



EARBUDS 500

Please read and keep all safety, security, and use instructions.

Important Safety Instructions

1. Read these instructions.
2. Keep these instructions.
3. Heed all warnings.
4. Follow all instructions.
5. Do not use this apparatus near water.
6. Clean only with a dry cloth.
7. Only use attachments/accessories specified by the manufacturer.

WARNINGS/CAUTIONS

- To avoid accidental ingestion, keep the earbuds away from children and pets. The earbuds contain a lithium-ion battery, and may be hazardous if swallowed. If ingested, seek immediate medical attention. When not in use, store the earbuds in the charging case with the charging lid closed, and keep out of the reach of children and pets.
- Do NOT allow children to use the earbuds.
- Do NOT use the earbuds at a high volume for any extended period.
 - To avoid hearing damage, use your earbuds at a comfortable, moderate volume level.
 - Turn the volume down on your device before placing the earbuds in/on your ears, then turn the volume up gradually until you reach a comfortable listening level.
- When using this product, basic precautions should always be followed, including the following:
 - Read all the instructions before using the charging case.
 - To reduce the risk of injury, close supervision is necessary when the charging case is used near children.
 - Do not put fingers or hands into the charging case.
 - Do not expose the charging case to water, rain, liquids or snow.
 - Do not use the charging case in excess of its output rating.
 - Do not use a charging case that is damaged or modified. Damaged or modified batteries may exhibit unpredictable behavior resulting in fire, explosion or risk of injury to persons.
 - Do not disassemble the charging case. Incorrect reassembly may result in risk of fire or injury to persons.
 - Do not open, crush, or expose a charging case to fire or excessive temperature. Exposure to fire or temperature above 212° F, 100° C may cause explosion.
 - Have servicing performed by a qualified repair person using only identical replacement parts.
- Use caution and follow applicable laws regarding mobile phone and headphone use if using the earbuds for phone calls while driving. Some jurisdictions impose specific limitations, such as single earpiece configuration, on the use of such products while driving. DON'T use the earbuds for any other purpose while driving.
- Focus on your safety and that of others if you use the earbuds while engaging in any activity requiring your attention, e.g., while riding a bicycle or walking in or near traffic, a construction site or railroad, etc. Remove the earbuds or adjust your volume to ensure you can hear surrounding sounds, including alarms and warning signals.

IMPORTANT SAFETY INSTRUCTIONS

- Do NOT submerge or expose the earbuds for extended period to water, or wear while participating in water sports, e.g., swimming, waterskiing, surfing, etc.
- Remove earbuds immediately if you experience a warming sensation or loss of audio.



Contains small parts which may be a choking hazard. Not suitable for children under age 3.



This product contains magnetic material. Consult your physician on whether this might affect your implantable medical device.

- Do NOT make unauthorized alterations to this product.
- Use this product only with an agency-approved power supply that meets local regulatory requirements (e.g., UL, CSA, VDE, CCC).
- Do not expose products containing batteries to excessive heat (e.g. from storage in direct sunlight, fire or the like).
- Wipe off sweat from the earbuds and the charging case before charging.
- IPX4 is not a permanent condition, and resistance might decrease as a result of normal wear.

NOTE: This equipment has been tested and found to comply with the limits for a Class B digital device, pursuant to Part 15 of the FCC Rules. These limits are designed to provide reasonable protection against harmful interference in a residential installation. This equipment generates, uses, and can radiate radio frequency energy and, if not installed and used in accordance with the instructions, may cause harmful interference to radio communications. However, there is no guarantee that interference will not occur in a particular installation. If this equipment does cause harmful interference to radio or television reception, which can be determined by turning the equipment off and on, the user is encouraged to try to correct the interference by one or more of the following measures:

- Reorient or relocate the receiving antenna.
- Increase the separation between the equipment and receiver.
- Connect the equipment into an outlet on a circuit different from that to which the receiver is connected.
- Consult the dealer or an experienced radio/TV technician for help.

Changes or modifications not expressly approved by Bose Corporation could void the user's authority to operate this equipment.

This device complies with part 15 of the FCC Rules and with Industry Canada license-exempt RSS standard(s). Operation is subject to the following two conditions: (1) This device may not cause harmful interference, and (2) this device must accept any interference received, including interference that may cause undesired operation.

This device complies with FCC and Industry Canada radiation exposure limits set forth for general population. This transmitter must not be co-located or operating in conjunction with any other antenna or transmitter.

FCC ID: A94427929 / FCC ID: A94BL2R / FCC ID: A94BL2L

IC: 3232A-427929 / IC: 3232A-BL2R / IC:3232A-BL2L

Case Model: 427929

Right Earbud Model: BL2R

Left Earbud Model: BL2L

CMIIT ID: XXXXXXXXXX

Country of Origin: China

CAN ICES-3 (B)/NMB-3(B)

CE Bose Corporation hereby declares that this product is in compliance with the essential requirements and other relevant provisions of Directive 2014/53/EU and all other applicable EU directive requirements. The complete declaration of conformity can be found at: www.Bose.com/compliance

For Europe:

Frequency band of operation 2400 to 2483.5 MHz:

Bluetooth: Maximum transmit power less than 20 dBm EIRP.

Bluetooth Low Energy: Maximum power spectral density less than 10 dBm/MHz EIRP.



This symbol means the product must not be discarded as household waste, and should be delivered to an appropriate collection facility for recycling. Proper disposal and recycling helps protect natural resources, human health and the environment. For more information on disposal and recycling of this product, contact your local municipality, disposal service, or the shop where you bought this product.

Management Regulation for Low-power Radio-frequency Devices

Article XII

According to “Management Regulation for Low-power Radio-frequency Devices” without permission granted by the NCC, any company, enterprise, or user is not allowed to change frequency, enhance transmitting power or alter original characteristic as well as performance to an approved low power radio-frequency devices.

Article XIV

The low power radio-frequency devices shall not influence aircraft security and interfere legal communications; If found, the user shall cease operating immediately until no interference is achieved. The said legal communications means radio communications operated in compliance with the Telecommunications Act.

The low power radio-frequency devices must be susceptible with the interference from legal communications or ISM radio wave radiated devices.

DON'T attempt to remove the rechargeable lithium-ion battery from this product. Contact your local Bose retailer or other qualified professional for removal.



Please dispose of used batteries properly, following local regulations.
Do not incinerate.



China Restriction of Hazardous Substances Table

Names and Contents of Toxic or Hazardous Substances or Elements						
Part Name	Toxic or Hazardous Substances and Elements					
	Lead (Pb)	Mercury (Hg)	Cadmium (Cd)	Hexavalent (CR(VI))	Polybrominated Biphenyl (PBB)	Polybrominated diphenylether (PBDE)
PCBs	X	0	0	0	0	0
Metal Parts	X	0	0	0	0	0
Plastic Parts	0	0	0	0	0	0
Speakers	X	0	0	0	0	0
Cables	X	0	0	0	0	0
This table is prepared in accordance with the provisions of SJ/T 11364. O: Indicates that this toxic or hazardous substance contained in all of the homogeneous materials for this part is below the limit requirement of GB/T 26572. X: Indicates that this toxic or hazardous substance contained in at least one of the homogeneous materials used for this part is above the limit requirement of GB/T 26572.						

Please complete and retain for your records

The earbud serial numbers are located on the earbud nozzles. The charging case serial number is located on the earbud well in the charging case. The model numbers are located on the bottom of the charging case.

Serial number: _____

Model number: _____

Please keep your receipt with your owner's guide. Now is a good time to register your Bose product. You can easily do this by going to <http://global.Bose.com/register>

Security Information

This product is capable of receiving automatic security updates from Bose. To receive automatic security updates, you must complete the product setup process in the Bose Music app and connect the product to the Internet. **If you do not complete the setup process, you will be responsible for installing security updates that Bose makes available.**

Date of Manufacture: The eighth digit in the serial number indicates the year of manufacture; "9" is 2009 or 2019.

China Importer: Bose Electronics (Shanghai) Company Limited, Part C, Plan 9, No. 353 North Riyang Road, China (Shanghai) Pilot Free Trade Zone

EU Importer: Bose Products B.V., Gorslaan 60, 1441 RG Purmerend, The Netherlands

Taiwan Importer: Bose Taiwan Branch, 9F-A1, No.10, Section 3, Minsheng East Road, Taipei City 104, Taiwan
Phone Number: +886-2-2514 7676

Mexico Importer: Bose de México, S. de R.L. de C.V. , Paseo de las Palmas 405-204, Lomas de Chapultepec, 11000 México, D.F. Phone Number: +5255 (5202) 3545

Amazon, Alexa, Amazon Music, and all related logos are trademarks of Amazon, Inc. or its affiliates.

Apple, the Apple logo, iPad, iPhone, and iPod are trademarks of Apple Inc., registered in the U.S. and other countries. The trademark "iPhone" is used in Japan with a license from Aiphone K.K. App Store is a service mark of Apple Inc.

Use of the Made for Apple badge means that an accessory has been designed to connect specifically to the Apple product(s) identified in the badge, and has been certified by the developer to meet Apple performance standards. Apple is not responsible for the operation of this device or its compliance with safety and regulatory standards. Please note that the use of this accessory with an Apple product may affect wireless performance.

The *Bluetooth*[®] word mark and logos are registered trademarks owned by Bluetooth SIG, Inc. and any use of such marks by Bose Corporation is under license.

Google, Google Maps, Google Play, Google Play Music, the Google Play logo, and other related marks are trademarks of Google LLC.

Wi-Fi is a registered trademark of Wi-Fi Alliance[®].

Bose, Bose Earbuds, and Bose Music are trademarks of Bose Corporation.

Bose Corporation Headquarters: 1-877-230-5639

©2019 Bose Corporation. No part of this work may be reproduced, modified, distributed or otherwise used without prior written permission.

WHAT'S IN THE BOX

Contents 11

BOSE MUSIC APP SETUP

Download the Bose Music app..... 12
 Add the earbuds to an existing account 13

SWEAT AND WEATHER RESISTANCE 14

HOW TO WEAR

Insert the earbuds..... 15
 Check the fit..... 16
 Eartip size 16
 Change the eartips..... 17

POWER

Power on 18
 Power off..... 18
 Standby..... 18

TOUCH CONTROL

Touch surface area 19
 Media playback and volume 19
 Phone calls..... 20
 Call notifications 20
 Voice assistant 20

IN-EAR DETECTION

Auto Play/Pause..... 21
 Auto Answer Call 21

VOICE ASSISTANT

Voice assistant options..... 22

Set up your voice assistant 22

Access Amazon Alexa..... 23

 Use your voice 23

 Use touch control 24

Access your Google Assistant 25

 Use your voice 25

 Use touch control 26

Disable the wake word for Amazon Alexa or your Google Assistant 27

Access your mobile device voice control..... 27

CUSTOMIZE TOUCH CONTROL

Touch control Shortcut..... 28

 Set a Shortcut 28

 Use your Shortcut..... 28

 Remove or change your Shortcut..... 28

BATTERY

Charge the earbuds 29

 Charging time..... 29

Check the earbud battery level..... 30

 While using the earbuds 30

 While charging the earbuds 30

Charge the charging case..... 31

 Charging time..... 31

Check the charging case battery level 31

EARBUD AND CHARGING CASE STATUS

Earbud status lights 32

Bluetooth® connection status 32

 Earbud charge status 32

Charging case status lights 33

 Charging case charge status 33

 Update and error status 33

BLUETOOTH CONNECTIONS

Connect using the *Bluetooth* menu on your mobile device 34

Disconnect a mobile device 35

Reconnect a mobile device 35

Connect an additional mobile device 35

Clear the earbuds device list 35

CARE AND MAINTENANCE

Store the earbuds 36

Clean the earbuds and charging case 36

Find your lost earbuds 37

Replacement parts and accessories 37

Limited warranty 37

Update the earbuds 37

Serial number locations 38

TROUBLESHOOTING

Try these solutions first 39

Other solutions 39

CONTENTS

Confirm that the following parts are included:

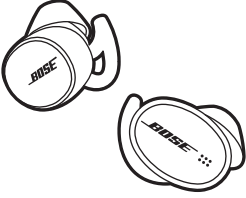

Bose Earbuds 500



Charging case

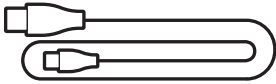
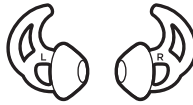

USB-C to USB-A cable

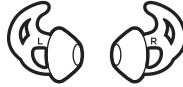

Eartips (sizes 1 and 3)

NOTE: Size 2 eartips are attached to the earbuds. For help identifying the eartip sizes, see page 16.

NOTE: If any part of the product is damaged, don't use it. Contact your authorized Bose dealer or Bose customer service.

Visit: worldwide.Bose.com/Support/EB500

The Bose Music app lets you set up and control the earbuds from any mobile device, such as a smartphone or tablet.

Using the app, you can configure Amazon Alexa or your Google Assistant, choose your voice prompt language, and manage earbud settings.

NOTE: If you have already created a Bose account in the app for another Bose product, see “Add the earbuds to an existing account.”

DOWNLOAD THE BOSE MUSIC APP

1. On your mobile device, download the Bose Music app.

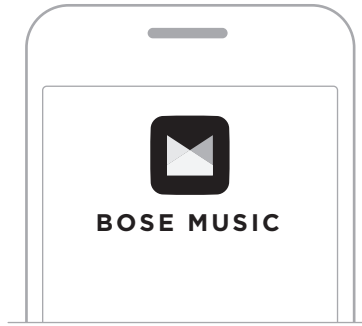

2. Follow the app instructions.

ADD THE EARBUDS TO AN EXISTING ACCOUNT

1. On the charging case, press and hold the *Bluetooth* button until you hear “Ready to connect,” and the earbud status lights slowly pulse blue.

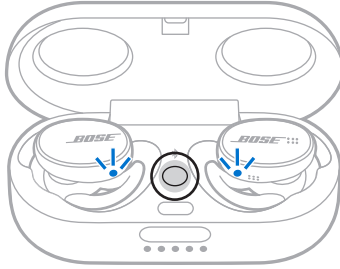

2. In the Bose Music app, from the **My Bose** screen, tap +.
NOTE: To return to the **My Bose** screen, tap  in the top-left corner of the screen.
3. Follow the app instructions.

The earbuds are rated IPX4 sweat and weather resistant. They aren't meant to be submerged under water.

CAUTIONS:

- Do NOT swim or shower with the earbuds.
- Do NOT submerge the earbuds.

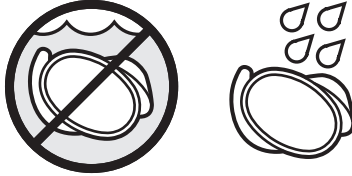

NOTES:

- To prevent rusting, regularly clean the charging pins on the earbuds with a dry, soft cotton swab or equivalent.
- IPX4 is not a permanent condition, and resistance might decrease as a result of normal wear.

INSERT THE EARBUDS

1. Insert the earbud so the eartip gently rests in your ear canal.

NOTE: Each eartip is marked with either an **L** (left) or an **R** (right).

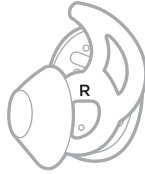

2. Slightly rotate the earbud back until the eartip creates a comfortable seal in your ear canal.

NOTE: Rotating the earbud too far back may impact audio performance.

3. Tuck the top of the eartip under your ear ridge.



Insert



Rotate

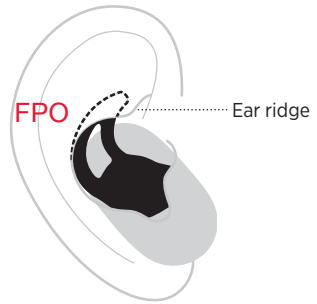

Tuck

4. Check the fit (see page 16).
5. Repeat steps 1 - 4 to insert the other earbud.

CHECK THE FIT

When the eartips are properly inserted and fit correctly, they:

- Sit deep enough in your ears to create a seal but still feel comfortable. Background noise should sound muffled.
- Stay secure, even when moving your head.

If the eartips don't feel comfortable or secure, try another eartip size.

Eartip size

The size is marked on the bottom of each eartip with a 1 (small), 2 (medium), or 3 (large).



The size 2 (medium) eartips come attached to the earbuds. If size 2 feels too loose, try size 3 (large). If it feels too tight, try size 1 (small).

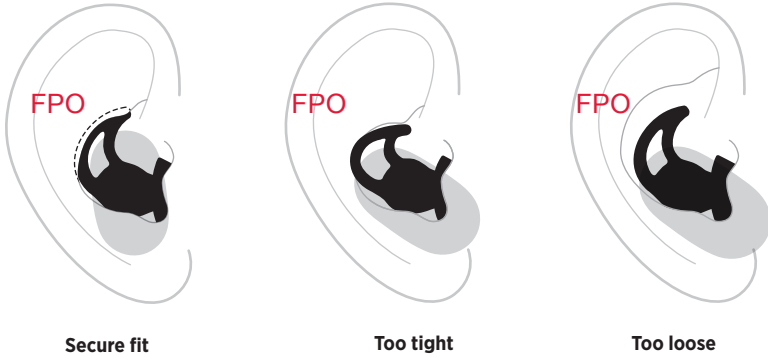

NOTE: You may need to try all three sizes or use a different size for each ear.

Change the eartips

1. Holding the earbud, gently stretch the eartip base and peel it away from the earbud.

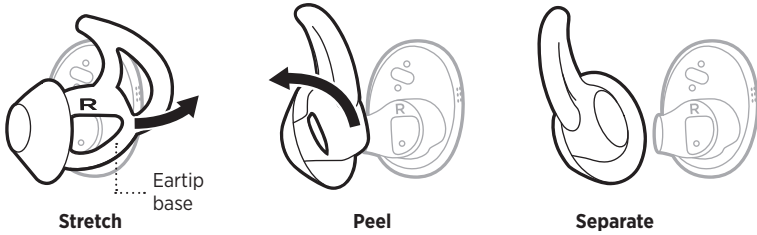

CAUTION: To prevent tearing, do NOT pull on the top of the eartip.

2. Choose a new eartip size (see page 16).
3. Align the opening of the eartip with the earbud nozzle, and slide the eartip opening onto the earbud nozzle.

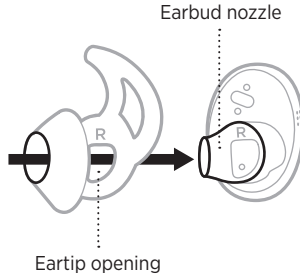

4. Gently stretch the base of the eartip around the nozzle, and press down until the eartip clicks securely into place.

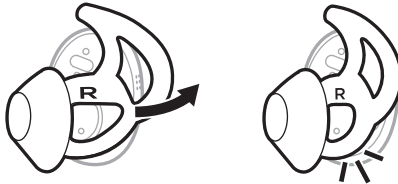

5. Insert the earbuds (see page 15).
6. Check the fit (see page 16).

POWER ON

Press the button on the front of the charging case.

When the charging case opens, the earbuds power on. The earbud status lights (see page 33) and charging case status lights glow (see page 33).

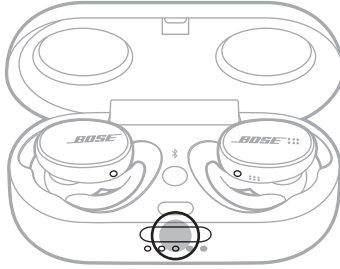

POWER OFF

1. Place both earbuds in the charging case (see page 29).

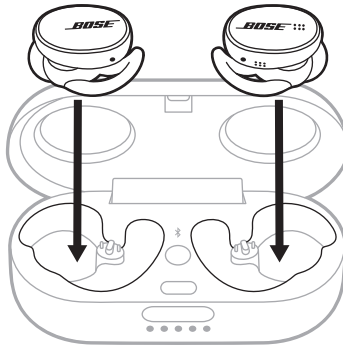

The earbud status lights glow according to the charging status (see page 33).

2. Close the charging case.

STANDBY

Standby conserves the earbud battery when the earbuds are not in use. Using motion detection, the earbuds switch to Standby when you remove both earbuds from your ears for 10 minutes.

To wake the earbuds, insert the right earbud in your ear or use the Bose Music app.

NOTE: To wake the earbuds when In-Ear Detection (see page 21) is disabled, move both earbuds.



Use touch control by tapping or swiping the touch surface of the earbuds. With touch control, you can play/pause audio, change the volume, perform basic call functions, and access your voice assistant.

TOUCH SURFACE AREA

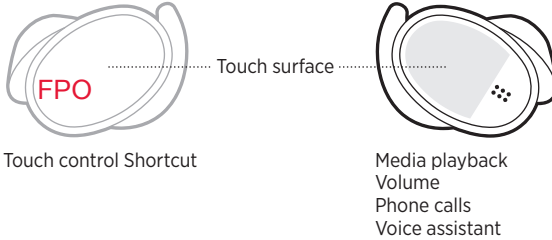
The touch surface is located on the outer surface of each earbud. The right earbud controls media playback, volume, phone calls, and your voice assistant. The left earbud controls your Shortcut.





MEDIA PLAYBACK AND VOLUME

CONTROL	WHAT TO DO	TOUCH CONTROL
Play/Pause	Tap the right earbud.	
Increase the volume	Swipe up.	
Decrease the volume	Swipe down.	

PHONE CALLS

The microphone is located on the right earbud.



CONTROL	WHAT TO DO	TOUCH CONTROL
Answer/end a call	Tap the right earbud.	
Decline an incoming call	Touch and hold the right earbud.	

NOTE: When talking on the phone, you must wear the right earbud. You hear audio from both earbuds.

Call notifications

A voice prompt announces incoming callers and call status.

To disable call notifications, use the Bose Music app. You can access this option from the Settings menu.

NOTE: Disabling voice prompts disables call notifications.

VOICE ASSISTANT

You can use touch controls to access Amazon Alexa (see page 24), your Google Assistant (see page 26), or your mobile device voice control (see page 27).

In-ear detection uses sensors to identify when you're wearing the earbuds. You can automatically play or pause audio and answer phone calls by inserting or removing the right earbud.

NOTE: To disable in-ear detection features, use the Bose Music app. You can access the features from the Settings menu.

AUTO PLAY/PAUSE

When you remove the right earbud, audio pauses on both earbuds. To resume audio, re-insert the right earbud.

AUTO ANSWER CALL

You can answer phone calls by inserting the right earbud. To enable this feature, use the Bose Music app. You can access this feature from the Settings menu.

VOICE ASSISTANT OPTIONS

You can set up the earbuds to quickly and easily access Amazon Alexa, your Google Assistant, or voice control capabilities on your mobile device.

NOTE: Amazon Alexa and the Google Assistant aren't available in certain languages and countries.

OPTIONS	HOW TO USE
Amazon Alexa	Use your voice and/or touch control (see page 24).
Your Google Assistant	Use your voice and/or touch control (see page 26).
Mobile device voice control	Use touch control (see page 27). NOTE: You can't use your voice to access mobile device voice control.

NOTE: You can't set the earbuds to access Amazon Alexa and the Google Assistant at the same time.

SET UP YOUR VOICE ASSISTANT

Before you begin, make sure your mobile device is connected to a Wi-Fi® or cellular data network.

To set up your voice assistant, use the Bose Music app. You can access this option from the Settings menu.

NOTE: To access Amazon Alexa or your Google Assistant using touch control only, disable the wake word (see page 27).

ACCESS AMAZON ALEXA

The earbuds are Amazon Alexa enabled. With Alexa, you can ask to play music, hear the news, check the weather, control smart home devices, and more. Using Alexa on your earbuds is as simple as asking. Just ask and Alexa responds instantly.

For more information about what Alexa can do, visit:

<https://www.amazon.com/usealexa>

NOTES:

- Alexa isn't available in certain languages and countries.
- When talking to Alexa, you must wear the right earbud. You hear audio from both earbuds.

Use your voice



Start with the wake word "Alexa," then say:

THINGS TO TRY	EXAMPLES OF WHAT TO SAY
Talk to Alexa	What can you do?
Play audio	Play Beethoven. NOTE: Amazon Music is set as the default music service. To change the default music service, use the Alexa app.
Play from a specific audio service	Play NPR on TuneIn. NOTE: Amazon Alexa doesn't support all audio services.
Skip to the next song	Next song.
Plan your day	What's the weather?
Add to your shopping list	Add eggs to my shopping list.
Send a message (Alexa-to-Alexa messaging only)	Send a message to Tom.
Discover more skills	What new skills do you have?
Stop Alexa	Stop.

Use touch control

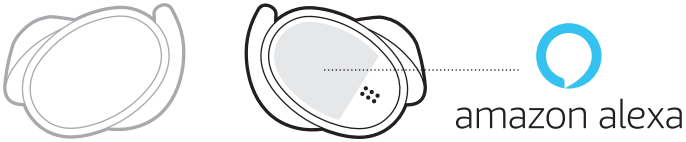
Use the touch surface on the right earbud to control Amazon Alexa.



THINGS TO TRY	WHAT TO DO	TOUCH CONTROL
Talk to Alexa	Touch and hold the right earbud.	
Disable/enable the wake word	Double-tap the right earbud.	

NOTE: You can also set your Shortcut to disable/enable the Alexa wake word. For information about how to set and use this Shortcut, see "Touch control Shortcut" on page 28.

ACCESS YOUR GOOGLE ASSISTANT

Your earbuds are optimized for the Google Assistant, making your earbuds the perfect companion for getting stuff done on your travels or commute. Continue your conversations while on the go and easily access the best of Google, from Google Play Music to Google Maps. You can quickly enjoy entertainment, stay connected to friends, get information, and manage your day—all without glancing at your phone. Listen to your favorite songs, have notifications and messages read to you, or set reminders and timers. Just touch and hold the touch surface or say “Hey Google” to start a conversation with your Google Assistant.

For more information about what your Google Assistant can do, visit:
<https://support.google.com/headphones>

NOTES:

- The Google Assistant isn’t available in certain languages and countries.
- When talking to your Google Assistant, you must wear the right earbud. You hear audio from both earbuds.

Use your voice





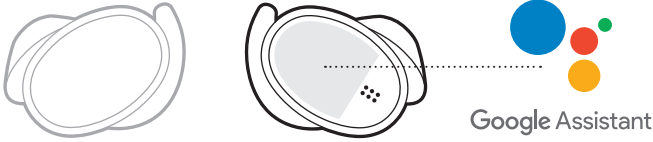

Start with the wake word “Hey Google,” then say:

THINGS TO TRY	EXAMPLES OF WHAT TO SAY
Enjoy entertainment	Play some jazz.
Set a reminder	Remind me to do laundry when I get home.
Manage tasks	Text mom “see you in five.”
Plan your day	What’s the traffic like to work?
Get answers	What is 33% of 81?

Use touch control

Use the touch surface on the right earbud to control your Google Assistant.



THINGS TO TRY	WHAT TO DO	TOUCH CONTROL
Talk to your Google Assistant	Touch and hold the right earbud while saying your request.	
Get notifications	Double-tap the right earbud.	
Read out an incoming notification	Gesture TBD	
Confirm your message reply	Gesture TBD	
Dismiss a notification	Gesture TBD	
Stop your Google Assistant	Gesture TBD	

NOTE: You can also set your Shortcut to disable/enable the Google Assistant wake word. For information about how to set and use this Shortcut, see "Touch control Shortcut" on page 28.

DISABLE THE WAKE WORD FOR AMAZON ALEXA OR YOUR GOOGLE ASSISTANT

To disable the wake word, use the Bose Music app. You can access this option from the Settings menu.

NOTES:

- After disabling the wake word, you can still access the voice assistant using touch control (see page 22).
- You can also set a Shortcut control to automatically disable/enable the wake word (see page 28).

ACCESS YOUR MOBILE DEVICE VOICE CONTROL

You can set the earbuds to access voice control on your mobile device. Once set, the earbud microphone acts as an extension of the microphone in your mobile device.

To access your mobile device voice control, touch and hold the right earbud.



TOUCH CONTROL SHORTCUT

A Shortcut enables you to quickly and easily access one of the following functions:

- Check the earbud battery level.
- Skip a track.
- Disable/Enable the wake word for Amazon Alexa or your Google Assistant (see page 27).

NOTE: The Shortcut to disable/enable the wake word is not applicable for mobile device voice control.

Set a Shortcut

To set a Shortcut, use the Bose Music app. You can access this option from the Settings menu.

Use your Shortcut

To use your Shortcut, double-tap the left earbud.



Remove or change your Shortcut

To remove or change your Shortcut, use the Bose Music app. You can access this feature from the Settings menu.

CHARGE THE EARBUDS

1. Align the charging pins on the left earbud with the charging pins on the left side of the charging case.

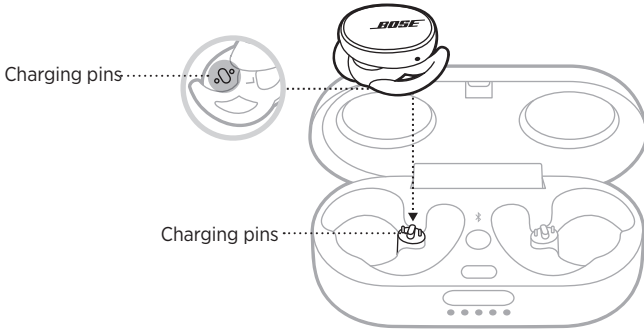

2. Place the earbud in the charging case until it magnetically snaps into place.

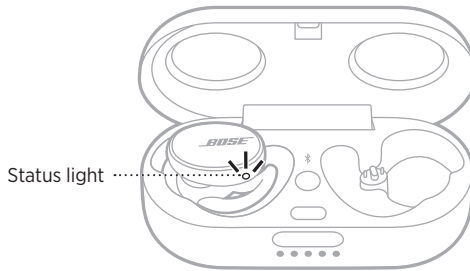

The earbud status light glows according to the charging status (see page 32).

3. Repeat steps 1 - 2 to charge the right earbud.

Charging time

Allow up to 2.5 hours to fully charge the earbuds.

NOTE: A full charge powers the earbuds for 4 - 6 hours.

CHECK THE EARBUD BATTERY LEVEL

While using the earbuds

- When you remove the earbuds from the charging case and insert the earbuds, a voice prompt announces the battery level. If the battery is low, you hear “Battery low, please charge now.”
- If you set your Shortcut to check the battery level, double-tap the left earbud (see page 28).
- If connected to an Apple device, your device displays the battery level on the home screen, Control Center, or notification screen.
- You can also check the earbud battery level using the Bose Music app.

While charging the earbuds

When you place the earbuds into the charging case, the earbud status lights glow (see page 32).

CHARGE THE CHARGING CASE

CAUTION: Use this product only with an agency approved power supply which meets local regulatory requirements (e.g., UL, CSA, VDE, CCC).

1. Connect the small end of the USB cable into the USB-C port.

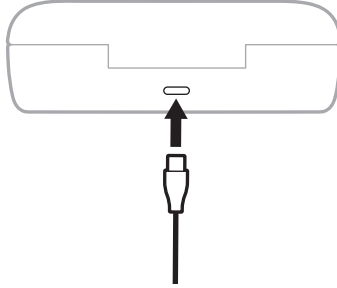

2. Connect the other end into a USB-A wall charger (not provided) or computer that is powered on.

NOTE: Before charging, be sure the earbuds are at room temperature, between 41° F (5° C) and 104° F (40° C).

Charging time

Allow up to 2.5 hours to fully charge the case.

When the case is fully charged, you can charge the earbuds up to two times.

NOTE: When the earbuds are inside of the case, charging time varies.

CHECK THE CHARGING CASE BATTERY LEVEL

Press the button on the front of the charging case.

When the charging case opens, the five charging case status lights glow according to the battery level (see page 33).

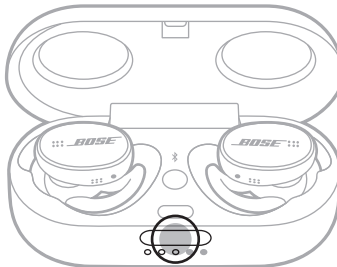

TIP: You can also check the charging case battery level using the Bose Music app.

EARBUD STATUS LIGHTS

The earbud status lights are located on the outside surface of each earbud.

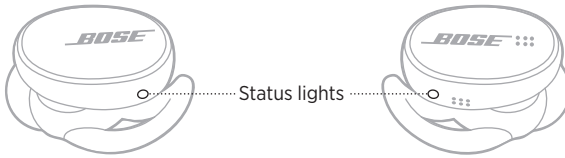

Bluetooth connection status

Shows the *Bluetooth* connection status.

LIGHT ACTIVITY	SYSTEM STATE
Slowly pulses blue	Ready to connect
Blinks blue	Connecting
Solid blue	Connected

Earbud charge status

Shows the earbud battery level.

LIGHT ACTIVITY	SYSTEM STATE
Solid white	Full charge
Slowly pulses red	Need to charge
Slowly pulses white	Charging
Blinks red and white	Error - contact Bose customer service

NOTE: While charging, the earbud status lights slowly pulse white. When the earbuds are fully charged, the status lights glow solid white.

CHARGING CASE STATUS LIGHTS

The charging case status lights are located on the front of the charging case. They show the charge status and battery level of the case, and the earbud update status.

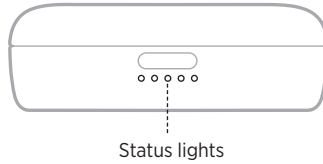

Charging case charge status

Shows the charging case battery level.

LIGHT ACTIVITY	CHARGING PERCENTAGE
○ ● ● ● ●	0% - 20%
○ ○ ● ● ●	20% - 40%
○ ○ ○ ● ●	40% - 60%
○ ○ ○ ○ ●	60% - 80%
○ ○ ○ ○ ○	80% - 99%

NOTE: When the charging case is charging, the last lit status light blinks white. When it is fully charged, all five charging case status lights glow solid white.

Update and error status

Shows the update and error status.

LIGHT ACTIVITY	SYSTEM STATE
☼ ○ ● ● ●	Updating earbuds (see page 37) NOTE: The charging case status lights blink sequentially, starting with the first light.
☼ ☼ ☼ ☼ ☼	Charging error - contact Bose customer service

Bluetooth wireless technology lets you stream music from mobile devices such as smartphones, tablets, and laptop computers. Before you can play audio from a device, you must connect the device with the earbuds.

CONNECT USING THE *BLUETOOTH* MENU ON YOUR MOBILE DEVICE

NOTE: For the best experience, set up and connect your mobile device using the Bose Music app (see page 12).

1. On the charging case, press and hold the *Bluetooth* button until you hear “Ready to connect,” and the earbud status lights slowly pulse blue.

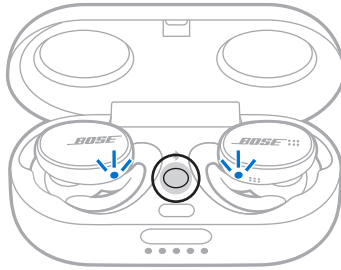

NOTE: Make sure both earbuds are within range (30 ft. or 9 m) of the charging case.

2. On your device, enable the *Bluetooth* feature.

TIP: The *Bluetooth* feature is usually found in the Settings menu.

3. Select the earbuds from the device list.

TIP: Look for the name you entered for the earbuds in the Bose Music app.

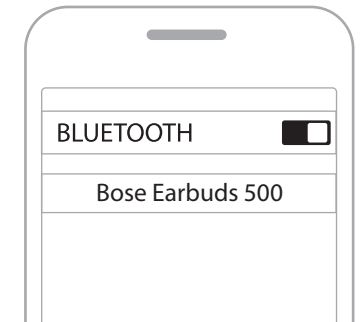

Once connected, you hear “Connected to <mobile device name>,” and the earbud status lights glow solid blue.

DISCONNECT A MOBILE DEVICE

Use the Bose Music app to disconnect your mobile device.

TIP: You can also use *Bluetooth* settings to disconnect your device. Disabling the *Bluetooth* feature disconnects all other devices.

RECONNECT A MOBILE DEVICE

When powered on, the earbuds try to reconnect with the most recently-connected device.

NOTES:

- The device must be within range (30 ft. or 9 m) and powered on.
- Make sure the *Bluetooth* feature is enabled on your mobile device.

CONNECT AN ADDITIONAL MOBILE DEVICE

You can store up to seven devices in the earbud device list.

To connect an additional device, see "Add the earbuds to an existing account" on page 13.

NOTE: You can connect and play audio from only one device at a time.

CLEAR THE EARBUDS DEVICE LIST

1. Press and hold the *Bluetooth* button on the charging case until you hear "Bluetooth device list cleared," and the earbud status lights slowly pulse blue.

NOTE: Make sure both earbuds are within range (30 ft. or 9 m) of the charging case.

2. Delete the earbuds from the *Bluetooth* list on your device.

All devices are cleared, and the earbuds are ready to connect.

STORE THE EARBUDS

To store the earbuds, place them in the charging case.

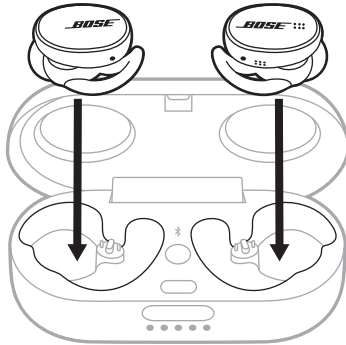

When the earbuds are stored, the earbud status lights glow (see page 33).

CLEAN THE EARBUDS AND CHARGING CASE

The earbuds and charging case may require periodic cleaning.

COMPONENT	CLEANING PROCEDURE
Eartips	Remove the tips from the earbuds and wash them with a mild detergent and water. NOTE: Make sure you thoroughly rinse and dry the tips before re-attaching them to the earbuds.
Earbud nozzles	Clean only with a dry, soft cotton swab or equivalent. NOTE: Never insert any cleaning tool into the nozzle.
Charging pins (on earbuds and charging case)	To prevent rusting, clean with a dry, soft cotton swab or equivalent.
Charging case	Clean only with a dry, soft cotton swab or equivalent.

FIND YOUR LOST EARBUDS

Use the Bose Music app to help find your lost earbuds.

REPLACEMENT PARTS AND ACCESSORIES

Replacement parts and accessories can be ordered through Bose customer service.

Visit: worldwide.Bose.com/Support/EB500

LIMITED WARRANTY

The earbuds are covered by a limited warranty. Visit our website at global.Bose.com/warranty for details of the limited warranty.

To register your product, visit global.Bose.com/register for instructions. Failure to register will not affect your limited warranty rights.

UPDATE THE EARBUDS

The earbuds and charging case update automatically when connected to the Bose Music app. Follow the app instructions.

TIP: You can also update the earbuds and charging case using the Bose updater website. On your computer, visit: btu.Bose.com and follow the on-screen instructions.

SERIAL NUMBER LOCATIONS

The earbud and charging case serial numbers are located:

- On the carton outer label.
- In the Bose Music app, under Technical Info.
- On the earbud nozzles (earbuds only).
- On the charging case (charging case only).

View the serial number on the earbuds

Remove the eartip from the earbud (see page 17).

The serial number is located on the earbud nozzle.



View the serial number on the charging case

Remove the earbuds from the charging case.

The serial number is located on the right side of the left earbud well.

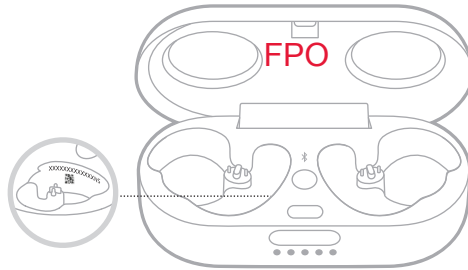

TRY THESE SOLUTIONS FIRST

If you experience problems with the earbuds, try these solutions first:

- Power on the earbuds (see page 18).
- Check the earbud status lights (see page 33).
- Charge the earbuds (see page 29).
- Charge the charging case (see page 31).
- Make sure your mobile device supports *Bluetooth* connections (see page 35).
- Download the Bose Music app and run available software updates (see page 12).
- Move your mobile device closer to the earbuds (30 ft. or 9 m) and away from any interference or obstructions.
- Increase the volume on the earbuds, mobile device, and music app.
- Connect another mobile device (see page 35).

OTHER SOLUTIONS

If you could not resolve your issue, see the table below to identify symptoms and solutions to common problems. If you are unable to resolve your issue, contact Bose customer service.

Visit: worldwide.Bose.com/contact

PROBLEM	WHAT TO DO
Earbuds don't power on	<p>Make sure the earbuds are not in standby mode. To wake the earbuds, insert the earbuds in your ears.</p> <p>Place both earbuds in the charging case until they magnetically snap into place, and the earbud status lights glow solid white (see page 33). Remove the earbuds.</p>
Earbuds don't connect with mobile device	<p>On your device:</p> <ul style="list-style-type: none"> • Turn the <i>Bluetooth</i> feature off and then on. • Delete the earbuds from the <i>Bluetooth</i> list on your device. Connect again (see page 34). <p>Place both earbuds in the charging case until they magnetically snap into place, and the status lights glow solid white (see page 33). Remove the earbuds.</p> <p>Visit: worldwide.Bose.com/Support/EB500 to see how-to videos.</p> <p>Clear the earbud device list (see page 35). Connect again (see page 34).</p>
Earbuds don't respond during app setup	<p>Make sure you are using the Bose Music app for setup (see page 12).</p>

PROBLEM	WHAT TO DO
Bose Music app doesn't work on mobile device	<p>Make sure your mobile device is compatible with the Bose Music app and meets minimum system requirements. For more information, refer to the app store on your mobile device.</p> <p>Uninstall the Bose Music app on your mobile device. Reinstall the app (see page 12).</p>
No sound	<p>Make sure that both eartips fit securely in your ear, and they are not rotated too far back (see page 15).</p> <p>Press Play on your mobile device to make sure audio is playing.</p> <p>Play audio from a different application or music service.</p> <p>Play audio from content stored directly on your device.</p> <p>Restart your mobile device.</p> <p>Press the <i>Bluetooth</i> button on the charging case to hear the connected mobile device. Make sure you are using the correct device.</p> <p>Make sure the earbuds are within range of each other.</p> <p>Disable in-ear detection features using the Bose Music app.</p>
No sound from one earbud	<p>Make sure that both eartips fit securely in your ear, and they are not rotated too far back (see page 15).</p> <p>Make sure the earbuds are within range of each other.</p> <p>Place both earbuds in the charging case until they magnetically snap into place, and the earbud status lights glow solid white (see page 32). Remove the earbuds.</p>

PROBLEM	WHAT TO DO
Poor sound quality	<p>Make sure that both eartips fit securely in your ear, and they are not rotated too far back (see page 15).</p> <p>Try a different audio track.</p> <p>Play audio from a different application or music service.</p> <p>Clear any debris or wax buildup from the eartips and earbud nozzles.</p> <p>Turn off any audio enhancement features on the device or music app.</p> <p>Make sure your earbuds are connected over the correct <i>Bluetooth</i> profile: Stereo A2DP. Check your device's <i>Bluetooth</i>/audio settings menu to make sure the correct profile is selected.</p> <p>On your device:</p> <ul style="list-style-type: none">• Turn the <i>Bluetooth</i> feature off and then on.• Delete the earbuds from the <i>Bluetooth</i> list on your device. Connect again (see page 34).
Earbuds don't charge	<p>Make sure the earbuds are properly placed in the charging case (see page 29).</p> <p>Make sure the charging case battery is not depleted (see page 33).</p> <p>Make sure there is no dirt or debris covering the charging conductors within the case or on the earbuds.</p> <p>Make sure the USB cable is correctly aligned with the port on the charging case.</p> <p>Secure both ends of the USB cable.</p> <p>Try another USB cable.</p> <p>Try another wall charger.</p> <p>If your earbuds have been exposed to high or low temperatures, let the earbuds return to room temperature. Charge again (see page 29).</p>

PROBLEM	WHAT TO DO
Microphone doesn't pick up sound	<p>Make sure the microphone openings on the front edge of each of the earbuds are not blocked.</p> <p>Try using your voice assistant and see if your voice assistant hears your voice.</p> <p>Try another voice assistant.</p> <p>Try another phone call.</p> <p>Try another compatible device.</p> <p>On your device:</p> <ul style="list-style-type: none"> • Turn the <i>Bluetooth</i> feature off and then on. • Delete the earbuds from the <i>Bluetooth</i> list on your device. Connect again (see page 34).
Charging case doesn't charge	<p>Make sure the USB cable is correctly aligned with the port on the charging case.</p> <p>Secure both ends of the USB cable.</p> <p>Try another USB cable.</p> <p>Try another wall charger.</p> <p>If your charging case has been exposed to high or low temperatures, let the case return to room temperature. Charge again (see page 31).</p>
Earbuds don't respond to touch control	<p>For multi-tap functions, vary the tap pressure.</p> <p>Make sure your hands are dry.</p> <p>If your hair is wet, make sure it isn't interfering with the touch surface.</p> <p>If wearing gloves, remove them before tapping the touch control surface.</p>
Can't access Shortcut	<p>Make sure you have set a Shortcut using the Bose Music app.</p> <p>If the controls are locked, make sure you are using the correct earbud. To unlock the controls, use the Bose Music app.</p>

PROBLEM	WHAT TO DO
Alexa doesn't respond	<p>Make sure Alexa has been set up using the Bose Music app (see page 22).</p> <p>Connect your mobile device to Wi-Fi or enable the cellular data functionality for the Alexa app in your mobile device Settings menu.</p> <p>Make sure you're in a country where Alexa is available (see page 23).</p> <p>Make sure the wake word is enabled (see page 27).</p> <p>Make sure you are using the most up-to-date version of the Amazon Alexa app.</p> <p>Make sure your mobile device is compatible.</p> <p>Remove Alexa from the earbuds using the Bose Music app. Add Alexa again.</p> <p>For additional support, visit: https://www.amazon.com/usealexa</p>
Your Google Assistant doesn't respond	<p>Make sure your Google Assistant has been set up using the Bose Music app (see page 22).</p> <p>Connect your mobile device to Wi-Fi or enable the cellular data functionality for your Google Assistant app in your mobile device Settings menu.</p> <p>Make sure you're in a country where Google Assistant is available (see page 25).</p> <p>Make sure the wake word is enabled (see page 27).</p> <p>Make sure you are using the most up-to-date version of the Google Assistant app.</p> <p>Remove your Google Assistant from the earbuds using the Bose Music app. Add your Google Assistant again.</p> <p>Make sure your mobile device is compatible or for additional support, visit: https://support.google.com/headphones</p>
Eartips falling off	<p>Securely attach the eartips to the earbuds (see page 16).</p>
Earbuds lost	<p>Use the Bose Music app to help find your lost earbuds.</p>
Voice prompt language unavailable	<p>To customize or disable voice prompts, use the Bose Music app (see page 12). You can access this option from the Settings menu.</p>



836279-0010