

**Please read and keep all safety and use instructions.**

**Important Safety Instructions**

1. Read these instructions.
2. Keep these instructions.
3. Heed all warnings.
4. Follow all instructions.
5. Do not use this apparatus near water.
6. Clean only with a dry cloth.
7. Do not block any ventilation openings. Install in accordance with the manufacturer's instructions.
8. Do not install near any heat sources such as radiators, heat registers, stoves, or other apparatus (including amplifiers) that produce heat.
9. Protect the power cord from being walked on or pinched particularly at plugs, convenience receptacles, and the point where they exit from the apparatus.
10. Only use attachments/accessories specified by the manufacturer.
11.  Use only with the cart, stand, tripod, bracket, or table specified by the manufacturer, or sold with the apparatus. When a cart is used, use caution when moving the cart/apparatus combination to avoid injury from tip-over.
12. Unplug this apparatus during lightning storms or when unused for long periods of time.
13. Refer all servicing to qualified personnel. Servicing is required when the apparatus has been damaged in any way, such as power-supply cord or plug is damaged, liquid has been spilled or objects have fallen into the apparatus, the apparatus has been exposed to rain or moisture, does not operate normally, or has been dropped.

## WARNINGS/CAUTIONS



This symbol on the product means there is uninsulated, dangerous voltage within the product enclosure that may present a risk of electrical shock.



This symbol on the product means there are important operating and maintenance instructions in this guide.



Contains small parts which may be a choking hazard. Not suitable for children under age 3.



This product contains magnetic material. Consult your physician on whether this might affect your implantable medical device.



This product contains a tempered glass surface. Use caution to avoid impact. In the event of breakage, use care in handling broken glass.

- To reduce the risk of fire or electrical shock, do NOT expose this product to rain, liquids or moisture.
- Do NOT expose this product to dripping or splashing, and do not place objects filled with liquids, such as vases, on or near the product.
- Keep the product away from fire and heat sources. Do NOT place naked flame sources, such as lighted candles, on or near the product.
- Do NOT make unauthorized alterations to this product.
- Do NOT use in vehicles or boats.
- Where the mains plug or an appliance coupler is used as the disconnect device, the disconnect device shall remain readily operable.



仅适用于 2000m 以下地区安全使用  
Use at altitude less than 2000 meters only.

- The battery provided with this product may present a risk of fire or chemical burn if mishandled.
- If the battery leaks, do not allow the liquid to come in contact with the skin or eyes. If contact is made, seek medical advice.
- Do not expose products containing batteries to excessive heat (e.g. from storage in direct sunlight, fire or the like).
- Only use the following hardware to mount this product: Bose® Soundbar Wall Bracket

**NOTE:** This equipment has been tested and found to comply with the limits for a Class B digital device, pursuant to Part 15 of the FCC Rules. These limits are designed to provide reasonable protection against harmful interference in a residential installation. This equipment generates, uses, and can radiate radio frequency energy and, if not installed and used in accordance with the instructions, may cause harmful interference to radio communications. However, there is no guarantee that interference will not occur in a particular installation. If this equipment does cause harmful interference to radio or television reception, which can be determined by turning the equipment off and on, the user is encouraged to try to correct the interference by one or more of the following measures:

- Reorient or relocate the receiving antenna.
- Increase the separation between the equipment and receiver.
- Connect the equipment into an outlet on a circuit different from that to which the receiver is connected.
- Consult the dealer or an experienced radio/TV technician for help.

Changes or modifications not expressly approved by Bose Corporation could void the user's authority to operate this equipment.

This device complies with part 15 of the FCC Rules and with Industry Canada license-exempt RSS standard(s). Operation is subject to the following two conditions: (1) This device may not cause harmful interference, and (2) this device must accept any interference received, including interference that may cause undesired operation.

This device complies with FCC and Industry Canada radiation exposure limits set forth for general population. This equipment should be installed and operated with a minimum distance of 20 cm between radiator and your body. This transmitter must not be co-located or operating in conjunction with any other antenna or transmitter.

This device for operation in the band 5150 – 5250 MHz is only for indoor use to reduce the potential for harmful interference to other co-channel mobile satellite systems.

**CE** Bose Corporation hereby declares that this product is in compliance with the essential requirements and other relevant provisions of Directive 2014/53/EU and all other applicable EU directive requirements. The complete declaration of conformity can be found at: [www.Bose.com/compliance](http://www.Bose.com/compliance)

The product, in accordance with the Ecodesign Requirements for Energy Related Products Directive 2009/125/EC, is in compliance with the following norm(s) or document(s): Regulation (EC) No. 1275/2008, as amended by Regulation (EU) No. 801/2013.

Required Power State Information	Power Modes	
	Standby*	Networked Standby
Power consumption in specified power mode, at 230V/50Hz input	< 0.5 W	all network types ≤ 2.0 W
Time after which equipment is automatically switched into mode	< 2.5 hours	≤ 20 minutes
Power consumption in networked standby if all wired network ports are connected and all wireless network ports are activated, at 230V/50Hz input	N/A	≤ 2.0 W
Network port deactivation/activation procedures. Deactivating all networks will enable standby mode.* * Prior to deactivating networks or entering standby mode, use the microphone on/off button to ensure the microphone is turned on (the red indicator light will be off).	<p><b>Wi-Fi</b>®: Deactivate by pressing and holding the Bose® Music and Skip Forward buttons on the remote simultaneously. Repeat to activate.</p> <p><b>Bluetooth</b>®: Deactivate by clearing the pairing list by pressing and holding the <i>Bluetooth</i>® button on the remote for 10 seconds. Activate by pairing with a <i>Bluetooth</i>® source.</p> <p><b>Ethernet</b>: Deactivate by removing the Ethernet cable. Activate by inserting the Ethernet cable.</p>	

**For Europe:**

**Frequency band of operation 2400 to 2483.5 MHz:**

- *Bluetooth*/Wi-Fi: Maximum transmit power less than 20 dBm EIRP.
- *Bluetooth* Low Energy: Maximum power spectral density less than 10 dBm/MHz EIRP.

**Frequency bands of operation 5150 to 5350 MHz and 5470 to 5725 MHz:**

- Wi-Fi: Maximum transmit power less than 20dBm EIRP.

This device is restricted to indoor use when operating in the 5150 to 5350 MHz frequency range in all EU Member States listed in the table.

									
BE	DK	IE	UK	FR	CY	SK	HU	AT	SE
BG	DE	PT	EL	HR	LV	LT	MT	PL	
CZ	EE	FI	ES	IT	RO	LU	NL	SI	



This symbol means the product must not be discarded as household waste, and should be delivered to an appropriate collection facility for recycling. Proper disposal and recycling helps protect natural resources, human health and the environment. For more information on disposal and recycling of this product, contact your local municipality, disposal service, or the shop where you bought this product.

**Management Regulation for Low-power Radio-frequency Devices**

**Article XII**

According to “Management Regulation for Low-power Radio-frequency Devices” without permission granted by the NCC, any company, enterprise, or user is not allowed to change frequency, enhance transmitting power or alter original characteristic as well as performance to an approved low power radio-frequency devices.

**Article XIV**

The low power radio-frequency devices shall not influence aircraft security and interfere legal communications; If found, the user shall cease operating immediately until no interference is achieved. The said legal communications means radio communications operated in compliance with the Telecommunications Act.

The low power radio-frequency devices must be susceptible with the interference from legal communications or ISM radio wave radiated devices.



**Please dispose of used batteries properly, following local regulations.** Do not incinerate.

### China Restriction of Hazardous Substances Table

Names and Contents of Toxic or Hazardous Substances or Elements						
Part Name	Toxic or Hazardous Substances and Elements					
	Lead (Pb)	Mercury (Hg)	Cadmium (Cd)	Hexavalent (CR(VI))	Polybrominated Biphenyl (PBB)	Polybrominated diphenylether (PBDE)
PCBs	X	0	0	0	0	0
Metal Parts	X	0	0	0	0	0
Plastic Parts	0	0	0	0	0	0
Speakers	X	0	0	0	0	0
Cables	X	0	0	0	0	0
This table is prepared in accordance with the provisions of SJ/T 11364. O: Indicates that this toxic or hazardous substance contained in all of the homogeneous materials for this part is below the limit requirement of GB/T 26572. X: Indicates that this toxic or hazardous substance contained in at least one of the homogeneous materials used for this part is above the limit requirement of GB/T 26572.						

### Taiwan Restriction of Hazardous Substances Table

Equipment name: Powered Speaker, Type designation: 425842						
Restricted substances and its chemical symbols						
Unit	Lead (Pb)	Mercury (Hg)	Cadmium (Cd)	Hexavalent chromium (Cr+6)	Polybrominated biphenyls (PBB)	Polybrominated diphenyl ethers (PBDE)
PCBs	-	o	o	o	o	o
Metal Parts	-	o	o	o	o	o
Plastic Parts	o	o	o	o	o	o
Speakers	-	o	o	o	o	o
Cables	-	o	o	o	o	o
<b>Note 1:</b> "o" indicates that the percentage content of the restricted substance does not exceed the percentage of reference value of presence. <b>Note 2:</b> The "-" indicates that the restricted substance corresponds to the exemption.						

#### Please complete and retain for your records

The serial and model numbers are located on the back of the soundbar.

Serial number: \_\_\_\_\_

Model number: \_\_\_\_\_

Please keep your receipt with your owner's guide. Now is a good time to register your Bose product. You can easily do this by going to [global.Bose.com/register](http://global.Bose.com/register)

**Date of Manufacture:** The eighth digit in the serial number indicates the year of manufacture; “8” is 2008 or 2018.

**China Importer:** Bose Electronics (Shanghai) Company Limited, Part C, Plan 9, No. 353 North Riyang Road, China (Shanghai) Pilot Free Trade Zone

**EU Importer:** Bose Products B.V., Gorlaan 60, 1441 RG Purmerend, The Netherlands

**Taiwan Importer:** Bose Taiwan Branch, 9F-A1, No.10, Section 3, Minsheng East Road, Taipei City 104, Taiwan  
Phone Number: +886-2-2514 7676

**Mexico Importer:** Bose de México, S. de R.L. de C.V. , Paseo de las Palmas 405-204, Lomas de Chapultepec, 11000 México, D.F. Phone Number: +5255 (5202) 3545

**Input Rating:** 100 - 240V  $\sim$  50/60Hz, 65W

Amazon, Alexa, Amazon Music and all related logos are trademarks of Amazon, Inc. or its affiliates.

Android, Google Play, and the Google Play logo are trademarks of Google Inc.

The *Bluetooth*<sup>®</sup> word mark and logos are registered trademarks owned by Bluetooth SIG, Inc. and any use of such marks by Bose Corporation is under license.

**DOLBY AUDIO**<sup>™</sup> Dolby, Dolby Audio and the double-D symbol are trademarks of Dolby Laboratories.



For DTS patents, see <http://patents.dts.com>. Manufactured under license from DTS, Inc. DTS, the Symbol, DTS in combination with the Symbol, and DTS Digital Surround are registered trademarks or trademarks of DTS, Inc. in the United States and/or other countries. © DTS, Inc. All Rights Reserved.



The terms HDMI and HDMI High-Definition Multimedia Interface, and the HDMI logo are trademarks or registered trademarks of HDMI Licensing LLC in the United States and other countries.

This product contains the iHeartRadio service. iHeartRadio is a registered trademark of iHeartMedia, Inc.

Apple and the Apple logo are trademarks of Apple Inc., registered in the U.S. and other countries. App Store is a service mark of Apple Inc.

This product is protected by certain intellectual property rights of Microsoft. Use or distribution of such technology outside of this product is prohibited without a license from Microsoft.

This product incorporates Spotify software which is subject to 3rd party licenses found here:  
[www.spotify.com/connect/third-party-licenses](http://www.spotify.com/connect/third-party-licenses)

Spotify is a registered trademark of Spotify AB.

Designed with UEI Technology<sup>™</sup>. Under License from Universal Electronics, Inc. © UEI 2000-2018

Wi-Fi is a registered trademark of Wi-Fi Alliance<sup>®</sup>.

Bose Corporation Headquarters: 1-877-230-5639

©2018 Bose Corporation. No part of this work may be reproduced, modified, distributed or otherwise used without prior written permission.

**WHAT'S IN THE CARTON**

Contents ..... 11

**SOUNDBAR PLACEMENT**

Recommendations..... 12  
 Wall mount the soundbar ..... 13

**POWER**

Connect the soundbar to power..... 14  
 Network standby..... 14

**BOSE® MUSIC APP SETUP**

Download the Bose Music app..... 15

**EXISTING BOSE MUSIC APP USERS**

Add the soundbar to an existing account..... 16  
 Connect to a Wi-Fi® network ..... 16  
     If the soundbar is not connected to a network ..... 16  
     If the soundbar is connected to a network ..... 16

**ADAPTIQ® AUDIO CALIBRATION**

Run ADAPTIQ audio calibration using the Bose Music app..... 17

**SOUNDBAR CONTROLS**

Amazon Alexa controls ..... 18  
 Remote functions..... 19  
     Power..... 20  
     Sources ..... 21  
     Presets ..... 22  
     Media playback, channels and volume..... 23  
     Cable/satellite functions ..... 24

Adjust the bass ..... 24  
 Program a third-party remote ..... 24

**AMAZON ALEXA**

Set up Alexa using the Bose® Music app ..... 25  
 Access Alexa ..... 25  
     Use your voice ..... 25  
     Use the soundbar controls..... 26

**PRESET PERSONALIZATION**

Set a preset ..... 27  
 Play a preset ..... 29

**BLUETOOTH® CONNECTIONS**

Connect a mobile device ..... 30  
 Disconnect a mobile device..... 31  
 Reconnect a mobile device..... 31  
 Clear the soundbar pairing list ..... 31

**SOUNDBAR STATUS**

Wi-Fi status ..... 32  
*Bluetooth* status ..... 32  
 Alexa status..... 33  
     Microphone off indicator ..... 33  
 Update and error status ..... 34

**ADVANCED FEATURES**

Disable/enable Wi-Fi capability ..... 35  
 Connect accessories (optional)..... 36



**CARE AND MAINTENANCE**

Install the remote batteries..... 37

Clean the soundbar..... 38

Replacement parts and accessories..... 38

Limited warranty..... 38

**TROUBLESHOOTING**

Try these solutions first ..... 39

Other solutions ..... 39

Reset the soundbar..... 44

**APPENDIX: SETUP REFERENCE**

Connection options..... 45

Connect the soundbar to your TV ..... 46

    Option 1 (preferred): HDMI™ eARC or ARC..... 46

    Option 2: Optical..... 47

Check for sound ..... 48

## CONTENTS

Confirm that the following parts are included:



Bose® Soundbar 700



Bose® Soundbar Universal Remote



AA Battery (4)

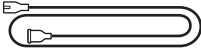

Power cord\*

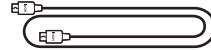

HDMI cable

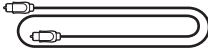

Optical cable



Cleaning cloth

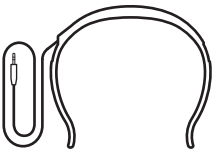

ADAPTiQ® headset

\*May ship with multiple power cords. Use the power cord for your region.

**NOTE:** If any part of the product is damaged or if the glass on the soundbar is broken, do NOT use it. Contact your authorized Bose® dealer or Bose customer service.

Visit: [worldwide.Bose.com/Support/SB700](http://worldwide.Bose.com/Support/SB700)

## RECOMMENDATIONS

For best performance, follow these recommendations when placing the soundbar:

Do NOT place any objects on top of the soundbar.

To avoid wireless interference, keep other wireless equipment 1 – 3 ft. (0.3 – 0.9 m) away from the soundbar. Place the soundbar outside and away from metal cabinets, other audio/video components and direct heat sources.

Place the soundbar directly below (preferred) or above your TV with the grille facing into the room.

Place the soundbar on its rubber feet on a stable and level surface. For proper support, both feet must be resting on the surface. Vibration can cause the soundbar to move, particularly on smooth surfaces like marble, glass or highly polished wood.

Keep the back side of the soundbar at least 0.4 in. (1 cm) from any other surface. Blocking the ports on this side affects acoustic performance.

Make sure there is an AC (mains) outlet nearby.

For best sound quality, do NOT place the soundbar in an enclosed cabinet or diagonally in a corner.

If placing the soundbar on a shelf or TV stand, position the front of the soundbar as close as possible to the front edge of the shelf or TV stand for optimal acoustic performance.

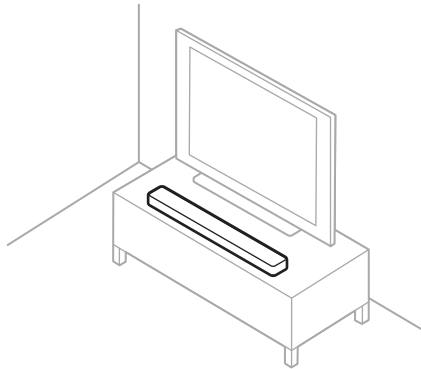

**CAUTION:** Do NOT place the soundbar on its front, back or top when in use.

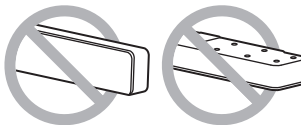

## **WALL MOUNT THE SOUNDBAR**

You can mount the soundbar on a wall. To purchase the Bose® Soundbar Wall Bracket, contact your authorized Bose® dealer.

Visit: [worldwide.bose.com/Support/SB700](https://worldwide.bose.com/Support/SB700)

**CAUTION:** Do NOT use any other hardware to mount the soundbar.

## CONNECT THE SOUNDBAR TO POWER

1. Connect the power cord to the **POWER** connector on the back of the soundbar.
2. Plug the other end of the power cord into an AC (mains) power outlet.

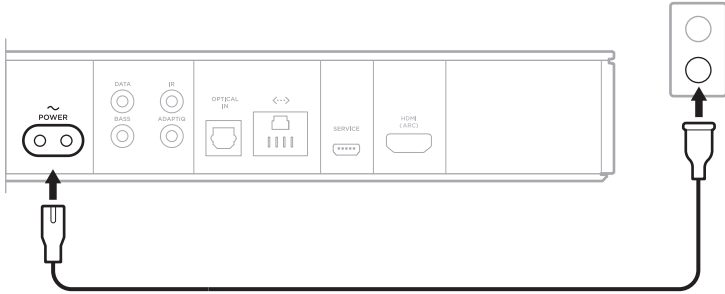

The soundbar powers on.

## NETWORK STANDBY

The soundbar transitions to network standby when audio has stopped and you have not pressed any buttons for 20 minutes. To wake the soundbar from network standby:

Play or resume audio using your mobile device or the Bose® Music app.

Talk to Alexa.

On the remote, press the Power button , a source button (see page 21), or Bose Music button  then a preset button (see page 22).

### NOTES:

You can still access Alexa in network standby as long as Alexa has been set up using the Bose Music app and the microphone is on (see page 33).

You can disable the standby timer using the Bose Music app.

The Bose Music app lets you set up and control the soundbar from your mobile device, such as a smartphone or tablet. Using the app, your device acts as an additional remote for the soundbar.

From the app, you can stream music, set and change presets, add music services, explore internet radio stations, configure Alexa and manage soundbar settings.

**NOTE:** If you have already created a Bose account in the Bose Music app for another Bose product, see “Existing Bose® Music App Users” on page 16.

## DOWNLOAD THE BOSE MUSIC APP

1. On your mobile device, download the Bose Music app.



2. Follow the app instructions.

**NOTE:** For support information related to the Bose Music app, visit: [worldwide.Bose.com/Support/SB700](https://worldwide.Bose.com/Support/SB700)

## ADD THE SOUNDBAR TO AN EXISTING ACCOUNT

1. In the Bose Music app, from the **My Bose** screen, tap +.



**NOTE:** To return to the **My Bose** screen, tap  in the top left corner.

2. Follow the app instructions.

## CONNECT TO A WI-FI NETWORK

### If the soundbar is not connected to a network

If your soundbar is no longer connected to a network because your Wi-Fi name, password or router has changed, add the soundbar to your existing network.

1. In the Bose Music app, select your soundbar.
2. On the remote, press the TV button  and Skip backward button .
3. Follow the app instructions.

### If the soundbar is connected to a network

If your soundbar is connected to a network and you would like to switch to a new network, add the soundbar to the new network.

1. In the Bose Music app, from the **My Bose** screen, select your soundbar.
2. Tap the soundbar image in the bottom-right corner of the screen.
3. Tap **Settings > Wi-Fi > Select a Different Network**.
4. Follow the app instructions.

After you set up the soundbar using the Bose® Music app, the app prompts you to run ADAPTIQ audio calibration for best acoustic performance. ADAPTIQ audio calibration customizes the sound of the system to the acoustics of your listening area by taking five audio measurements. To run an audio calibration, you need 10 minutes when the room is quiet.

During ADAPTIQ audio calibration, a microphone on the top of the ADAPTIQ headset (provided with the soundbar) measures the sound characteristics of your room to determine optimal sound quality.

## **RUN ADAPTIQ AUDIO CALIBRATION USING THE BOSE MUSIC APP**

If you later connect an optional bass module or surround speakers, move the soundbar or move any furniture, run ADAPTIQ audio calibration again to ensure optimal sound quality.

1. In the Bose Music app, from the **My Bose** screen, select your soundbar.
2. Tap the soundbar image on the bottom-right corner of the screen.
3. Tap **Settings > ADAPTIQ > Run ADAPTIQ**.
4. Follow the app instructions.



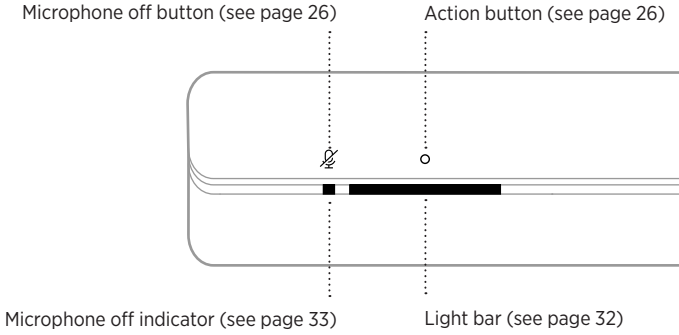

The soundbar controls are located on the top of the soundbar and on the remote.

**NOTE:** You can also control your soundbar using the Bose® Music app.



## AMAZON ALEXA CONTROLS

The Action button  and Microphone off button  are used to control Alexa. For information about how to access Alexa, see page 25.

## REMOTE FUNCTIONS

Use the remote to control your soundbar, sources connected to your soundbar, *Bluetooth* connections and set and change presets.

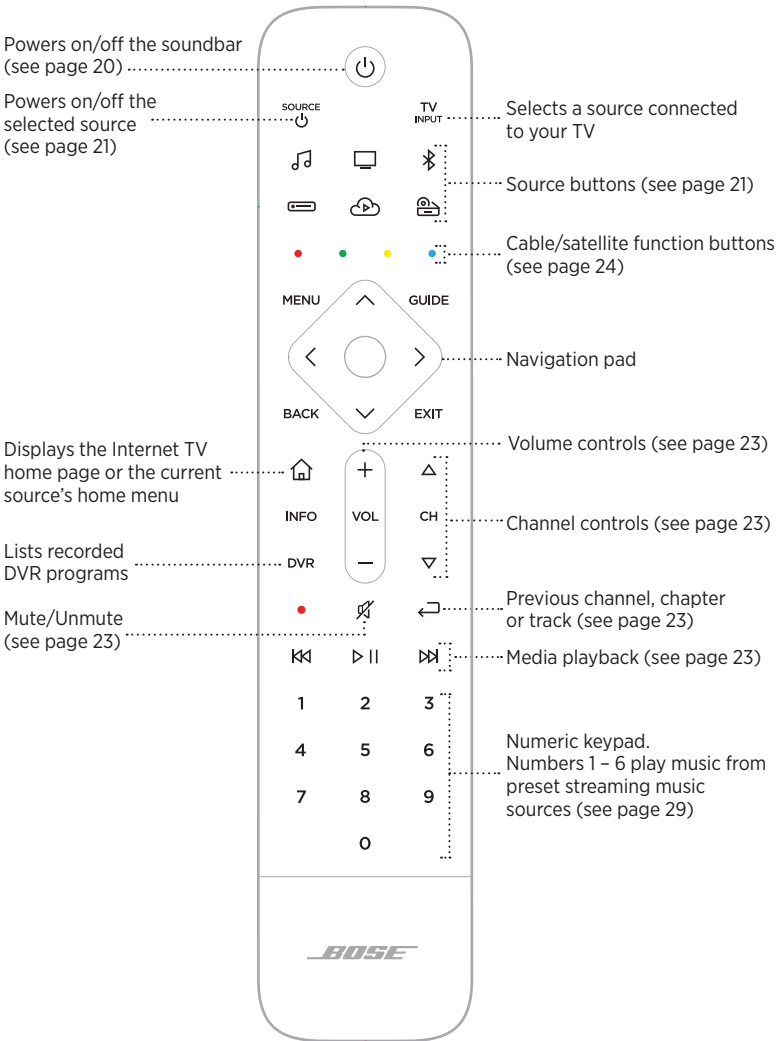

**NOTE:** You can also program your remote using the Bose® Music app.

## Power

To power the soundbar on/off, press the Power button  on the remote.

When powered on, the remote buttons glow according to the last active source.

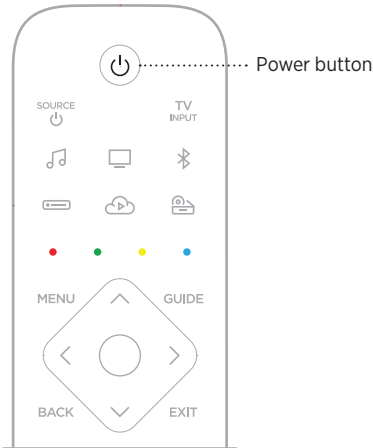

### NOTES:

When you plug the soundbar into an AC (mains) outlet, the soundbar automatically powers on.



The first time the soundbar is powered on, the soundbar defaults to TV  source.

You can still access Alexa when the soundbar is powered off as long as Alexa has been set up using the Bose® Music app and the microphone is on (see page 33).

## Sources

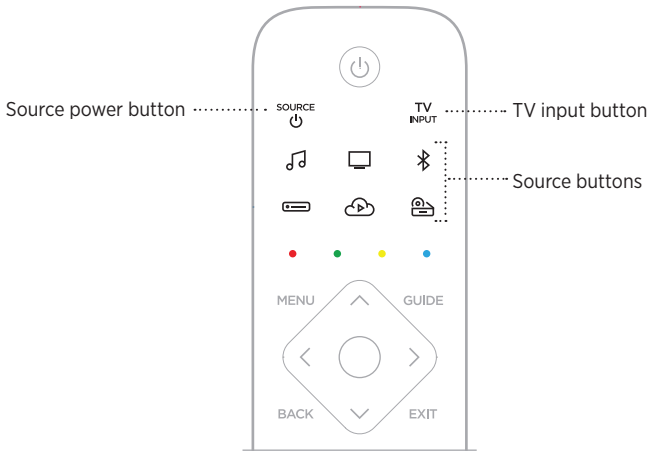
The remote has four programmable source buttons (TV, cable/satellite box, cloud and Blu-ray). You can program these buttons to control your TV, cable/satellite box, game system, DVD or Blu-ray Disc™ player or other source. You can switch between sources by selecting different inputs on your TV using the remote.



1. On the remote, press the appropriate source button (TV, cable/satellite box, cloud and Blu-ray).  
The remote buttons glow according to the selected source.
2. Press <sup>SOURCE</sup> .
3. Press <sup>TV</sup> .
4. Select the correct input on your TV.

### NOTES:

If CEC is enabled on your TV, the TV may automatically switch the source when the source is powered on.

Pressing source buttons on the remote does not switch the source. It powers on the soundbar and changes the mode of the remote so that the remote can control the source functions.

The remote is programmed to your TV during setup using the Bose® Music app. If you replace your TV, use the Bose Music app to program the remote to your new TV.

## Presets

The soundbar includes six presets that you can set to your favorite music services, stations, playlists, artists, albums or songs from your music library. Once set, you can access your music, at any time, with a simple touch of a button on the remote or using the Bose® Music app.

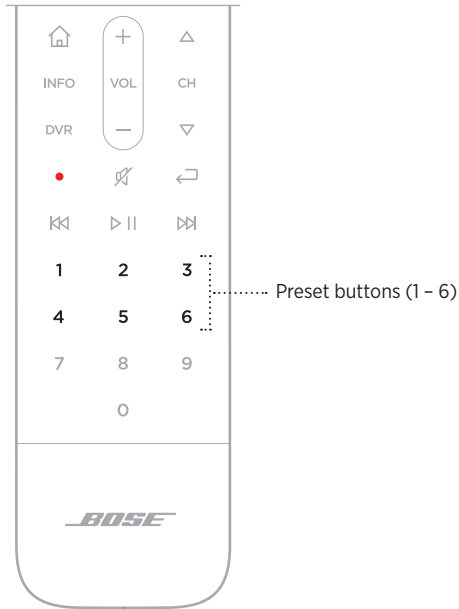

For more information about presets, see “Preset Personalization” on page 27.

## Media playback, channels and volume

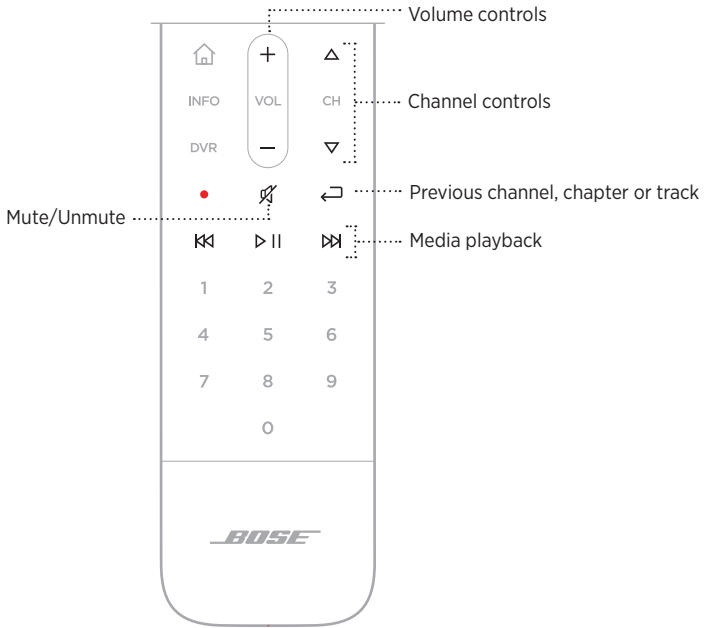

FUNCTION	WHAT TO DO
<b>Play/Pause</b>	Press ▷  .
<b>Skip backward</b>	Press ◀◀.
<b>Skip forward</b>	Press ▶▶.
<b>Previous channel, chapter or track</b>	Press ◀◁.
<b>Volume up</b>	Press +. <b>NOTE:</b> To quickly increase the volume, press and hold +.

FUNCTION	WHAT TO DO
<b>Volume down</b>	Press —. <b>NOTE:</b> To quickly decrease the volume, press and hold —.
<b>Mute/Unmute</b>	Press ✕.
<b>Channel up</b>	Press △.
<b>Channel down</b>	Press ▽.

### Cable/satellite functions

The red, green, yellow and blue buttons on the remote correspond with the color-coded function buttons on your cable/satellite box. Refer to your cable/satellite box owner's guide.

### ADJUST THE BASS

1. In the Bose® Music app, from the **My Bose** screen, select your soundbar.
2. Tap the soundbar image in the bottom-right corner of the screen.
3. Tap **Adjustments** to adjust the bass.

### PROGRAM A THIRD-PARTY REMOTE

You can program a third-party remote, such as your cable/satellite box remote, to control the soundbar. Refer to your third-party remote owner's guide or website for instructions.

Once programmed, the third-party remote controls basic soundbar functions such as power on/off and volume.

**NOTE:** Not all third-party remotes are compatible with the soundbar. The remote must support IR (infrared) signals in order to control the soundbar.

The soundbar is Amazon Alexa enabled. With Alexa, you can ask to play music, hear the news, check the weather, control smart home devices and more. Using Alexa on your soundbar is as simple as asking. Just ask or use the Action button  and Alexa responds instantly.

**NOTE:** Alexa isn't available in all languages and countries.

## SET UP ALEXA USING THE BOSE® MUSIC APP

1. In the Bose Music app, from the **My Bose** screen, select your soundbar.
2. Tap the soundbar image in the bottom-right corner of the screen.
3. Tap **Settings > Voice Assistant > Add**.
4. Follow the app instructions.

## ACCESS ALEXA

You can access Alexa using your voice or the Action button .

**NOTE:** For more information about what Alexa can do, visit: [worldwide.bose.com/Support/SB700](https://worldwide.bose.com/Support/SB700)

## Use your voice



To access Alexa, say the wake word “Alexa,” then your request.

THINGS TO TRY	EXAMPLE OF WHAT TO SAY
<b>Talk to Alexa</b>	“Alexa, what’s the weather?”
<b>Play audio</b>	“Alexa, play Niall Horan.” <b>NOTE:</b> Amazon Music is set as the default music service. To change the default music service, use the Alexa app.
<b>Control volume</b>	“Alexa, turn the volume up.”
<b>Play from a specific audio service</b>	“Alexa, play NPR on iHeartRadio.”
<b>Play on a specific speaker</b>	“Alexa, play funk in the living room.”





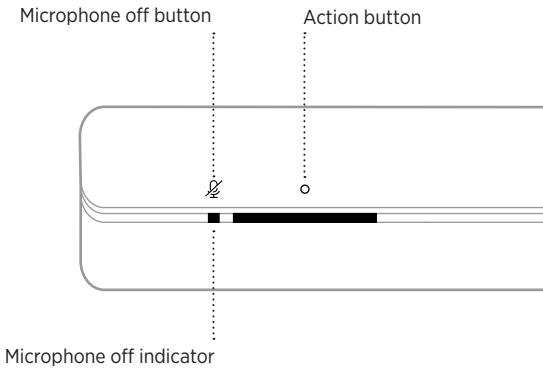

THINGS TO TRY	EXAMPLE OF WHAT TO SAY
Skip to the next song	“Alexa, next song.”
Set a timer	“Alexa, set a timer for 5 minutes.”
Discover more skills	“Alexa, what new skills do you have?”
Stop Alexa	“Alexa, stop.”

### Use the soundbar controls

The Action button  and Microphone off button  are used to control Alexa. They are located on the top of the soundbar.



THINGS TO TRY	WHAT TO DO
Access Alexa	Tap  then say your request. For a list of things to try, visit <a href="http://worldwide.Bose.com/Support/SB700">worldwide.Bose.com/Support/SB700</a>
Stop timer	Tap  .
Stop Alexa	Tap  .
Turn the microphone on/off	Tap  . <b>NOTE:</b> When the microphone is off, the Microphone off indicator glows solid red, and you can't access Alexa.

You can control presets using the Bose® Music app and remote.

Before using presets, note the following:

If the preset source is your music library, make sure the computer storing your music library is on and connected to the same network as the soundbar.

You can't set presets while in *Bluetooth* mode.

## SET A PRESET

1. Stream music using the Bose Music app.
2. On the remote, press the Bose Music button .

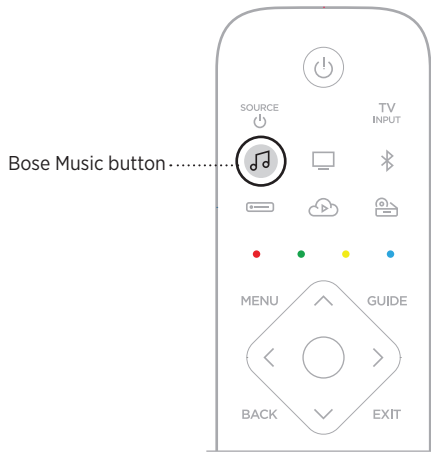

3. Press and hold a preset button until you hear a tone.

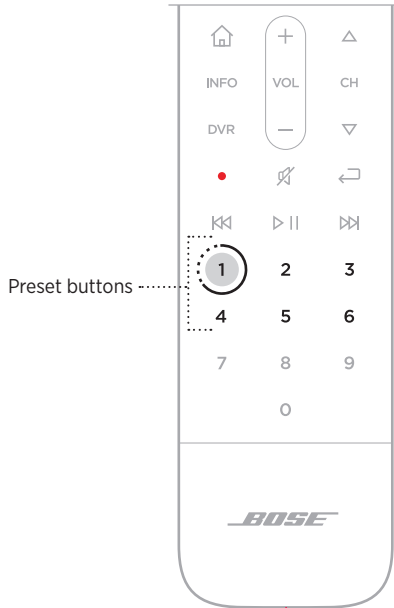

## PLAY A PRESET

1. On the remote, press the Bose® Music button .
2. Press a preset button to play music.

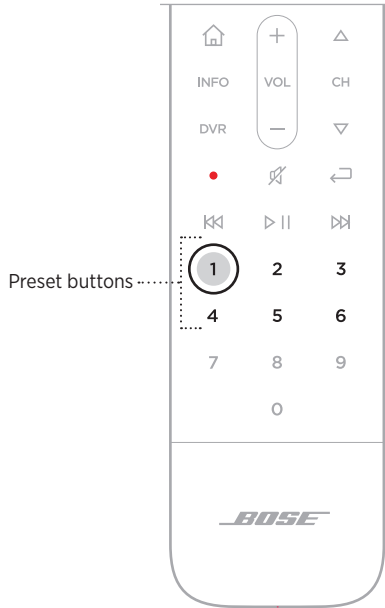

*Bluetooth* wireless technology lets you stream music from mobile devices such as smartphones, tablets and laptop computers. Before you can stream music from a device, you must connect your device to the soundbar.

When using *Bluetooth* on the soundbar, note the following:

- You can store up to eight mobile devices in the soundbar pairing list.
- You can connect and play audio from only one device at a time.
- You can also manage *Bluetooth* connections using the Bose® Music app.

## CONNECT A MOBILE DEVICE

1. On the remote, press and hold the *Bluetooth* button  until the light bar pulses blue.

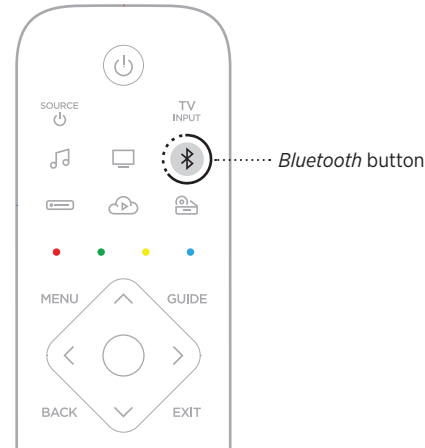

2. On your mobile device, turn on the *Bluetooth* feature.

**TIP:** The *Bluetooth* menu is usually found in the Settings menu.

3. Select your soundbar from the device list.

**TIP:** Look for the name you entered for your soundbar in the Bose® Music app. If you didn't name your soundbar, the default name appears.



Once connected, you hear a tone and the light bar glows solid white. The soundbar's name appears in the mobile device list.

## DISCONNECT A MOBILE DEVICE

Use the *Bluetooth* menu on your mobile device to disconnect your device.

## RECONNECT A MOBILE DEVICE

On the remote, press the *Bluetooth* button .

The soundbar tries to connect with the most recently connected device.

**NOTE:** The device must be within 30 ft. (9 m) and powered on.

## CLEAR THE SOUNDBAR PAIRING LIST

On the remote, press and hold  for 10 seconds until the light bar pulses blue twice.

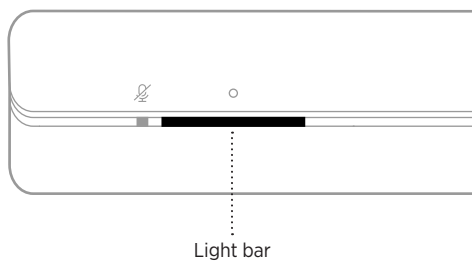

The LED light bar located on the front of the soundbar shows the soundbar status.



**NOTE:** The light bar displays one status at a time of the selected source.





## WI-FI STATUS

Shows the Wi-Fi connection status of the soundbar.

LIGHT BAR ACTIVITY	SYSTEM STATE
<b>Pulsing white</b> 	Connecting to Wi-Fi
<b>Solid white then fades to black</b> 	Connected to Wi-Fi

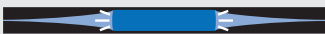



## BLUETOOTH STATUS

Shows the *Bluetooth* connection status of mobile devices.

LIGHT BAR ACTIVITY	SYSTEM STATE
<b>Pulsing blue</b> 	Ready to connect to mobile device
<b>Pulsing white</b> 	Connecting to mobile device
<b>Solid white then fades to black</b> 	Connected to mobile device
<b>Pulses blue twice</b> 	Pairing list cleared

## ALEXA STATUS

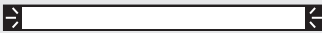
Shows the status of Amazon Alexa.

LIGHT BAR ACTIVITY	SYSTEM STATE
<b>Off</b> 	Alexa is idle
<b>White light slides to the center then glows solid</b> 	Alexa is listening
<b>White light slides to the sides</b> 	Alexa is thinking
<b>Pulsing white (full)</b> 	Alexa is speaking
<b>Pulsing yellow</b> 	Notification from Alexa

## Microphone off indicator

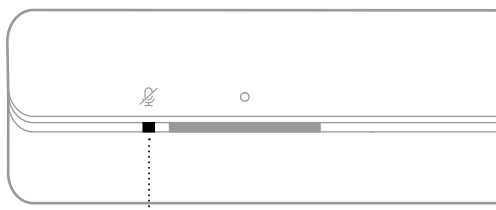







Microphone off indicator

INDICATOR ACTIVITY	SYSTEM STATE
<b>Solid red</b>	The microphone is off





## UPDATE AND ERROR STATUS

Shows the status of software updates and error alerts.

LIGHT BAR ACTIVITY		SYSTEM STATE
<b>Solid amber</b>		Wi-Fi setup in progress
<b>White light slides from right to left</b>		Downloading update
<b>White light slides from left to right</b>		Updating soundbar
<b>Pulses amber four times</b>		Source error - refer to the Bose® Music app
<b>Pulses red four times</b>		Request is temporarily unavailable. Try again later.
<b>Solid red</b>		Soundbar error - contact Bose customer service

## DISABLE/ENABLE WI-FI CAPABILITY

On the remote, press and hold the Bose® Music button  and Skip forward button  until the light bar slides to the center, then glows solid white.

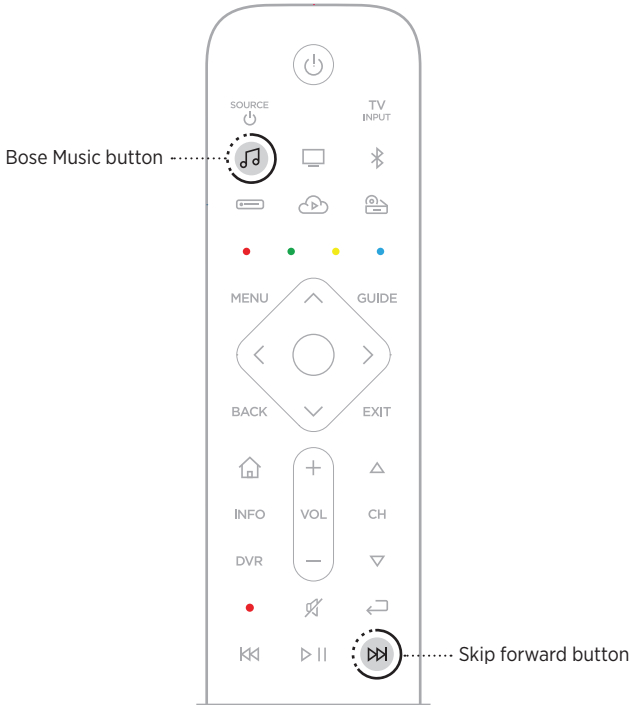

When Wi-Fi is enabled/disabled, the light bar pulses white twice, then fades to black.

## CONNECT ACCESSORIES (OPTIONAL)

You can connect any of these accessories to your soundbar. For more information, refer to your product owner's guide.

**Bose® Bass Module 500:** [worldwide.bose.com/Support/BASS500](https://worldwide.bose.com/Support/BASS500)

**Bose Bass Module 700:** [worldwide.bose.com/Support/BASS700](https://worldwide.bose.com/Support/BASS700)

**Acoustimass® 300 bass module:** [global.bose.com/Support/AM300](https://global.bose.com/Support/AM300)

**Bose Surround Speakers:** [worldwide.bose.com/Support/WSS](https://worldwide.bose.com/Support/WSS)

**Virtually Invisible® 300 wireless surround speakers:**

[global.bose.com/Support/VI300](https://global.bose.com/Support/VI300)

## INSTALL THE REMOTE BATTERIES

1. Slide open the battery compartment cover on the back of the remote.

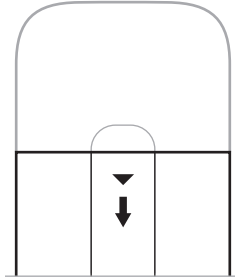

2. Insert the four provided AA (IEC-LR3) 1.5V batteries. Match the + and – symbols on the batteries with the + and – markings inside the compartment.

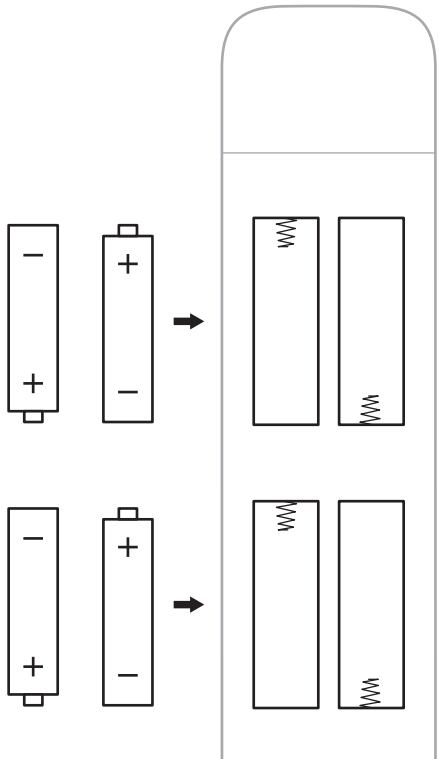

3. Slide the battery compartment cover back into place.

## **CLEAN THE SOUNDBAR**

Clean the exterior of the soundbar with the provided cleaning cloth or another soft dry cloth.

### **CAUTIONS:**

- Do NOT allow liquids to spill onto the system or into any openings.
- Do NOT blow air into the system.
- Do NOT use a vacuum to clean the system.
- Do NOT use any sprays near the system.
- Do NOT use any solvents, chemicals or cleaning solutions containing alcohol, ammonia or abrasives.
- Do NOT allow objects to drop into any openings.

## **REPLACEMENT PARTS AND ACCESSORIES**

Replacement parts and accessories can be ordered through Bose customer service.

Visit: [worldwide.Bose.com/Support/SB700](https://worldwide.Bose.com/Support/SB700)

## **LIMITED WARRANTY**

The soundbar is covered by a limited warranty. Visit our website at [global.Bose.com/warranty](https://global.Bose.com/warranty) for details of the limited warranty.

To register your product, visit [global.Bose.com/register](https://global.Bose.com/register) for instructions. Failure to register will not affect your limited warranty rights.

## TRY THESE SOLUTIONS FIRST

If you experience problems with the soundbar:

Make sure the soundbar is connected to a live AC (mains) outlet.

Secure all cables.

Verify the state of the light bar (see page 32).

Move the soundbar away 1 – 3 ft. (0.3 – 0.9 m) from possible interference (wireless routers, cordless phones, televisions, microwaves, etc.).

Move the soundbar within the recommended range of your wireless router or mobile device for proper operation.



Place the soundbar according to the placement guidelines (see page 12).

## OTHER SOLUTIONS

If you could not resolve your issue, see the table below to identify symptoms and solutions to common problems. If you are unable to resolve your issue, contact Bose customer service.

Visit: [worldwide.Bose.com/Support/SB700](http://worldwide.Bose.com/Support/SB700)

SYMPTOM	SOLUTION
<b>No HDMI eARC (ARC) or optical connector on your TV</b>	Connect to your TV using an audio converter and separate audio cable, such as a coaxial, 3.5 mm or analog audio cable (not provided). The type of converter and cable you need depends on the audio output connectors available on your TV.
<b>Soundbar doesn't power on</b>	<p>Plug the power cord into a different AC (mains) outlet.</p> <p>Use the remote to power on the soundbar (see page 20).</p> <p>Unplug the power cords for the soundbar and optional bass module or surround speakers, wait 30 seconds and firmly plug them into the AC (mains) outlet.</p>

SYMPTOM	SOLUTION
<p><b>Remote is inconsistent or does not work</b></p>	<p>Match the + and — symbols on the batteries with the + and — markings inside the compartment (see page 37).</p> <p>Replace the batteries (see page 37).</p> <p>Make sure the remote is within operating range 20 ft. (0.6 m) of the soundbar.</p> <p>Make sure there are no obstructions between the remote and the soundbar.</p> <p>Make sure you are in the correct source by pressing the volume button on the remote to see if the correct source button flashes.</p> <p>On the soundbar, tap and hold the Action button  for 5 seconds to pair the remote with the soundbar. Insert the batteries into the remote (see page 37). The remote turns on and the source buttons glow.</p> <p><b>NOTE:</b> This solution applies only if Alexa has not been set up.</p>
<p><b>Intermittent or no audio</b></p>	<p>If the sides of the light bar are pulsing, the soundbar is muted. Press the Mute/Unmute button  to unmute the soundbar.</p> <p>Make sure your mobile device is not muted.</p> <p>Increase the volume on the soundbar (see page 23) or your mobile device.</p> <p>Switch to a different source (see page 21).</p> <p>Play audio from a different application or music service.</p> <p>If the audio is from a Wi-Fi source, reset the router.</p> <p>Restart your mobile device.</p> <p>Make sure you're using a compatible <i>Bluetooth</i> mobile device.</p> <p><b>NOTE:</b> You can't connect <i>Bluetooth</i> headphones to the soundbar.</p> <p>Make sure that the soundbar's HDMI cable is inserted into a connector on your TV labeled <b>eARC</b> or <b>ARC (Audio Return Channel)</b>, not a standard HDMI connector. If your TV does not have an HDMI eARC or ARC connector, connect the soundbar using the optical cable (see page 47).</p> <p>If the soundbar is connected to your TV's HDMI eARC or ARC connector, make sure that <b>Consumer Electronics Control (CEC)</b> is enabled in your TV system menu. Your TV may refer to CEC by a different name. Refer to your TV owner's guide.</p> <p>Disconnect the soundbar's HDMI cable from your TV's HDMI eARC or ARC connector and reconnect it.</p> <p>Insert the optical cable into a connector on your TV labeled <b>Output</b> or <b>OUT</b>, not Input or IN.</p> <p>Unplug the power cords for the soundbar and optional bass module or surround speakers, wait 30 seconds and firmly plug them into the AC (mains) outlet.</p>

SYMPTOM	SOLUTION
<p><b>Soundbar doesn't connect to bass module or surround speakers</b></p>	<p>Refer to your bass module or surround speakers owner's guide for troubleshooting (see page 36).</p> <p>Make sure your bass module or surround speakers are compatible with the soundbar (see page 36).</p> <p>Unplug the power cords for the soundbar and optional bass module or surround speakers, wait 30 seconds and firmly plug them into the AC (mains) outlet.</p>
<p><b>No audio from bass module or surround speakers</b></p>	<p>Make sure your bass module or surround speakers are compatible with the soundbar (see page 36).</p> <p>Make sure the software is current in the Bose® Music app.</p> <p>Adjust the bass level using the Bose Music app (see page 24).</p> <p>Switch to a different source (see page 21).</p>
<p><b>Sound is coming from TV speaker</b></p>	<p>Make sure that the soundbar's HDMI cable is inserted into a connector on your TV labeled <b>eARC</b> or <b>ARC (Audio Return Channel)</b>. If your TV does not have an HDMI eARC or ARC connector, connect to the soundbar using the optical cable (see page 47).</p> <p>Turn off your TV speakers. Refer to your TV owner's guide.</p> <p>If the soundbar is connected to your TV's HDMI eARC or ARC connector, make sure that <b>Consumer Electronics Control (CEC)</b> is enabled in your TV system menu. Your TV may refer to CEC by a different name. Refer to your TV owner's guide.</p> <p>Disconnect the soundbar's HDMI cable from your TV's HDMI eARC or ARC connector and reconnect it.</p> <p>Decrease your TV volume to its lowest setting.</p> <p>Connect to the soundbar using both the HDMI cable (see page 46) and optical cable (see page 47).</p>
<p><b>Poor or distorted audio</b></p>	<p>Test different sources if available.</p> <p>Make sure that your TV can output surround sound audio. Refer to your TV owner's guide.</p> <p>If the audio is being played from another device, reduce the volume of that device.</p> <p>Adjust the bass level using the Bose Music app (see page 24).</p> <p>Power off your TV speakers. Refer to your TV owner's guide.</p> <p>Run ADAPTiQ® audio calibration (see page 17).</p>





SYMPTOM	SOLUTION
<b>Soundbar doesn't play audio from the correct source or selects the incorrect source after a delay</b>	<p>Set CEC to Alternate On using the Bose® Music app.</p> <p>Disable CEC on your source (refer to the source owner's guide for more information).</p> <p>Connect to the soundbar using both the HDMI cable (see page 46) and the optical cable (see page 47).</p>
<b>Soundbar and source do not power on/off simultaneously</b>	<p>On the remote, press the source button for the source that is out of sync.</p> <p>Press the Power button (⏻) to power on/off the source.</p>
<b>Soundbar doesn't connect to Wi-Fi network</b>	<p>In the Bose Music app, select correct network name, and enter the network password (case-sensitive).</p> <p>Make sure the soundbar and your mobile device are connected to the same Wi-Fi network.</p> <p>If your network information has changed, see page 16.</p> <p>Enable Wi-Fi on the mobile device you are using for setup.</p> <p>Close other open applications on your mobile device.</p> <p>Restart your mobile device and router.</p> <p>If your router supports both 2.4GHz and 5GHz bands, make sure both the mobile device and soundbar are connecting to the same band.</p> <p><b>NOTE:</b> Give each band a unique name to make sure you're connecting to the correct band.</p> <p>Reset the router.</p> <p>Unplug the power cords for the soundbar and optional bass module or surround speakers, wait 30 seconds and firmly plug them into the AC (mains) outlet. Uninstall the Bose Music app on your mobile device, reinstall the app and restart setup.</p> <p>Connect to the network using an Ethernet cable.</p>
<b>Soundbar doesn't connect to mobile device</b>	<p>On your mobile device, turn the <i>Bluetooth</i> feature off and then on. Delete the soundbar from the <i>Bluetooth</i> list. Connect again (see page 30).</p> <p>Connect a different mobile device (see page 30).</p> <p>Make sure you're using a compatible <i>Bluetooth</i> mobile device.</p> <p><b>NOTE:</b> You can't connect <i>Bluetooth</i> headphones to the soundbar.</p> <p>Remove the soundbar from your mobile device <i>Bluetooth</i> pairing list and connect again (see page 30).</p> <p>Clear the soundbar's pairing list (see page 31) and connect again (see page 30).</p>

SYMPTOM	SOLUTION
<b>Bose® Music app doesn't work on mobile device</b>	<p>Make sure the Bose Music app is compatible with your device. Visit: <a href="https://worldwide.Bose.com/Support/SB700">worldwide.Bose.com/Support/SB700</a></p> <p>Uninstall the Bose Music app on your mobile device then reinstall the app (see page 15).</p>
<b>Soundbar isn't visible to add to another Bose account</b>	<p>In the Bose Music app, make sure the soundbar is set to Public.</p> <p>Make sure the soundbar and your mobile device are connected to the same Wi-Fi network.</p>
<b>Alexa doesn't respond</b>	<p>Make sure Alexa has been set up using the Bose Music app (see page 25).</p> <p><b>NOTE:</b> The soundbar must be set up and connected to your Wi-Fi network using the Bose Music app.</p> <p>Make sure you're in a country where Amazon Alexa is available.</p> <p>Make sure the Microphone off indicator is not glowing red. To turn on the microphone, see page 26.</p> <p>For additional support, visit: <a href="https://worldwide.Bose.com/Support/SB700">worldwide.Bose.com/Support/SB700</a></p>
<b>Preset doesn't respond</b>	<p>Make sure the preset has been set (see page 27).</p>

## RESET THE SOUNDBAR

Factory reset clears all source, volume, network and ADAPTiQ® audio calibration settings from the soundbar and returns it to original factory settings.

1. On the remote, press and hold the Power button  and Skip forward button  for 10 seconds until the left side of the light bar pulses white.

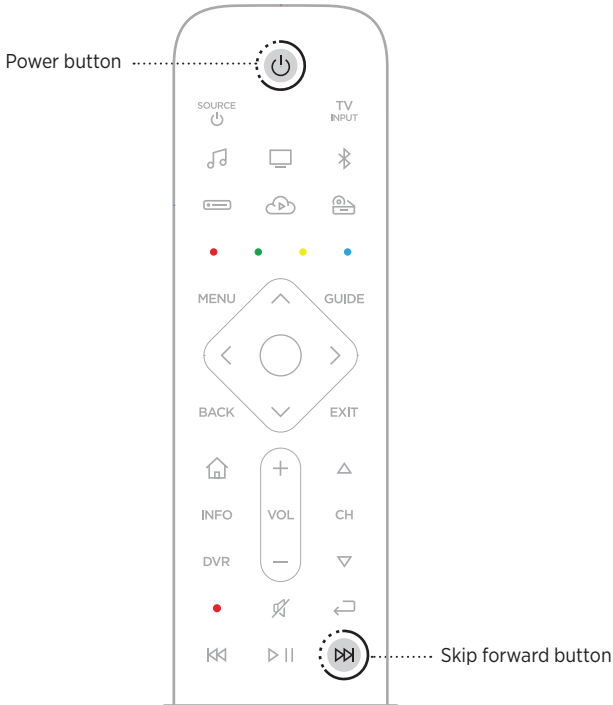

The soundbar reboots. When the reset is complete, the light bar glows solid amber.

2. To restore the soundbar's network and audio settings:
  - a. Launch the Bose® Music app on your mobile device and add the soundbar to your network (see “Existing Bose® Music App Users” on page 16).
  - b. Run ADAPTiQ audio calibration using the Bose Music app.

## CONNECTION OPTIONS

Connect the soundbar to your TV using one of the following connection options:

**Option 1 (preferred):** HDMI eARC or ARC (Audio Return Channel)

**Option 2:** Optical

**NOTE:** The preferred option is to connect the soundbar to your TV's HDMI eARC or ARC connector using the HDMI cable.

1. On the back of your TV, locate the **HDMI IN** and **Audio OUT** (digital) connector panels.

**NOTE:** Your TV's connector panel may not appear as shown. Look for the shape of the connector.

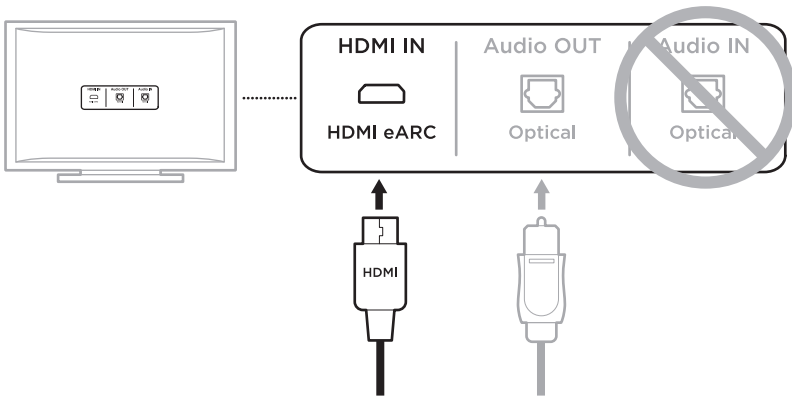

**Option 1 (Preferred)**  
**HDMI eARC or ARC:** Use the HDMI cable for this connection.

**Option 2**  
**Optical:** If your TV doesn't have an HDMI eARC or ARC connector, use an optical cable for this connection.

2. Choose an audio cable.

## CONNECT THE SOUNDBAR TO YOUR TV

After choosing an audio cable, connect the soundbar to your TV.

### Option 1 (preferred): HDMI eARC or ARC

1. Insert one end of the HDMI cable into your TV's **HDMI eARC** or **ARC** connector.

**NOTE:** Make sure you insert the HDMI cable into an HDMI eARC or ARC connector on your TV, not a standard HDMI connector. If your TV does not have an HDMI eARC or ARC connector, see page 47.

2. Insert the other end of the cable into the **HDMI (ARC)** connector on the soundbar.

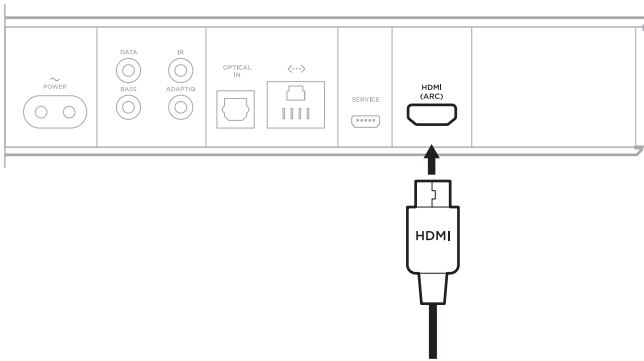

## Option 2: Optical

If your TV doesn't have an HDMI eARC or ARC connector, use the optical cable to connect the soundbar to your TV.

1. Remove the protective cap from both ends of the optical cable.

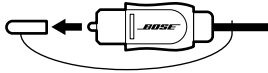

**CAUTION:** Inserting the plug in the wrong orientation can damage the plug and/or the connector.

2. Insert one end of the optical cable into your TV's **Optical OUT** connector.
3. Hold the plug at the other end of the optical cable.
4. Align the plug with the soundbar's **OPTICAL IN** connector, and insert the plug carefully.

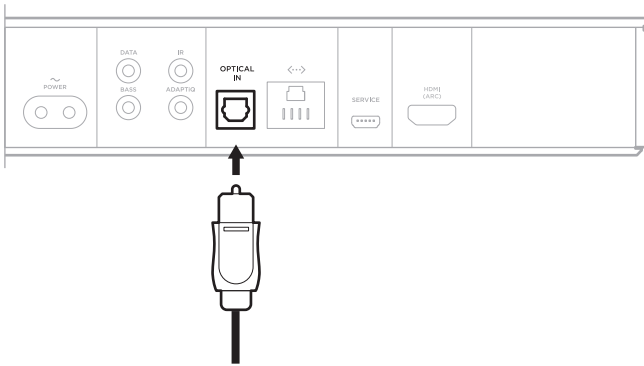



**NOTE:** The connector has a hinged door that swings inward when inserting the plug.

5. Firmly push the plug into the connector until you hear or feel a click.



## CHECK FOR SOUND

**NOTE:** To avoid hearing distorted audio, turn off your TV speakers. Refer to your TV owner's guide for more information.

1. Power on your TV.
  2. If you are using a cable/satellite box or other secondary source:
    - a. Power on this source.
    - b. Select the appropriate TV input.
  3. If the soundbar is not powered on, press the Power button  on the remote.  
You hear sound coming from the soundbar.
  4. Press the Mute/Unmute button .
- You don't hear sound coming from the TV speakers or soundbar.

**NOTE:** If you don't hear sound coming from the soundbar or hear sound coming from your TV speakers, see "Troubleshooting" on page 39.