

Serial number

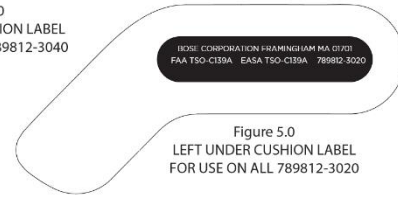
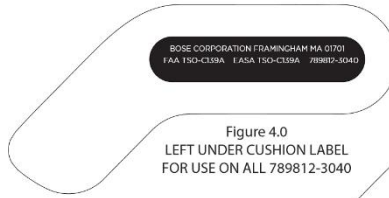
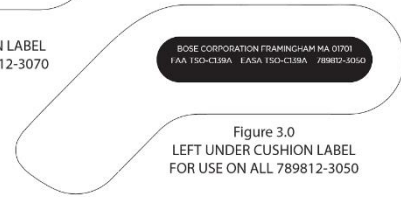
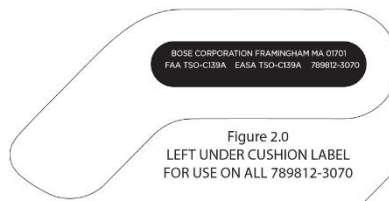
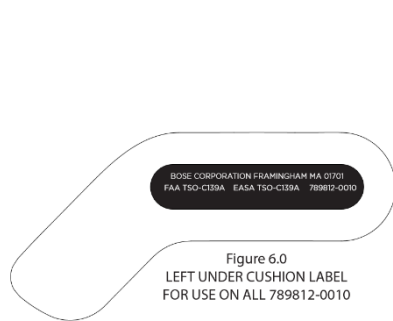
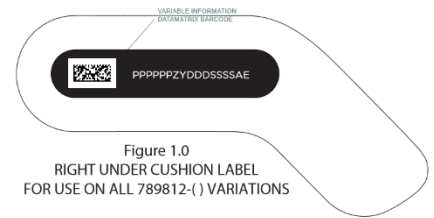
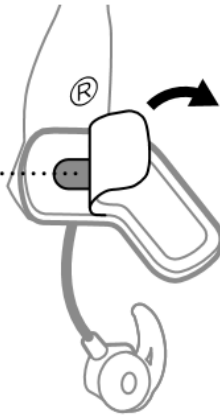



Figure 1.0
806704-3040
DIPSWITCH LABEL
FOR USE ON 801956-3040



Figure 3.0
806704-3040
DIPSWITCH LABEL
FOR USE ON 801956-3020



Figure 2.0
806704-3050
DIPSWITCH LABEL
FOR USE ON 801956-3050



Figure 4.0
806704-3070
DIPSWITCH LABEL
FOR USE ON 801956-3070

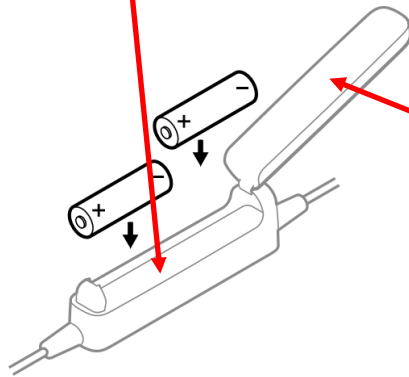

CABLE SERIAL NUMBER VARIATION TABLE

PART NUMBER	DESCRIPTION	MATERIAL ID
801956-3020	CABLE,ICS,DUAL PLUG,ACCY	078694
801956-3040	CABLE,ICS,LEMO,ACCY	078695
801956-3050	CABLE,ICS,XLR 7,ACCY	078693
801956-3070	CABLE,ICS,XLR 5,ACCY	078696

BARCODE 17 DIGIT FORMAT				
EXAMPLE (FINAL ASSY): P P P P P P Z D D D S S S S S A E				
POSITION	SIZE	TYPE	EXAMPLE	DESCRIPTION
1-6	6	N	PPPPPP	BOSE PRODUCT CODE / MATERIAL ID #
7	1	AN	Z	PLANT CODE (NON BOSE BUILT)
8-11	4	N	<u>DDDD</u>	DATE OF MANUFACTURE (195th DAY OF YEAR 2000, VALUE IS UNDERLINED)
12-15	4	N	SSSS	SEQUENCE NUMBER (5th PRODUCT BUILT ON THIS DATE)
16	1	A	A	NUMBER OF ITEMS IN THE PRODUCT (A=001, RECEIVER) (B=002, TRANSMITTER)
17	1	A	E	UNIT MEASURE (C=CARTON)