

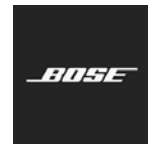

DESIGN ASSURANCE ENGINEERING  
Wireless Transceiver Bluetooth Low Energy Test Report



FCC ID: A94423376 IC: 3232A-423376

Test Type: Emissions  Immunity

Product Type: Wireless Headphones

Product Name/Number: *Model Number: 423376*  
*FCC ID: A94423376*  
*IC: 3232A-423376*

Prepared For: *Design Assurance Engineering Department,*  
*Bose Corporation*

Test Results: Pass  Fail

Applicable Standards: FCC CFR 47 PART 15 SUBPART C  
Industry Canada RSS-247 Issue 2  
Industry Canada RSS-GEN Issue 4

Report Number: *EMC.423376.18.75.1*

General Comments/Special Test Conditions:

This report relates only to the items tested. This report covers EMC marking requirements for *Enter product and any special modifications or test conditions.*

	Print Name	Signature	Date
Prepared By:	Brent DeWitt		March 16, 2018
Electrical Engineer Review* By:	Chad Bell		March 29, 2018

\* Since every test result is separately reviewed after its completion, the electrical engineer review indicated above represents a higher level review to ensure this report lists and contains all applicable and appropriate requirements. If the report carries the "accredited" logo, the reviewer must verify all the tests in this report are covered under the current ISO17025 accreditation. The A2LA-accredited logo must be removed if any of the tests in the report are not performed under the current scope of accreditation. It is the responsibility of the reviewer to ensure the A2LA advertising policy is followed.

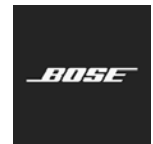

# Table of Contents

## Tests Performed (Table of Contents):

Test Report Summary .....	3
6dB Bandwidth .....	5
99% Bandwidth.....	8
Conducted Output Power .....	11
Power Spectral Density .....	14
Conducted Spurious Emissions .....	17

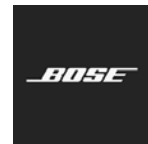

# Test Report Summary

## Product Information:

### Description

*The EUT is a wireless headphone that contains Bluetooth/BLE transceivers, manufactured by Cambridge Silicon Radio, CSR8670. The EUT uses Adaptive Frequency Hopping (AFH) mode, using a reduced hop set if interference is detected in band, however a maximum of 20 channels is always maintained..*

### Setup (Cables and Accessories)

*Radiated emission and power line conducted emission were performed with the EUT playing IEC pink noise over the BT link. EUT is not sold with a power supply so when necessary a Bose model number PSA05F-050QBT1 power supply was used for charging. For radio tests the BT radio was configured with CSR Blue Suite software (details provided in SOFTWARE AND FIRMWARE section).*

### EUT Antenna Description

*The antenna is an internal inverted F antenna with antenna gain of 3.8dBi formed by printed circuit board etch.*

### SOFTWARE AND FIRMWARE

*The firmware installed in the EUT during testing was version 0.1.5  
The test utility software used during testing was Polycomm, version 0.2.1.0 and CSR Blue Suite version 2.6.2.*

### Scope:

*This report covers EMC requirements. FCC CFR 47 PART 15 SUBPART C, Industry Canada RSS-247 Issue 2, and Industry Canada RSS-GEN Issue 4..*

### Test Objective:

*Verify product meets all applicable EMC requirements.*

### Results:

*Product complies with all applicable EMC requirements. All final results represent worst-case emissions and/or immunity.*

### Conclusions:

The device under test (D.U.T.):  
 meets all test standards selected in section 2 of this report.  
 does not meet all test standards selected in section 2 of this report.

### Affirmation of Test Results:

	Print Name	Signature	Date
Testing Engineer/Technician	Brent DeWitt		March 16, 2018

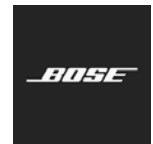

# Test Standards

## Emissions:

- Standard
- FCC Part 15C
- Canada RSS-247
- Canada RSS-GEN
- FCC KDB 558074 D01 DTS measurement guidance v04

# Environmental Conditions

## Ambient:

- Temperature: 22±4°C
- Humidity: 30-60%RH
- Mains Voltage:  120VAC

# MEASUREMENT METHODS

- Duty Cycle: KDB 558074 D01 Section 6.0
- 6 dB BW: KDB 558074 D01, Section 8.1.
- 99% Occupied Bandwidth: ANSI C63.10-2013, Section 6.9.3
- Output Power: KDB 558074 D01 Section 9.1.2
- Power Spectral Density: KDB 558074 D01 Section 10.2.
- Out-of-band emissions in non-restricted bands: KDB 558074 D01 Section 11.0.
- Out-of-band emissions in restricted bands: KDB 558074 D01 Section 12.2.5.2
- General Radiated Emissions: ANSI C63.10:2013 Sections 6.3-6.6
- Line Conducted Emissions: ANSI C63.10:2013 Sections 6.2

# FCC Test Site Accreditation.

Firm Name	Location	Accreditation	MRA Designation Number	Expiration Date	Contact	Contact Title
Bose Corporation	1 New York Avenue, Framingham, MA	American Association for Laboratory Accreditation	N/A US1088	07/31/2018	Carole Park	Quality Manager

# Canadian Test Site Registration.

Radiated emissions below 1GHz were performed in Test Site 3232A-1. Radiated emissions above 1GHz were performed in Test Site 3232A-2.

## Scope of Accreditation for: Bose Corporation

Test Site	OATS 3m	OATS 10m	OATS 30m	Chamber 3m	Chamber 10m	Expiry Date
3232A-2	No	No	No	Yes	No	2020-06-27
3232A-1	No	No	No	Yes	No	2020-04-25

# 6dB Bandwidth Requirement:

FCC 15.247(a)(2); IC RSS-247 5.2 (1)  
The minimum 6 dB bandwidth shall be at least 500 kHz.

## Test Procedure:

The transmitter output is connected to a spectrum analyzer. The RBW is set to 1-5% of the 99% Occupied Bandwidth. The VBW is set to  $\geq$  RBW. The sweep time is coupled.

## Test Results:

DTS Bandwidth Summary Table (BLE)						
Channel	Frequency (MHz)	Mode	DTS BW (kHz)	Limit (kHz)	Margin (kHz)	Result
Low	2402	BLE	696.7	500	-196.7	Pass
Middle	2440	BLE	690.0	500	-190.0	Pass
High	2480	BLE	693.3	500	-193.3	Pass

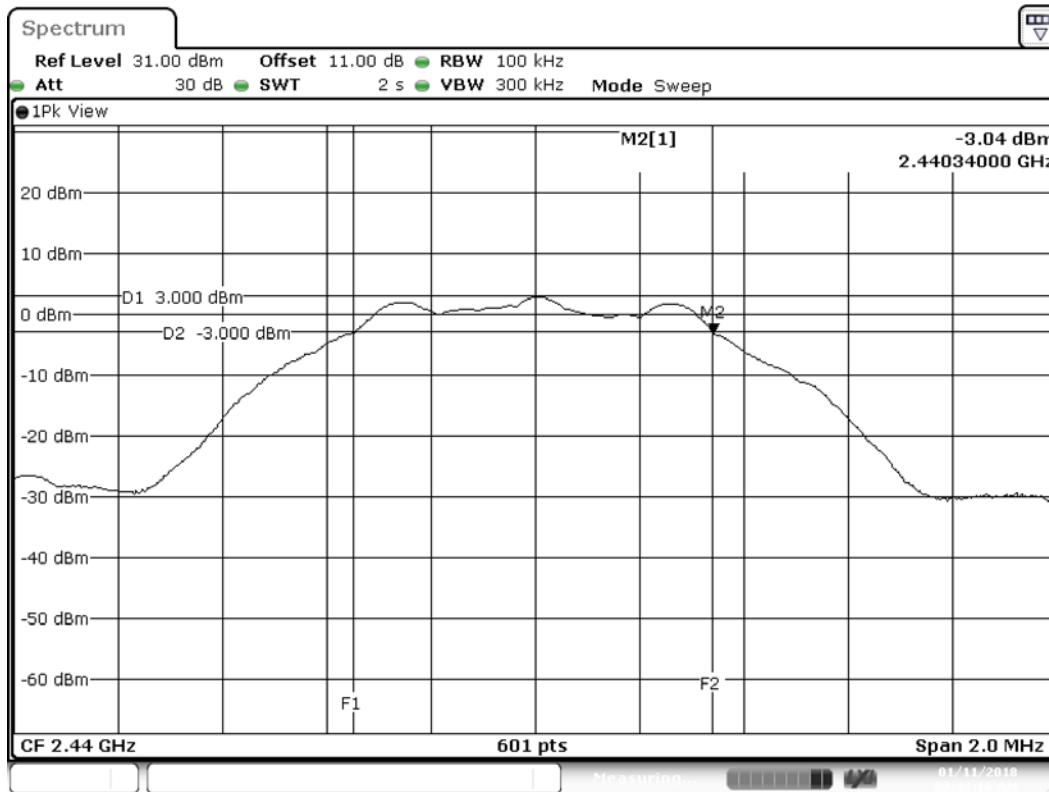

Plot2 DTS BW BLE 2440 MHz

The minimum 6dB bandwidth measured between vertical markers labeled F1 and F2 is 690.0 kHz which is more than the 500kHz minimum required.



Certificate # 1514.1

# DESIGN ASSURANCE ENGINEERING Wireless Transceiver Bluetooth Low Energy Test Report

FCC ID: A94423376 IC: 3232A-423376

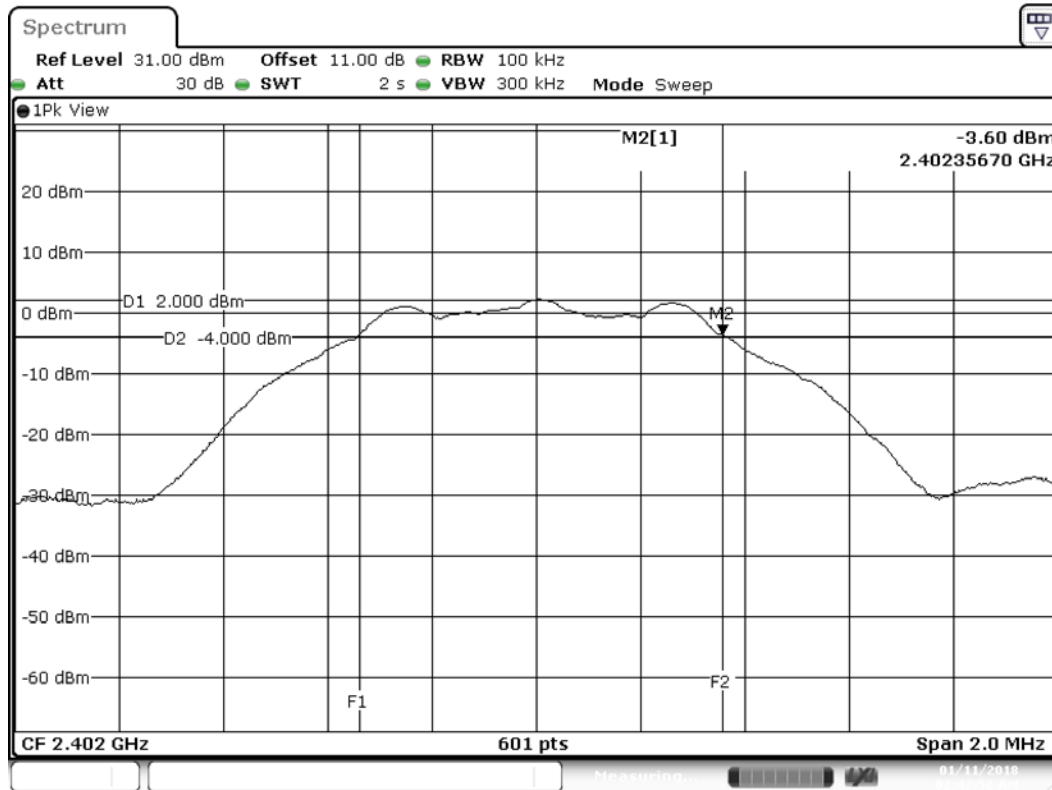

Plot1 DTS BW BLE 2402 MHz

The minimum 6dB bandwidth measured between vertical markers labeled F1 and F2 is 696.7 kHz which is more than the 500kHz minimum required.



Certificate # 1514.1

# DESIGN ASSURANCE ENGINEERING Wireless Transceiver Bluetooth Low Energy Test Report

FCC ID: A94423376 IC: 3232A-423376

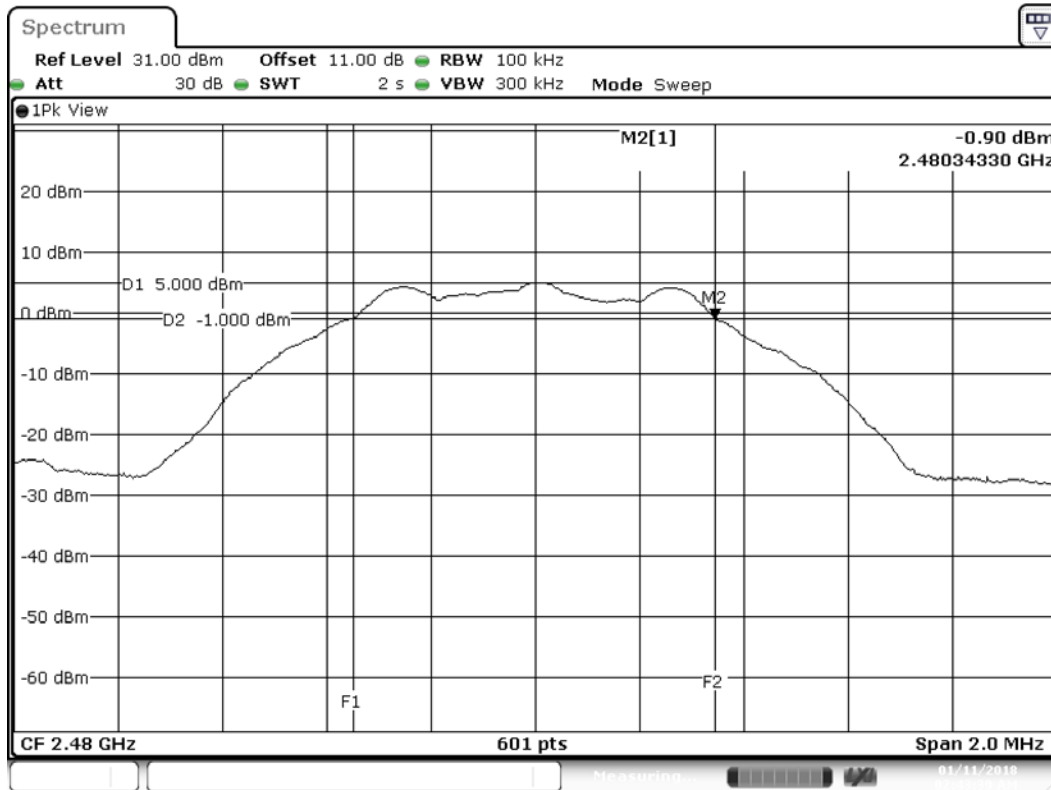

Plot3 DTS BW BLE 2480 MHz

The minimum 6dB bandwidth measured between vertical markers labeled F1 and F2 is 693.3 kHz which is more than the 500kHz minimum required.

# 99% Bandwidth Requirement:

None; for reporting purposes, only. Test per FCC 15.247(a)(1); IC RSS-247 5.1 (1), RSS-Gen 6.6.

## Test Procedure:

The transmitter output is connected to a spectrum analyzer. The RBW is set to 1-5% of the 99% Occupied Bandwidth. The VBW is set to  $\geq$  RBW. The sweep time is coupled.

## Test Results:

99% Bandwidth Summary Table (BLE)			
Channel	Frequency (MHz)	Mode	99% Bandwidth (kHz)
Low	2402	DH5	1023.3
Middle	2440	DH5	1018.3
High	2480	DH5	1018.3

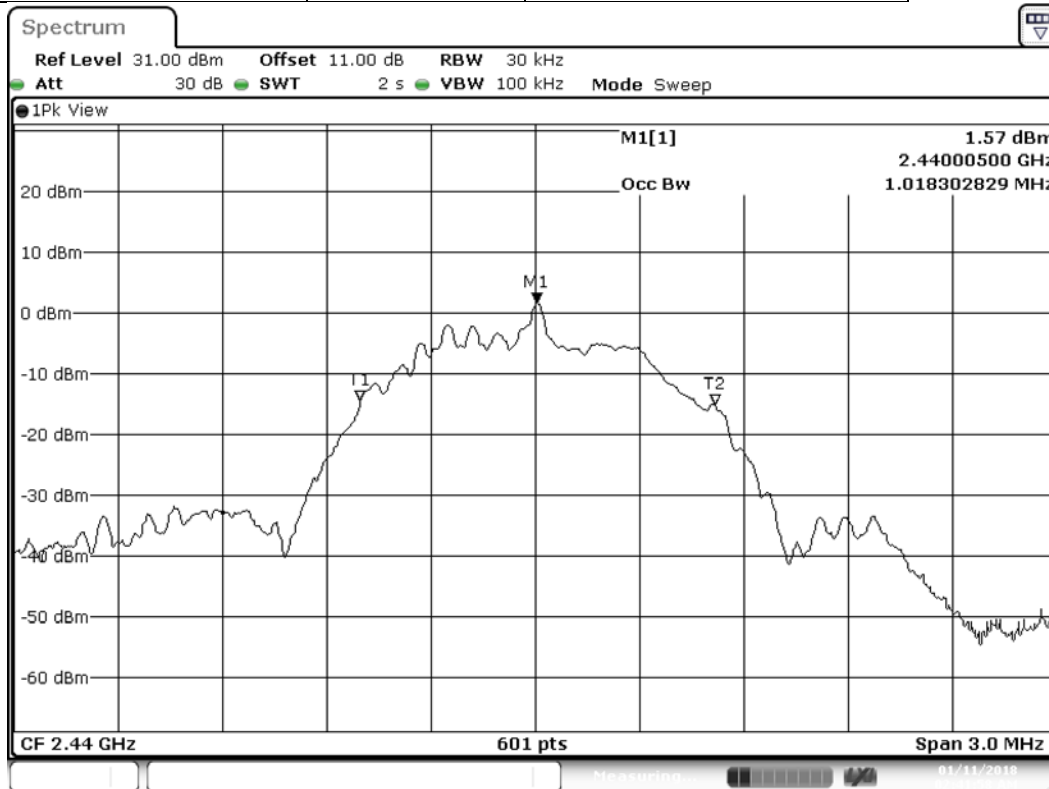

The minimum 99% bandwidth measured between markers labeled T1 and T2 is 1018.3 kHz.





Certificate # 1514.1

# DESIGN ASSURANCE ENGINEERING Wireless Transceiver Bluetooth Low Energy Test Report

FCC ID: A94423376 IC: 3232A-423376

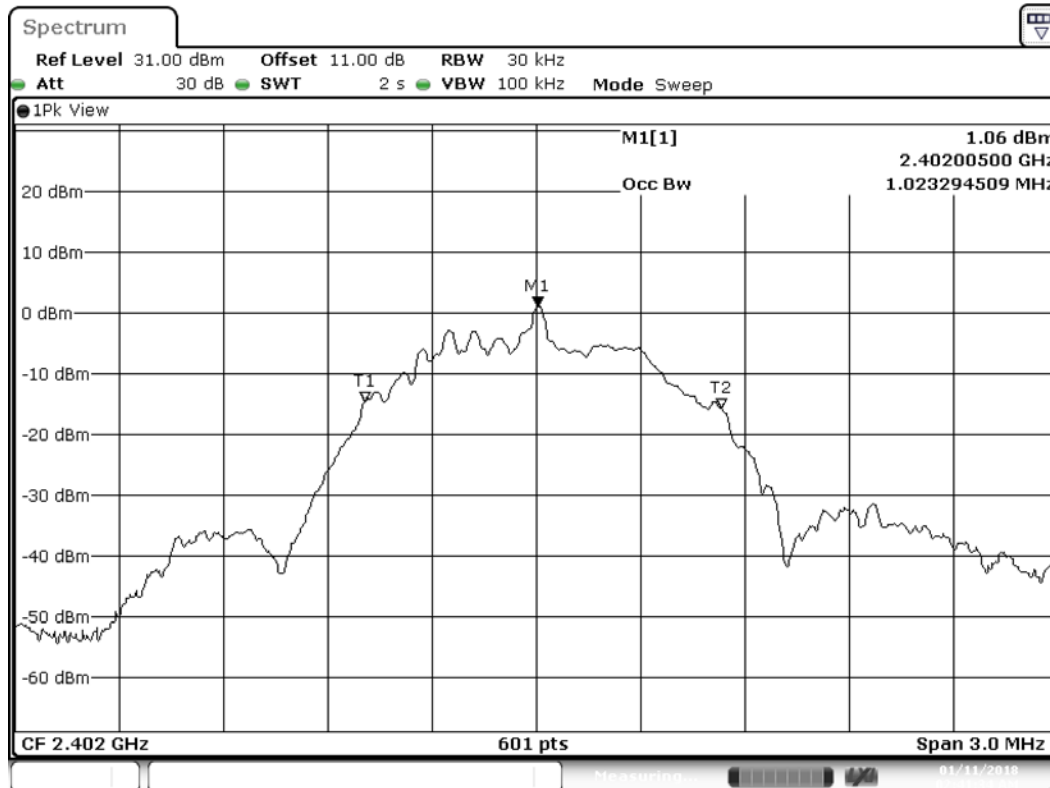

Plot1 99 Percent BW BLE 2402 MHz

The minimum 99% bandwidth measured between markers labeled T1 and T2 is 1023.3 kHz.



Certificate # 1514.1

# DESIGN ASSURANCE ENGINEERING Wireless Transceiver Bluetooth Low Energy Test Report

FCC ID: A94423376 IC: 3232A-423376

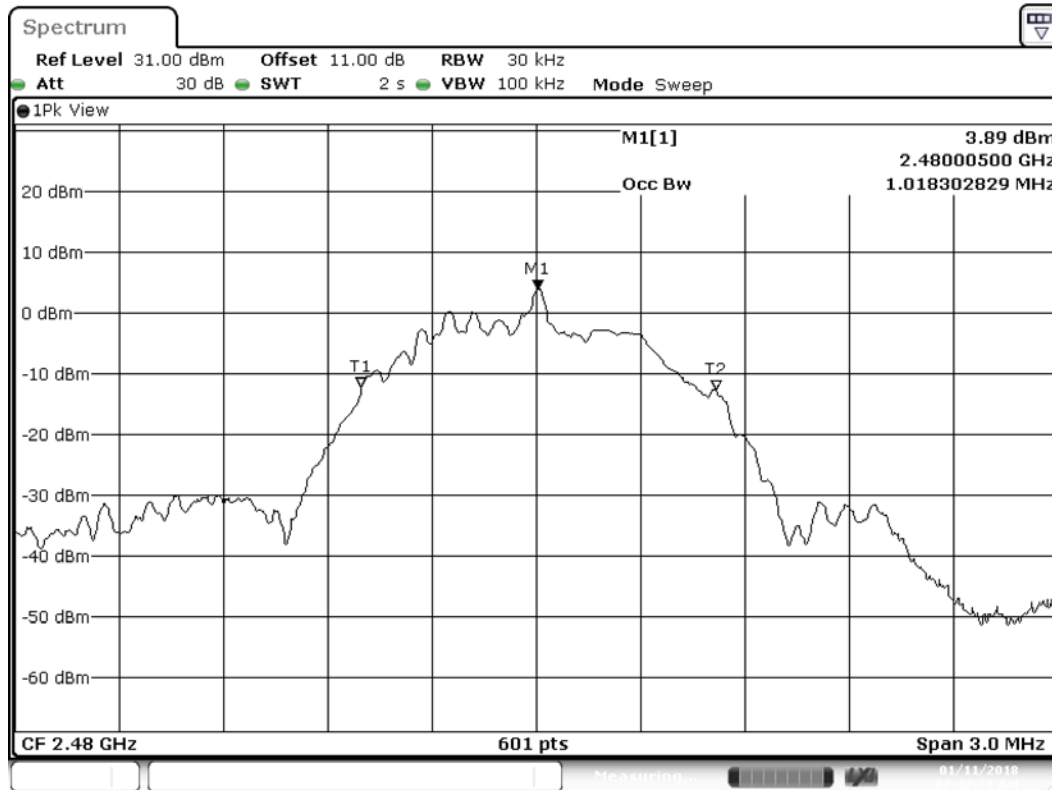

Plot3 99 Percent BW BLE 2480 MHz

The minimum 99% bandwidth measured between markers labeled T1 and T2 is 1018.3 kHz.



# Conducted Output Power

## Requirements:

FCC 15.247 (b) (3)

For systems using digital modulation in the 902-928 MHz, 2400-2483.5 MHz, and 5725-5850 MHz bands: 1 Watt, based on the use of antennas with directional gains that do not exceed 6 dBi. If transmitting antennas of directional gain greater than 6 dBi are used, the conducted output power from the intentional radiator shall be reduced by the amount in dB that the directional gain of the antenna exceeds 6 dBi.

RSS-247 5.4 (4)

For DTSSs employing digital modulation techniques operating in the bands 902-928 MHz and 2400-2483.5 MHz, the maximum peak conducted output power shall not exceed 1W. Except as provided in Section 5.4(5), the e.i.r.p. shall not exceed 4 W.

## Test setup details:

The EUT is controlled via the USB port with CSR's Blue Suite software which is used to set the test modes of the Bluetooth device. The EUT antenna is disconnected. A temporary test connector is mounted to the PCB. An 8 inch u.FL to SMA adapter cable with 1 dB loss and a 10 dB pad were used for all conducted measurements. To compensate for the cable loss and pad attenuation, the reference level offset feature of the spectrum analyzer was used. The EUT is programmed to operate on fixed frequencies at the low, middle, and high end of the authorized frequency band. The spectrum analyzer resolution bandwidth is set to 3 MHz (higher than the occupied bandwidth), peak detector and max hold. The maximum output power is recorded for each of the three frequencies.

## Test Results:

Output Power Summary Table (BLE)						
Channel	Frequency (MHz)	Output Power (dBm)	Directional Gain (dBi)	Limit (dB)	Margin (dB)	Result
Low	2402	2.78	0	30	27.22	Pass
Middle	2440	3.31	0	30	26.69	Pass
High	2480	5.50	0	30	24.50	Pass



Certificate # 1514.1

# DESIGN ASSURANCE ENGINEERING Wireless Transceiver Bluetooth Low Energy Test Report

FCC ID: A94423376 IC: 3232A-423376

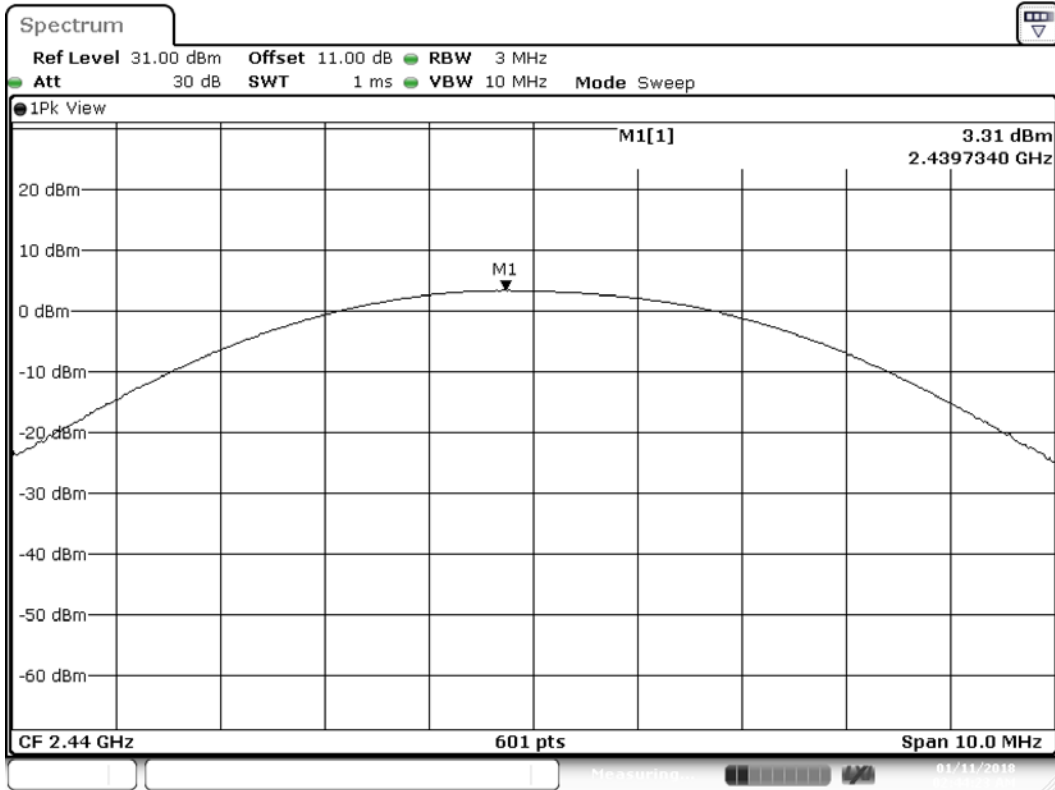

Plot2 BLE Power 2440 MHz

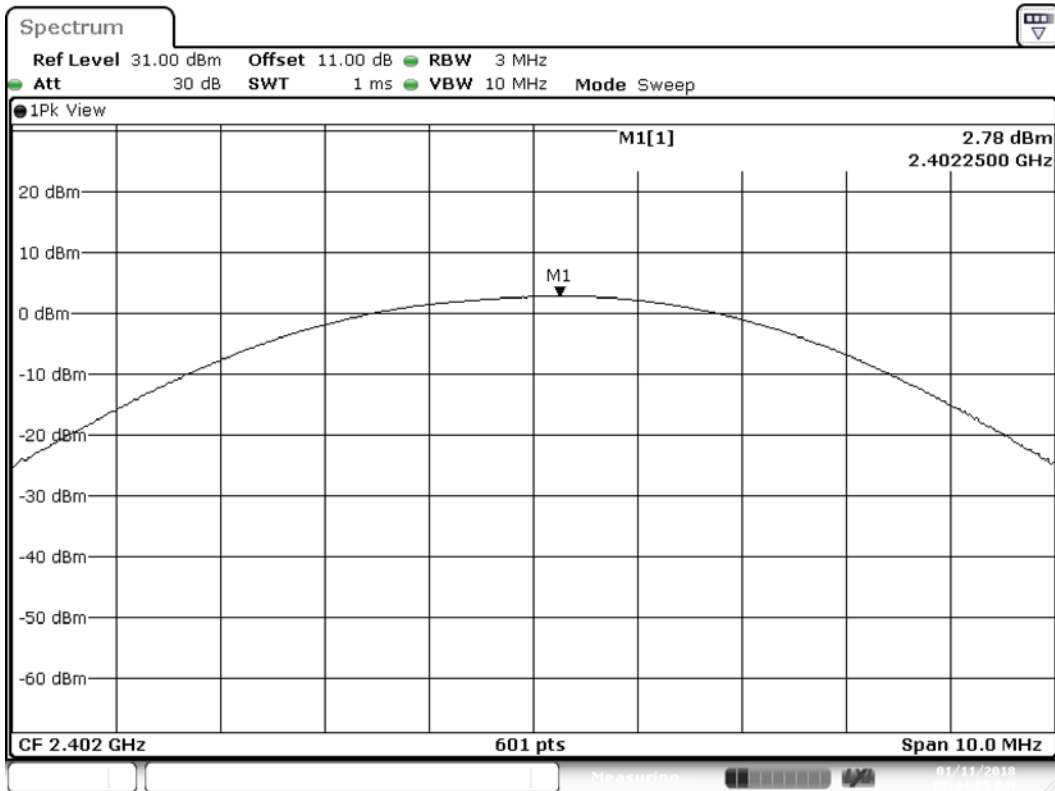

Plot1 BLE Power 2402 MHz



Certificate # 1514.1

# DESIGN ASSURANCE ENGINEERING Wireless Transceiver Bluetooth Low Energy Test Report

FCC ID: A94423376 IC: 3232A-423376

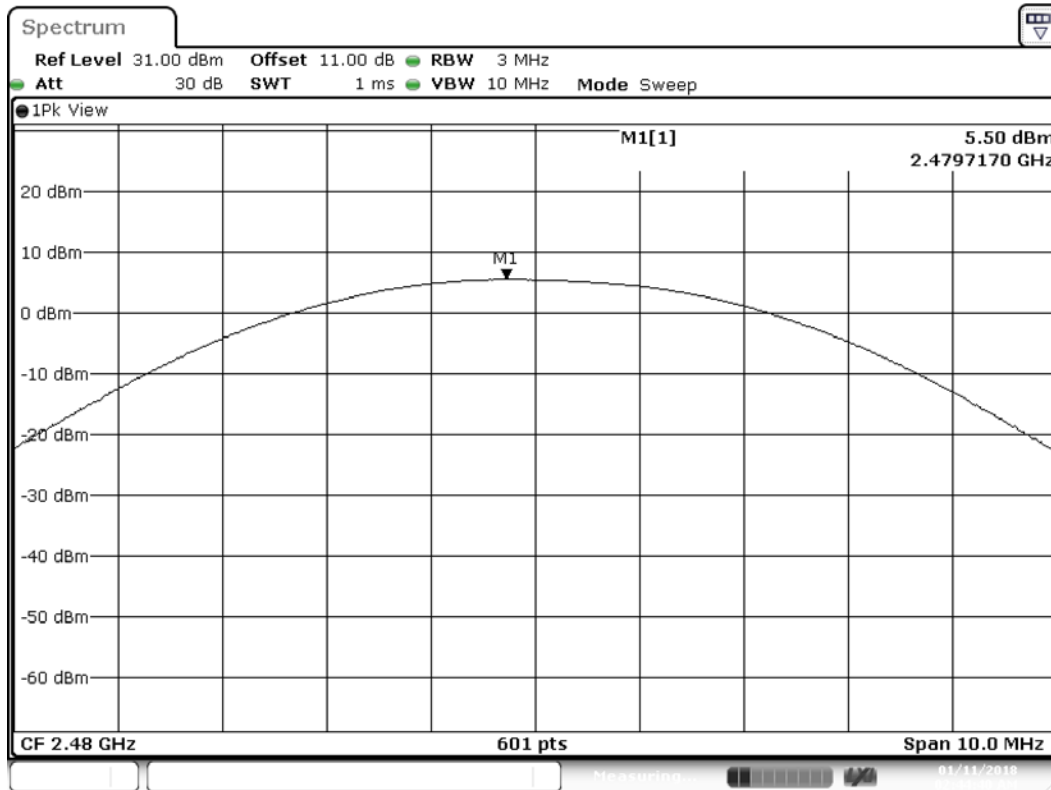

Model 423376 meets the conducted power limit of 1W (30dBm) by 27.2dB at 2402MHz.



# Power Spectral Density Requirements:

## FCC 15.247 (e) and IC RSS-247 5.2 (2)

The power spectral density conducted from the transmitter to the antenna shall not be greater than 8 dBm in any 3 kHz band during any time interval of continuous transmission.

## Test Results:

Power Spectral Density Summary Table (BLE)					
Channel	Frequency (MHz)	PSD (dBm)	Limit (dB)	Margin (dB)	Result
Low	2402	-13.57	8	21.57	Pass
Middle	2440	-12.71	8	20.71	Pass
High	2480	-10.41	8	18.41	Pass



Certificate # 1514.1

# DESIGN ASSURANCE ENGINEERING Wireless Transceiver Bluetooth Low Energy Test Report

FCC ID: A94423376 IC: 3232A-423376

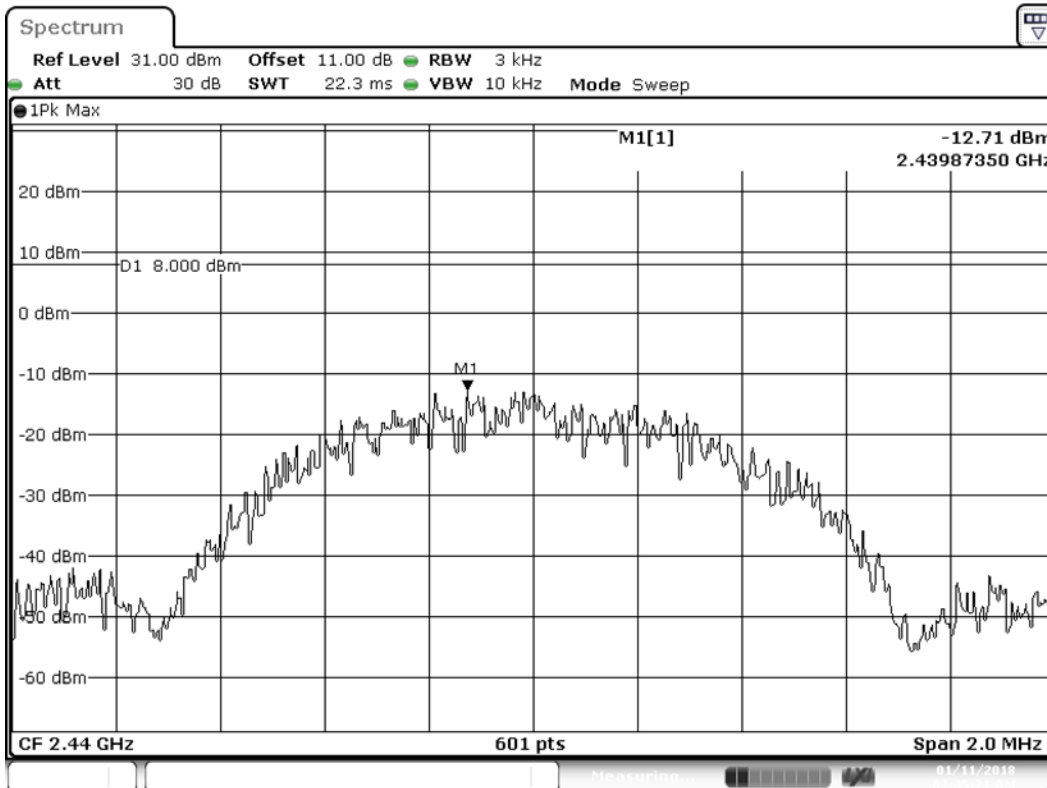

Plot2 BLE PSD 2440 MHz

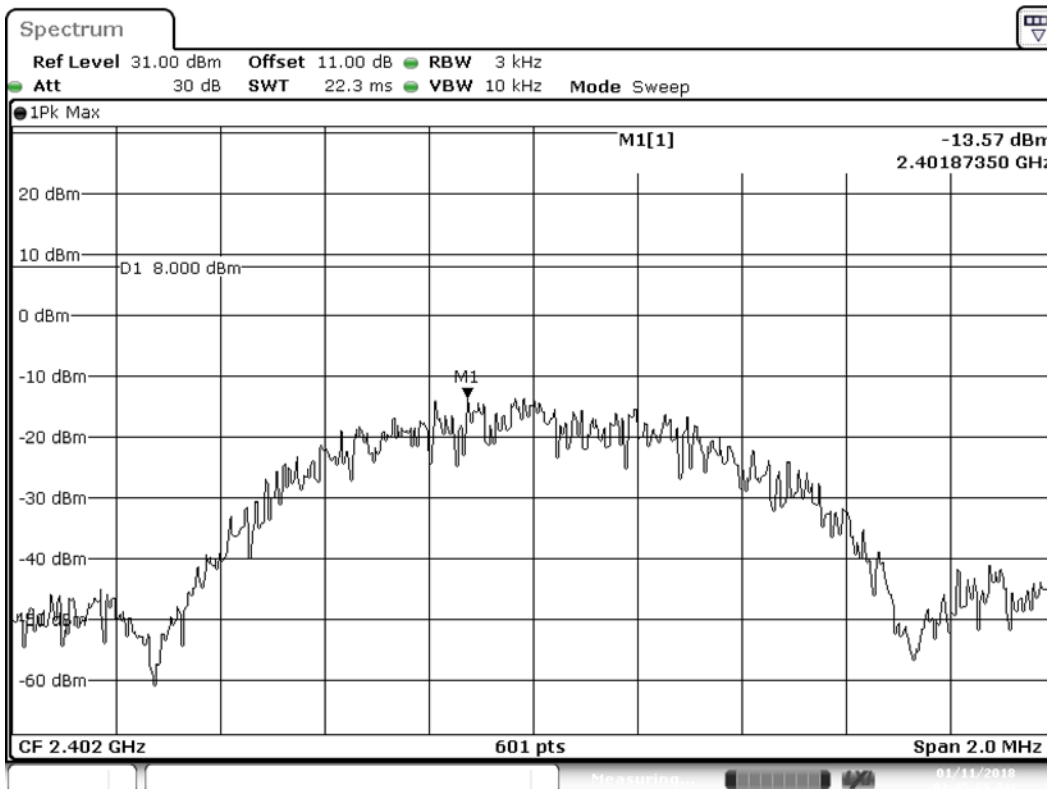

Plot1 BLE PSD 2402 MHz



Certificate # 1514.1

# DESIGN ASSURANCE ENGINEERING Wireless Transceiver Bluetooth Low Energy Test Report

FCC ID: A94423376 IC: 3232A-423376

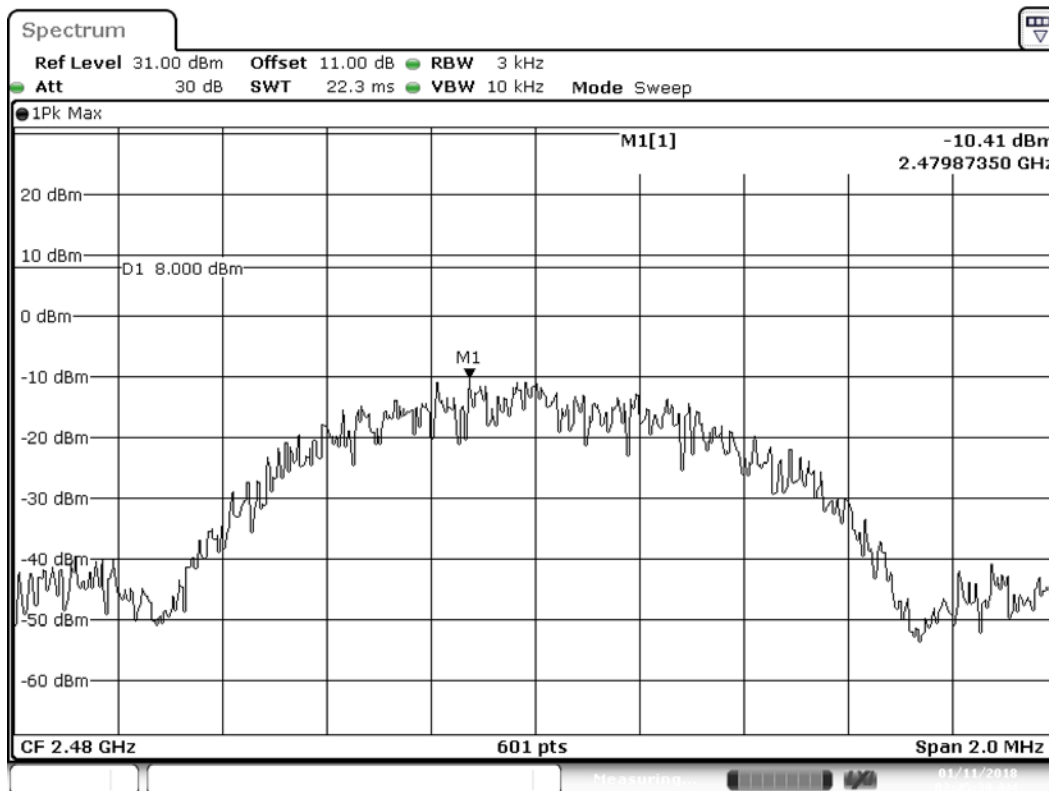

Plot3 BLE PSD 2480 MHz





# Conducted Spurious Emissions Requirements:

## **FCC 15.247 (d)**

In any 100 kHz bandwidth outside the frequency band in which the spread spectrum or digitally modulated intentional radiator is operating, the radio frequency power that is produced by the intentional radiator shall be at least 20 dB below that in the 100 kHz bandwidth within the band that contains the highest level of the desired power, based on either an RF conducted or a radiated measurement, provided the transmitter demonstrates compliance with the peak conducted power limits. If the transmitter complies with the conducted power limits based on the use of RMS averaging over a time interval, as permitted under paragraph (b)(3) of this section, the attenuation required under this paragraph shall be 30 dB instead of 20 dB. Attenuation below the general limits specified in §15.209(a) is not required. In addition, radiated emissions which fall in the restricted bands, as defined in 15.205(a), must also comply with the radiated emission limits specified in 15.209(a) (see 15.205(c)).

## **IC RSS-247 5.5**

In any 100 kHz bandwidth outside the frequency band in which the spread spectrum or digitally modulated device is operating, the RF power that is produced shall be at least 20 dB below that in the 100 kHz bandwidth within the band that contains the highest level of the desired power, based on either an RF conducted or a radiated measurement, provided that the transmitter demonstrates compliance with the peak conducted power limits. If the transmitter complies with the conducted power limits based on the use of root-mean-square averaging over a time interval, as permitted under Section A8.4 (4), the attenuation required shall be 30 dB instead of 20 dB. Attenuation below the general field strength limits specified in RSS-Gen is not required.

Note: Antenna gain outside of the wanted band was assumed to be zero. The conducted spurious readings are for additional information as the radiated readings take precedence.

# Spurious Band-edge Emissions

Upper Band Edge (BLE) (Peak Detector)						
Channel	Frequency (MHz)	Mode	Worst Case (dBc)	Limit (dBc)	Margin (dB)	Result
High	2480	BLE	54.25	20	34.25	Pass

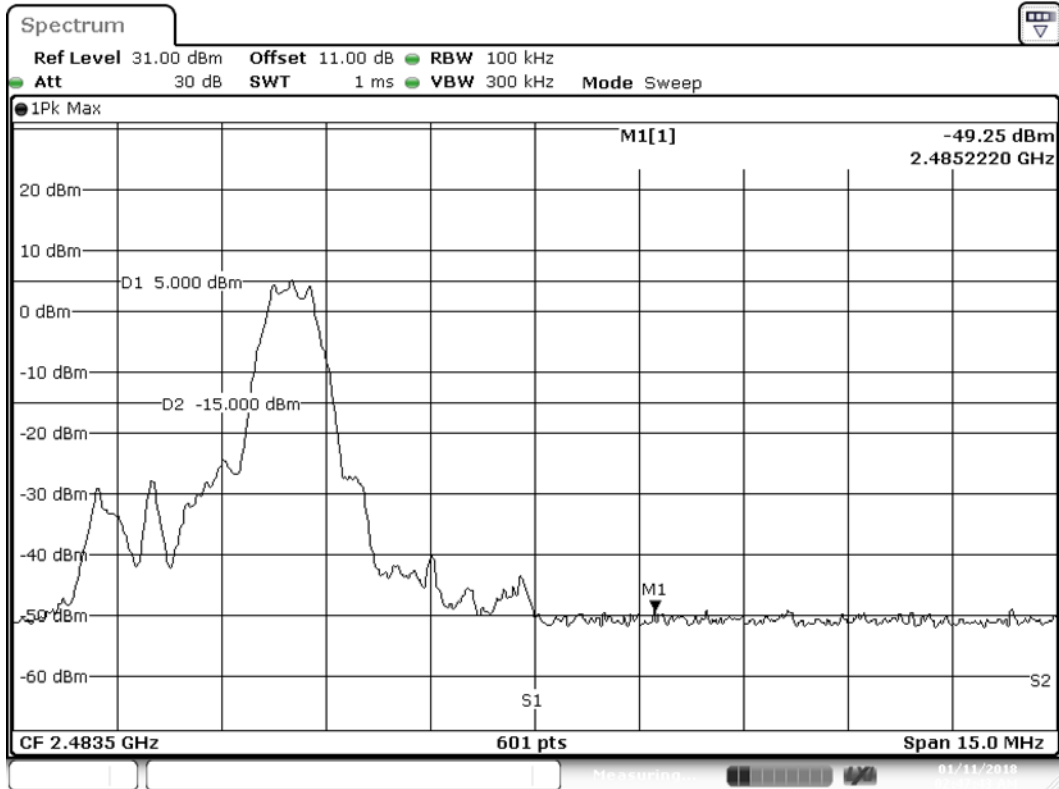

Plot1 Upper Band Edge BLE Peak 2480 MHz

Lower Band Edge (BLE)						
Channel	Frequency (MHz)	Mode	Worst Case (dBc)	Limit (dBc)	Margin (dB)	Result
Low	2402	BLE	47.69	20	27.69	Pass

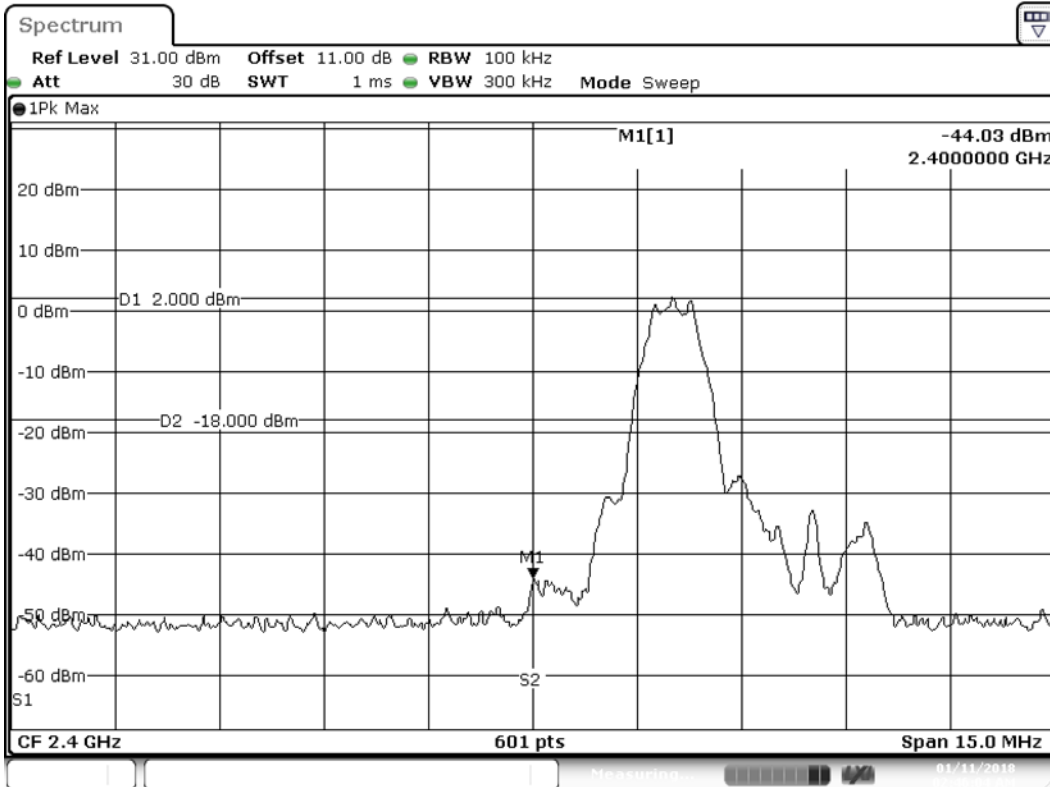

Plot1 Lower Band Edge BLE PK 2402 MHz



Certificate # 1514.1

# DESIGN ASSURANCE ENGINEERING Wireless Transceiver Bluetooth Low Energy Test Report

FCC ID: A94423376 IC: 3232A-423376



## Spurious Emissions

Spurious Summary Table (BLE)											
Channel	Band Range (MHz)	Mode	Raw Measurement (dBm)	Test Cable Loss (dB)	Pad ATTN (dB)	EUT Antenna Gain At Harmonic Frequency (dBi)	Corrected Reading (dBm)	Convert to E-Field at 3 meters (dBuV/m)	Peak Limit (dBuV/m)	Margin (dB)	Result
Low	30 To 1000	BLE	-88.2	1.0	10.0	0.0	-77.2	17.98	74	56.02	Pass
Low	2483.5 To 25000	BLE	-78.5	1.0	10.0	0.0	-67.5	27.76	74	46.24	Pass
Spurious Summary Table (BLE)											
Channel	Band Range (MHz)	Mode	Raw Measurement (dBm)	Test Cable Loss (dB)	Pad ATTN (dB)	EUT Antenna Gain At Harmonic Frequency (dBi)	Corrected Reading (dBm)	Convert to E-Field at 3 meters (dBuV/m)	Peak Limit (dBuV/m)	Margin (dB)	Result
Mid	30 To 1000	BLE	-88.7	1.0	10.0	0.0	-77.7	17.52	74	56.48	Pass
Mid	2483.5 To 25000	BLE	-73.9	1.0	10.0	0.0	-62.9	32.30	74	41.70	Pass
Spurious Summary Table (BLE)											
Channel	Band Range (MHz)	Mode	Raw Measurement (dBm)	Test Cable Loss (dB)	Pad ATTN (dB)	EUT Antenna Gain At Harmonic Frequency (dBi)	Corrected Reading (dBm)	Convert to E-Field at 3 meters (dBuV/m)	Peak Limit (dBuV/m)	Margin (dB)	Result
High	30 To 1000	BLE	-88.5	1.0	10.0	0.0	-77.5	17.71	74	56.29	Pass
High	2483.5 To 25000	BLE	-78.5	1.0	10.0	0.0	-67.5	27.76	74	46.24	Pass



Certificate # 1514.1

# DESIGN ASSURANCE ENGINEERING Wireless Transceiver Bluetooth Low Energy Test Report

FCC ID: A94423376 IC: 3232A-423376

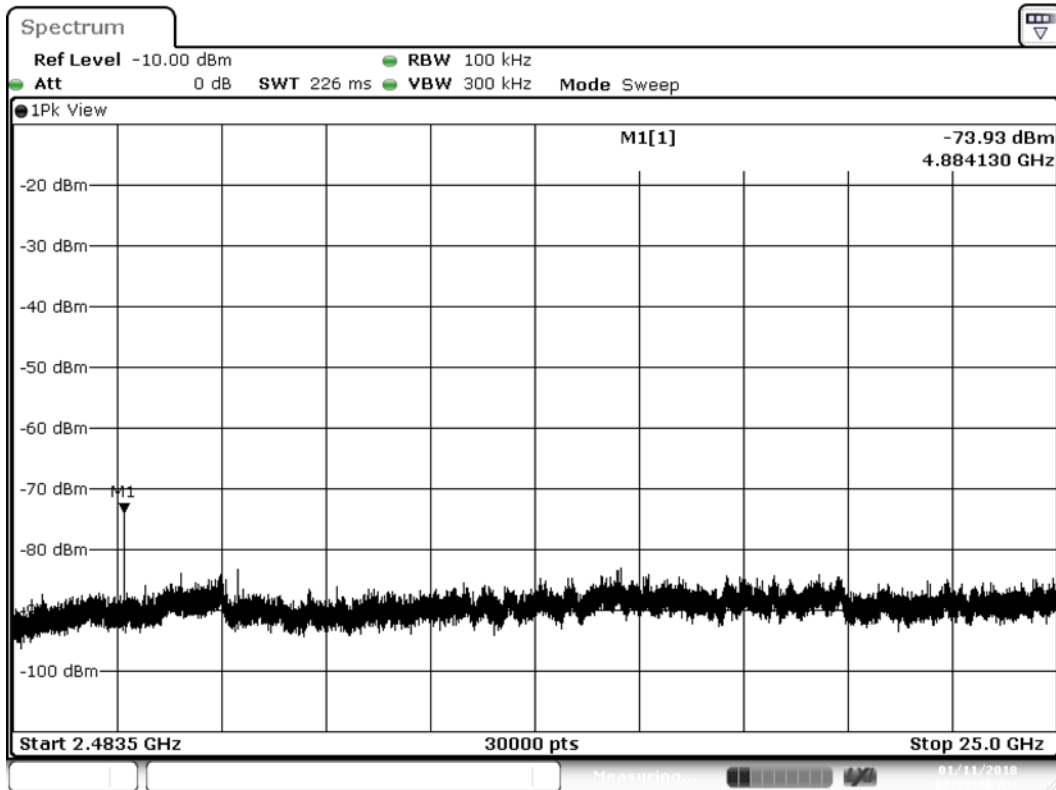
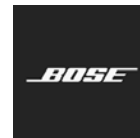

Plot2 BLE 2442 MHz Peak Band 2

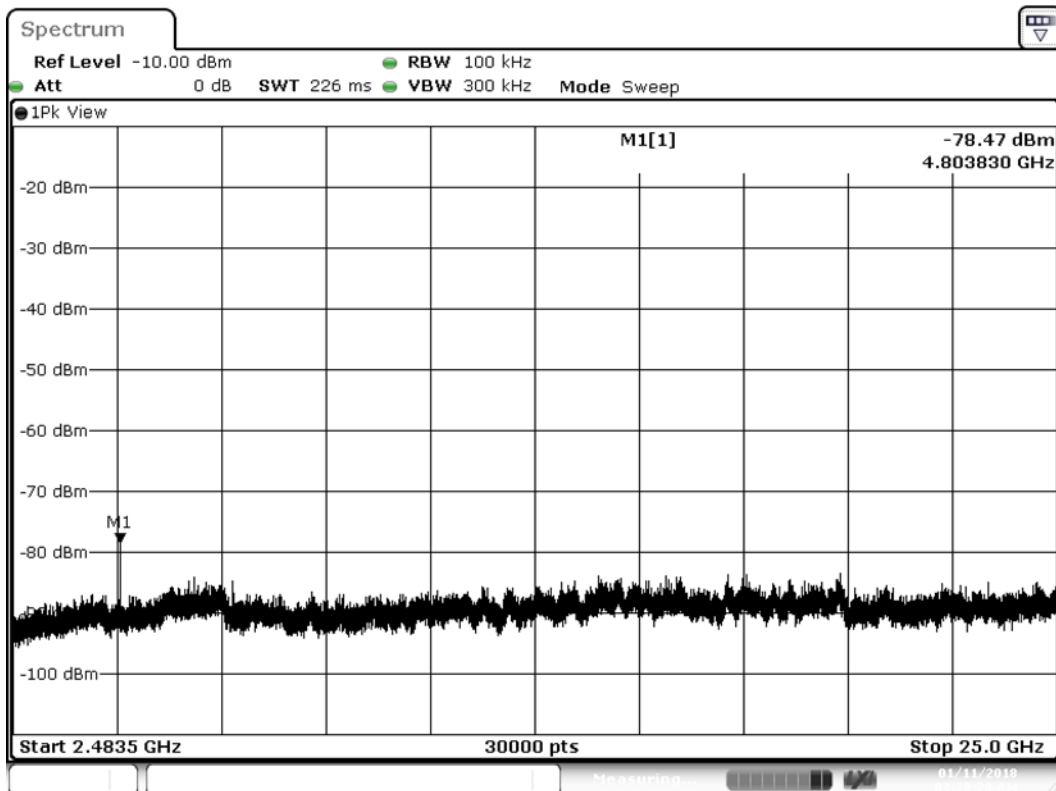

Plot2 BLE 2402 MHz Peak Band 2



Certificate # 1514.1

# DESIGN ASSURANCE ENGINEERING Wireless Transceiver Bluetooth Low Energy Test Report

FCC ID: A94423376 IC: 3232A-423376

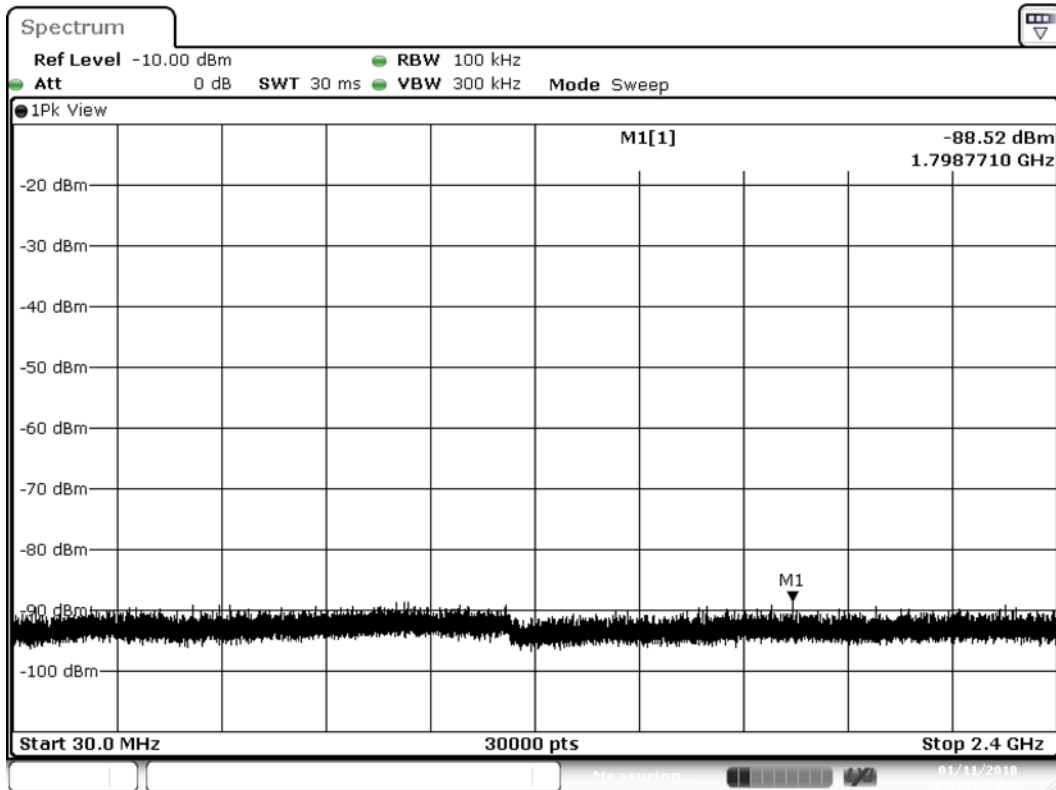

Plot1 BLE 2480 MHz Peak Band 1

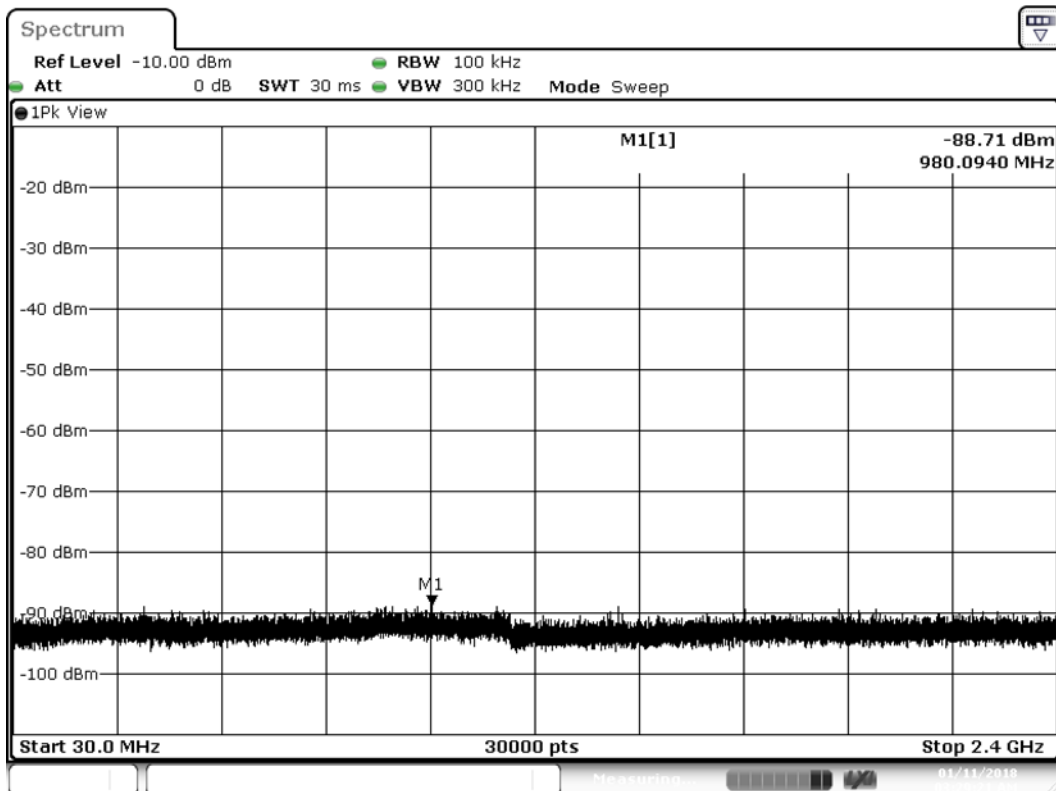

Plot1 BLE 2442 MHz Peak Band 1



Certificate # 1514.1

# DESIGN ASSURANCE ENGINEERING Wireless Transceiver Bluetooth Low Energy Test Report

FCC ID: A94423376 IC: 3232A-423376

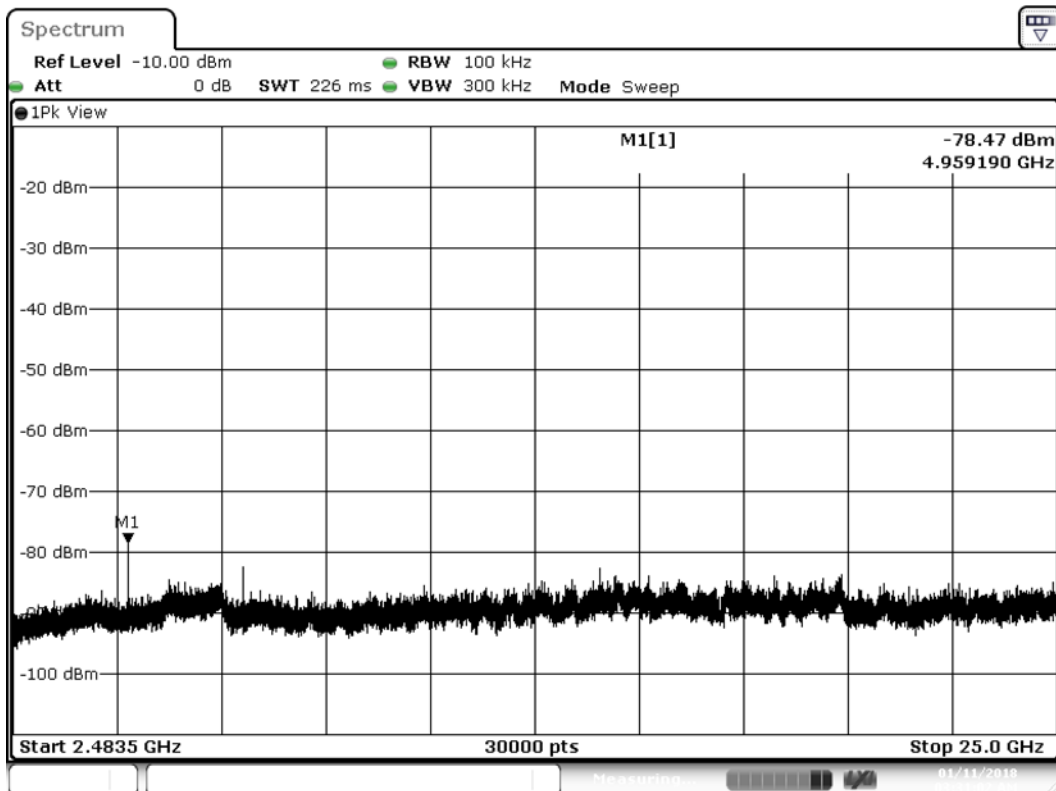
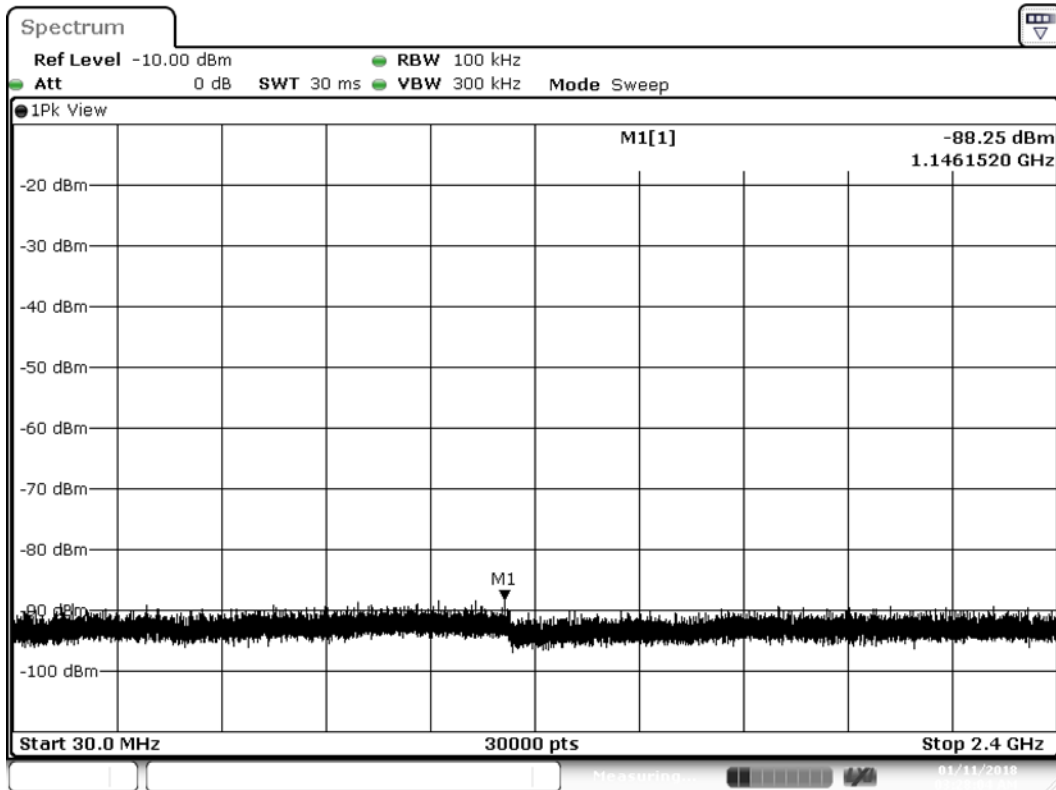



Certificate # 1514.1

# DESIGN ASSURANCE ENGINEERING

## Wireless Transceiver Bluetooth Low Energy Test Report

FCC ID: A94423376 IC: 3232A-423376



Spurious Summary Table (BLE)											
Channel	Band Range (MHz)	Mode	Raw Measurement (dBm)	Test Cable Loss (dB)	Pad ATTN (dB)	EUT Antenna Gain At Harmonic Frequency (dBi)	Corrected Reading (dBm)	Convert to E-Field at 3 meters (dBuV/m)	Average Limit (dBuV/m)	Margin (dB)	Result
Low	30 To 1000	BLE	-94.5	1.0	10.0	0.0	-83.5	11.72	54	42.28	Pass
Low	2483.5 To 25000	BLE	-89.0	1.0	10.0	0.0	-78.0	17.24	54	36.76	Pass

Spurious Summary Table (BLE)											
Channel	Band Range (MHz)	Mode	Raw Measurement (dBm)	Test Cable Loss (dB)	Pad ATTN (dB)	EUT Antenna Gain At Harmonic Frequency (dBi)	Corrected Reading (dBm)	Convert to E-Field at 3 meters (dBuV/m)	Average Limit (dBuV/m)	Margin (dB)	Result
Mid	30 To 1000	BLE	-94.7	1.0	10.0	0.0	-83.7	11.58	54	42.42	Pass
Mid	2483.5 To 25000	BLE	-84.9	1.0	10.0	0.0	-73.9	21.30	54	32.70	Pass

Spurious Summary Table (BLE)											
Channel	Band Range (MHz)	Mode	Raw Measurement (dBm)	Test Cable Loss (dB)	Pad ATTN (dB)	EUT Antenna Gain At Harmonic Frequency (dBi)	Corrected Reading (dBm)	Convert to E-Field at 3 meters (dBuV/m)	Average Limit (dBuV/m)	Margin (dB)	Result
High	30 To 1000	BLE	-94.7	1.0	10.0	0.0	-83.7	11.51	54	42.49	Pass
High	2483.5 To 25000	BLE	-86.1	1.0	10.0	0.0	-75.1	20.14	54	33.86	Pass





Certificate # 1514.1

# DESIGN ASSURANCE ENGINEERING Wireless Transceiver Bluetooth Low Energy Test Report

FCC ID: A94423376 IC: 3232A-423376

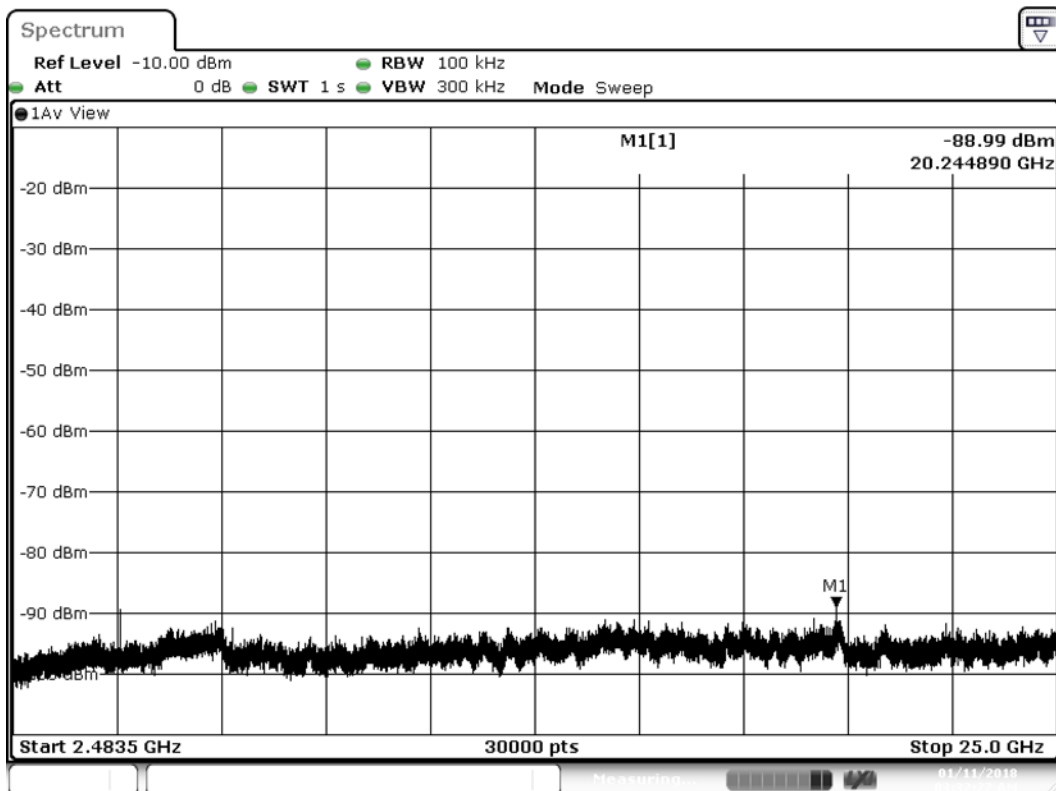
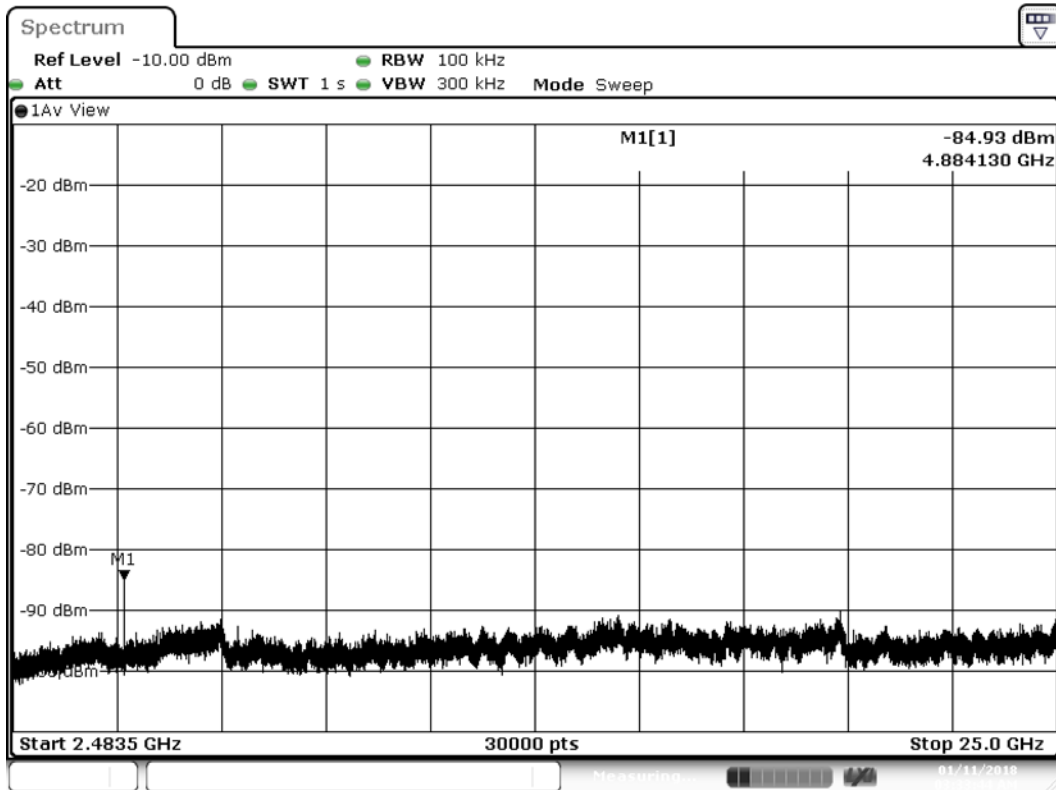
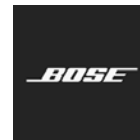



Certificate # 1514.1

# DESIGN ASSURANCE ENGINEERING Wireless Transceiver Bluetooth Low Energy Test Report

FCC ID: A94423376 IC: 3232A-423376

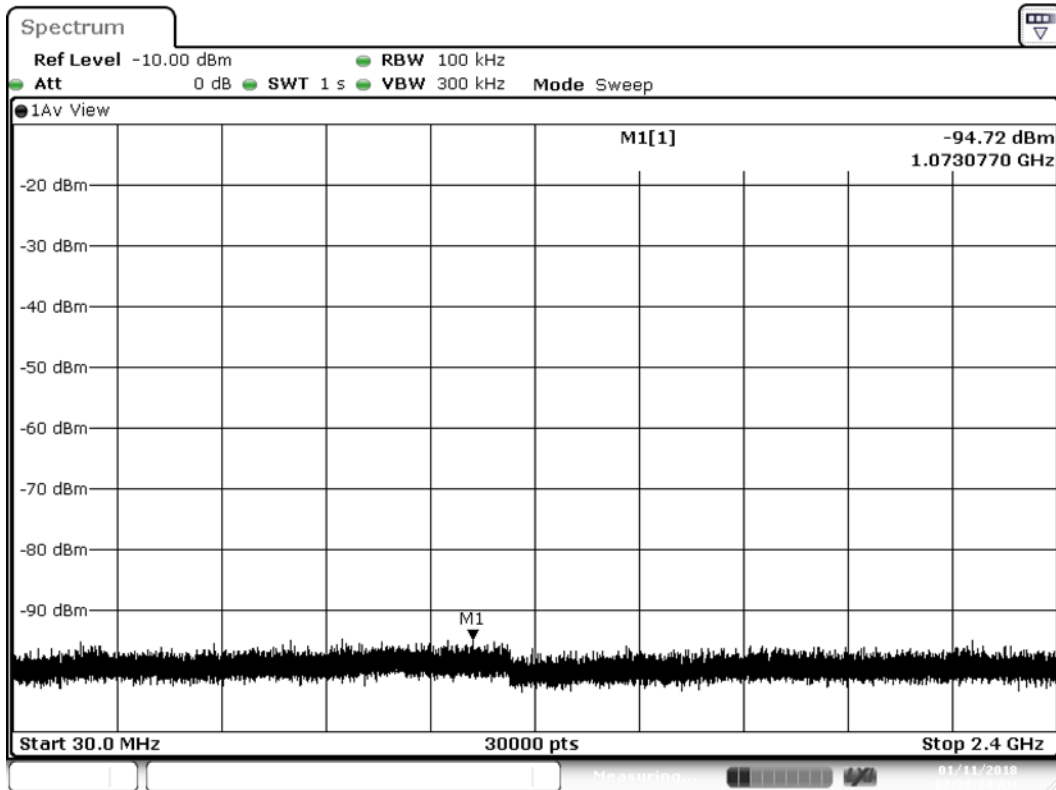
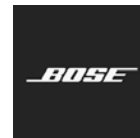

Plot1 BLE 2480 MHz Average Band 1

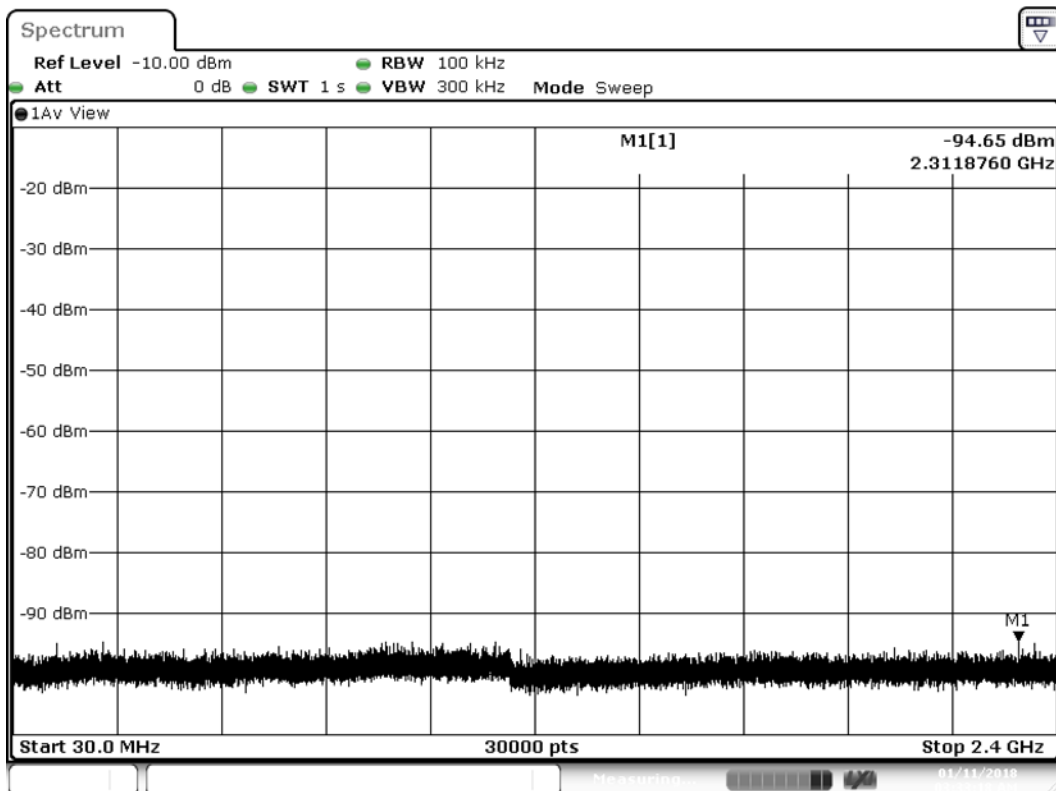

Plot1 BLE 2442 MHz Average Band 1



Certificate # 1514.1

# DESIGN ASSURANCE ENGINEERING Wireless Transceiver Bluetooth Low Energy Test Report

FCC ID: A94423376 IC: 3232A-423376

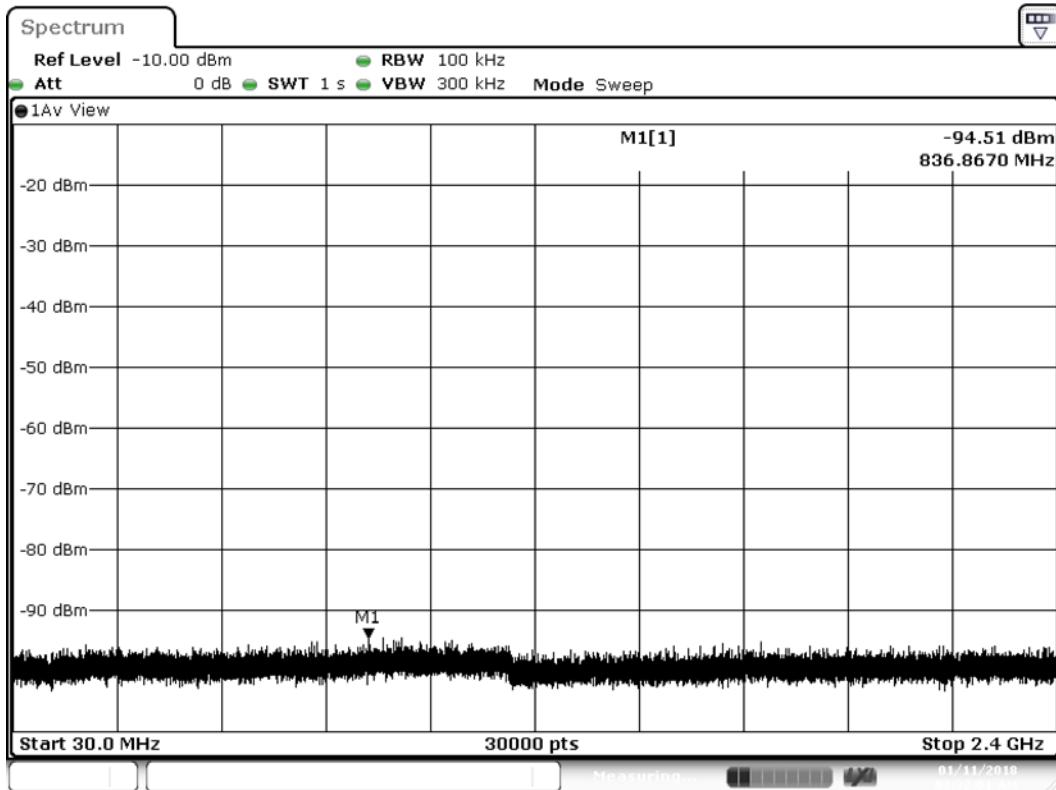
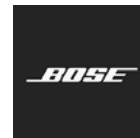

Plot1 BLE 2402 MHz Average Band 1

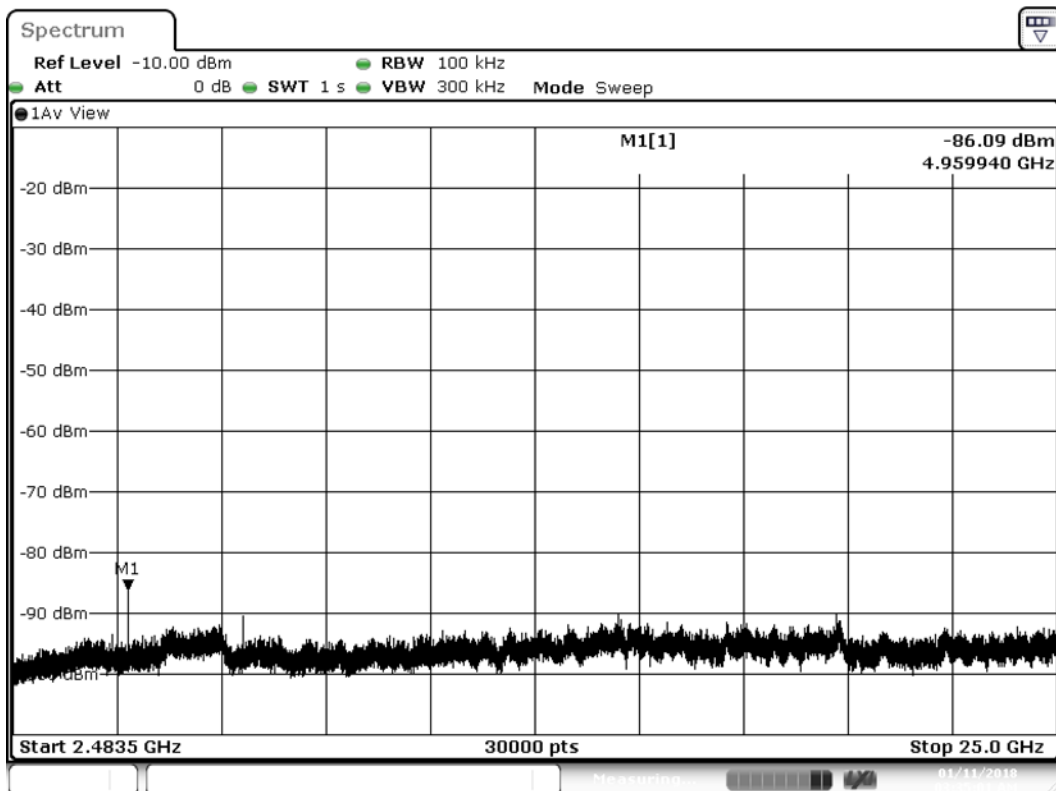

Plot2 BLE 2480 MHz Average Band 2



Certificate # 1514.1

# DESIGN ASSURANCE ENGINEERING Wireless Transceiver Bluetooth Low Energy Test Report

FCC ID: A94423376 IC: 3232A-423376



## Spurious Harmonic Emissions

Spurious Harmonics Summary Table (BLE)													
Channel	Frequency (MHz)	Harmonic	Harmonic Frequency (MHz)	Mode	Raw Measurement (dBm)	Test Cable Loss (dB)	Pad ATTN (dB)	EUT Antenna Gain At Harmonic Frequency (dBi)	Corrected Reading (dBm)	Convert to E-Field at 3 meters (dBuV/m)	Peak Limit (dBuV/m)	Margin (dB)	Result
Low	2402	1	2402	DH5	-69.5	1.0	10.0	0.0	-58.5	36.73	-	-	-
Low	2402	2	<b>4804</b>	DH5	-75.7	1.0	10.0	0.0	-64.7	30.56	74	43.44	Pass
Low	2402	3	7206	DH5	-80.0	1.0	10.0	0.0	-69.0	26.23	74	47.77	Pass
Low	2402	4	9608	DH5	-85.4	1.0	10.0	0.0	-74.4	20.78	74	53.22	Pass
Low	2402	5	<b>12010</b>	DH5	-83.8	1.0	10.0	0.0	-72.8	22.39	74	51.61	Pass
Low	2402	6	14412	DH5	-85.2	1.0	10.0	0.0	-74.2	21.05	74	52.95	Pass
Low	2402	7	16814	DH5	-84.3	1.0	10.0	0.0	-73.3	21.93	74	52.07	Pass
Low	2402	8	<b>19216</b>	DH5	-83.7	1.0	10.0	0.0	-72.7	22.51	74	51.49	Pass
Low	2402	9	21618	DH5	-85.5	1.0	10.0	0.0	-74.5	20.70	74	53.30	Pass
Low	2402	10	24020	DH5	-85.9	1.0	10.0	0.0	-74.9	20.37	74	53.63	Pass

Spurious Harmonics Summary Table (BLE)													
Channel	Frequency (MHz)	Harmonic	Harmonic Frequency (MHz)	Mode	Raw Measurement (dBm)	Test Cable Loss (dB)	Pad ATTN (dB)	EUT Antenna Gain At Harmonic Frequency (dBi)	Corrected Reading (dBm)	Convert to E-Field at 3 meters (dBuV/m)	Peak Limit (dBuV/m)	Margin (dB)	Result
Mid	2440	1	2440	DH5	-66.0	1.0	10.0	0.0	-55.0	40.27	-	-	-
Mid	2440	2	<b>4880</b>	DH5	-73.7	1.0	10.0	0.0	-62.7	32.50	74	41.50	Pass
Mid	2440	3	<b>7320</b>	DH5	-78.6	1.0	10.0	0.0	-67.6	27.62	74	46.38	Pass
Mid	2440	4	9760	DH5	-86.4	1.0	10.0	0.0	-75.4	19.78	74	54.22	Pass
Mid	2440	5	<b>12200</b>	DH5	-81.5	1.0	10.0	0.0	-70.5	24.73	74	49.27	Pass
Mid	2440	6	14640	DH5	-85.3	1.0	10.0	0.0	-74.3	20.90	74	53.10	Pass
Mid	2440	7	17080	DH5	-85.4	1.0	10.0	0.0	-74.4	20.81	74	53.19	Pass
Mid	2440	8	<b>19520</b>	DH5	-84.5	1.0	10.0	0.0	-73.5	21.69	74	52.31	Pass
Mid	2440	9	21960	DH5	-85.9	1.0	10.0	0.0	-74.9	20.29	74	53.71	Pass
Mid	2440	10	24400	DH5	-86.1	1.0	10.0	0.0	-75.1	20.14	74	53.86	Pass

Spurious Harmonics Summary Table (BLE)													
Channel	Frequency (MHz)	Harmonic	Harmonic Frequency (MHz)	Mode	Raw Measurement (dBm)	Test Cable Loss (dB)	Pad ATTN (dB)	EUT Antenna Gain At Harmonic Frequency (dBi)	Corrected Reading (dBm)	Convert to E-Field at 3 meters (dBuV/m)	Peak Limit (dBuV/m)	Margin (dB)	Result
High	2480	1	2480	DH5	-61.5	1.0	10.0	0.0	-50.5	44.77	-	-	-
High	2480	2	<b>4960</b>	DH5	-75.4	1.0	10.0	0.0	-64.4	30.84	74	43.16	Pass
High	2480	3	<b>7440</b>	DH5	-77.8	1.0	10.0	0.0	-66.8	28.41	74	45.59	Pass
High	2480	4	9920	DH5	-86.2	1.0	10.0	0.0	-75.2	20.08	74	53.92	Pass
High	2480	5	<b>12400</b>	DH5	-83.7	1.0	10.0	0.0	-72.7	22.52	74	51.48	Pass
High	2480	6	14880	DH5	-84.7	1.0	10.0	0.0	-73.7	21.58	74	52.42	Pass
High	2480	7	17360	DH5	-85.4	1.0	10.0	0.0	-74.4	20.79	74	53.21	Pass
High	2480	8	<b>19840</b>	DH5	-83.5	1.0	10.0	0.0	-72.5	22.69	74	51.31	Pass
High	2480	9	22320	DH5	-86.2	1.0	10.0	0.0	-75.2	20.05	74	53.95	Pass
High	2480	10	24800	DH5	-85.5	1.0	10.0	0.0	-74.5	20.73	74	53.27	Pass

**BOLDed frequencies are in the restricted bands.**



Certificate # 1514.1

# DESIGN ASSURANCE ENGINEERING Wireless Transceiver Bluetooth Low Energy Test Report

FCC ID: A94423376 IC: 3232A-423376



Spurious Harmonics Summary Table (BLE)													
Channel	Frequency (MHz)	Harmonic	Harmonic Frequency (MHz)	Mode	Raw Measurement (dBm)	Test Cable Loss (dB)	Pad ATTN (dB)	EUT Antenna Gain At Harmonic Frequency (dBi)	Corrected Reading (dBm)	Convert to E-Field at 3 meters (dBuV/m)	Average Limit (dBuV/m)	Margin (dB)	Result
Low	2402	1	2402	DH5	-69.3	1.0	10.0	0.0	-58.3	36.89	-	-	-
Low	2402	2	<b>4804</b>	DH5	-76.7	1.0	10.0	0.0	-65.7	29.55	54	24.45	Pass
Low	2402	3	7206	DH5	-80.5	1.0	10.0	0.0	-69.5	25.77	54	28.23	Pass
Low	2402	4	9608	DH5	-86.8	1.0	10.0	0.0	-75.8	19.39	54	34.61	Pass
Low	2402	5	<b>12010</b>	DH5	-84.9	1.0	10.0	0.0	-73.9	21.29	54	32.71	Pass
Low	2402	6	14412	DH5	-85.8	1.0	10.0	0.0	-74.8	20.38	54	33.62	Pass
Low	2402	7	16814	DH5	-86.0	1.0	10.0	0.0	-75.0	20.24	54	33.76	Pass
Low	2402	8	<b>19216</b>	DH5	-85.6	1.0	10.0	0.0	-74.6	20.66	54	33.34	Pass
Low	2402	9	21618	DH5	-86.5	1.0	10.0	0.0	-75.5	19.69	54	34.31	Pass
Low	2402	10	24020	DH5	-86.6	1.0	10.0	0.0	-75.6	19.62	54	34.38	Pass

Spurious Harmonics Summary Table (BLE)													
Channel	Frequency (MHz)	Harmonic	Harmonic Frequency (MHz)	Mode	Raw Measurement (dBm)	Test Cable Loss (dB)	Pad ATTN (dB)	EUT Antenna Gain At Harmonic Frequency (dBi)	Corrected Reading (dBm)	Convert to E-Field at 3 meters (dBuV/m)	Average Limit (dBuV/m)	Margin (dB)	Result
Mid	2440	1	2440	DH5	-66.0	1.0	10.0	0.0	-55.0	40.18	-	-	-
Mid	2440	2	<b>4880</b>	DH5	-73.7	1.0	10.0	0.0	-62.7	32.58	54	21.42	Pass
Mid	2440	3	<b>7320</b>	DH5	-78.6	1.0	10.0	0.0	-67.6	27.66	54	26.34	Pass
Mid	2440	4	9760	DH5	-88.9	1.0	10.0	0.0	-77.9	17.29	54	36.71	Pass
Mid	2440	5	<b>12200</b>	DH5	-82.2	1.0	10.0	0.0	-71.2	24.03	54	29.97	Pass
Mid	2440	6	14640	DH5	-86.5	1.0	10.0	0.0	-75.5	19.69	54	34.31	Pass
Mid	2440	7	17080	DH5	-86.7	1.0	10.0	0.0	-75.7	19.55	54	34.45	Pass
Mid	2440	8	<b>19520</b>	DH5	-86.8	1.0	10.0	0.0	-75.8	19.44	54	34.56	Pass
Mid	2440	9	21960	DH5	-88.0	1.0	10.0	0.0	-77.0	18.23	54	35.77	Pass
Mid	2440	10	24400	DH5	-87.1	1.0	10.0	0.0	-76.1	19.08	54	34.92	Pass

Spurious Harmonics Summary Table (BLE)													
Channel	Frequency (MHz)	Harmonic	Harmonic Frequency (MHz)	Mode	Raw Measurement (dBm)	Test Cable Loss (dB)	Pad ATTN (dB)	EUT Antenna Gain At Harmonic Frequency (dBi)	Corrected Reading (dBm)	Convert to E-Field at 3 meters (dBuV/m)	Average Limit (dBuV/m)	Margin (dB)	Result
High	2480	1	2480	DH5	-61.5	1.0	10.0	0.0	-50.5	44.71	-	-	-
High	2480	2	<b>4960</b>	DH5	-75.1	1.0	10.0	0.0	-64.1	31.09	54	22.91	Pass
High	2480	3	<b>7440</b>	DH5	-78.0	1.0	10.0	0.0	-67.0	28.27	54	25.73	Pass
High	2480	4	9920	DH5	-87.7	1.0	10.0	0.0	-76.7	18.58	54	35.42	Pass
High	2480	5	<b>12400</b>	DH5	-84.4	1.0	10.0	0.0	-73.4	21.81	54	32.19	Pass
High	2480	6	14880	DH5	-86.6	1.0	10.0	0.0	-75.6	19.62	54	34.38	Pass
High	2480	7	17360	DH5	-85.9	1.0	10.0	0.0	-74.9	20.29	54	33.71	Pass
High	2480	8	<b>19840</b>	DH5	-85.2	1.0	10.0	0.0	-74.2	21.06	54	32.94	Pass
High	2480	9	22320	DH5	-87.2	1.0	10.0	0.0	-76.2	18.99	54	35.01	Pass
High	2480	10	24800	DH5	-87.3	1.0	10.0	0.0	-76.3	18.97	54	35.03	Pass

BOLDed frequencies are in the restricted bands.

## Conducted Measurements Resources Used

TN	Description	Model	S/N	Manufacturer	Most Recent Calibration	Calibration Due Date	Most Recent Verification	Verification Due Date
2409	Spectrum Analyzer	FSV40	101413	Rohde & Schwarz	05-Apr-2017	05-Apr-2018	n/a	n/a
2342	Band Reject Filter	BRM50702-07	001	Micro-Tronics	n/a	n/a	29-Mar-2017	29-Mar-2018



# End of Report