

FCC Test Report

Report No.: RF150407D12

FCC ID: A94418775

Test Model: 418775

Received Date: Apr. 2, 2015

Test Date: Apr. 2 ~ 13, 2015

Issued Date: May 4, 2015

Applicant: BOSE CORPORATION

Address: 100 The Mountain Road Framingham Massachusetts 01701-9168 United States

Issued By: Bureau Veritas Consumer Products Services (H.K.) Ltd., Taoyuan Branch

Lab Address: No. 47-2, 14th Ling, Chia Pau Vil., Lin Kou Dist., New Taipei City, Taiwan (R.O.C.)



This report is for your exclusive use. Any copying or replication of this report to or for any other person or entity, or use of our name or trademark, is permitted only with our prior written permission. This report sets forth our findings solely with respect to the test samples identified herein. The results set forth in this report are not indicative or representative of the quality or characteristics of the lot from which a test sample was taken or any similar or identical product specifically and expressly noted. Our report includes all of the tests requested by you and the results thereof based upon the information that you provided to us. You have 60 days from date of issuance of this report to notify us of any material error or omission caused by our negligence, provided, however, that such notice shall be in writing and shall specifically address the issue you wish to raise. A failure to raise such issue within the prescribed time shall constitute your unqualified acceptance of the completeness of this report, the tests conducted and the correctness of the report contents. Unless specific mention, the uncertainty of measurement has been explicitly taken into account to declare the compliance or non-compliance to the specification. The report must not be used by the client to claim product certification, approval, or endorsement by TAF or any government agencies.

Table of Contents

Release Control Record	4
1 Certificate of Conformity	5
2 Summary of Test Results	6
2.1 Measurement Uncertainty.....	6
2.2 Modification Record.....	6
3 General Information	7
3.1 General Description of EUT.....	7
3.2 Description of Test Modes.....	8
3.2.1 Test Mode Applicability and Tested Channel Detail.....	9
3.3 Description of Support Units.....	10
3.3.1 Configuration of System under Test.....	11
3.4 General Description of Applied Standards.....	12
4 Test Types and Results	13
4.1 Radiated Emission and Bandedge Measurement.....	13
4.1.1 Limits of Radiated Emission and Bandedge Measurement.....	13
4.1.2 Test Instruments.....	14
4.1.3 Test Procedures.....	15
4.1.4 Deviation from Test Standard.....	15
4.1.5 Test Set Up.....	16
4.1.6 EUT Operating Conditions.....	16
4.1.7 Test Results.....	17
4.2 Conducted Emission Measurement.....	24
4.2.1 Limits of Conducted Emission Measurement.....	24
4.2.2 Test Instruments.....	24
4.2.3 Test Procedures.....	25
4.2.4 Deviation From Test Standard.....	25
4.2.5 Test Setup.....	25
4.2.6 EUT Operating Condition.....	25
4.2.7 Test Results.....	26
4.3 Number of Hopping Frequency Used.....	28
4.3.1 Limits of Hopping Frequency Used Measurement.....	28
4.3.2 Test Setup.....	28
4.3.3 Test Instruments.....	28
4.3.4 Test Procedure.....	28
4.3.5 Deviation from Test Standard.....	28
4.3.6 Test Results.....	29
4.4 Dwell Time on Each Channel.....	30
4.4.1 Limits of Dwell Time on Each Channel Measurement.....	30
4.4.2 Test Setup.....	30
4.4.3 Test Instruments.....	30
4.4.4 Test Procedures.....	30
4.4.5 Deviation from Test Standard.....	30
4.4.6 Test Results.....	31
4.5 Channel Bandwidth.....	33
4.5.1 Limits of Channel Bandwidth Measurement.....	33
4.5.2 Test Setup.....	33
4.5.3 Test Instruments.....	33
4.5.4 Test Procedure.....	33
4.5.5 Deviation from Test Standard.....	33
4.5.6 EUT Operating Condition.....	33
4.5.7 Test Results.....	34
4.6 Hopping Channel Separation.....	35

4.6.1	Limits of Hopping Channel Separation Measurement.....	35
4.6.2	Test Setup	35
4.6.3	Test Instruments.....	35
4.6.4	Test Procedure	35
4.6.5	Deviation From Test Standard.....	35
4.6.6	Test Results.....	36
4.7	Maximum Output Power.....	37
4.7.1	Limits of Maximum Output Power Measurement	37
4.7.2	Test Setup	37
4.7.3	Test Instruments.....	37
4.7.4	Test Procedure	37
4.7.5	Deviation fromTest Standard.....	37
4.7.6	EUT Operating Condition.....	37
4.7.7	Test Results.....	38
4.8	Conducted Out of Band Emission Measurement.....	39
4.8.1	Limits Of Conducted Out Of Band Emission Measurement.....	39
4.8.2	Test Instruments.....	39
4.8.3	Test Procedure	39
4.8.4	Deviation From Test Standard.....	39
4.8.5	Eut Operating Condition	39
4.8.6	Test Results.....	39
5	Pictures of Test Arrangements.....	42
	Appendix – Information on the Testing Laboratories.....	43



Release Control Record

Issue No.	Description	Date Issued
RF150407D12	Original release.	May 4, 2015

1 Certificate of Conformity

Product: Wireless Speaker

Brand: BOSE

Test Model: 418775

Sample Status: Engineering sample

Applicant: BOSE CORPORATION

Test Date: Apr. 2 ~ 13, 2015

Standards: 47 CFR FCC Part 15, Subpart C (Section 15.247)
ANSI C63.10:2009

The above equipment has been tested by **Bureau Veritas Consumer Products Services (H.K.) Ltd., Taoyuan Branch**, and found compliance with the requirement of the above standards. The test record, data evaluation & Equipment Under Test (EUT) configurations represented herein are true and accurate accounts of the measurements of the sample's EMC characteristics under the conditions specified in this report.

Prepared by :  , **Date:** May 4, 2015
Jessica Cheng / Senior Specialist

Approved by :  , **Date:** May 4, 2015
Rex Lai / Assistant Manager

2 Summary of Test Results

47 CFR FCC Part 15, Subpart C (SECTION 15.247)			
FCC Clause	Test Item	Result	Remarks
15.207	AC Power Conducted Emission	PASS	Meet the requirement of limit. Minimum passing margin is -10.34dB at 0.35313MHz.
15.247(a)(1)(iii)	Number of Hopping Frequency Used	PASS	Meet the requirement of limit.
15.247(a)(1)(iii)	Dwell Time on Each Channel	PASS	Meet the requirement of limit.
15.247(a)(1)	1. Hopping Channel Separation 2. Spectrum Bandwidth of a Frequency Hopping Sequence Spread Spectrum System	PASS	Meet the requirement of limit.
15.247(b)	Maximum Peak Output Power	PASS	Meet the requirement of limit.
15.205 & 209	Radiated Emissions	PASS	Meet the requirement of limit. Minimum passing margin is -7.2dB at 172.01MHz.
15.247(d)	Band Edge Measurement	PASS	Meet the requirement of limit. Minimum passing margin is -8.1dB at 2400.00MHz.
15.247(d)	Antenna Port Emission	PASS	Meet the requirement of limit.
15.203	Antenna Requirement	PASS	No antenna connector is used.

NOTE: If The Frequency Hopping System operating in 2400-2483.5MHz band and the output power less than 125mW. The hopping channel carrier frequencies separated by a minimum of 25kHz or two-thirds of the 20dB bandwidth of hopping channel whichever is greater.

2.1 Measurement Uncertainty

Where relevant, the following measurement uncertainty levels have been estimated for tests performed on the EUT as specified in CISPR 16-4-2:

Measurement	Frequency	Expanded Uncertainty (k=2) (±)
Conducted Emissions at mains ports	150kHz ~ 30MHz	3.43 dB
Radiated Emissions up to 1 GHz	30MHz ~ 1000MHz	4.00 dB
Radiated Emissions above 1 GHz	Above 1GHz	3.36 dB

2.2 Modification Record

There were no modifications required for compliance.

3 General Information

3.1 General Description of EUT

Product	Wireless Speaker
Brand	BOSE
Test Model	418775
Status of EUT	Engineering sample
Power Supply Rating	20Vdc from adapter
Bluetooth Verision	Bluetooth 4.1 don't support BLE
Modulation Type	GFSK, $\pi/4$ -DQPSK, 8DPSK
Modulation Technology	FHSS
Transfer Rate	1/2/3Mbps
Operating Frequency	2402 ~ 2480MHz
Number of Channel	79
Output Power	2.786mW
Antenna Type	PCB antenna with 6.13dBi gain
Antenna Connector	N/A
Accessory Device	Adapter, Remote Controller
Data Cable Supplied	Non-shielded Optical Fiber w/o core 1.5m

Note:

1. The EUT uses following Adapter.

Brand	BOSE
Model	DT20V-1.8C-DC
Input Power	100-240V, 50-60Hz, 1.2A Max
Output Power	20V, 1.8A
Power Line	Non-shielded AC 2-Pin cable (1.5m) Non-shielded DC cable (1.5m)

2. The above EUT information is declared by manufacturer and for more detailed features description, please refer to the manufacturer's specifications or User's Manual.

3.2 Description of Test Modes

79 channels are provided to this EUT

Channel	Freq. (MHz)	Channel	Freq. (MHz)	Channel	Freq. (MHz)	Channel	Freq. (MHz)
0	2402	20	2422	40	2442	60	2462
1	2403	21	2423	41	2443	61	2463
2	2404	22	2424	42	2444	62	2464
3	2405	23	2425	43	2445	63	2465
4	2406	24	2426	44	2446	64	2466
5	2407	25	2427	45	2447	65	2467
6	2408	26	2428	46	2448	66	2468
7	2409	27	2429	47	2449	67	2469
8	2410	28	2430	48	2450	68	2470
9	2411	29	2431	49	2451	69	2471
10	2412	30	2432	50	2452	70	2472
11	2413	31	2433	51	2453	71	2473
12	2414	32	2434	52	2454	72	2474
13	2415	33	2435	53	2455	73	2475
14	2416	34	2436	54	2456	74	2476
15	2417	35	2437	55	2457	75	2477
16	2418	36	2438	56	2458	76	2478
17	2419	37	2439	57	2459	77	2479
18	2420	38	2440	58	2460	78	2480
19	2421	39	2441	59	2461		

3.2.1 Test Mode Applicability and Tested Channel Detail

EUT CONFIGURE MODE	APPLICABLE TO				DESCRIPTION
	RE ³ 1G	RE<1G	PLC	APCM	
-	√	√	√	√	

Where **RE³1G**: Radiated Emission above 1GHz **RE<1G**: Radiated Emission below 1GHz
PLC: Power Line Conducted Emission **APCM**: Antenna Port Conducted Measurement

Radiated Emission Test (Above 1GHz):

- Pre-Scan has been conducted to determine the worst-case mode from all possible combinations between available modulations, data rates and antenna ports (if EUT with antenna diversity architecture).
- Following channel(s) was (were) selected for the final test as listed below.

EUT CONFIGURE MODE	AVAILABLE CHANNEL	TESTED CHANNEL	MODULATION TECHNOLOGY	MODULATION TYPE	PACKET TYPE
-	0 to 78	0, 39, 78	FHSS	GFSK	DH5
-	0 to 78	0, 39, 78	FHSS	8DPSK	DH5

Radiated Emission Test (Below 1GHz):

- Pre-Scan has been conducted to determine the worst-case mode from all possible combinations between available modulations, data rates and antenna ports (if EUT with antenna diversity architecture).
- Following channel(s) was (were) selected for the final test as listed below.

EUT CONFIGURE MODE	AVAILABLE CHANNEL	TESTED CHANNEL	MODULATION TECHNOLOGY	MODULATION TYPE	PACKET TYPE
-	0 to 78	78	FHSS	GFSK	DH5

Power Line Conducted Emission Test:

- Pre-Scan has been conducted to determine the worst-case mode from all possible combinations between available modulations, data rates and antenna ports (if EUT with antenna diversity architecture).
- Following channel(s) was (were) selected for the final test as listed below.

EUT CONFIGURE MODE	AVAILABLE CHANNEL	TESTED CHANNEL	MODULATION TECHNOLOGY	MODULATION TYPE	PACKET TYPE
-	0 to 78	78	FHSS	GFSK	DH5

Antenna Port Conducted Measurement:

- This item includes all test value of each mode, but only includes spectrum plot of worst value of each mode.
- Pre-Scan has been conducted to determine the worst-case mode from all possible combinations between available modulations, data rates and antenna ports (if EUT with antenna diversity architecture).
- Following channel(s) was (were) selected for the final test as listed below.

EUT CONFIGURE MODE	AVAILABLE CHANNEL	TESTED CHANNEL	MODULATION TECHNOLOGY	MODULATION TYPE	PACKET TYPE
-	0 to 78	0, 39, 78	FHSS	GFSK	DH5
-	0 to 78	0, 39, 78	FHSS	8DPSK	DH5

Test Condition:

APPLICABLE TO	ENVIRONMENTAL CONDITIONS	INPUT POWER	TESTED BY
RE [≥] 1G	26deg. C, 70%RH	120Vac, 60Hz	Dalen Dai
RE<1G	26deg. C, 70%RH	120Vac, 60Hz	Dalen Dai
PLC	19deg. C, 78%RH	120Vac, 60Hz	John Liao
APCM	25deg. C, 60%RH	120Vac, 60Hz	Saxon Lee

3.3 Description of Support Units

The EUT has been tested as an independent unit together with other necessary accessories or support units. The following support units or accessories were used to form a representative test configuration during the tests.

No.	Product	Brand	Model No.	Serial No.	FCC ID	Remark
A.	EUT	BOSE	418775	-	-	-
B.	IPhone 5	BOSE	N/A	N/A	N/A	Supplied by client
C.	DVD PLAYER	SONY	BDP-S470	3205076	VERIFICATION	Provided by Lab
D.	DVD PLAYER	SONY	BDP-S470	3205078	VERIFICATION	Provided by Lab
E.	AC ADAPTER	N/A	DT20V-1.8C-DC	N/A	N/A	Supplied by client
F.	IPHONE 5C	APPLE	ME493LLA	F78LFYTVFFHG	N/A	Supplied by client
G.	REMOTE CONTROLLER	N/A	N/A	N/A	N/A	Supplied by client

Note:

1. All power cords of the above support units are non-shielded (1.8m).
2. Item F acted as communication partners to transfer data.

No.	Cable	Qty.	Length (m)	Shielded(Yes/ No)	Cores (Number)	Remark
1.	Audio to Audio (R/L) cable	1	1.8	N	0	Supplied by client
2.	Coaxial cable	1	1.8	N	0	Supplied by client
3.	Optical Fiber	1	1.5	N	0	Supplied by client
4.	DC cable	1	1.5	N	0	Supplied by client
5.	AC power cable	1	1.5	N	0	Supplied by client

Note: 1. The core(s) is(are) originally attached to the cable(s).

3.3.1 Configuration of System under Test

Radiated Emission Test (Above 1GHz)

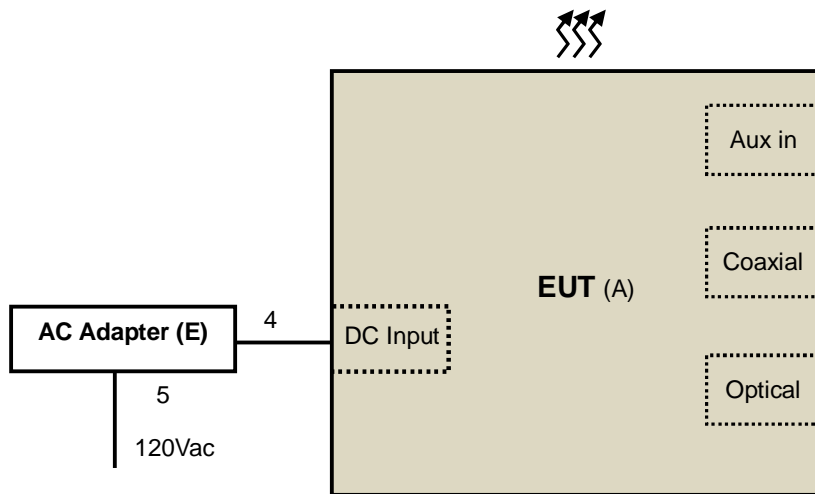

Radiated Emission Test (Below 1GHz) & Conducted Emission Test

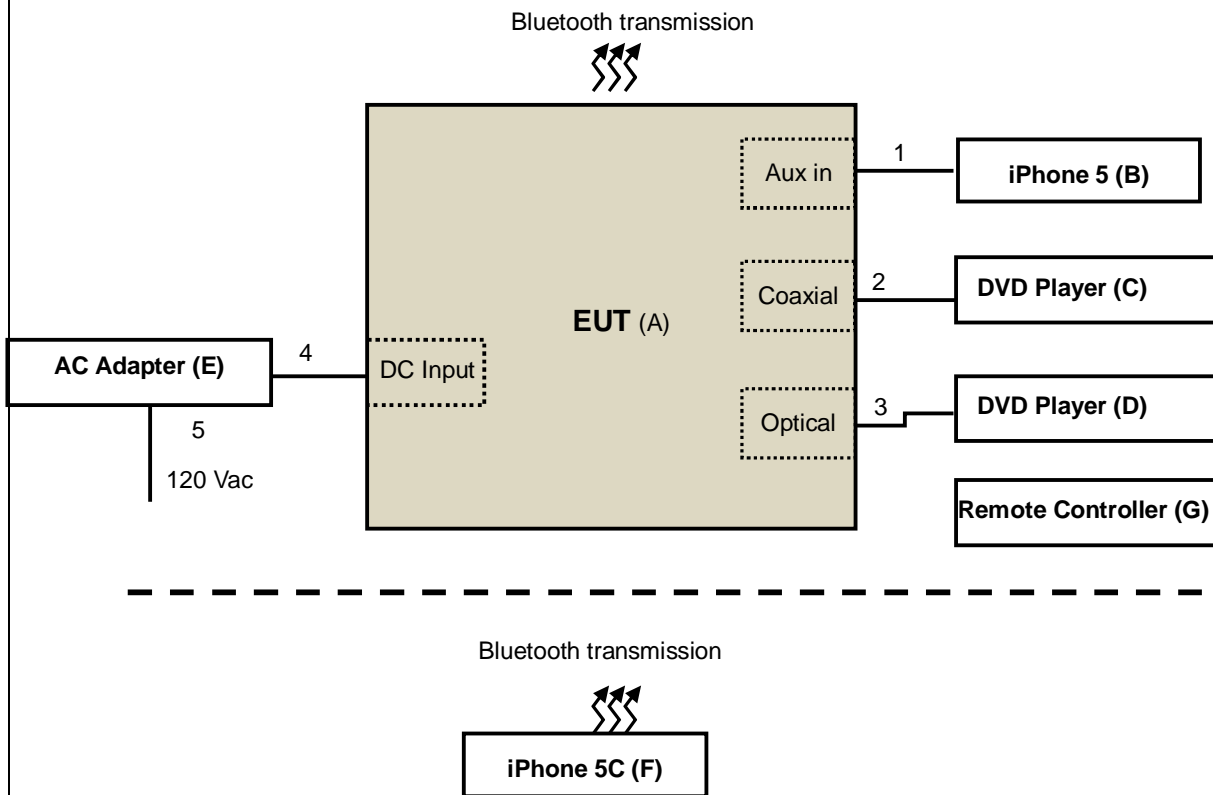

3.4 General Description of Applied Standards

The EUT is a RF Product. According to the specifications of the manufacturer, it must comply with the requirements of the following standards:

FCC Part 15, Subpart C (15.247)

FCC Public Notice DA 00-705

ANSI C63.10-2009

All test items have been performed and recorded as per the above standards.

4 Test Types and Results

4.1 Radiated Emission and Bandedge Measurement

4.1.1 Limits of Radiated Emission and Bandedge Measurement

Radiated emissions which fall in the restricted bands must comply with the radiated emission limits specified as below table. Other emissions shall be at least 20dB below the highest level of the desired power:

Frequencies (MHz)	Field Strength (microvolts/meter)	Measurement Distance (meters)
0.009 ~ 0.490	2400/F(kHz)	300
0.490 ~ 1.705	24000/F(kHz)	30
1.705 ~ 30.0	30	30
30 ~ 88	100	3
88 ~ 216	150	3
216 ~ 960	200	3
Above 960	500	3

NOTE:

1. The lower limit shall apply at the transition frequencies.
2. Emission level (dBuV/m) = 20 log Emission level (uV/m).
3. For frequencies above 1000MHz, the field strength limits are based on average detector, however, the peak field strength of any emission shall not exceed the maximum permitted average limits, specified above by more than 20dB under any condition of modulation.

4.1.2 Test Instruments

DESCRIPTION & MANUFACTURER	MODEL NO.	SERIAL NO.	CALIBRATED DATE	CALIBRATED UNTIL
HP Preamplifier	8447D	2432A03504	Feb. 26, 2015	Feb. 25, 2016
HP Preamplifier	8449B	3008A01201	Feb. 26, 2015	Feb. 25, 2016
MITEQ Preamplifier	AMF-6F-260400-33-8P	892164	Mar. 01, 2015	Feb. 28, 2016
Agilent Spectrum	E4446A	MY51100050	Oct. 24, 2014	Oct. 23, 2015
Agilent TEST RECEIVER	N9038A	MY51210129	Jan. 20, 2015	Jan. 19, 2016
Schwarzbeck Antenna	VULB 9168	139	Feb. 04, 2015	Feb. 03, 2016
Schwarzbeck Antenna	VHBA 9123	480	May 29, 2013	May 28, 2015
Schwarzbeck Horn Antenna	BBHA-9170	212	Feb. 09, 2015	Feb. 08, 2016
Schwarzbeck Horn Antenna	BBHA 9120-D1	D130	Feb. 10, 2015	Feb. 09, 2016
ADT. Turn Table	TT100	0306	NA	NA
ADT. Tower	AT100	0306	NA	NA
Software	ADT_Radiated_V 7.6.15.9.4	NA	NA	NA
SUHNER RF cable	SF104	CABLE-CH6	Aug. 15, 2014	Aug. 14, 2015
SUHNER RF cable	SF102	Cable-CH8-3.6 m	Aug. 15, 2014	Aug. 14, 2015
EMCO Horn Antenna	3115	00028257	Feb. 05, 2015	Feb. 04, 2016
Highpass filter Wainwright Instruments	WHK 3.1/18G-10SS	SN 8	NA	NA
ROHDE & SCHWARZ Spectrum Analyzer	FSV40	101042	Sep. 29, 2014	Sep. 28, 2015
Anritsu Power Sensor	MA2411B	0738404	Apr. 21, 2014	Apr. 20, 2015
Anritsu Power Meter	ML2495A	0842014	Apr. 21, 2014	Apr. 20, 2015

- NOTE:**
1. The calibration interval of the above test instruments is 12/24 months. And the calibrations are traceable to NML/ROC and NIST/USA.
 2. The horn antenna and HP preamplifier (model: 8449B) are used only for the measurement of emission frequency above 1GHz if tested.
 3. The test was performed in Chamber No. 6.
 4. The Industry Canada Reference No. IC 7450E-6.
 5. The FCC Site Registration No. is 447212.

4.1.3 Test Procedures

- a. The EUT was placed on the top of a rotating table 0.8 meters above the ground at 3 meter chamber room for test. The table was rotated 360 degrees to determine the position of the highest radiation.
- b. The EUT was set 3 meters away from the interference-receiving antenna, which was mounted on the top of a variable-height antenna tower.
- c. The height of antenna is varied from one meter to four meters above the ground to determine the maximum value of the field strength. Both horizontal and vertical polarizations of the antenna are set to make the measurement.
- d. For each suspected emission, the EUT was arranged to its worst case and then the antenna was tuned to heights from 1 meter to 4 meters and the rotatable table was turned from 0 degrees to 360 degrees to find the maximum reading.
- e. The test-receiver system was set to quasi-peak detect function and specified bandwidth with maximum hold mode when the test frequency is below 1 GHz.
- f. The test-receiver system was set to peak detect function and specified bandwidth with maximum hold mode when the test frequency is above 1 GHz.

Note:

1. For emission measurements above 1 GHz, the EUT shall be placed at a height of 1.5 m above the ground at 3 meter chamber room for test
2. The resolution bandwidth and video bandwidth of test receiver/spectrum analyzer is 120kHz for Quasi-peak detection (QP) at frequency below 1GHz.
3. The resolution bandwidth of test receiver/spectrum analyzer is 1 MHz and the video bandwidth is 3 MHz for Peak detection (PK) at frequency above 1GHz.
4. All modes of operation were investigated and the worst-case emissions are reported.

4.1.4 Deviation from Test Standard

No deviation.

4.1.5 Test Set Up

<Frequency Range below 1GHz>

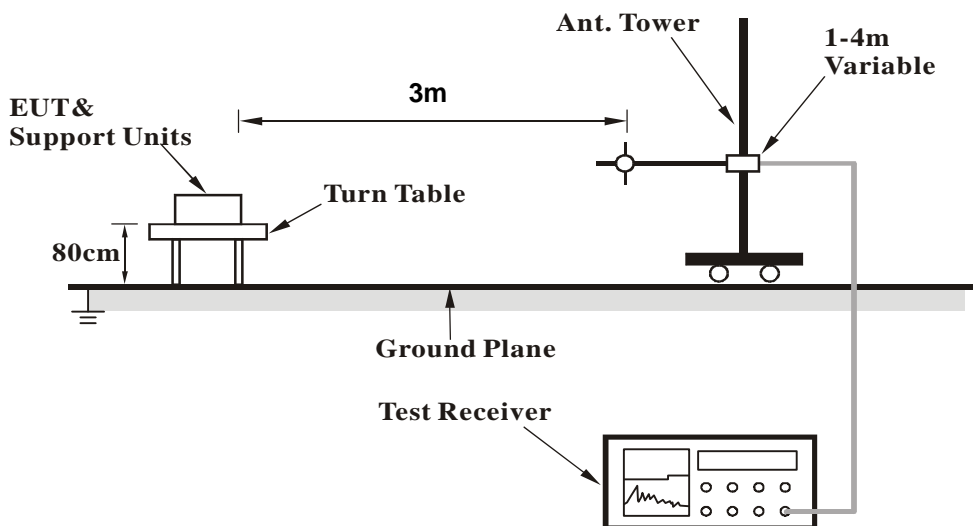

<Frequency Range above 1GHz>

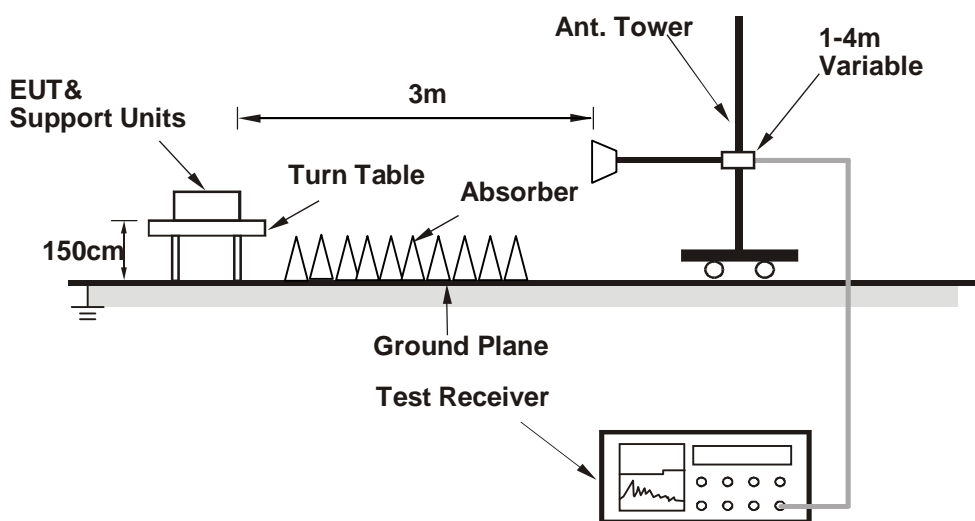

For the actual test configuration, please refer to the attached file (Test Setup Photo).

4.1.6 EUT Operating Conditions

Set the EUT under transmission condition continuously at specific channel frequency.

4.1.7 Test Results
ABOVE 1GHz DATA :
BT_GFSK

CHANNEL	TX Channel 0	DETECTOR FUNCTION	Peak (PK)
FREQUENCY RANGE	1GHz ~ 25GHz		Average (AV)

ANTENNA POLARITY & TEST DISTANCE: HORIZONTAL AT 3 M

NO.	FREQ. (MHz)	EMISSION LEVEL (dBuV/m)	LIMIT (dBuV/m)	MARGIN (dB)	ANTENNA HEIGHT (m)	TABLE ANGLE (Degree)	RAW VALUE (dBuV)	CORRECTION FACTOR (dB/m)
1	2390.00	42.1 PK	74.0	-31.9	1.65 H	240	46.45	-4.34
2	2390.00	30.5 AV	54.0	-23.5	1.65 H	240	34.87	-4.34
3	#2400.00	56.7 PK	76.6	-20.0	1.65 H	240	60.93	-4.27
4	#2400.00	42.0 AV	63.1	-21.2	1.65 H	240	46.24	-4.27
5	*2402.00	96.6 PK			1.65 H	240	100.88	-4.26
6	*2402.00	83.1 AV			1.65 H	240	87.39	-4.26
7	4804.00	48.7 PK	74.0	-25.3	1.00 H	75	45.81	2.90
8	4804.00	39.8 AV	54.0	-14.2	1.00 H	75	36.90	2.90

ANTENNA POLARITY & TEST DISTANCE: VERTICAL AT 3 M

NO.	FREQ. (MHz)	EMISSION LEVEL (dBuV/m)	LIMIT (dBuV/m)	MARGIN (dB)	ANTENNA HEIGHT (m)	TABLE ANGLE (Degree)	RAW VALUE (dBuV)	CORRECTION FACTOR (dB/m)
1	2390.00	41.3 PK	74.0	-32.7	1.00 V	271	45.61	-4.34
2	2390.00	29.1 AV	54.0	-24.9	1.00 V	271	33.45	-4.34
3	#2400.00	54.9 PK	73.3	-18.4	1.00 V	271	59.16	-4.27
4	#2400.00	40.4 AV	60.1	-19.7	1.00 V	271	44.68	-4.27
5	*2402.00	93.3 PK			1.00 V	271	97.53	-4.26
6	*2402.00	80.1 AV			1.00 V	271	84.38	-4.26
7	4804.00	49.4 PK	74.0	-24.6	1.02 V	188	46.53	2.90
8	4804.00	40.4 AV	54.0	-13.6	1.02 V	188	37.46	2.90

REMARKS:

- Emission Level(dBuV/m) = Raw Value(dBuV) + Correction Factor(dB/m)
- Correction Factor(dB/m) = Antenna Factor(dB/m) + Cable Factor(dB) – Pre-Amplifier Factor(dB)
- The other emission levels were very low against the limit.
- Margin value = Emission Level – Limit value
- " * ": Fundamental frequency.
- " # ": The radiated frequency is out of the restricted band.

CHANNEL	TX Channel 39	DETECTOR FUNCTION	Peak (PK)
FREQUENCY RANGE	1GHz ~ 25GHz		Average (AV)

ANTENNA POLARITY & TEST DISTANCE: HORIZONTAL AT 3 M								
NO.	FREQ. (MHz)	EMISSION LEVEL (dBuV/m)	LIMIT (dBuV/m)	MARGIN (dB)	ANTENNA HEIGHT (m)	TABLE ANGLE (Degree)	RAW VALUE (dBuV)	CORRECTION FACTOR (dB/m)
1	*2441.00	97.3 PK			1.59 H	244	101.37	-4.06
2	*2441.00	84.1 AV			1.59 H	244	88.19	-4.06
3	4882.00	49.7 PK	74.0	-24.4	1.06 H	77	46.57	3.08
4	4882.00	40.9 AV	54.0	-13.1	1.06 H	77	37.84	3.08

ANTENNA POLARITY & TEST DISTANCE: VERTICAL AT 3 M								
NO.	FREQ. (MHz)	EMISSION LEVEL (dBuV/m)	LIMIT (dBuV/m)	MARGIN (dB)	ANTENNA HEIGHT (m)	TABLE ANGLE (Degree)	RAW VALUE (dBuV)	CORRECTION FACTOR (dB/m)
1	*2441.00	95.1 PK			1.00 V	277	99.16	-4.06
2	*2441.00	81.8 AV			1.00 V	277	85.84	-4.06
3	4882.00	51.3 PK	74.0	-22.7	1.01 V	192	48.22	3.08
4	4882.00	42.4 AV	54.0	-11.7	1.01 V	192	39.27	3.08

REMARKS:

1. Emission Level(dBuV/m) = Raw Value(dBuV) + Correction Factor(dB/m)
2. Correction Factor(dB/m) = Antenna Factor(dB/m) + Cable Factor(dB) – Pre-Amplifier Factor(dB)
3. The other emission levels were very low against the limit.
4. Margin value = Emission Level – Limit value
5. " * ": Fundamental frequency.

CHANNEL	TX Channel 78	DETECTOR FUNCTION	Peak (PK)
FREQUENCY RANGE	1GHz ~ 25GHz		Average (AV)

ANTENNA POLARITY & TEST DISTANCE: HORIZONTAL AT 3 M								
NO.	FREQ. (MHz)	EMISSION LEVEL (dBuV/m)	LIMIT (dBuV/m)	MARGIN (dB)	ANTENNA HEIGHT (m)	TABLE ANGLE (Degree)	RAW VALUE (dBuV)	CORRECTION FACTOR (dB/m)
1	*2480.00	99.3 PK			2.48 H	42	103.13	-3.88
2	*2480.00	95.9 AV			2.48 H	42	99.74	-3.88
3	2483.50	49.2 PK	74.0	-24.8	2.48 H	42	53.04	-3.85
4	2483.50	37.1 AV	54.0	-16.9	2.48 H	42	40.93	-3.85
5	4960.00	51.5 PK	74.0	-22.6	1.09 H	178	48.12	3.33
6	4960.00	41.4 AV	54.0	-12.6	1.09 H	178	38.04	3.33

ANTENNA POLARITY & TEST DISTANCE: VERTICAL AT 3 M								
NO.	FREQ. (MHz)	EMISSION LEVEL (dBuV/m)	LIMIT (dBuV/m)	MARGIN (dB)	ANTENNA HEIGHT (m)	TABLE ANGLE (Degree)	RAW VALUE (dBuV)	CORRECTION FACTOR (dB/m)
1	*2480.00	96.8 PK			1.50 V	133	100.66	-3.88
2	*2480.00	83.4 AV			1.50 V	133	87.27	-3.88
3	2483.50	46.9 PK	74.0	-27.1	1.50 V	133	50.79	-3.85
4	2483.50	32.6 AV	54.0	-21.4	1.50 V	133	36.42	-3.85
5	4960.00	52.4 PK	74.0	-21.6	1.02 V	184	49.05	3.33
6	4960.00	43.2 AV	54.0	-10.9	1.02 V	184	39.82	3.33

REMARKS:

1. Emission Level(dBuV/m) = Raw Value(dBuV) + Correction Factor(dB/m)
2. Correction Factor(dB/m) = Antenna Factor(dB/m) + Cable Factor(dB) – Pre-Amplifier Factor(dB)
3. The other emission levels were very low against the limit.
4. Margin value = Emission Level – Limit value
5. " * ": Fundamental frequency.

BT_8DPSK

CHANNEL	TX Channel 0	DETECTOR FUNCTION	Peak (PK)
FREQUENCY RANGE	1GHz ~ 25GHz		Average (AV)

ANTENNA POLARITY & TEST DISTANCE: HORIZONTAL AT 3 M

NO.	FREQ. (MHz)	EMISSION LEVEL (dBuV/m)	LIMIT (dBuV/m)	MARGIN (dB)	ANTENNA HEIGHT (m)	TABLE ANGLE (Degree)	RAW VALUE (dBuV)	CORRECTION FACTOR (dB/m)
1	2390.00	42.4 PK	74.0	-31.6	2.34 H	202	46.75	-4.34
2	2390.00	30.2 AV	54.0	-23.8	2.34 H	202	34.53	-4.34
3	#2400.00	64.0 PK	75.7	-11.8	2.34 H	202	68.22	-4.27
4	#2400.00	49.7 AV	58.2	-8.4	2.34 H	202	53.99	-4.27
5	*2402.00	95.7 PK			2.34 H	202	99.97	-4.26
6	*2402.00	78.2 AV			2.34 H	202	82.43	-4.26
7	4804.00	48.3 PK	74.0	-25.7	1.26 H	311	45.37	2.90
8	4804.00	37.8 AV	54.0	-16.2	1.26 H	311	34.88	2.90

ANTENNA POLARITY & TEST DISTANCE: VERTICAL AT 3 M

NO.	FREQ. (MHz)	EMISSION LEVEL (dBuV/m)	LIMIT (dBuV/m)	MARGIN (dB)	ANTENNA HEIGHT (m)	TABLE ANGLE (Degree)	RAW VALUE (dBuV)	CORRECTION FACTOR (dB/m)
1	2390.00	41.0 PK	74.0	-33.0	2.77 V	227	45.36	-4.34
2	2390.00	28.9 AV	54.0	-25.1	2.77 V	227	33.28	-4.34
3	#2400.00	63.0 PK	72.7	-9.7	2.77 V	227	67.28	-4.27
4	#2400.00	47.3 AV	55.4	-8.1	2.77 V	227	51.55	-4.27
5	*2402.00	92.7 PK			2.77 V	227	96.99	-4.26
6	*2402.00	75.4 AV			2.77 V	227	79.64	-4.26
7	4804.00	49.7 PK	74.0	-24.3	1.08 V	172	46.81	2.90
8	4804.00	39.0 AV	54.0	-15.0	1.08 V	172	36.14	2.90

REMARKS:

- Emission Level(dBuV/m) = Raw Value(dBuV) + Correction Factor(dB/m)
- Correction Factor(dB/m) = Antenna Factor(dB/m) + Cable Factor(dB) – Pre-Amplifier Factor(dB)
- The other emission levels were very low against the limit.
- Margin value = Emission Level – Limit value
- " * ": Fundamental frequency.
- " # ": The radiated frequency is out of the restricted band.

CHANNEL	TX Channel 39	DETECTOR FUNCTION	Peak (PK)
FREQUENCY RANGE	1GHz ~ 25GHz		Average (AV)

ANTENNA POLARITY & TEST DISTANCE: HORIZONTAL AT 3 M								
NO.	FREQ. (MHz)	EMISSION LEVEL (dBuV/m)	LIMIT (dBuV/m)	MARGIN (dB)	ANTENNA HEIGHT (m)	TABLE ANGLE (Degree)	RAW VALUE (dBuV)	CORRECTION FACTOR (dB/m)
1	*2441.00	98.8 PK			2.50 H	194	102.83	-4.06
2	*2441.00	81.3 AV			2.50 H	194	85.36	-4.06
3	4882.00	51.3 PK	74.0	-22.7	1.19 H	318	48.21	3.08
4	4882.00	41.0 AV	54.0	-13.0	1.19 H	318	37.93	3.08

ANTENNA POLARITY & TEST DISTANCE: VERTICAL AT 3 M								
NO.	FREQ. (MHz)	EMISSION LEVEL (dBuV/m)	LIMIT (dBuV/m)	MARGIN (dB)	ANTENNA HEIGHT (m)	TABLE ANGLE (Degree)	RAW VALUE (dBuV)	CORRECTION FACTOR (dB/m)
1	*2441.00	96.6 PK			2.77 V	213	100.62	-4.06
2	*2441.00	79.2 AV			2.77 V	213	83.23	-4.06
3	4882.00	52.0 PK	74.0	-22.0	1.04 V	138	48.95	3.08
4	4882.00	41.6 AV	54.0	-12.4	1.04 V	138	38.54	3.08

REMARKS:

1. Emission Level(dBuV/m) = Raw Value(dBuV) + Correction Factor(dB/m)
2. Correction Factor(dB/m) = Antenna Factor(dB/m) + Cable Factor(dB) – Pre-Amplifier Factor(dB)
3. The other emission levels were very low against the limit.
4. Margin value = Emission Level – Limit value
5. " * ": Fundamental frequency.



A D T

CHANNEL	TX Channel 78	DETECTOR FUNCTION	Peak (PK)
FREQUENCY RANGE	1GHz ~ 25GHz		Average (AV)

ANTENNA POLARITY & TEST DISTANCE: HORIZONTAL AT 3 M

NO.	FREQ. (MHz)	EMISSION LEVEL (dBuV/m)	LIMIT (dBuV/m)	MARGIN (dB)	ANTENNA HEIGHT (m)	TABLE ANGLE (Degree)	RAW VALUE (dBuV)	CORRECTION FACTOR (dB/m)
1	*2480.00	99.6 PK			2.49 H	45	103.46	-3.88
2	*2480.00	81.3 AV			2.49 H	45	85.13	-3.88
3	2483.50	49.4 PK	74.0	-24.6	2.49 H	45	53.27	-3.85
4	2483.50	37.8 AV	54.0	-16.2	2.49 H	45	41.62	-3.85
5	4960.00	52.3 PK	74.0	-21.7	1.11 H	307	48.95	3.33
6	4960.00	42.0 AV	54.0	-12.0	1.11 H	307	38.67	3.33

ANTENNA POLARITY & TEST DISTANCE: VERTICAL AT 3 M

NO.	FREQ. (MHz)	EMISSION LEVEL (dBuV/m)	LIMIT (dBuV/m)	MARGIN (dB)	ANTENNA HEIGHT (m)	TABLE ANGLE (Degree)	RAW VALUE (dBuV)	CORRECTION FACTOR (dB/m)
1	*2480.00	97.1 PK			2.68 V	217	100.95	-3.88
2	*2480.00	79.4 AV			2.68 V	217	83.27	-3.88
3	2483.50	46.8 PK	74.0	-27.2	2.68 V	217	50.69	-3.85
4	2483.50	34.6 AV	54.0	-19.4	2.68 V	217	38.44	-3.85
5	4960.00	53.2 PK	74.0	-20.8	1.06 V	122	49.86	3.33
6	4960.00	42.5 AV	54.0	-11.5	1.06 V	122	39.17	3.33

REMARKS:

1. Emission Level(dBuV/m) = Raw Value(dBuV) + Correction Factor(dB/m)
2. Correction Factor(dB/m) = Antenna Factor(dB/m) + Cable Factor(dB) – Pre-Amplifier Factor(dB)
3. The other emission levels were very low against the limit.
4. Margin value = Emission Level – Limit value
5. " * ": Fundamental frequency.

BELOW 1GHz WORST-CASE DATA: GFSK

CHANNEL	TX Channel 78	DETECTOR FUNCTION	Quasi-Peak (QP)
FREQUENCY RANGE	30MHz ~ 1GHz		

ANTENNA POLARITY & TEST DISTANCE: HORIZONTAL AT 3 M

NO.	FREQ. (MHz)	EMISSION LEVEL (dBuV/m)	LIMIT (dBuV/m)	MARGIN (dB)	ANTENNA HEIGHT (m)	TABLE ANGLE (Degree)	RAW VALUE (dBuV)	CORRECTION FACTOR (dB/m)
1	80.54	25.1 QP	40.0	-14.9	1.57 H	173	43.36	-18.28
2	172.01	36.3 QP	43.5	-7.2	1.73 H	176	50.34	-14.01
3	208.09	34.5 QP	43.5	-9.0	1.27 H	101	50.75	-16.28
4	224.02	38.3 QP	46.0	-7.7	1.34 H	80	54.68	-16.36
5	487.99	33.2 QP	46.0	-12.8	1.46 H	122	41.98	-8.82
6	760.51	30.2 QP	46.0	-15.8	1.00 H	110	33.74	-3.58

ANTENNA POLARITY & TEST DISTANCE: VERTICAL AT 3 M

NO.	FREQ. (MHz)	EMISSION LEVEL (dBuV/m)	LIMIT (dBuV/m)	MARGIN (dB)	ANTENNA HEIGHT (m)	TABLE ANGLE (Degree)	RAW VALUE (dBuV)	CORRECTION FACTOR (dB/m)
1	34.12	32.2 QP	40.0	-7.8	1.34 V	231	47.57	-15.36
2	81.27	31.8 QP	40.0	-8.2	1.56 V	150	50.28	-18.44
3	172.01	29.0 QP	43.5	-14.5	1.44 V	86	43.03	-14.01
4	224.09	33.7 QP	46.0	-12.3	1.33 V	205	50.09	-16.36
5	376.05	27.7 QP	46.0	-18.3	1.82 V	6	38.60	-10.86
6	618.04	29.6 QP	46.0	-16.4	1.00 V	297	35.78	-6.16

REMARKS:

1. Emission Level(dBuV/m) = Raw Value(dBuV) + Correction Factor(dB/m)
2. Correction Factor(dB/m) = Antenna Factor(dB/m) + Cable Factor(dB) – Pre-Amplifier Factor(dB)
3. The other emission levels were very low against the limit.
4. Margin value = Emission Level – Limit value

4.2 Conducted Emission Measurement

4.2.1 Limits of Conducted Emission Measurement

Frequency (MHz)	Conducted Limit (dBuV)	
	Quasi-peak	Average
0.15 - 0.5	66 - 56	56 - 46
0.50 - 5.0	56	46
5.0 - 30.0	60	50

Note: 1. The lower limit shall apply at the transition frequencies.

2. The limit decreases in line with the logarithm of the frequency in the range of 0.15 to 0.50MHz.

4.2.2 Test Instruments

Description & Manufacturer	Model No.	Serial No.	Cal. Date	Cal. Due
ROHDE & SCHWARZ TEST RECEIVER	ESCS30	838251/021	Oct. 27, 2014	Oct. 26, 2015
SCHWARZBECK Artificial Mains Network (for EUT)	NSLK 8128	8128-244	Sep. 29, 2014	Sep. 28, 2015
LISN With Adapter (for EUT)	AD10	C05Ada-001	Sep. 29, 2014	Sep. 28, 2015
ROHDE & SCHWARZ 200-A Four-line V-Network	ENV4200	830326/018	Sep. 15, 2014	Sep. 14, 2015
ROHDE & SCHWARZ Artificial Mains Network (for peripherals)	ESH3-Z5	894785/020	Aug. 14, 2014	Aug. 13, 2015
Software	ADT_Cond_V7.3.7	NA	NA	NA
RF cable (JYEBAO)	5D-FB	Cable-C05.01	Feb. 05, 2015	Feb. 04, 2016
LYNICS Terminator (For R&S LISN)	0900510	E1-01-305	Feb. 09, 2015	Feb. 08, 2016

Notes: 1. The calibration interval of the above test instruments is 12 months and the calibrations are traceable to NML/ROC and NIST/USA.

2. The test was performed in Shielded Room No. 5.

3. The VCCI Site Registration No. C-1093.

4. The Industry Canada Reference No. IC 3789-5.

4.2.3 Test Procedures

- The EUT was placed 0.4 meters from the conducting wall of the shielded room with EUT being connected to the power mains through a line impedance stabilization network (LISN). Other support units were connected to the power mains through another LISN. The two LISNs provide 50 ohm/ 50uH of coupling impedance for the measuring instrument.
- Both lines of the power mains connected to the EUT were checked for maximum conducted interference.
- The frequency range from 150kHz to 30MHz was searched. Emission levels under (Limit - 20dB) was not recorded.

NOTE: The resolution bandwidth and video bandwidth of test receiver is 9kHz for quasi-peak detection (QP) and average detection (AV) at frequency 0.15MHz-30MHz.

4.2.4 Deviation From Test Standard

No deviation.

4.2.5 Test Setup

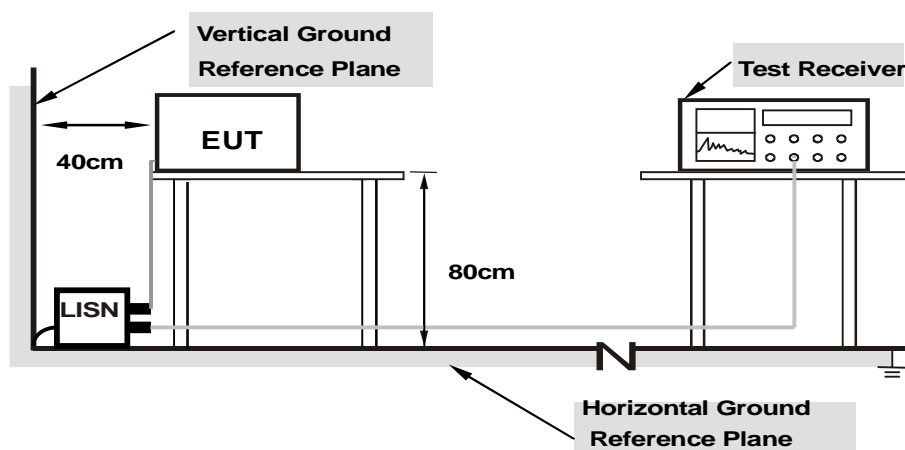

- Note:**
- Support units were connected to second LISN.
 - Both of LISNs (AMN) are 80 cm from EUT and at least 80 from other units and other metal planes

For the actual test configuration, please refer to the attached file (Test Setup Photo).

4.2.6 EUT Operating Condition

Same as 4.1.6.

4.2.7 Test Results

Phase	Line (L)	Detector Function	Quasi-Peak (QP) / Average (AV)
-------	----------	-------------------	--------------------------------

No	Freq. [MHz]	Corr.	Reading Value		Emission Level		Limit		Margin	
		Factor	[dB (uV)]		[dB (uV)]		[dB (uV)]		(dB)	
	(dB)	Q.P.	AV.	Q.P.	AV.	Q.P.	AV.	Q.P.	AV.	
1	0.15001	0.10	45.47	29.81	45.57	29.91	66.00	56.00	-20.43	-26.09
2	0.20469	0.12	38.10	24.94	38.22	25.06	63.42	53.42	-25.20	-28.36
3	0.35313	0.17	43.51	35.82	43.68	35.99	58.89	48.89	-15.20	-12.89
4	0.59922	0.24	25.58	17.84	25.82	18.08	56.00	46.00	-30.18	-27.92
5	1.62109	0.36	32.53	24.73	32.89	25.09	56.00	46.00	-23.11	-20.91
6	7.95703	0.58	29.18	21.25	29.76	21.83	60.00	50.00	-30.24	-28.17

REMARKS:

1. Q.P. and AV. are abbreviations of quasi-peak and average individually.
2. The emission levels of other frequencies were very low against the limit.
3. Margin value = Emission level - Limit value
4. Correction factor = Insertion loss + Cable loss
5. Emission Level = Correction Factor + Reading Value.

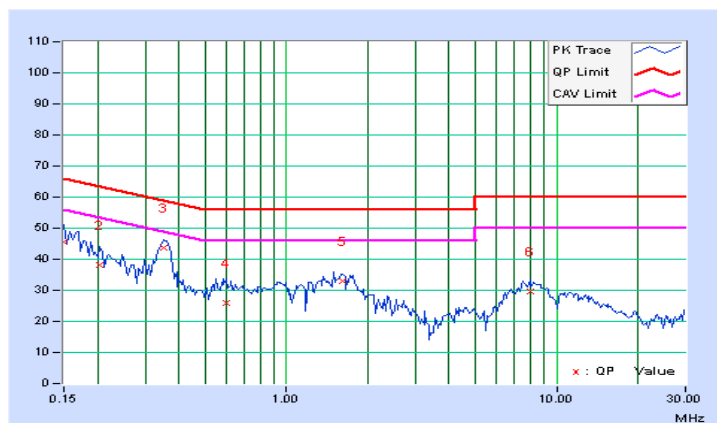

Phase	Neutral (N)	Detector Function	Quasi-Peak (QP) / Average (AV)
-------	-------------	-------------------	--------------------------------

No	Freq. [MHz]	Corr.	Reading Value		Emission Level		Limit		Margin	
		Factor (dB)	[dB (uV)]		[dB (uV)]		[dB (uV)]		(dB)	
			Q.P.	AV.	Q.P.	AV.	Q.P.	AV.	Q.P.	AV.
1	0.16562	0.14	44.31	31.84	44.45	31.98	65.18	55.18	-20.73	-23.20
2	0.35313	0.21	46.85	38.34	47.06	38.55	58.89	48.89	-11.83	-10.34
3	0.61484	0.28	32.69	25.83	32.97	26.11	56.00	46.00	-23.03	-19.89
4	0.93125	0.35	32.58	24.15	32.93	24.50	56.00	46.00	-23.07	-21.50
5	1.57813	0.39	34.12	25.19	34.51	25.58	56.00	46.00	-21.49	-20.42
6	8.53516	0.70	23.51	16.11	24.21	16.81	60.00	50.00	-35.79	-33.19

REMARKS:

1. Q.P. and AV. are abbreviations of quasi-peak and average individually.
2. The emission levels of other frequencies were very low against the limit.
3. Margin value = Emission level - Limit value
4. Correction factor = Insertion loss + Cable loss
5. Emission Level = Correction Factor + Reading Value.

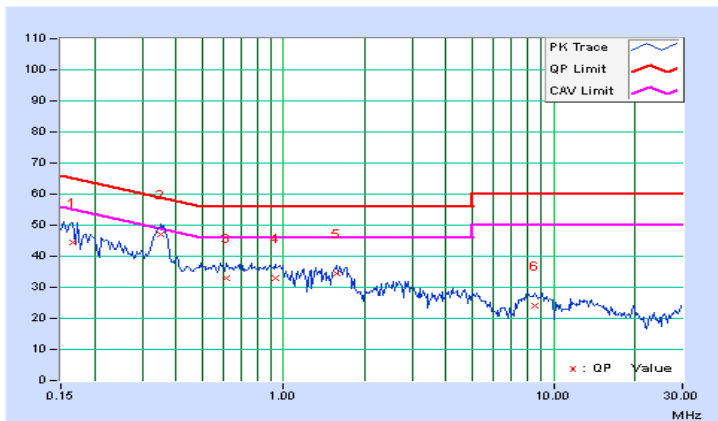

4.3 Number of Hopping Frequency Used

4.3.1 Limits of Hopping Frequency Used Measurement

At least 15 channels frequencies, and should be equally spaced.

4.3.2 Test Setup

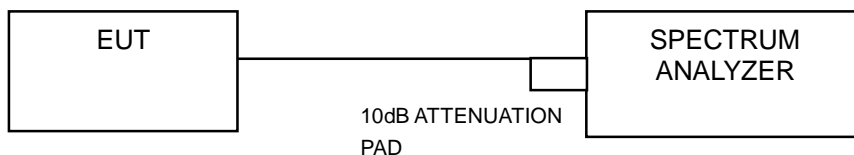

4.3.3 Test Instruments

Refer to section 4.1.2 to get information of above instrument.

4.3.4 Test Procedure

- a. Check the calibration of the measuring instrument (SA) using either an internal calibrator or a known signal from an external generator.
- b. Turn on the EUT and connect its antenna terminal to measurement via a low loss cable. Then set it to any one measured frequency within its operating range and make sure the instrument is operated in its linear range.
- c. Set the SA on MaxHold Mode, and then keep the EUT in hopping mode. Record all the signals from each channel until each one has been recorded.
- d. Set the SA on View mode and then plot the result on SA screen.
- e. Repeat above procedures until all frequencies measured were complete.

4.3.5 Deviation from Test Standard

No deviation.

4.3.6 Test Results

There are 79 hopping frequencies in the hopping mode. Please refer to next page for the test result. On the plots, it shows that the hopping frequencies are equally spaced.

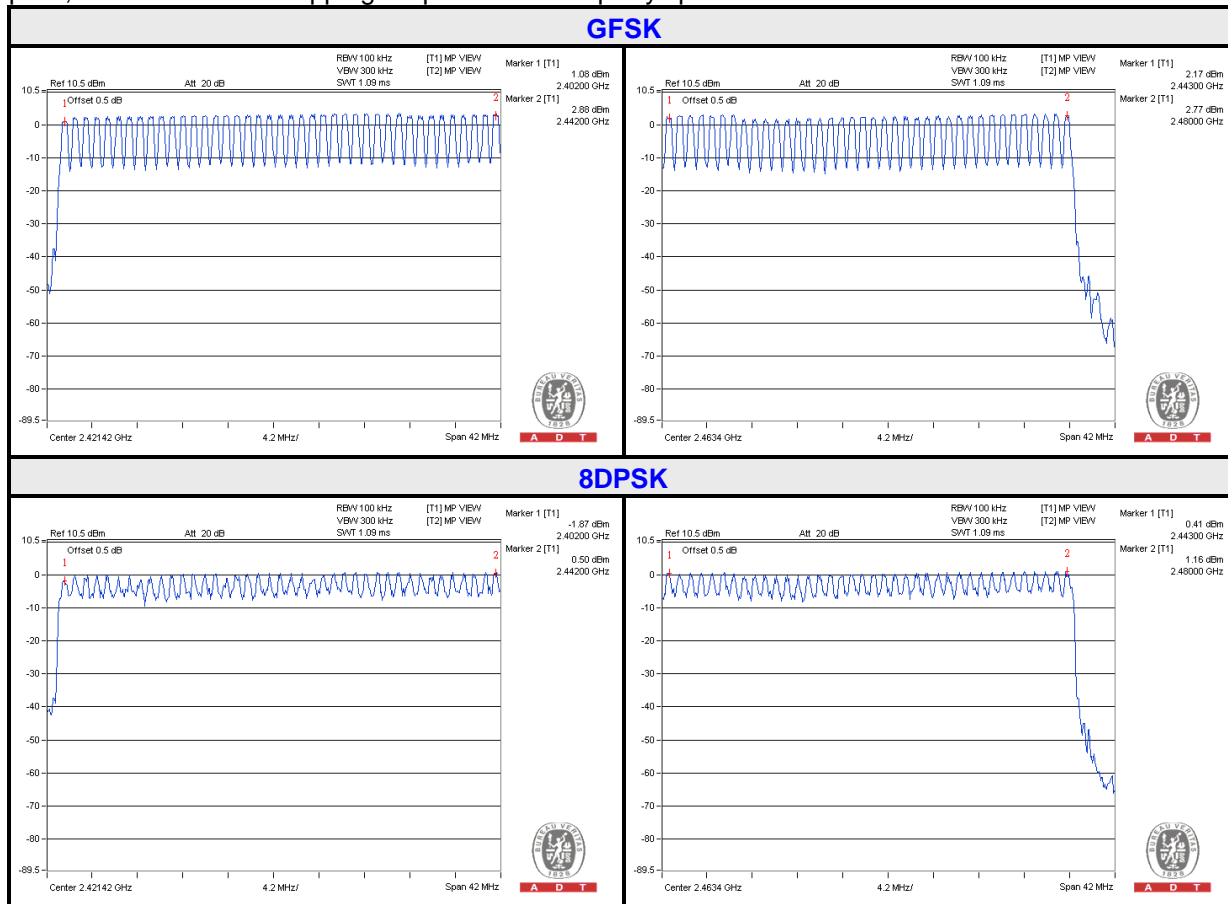

4.4 Dwell Time on Each Channel

4.4.1 Limits of Dwell Time on Each Channel Measurement

The average time of occupancy on any channel shall not be greater than 0.4 seconds within a period of 0.4 seconds multiplied by the number of hopping channels employed.

4.4.2 Test Setup

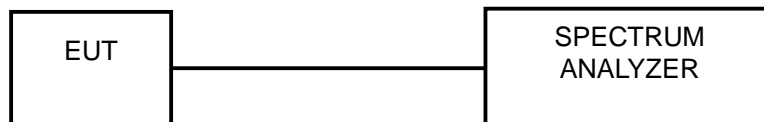

4.4.3 Test Instruments

Refer to section 4.1.2 to get information of above instrument.

4.4.4 Test Procedures

- a. Check the calibration of the measuring instrument (SA) using either an internal calibrator or a known signal from an external generator.
- b. Turn on the EUT and connect its antenna terminal to measurement via a low loss cable. Then set it to any one measured frequency within its operating range and make sure the instrument is operated in its linear range.
- c. Adjust the center frequency of SA on any frequency be measured and set SA to zero span mode. And then, set RBW and VBW of spectrum analyzer to proper value.
- d. Measure the time duration of one transmission on the measured frequency. And then plot the result with time difference of this time duration.
- e. Repeat above procedures until all different time-slot modes have been completed.

4.4.5 Deviation from Test Standard

No deviation.

4.4.6 Test Results

GFSK

Mode	Number of transmission in a 31.6 (79Hopping*0.4)	Length of transmission time (msec)	Result (msec)	Limit (msec)
DH1	51 (times / 5 sec) * 6.32 = 322.32 times	0.46	148.27	400
DH3	25 (times / 5 sec) * 6.32 = 158.00 times	1.711	270.34	400
DH5	16 (times / 5 sec) * 6.32 = 101.12 times	2.978	301.14	400

NOTE: Test plots of the transmitting time slot are shown on next page.



8DPSK

Mode	Number of transmission in a 31.6 (79Hopping*0.4)	Length of transmission time (msec)	Result (msec)	Limit (msec)
DH1	50 (times / 5 sec) * 6.32 = 316.00 times	0.461	145.68	400
DH3	26 (times / 5 sec) * 6.32 = 164.32 times	1.71	280.99	400
DH5	17 (times / 5 sec) * 6.32 = 107.44 times	2.985	320.71	400

NOTE: Test plots of the transmitting time slot are shown on next page.



4.5 Channel Bandwidth

4.5.1 Limits of Channel Bandwidth Measurement

For frequency hopping system operating in the 2400-2483.5MHz, If the 20dB bandwidth of hopping channel is greater than 25kHz, two-thirds 20dB bandwidth of hopping channel shall be a minimum limit for the hopping channel separation.

4.5.2 Test Setup

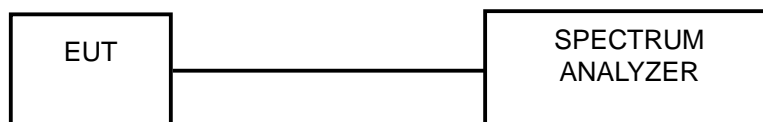

4.5.3 Test Instruments

Refer to section 4.1.2 to get information of above instrument.

4.5.4 Test Procedure

- Check the calibration of the measuring instrument using either an internal calibrator or a known signal from an external generator.
- Turn on the EUT and connect it to measurement instrument. Then set it to any one convenient frequency within its operating range. Set a reference level on the measuring instrument equal to the highest peak value.
- Measure the frequency difference of two frequencies that were attenuated 20dB from the reference level. Record the frequency difference as the emission bandwidth.
- Repeat above procedures until all frequencies measured were complete.

4.5.5 Deviation from Test Standard

No deviation.

4.5.6 EUT Operating Condition

The software provided by client enabled the EUT to transmit and receive data at lowest, middle and highest channel frequencies individually.

4.5.7 Test Results

Channel	Frequency (MHz)	20dB Bandwidth (MHz)	
		GFSK	8DPSK
0	2402	0.91	1.21
39	2441	0.88	1.21
78	2480	0.89	1.21

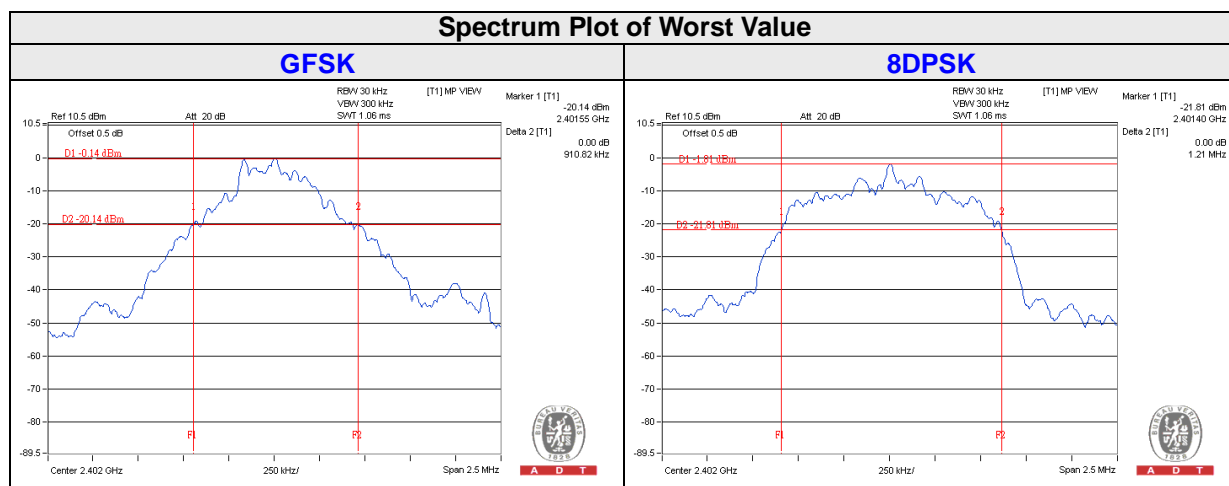

4.6 Hopping Channel Separation

4.6.1 Limits of Hopping Channel Separation Measurement

At least 25kHz or two-third of 20dB hopping channel bandwidth (whichever is greater).

4.6.2 Test Setup

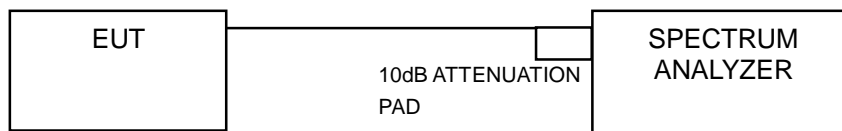

4.6.3 Test Instruments

Refer to section 4.1.2 to get information of above instrument.

4.6.4 Test Procedure

Measurement Procedure REF

- a. Check the calibration of the measuring instrument using either an internal calibrator or a known signal from an external generator.
- b. Turn on the EUT and connect it to measurement instrument. Then set it to any one convenient frequency within its operating range.
- c. By using the MaxHold function record the separation of two adjacent channels.
- d. Measure the frequency difference of these two adjacent channels by SA MARK function. And then plot the result on SA screen.
- e. Repeat above procedures until all frequencies measured were complete.

4.6.5 Deviation From Test Standard

No deviation.

4.6.6 Test Results

Channel	Frequency (MHz)	Adjacent Channel Separation (MHz)		20dB Bandwidth (MHz)		Minimum Limit (MHz)		Pass / Fail
		GFSK	8DPSK	GFSK	8DPSK	GFSK	8DPSK	
0	2402	1.00	1.00	0.91	1.21	0.61	0.81	Pass
39	2441	1.00	1.00	0.88	1.21	0.59	0.81	Pass
78	2480	1.00	1.00	0.89	1.21	0.59	0.81	Pass

NOTE: The minimum limit is two-third 20dB bandwidth.

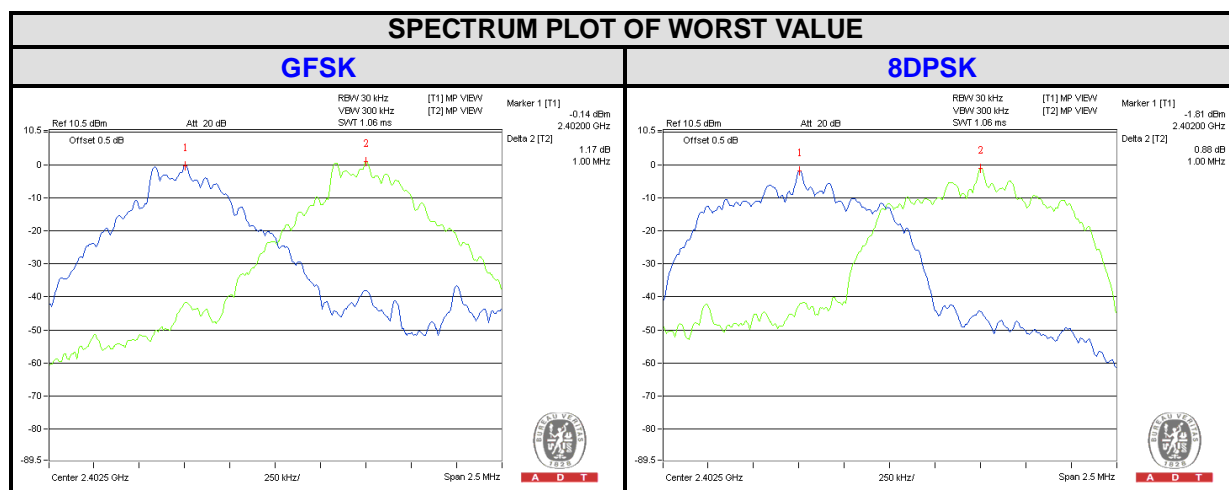

4.7 Maximum Output Power

4.7.1 Limits of Maximum Output Power Measurement

The Maximum Output Power Measurement is 125mW. (21dBm)

4.7.2 Test Setup

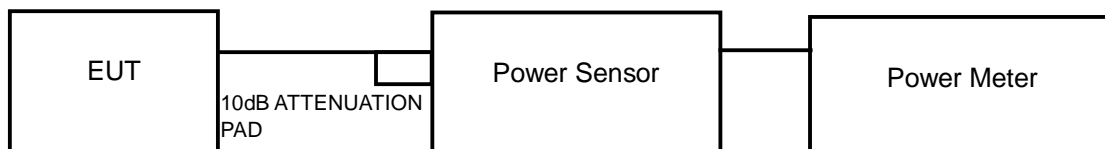

4.7.3 Test Instruments

Refer to section 4.1.2 to get information of above instrument.

4.7.4 Test Procedure

A peak / average power sensor was used on the output port of the EUT. A power meter was used to read the response of the peak / average power sensor. Record the peak power level.

4.7.5 Deviation from Test Standard

No deviation.

4.7.6 EUT Operating Condition

The software provided by client enabled the EUT to transmit and receive data at lowest, middle and highest channel frequencies individually.

4.7.7 Test Results

Channel	Frequency (MHZ)	Output Power (mW)		Output Power (dBm)		Power Limit (mW)	Pass / Fail
		GFSK	8DPSK	GFSK	8DPSK		
0	2402	1.641	0.977	2.15	-0.10	122.2	Pass
39	2441	2.432	1.374	3.86	1.38	122.2	Pass
78	2480	2.786	1.652	4.45	2.18	122.2	Pass

Power Limit = 21dBm -(6.13-6)=20.87dBm=122.2mW

4.8 Conducted Out of Band Emission Measurement

4.8.1 Limits Of Conducted Out Of Band Emission Measurement

Below -20dB of the highest emission level of operating band (in 100kHz RBW).

4.8.2 Test Instruments

Refer to section 4.1.2 to get information of above instrument.

4.8.3 Test Procedure

The transmitter output was connected to the spectrum analyzer via a low loss cable. Set both RBW and VBW of spectrum analyzer to 100 kHz and 300 kHz with suitable frequency span including 100 MHz bandwidth from band edge. The band edges was measured and recorded.

4.8.4 Deviation From Test Standard

No deviation.

4.8.5 Eut Operating Condition

The software provided by client enabled the EUT to transmit and receive data at lowest, middle and highest channel frequencies individually.

4.8.6 Test Results

The spectrum plots are attached on the following images. D1 line indicates the highest level, D2 line indicates the 20dB offset below D1. It shows compliance with the requirement.

GFSK

Hopping disabled_Low Channel

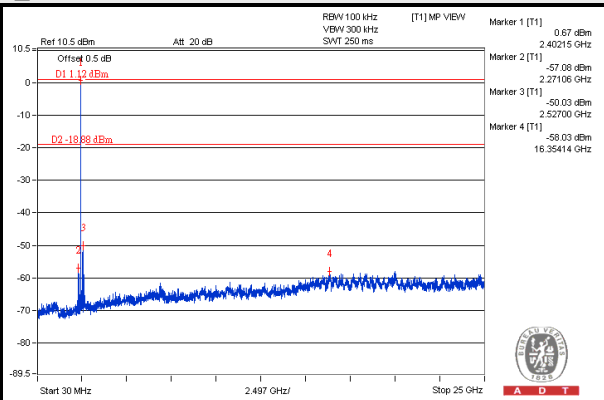
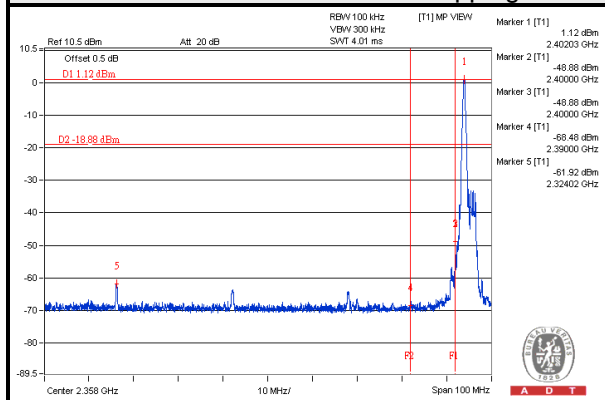

Hopping disabled_High Channel

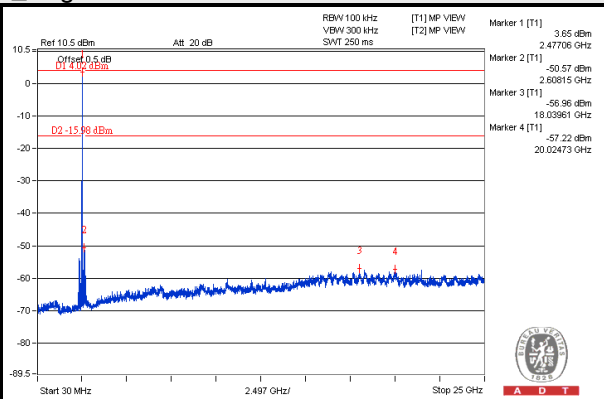
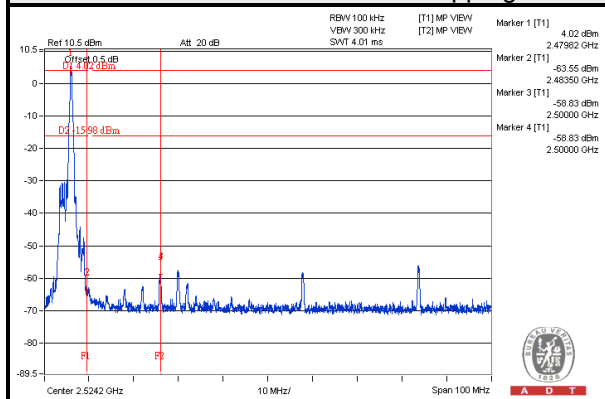

Hopping enabled_Low Channel

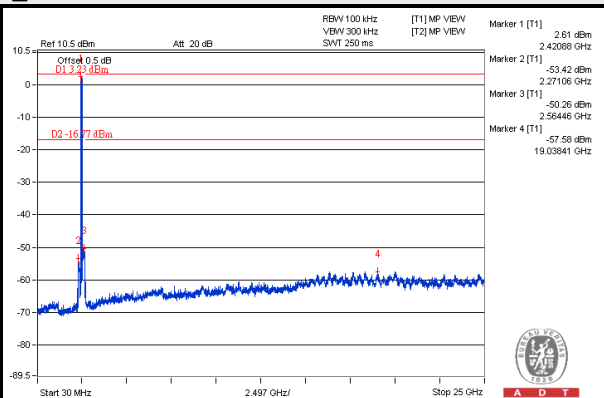
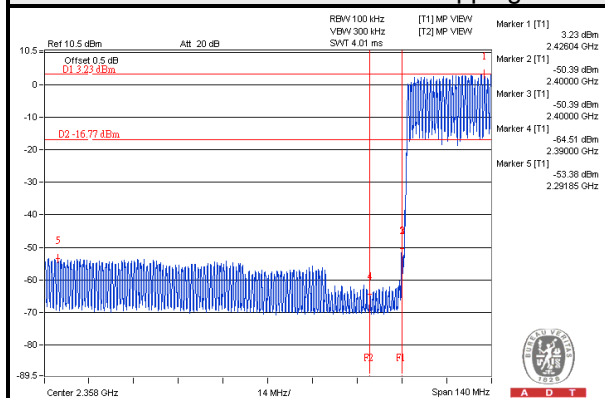

Hopping enabled_High Channel

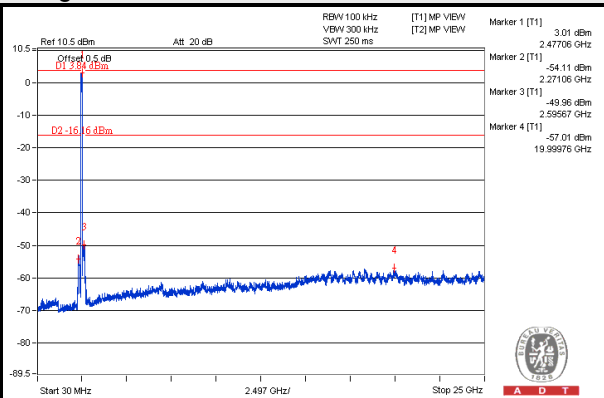
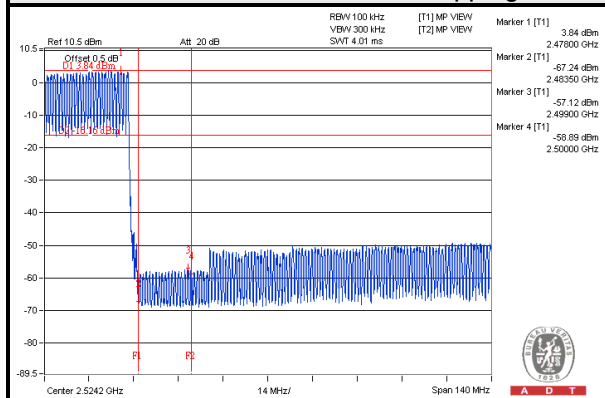

8DPSK

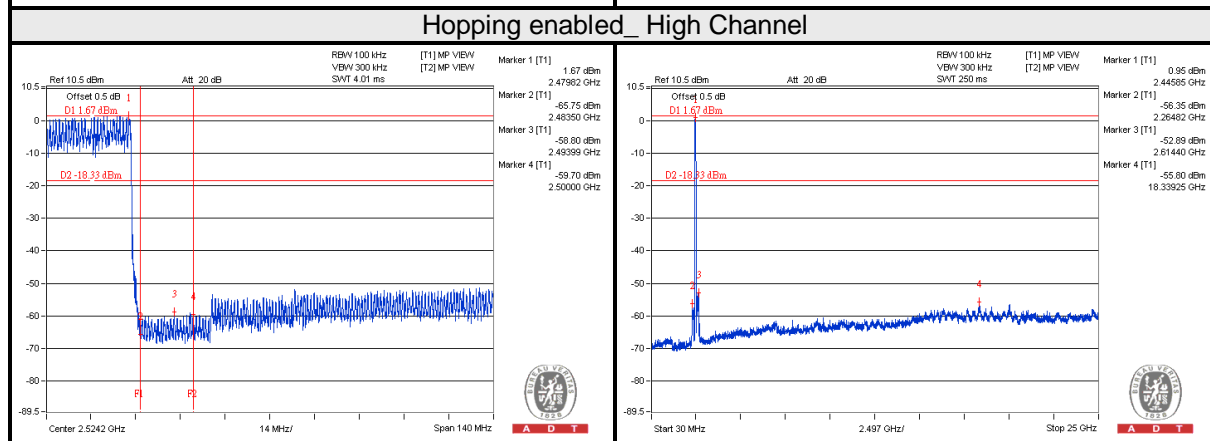
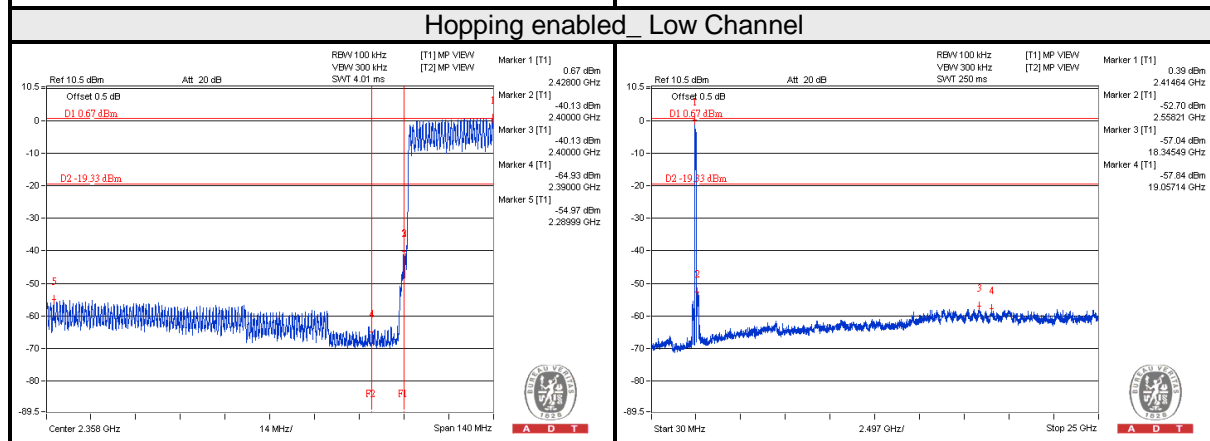
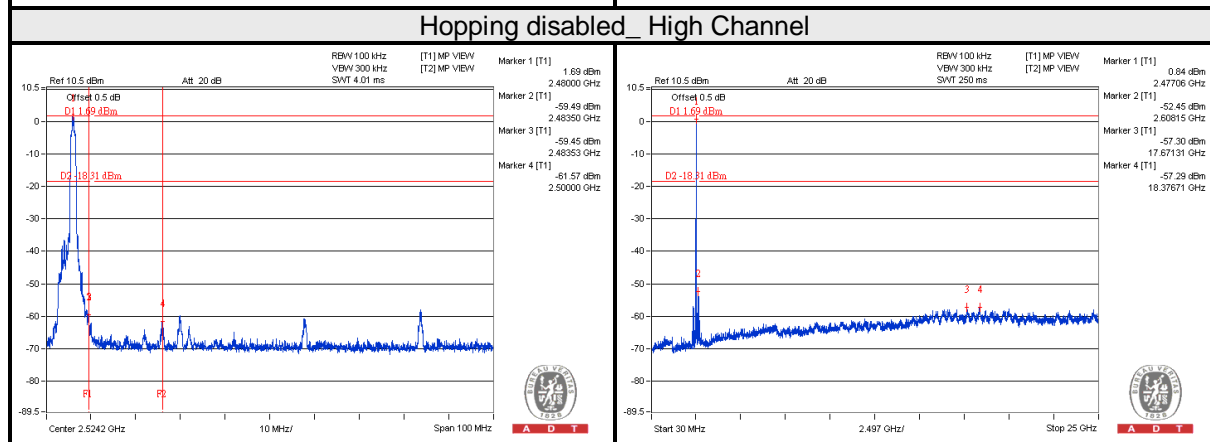
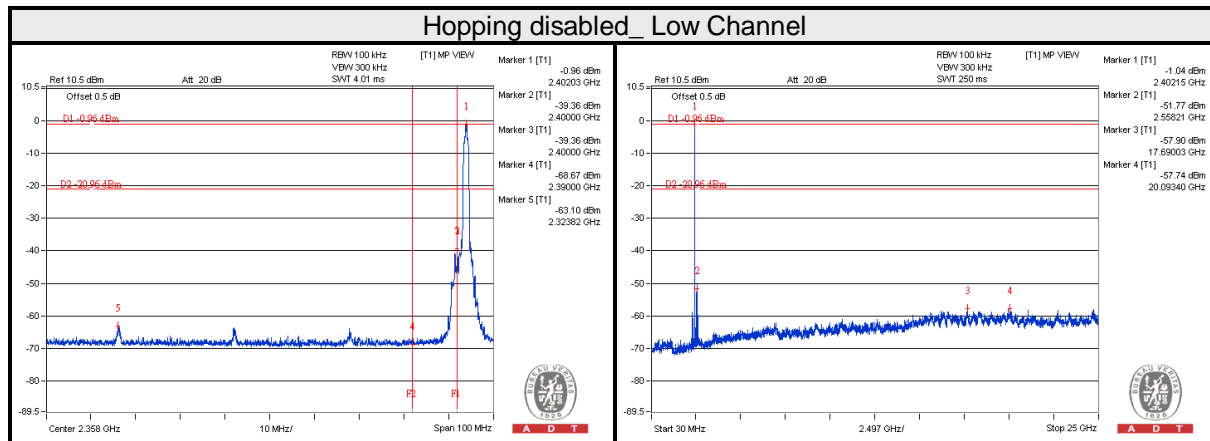

5 Pictures of Test Arrangements

Please refer to the attached file (Test Setup Photo).



Appendix – Information on the Testing Laboratories

We, Bureau Veritas Consumer Products Services (H.K.) Ltd., Taoyuan Branch, were founded in 1988 to provide our best service in EMC, Radio, Telecom and Safety consultation. Our laboratories are accredited and approved according to ISO/IEC 17025.

If you have any comments, please feel free to contact us at the following:

Linko EMC/RF Lab

Tel: 886-2-26052180

Fax: 886-2-26051924

Hsin Chu EMC/RF Lab/Telecom Lab

Tel: 886-3-5935343

Fax: 886-3-5935342

Hwa Ya EMC/RF/Safety

Tel: 886-3-3183232

Fax: 886-3-3270892

Email: service.adt@tw.bureauveritas.com

Web Site: www.bureauveritas-adt.com

The address and road map of all our labs can be found in our web site also.

--- END ---