

## EXHIBIT 5

### 5.0 Product Labeling

#### 5.1 Label Artwork

The label shown in the attached will be permanently affixed to the system at the location shown in Exhibit 5.2. Please note that the "???" in the FCC ID field will be replaced with "A94" for the production labels.

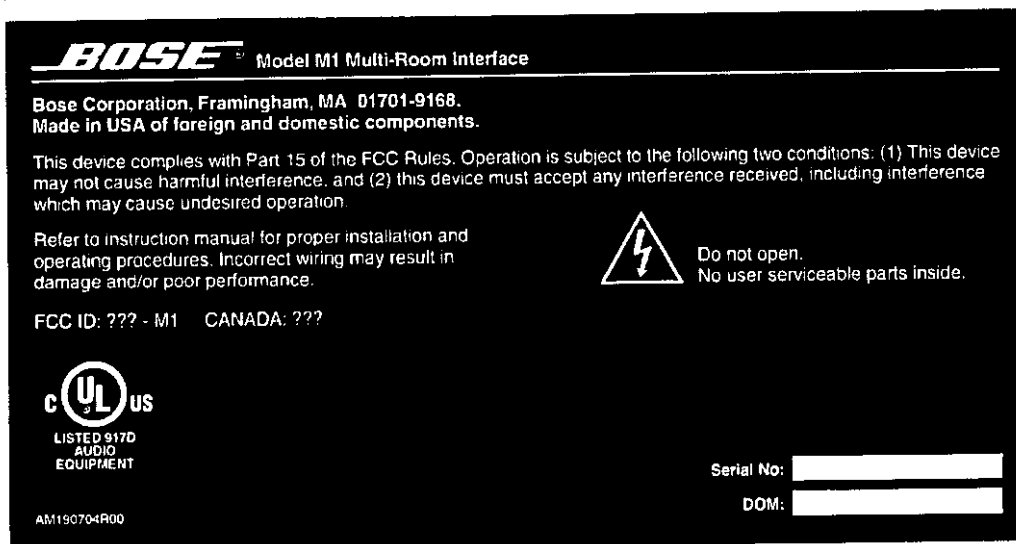

Label 1: Multi-Room Interface (base station)

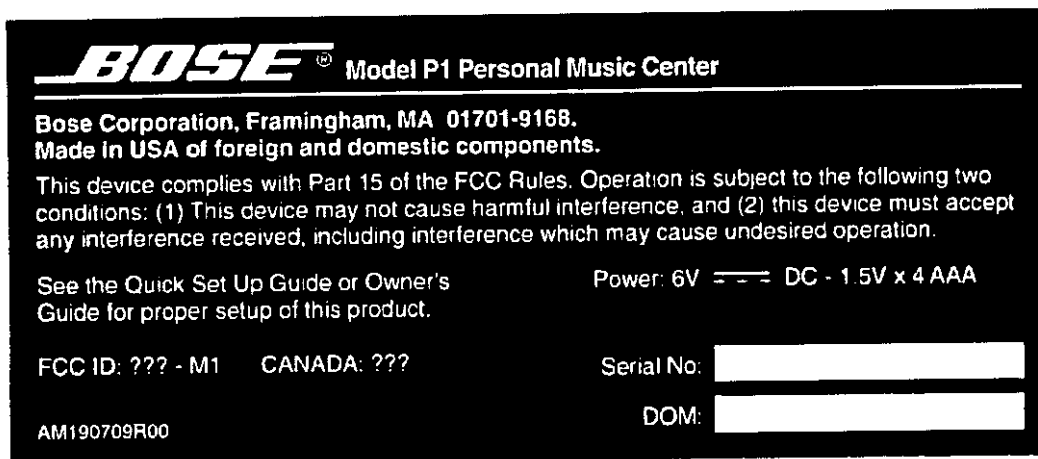

Label 2: Personal Music Center (remote)

5.2 Label Location

The label location is shown on the following two pages

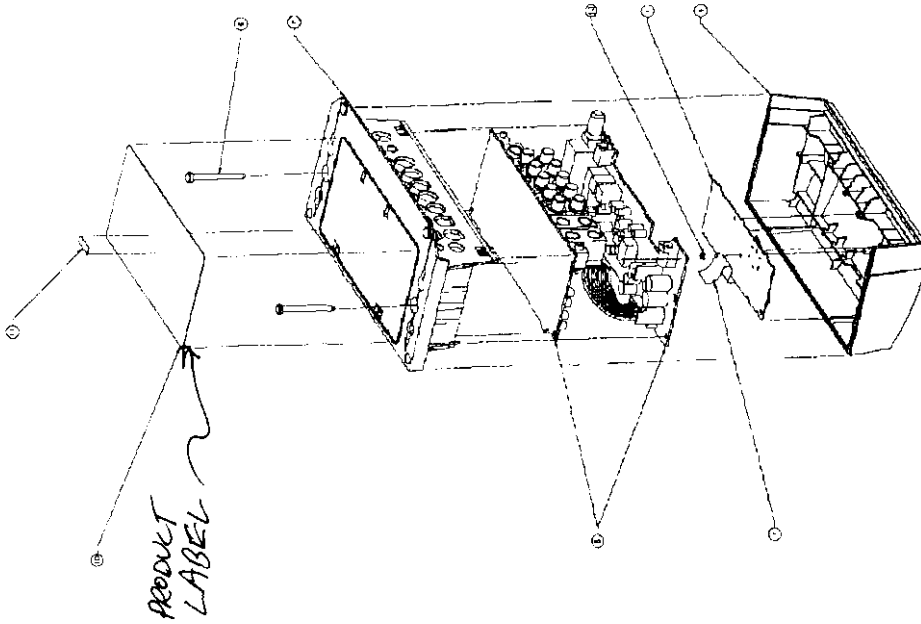
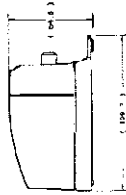
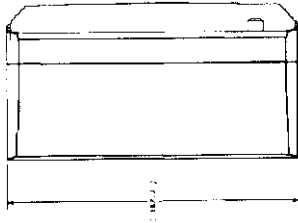
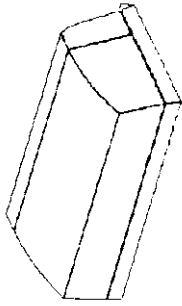

- NOTES:
1. MATERIAL - N/A
  2. FINISH - N/A
  3. DIMENSIONS ARE IN MILLIMETERS
  4. TOLERANCES UNLESS OTHERWISE SPECIFIED: N/A
  5. DIMENSIONS IN PARENTHESES ( ) TO BE PER BOSE OPERATING PROCEDURE DOCUMENT (N/A)

PROPERTY OF BOSE CORPORATION  
 ALL RIGHTS RESERVED  
 © 1989 BOSE CORPORATION

REV	DATE	BY	CHKD	DESCRIPTION
1	12/10/89	WJ	WJ	INITIAL RELEASE
2	01/11/90	WJ	WJ	REVISION
3	02/01/90	WJ	WJ	REVISION
4	02/01/90	WJ	WJ	REVISION
5	02/01/90	WJ	WJ	REVISION
6	02/01/90	WJ	WJ	REVISION
7	02/01/90	WJ	WJ	REVISION
8	02/01/90	WJ	WJ	REVISION
9	02/01/90	WJ	WJ	REVISION
10	02/01/90	WJ	WJ	REVISION
11	02/01/90	WJ	WJ	REVISION
12	02/01/90	WJ	WJ	REVISION
13	02/01/90	WJ	WJ	REVISION
14	02/01/90	WJ	WJ	REVISION
15	02/01/90	WJ	WJ	REVISION
16	02/01/90	WJ	WJ	REVISION
17	02/01/90	WJ	WJ	REVISION
18	02/01/90	WJ	WJ	REVISION
19	02/01/90	WJ	WJ	REVISION
20	02/01/90	WJ	WJ	REVISION
21	02/01/90	WJ	WJ	REVISION
22	02/01/90	WJ	WJ	REVISION
23	02/01/90	WJ	WJ	REVISION
24	02/01/90	WJ	WJ	REVISION
25	02/01/90	WJ	WJ	REVISION
26	02/01/90	WJ	WJ	REVISION
27	02/01/90	WJ	WJ	REVISION
28	02/01/90	WJ	WJ	REVISION
29	02/01/90	WJ	WJ	REVISION
30	02/01/90	WJ	WJ	REVISION
31	02/01/90	WJ	WJ	REVISION
32	02/01/90	WJ	WJ	REVISION
33	02/01/90	WJ	WJ	REVISION
34	02/01/90	WJ	WJ	REVISION
35	02/01/90	WJ	WJ	REVISION
36	02/01/90	WJ	WJ	REVISION
37	02/01/90	WJ	WJ	REVISION
38	02/01/90	WJ	WJ	REVISION
39	02/01/90	WJ	WJ	REVISION
40	02/01/90	WJ	WJ	REVISION
41	02/01/90	WJ	WJ	REVISION
42	02/01/90	WJ	WJ	REVISION
43	02/01/90	WJ	WJ	REVISION
44	02/01/90	WJ	WJ	REVISION
45	02/01/90	WJ	WJ	REVISION
46	02/01/90	WJ	WJ	REVISION
47	02/01/90	WJ	WJ	REVISION
48	02/01/90	WJ	WJ	REVISION
49	02/01/90	WJ	WJ	REVISION
50	02/01/90	WJ	WJ	REVISION

PROPERTY OF BOSE CORPORATION  
 ALL RIGHTS RESERVED  
 © 1989 BOSE CORPORATION

PROPERTY OF BOSE CORPORATION  
 ALL RIGHTS RESERVED  
 © 1989 BOSE CORPORATION

PROPERTY OF BOSE CORPORATION  
 ALL RIGHTS RESERVED  
 © 1989 BOSE CORPORATION

PROPERTY OF BOSE CORPORATION  
 ALL RIGHTS RESERVED  
 © 1989 BOSE CORPORATION

PROPERTY OF BOSE CORPORATION  
 ALL RIGHTS RESERVED  
 © 1989 BOSE CORPORATION

PROPERTY OF BOSE CORPORATION  
 ALL RIGHTS RESERVED  
 © 1989 BOSE CORPORATION

PROPERTY OF BOSE CORPORATION  
 ALL RIGHTS RESERVED  
 © 1989 BOSE CORPORATION

PROPERTY OF BOSE CORPORATION  
 ALL RIGHTS RESERVED  
 © 1989 BOSE CORPORATION

PROPERTY OF BOSE CORPORATION  
 ALL RIGHTS RESERVED  
 © 1989 BOSE CORPORATION

10 X 10 X 10  
10 X 10 X 10  
10 X 10 X 10

H G F E D C B A

11 10 9 8 7 6 5 4 3 2 1

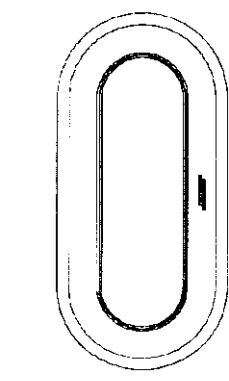

TOP VIEW

PRODUCT LABEL

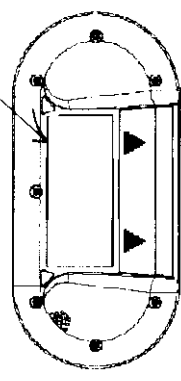

BOTTOM VIEW

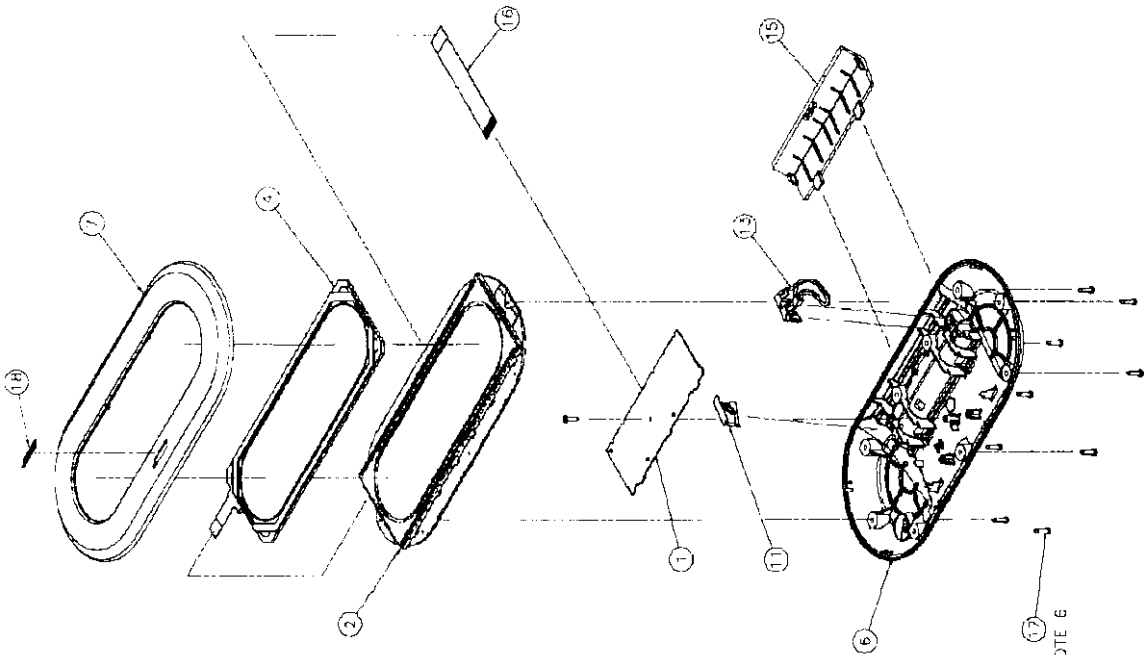

10 X (7)  
SEE NOTE 6

- NOTES:
1. MATERIAL: N/A
  2. FINISH: N/A
  3. DIMENSIONS: N/A
  4. TOLERANCES: N/A
  5. FINISH: PHOSPHATE
  6. TORQUE TO 4.0 ± 0.5 IN-LB.

EXPLODED VIEW

APPLICABLE DOCUMENTS TABLE	DESCRIBED BY
MODULE OF CONTROL CHARACTERISTICS	
CONTROL CHARACTERISTICS	

REVISIONS TO THIS DRAWING  
DATE  
BY

REV	DATE	DESCRIPTION
1		INITIAL RELEASE
2		REVISION
3		REVISION

**BRIDGE**  
BRIDGE  
SYSTEM ASSEMBLY CONTROLLER

11 10 9 8 7 6 5 4 3 2 1

# *Curtis-Straus*

---

October 16, 1998

Federal Communications Commission  
C/O Mellon Bank  
Three Mellon Bank  
525 William Penn Way  
27<sup>th</sup> Floor, Room 153-2713  
Pittsburgh, PA 15251-5315  
Attn: Wholesale Lockbox Shift Supervisor

Re: FCC Part 15 Certification for Bose Corporation (FCC ID: A94-M1)

Dear Sir:

Enclosed please find the above-referenced application, along with a check in the amount of \$1075.00 to cover the filing fee. Please note that we are simultaneously requesting the following services:

Certification	\$940.00
Request for Confidentiality	\$135.00

Please feel free to contact me with any questions.

Best regards,

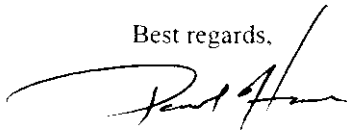

Paul Hare  
EMC Manager

CC w/enclosures  
Bose Corporation  
John Kanter

Curtis-Straus LLC  
527 Great Road  
Littleton, Massachusetts 01460  
Tel: (978) 486-8880 Fax: (978) 486-8828  
web: <http://world.std.com/~csweb>  
e-mail: [csweb@world.std.com](mailto:csweb@world.std.com)

---

Curtis-Straus Report  
prepared for

Bose Corp.

Testing of the Lifestyle 50 Personal  
Music Center and Multi-room Interface  
for FCC 47 CFR Part 15C

WO#: 980362

October 22, 1998

---