

Straubing, July 16, 2002

TEST-REPORT

No. 52226-20430

for

Tigershark

Inductive Tag Reader

Applicant: Texas Instruments Deutschland GmbH

Purpose of testing: To show compliance with

FCC Code of Federal Regulations,
CFR 47, Part 15, Subpart C,
Section 15.225

Note:

The test data of this report relate only to the individual item which has been tested. This report shall not be reproduced except in full extent without the written approval of the testing laboratory.

Table of Contents

1.	Administrative Data	3
2.	Identification of Test Laboratory	4
3.	Summary of Test Results	5
4.	Operation Mode of EUT.....	6
5.	Configuration of EUT and Peripheral Devices	7
6.	Measuring Methods	8
6.1.	Field strength of in-band emissions (§15.225 (a)) and unwanted emissions < 30 MHz (§15.225 (b))	8
6.2.	Frequency tolerance (§15.225 (c)).....	9
6.3.	Unwanted Emission 30 MHz - 1 GHz (§15.225 (b))	11
7.	Photographs of Test Setups	13
7.1.	Conducted Emissions 450 kHz – 30 MHz	13
7.2.	Radiated Emissions 10 kHz – 30 MHz	14
7.3.	Radiated Emissions 30 – 1000 MHz	15
8.	Equipment List.....	17
9.	Referenced Regulations	19
10.	List of Measurements	20
11.	Test Results	21
12.	Charts taken during testing.....	28

1. Administrative Data

Equipment Under Test (EUT): **Tigershark**
Serial number(s): **Sample no. 1**
Type of equipment: **Inductive Tag Reader**
Type of emission: **7K0A1D**
Parts/accessories: **---**
FCC-ID: **A92TSR102**

Applicant: **Texas Instruments Deutschland GmbH**
(full address) **Haggertystrasse 1
D-85356 Freising / Germany**
Contract identification: **---**
Contact person: **Mr. Reinhard Nowak**
Manufacturer: **Texas Instruments Deutschland GmbH**

Receipt of EUT: **01 July 2002**
Dates of test: **16 July 2002**
Note: **---**

Responsible for testing: **Johann Roidt**
Responsible for test report: **Johann Roidt**

2. Identification of Test Laboratory

Test Laboratory:
(full address): **Senton GmbH EMI/EMC Test Center
Aeussere Fruehlingstrasse 45
D-94315 Straubing
Germany**

Contact person: **Mr. Johann Roidt**
Communication: **Telephone (+49) 0 94 21 / 55 22-0
Fax (+49) 0 94 21 / 55 22-99
eMail: Office@senton.de**

FCC registration number: **90926**
Industry Canada file number: **IC 3050**

3. Summary of Test Results

The tested sample complies with the requirements for set forth in the

The Code of Federal Regulations 47, Part 15, Subpart C, Section 15.225

of the Federal Communication Commission (FCC).



Johann Roidt
Technical Manager

4. Operation Mode of EUT

Continuously reading a TAG

5. Configuration of EUT and Peripheral Devices

Configuration of cables of EUT

Not applicable

Configuration of peripheral devices connected to EUT

The EUT was connected to a Fujitsu Notebook PC via standard RS 232 interface.

6. Measuring Methods

6.1. Field strength of in-band emissions (§15.225 (a)) and unwanted emissions < 30 MHz (§15.225 (b))

Radiated emissions in the frequency range 9 kHz – 30 MHz will be measured initially at a distance of 3 meters. A prescan at 3 meter distance will be performed in a shielded room with the detector of the spectrum analyzer or EMI Receiver set to peak. Final measurement is then performed at 30 meter distance. In case the regulation requires testing at other distances, the result will be extrapolated. The extrapolation factor will be determined by making a second measurement at 10 meter distance. The provisions of 15.31 (d) apply.

According to section 15.209 (d) final measurement is performed with the detector set to Quasi Peak except for the frequency bands 9 – 90 kHz and 110 – 490 kHz where average detector is employed.

6.2. Frequency tolerance (§15.225 (c))

6.2.1. Frequency stability vs. temperature

The frequency stability vs. temperature was measured with a spectrum analyzer connected to the output of the transmitter power amplifier (conducted measurement) via dummy load while EUT was operating in transmit mode using the assigned frequency.

The trace mode of the spectrum analyzer was set to write with frequency count mode activated:

RBW = 100 Hz, VBW = 100 Hz, span = 20 kHz, sweep = 1.5 s (auto mode)

See figure 1 for the measurement setup.

Test equipment used (see equipment list for details):

02, 18, 51, 54, 69, 70, 71

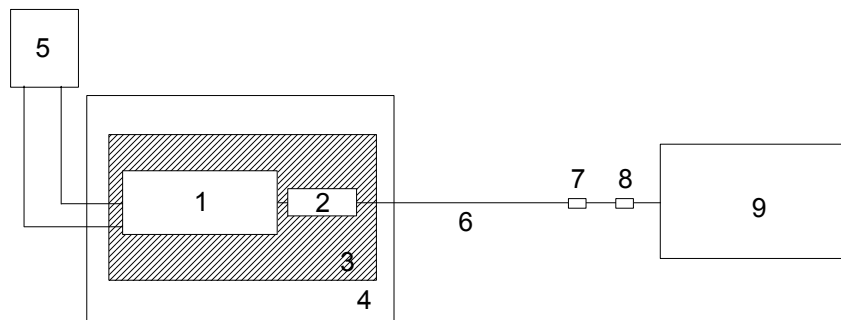

Figure 1: Measurement setup for testing within temperature test chamber

- | | |
|----------------------------|---------------------|
| 1 Transmitter (EUT) | 6 Test cable |
| 2 Dummy load | 7 DC-block |
| 3 Wooden support | 8 Attenuator |
| 4 Temperature test chamber | 9 Spectrum analyzer |
| 5 DC power supply | |

6.2.2. Frequency stability vs. supply voltage

The frequency stability vs. supply voltage was measured with a spectrum analyzer connected to the output of the transmitter power amplifier (conducted measurement) via dummy load while EUT was operating in transmit mode using the assigned frequency.

The trace mode of the spectrum analyzer was set to write with frequency count mode activated:

RBW = 100 Hz, VBW = 100 Hz, span = 20 kHz, sweep = 1.5 s (auto mode)

See figure 1 for the measurement setup.

Test equipment used (see equipment list for details):
02, 18, 51, 69, 70, 71

6.3. Unwanted Emission 30 MHz - 1 GHz (§15.225 (b))

Radiated emissions were measured over the frequency range from 30 MHz to 1 GHz. For final testing the detector-function of the spectrum analyzer was set to quasi peak

Measurements were made in both the horizontal and vertical planes of polarization. Preliminary scans were taken in a semi-anechoic room using a spectrum analyzer with the detector function set to peak and resolution bandwidth set to 100 kHz. All tests were performed at a test-distance of 3 meters. Hand-held or body-worn devices are rotated through three orthogonal axes to determine which attitude and configuration produces the highest emission relative to the limit and therefore shall be used for final testing. For final testing an open-area test-site was used. During the tests the EUT was rotated all around and the receiving-antenna was raised and lowered from 1 meter to 4 meters to find the maximum levels of emissions. The cables and equipment were placed and moved within the range of position likely to find their maximum emissions.

See figure 2 for the measurement setup.

Test equipment used (see equipment list for details):
01, 06, 12, 15, 38, 39, 40, 41, 55, 58, 61, 64, 66

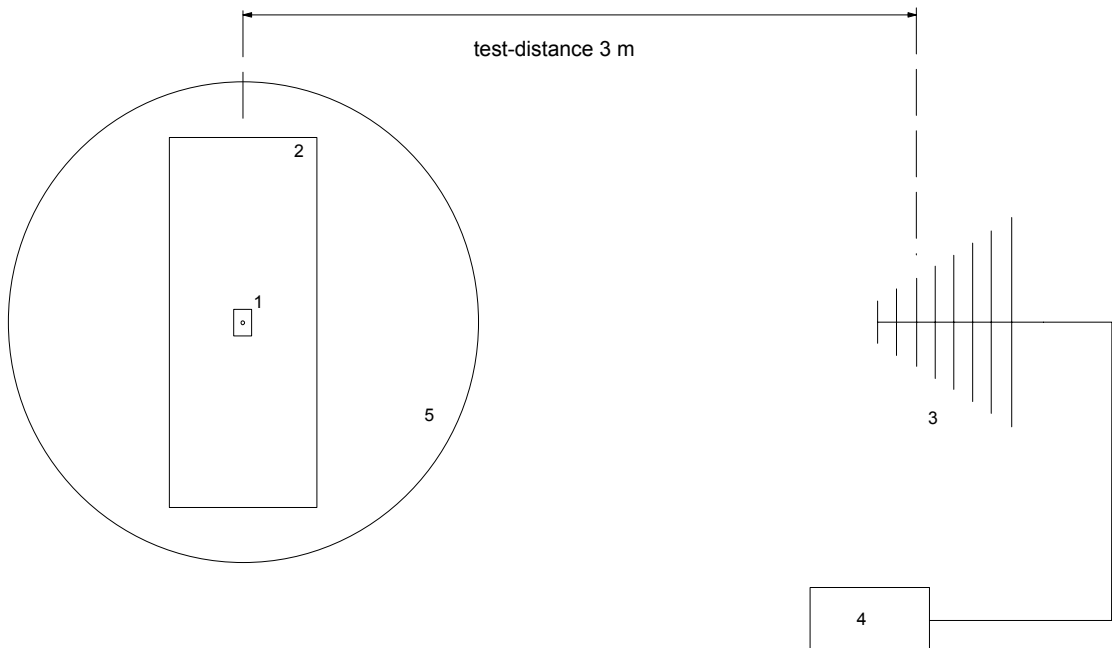

Figure 2: Measurement setup for radiated emission test

- 1 Transmitter (EUT)
- 2 Wooden table

- 3 Measurement antenna
- 4 Test receiver
- 5 Turn table

7. Photographs of Test Setups

7.1. Conducted Emissions 450 kHz – 30 MHz



7.2. Radiated Emissions 10 kHz – 30 MHz



7.3. Radiated Emissions 30 – 1000 MHz



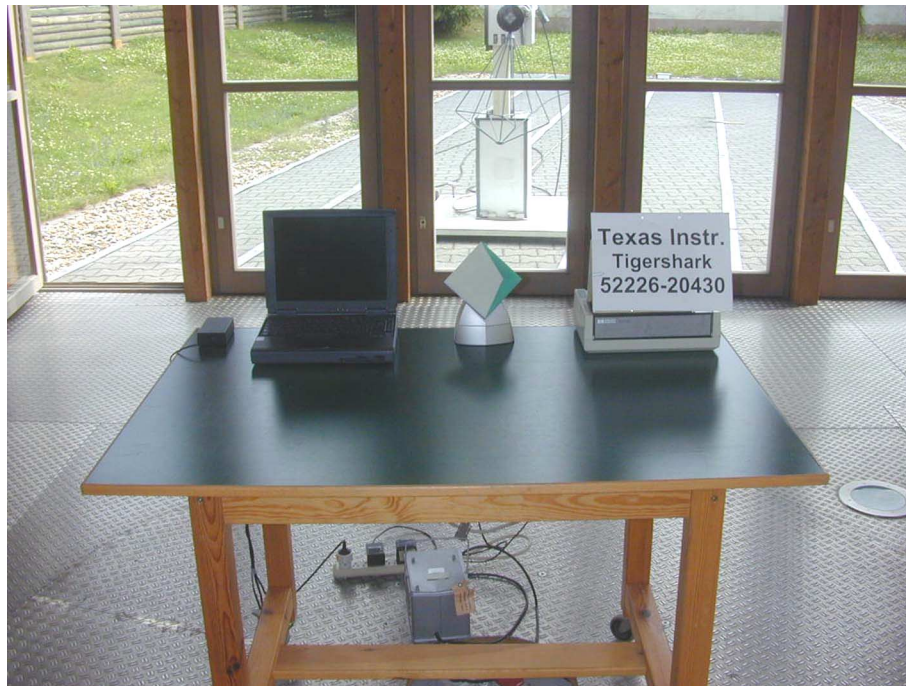

8. Equipment List

To facilitate reference to test equipment used for related tests, each item of test equipment and ancillaries such as cables are identified (numbered) by the Test Laboratory.

No.	Type	Model	Serial Number	Manufacturer
01	Spectrum Analyzer	R 3271	05050023	Advantest
02	EMI Test Receiver	ESMI	839379/013 839587/006	Rohde & Schwarz
03	Test Receiver	ESH 3	880112/032	Rohde & Schwarz
04	Test Receiver	ESHS 10	860043/016	Rohde & Schwarz
05	Test Receiver	ESV	881414/009	Rohde & Schwarz
06	Test Receiver	ESVP	881120/024	Rohde & Schwarz
07	Audio Analyzer	UPA	862954	Rohde & Schwarz
08	Power Meter	NRVS	836856/015	Rohde & Schwarz
09	Power Sensor	NRV-Z52	837901/030	Rohde & Schwarz
10	Power Sensor	NRV-Z4	863828/015	Rohde & Schwarz
11	Preamplifier	ESV-Z3	860907/004	Rohde & Schwarz
12	Preamplifier	R14601		Advantest
13	Preamplifier	ACX/080-3030	32640	CTT
14	Preamplifier	ACO/180-3530	32641	CTT
15	Signal generator	SMY 01	830694/001	Rohde & Schwarz
16	Signal Generator	HP 8673 D	2930A00966	Hewlett Packard
17	Waveform Generator	HP 33120 A	US34005375	Hewlett Packard
18	Attenuator 20 dB	4776-20	9503	Narda
19	Attenuator 10 dB	4776-10	9412	Narda
20	Pulse Limiter	ESH 3-Z2	1144	Rohde & Schwarz
21	Pulse Limiter	11947 A	3107A00566	Hewlett Packard
22	V-Network	ESH 3-Z5	862770/018	Rohde & Schwarz
23	V-Network	ESH 3-Z5	894785/005	Rohde & Schwarz
24	V-Network	ESH 3-Z5	830952/025	Rohde & Schwarz
25	V-Network	ESH 3-Z6	830722/010	Rohde & Schwarz
26	V-Network	NSLK 8127	8127152	Schwarzbeck
27	V-Network	NNLA 8119	8119148	Schwarzbeck
28	V-Network	SE 01	01	Senton
29	T-Network	ESH 3-Z4	890602/011	Rohde & Schwarz
30	T-Network	ESH 3-Z4	890602/012	Rohde & Schwarz
31	High Impedance Probe	TK 9416	01	Schwarzbeck
32	High Impedance Probe	TK 9416	02	Schwarzbeck
33	Current Probe	ESH 2-Z1	863366/18	Rohde & Schwarz
34	Current Probe	ESV-Z1	862553/3	Rohde & Schwarz

No.	Type	Model	Serial Number	Manufacturer
35	Absorbing Clamp	MDS 21	80911	Lüthi
36	Absorbing Clamp	MDS 21	79690	Lüthi
37	Loop Antenna	HFH2-Z2	882964/1	Rohde & Schwarz
38	Biconical Antenna	HK 116	842204/001	Rohde & Schwarz
39	Biconical Antenna	HK 116	836239/02	Rohde & Schwarz
40	Log. Periodic Antenna	HL 223	841516/023	Rohde & Schwarz
41	Log. Periodic Antenna	HL 223	834408/12	Rohde & Schwarz
42	Horn Antenna	3115	9508-4553	Emco
43	Horn Antenna	3160-03	9112-1003	Emco
44	Horn Antenna	3160-04	9112-1001	Emco
45	Horn Antenna	3160-05	9112-1001	Emco
46	Horn Antenna	3160-06	9112-1001	Emco
47	Horn Antenna	3160-07	9112-1008	Emco
48	Horn Antenna	3160-08	9112-1002	Emco
49	Horn Antenna	3160-09	9403-1025	Emco
50	Digital multimeter	199	463386	Keithley
51	DC Power Supply	NGSM 32/10	203	Rohde & Schwarz
52	DC Power Supply	NGB	2455	Rohde & Schwarz
53	DC Power Supply	NGA	386	Rohde & Schwarz
54	Temperature Test Chamber	HT4010	07065550	Heraeus
55	Cable	RG214	1309	Senton
56	Cable	200CM_001	1357	Rosenberger
57	Cable	150CM_001	1479	Rosenberger
58	Cable Set EG1	RG214	1189 - 1191	Senton
59	Cable Set Cabine 1	RG214		Senton
60	Cable Set Cabine 2	RG214		Senton
61	Cable Set Cabine 3	RG214		Senton
62	Shielded Room	No. 1	1451	Senton
63	Shielded Room	No. 2	1452	Senton
64	Semi-anechoic Chamber	No. 3	1453	Siemens
65	Shielded Room	No. 4	1454	Euroshield
66	Open Area Test Site	EG 1		Senton
67	Cable for Antenna Connector			Lucent Technologies
68	DC Block 0.01-18GHz		8037	Inmet Corp.
69	High pass filter			Lucent Technologies
69	DC Block	7006	A2798	Weinschel Corp.
70	Cable for Antenna Connector			Senton
71	Dummy load			Futaba Corporation

9. Referenced Regulations

All tests were performed with reference to the following regulations and standards:

<input checked="" type="checkbox"/>	CFR 47 Part 2	Code of Federal Regulations Part 2 (Frequency Allocations And Radio Treaty Matters, General Rules And Regulations) of the Federal Communication Commission (FCC)	October 1, 1999
<input type="checkbox"/>	CFR 47 Part 15 Subpart A	Code of Federal Regulations Part 15 (Radio Frequency Devices), Subpart A (General) of the Federal Communication Commission (FCC)	October 1, 1999
<input type="checkbox"/>	CFR 47 Part 15 Subpart B	Code of Federal Regulations Part 15 (Radio Frequency Devices), Subpart B (Unintentional Radiators) of the Federal Communication Commission (FCC)	October 1, 1999
<input checked="" type="checkbox"/>	CFR 47 Part 15 Subpart C	Code of Federal Regulations Part 15 (Radio Frequency Devices), Subpart C (Intentional Radiators) of the Federal Communication Commission (FCC)	October 1, 1999
<input type="checkbox"/>	CFR 47 Part 95 Subpart C/E	Code of Federal Regulations Part 95 (Personal Radio Services), Subpart C/E (Radio Control(R/C) Radio Service) of the Federal Communication Commission (FCC)	October 1, 1998
<input checked="" type="checkbox"/>	ANSI C63.4	American National Standard for Methods of Measurement of Radio-Noise Emissions from Low-Voltage Electrical and Electronic Equipment in the Range of 9 kHz - 40 GHz	October, 1992
<input checked="" type="checkbox"/>	RSS-210	Radio Standards Specification RSS-210 Issue 2 for Low Power Licence-Exempt Radiocommunication Devices of Industry Canada	February 24, 1996
<input type="checkbox"/>	TIA/EIA-603	Land Mobile FM or PM Communications Equipment Measurement and Performance Standards	February, 1993
<input type="checkbox"/>	TIA/EIA-603-1	Addendum to TIA/EIA-603	March 4, 1998

10. List of Measurements

CFR 47 Part 15 Subpart C			
Section(s):	Test	Page	Result
§15.207	Conducted powerline emissions		Passed
§15.225 (a)	Maximum in-band field strength		Passed
§15.225 (b)	Out-of-band emissions		Passed
§15.225 (c)	Frequency tolerance of carrier signal		Passed

11. Test Results

**Measurement of Conducted Emissions according to FCC Rules,
 Part 15, Subpart C, Section 15.207
 Frequency Band 0.45 - 30 MHz**

Model: Tigershark
 Type: Inductive Reader
 Serial No. ---
 Applicant: Texas Instruments Deutschland GmbH
 Test Site: Shielded Room No. 2
 Distance: N/A
 Date of Test: 16 July 2002

Test Results

Frequency (MHz)	Detector	Terminal tested	Analyzer Reading (dBµV)	Correction Factor (dB)	Terminal Voltage (dBµV)	Limit (dBµV)	Margin (dB)
0.185	AV	Neutral	52,4	0	52,4	54,3	1,9
0.370	AV	Neutral	48	0	48	48,5	0,5
0.555	AV	Neutral	42,6	0	42,6	46	3,4
0.920	AV	Neutral	40	0	40	46	6,0

**Field Strength of Emissions according to FCC Rules,
 Part 15, Subpart C, Section 15.225 (a), (b)
 Frequency Band < 30 MHz**

Model: **Tigershark**
 Type: **Inductive Reader**
 Serial No. **Prototype 1**
 Applicant: **Texas Instruments Deutschland GmbH**
 Test Site: **Open Field Test Site (without Ground Plane)**
 Distance: **30 Meter**
 Date of Test: **16 July 2002**

Frequency (MHz)	Detector	Antenna Polarization	Analyzer Reading (dBµV)	Correction Factor (dB)	Field Strength (dBµV/m)	Limit dBµV/m	Margin dB
13.553	Q.P.	N/A	***	20		29.5	---
13.560	Q.P.	N/A	30,8	20	56.8	80.0	23.2
13.567	Q.P.	N/A	***	20		29.5	---
27.125	Q.P.	N/A	***	20		29.5	---

*** = No emissions above noise floor detected

Sample calculation of field strength values:

$$\text{Field Strength (dBµV/m)} = \text{Analyzer Reading (dBµV)} + \text{Correction Factor (dB)}$$

Test equipment used (see equipment list for details):
 02, 13, 14, 16, 38, 40 ,42, 57, 64, 67

Band-edge compliance plot

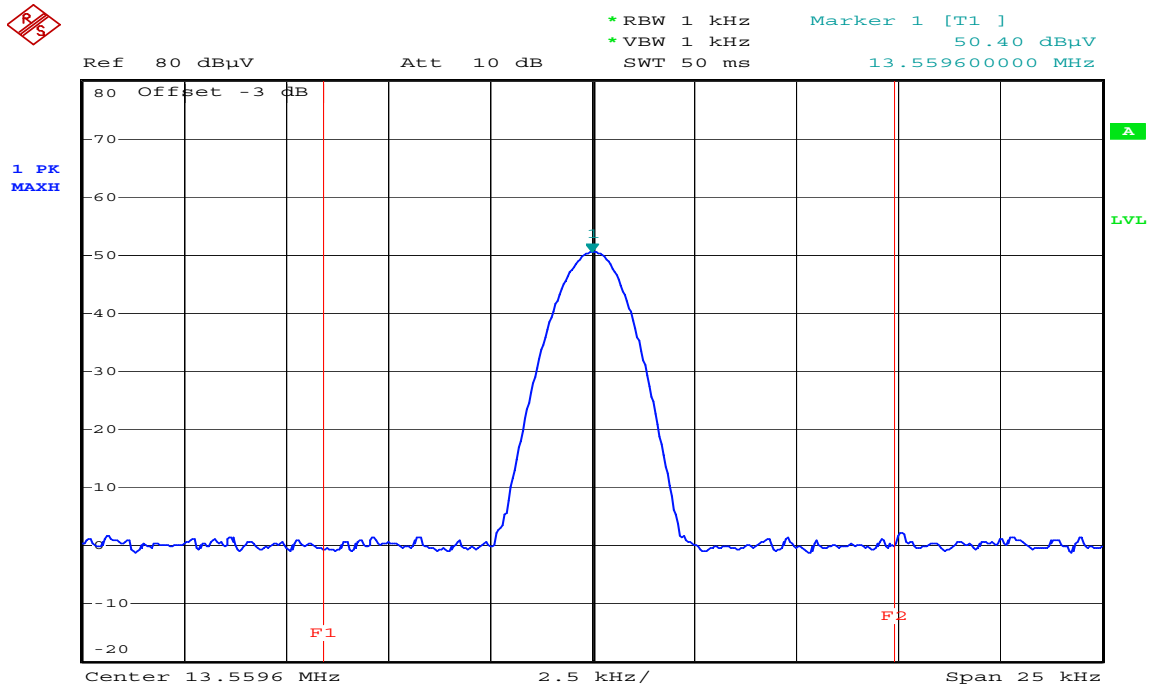

Comment A: ITS20393 External immunity in-band scan
 fv = 680 MHz / 70 dBuV
 Date: 17.JUL.2002 08:23:46

Restricted band compliance plot

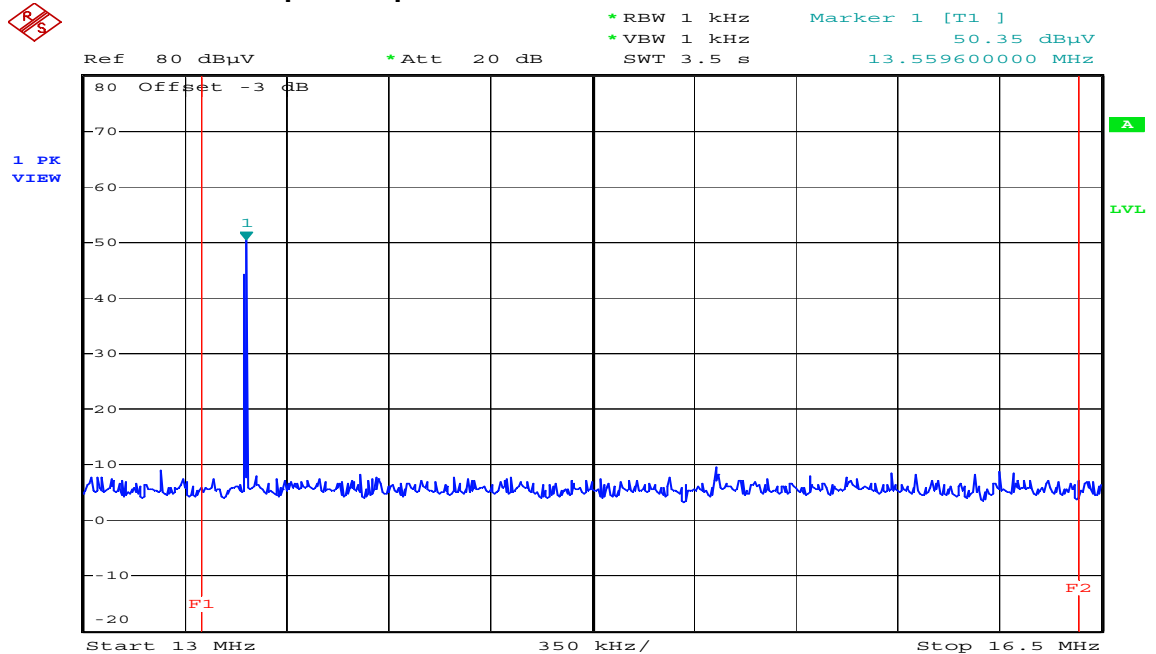

Comment A: ITS20393 External immunity in-band scan
 fv = 680 MHz / 70 dBuV
 Date: 17.JUL.2002 08:28:03

**Field Strength of Emissions according to FCC Rules,
 Part 15, Subpart C, Section 15.225 (b)
 Frequency Band > 30 MHz**

Model: **Tigershark**
 Type: **Inductive Reader**
 Serial No. **Prototype 1**
 Applicant: **Texas Instruments Deutschland GmbH**
 Test Site: **Open Field Test Site**
 Distance: **3 Meter**
 Date of Test: **15 July 2002**

Frequency (MHz)	Detector	Antenna Polarization	Analyzer Reading (dBµV)	Correction Factor (dB)	Field Strength (dBµV/m)	Limit dBµV/m	Margin dB
190.00	Q.P.	Hor	17.0	19.0	36.0	43.5	7.5
348.00	Q.P.	Hor	11.8	20.9	32.6	46.0	13.4
443.2	Q.P.	Hor	12.5	23.8	36.3	46.0	9.7
583.00	Q.P.	Hor	14.0	27.5	41.5	46.0	4.5

*** = No emissions above noise floor detected

Sample calculation of field strength values:

$$\text{Field Strength (dB}\mu\text{V/m)} = \text{Analyzer Reading (dB}\mu\text{V)} + \text{Correction Factor (dB)}$$

Test equipment used (see equipment list for details):
 02, 13, 14, 16, 38, 40, 42, 57, 64, 67

FREQUENCY STABILITY VS. TEMPERATURE

Section 15.225 (c)

Model: **Tigershark**
 Type: **Inductive Reader**
 Serial No. **Prototype 1**
 Applicant: **Texas Instruments Deutschland GmbH**
 Date of Test: **16 July 2002**

Test conditions:

Temperature: see table below
 Supply voltage: 5.0 V DC

Specifications:

Frequency tolerance: **±0.01 % of nominal carrier frequency**
 Temperature range: -20 to +50°C

Temperature (°C)	Nominal carrier frequency (MHz)	Frequency measured (MHz)	Frequency deviation (Hz)	Frequency deviation (%)	Limit (%)
-20	13,560000	13,559893	-107	-0,0008	0,01
-10	13,560000	13,559789	-211	-0,0016	0,00
±0	13,560000	13,559781	-219	-0,0016	0,01
+10	13,560000	13,559751	-249	-0,0018	0,01
+20	13,560000	13,559711	-289	-0,0021	0,01
+30	13,560000	13,559659	-341	-0,0025	0,01
+40	13,560000	13,559613	-387	-0,0029	0,01
+50	13,560000	13,559575	-425	-0,0031	0,01

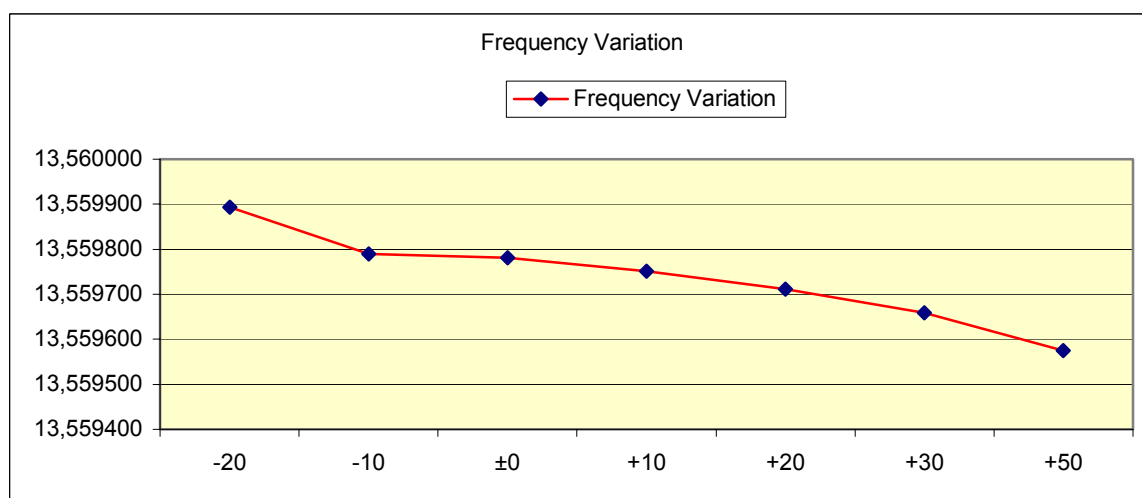

Result: Test passed

FREQUENCY STABILITY VS. SUPPLY VOLTAGE

Section 15.225 (c)

Model: **Tigershark**
 Type: **Inductive Reader**
 Serial No. **Prototype 1**
 Applicant: **Texas Instruments Deutschland GmbH**
 Date of Test: **16 July 2002**

Test conditions:

Temperature: see table below
 Supply voltage: **115 V AC**

Specifications:

Frequency tolerance: **±0.01 % of nominal carrier frequency**
 Supply voltage range: +/- 15 % of nominal supply voltage

Supply voltage (V)	Nominal carrier frequency (MHz)	Frequency measured (MHz)	Frequency deviation (Hz)	Frequency deviation (%)	Limit (%)
97,75	13,560000	13,559711	-289	-0,00213	0,01
115,00	13,560000	13,559711	-289	-0,00213	0,01
132,25	13,560000	13,559711	-289	-0,00213	0,01

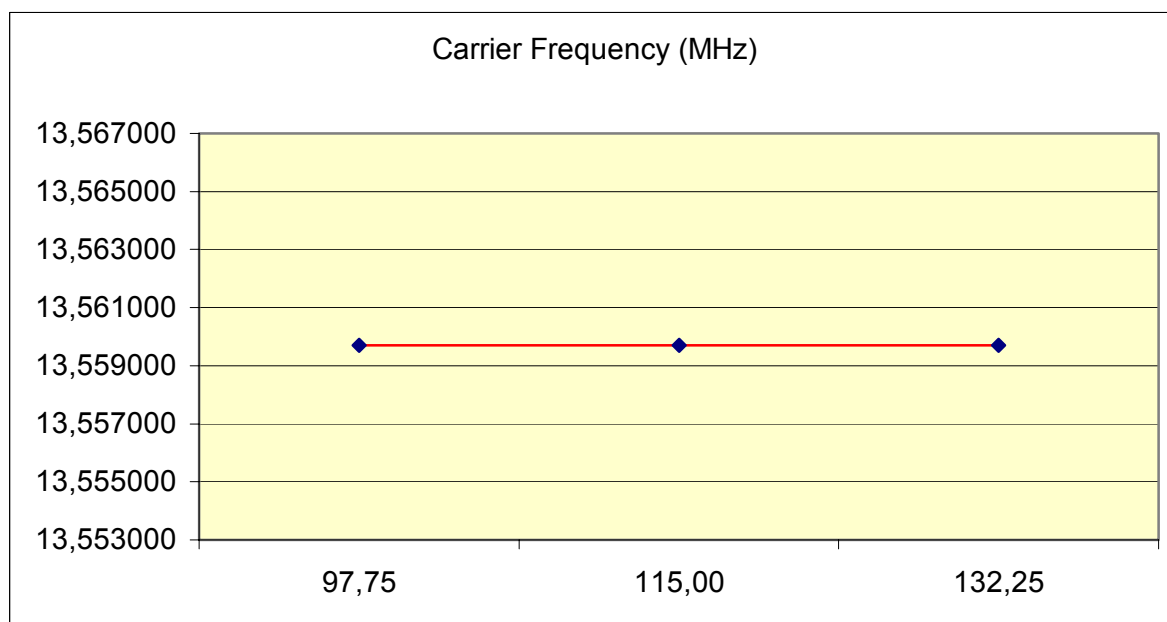

Result: Test passed

12. Charts taken during testing

Conducted Emission Test 150 kHz - 30 MHz according to FCC Rules, section 15.207

Model:
Tigershark

Serial no.:
0001

Applicant:
Texas Instruments Deutschland GmbH

Test site:
Shielded room, cabin no. 2

Tested on:
**Linecord
Neutral Wire**

Date of test: **07/16/2002** Operator:
J. Roidt

Test performed:
automatically File name:

Mode:

Detector:
Average / Final Results: AV

Final results:
20 dB Margin **25 Subranges**

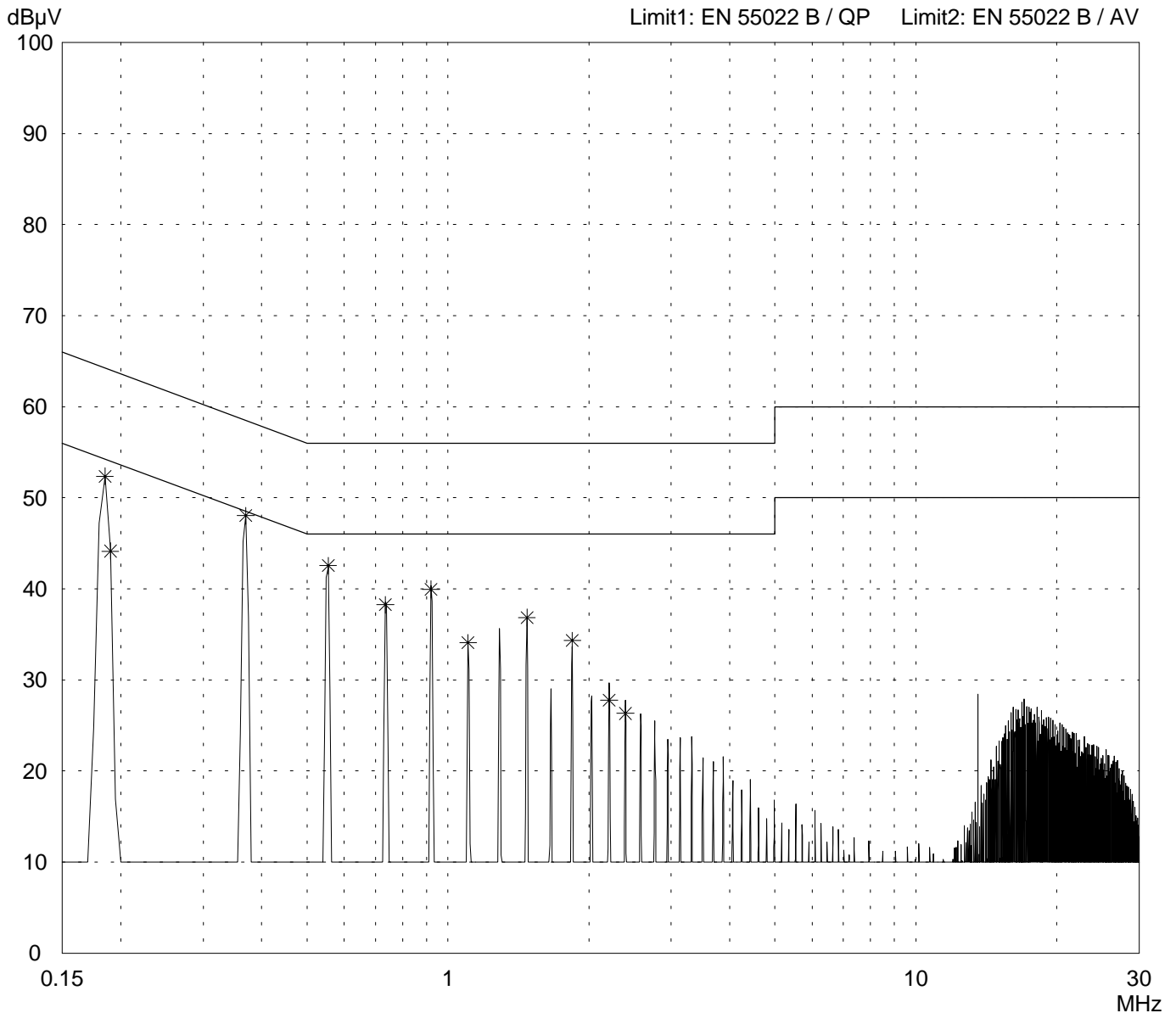

Result:
Limit kept

Project file:
00000-00000 Page of Pages

Conducted Emission Test 150 kHz - 30 MHz according to FCC Rules, section 15.207

Model:
Tigershark

Serial no.:
0001

Applicant:
Texas Instruments Deutschland GmbH

Test site:
Shielded room, cabin no. 2

Tested on:
**Linecord
Life Wire**

Date of test: **07/16/2002** Operator:
J. Roidt

Test performed: **automatically** File name:

Mode:

Detector:
Average / Final Results: AV

Final results:
20 dB Margin **25 Subranges**

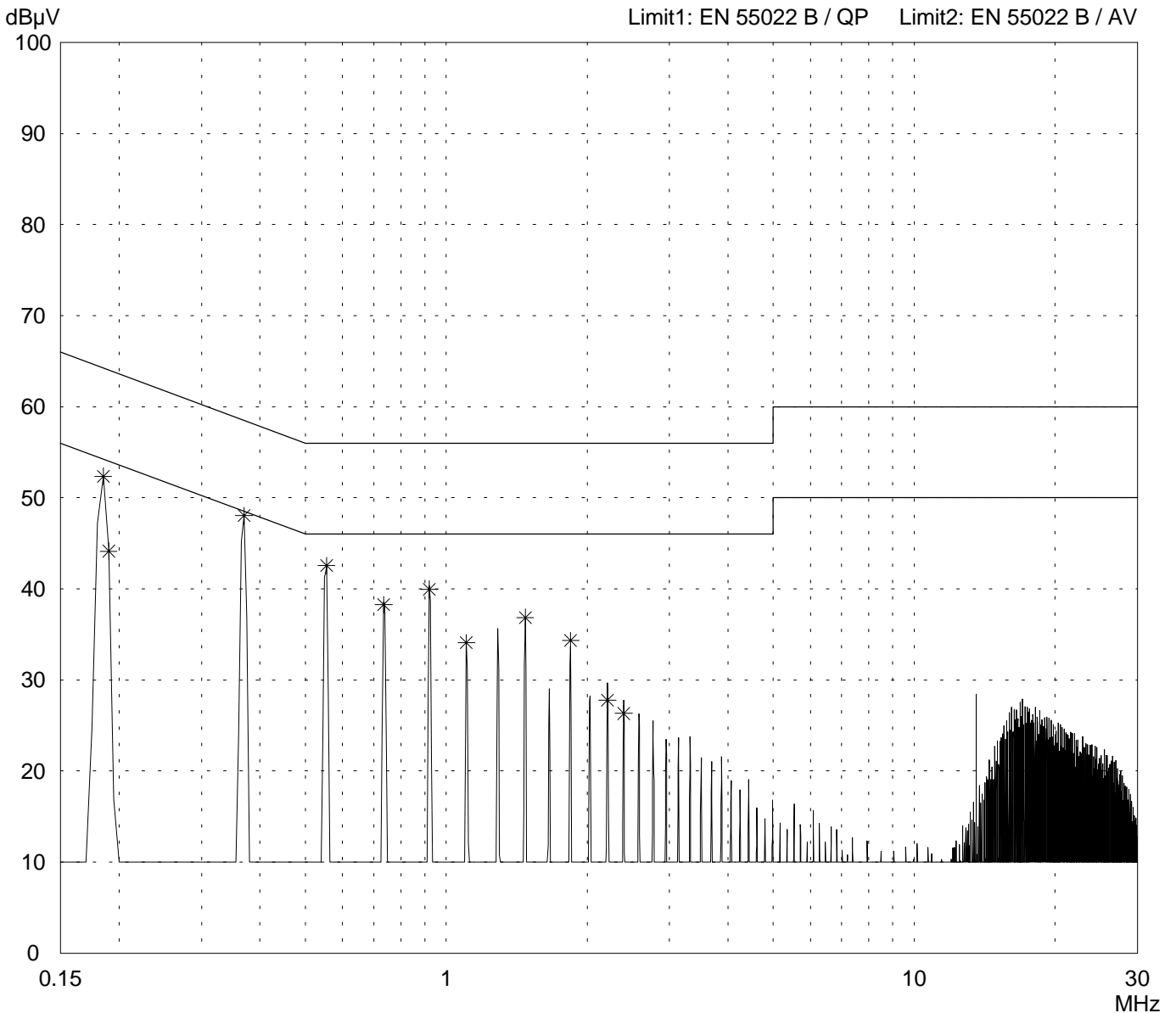

Result:
Limit kept

Project file:
00000-00000 Page of Pages

Conducted Emission Test 150 kHz - 30 MHz according to FCC Rules, section 15.207

Model:
Tigershark

Serial no.:
0001

Applicant:
Texas Instruments Deutschland GmbH

Test site:
Shielded room, cabin no. 2

Tested on:
**Linecord
Neutral Wire**

Date of test: **07/16/2002** Operator:
J. Roidt

Test performed: **automatically** File name:

Mode:

Detector:
Peak / Final Results: QP

Final results:
20 dB Margin **25 Subranges**

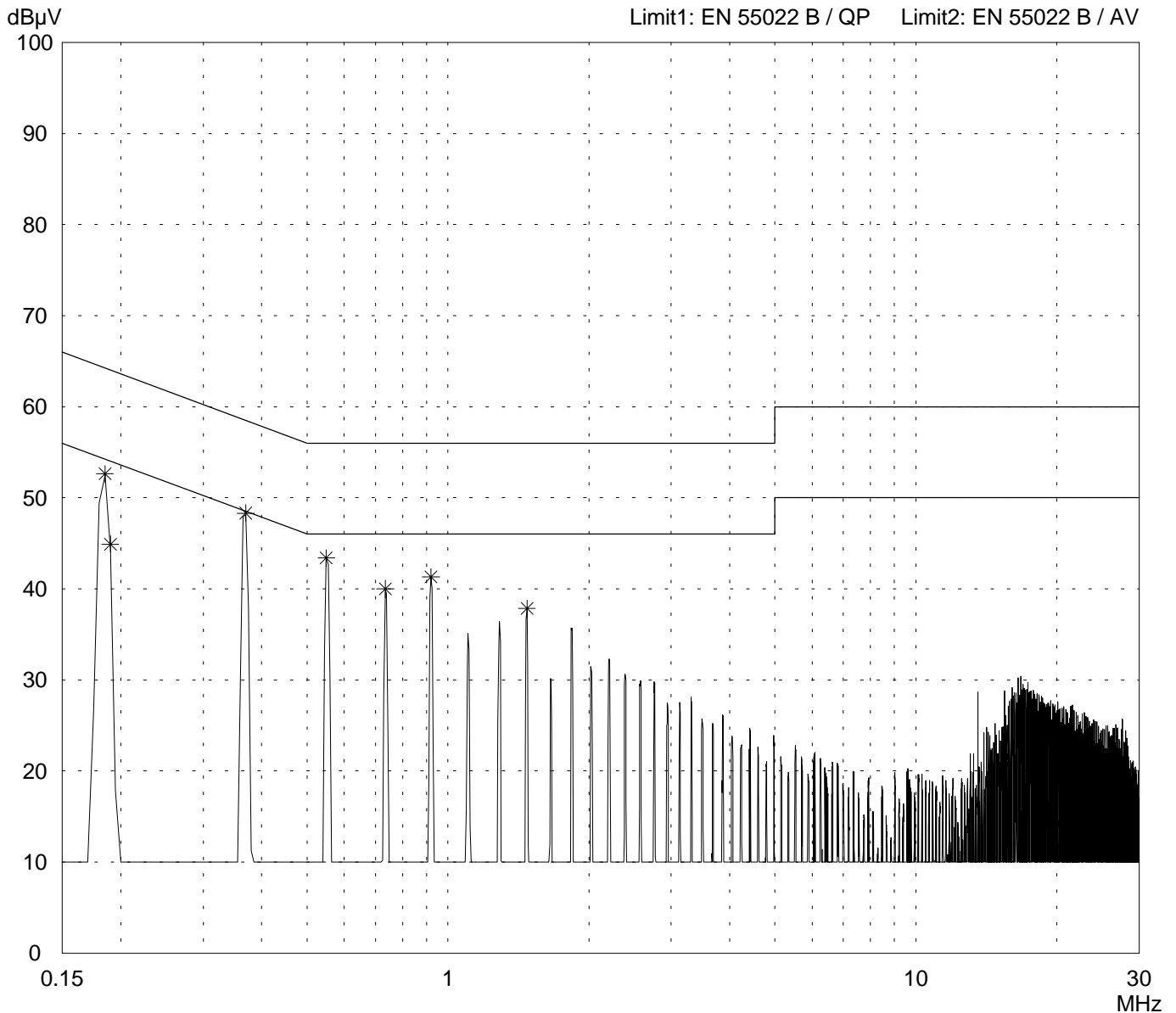

Result:
Limit kept

Project file:
00000-00000 Page of Pages

Conducted Emission Test 150 kHz - 30 MHz according to FCC Rules, section 15.207

Model: Tigershark	
Serial no.: 0001	
Applicant: Texas Instruments Deutschland GmbH	
Test site: Shielded room, cabin no. 2	
Tested on: Linecord Live wire	
Date of test: 07/16/2002	Operator: J. Roidt
Test performed: automatically	File name:

Mode:	
-------	--

Detector: Peak / Final Results: QP
--

Final results: 20 dB Margin	25 Subranges
---------------------------------------	---------------------

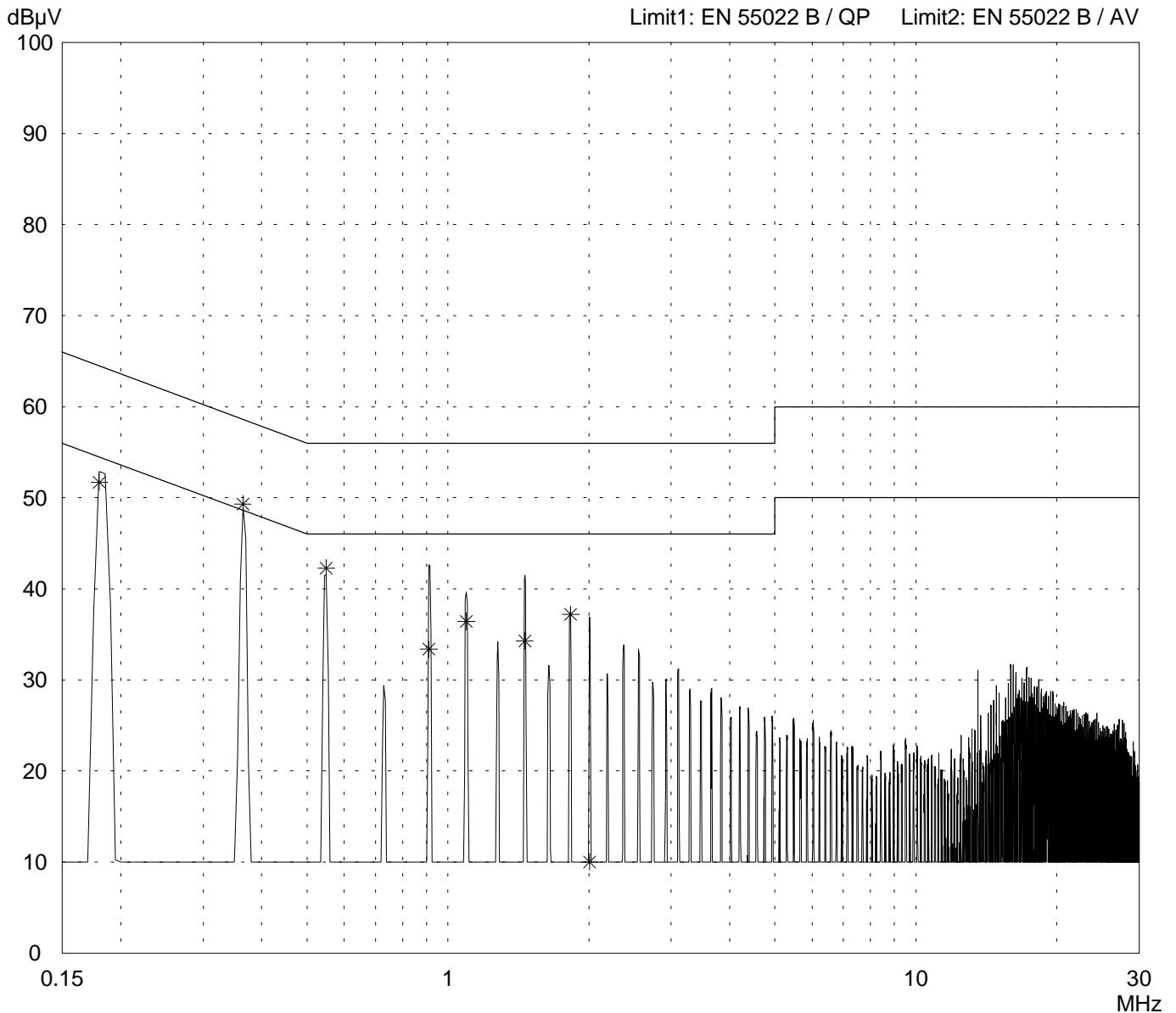

Result: Limit kept

Project file: 00000-00000	Page of Pages
-------------------------------------	---------------------

Radiated Emission Test 9 kHz - 30 MHz according to FCC Rules, section 15.209

Model: Tigershark	
Serial no.: --	
Applicant: Texas Instruments Deutschland GmbH	
Test site: Shielded room, cabin no. 2	
Tested on: Test distance 3 metres Antenna parallel to EUT	
Date of test: 07/15/2002	Operator: T. Eberl
Test performed: automatically	File name:

Mode: - TX mode - FCC test setup	
--	--

Detector: Peak / Final Results: QP
--

Final results: 20 dB Margin	8 Subranges
---------------------------------------	--------------------

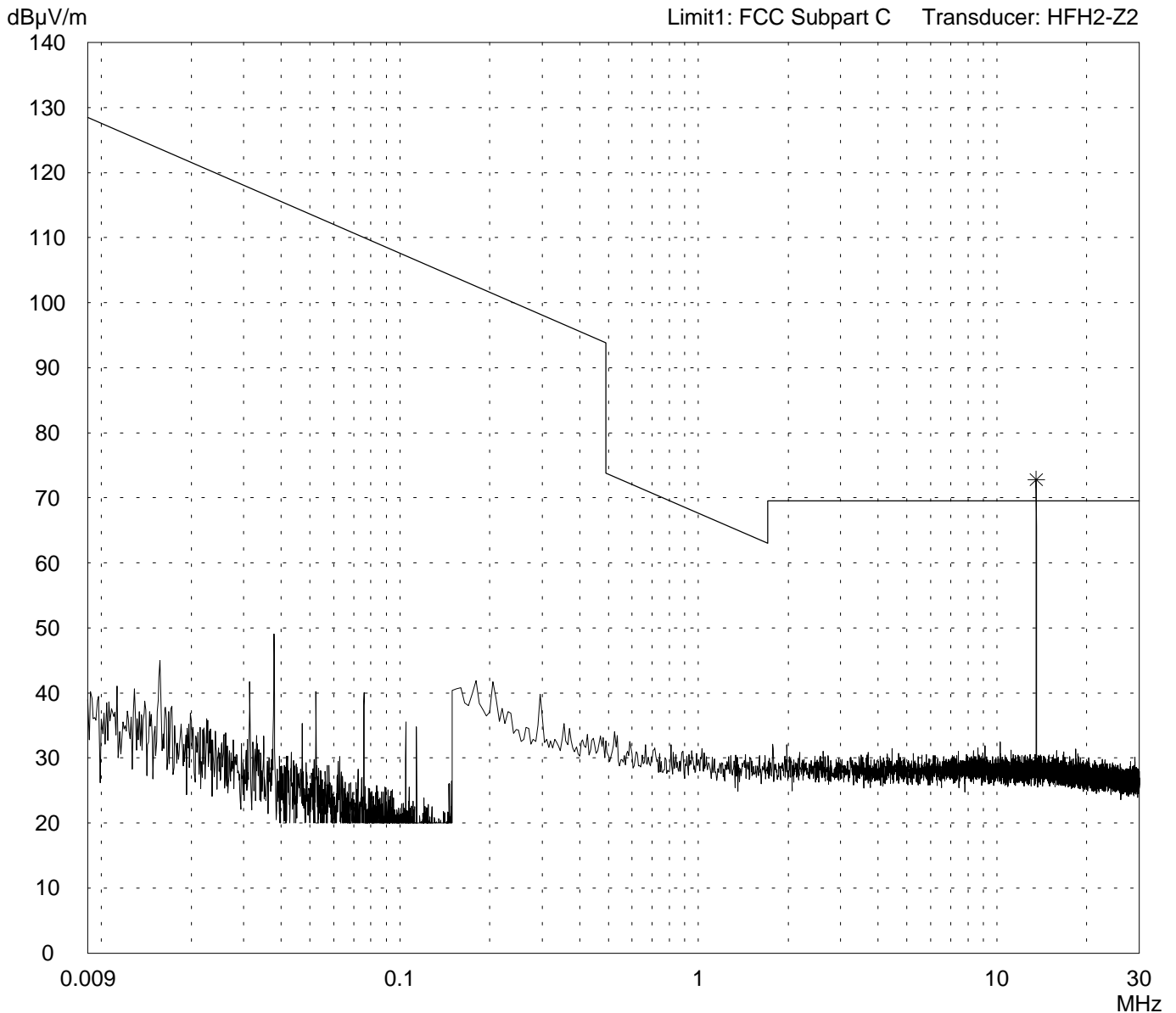

Result: Prescan

Project file: 52226-20430	Page of Pages
-------------------------------------	---------------------

Radiated Emission Test 30 MHz - 200 MHz acc. to FCC Part 15 (Fully Anechoic Chamber)

<p>Model: Tigershark</p> <p>Serial no.: 01</p> <p>Applicant: Texas Instruments Deutschland GmbH</p> <p>Test site: Fully anechoic room</p> <p>Tested on: Test distance 3 metres Horizontal Polarization</p> <p>Date of test: 07/15/2002 Operator: T. Eberl</p> <p>Test performed: automatically File name: default.emi</p>	<p>Comment:</p> <ul style="list-style-type: none"> - TX mode - FCC test setup
--	---

<p>Detector: Peak</p>	<p>List of values: 10 dB Margin 8 Subranges</p>
----------------------------------	---

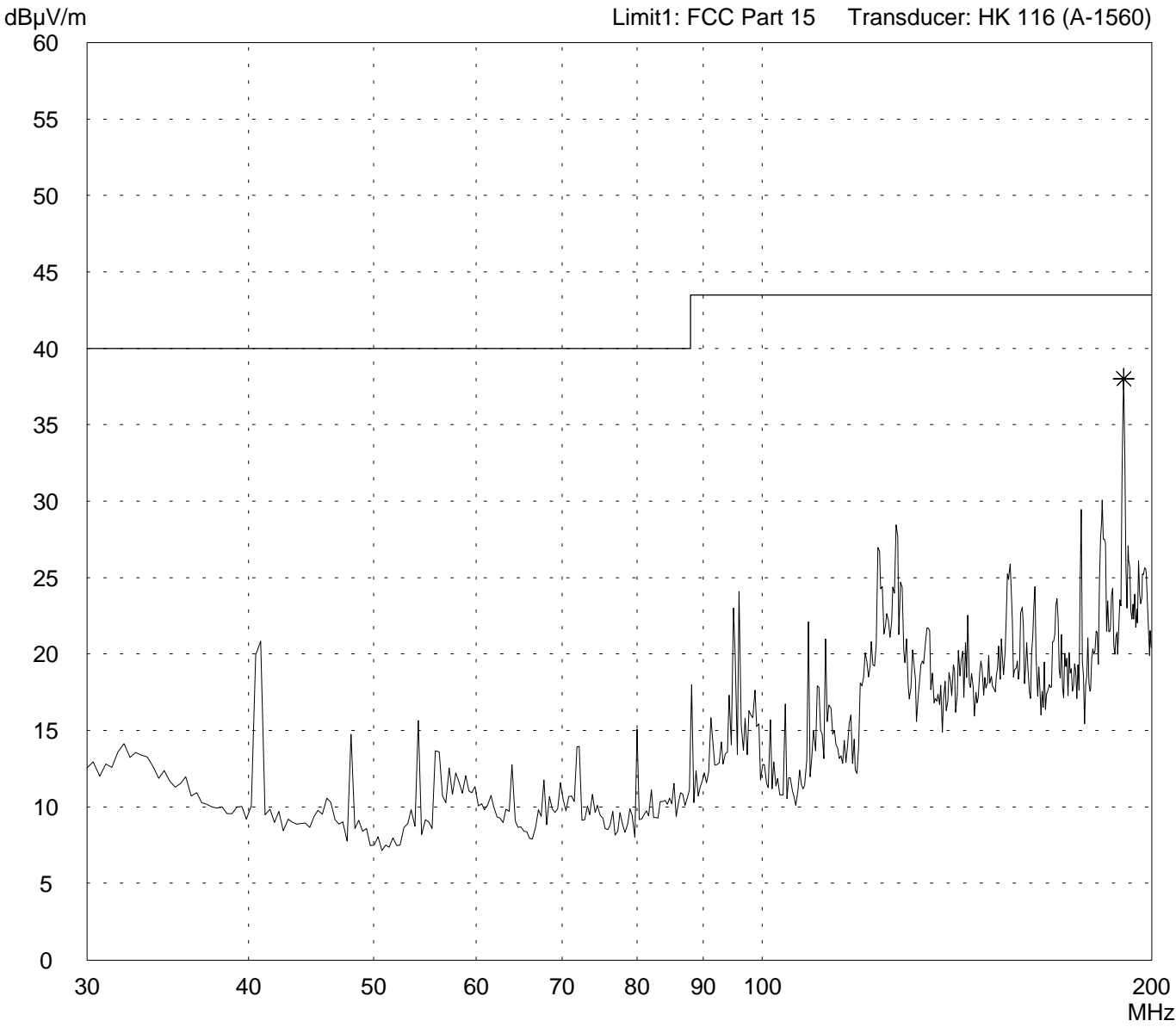

<p>Result: Prescan</p>	<p>Project file: 52226-20430</p> <p style="text-align: right;">Page of Pages</p>
-----------------------------------	---

Radiated Emission Test 30 MHz - 200 MHz acc. to FCC Part 15 (Fully Anechoic Chamber)

<p>Model: Tigershark</p> <p>Serial no.: 01</p> <p>Applicant: Texas Instruments Deutschland GmbH</p> <p>Test site: Fully anechoic room</p> <p>Tested on: Test distance 3 metres Vertical Polarization</p> <p>Date of test: 07/15/2002 Operator: T. Eberl</p> <p>Test performed: automatically File name: default.emi</p>	<p>Comment:</p> <ul style="list-style-type: none"> - TX mode - FCC test setup
--	---

<p>Detector: Peak</p>	<p>List of values: 10 dB Margin 8 Subranges</p>
----------------------------------	---

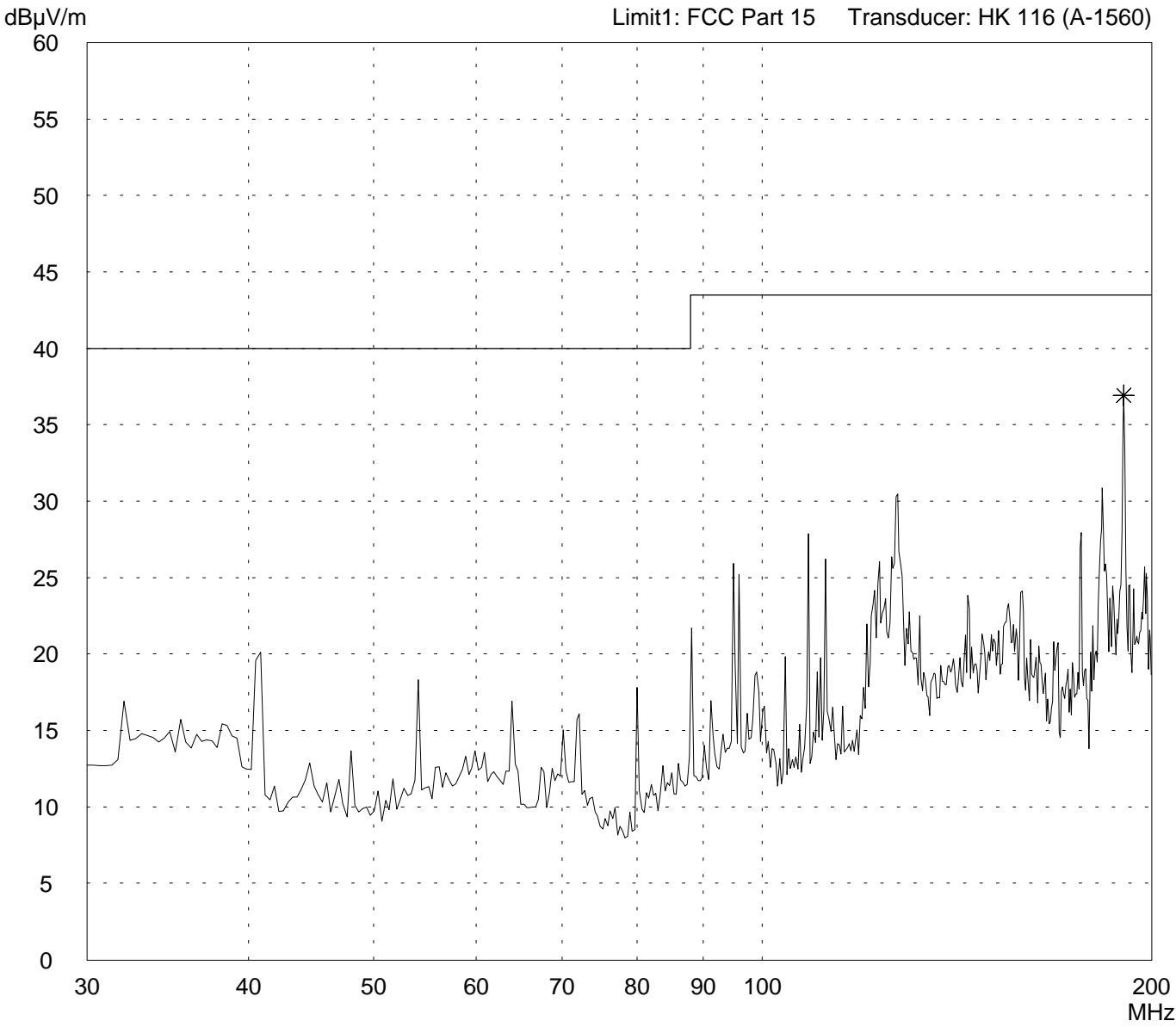

<p>Result: Prescan</p>	<p>Project file: 52226-20430</p> <p style="text-align: right;">Page of Pages</p>
-----------------------------------	---

Radiated Emission Test 200 MHz - 1 GHz acc. to FCC Part 15 (Fully Anechoic Chamber)

<p>Model: Tigershark</p> <p>Serial no.: 01</p> <p>Applicant: Texas Instruments Deutschland GmbH</p> <p>Test site: Fully anechoic room</p> <p>Tested on: Test distance 3 metres Horizontal Polarization</p> <p>Date of test: 07/15/2002 Operator: T. Eberl</p> <p>Test performed: automatically File name: default.emi</p>	<p>Comment:</p> <ul style="list-style-type: none"> - TX mode - FCC test setup
--	---

<p>Detector: Peak</p>	<p>List of values: 10 dB Margin 8 Subranges</p>
----------------------------------	---

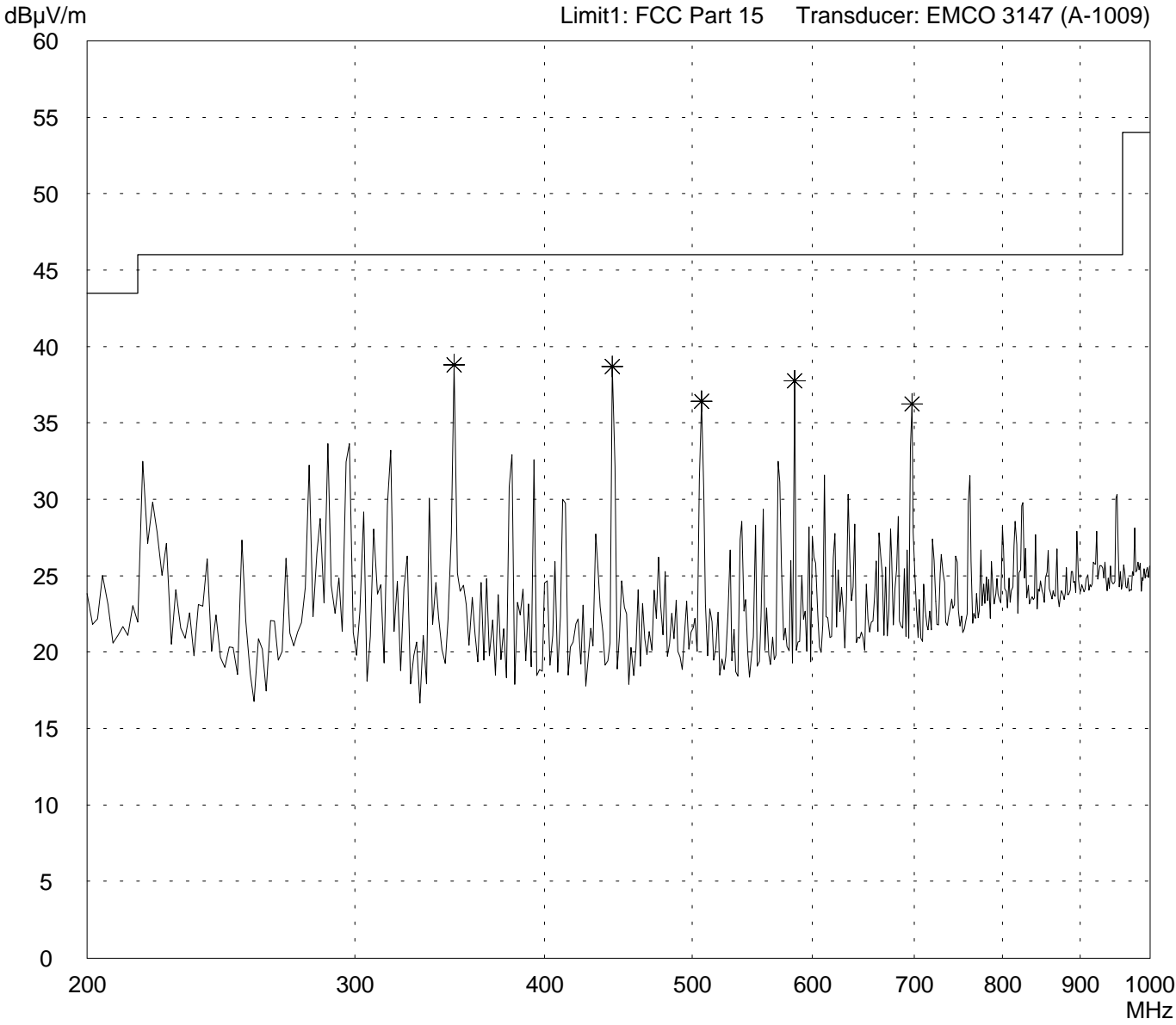

<p>Result: Prescan</p>	<p>Project file: 52226-20430</p> <p style="text-align: right;">Page of Pages</p>
-----------------------------------	---

Radiated Emission Test 200 MHz - 1 GHz acc. to FCC Part 15 (Fully Anechoic Chamber)

<p>Model: Tigershark</p> <p>Serial no.: 01</p> <p>Applicant: Texas Instruments Deutschland GmbH</p> <p>Test site: Fully anechoic room</p> <p>Tested on: Test distance 3 metres Vertical Polarization</p> <p>Date of test: 07/15/2002 Operator: T. Eberl</p> <p>Test performed: automatically File name: default.emi</p>	<p>Comment:</p> <ul style="list-style-type: none"> - TX mode - FCC test setup
--	---

<p>Detector: Peak</p>	<p>List of values: Selected by hand</p>
----------------------------------	--

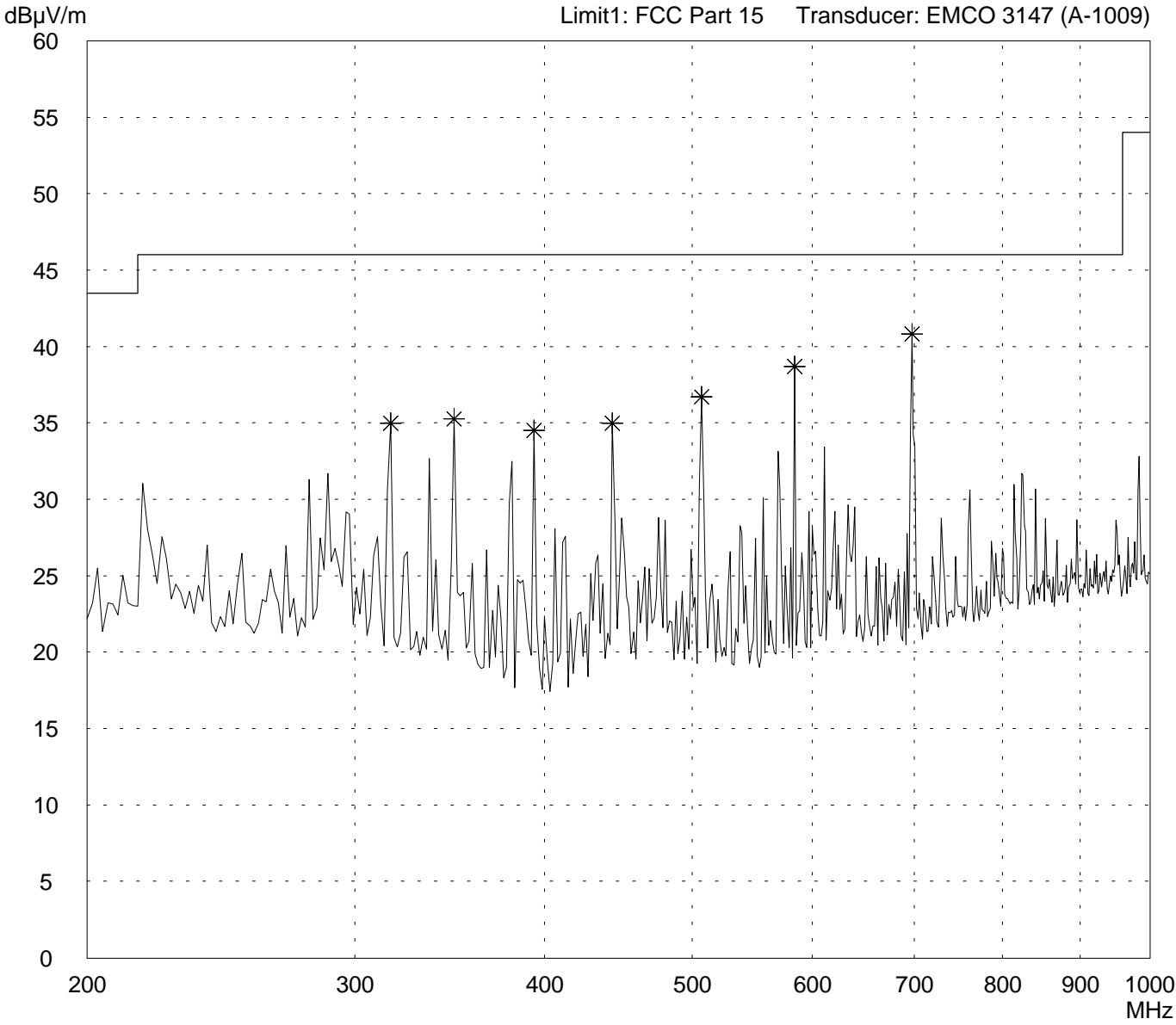

<p>Result: Prescan</p>	<p>Project file: 52226-20430</p> <p style="text-align: right;">Page of Pages</p>
-----------------------------------	---