

TEST REPORT

Report Number: 30353172
Project Number: 3031188 & 3035317
Report Date: December 23, 2002

Testing performed on the

Vicinity Card RFID Reader
Model Number: S6410
Part No: RI-H4RS6H3-00
FCC ID: A92ACS6410

to

FCC Part 15.225

For

Texas Instruments



Test Performed by:
Intertek Testing Services
1365 Adams Court
Menlo Park, CA 94025

Test Authorized by:
Texas Instruments Incorporated
6550 Chase Oaks Blvd, MS8470
Plano, TX 75023



Prepared by: David Chernomordik Date: 12/24/02
David Chernomordik



All services undertaken are subject to the following general policy: Reports are submitted for exclusive use of the client to whom they are addressed. Their significance is subject to the adequacy and representative character of the samples and to the comprehensiveness of the tests, examinations or surveys made. This report shall not be reproduced except in full, without written consent of Intertek Testing Services NA Inc. This report must not be used to claim product endorsement by A2LA, NIST nor any other agency of the U.S. Government.

FCC Part 15.225 Tx Cert, Ver 3/02



Intertek Testing Services NA, Inc.
1365 Adams Court, Menlo Park, CA 94025
Telephone 650-463-2900 Fax 650-463-2910 Home Page www.etlsemko.com



TABLE OF CONTENTS

1.0	Summary of Tests	3
2.0	General Description	4
2.1	Product Description	4
2.2	Related Submittal(s) Grants	5
2.3	Test Methodology	5
2.4	Test Facility	5
3.0	System Test Configuration	6
3.1	Support Equipment and description	6
3.2	Block Diagram of Test Setup	7
3.3	Justification	8
3.4	Software Exercise Program	8
3.5	Mode of operation during test	8
3.6	Modifications required for Compliance	8
3.7	Additions, deviations and exclusions from standards	8
4.0	Measurement Results	9
4.1	Transmitter Radiated Emissions	9
4.2	AC Line Conducted Emission	13
4.3	Occupied Bandwidth and Out-of-band Emission Plots	16
5.0	Frequency Tolerance	24
6.0	List of test equipment	25
7.0	Document History	26

Intertek Testing Services

1.0 Summary of Tests

TEST	REFERENCE	RESULT
Field Strength of Fundamental	15.225(a)	Complies
Radiated Emissions outside the band	15.225(b), 15.209	Complies
Frequency tolerance of the carrier	15.225(c)	Complies
Line Conducted Emissions	15.207	Complies
Antenna requirement	15.203	Not Applicable. The antenna is permanently connected to the transmitter

Intertek Testing Services

2.0 General Description

2.1 Product Description

EUT is an Access Control Reader.

Overview of the EUT

Applicant name & address	Texas Instruments Incorporated 34 Forest Street Attleboro, MA 02703
Contact info	Russ Baumann 508-236-3314, rbaumann@ti.com
Model No. Part No.	Model No: S6410 Part No: RI-H4R-S6H3-00
FCC Identifier	A92ACS6410
Operating Frequency	13.56 MHz
Number of Channels	1 channel
Type of Modulation	FSK, ASK
Modulation depth	100%, 10% - 30%
Operating Temperature	-20 ⁰ C to +70 ⁰ C
Antenna	Integral antenna, loop type,

A prototype version of the EUT was received on October 20, 2002 in good operating condition. As declared by the Applicant, it is identical to production units.

2.2 Related Submittal(s) Grants

This report is for use with an application for certification of a low power transmitter. One transmitter is included in the application.

2.3 Test Methodology

Both AC mains line-conducted and radiated emissions measurements were performed according to the procedures in ANSI C63.4 (1992). Radiated tests were performed at an antenna to EUT distance of 3 meters, unless stated otherwise in the "**Data Sheet**" of this Application. All other measurements were made in accordance with the procedures in part 2 of CFR 47.

2.4 Test Facility

The 10m anechoic chamber and conducted measurement facility used to collect the radiated data is site #1. This test facility and site measurement data have been fully placed on file with the FCC and A2LA accredited.

Intertek Testing Services

3.0 System Test Configuration

3.1 Support Equipment and description

System Support Equipment

Description	Manufacturer	Model Number	Serial Number
Power supply *	Altronix	Model AL624	-
Power supply **	Ceptre	LPS-017	-

* Used for radiated emission test

** Used for conducted emission test

Cables Associated with EUT

Description	Length	Shielding	Ferrites	Connection	
				From	To
DC and I/O cable	8 m	No	No	EUT	DC Power Supply

3.2 Block Diagram of Test Setup

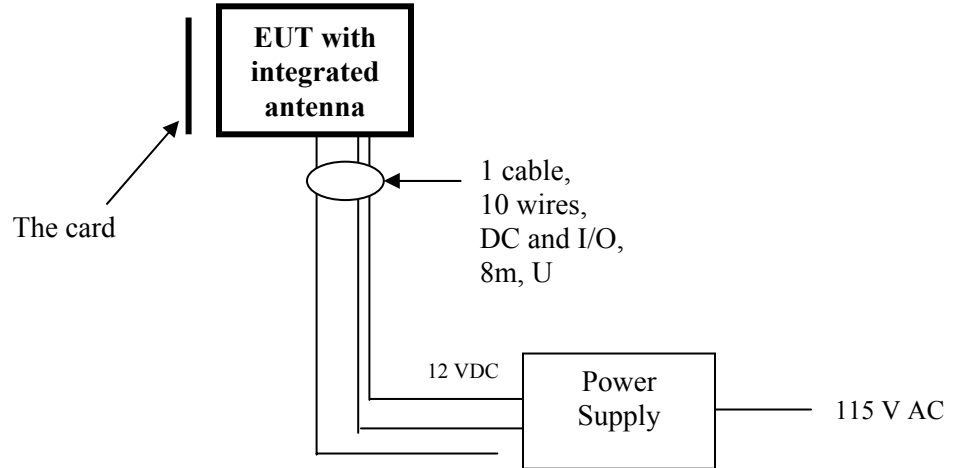

Note: Two I/O wires, green and orange, are connected together, all others are open.

S = Shielded U = Unshielded	F = With Ferrite m = Meter
--	---

3.3 Justification

For emission testing, the test procedures, as described in American National Standards Institute C63.4-1992, were employed. The equipment under test (EUT) was configured for testing in a typical fashion (as a customer would normally use it).

For radiated emission measurements, the EUT is attached to a cardboard box (if necessary) and placed on the wooden turntable. The signal is maximized through rotation and placement in the three orthogonal axes. During testing, all cables were manipulated to produce worst-case emissions.

If the EUT attaches to peripherals, they are connected and operational (as typical as possible). The EUT was wired to transmit full power. Care was taken to ensure proper power supply voltages during testing.

3.4 Software Exercise Program

The EUT exercise program used during radiated and conducted testing was designed to exercise the various system components in a manner similar to a typical use.

3.5 Mode of operation during test

For radiated and AC line conducted emission tests, the EUT was setup to transmit continuously in self-test mode (worst case emissions). For the occupied bandwidth and out-of-band conducted emission tests, the EUT was setup to transmit in normal operation mode, FSK with 20% duty cycle.

3.6 Modifications required for Compliance

No modifications were installed by Intertek Testing Services during compliance testing in order to bring the product into compliance (Please note that this does not include changes made specifically by Taxes Instruments prior to compliance testing).

3.7 Additions, deviations and exclusions from standards

No additions, deviations or exclusion have been made from standard.

4.0 Measurement Results

4.1 Transmitter Radiated Emissions FCC Rules 15.225, 15.209

Requirements

The Field Strength of emissions at fundamental frequency shall not exceed 80 dB ($\mu\text{V}/\text{m}$) at 30m, Emissions radiated outside of the specified frequency band shall not exceed the general radiated emission limits in 15.209.

Procedure

During the test the EUT is rotated and the measuring antenna height and polarization are varied during the search for maximum signal level. The antenna height is varied from 1 to 4 meters.

Radiated emissions are taken at three meters unless the signal level is too low for measurement at that distance. If necessary, a pre-amplifier is used and/or the test is conducted at a closer distance. All readings are extrapolated back to the equivalent three-meter reading using inverse scaling with distance.

Radiated emission measurements were performed from 10 MHz to 1 GHz.
Analyzer resolution is:

9 kHz or greater for frequencies 30 MHz and below
100 kHz or greater for frequencies 1000 MHz and below,
For those frequencies quasi-peak value was measured.

Data is included of the worst-case configuration (the configuration which resulted in the highest emission levels). A sample calculation, configuration photographs and data tables of the emissions are included.

Field Strength Calculation

The field strength is calculated by adding the Antenna Factor and Cable Factor, and subtracting the Amplifier Gain (if any) from the measured reading. The basic equation is as follows:

$$FS = RA + AF + CF - AG$$

Where FS = Field Strength in dB ($\mu\text{V}/\text{m}$)

RA = Receiver Amplitude (including preamplifier) in dB (μV)

CF = Cable Attenuation Factor in dB

AF = Antenna Factor in dB(1/m)

AG = Amplifier Gain in dB

Intertek Testing Services

Test Result

The data below shows the significant emission frequencies, the limit and the margin of compliance.

Radiated emissions at fundamental frequency

Frequency MHz	Antenna Polarization H/V	SA Reading at 10m dB(uV)	Antenna Factor dB(1/m)	Preamp Gain dB	Cable Loss dB	Distance Correct. Factor dB	FS at 30 m dB(uV/m)	FS Limit at 30m dB(uV/m)	Margin dB
13.562	H	43.5	17.5	-	0.5	-20.0	41.5	80.0	-38.5

FS – Field Strength

FS was measured with loop antenna

Spurious Radiated emissions below 30 MHz

Frequency MHz	Antenna Polarization H/V	SA Reading at 10m dB(uV)	Antenna Factor dB(1/m)	Preamp Gain dB	Cable Loss dB	Distance Correct. Factor dB	FS at 30m dB(uV/m)	FS Limit at 30m dB(uV/m)	Margin dB
13.553	-	-	-	-	-	-	11.5 *	29.5	-18.0
13.567	-	-	-	-	-	-	11.5 *	29.5	-18.0
27.1	H	18.0	17.4	-	0.7	-20.0	16.1	29.5	-13.4

Note:

FS was measured with loop antenna

* The FS on the band-edge frequencies was obtained by subtracting “delta” (from plots in sec. 4.3) from the FS on the fundamental frequency.

All other emissions not reported are noise floor, which is at least 20 dB below the limit.

Intertek Testing Services

Spurious Radiated emissions above 30 MHz

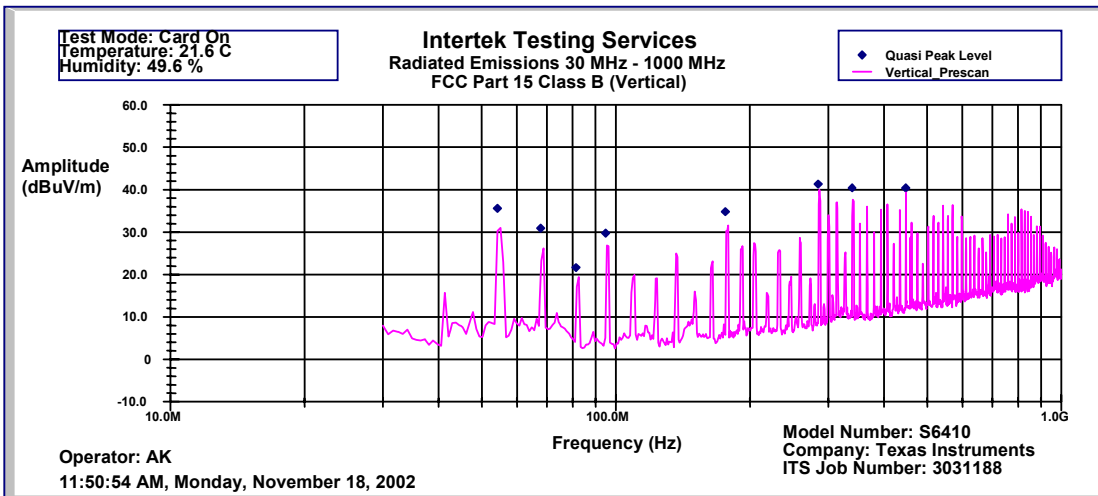
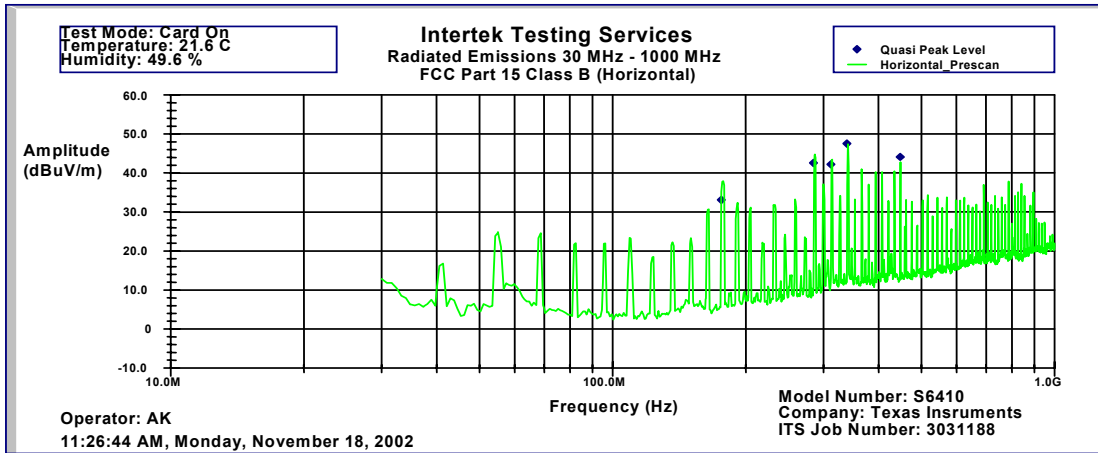

Intertek Testing Services

Spurious Radiated emissions above 30 MHz (Quasi-peak Reading)

Frequency	Antenna Polarization	SA Reading	Detector	Antenna Factor	Preamp Gain	Cable Loss + att.	FS	FS Limit	Margin
MHz	H/V	dB(μ V)	P/Q-P	dB(1/m)	dB	DB	dB(μ V/m)	dB(μ V/m)	dB
54.25	V	58.9	Q-P	5.3	32.3	3.7	35.5	40.0	-4.5
67.81	V	53.3	Q-P	6.0	32.3	3.9	30.9	40.0	-9.1
94.93	V	50.8	Q-P	7.4	32.3	3.9	29.7	43.4	-13.8
176.30	H	52.0	Q-P	9.1	32.3	4.3	33.1	43.5	-10.4
284.79	H	57.3	Q-P	13.0	32.2	4.5	42.5	46.0	-3.5
311.92	H	55.3	Q-P	14.2	32.2	5.0	42.2	46.0	-3.8
339.04	H	57.6	Q-P	15.5	32.2	4.7	47.5	46.0	-0.5
447.53	H	54.4	Q-P	17.2	32.3	4.9	44.1	46.0	-1.9

FS = Field Strength

P = Peak

Q-P = Quasi-Peak

The EUT passed by 38.5 dB at fundamental frequency and by 0.5 dB at spurious emission frequencies.

Intertek Testing Services

4.2 AC Line Conducted Emission FCC Rule 15.207

AC line conducted emission test was performed according the ANSI C63.4 standard. The EUT was connected to DC Power Supply, which was connected to AC Line through the LISN.

A complete scan from 0.15 - 30 MHz was made according to the FCC 02-157 (ET Docket 98-80)..

For the test result, see the attached plots 2.1, 2.2.
The EUT passed the test by 6 dB.

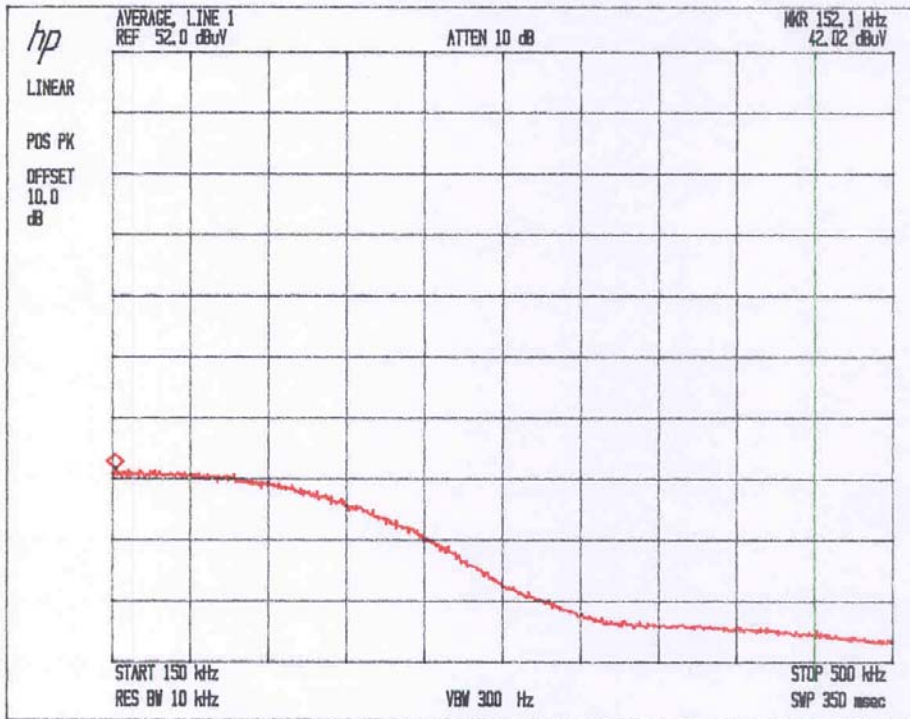
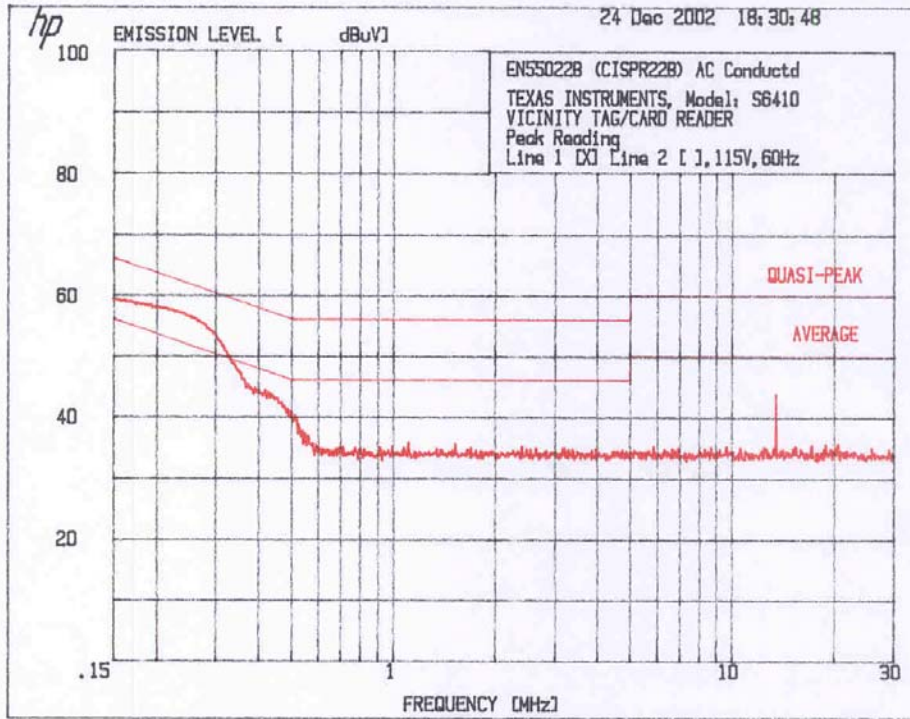

Intertek Testing Services

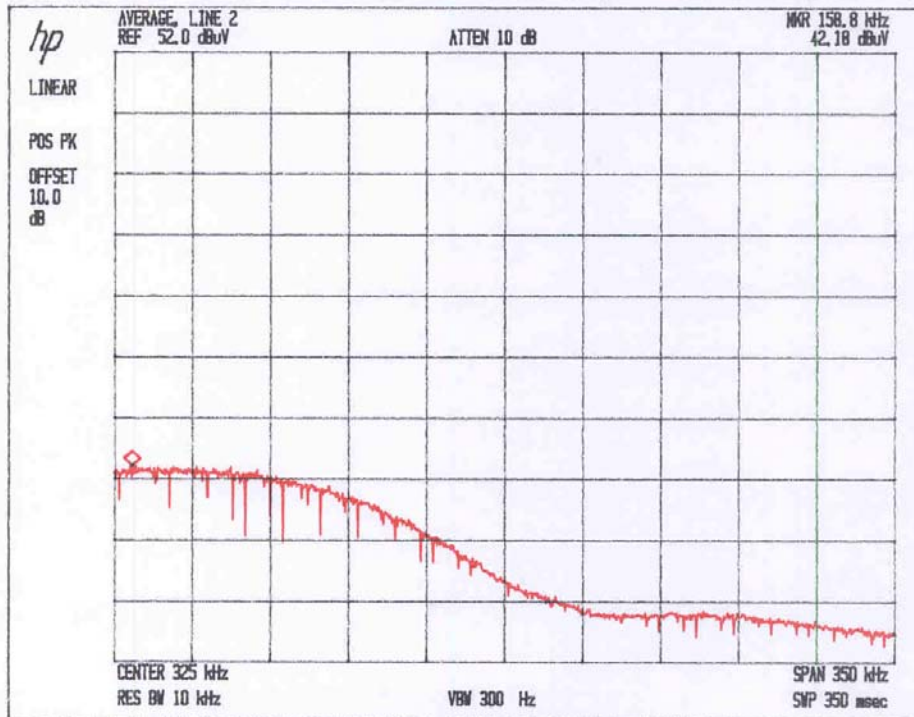
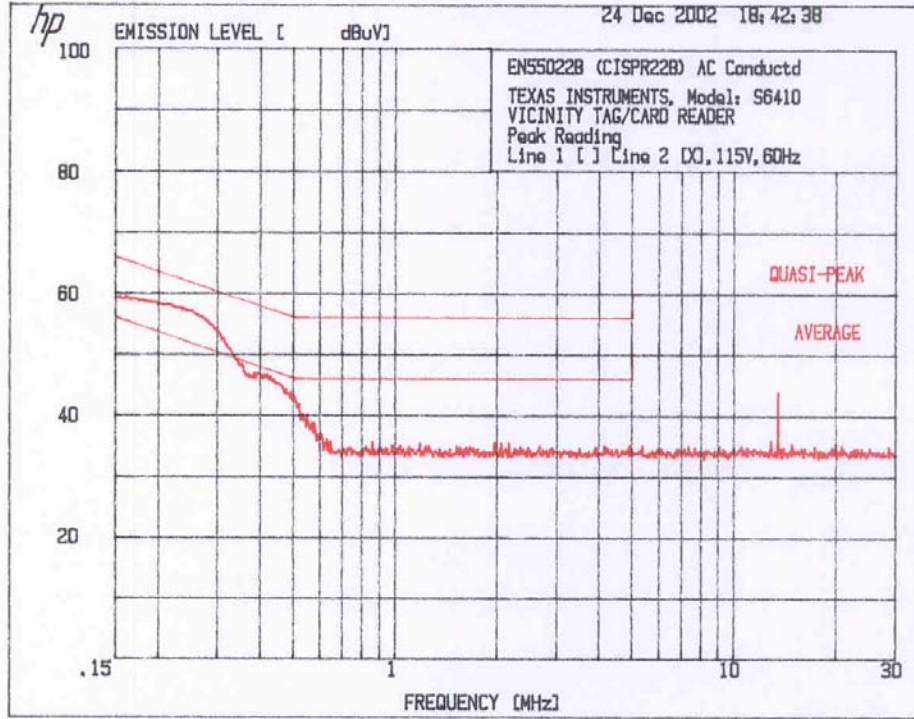

Intertek Testing Services

4.3 Occupied Bandwidth and Out-of-band Emission Plots

The EUT was setup to transmit in normal operating condition with 20% duty cycle.

A Spectrum Analyzer was connected to the output of the transmitter (antenna disconnected). The spectrum analyzer reading was plotted. The following plots show the in-band and out-of-band emissions.

Plot #	Description
1	In-band emission, RBW=100 Hz
2	In-band emission, RBW=100 Hz, MAX HOLD
3	In-band emission, RBW=300 Hz, MAX HOLD
4	Out-of-band emission, scan 10 MHz to 12 MHz
5	Out-of-band emission, scan 12 MHz to 13.553 MHz
6	Out-of-band emission, scan 13.567 MHz to 15 MHz
7	Out-of-band emission, scan 15 MHz to 30 MHz

The 20-dB bandwidth is about 140 Hz.

The emissions on the band-edge frequencies (see plots #2 and #3) are more than 30 dB below the level on fundamental frequency.

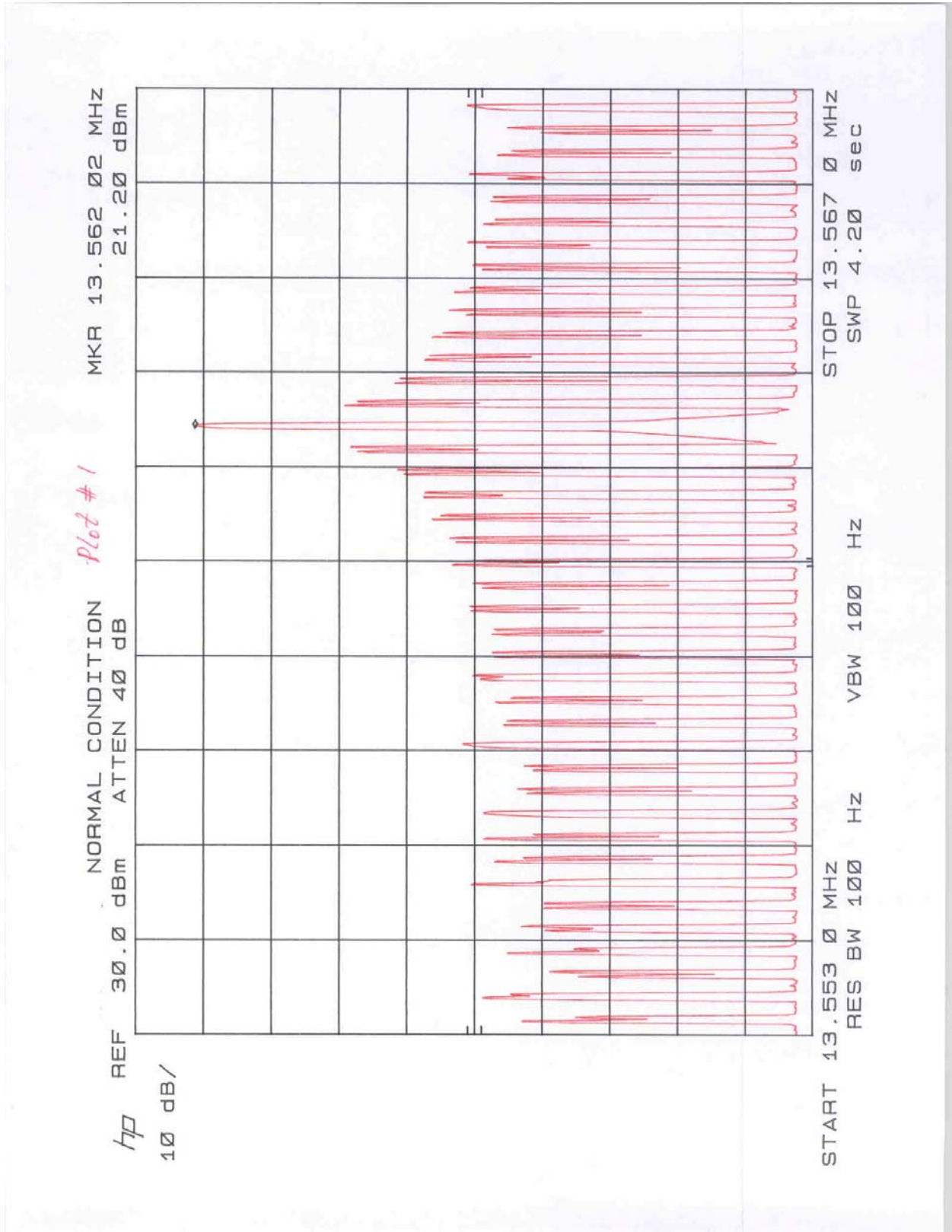

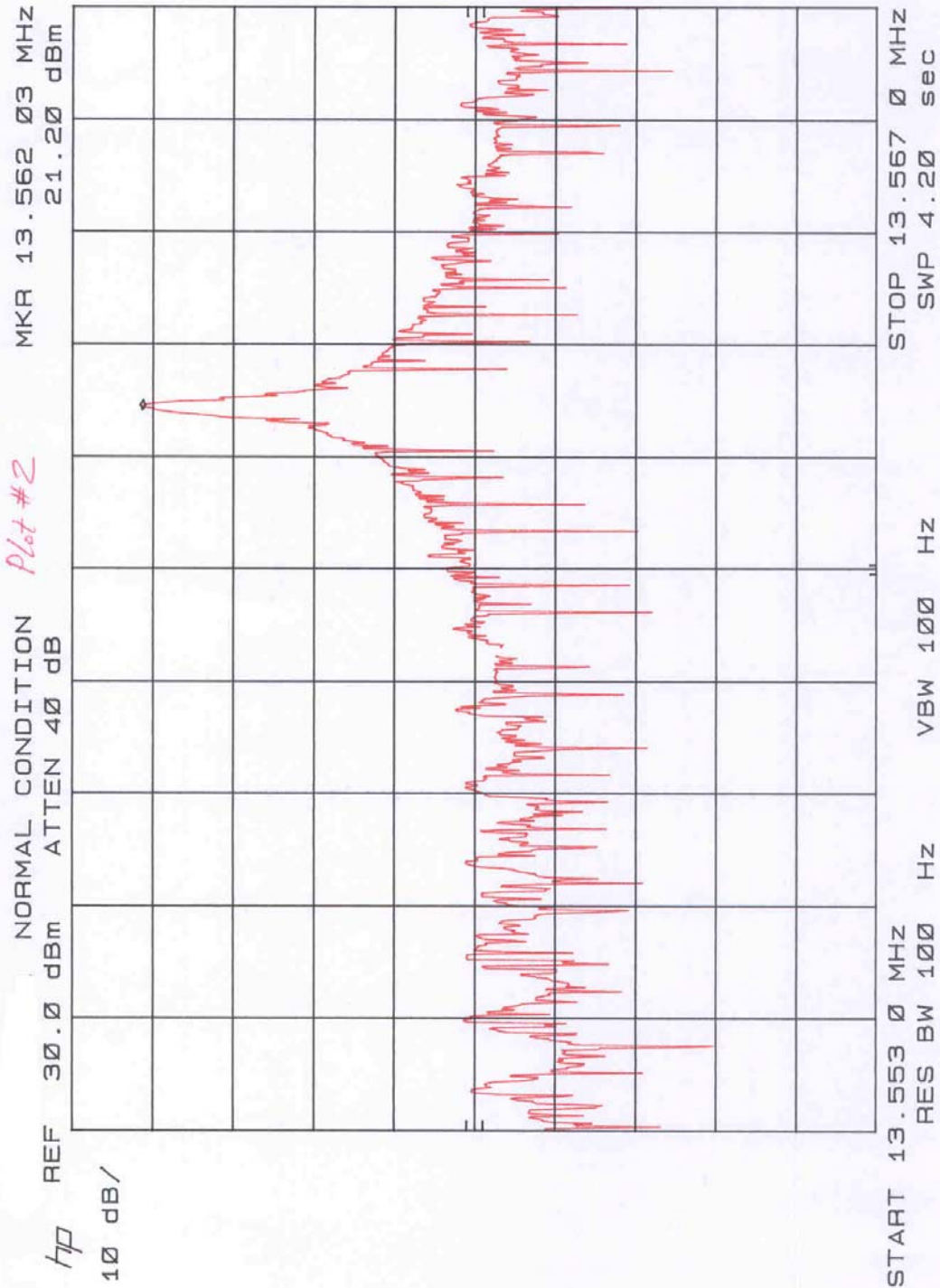

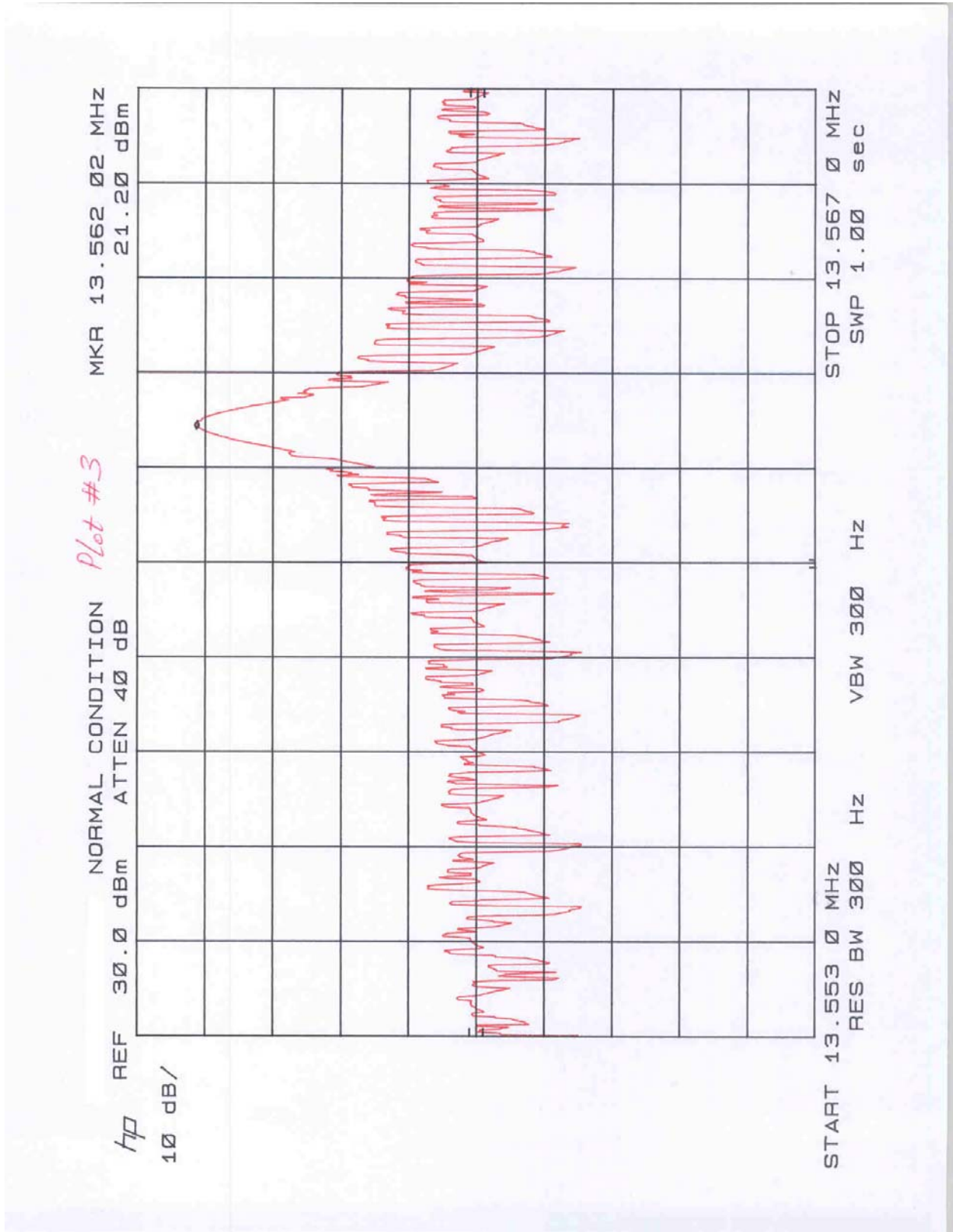

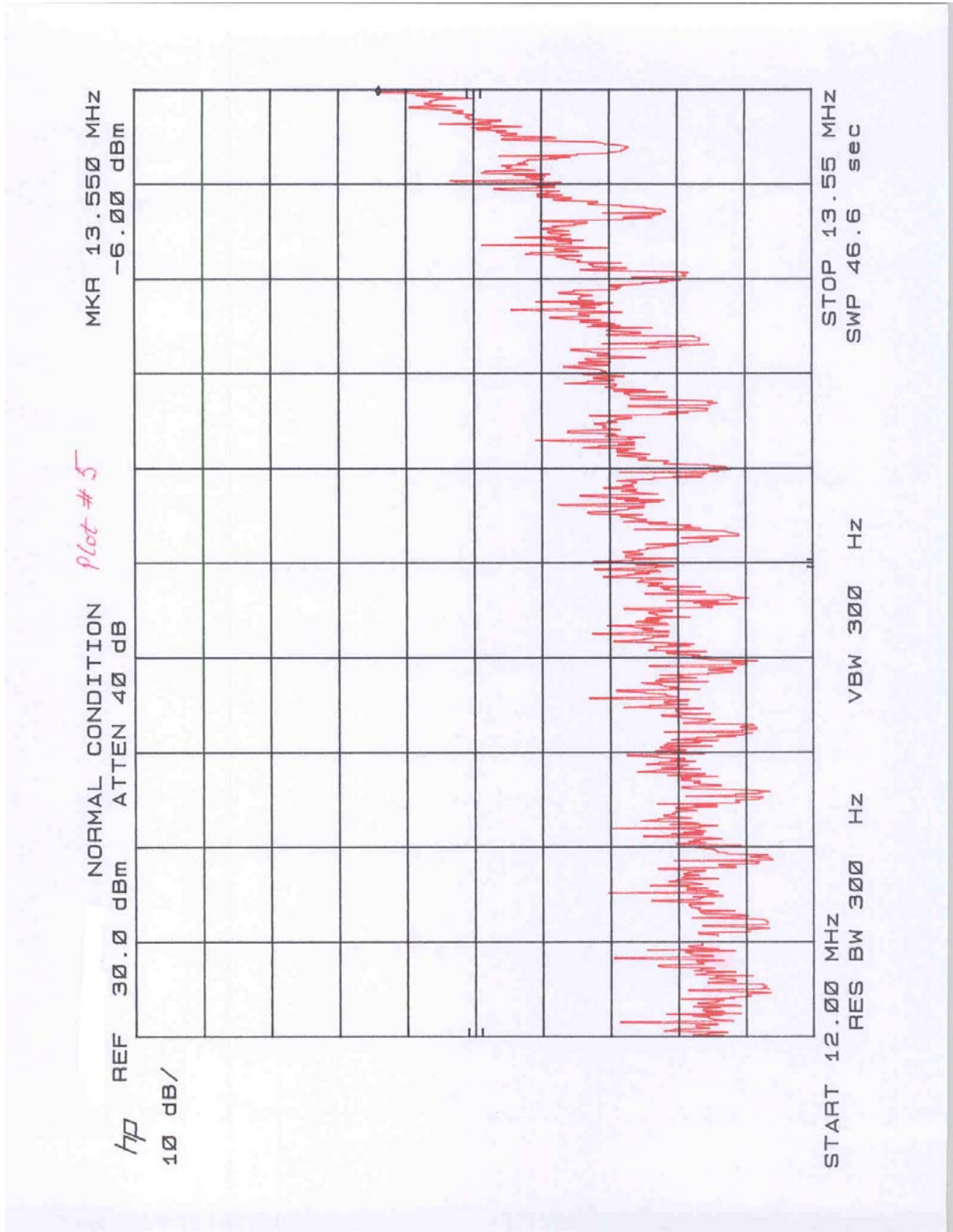

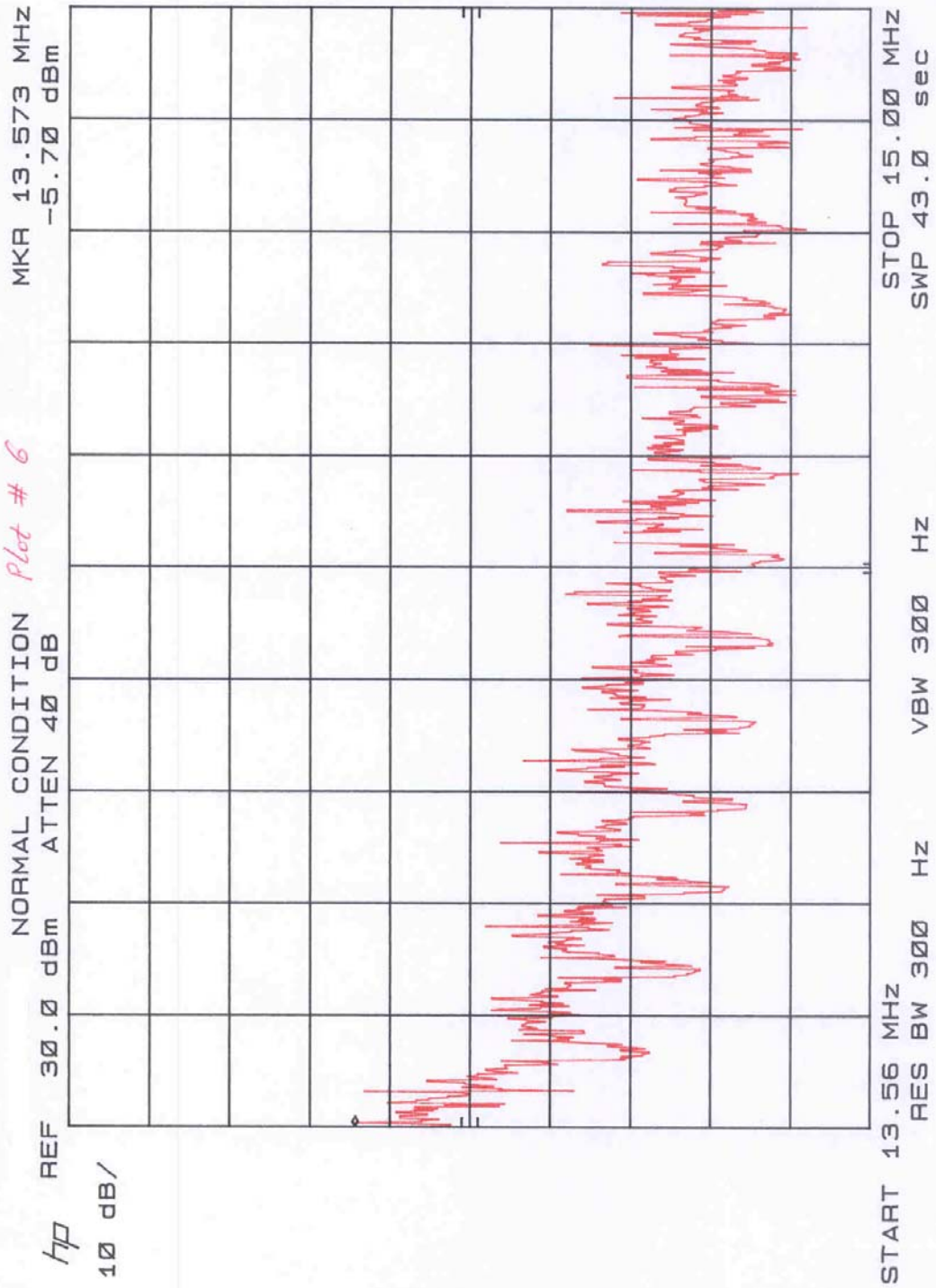

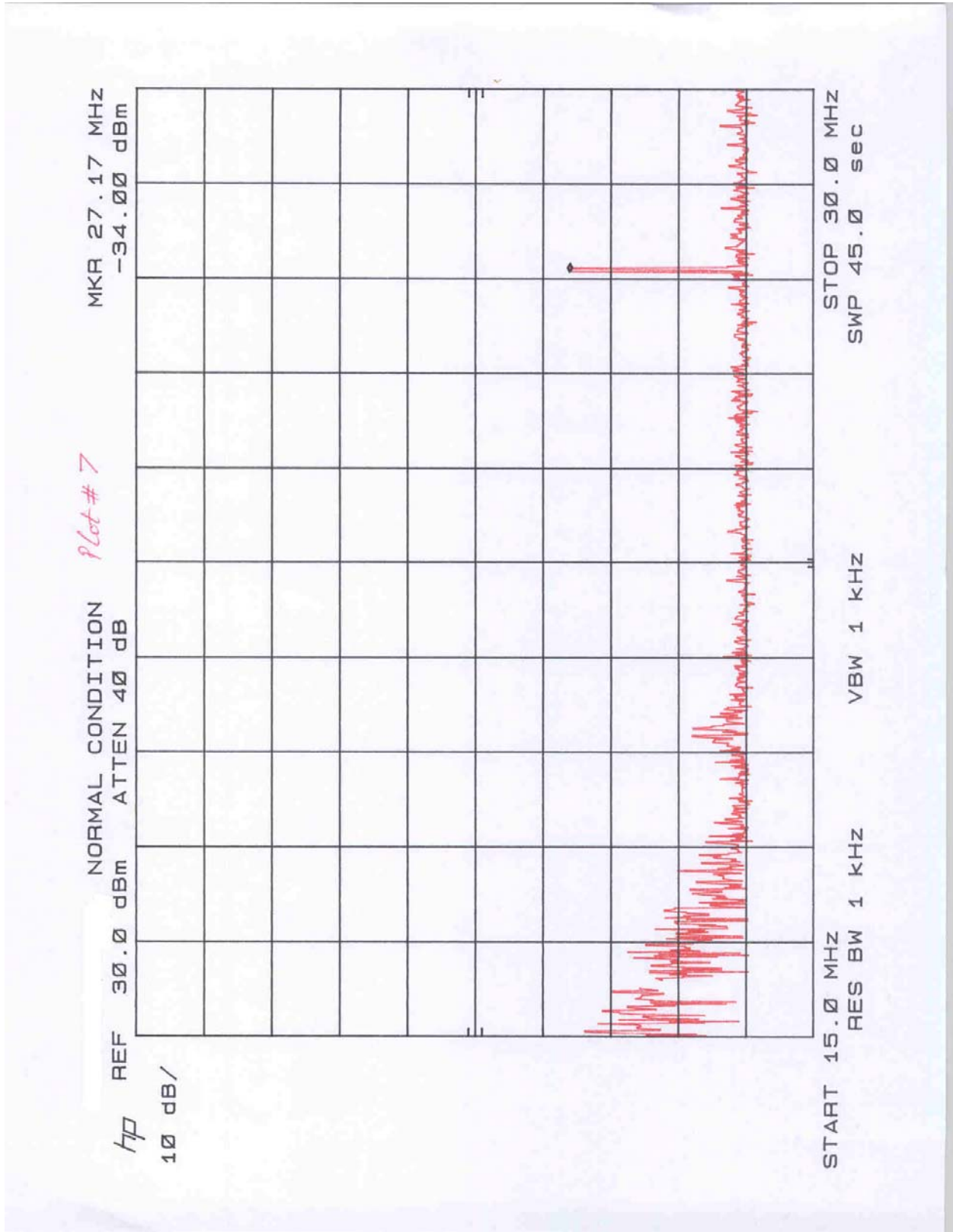

5.0 Frequency Tolerance

Requirement

The frequency tolerance of the carrier signal shall be maintained within $\pm 0.01\%$ of the operating frequency over a temperature variation of -20°C to $+50^{\circ}\text{C}$ at normal supply voltage, and for a variation in the primary supply voltage from 85% to 115% of the rated supply voltage at a temperature of $+20^{\circ}\text{C}$.

Procedure

The EUT was placed in the temperature chamber and set to transmit unmodulated carrier. The transmitter was powered from a DC power supply (12 VDC). The frequency counter was connected to the transmitter output. For each temperature, the carrier frequency was recorded. In addition, the carrier frequency was recorded when the power was set to 16.1 VDC (115% of the maximum specified voltage – 14 VDC) and to 5.1 VDC (85% of the minimum specified voltage – 6VDC).

Result

Nominal Frequency: 13.562000 Hz

Temperature, $^{\circ}\text{C}$	Measured Frequency, Hz	Measured Frequency, Hz	Measured Frequency, Hz	Maximum difference, Hz
	12 VDC	16.1 VDC	5.1 VDC	
+50	13.561920			-80
+40	13.561945			-55
+30	13.561978			-22
+20	13.562002	13.561975	13.561985	-25
+10	13.562040			40
0	13562060			60
-10	13.562060			60
-20	13.562045			45

The frequency tolerance is within -0.0006% to 0.0004% .

Intertek Testing Services

6.0 List of test equipment

Measurement equipment used for emission compliance testing utilized the equipment on the following list:

Equipment	Manufacturer	Model/Type	Serial #	Cal Int	Cal Due
Bi-Log Antenna	EMCO	3143	9509-1160	12	9/19/03
Loop Antenna	EMCO	6507	9012-1259	12	5/12/03
Pre-Amplifier	Sonoma Inst.	310	185634	12	4/30/03
RF Filter Section	Hewlett Packard	85460A	3448A00267	12	7/16/03
EMI Receiver	Hewlett Packard	8546A	3710A00373	12	7/16/03
Spectrum Analyzer w/85650 QP Adapter	Hewlett Packard	8566B	2416A00317 2043A00251	12	4/06/03

7.0 Document History

Revision/ Job Number	Writer Initials	Date	Change
1.0 / 30353172	DC	December 16, 2002	Original document