

<b>Prüfbericht-Nr.:</b> <i>Test Report No.:</i>	<b>10052793 001</b>	<b>Auftrags-Nr.:</b> <i>Order No.:</i>	<b>114039665</b>	Seite 1 von 32 <i>Page 1 of 32</i>
<b>Kunden-Referenz-Nr.:</b> <i>Client Reference No.:</i>	N/A	<b>Auftragsdatum:</b> <i>Order date:</i>	20-Aug-2015	
<b>Auftraggeber:</b> <i>Client:</i>	Microchip Technology Inc., 2355 West Chandler Blvd. Chandler, Arizona 85224-6199, United States			
<b>Prüfgegenstand:</b> <i>Test item:</i>	Bluetooth module			
<b>Bezeichnung / Typ-Nr.:</b> <i>Identification / Type No.:</i>	BM78abcdefgh, RN4678			
<b>Auftrags-Inhalt:</b> <i>Order content:</i>	FCC Part15C / IC RSS-247 Test report (BLE)			
<b>Prüfgrundlage:</b> <i>Test specification:</i>	FCC 47CFR Part 15: Subpart C Section 15.247 RSS-247 (05-2015)			
<b>Wareneingangsdatum:</b> <i>Date of receipt:</i>	23-Aug-2015			
<b>Prüfmuster-Nr.:</b> <i>Test sample No.:</i>	A000244783-005 A000244783-006			
<b>Prüfzeitraum:</b> <i>Testing period:</i>	2-Sep-2015 - 8-Sep-2015			
<b>Ort der Prüfung:</b> <i>Place of testing:</i>	EMC/RF Laboratory Taipei			
<b>Prüflaboratorium:</b> <i>Testing laboratory:</i>	TUV Rheinland Taiwan Ltd.			
<b>Prüfergebnis*:</b> <i>Test result*:</i>	Pass			
<b>geprüft von / tested by:</b>		<b>kontrolliert von / reviewed by:</b>		
2015-09-10 Ryan W. T. Chen / Project Engineer		2015-09-10 Rene Charton / Senior Project Manager		
<i>Date</i>	<i>Name / Stellung</i>	<i>Unterschrift</i>	<i>Date</i>	<i>Name / Stellung</i>
<b>Sonstiges / Other:</b>				
FCC Model name: BM78abcdefgh (0~9/A~Z) RN4678 is identical to the model BM78abcdefgh, due to Market Strategy				
<b>Zustand des Prüfgegenstandes bei Anlieferung:</b> <i>Condition of the test item at delivery:</i>		Prüfmuster vollständig und unbeschädigt <i>Test item complete and undamaged</i>		
* Legende: 1 = sehr gut 2 = gut 3 = befriedigend 4 = ausreichend 5 = mangelhaft P(ass) = entspricht o.g. Prüfgrundlage(n) F(ail) = entspricht nicht o.g. Prüfgrundlage(n) N/A = nicht anwendbar N/T = nicht getestet				
Legend: 1 = very good 2 = good 3 = satisfactory 4 = sufficient 5 = poor P(ass) = passed a.m. test specification(s) F(ail) = failed a.m. test specification(s) N/A = not applicable N/T = not tested				
Dieser Prüfbericht bezieht sich nur auf das o.g. Prüfmuster und darf ohne Genehmigung der Prüfstelle nicht auszugsweise vervielfältigt werden. Dieser Bericht berechtigt nicht zur Verwendung eines Prüfzeichens. <i>This test report only relates to the a. m. test sample. Without permission of the test center this test report is not permitted to be duplicated in extracts. This test report does not entitle to carry any test mark.</i>				

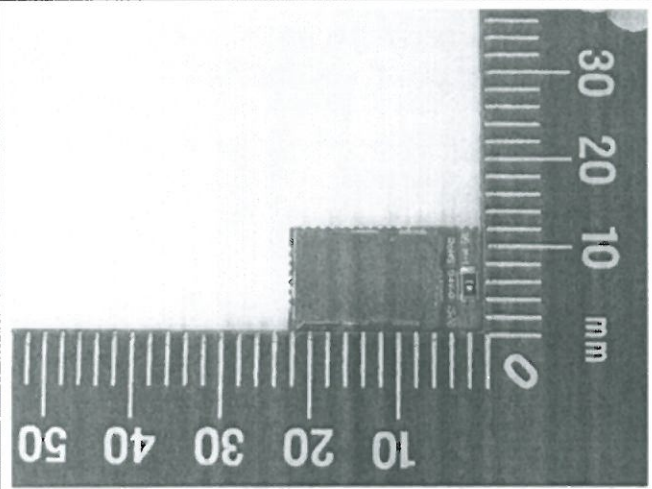

## TEST SUMMARY

**5.1.1 ANTENNA REQUIREMENT***RESULT: Passed***5.1.2 PEAK OUTPUT POWER***RESULT: Passed***5.1.3 6dB BANDWIDTH***RESULT: Passed***5.1.4 POWER DENSITY***RESULT: Passed***5.1.5 CONDUCTED SPURIOUS EMISSIONS AND FREQUENCY BAND EDGE MEASURED IN  
100kHz BANDWIDTH***RESULT: Passed***5.1.6 SPURIOUS EMISSION***RESULT: Passed***5.2.1 MAINS CONDUCTED EMISSIONS***RESULT: Passed***6.1.1 ELECTROMAGNETIC FIELDS***RESULT: Passed*

## Contents

<b>1.</b>	<b>GENERAL REMARKS .....</b>	<b>4</b>
<b>1.1</b>	<b>COMPLEMENTARY MATERIALS.....</b>	<b>4</b>
<b>2.</b>	<b>TEST SITES .....</b>	<b>5</b>
<b>2.1</b>	<b>TEST LABORATORY .....</b>	<b>5</b>
<b>2.2</b>	<b>TEST FACILITY.....</b>	<b>5</b>
<b>2.3</b>	<b>LIST OF TEST AND MEASUREMENT INSTRUMENTS.....</b>	<b>6</b>
<b>2.4</b>	<b>TRACEABILITY .....</b>	<b>7</b>
<b>2.5</b>	<b>CALIBRATION .....</b>	<b>7</b>
<b>2.6</b>	<b>MEASUREMENT UNCERTAINTY .....</b>	<b>7</b>
<b>3.</b>	<b>GENERAL PRODUCT INFORMATION.....</b>	<b>8</b>
<b>3.1</b>	<b>PRODUCT FUNCTION AND INTENDED USE .....</b>	<b>8</b>
<b>3.2</b>	<b>SYSTEM DETAILS AND RATINGS.....</b>	<b>8</b>
<b>3.3</b>	<b>INDEPENDENT OPERATION MODES.....</b>	<b>9</b>
<b>3.4</b>	<b>NOISE GENERATING AND NOISE SUPPRESSING PARTS .....</b>	<b>9</b>
<b>3.5</b>	<b>SUBMITTED DOCUMENTS.....</b>	<b>9</b>
<b>4.</b>	<b>TEST SET-UP AND OPERATION MODES.....</b>	<b>10</b>
<b>4.1</b>	<b>PRINCIPLE OF CONFIGURATION SELECTION .....</b>	<b>10</b>
<b>4.2</b>	<b>TEST OPERATION AND TEST SOFTWARE.....</b>	<b>10</b>
<b>4.3</b>	<b>SPECIAL ACCESSORIES AND AUXILIARY EQUIPMENT .....</b>	<b>10</b>
<b>4.4</b>	<b>COUNTERMEASURES TO ACHIEVE EMC COMPLIANCE.....</b>	<b>11</b>
<b>4.5</b>	<b>TEST SETUP DIAGRAM .....</b>	<b>11</b>
<b>5.</b>	<b>TEST RESULTS .....</b>	<b>13</b>
<b>5.1</b>	<b>TRANSMITTER REQUIREMENT &amp; TEST SUITES .....</b>	<b>13</b>
5.1.1	<i>Antenna Requirement .....</i>	<i>13</i>
5.1.2	<i>Peak Output Power.....</i>	<i>14</i>
5.1.3	<i>6dB Bandwidth .....</i>	<i>15</i>
5.1.4	<i>Power Density .....</i>	<i>18</i>
5.1.5	<i>Conducted spurious emissions and Frequency Band Edge measured in 100kHz Bandwidth.....</i>	<i>21</i>
5.1.6	<i>Spurious Emission .....</i>	<i>25</i>
<b>5.2</b>	<b>MAINS EMISSIONS.....</b>	<b>26</b>
5.2.1	<i>Mains Conducted Emissions.....</i>	<i>26</i>
<b>6.</b>	<b>SAFETY HUMAN EXPOSURE .....</b>	<b>27</b>

<b>6.1</b>	<b>RADIO FREQUENCY EXPOSURE COMPLIANCE .....</b>	<b>27</b>
6.1.1	<i>Electromagnetic Fields.....</i>	<i>27</i>
<b>7.</b>	<b>PHOTOGRAPHS OF THE TEST SET-UP.....</b>	<b>28</b>
<b>8.</b>	<b>LIST OF TABLES .....</b>	<b>32</b>
<b>9.</b>	<b>LIST OF PHOTOGRAPHS.....</b>	<b>32</b>

## 1. General Remarks

### 1.1 Complementary Materials

These attachments are integral parts of this test report:

**Appendix P: Photo Documentation internal view**  
(File Name: 10052793APPENDIX P)

**Appendix D: Test Result of Radiated Emissions**  
(File Name: 10052793APPENDIX D)

Test Specifications

The following standards were applied.

#### Table 1: Applied Standard and Test Levels

<b>Radio</b>
--------------

NCC Low-power Radio-frequency Devices Technical Regulations LP0002(2011)(100年6月28日)
FCC CFR47 Part 15: Subpart C Section 15.247
RSS-247 Issue 1 May 2015
RSS-Gen, Issue 4, November 2014
ANSI C63.10:2013
KDB558074 D01 DTS Meas Guidance v02

## 2. Test Sites

### 2.1 Test Laboratory

TUV Rheinland Taiwan Ltd.  
Taichung Branch Office

No.9, Lane 36, Minsheng Rd., Sec. 3, Daya District,  
Taichung City 428  
Taiwan (R.O.C.)

### 2.2 Test Facility

TUV Rheinland Taiwan Ltd.  
Taipei Office

11F. No.758, Sec. 4, Bade Rd., Songshan Dist.  
Taipei City 105  
Taiwan (R.O.C.)

FCC RegistrationNo.: 365730  
IC Canada Registration No.: 9465A-1  
TAF Accredited NCC Test Lab. No.:0759  
TAF ISO17025 Certification effective periods: 2013-Jul-1st to 2016-Jun-30th



**Testing Laboratory**  
**0759**

## 2.3 List of Test and Measurement Instruments

**Table 2: List of Test and Measurement Equipment**

Kind of Equipment	Manufacturer	Type	S/N	Last Calibration	Next Calibration
EMI Test Receiver	R&S	ESR7	101062	31-Aug-14	15-Sep-15
Bilog Antenna	TESEQ	CBL6111D	29802	4-Jul-14	3-Jul-16
Spectrum Analyzer	R&S	FSV 40	100921	17-Dec-14	16-Dec-15
Spectrum Analyzer	Agilent	N9010A	MY53470241	1-Apr-15	30-Mar-16
Horn Antenna	ETS-Lindgren	3117	138160	12-Jan-15	11-Jan-17
Horn Antenna (18GHz~40GHz)	COM-POWER	AH840	101031	30-Oct-13	29-Oct-15
Preamplifier (30MHz -1GHz)	HP	8447F	2805A03335	24-Dec-14	24-Dec-15
Preamplifier (18 GHz -40 GHz)	COM-POWER	PAM-840	461257	26-Aug-14	26-Aug-16
Pre-Amplifier (1GHz~18GHz)	EM Electronics	EM30180	60558	4-Nov-14	3-Nov-15
Loop Antenna	Schwarzbeck	FMZB 1513	1513-076	22-Oct-14	21-Oct-15
EMI Test Receiver	R&S	ESCI7	100797	28-Dec-14	27-Dec-15
Spectrum Analyzer	R&S	FSL3	101943	7-Sep-15	7-Sep-16
LISN (1 phase)	R&S	ENV216	101243	1-Jun-15	31-May-16
LISN	R&S	ENV216	101262	16-Jun-15	15-Jun-16
Power sensor	Agilent	U2021XA	MY53480013	11-Mar-15	9-Mar-16

## 2.4 Traceability

All measurement equipment calibrations are traceable to NML(Taiwan)/NIST(USA) or where calibration is performed outside Taiwan, to equivalent nationally recognized standards organizations.

## 2.5 Calibration

Equipment requiring calibration is calibrated periodically in a suitably accredited Calibration Lab. Additionally all equipment is verified for proper performance on a regular schedule using in house standards or comparisons.

## 2.6 Measurement Uncertainty

The estimated combined standard uncertainty for radiated emissions and conducted emissions measurements .

**Table 3: Emission Measurement Uncertainty**

Parameter	Uncertainty
Radio Frequency	$\pm 1 \times 10^{-7}$
RF power, conducted	$\pm 1.5$ dB
RF power density, conducted	$\pm 3$ dB
spurious emissions, conducted	$\pm 3$ dB
all emissions, radiated	$\pm 6$ dB
Temperature	$\pm 1$ °C
Humidity	$\pm 5$ %
DC and low frequency voltages	$\pm 3$ %

### 3. General Product Information

#### 3.1 Product Function and Intended Use

The EUT is a Bluetooth module. It contains a Bluetooth 4.0 +EDR compatible module enabling the user to communicate data through a Wireless interface.  
For details refer to the User Guide, Data Sheet and Circuit Diagram.

#### 3.2 System Details and Ratings

**Table 4: Basic Information of EUT**

Item	EUT information
Kind of Equipment	Bluetooth module
Type Designation	BM78abcdefgh,RN4678
Brand Name	Microchip
FCC ID	A8TBM78ABCDEFGH
Canada ID	12246A-BM78SPPS5M2
Canada HVIN	BM78SPPS5M2

**Table 5: Technical Specification of EUT**

Technical Specification	Value
Operating Frequencies	2402~2480 MHz
Channel Spacing	2 MHz
Channel number	40
Operation Voltage	5Vdc
Modulation	GFSK
Antenna gain	1.63 dBi



### **3.3 Independent Operation Modes**

Basic operation modes are:

- A. Transmitting
  - 1. Low channel
  - 2. Middle channel
  - 3. High channel
- B. Receiving
- C. Standby
- D. Off

### **3.4 Noise Generating and Noise Suppressing Parts**

Refer to the Circuit Diagram.

### **3.5 Submitted Documents**

- Circuit Diagram
- Instruction Manual
- Rating Label
- Technical Description

## 4. Test Set-up and Operation Modes

### 4.1 Principle of Configuration Selection

The equipment under test (EUT) was configured to measure its maximum power level. The test modes were adapted accordingly in reference to the instructions for use.

### 4.2 Test Operation and Test Software

Setup for testing: Test samples are provided with a USB interface which makes it possible to control them through a test software installed on a notebook computer.

This software was running on the laptop computer connected to the EUT. It was used to enable the operation modes listed in section 3.3 as appropriate.

The samples were used as follows:

Conducted: A000244783-006

Radiation: A000244783-005

Full test was applied on all test modes, but only worst case was shown

### 4.3 Special Accessories and Auxiliary Equipment

The product has been tested together with the following additional accessories:

Kind of Equipment	Manufacturer	Model Name	S/N
Laptop	HP	HSTNN-Q78C-3	CNF0339QBM

## 4.4 Countermeasures to achieve EMC Compliance

The test sample which has been tested contained the noise suppression parts as described in the Constructional Data Form or the Technical Construction File. No additional measures were employed to achieve compliance.

## 4.5 Test Setup Diagram

**Diagram of Measurement Configuration for Radiation Test**

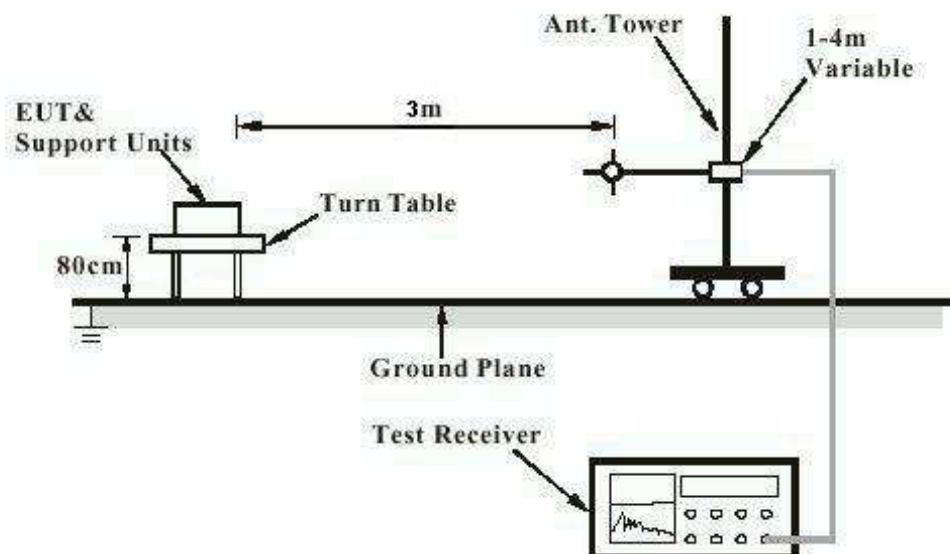

Note: Measurements above 1 GHz are done with a table height of 1.5m

**Diagram of Measurement Equipment Configuration for Conducted Transmitter Measurement**

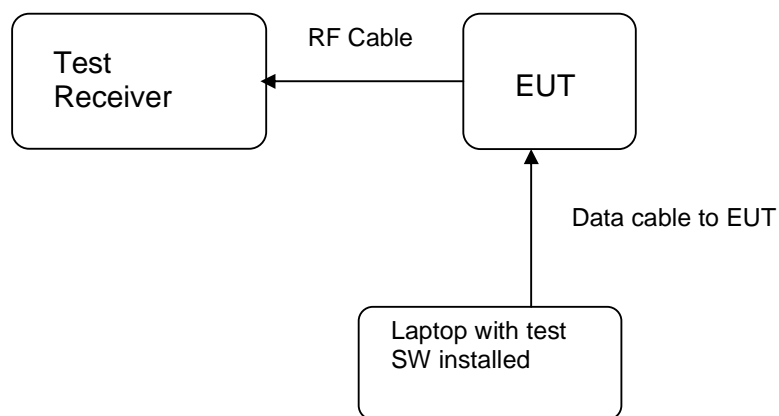

**Diagram of Measurement Equipment Configuration for Conducted Transmitter Measurement (Power meter)**

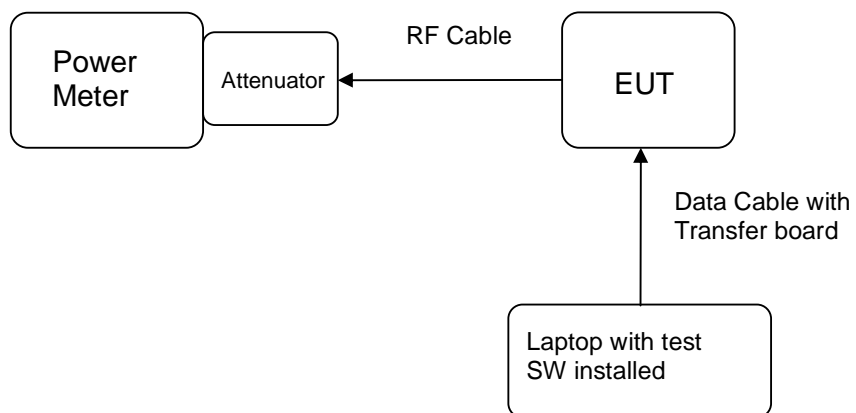

## 5. Test Results

### 5.1 Transmitter Requirement & Test Suites

#### 5.1.1 Antenna Requirement

**RESULT:** **Passed**

Test standard	:	LP0002(2011): 2.2, 3.10.1, (3) FCC Part 15.247(b)(4), Part 15.203 and RSS- Gen 8.3
Requirement	:	use of approved antennas only with directional gains that do not exceed 6 dBi

According to the manufacturer declaration, the EUT has an antenna with a directional gain of 1.63 dBi. The antenna is a Chip Antenna soldered to the PCB with no possibility of replacement with a non-approved antenna by the end-user. Therefore, the EUT is considered to comply with this provision.

Refer to EUT photo for details.

## 5.1.2 Peak Output Power

**RESULT:**
**Passed**

Test standard : LP0002(2011): 3.10.1, (2)  
 FCC Part 15.247(b)(3), RSS-247 5.4(4)  
 Basic standard : ANSI C63.10:2013, KDB558074  
 Limit : 1 Watt  
 Kind of test site : Shielded room

**Test setup**

Test Channel : Low/ Middle/ High  
 Operation Mode : A  
  
 Ambient temperature : 20-24 °C  
 Relative humidity : 50-65 %  
 Atmospheric pressure : 100-103 kPa

**Table 6: Test result of Peak Output Power**

Channel	Channel Frequency (MHz)	Output Power		Limit
		(dBm)	(W)	(W)
Low Channel	2402	0.67	0.0012	1
Middle Channel	2440	0.82	0.0012	1
High Channel	2480	0.62	0.0012	1

Pmax: 1.2078 mW

### 5.1.3 6dB Bandwidth

**RESULT:**
**Passed**

Test standard : LP0002(2011): 3.10.1, (5)  
 FCC Part 15.247(a)(2), RSS-247 5.2(1)  
 Basic standard : ANSI C63.10:2013, KDB558074  
 Kind of test site : Shielded room

**Test setup**

Test Channel : Low/ Middle/ High  
 Operation Mode : A

Ambient temperature : 20-24°C  
 Relative humidity : 50-65%  
 Atmospheric pressure : 100-103 kPa

**Table 7: Test result of 6dB Bandwidth**

Channel	Channel Frequency (MHz)	6dB Bandwidth (kHz)	Limit (kHz)	Result
Low Channel	2402	679.6	>500	Pass
Mid Channel	2440	678.2	>500	Pass
High Channel	2480	679.7	>500	Pass

**Table 8: Test result of 99% Bandwidth,**

Channel	Channel Frequency (MHz)	99% Bandwidth (MHz)
Mid Channel	2440	1.0768

## Test Plot of 6dB Bandwidth

### Low Channel

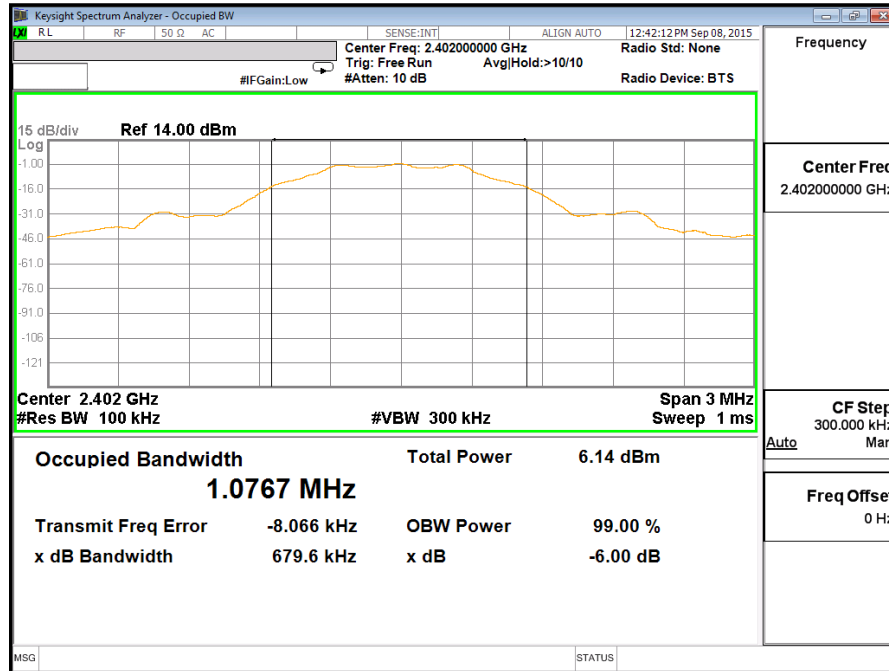

### Middle Channel

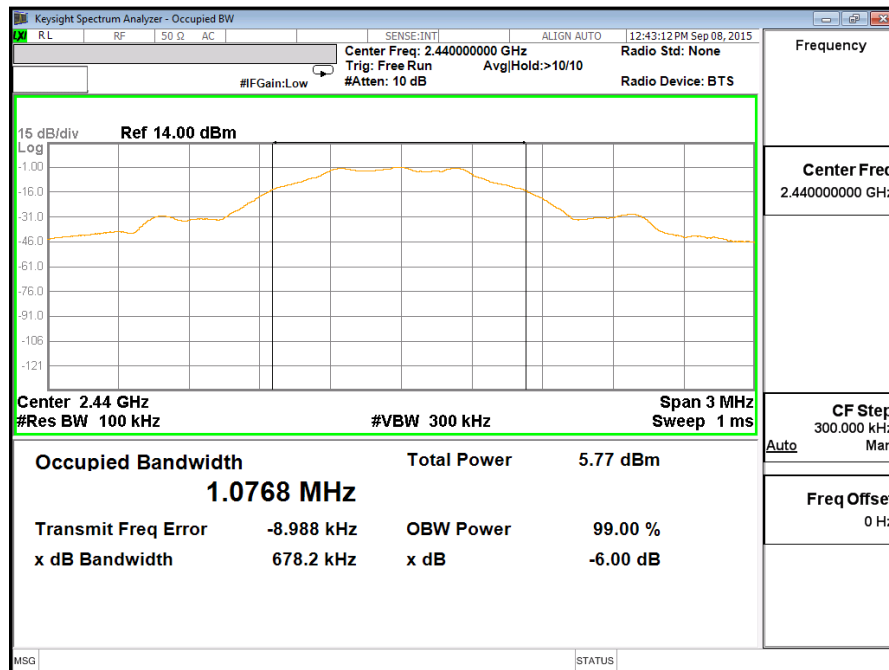

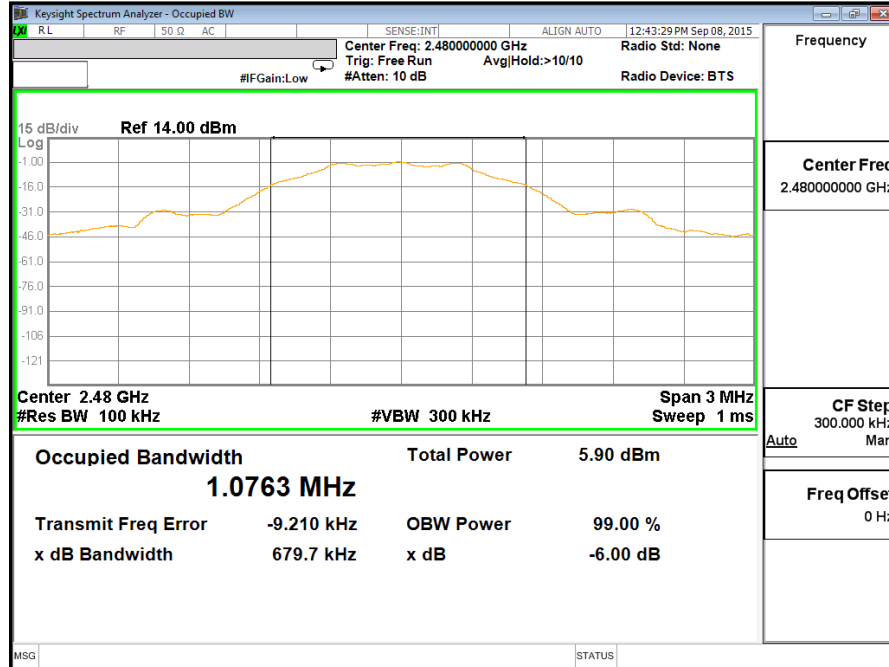

**High Channel**

## 5.1.4 Power Density

**RESULT:****Passed**

Test standard : LP0002(2011): 3.10.1, (6.2.2)  
FCC Part 15.247(e) , RSS-247 5.2(2)  
Basic standard : ANSI C63.10:2013, KDB558074  
Kind of test site : Shielded room

**Test setup**

Test Channel : Low/ Middle/ High  
Operation Mode : A  
Ambient temperature : 20-24°C  
Relative humidity : 50-65%  
Atmospheric pressure : 100-103 kPa

**Table 9: Test result of Power Density**

Channel	Channel Frequency (MHz)	Power Density	Limit
		(dBm)	(dBm)
Low Channel	2402	-13.72	8
Middle Channel	2440	-13.58	8
High Channel	2480	-13.86	8

## Test Plot of Power Density

### Low Channel

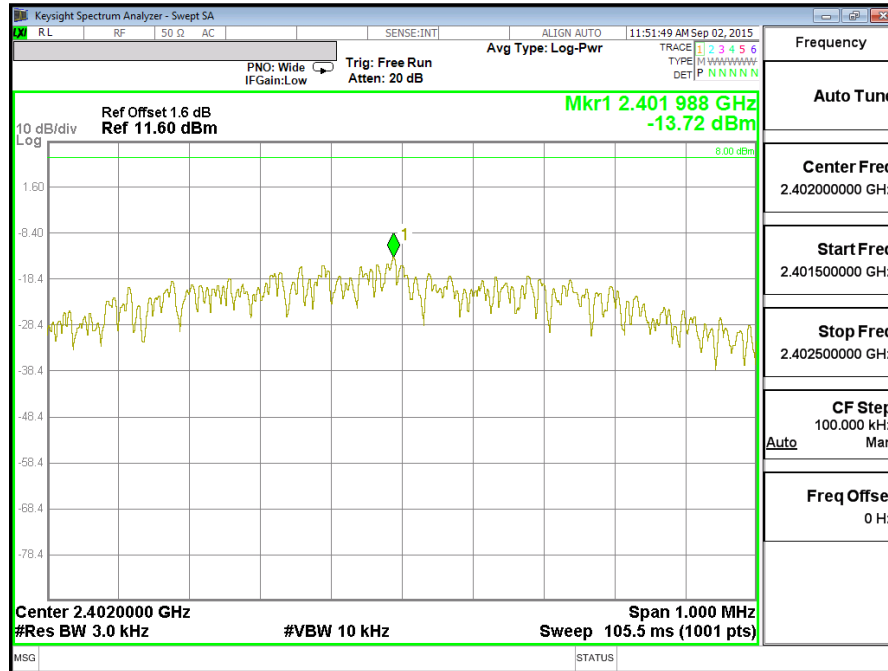

### Middle Channel

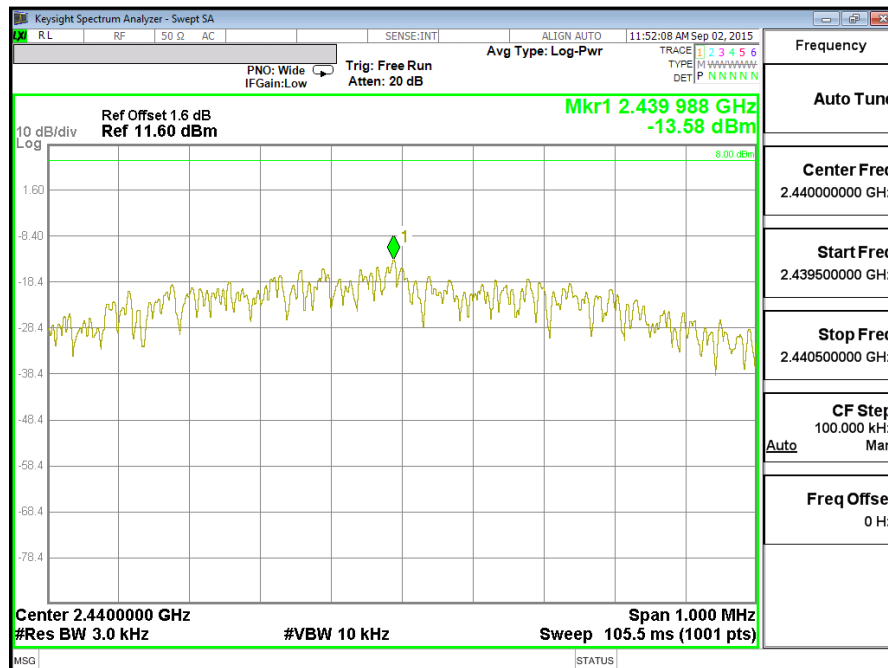

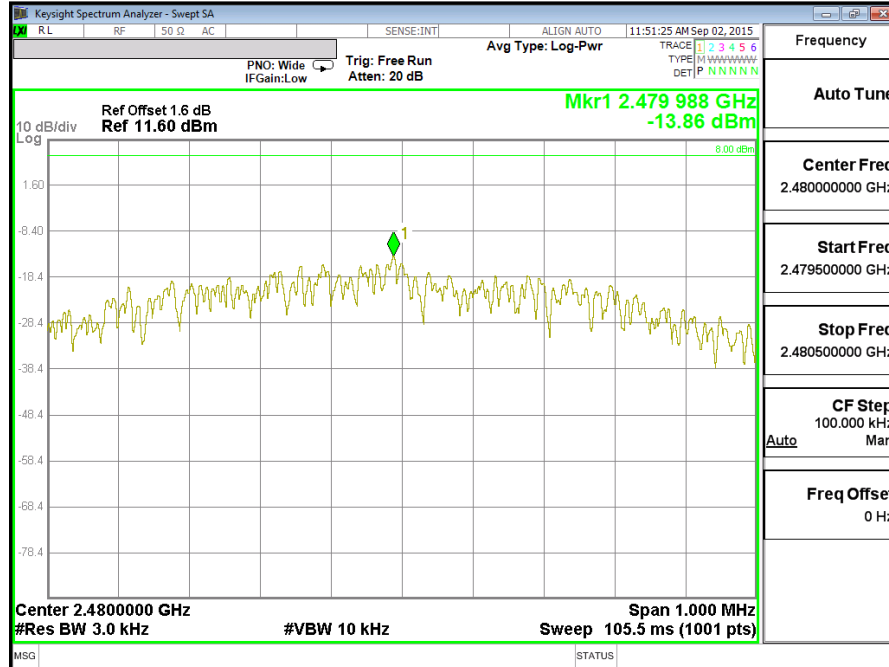
**High Channel**

### 5.1.5 Conducted spurious emissions and Frequency Band Edge measured in 100kHz Bandwidth

**RESULT:** **Passed**

Test standard : LP0002(2011): 3.10.1, (5)  
FCC part 15.247(d), RSS-247 5.5  
Basic standard : ANSI C63.10:2013, KDB558074  
Limit : 20dB (below that in the 100kHz bandwidth within the  
band that contains the highest level of the desired power)  
Kind of test site : Shielded room

#### Test setup

Test Channel : Low/ High  
Operation mode : A  
Ambient temperature : 20-24°C  
Relative humidity : 50-65%  
Atmospheric pressure : 100-103 kPa

All emissions are more than 20dB below fundamental, details refer to following test plot, and compliance is achieved as well.  
Due to the small size of the product and that there are no inductive components of significant size, 9kHz to 30MHz frequency range is not tested based on technical judgment.

## Test Plot 100kHz Conducted Emissions

### Low Channel

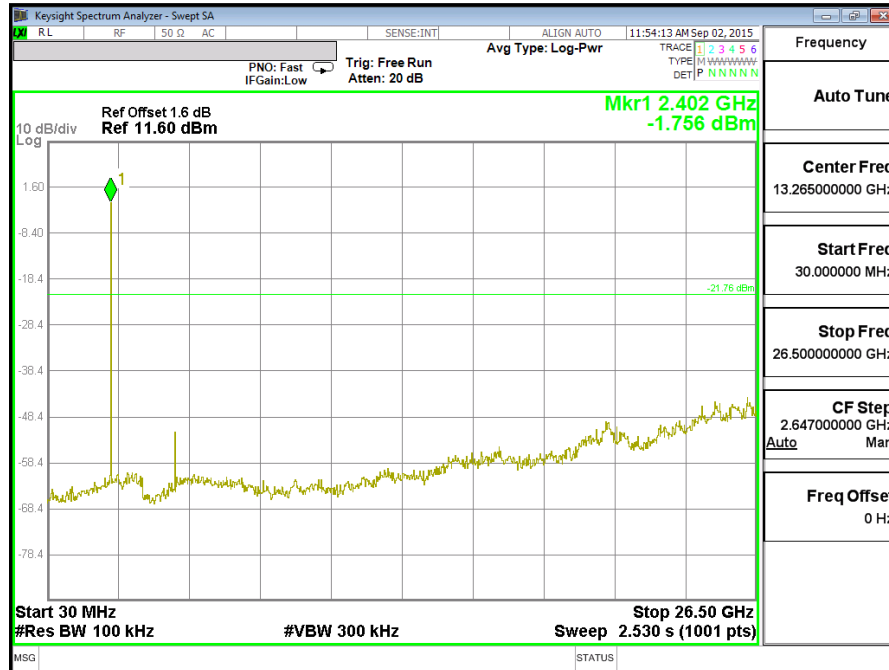

### Middle Channel

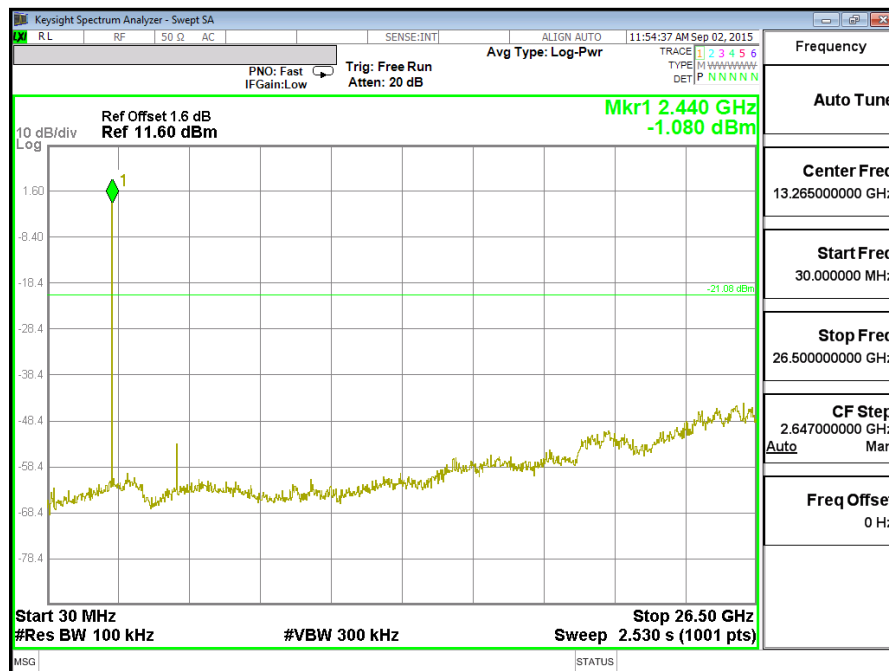

**High Channel**

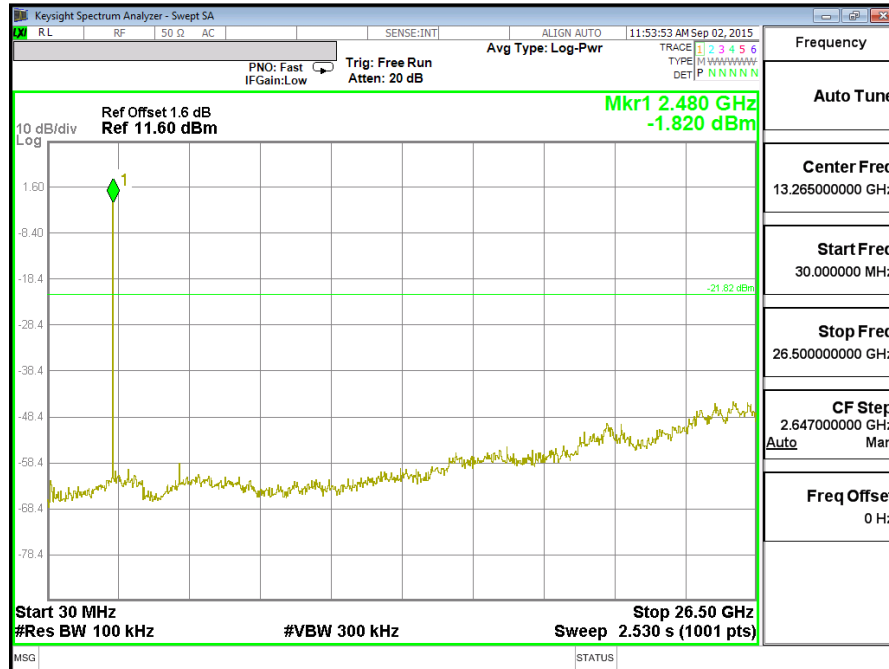

## Test Plot 100kHz RBW of Band Edge

### Low Channel

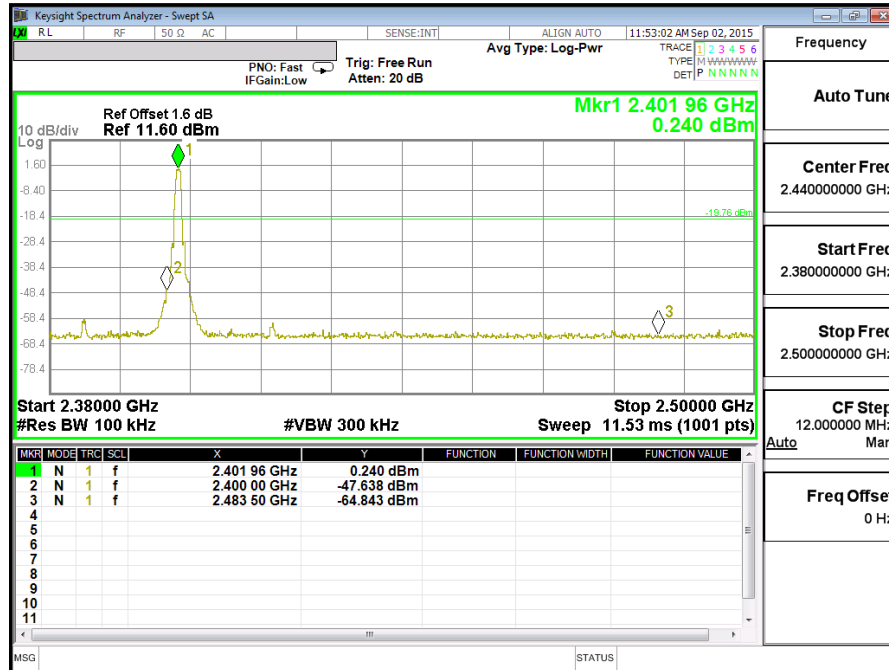

### High Channel

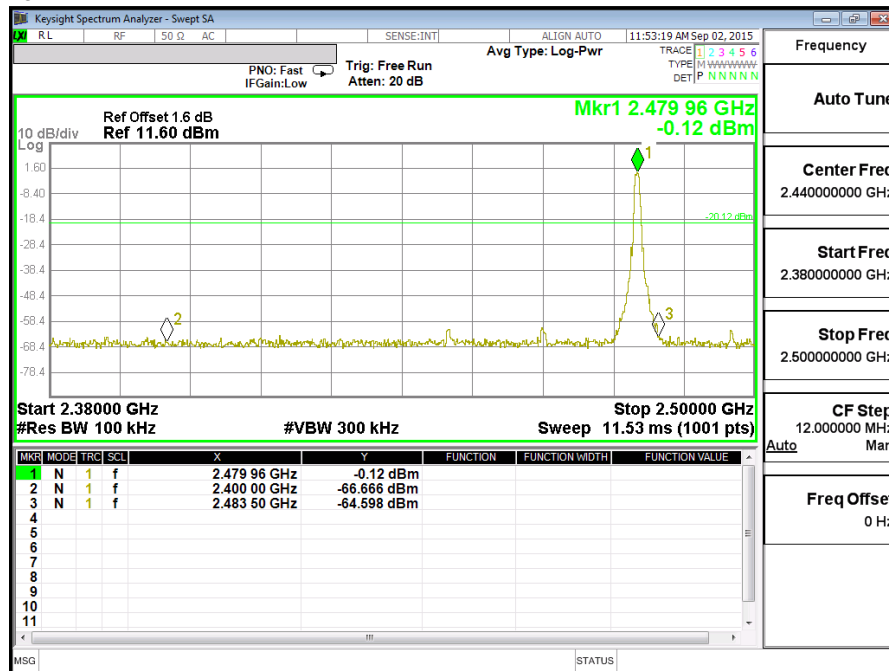



## 5.1.6 Spurious Emission

**RESULT:****Passed**

Test standard	:	FCC part 15.247(d), FCC 15.205, FCC 15.209, RSS-210 2.2, RSS-247 5.5 and RSS-Gen 8.9 LP0002(2011): 3.10.1, (5)
Basic standard	:	ANSI C63.10: 2009
Limits	:	Radiated emissions which fall in the restricted bands, as defined in FCC 15.205(a) and RSS-Gen i4, 8.9 (Table 6), must comply with the radiated emission limits specified in FCC 15.209(a) and RSS-Gen i4, 8.9 (Table 4 and 5). Radiated emissions which fall in the restricted bands, as defined in LP0002(2011): 2.7 , must comply with the radiated emission limits specified in LP0002(2011): 2.8 Emission radiated outside the specified frequency bands must comply with the radiated emission limits specified in FCC 15.209(a) and FCC 15.249(a), RSS-Gen i4, 8.9 (Table 4 and 5) and RSS-210 A2.9(a). Emission radiated outside the specified frequency bands must comply with the radiated emission limits specified in LP0002(2011): 2.8
Kind of test site	:	3m Semi-Anechoic Chamber

**Test setup**

Test Channel	:	Low/ Middle/ High
Operation mode	:	A, B

Remark: Testing was carried out within frequency range 30MHz to the tenth harmonic.

For details refer to Appendix D.

Testing was carried out within frequency range 30MHz to the tenth harmonic. For details refer to Appendix D. The Radiated Emissions testing was performed in the X, Y and Z axis orientation. The worst-case Axis orientation is recorded in this test report. Due to the small size of the product and that there are no inductive components of significant size, 9kHz to 30MHz frequency range is not tested based on technical judgment.

## 5.2 Mains Emissions

### 5.2.1 Mains Conducted Emissions

**RESULT:****Passed**

Test standard : FCC Part 15.207  
FCC Part 15.107  
RSS-Gen 8.8  
LP0002: 2.3

Limits : Mains Conducted emissions as defined in  
above standards

Kind of test site : Shielded Room

**Test setup**

Test Channel : Middle  
Operation mode : A

Remark: For details refer to Appendix D.

## 6. Safety Human exposure

### 6.1 Radio Frequency Exposure Compliance

#### 6.1.1 Electromagnetic Fields

**RESULT:****Passed**

Test standard : FCC KDB Publication 447498 D01 v05

The maximum peak output power of the transmitter is 1.2078 mW.

Hence the EUT is excluded from SAR evaluation.

Please also refer to FCC KDB publication 447498 D01 v05: Mobile Portable RF Exposure

## 7. Photographs of the Test Set-Up

Photograph 1: Set-up for Spurious Emissions (Front View)

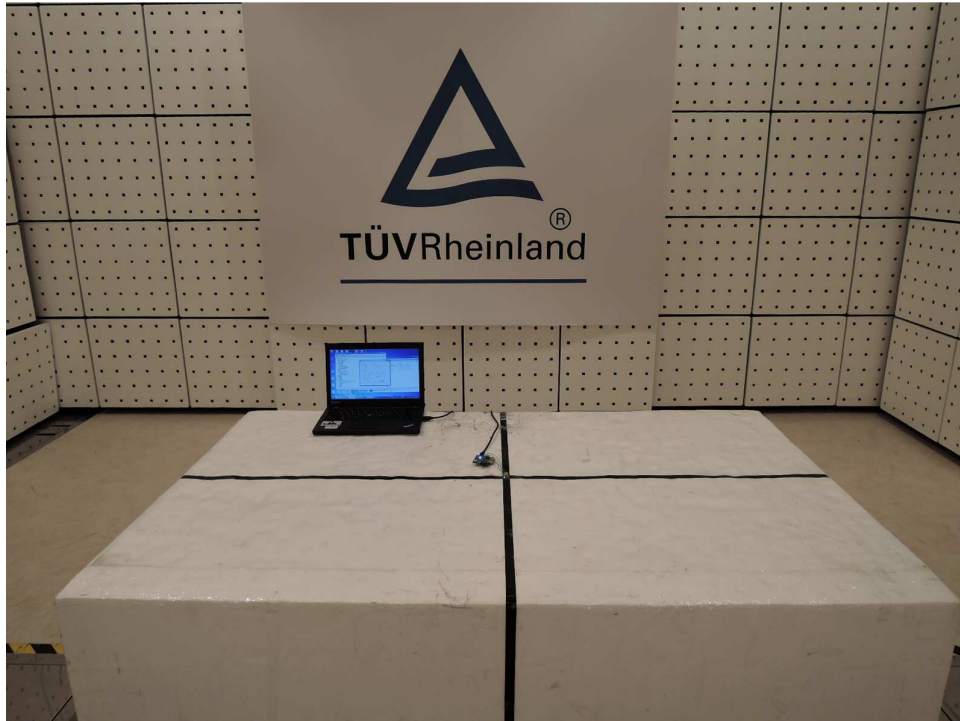

**Photograph 2: Set-up for Spurious Emissions (Back View 1)**

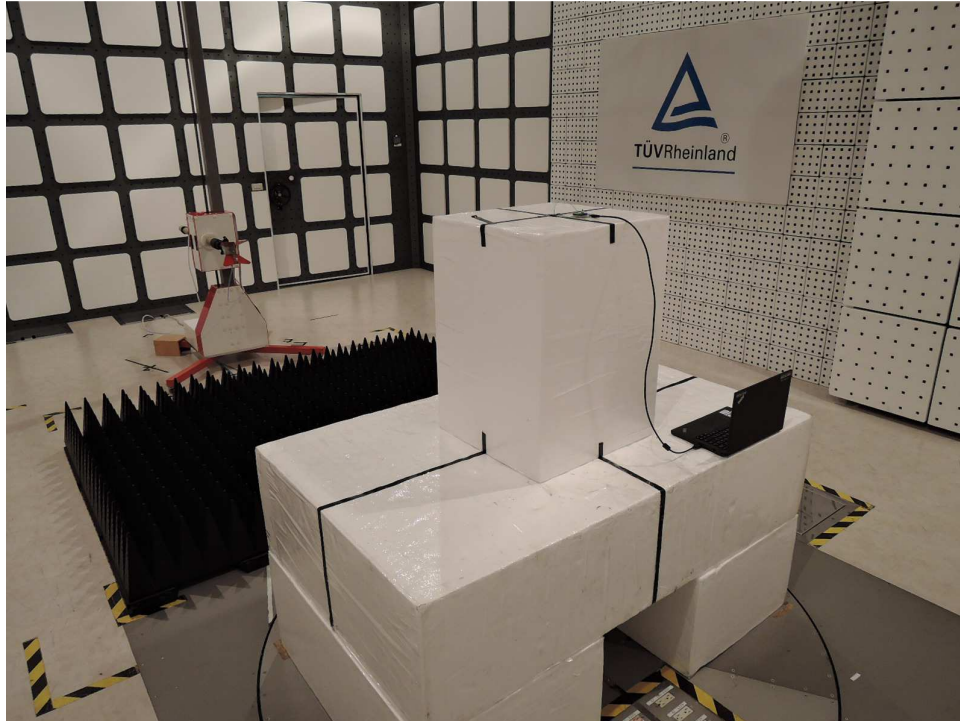

**Photograph 3: Set-up for Spurious Emissions (Back View 2)**

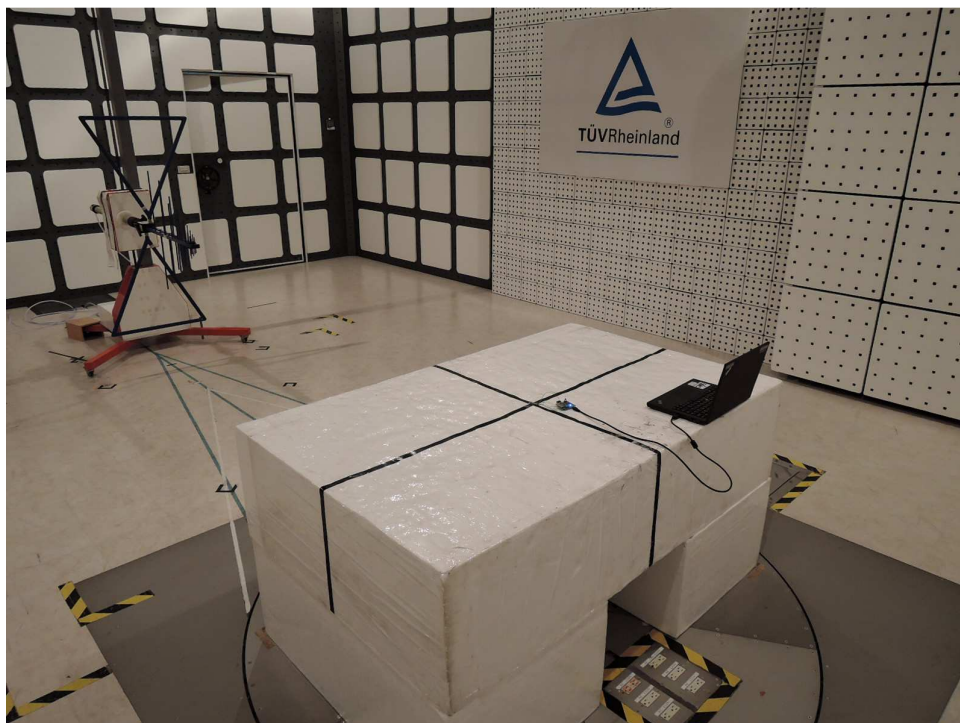



**Photograph 4: Set-up for Conducted testing**

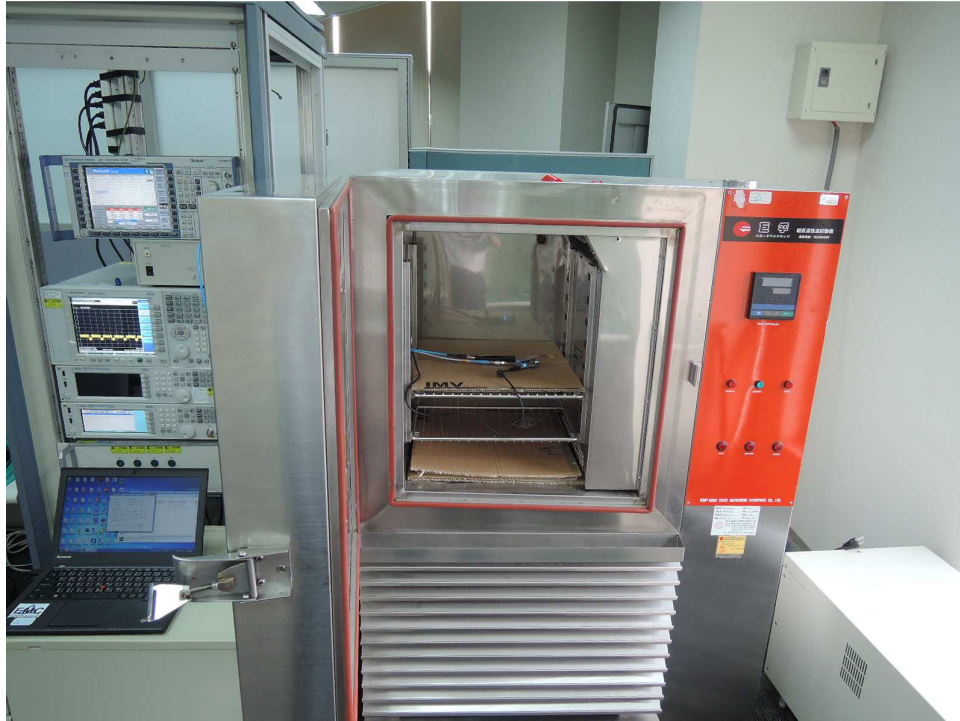

**Photograph 5: Set-up for for Mains Conducted testing Back**



**Photograph 6: Set-up for for Mains Conducted testing Front**



## 8. List of Tables

Table 1: Applied Standard and Test Levels .....	4
Table 2: List of Test and Measurement Equipment .....	6
Table 3: Emission Measurement Uncertainty.....	7
Table 4: Basic Information of EUT .....	8
Table 5: Technical Specification of EUT .....	8
Table 6: Test result of Peak Output Power .....	14
Table 7: Test result of 6dB Bandwidth .....	15
Table 8: Test result of 99% Bandwidth,.....	15
Table 9: Test result of Power Density .....	18

## 9. List of Photographs

Photograph 1: Set-up for Spurious Emissions (Front View).....	28
Photograph 2: Set-up for Spurious Emissions (Back View 1) .....	29
Photograph 3: Set-up for Spurious Emissions (Back View 2) .....	29
Photograph 4: Set-up for Conducted testing .....	30
Photograph 5: Set-up for for Mains Conducted testing Back .....	30
Photograph 6: Set-up for for Mains Conducted testing Front.....	31