

Prüfbericht-Nr.: <i>Test report no.:</i>	CN22BHJ8(P15C-BT) 001	Auftrags-Nr.: <i>Order no.:</i>	238538679	Seite 1 von 24 <i>Page 1 of 24</i>
Kunden-Referenz-Nr.: <i>Client reference no.:</i>	N/A	Auftragsdatum: <i>Order date:</i>	2022-01-14	
Auftraggeber: <i>Client:</i>	Microchip Technology Inc., 2355 West Chandler Blvd. Chandler, Arizona 85224-6199, United States			
Prüfgegenstand: <i>Test item:</i>	Bluetooth module			
Bezeichnung / Typ-Nr.: <i>Identification / Type no.:</i>	BM62SPKabcC2, BM62SPKS1MC2, BM62SPKS1NC2			
Auftrags-Inhalt: <i>Order content:</i>	FCC Part 15C Test report (BT)			
Prüfgrundlage: <i>Test specification:</i>	FCC 47CFR Part 15: Subpart C Section 15.247			
Wareneingangsdatum: <i>Date of sample receipt:</i>	2022-01-12			
Prüfmuster-Nr.: <i>Test sample no.:</i>	A003199106-001 A003199106-002			
Prüfzeitraum: <i>Testing period:</i>	2022-02-02 - 2022-03-03			
Ort der Prüfung: <i>Place of testing:</i>	EMC/RF Taipei Testing Site			
Prüflaboratorium: <i>Testing laboratory:</i>	Taipei Testing Laboratories			
Prüfergebnis*: <i>Test result*:</i>	Pass			
zusammengestellt von: <i>compiled by:</i>		genehmigt von: <i>authorized by:</i>		
Datum: <i>Date:</i>	2022-05-17	Ausstellungsdatum: <i>Issue date:</i>	2022-05-17	
Stellung / Position:	Senior Project Manager	Stellung / Position:	Senior Project Manager	
Sonstiges / Other:	This is update report for 2nd source crystal change. Hence, we only evaluate and verify the output power and radiated spurious emission tests. For the details, please refer to report no. 10055771 001.			
Zustand des Prüfgegenstandes bei Anlieferung: <i>Condition of the test item at delivery:</i>	Prüfmuster vollständig und unbeschädigt <i>Test item complete and undamaged</i>			
* Legende:	1 = sehr gut P(ass) = entspricht o.g. Prüfgrundlage(n)	2 = gut F(ail) = entspricht nicht o.g. Prüfgrundlage(n)	3 = befriedigend N/A = nicht anwendbar	4 = ausreichend N/T = nicht getestet
* Legend:	1 = very good P(ass) = passed a.m. test specification(s)	2 = good F(ail) = failed a.m. test specification(s)	3 = satisfactory N/A = not applicable	4 = sufficient N/T = not tested
Dieser Prüfbericht bezieht sich nur auf das o.g. Prüfmuster und darf ohne Genehmigung der Prüfstelle nicht auszugsweise vervielfältigt werden. Dieser Bericht berechtigt nicht zur Verwendung eines Prüfzeichens. <i>This test report only relates to the a. m. test sample. Without permission of the test center this test report is not permitted to be duplicated in extracts. This test report does not entitle to carry any test mark.</i>				

TEST SUMMARY

Report Section	FCC Clause	Test Item	Result
5.1.1	15.247(b) & 15.203	Antenna Requirement	Pass
5.1.2	15.247(b)(1)	Peak Output Power	Pass
5.1.3	15.247(d) & 15.205 & 15.209	Radiated Spurious Emissions and Band Edges	Pass
5.2.1	15.207	Mains Conducted Emission	Pass

Note:

1. If the Frequency Hopping Systems operating in 2400-2483.5 MHz band and the output power less than 125 mW. The hopping channel carrier frequencies separated by a minimum of 25 kHz or two-thirds of the 20 dB bandwidth of hopping channel whichever is greater.
2. Determining compliance based on the results of the compliance measurement, not taking into account measurement instrumentation uncertainty.

Contents

HISTORY OF THIS TEST REPORT	4
1. GENERAL REMARKS	5
1.1 COMPLEMENTARY MATERIALS.....	5
1.2 DECISION RULE OF CONFORMITY	5
2. TEST SITES	6
2.1 TEST LABORATORY	6
2.2 TEST FACILITY.....	6
2.3 TRACEABILITY	7
2.4 CALIBRATION	7
2.5 MEASUREMENT UNCERTAINTY	7
3. GENERAL PRODUCT INFORMATION.....	8
3.1 PRODUCT FUNCTION AND INTENDED USE	8
3.2 SYSTEM DETAILS AND RATINGS.....	8
3.3 NOISE GENERATING AND NOISE SUPPRESSING PARTS	9
3.4 SUBMITTED DOCUMENTS.....	9
4. TEST SET-UP AND OPERATION MODES.....	10
4.1 PRINCIPLE OF CONFIGURATION SELECTION	10
4.2 CARRIER FREQUENCY AND CHANNEL.....	10
4.3 TEST OPERATION AND TEST SOFTWARE.....	11
4.4 SPECIAL ACCESSORIES AND AUXILIARY EQUIPMENT	12
4.5 TEST SETUP DIAGRAM	13
5. TEST RESULTS	14
5.1 TRANSMITTER REQUIREMENT & TEST SUITES	14
5.1.1 <i>Antenna Requirement</i>	<i>14</i>
5.1.2 <i>Peak Output Power</i>	<i>15</i>
5.1.3 <i>Radiated Spurious Emissions and Band Edges</i>	<i>18</i>
5.2 MAINS EMISSION	23
5.2.1 <i>Mains Conducted Emission.....</i>	<i>23</i>

APPENDIX A - TEST RESULT OF RADIATED EMISSIONS & MAINS CONDUCTED EMISSION

APPENDIX SP - PHOTOGRAPHS TEST SETUP

APPENDIX EP - PHOTOGRAPHS OF EUT

Prüfbericht - Nr.: CN22BHJ8(P15C-BT) 001
Test Report No.

Seite 4 von 24
Page 4 of 24

HISTORY OF THIS TEST REPORT

Version	Description	Date Issued
00	Original Release	2022-03-08
01	Modified model name	2022-05-17

1. General Remarks

1.1 Complementary Materials

All attachments are integral parts of this test report. This applies especially to the following appendix:

Appendix A - Test Result of Radiated Emissions & Mains Conducted Emission

Appendix SP - Photographs Test Setup

Appendix EP - Photographs of EUT

Applied Standard and Test Levels

Radio
FCC 47CFR Part 15: Subpart C Section 15.247
FCC 47CFR Part 2: Subpart J Section 2.1049
ANSI C63.10:2013
KDB 558074 D01 15.247 Meas Guidance v05r02

1.2 Decision Rule of Conformity

The decision rule of conformity of this test report is following the requirements of the requested standard in the quotation, and agreed among testing laboratory and manufacturer (applicant) to exclude the consideration of Measurement Uncertainty, unless it is required by the specific standard.

2. Test Sites

2.1 Test Laboratory

Taipei Testing Laboratories

11F. No.758, Sec. 4, Bade Rd., Songshan Dist.
Taipei City 105
Taiwan (R.O.C.)

2.2 Test Facility

Taipei Testing Laboratories

No.458-18, Sec. 2, Fenliao Rd., Linkou Dist.,
New Taipei City 244
Taiwan (R.O.C.)
FCC Registration No.: 226631
ISED Registration No.: 25563

2.3 Traceability

All measurement equipment calibrations are traceable to NML(Taiwan)/NIST(USA) or where calibration is performed outside Taiwan, to equivalent nationally recognized standards organizations.

2.4 Calibration

Equipment requiring calibration is calibrated periodically in a suitably accredited Calibration Lab. Additionally all equipment is verified for proper performance on a regular basis using in house standards or comparisons.

2.5 Measurement Uncertainty

All measurement uncertainty values are shown with a coverage factor of $k=2$ to indicate a 95% level of confidence.

Emission Measurement Uncertainty

Parameter	Uncertainty
Radiated Emission (9 kHz ~ 30 MHz)	± 1.15 dB
Radiated Emission (30 MHz ~ 200 MHz)	± 1.30 dB
Radiated Emission (200 MHz ~ 1 GHz)	± 1.30 dB
Radiated Emission (1 GHz ~ 18 GHz)	± 1.54 dB
Radiated Emission (18 GHz ~ 40 GHz)	± 2.52 dB
Mains Conducted Emission	± 1.65 dB

3. General Product Information

3.1 Product Function and Intended Use

The EUT is a Bluetooth module. It contains a Bluetooth compatible module enabling the user to communicate data through a Wireless interface.

For details refer to the User Guide, Data Sheet and Circuit Diagram.

3.2 System Details and Ratings

Basic Information of EUT

Item	EUT information
Kind of Equipment/Test Item	Bluetooth module
Type Identification	BM62SPKabcC2, BM62SPKS1MC2, BM62SPKS1NC2
FCC ID	A8TBM62S2

Technical Specification of EUT

Item	EUT information
Operating Frequency	2402 MHz ~ 2480 MHz
Channel Spacing	1 MHz
Channel Number	79
Operation Voltage	3.2Vdc ~ 4.2Vdc (Tested at 3.3Vdc)
Modulation	GFSK, $\pi/4$ -DQPSK, 8DPSK
Maximum Output Power (mW)	3.289
Antenna Information	Refer to 5.1.1
Accessory Device	Refer to 4.4

3.3 Noise Generating and Noise Suppressing Parts

Refer to the Circuit Diagram.

3.4 Submitted Documents

- Circuit Diagram
- Instruction Manual
- Rating Label
- Technical Description

4. Test Set-up and Operation Modes

4.1 Principle of Configuration Selection

The test modes were adapted accordingly in reference to the instructions for use.

During testing, Channel and Power Controlling Software provided by the customer was used to control the operating channel as well as the output power level. The RF output power selection is for the setting of RF output expected by the customer and is going to be fixed on the firmware of the final end product.

Table for Parameters of Test Software Setting

Frequency (MHz)	Power Setting		
	GFSK	$\pi/4$ -DQPSK	8DPSK
2402	max.	max.	max.
2441	max.	max.	max.
2480	max.	max.	max.

4.2 Carrier Frequency and Channel

Channel	Freq. (MHz)	Channel	Freq. (MHz)	Channel	Freq. (MHz)	Channel	Freq. (MHz)
0	2402	20	2422	40	2442	60	2462
1	2403	21	2423	41	2443	61	2463
2	2404	22	2424	42	2444	62	2464
3	2405	23	2425	43	2445	63	2465
4	2406	24	2426	44	2446	64	2466
5	2407	25	2427	45	2447	65	2467
6	2408	26	2428	46	2448	66	2468
7	2409	27	2429	47	2449	67	2469
8	2410	28	2430	48	2450	68	2470
9	2411	29	2431	49	2451	69	2471
10	2412	30	2432	50	2452	70	2472
11	2413	31	2433	51	2453	71	2473
12	2414	32	2434	52	2454	72	2474
13	2415	33	2435	53	2455	73	2475
14	2416	34	2436	54	2456	74	2476
15	2417	35	2437	55	2457	75	2477
16	2418	36	2438	56	2458	76	2478
17	2419	37	2439	57	2459	77	2479
18	2420	38	2440	58	2460	78	2480
19	2421	39	2441	59	2461		

4.3 Test Operation and Test Software

Setup for testing: Test samples are provided with a USB interface which makes it possible to control them through a test software installed on a notebook computer.
 This software was running on the laptop computer connected to the EUT. It was used to enable the operation modes listed as below.

Test Software	ISRT Ver:2.1.31.5011
---------------	----------------------

The samples were used as follows:
 A003199106-001 for conducted test
 A003199106-002 for radiated test
 Full test was applied on all test modes, but only worst case was shown.

EUT Configure Mode	Applicable To				Description
	Antenna Port Conducted Measurement	Radiated Spurious Emissions above 1 GHz	Radiated Spurious Emissions below 1 GHz	Mains Conducted Emission	
-	√	√	√	√	-

- Note:
- For Radiated emission test, pre-tested GFSK, $\pi/4$ -DQPSK, 8DPSK modulation type and found 8DPSK was the worse, therefore chosen for the final test and presented in the test report.
 - The EUT had been pre-tested on the positioned of each 3 axis. The worst case was found when position on Z-plane.
 - "-" means no effect.

Antenna Port Conducted Measurement

- Pre-Scan full test was applied on all test modes, but only worst case was shown.
- Following channel(s) was (were) selected for the final test as listed below.

EUT Configure Mode	Available Frequency (MHz)	Tested Frequency (MHz)	Modulation Type	Packet Type
Output power only	2402 to 2480	2402, 2441, 2480	GFSK	1DH5
Output power only	2402 to 2480	2402, 2441, 2480	$\pi/4$ -DQPSK	2DH5
Output power only	2402 to 2480	2402, 2441, 2480	8DPSK	3DH5

Radiated Spurious Emissions (Above 1 GHz)

- Pre-Scan full test was applied on all test modes, but only worst case was shown.
- Following channel(s) was (were) selected for the final test as listed below.

EUT Configure Mode	Available Frequency (MHz)	Tested Frequency (MHz)	Modulation Type	Packet Type
-	2402 to 2480	2402, 2441, 2480	GFSK	1DH5
-	2402 to 2480	2402, 2441, 2480	8DPSK	3DH5

Radiated Spurious Emissions (Below 1 GHz)

- Pre-Scan full test was applied on all test modes, but only worst case was shown.
- Following channel(s) was (were) selected for the final test as listed below.

EUT Configure Mode	Available Frequency (MHz)	Tested Frequency (MHz)	Modulation Type	Packet Type
-	2402 to 2480	2402	8DPSK	3DH5

Mains Conducted Emission Test

- Pre-Scan full test was applied on all test modes, but only worst case was shown.
- Following channel(s) was (were) selected for the final test as listed below.

EUT Configure Mode	Available Frequency (MHz)	Tested Frequency (MHz)	Modulation Type	Packet Type
-	2402 to 2480	2402	8DPSK	3DH5

Test Condition

Test Item	Ambient Temperature	Relative Humidity	Tested by
Conducted Measurement	21.3 °C	69 %	Stanislas Charles
Radiated Spurious Emissions above 1 GHz	19.3 °C	20.4 %	Hunter Wang
Radiated Spurious Emissions below 1 GHz	19.3 °C	20.4 %	Hunter Wang
Mains Conducted Emission	20.1-20.9 °C	53-57 %	Hunter Wang

4.4 Special Accessories and Auxiliary Equipment

The product has been tested together with the following additional accessories:

Accessory of EUT

None.

Support Unit

No.	Description	Brand	Model	S/N	Remark
Radiate Test					
A	USB Cable	Microchip	-	-	145 cm shielded cable w/o core
1	USB Cable	TUV	TUV-001	-	175 cm shielded cable with 4 core
2	Notebook	Lenovo	81BL	MP1DCD6Y	-
Mains Conducted Emission Test					
A	USB Cable	Microchip	-	-	145 cm shielded cable w/o core
1	USB Cable	Microchip	-	-	145 cm shielded cable w/o core
Conducted Test					
-	Notebook	HP	TPN-C139	CND93662VF	-

4.5 Test Setup Diagram

<Radiated Spurious Emissions mode>

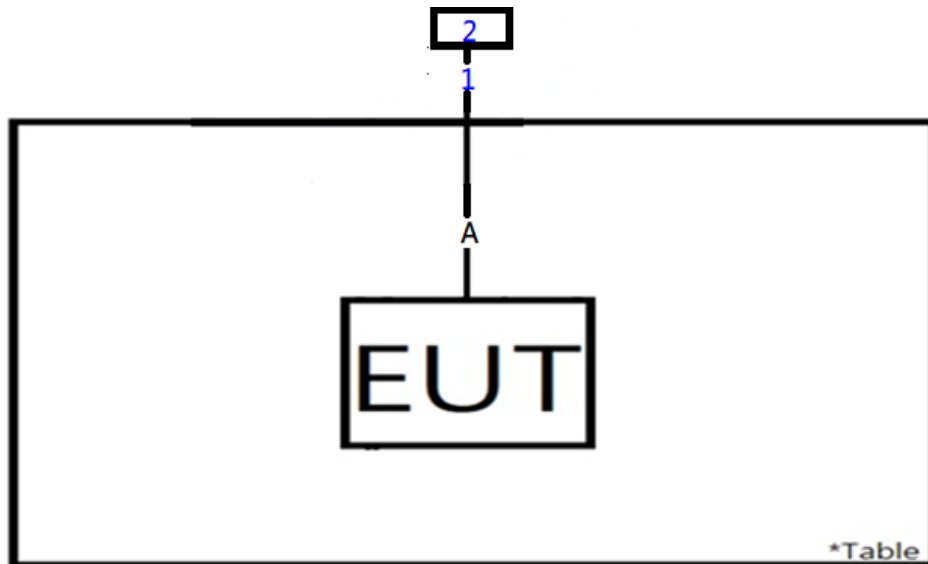

<Mains Conducted Emission mode>

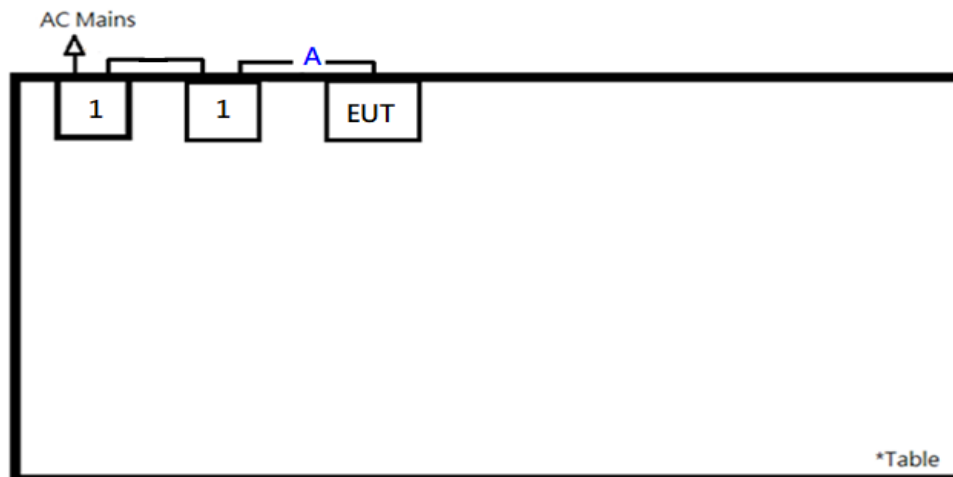

5. Test Results

5.1 Transmitter Requirement & Test Suites

5.1.1 Antenna Requirement

Requirement Use of approved antennas only

According to the manufacturer declaration, the EUT has an antenna with a directional gain of 1.927 dBi. The antenna is a PCB antenna with no possibility of replacement with a non-approved antenna by the end-user. Therefore, the EUT is considered to comply with this provision. Refer to EUT photo for details.

5.1.2 Peak Output Power

Limit

For frequency hopping systems operating in the 2400-2483.5 MHz band employing at least 75 non-overlapping hopping channels, and all frequency hopping systems in the 5725-5850 MHz band: 1 watt. For all other frequency hopping systems in the 2400-2483.5 MHz band: 0.125 watts.

Kind of Test Site Shielded room

Test Setup



Test Instruments

Kind of Equipment	Manufacturer	Type	S/N	Calibration Date	Calibration Due Date	Test Date	
						From	Until
Power Meter	Anritsu	ML2495A	1901008	2021/3/24	2022/3/23	2022/3/3	2022/3/3
Power Sensor	Anritsu	MA2411B	1725269	2021/3/24	2022/3/23	2022/3/3	2022/3/3

Test Procedures

A peak power sensor was used on the output port of the EUT. A power meter was used to read the response of the peak power sensor. Record the power level.

Average power sensor was used to perform output power measurement, trigger and gating function of wide band power meter is enabled to measure max output power of TX on burst. Duty factor is not added to measured value.

Test Result
Peak Output Power
<GFSK>

Channel	Channel Frequency	Peak Output Power		Limit
	(MHz)	(dBm)	(mW)	(mW)
Low Channel	2402	4.26	2.667	125
Middle Channel	2441	4.17	2.612	125
High Channel	2480	4.02	2.523	125

< $\pi/4$ -DQPSK>

Channel	Channel Frequency	Peak Output Power		Limit
	(MHz)	(dBm)	(mW)	(mW)
Low Channel	2402	4.96	3.133	125
Middle Channel	2441	4.86	3.062	125
High Channel	2480	4.71	2.958	125

<8DPSK>

Channel	Channel Frequency	Peak Output Power		Limit
	(MHz)	(dBm)	(mW)	(mW)
Low Channel	2402	5.17	3.289	125
Middle Channel	2441	5.11	3.243	125
High Channel	2480	4.98	3.148	125

Average Power
<GFSK>

Channel	Channel Frequency	Average Power	
	(MHz)	(dBm)	(mW)
Low Channel	2402	3.98	2.500
Middle Channel	2441	3.93	2.472
High Channel	2480	3.79	2.393

< $\pi/4$ -DQPSK>

Channel	Channel Frequency	Average Power	
	(MHz)	(dBm)	(mW)
Low Channel	2402	2.86	1.932
Middle Channel	2441	2.78	1.897
High Channel	2480	2.64	1.837

<8DPSK>

Channel	Channel Frequency	Average Power	
	(MHz)	(dBm)	(mW)
Low Channel	2402	2.86	1.932
Middle Channel	2441	2.78	1.897
High Channel	2480	2.64	1.837

5.1.3 Radiated Spurious Emissions and Band Edges

Limit

Radiated emissions which fall in the restricted bands, as defined in §15.205(a), must comply with the radiated emission limits specified in §15.209(a).

Emissions radiated outside the restricted and authorized frequency bands must either comply with the radiated emission limits specified for the restricted bands or in §15.247(d).

Kind of Test Site 3m Semi-Anechoic Chamber

Test Setup

<Radiated Emissions below 30 MHz>

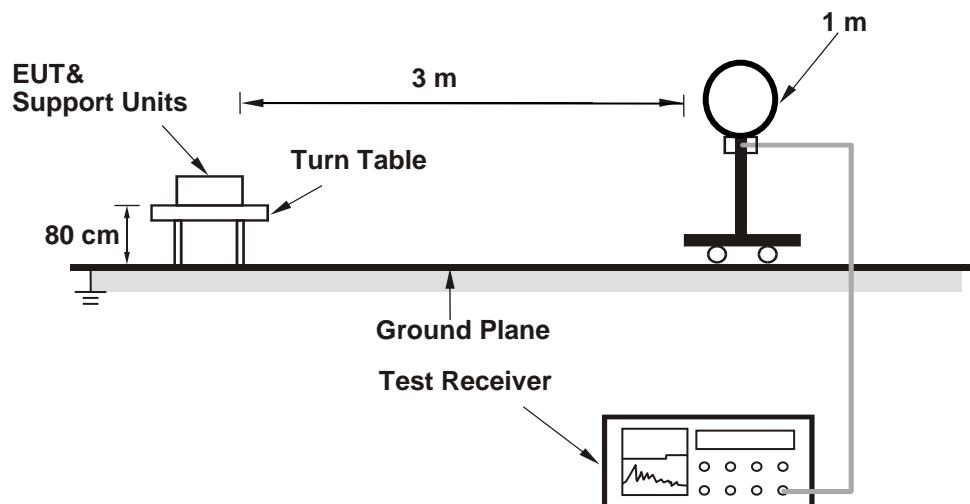

<Radiated Emissions 30 MHz to 1 GHz>

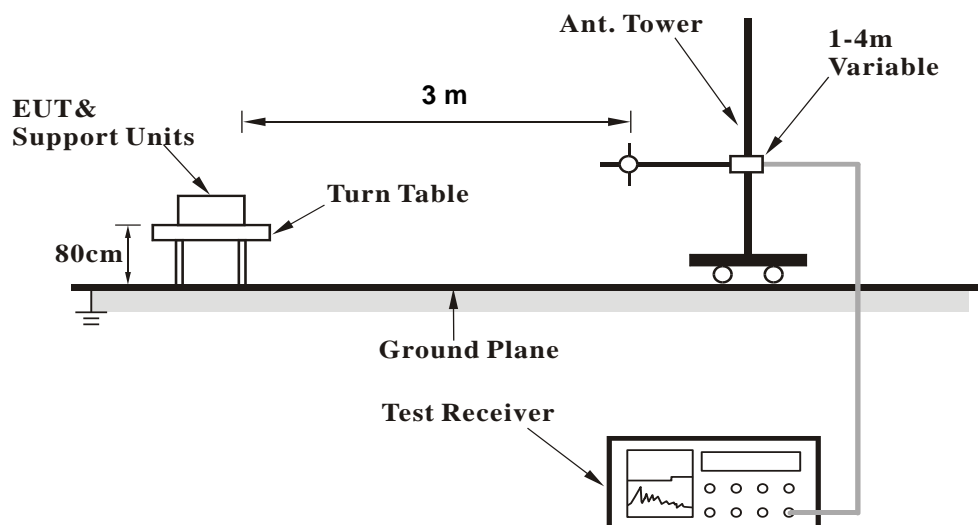

<Radiated Emissions above 1 GHz>

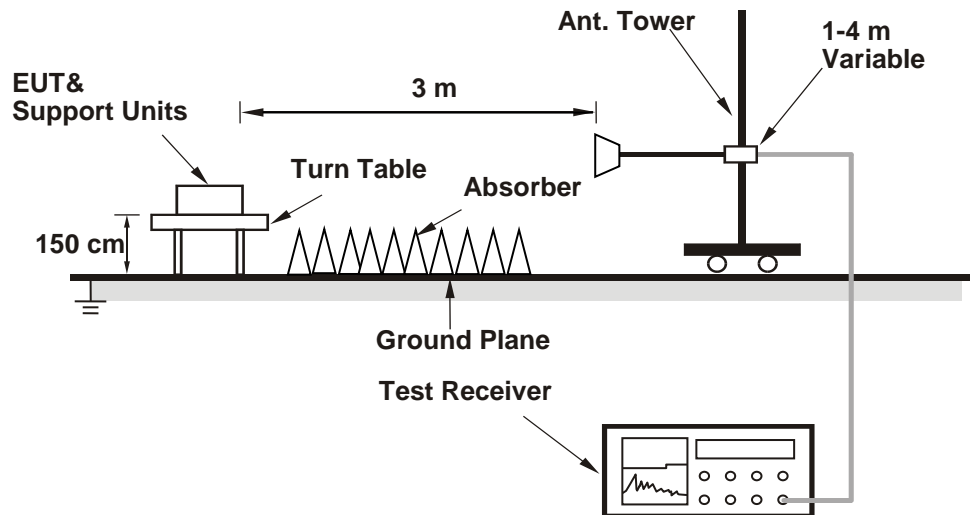

For the actual test configuration, please refer to the attached file (Test Setup Photo).

Test Instruments

Kind of Equipment	Manufacturer	Type	S/N	Calibration Date	Calibration Due Date
Receiver	R&S	ESR7	102109	2021/3/16	2022/3/15
Signal Analyzer	R&S	FSV40	101508	2021/3/16	2022/3/15
Bilog Antenna	SCHWARZBECK	VULB-9168	00951	2021/2/18	2022/2/17
Horn Antenna	ETS-Lindgren	3117	00218930	2021/12/20	2022/12/19
Horn Antenna	SCHWARZBECK	BBHA 9170	00887	2021/4/8	2022/4/7
LF-AMP	Agilent	8447D	2944A10772	2021/2/18	2022/2/17
HF-AMP + AC source	EMCI	EMC051845SE	980633	2021/2/9	2022/2/8
HF-AMP + AC source	EMCI	EMC184045SE	980657	2021/2/1	2022/1/31
HF-AMP + AC source	EMCI	EMC184045SE	980656	2022/1/20	2023/1/19
Microwave Cable	HUBER+SUHNER	SUCOFLEX 104EA	800056/4EA	2021/3/17	2022/3/16
Microwave Cable	HUBER+SUHNER	SUCOFLEX 104	804680/4	2021/3/17	2022/3/16
Microwave Cable	HUBER+SUHNER	SUCOFLEX 104	MY37202/4	2021/3/17	2022/3/16
Microwave Cable	HUBER+SUHNER	SUCOFLEX 102EA	800898/2EA	2021/4/16	2022/4/15
Microwave Cable	HUBER+SUHNER	SUCOFLEX 102EA	800901/2EA	2021/4/16	2022/4/15
Microwave Cable	HUBER+SUHNER	SUCOFLEX 102EA	801027/2EA	2021/4/16	2022/4/15
Loop Antenna	SCHWARZBECK	FMZB1519B	00215	12/8/2021	2022/12/7

Test Procedures**For Radiated Emissions below 30 MHz**

- a. The EUT was placed on the top of a rotating table 0.8 meters above the ground at a 3 meter chamber room. The table was rotated 360 degrees to determine the position of the highest radiation.
- b. The EUT was set 3 meters away from the interference-receiving antenna, which was mounted on the top of a variable-height antenna tower.
- c. Parallel (OPEN), perpendicular (CLOSE), and ground-parallel (GROUND) orientations of the antenna are set to make the measurement.
- d. For each suspected emission, the EUT was arranged to its worst case and the rotatable table was turned from 0 degrees to 360 degrees to find the maximum reading.
- e. The test-receiver system was set to Quasi-Peak Detect Function and Specified Bandwidth with Maximum Hold Mode.

Note:

1. The resolution bandwidth and video bandwidth of test receiver/spectrum analyzer is 9 kHz at frequency below 30 MHz.
2. All modes of operation were investigated and the worst-case emissions are reported.

For Radiated Emissions above 30 MHz

- a. The EUT was placed on the top of a rotating table 0.8 meters (for 30 MHz ~ 1 GHz) / 1.5 meters (for above 1 GHz) above the ground at 3 meter chamber room for test. The table was rotated 360 degrees to determine the position of the highest radiation.
- b. The EUT was set 3 meters away from the interference-receiving antenna, which was mounted on the top of a variable-height antenna tower.
- c. The height of antenna is varied from one meter to four meters above the ground to determine the maximum value of the field strength. Both horizontal and vertical polarizations of the antenna are set to make the measurement.
- d. For each suspected emission, the EUT was arranged to its worst case and then the antenna was tuned to heights from 1 meter to 4 meters and the rotatable table was turned from 0 degrees to 360 degrees to find the maximum reading.
- e. The test-receiver system was set to quasi-peak detect function and specified bandwidth with maximum hold mode when the test frequency is below 1 GHz.
- f. The test-receiver system was set to peak and average detected function and specified bandwidth with maximum hold mode when the test frequency is above 1 GHz. If the peak reading value also meets average limit, measurement with the average detector is unnecessary.

Note:

1. The resolution bandwidth and video bandwidth of test receiver/spectrum analyzer is 120 kHz for Quasi-peak detection (QP) or Peak detection (PK) at frequency below 1 GHz.
2. The resolution bandwidth of test receiver/spectrum analyzer is 1 MHz and the video bandwidth is 3 MHz for Peak detection (PK) at frequency above 1 GHz.
3. The resolution bandwidth of test receiver/spectrum analyzer is 1 MHz and the video bandwidth is $\geq 1/T$ (Duty cycle < 98 %) or 10 Hz (Duty cycle ≥ 98 %) for Average detection (AV) at frequency above 1 GHz.
4. For fundamental frequency: The average value is "Average = Peak value + 20log(Duty cycle)
Where the duty factor is calculated from following formula for DH5 packet type which has worst duty factor:
 $20\log(\text{Duty cycle}) = 20\log(\text{dwell time} / 100\text{ms}) = 20\log(3.125 / 100) = -30.1 \text{ dB}$
5. All modes of operation were investigated and the worst-case emissions are reported.

6. The Radiated Emissions testing was performed in the X(E1), Y(H) and Z(E2) axis orientation.
The worst-case Axis orientation is recorded in this test report.

Test Results

Factor (dB/m) = Antenna Factor (dB/m) + Cable Loss (dB)

Level (dBuV/m) = Reading (dBuV) + Factor (dB/m)

Please refer to Appendix A.

5.2 Mains Emission

5.2.1 Mains Conducted Emission

Limit

Mains Conducted Emission as defined in §15.207 must comply with the mains conducted emission limits.

Kind of Test Site Shielded room

Test Setup

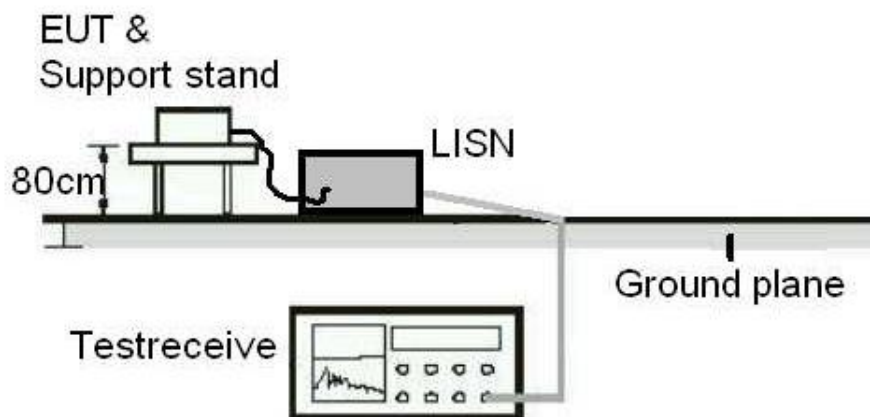

Test Instruments

Kind of Equipment	Manufacturer	Type	S/N	Calibration Date	Calibration Due Date
RF Cable	N/A	N/A	EMC-003	2021/3/16	2022/3/15
Two-Line V-Network	Rohde & Schwarz	ENV216	101938	2021/9/23	2022/9/22
EMI Test Receiver	R&S	ESCI	1816063	2021/11/15	2022/11/14

Test Procedures

- a. The EUT was placed 0.4 meters from the conducting wall of the shielded room with EUT being connected to the power mains through a line impedance stabilization network (LISN). Other support units were connected to the power mains through another LISN. The two LISNs provide 50 ohm/50 uH of coupling impedance for the measuring instrument.
- b. Both lines of the power mains connected to the EUT were checked for maximum conducted interference.
- c. The frequency range from 150 kHz to 30 MHz was searched. Emission levels under (Limit – 20 dB) was not recorded.

Note: The resolution bandwidth and video bandwidth of test receiver is 9 kHz for quasi-peak detection (QP) and average detection (AV) at frequency 0.15 MHz – 30 MHz.

Test Results

Please refer to Appendix A.

Appendix A: Test Results of Radiated Spurious Emissions & Mains Conducted Emission Test

Band Edges, 2.31GHz ~ 2.9GHz

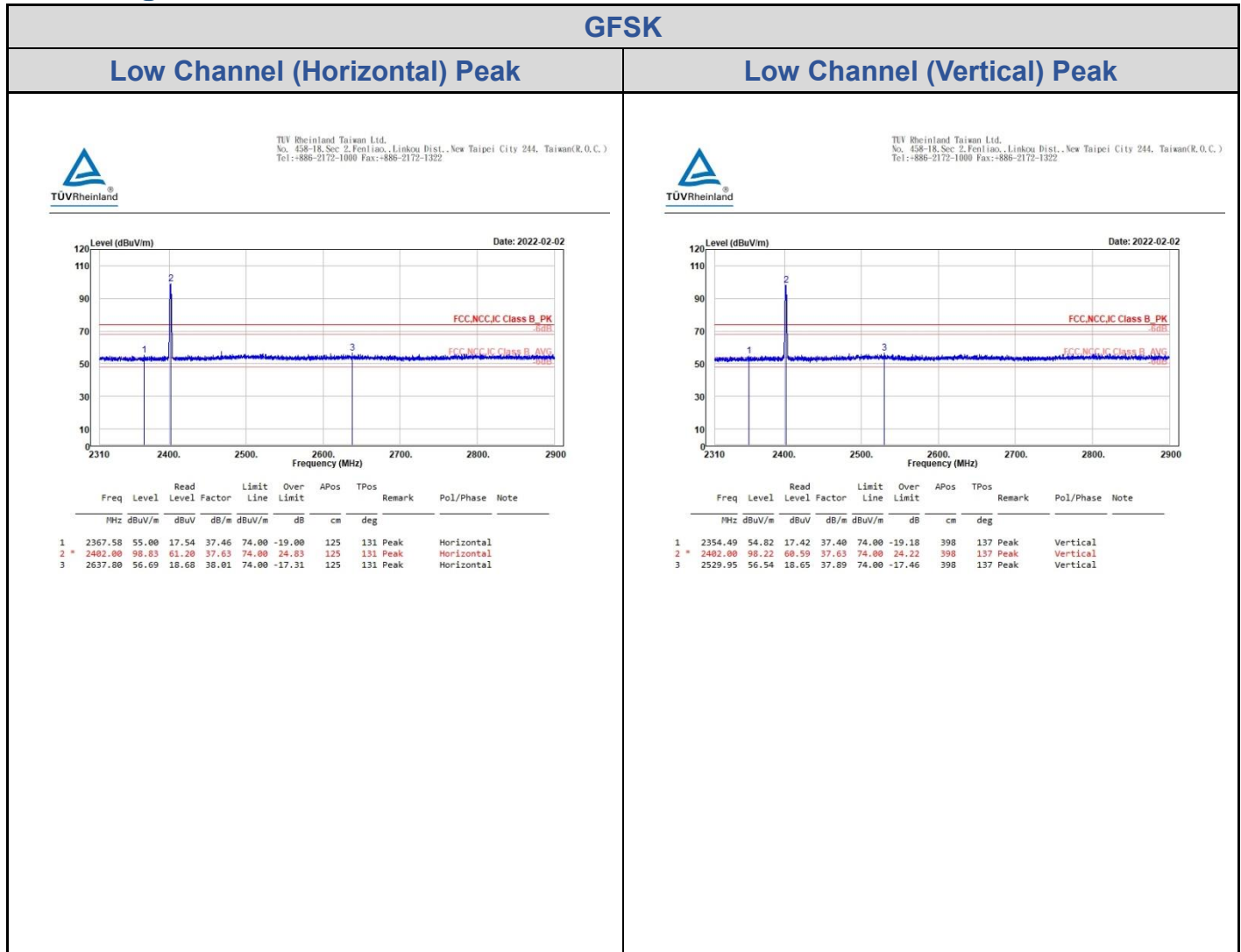

GFSK

Low Channel (Horizontal) Average

Low Channel (Vertical) Average



TÜV Rheinland Taiwan Ltd.
No. 438-18, Sec. 2, Fenhiao, Linkou Dist., New Taipei City 244, Taiwan(R.O.C.)
Tel: +886-2172-1000 Fax: +886-2172-1322

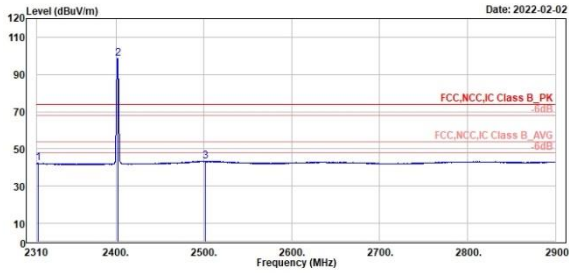

Freq	Level	Read	Level	Factor	Limit	Over	APos	TPos	Remark	Pol/Phase	Note
MHz	dBuV/m	dBuV	dB/m	dBuV/m	dB	cm	cm	deg			
1	2311.42	42.29	5.04	37.25	54.00	-11.71	125	131	Average	Horizontal	
2 *	2402.00	98.46	60.83	37.63	54.00	44.46	125	131	Average	Horizontal	
3	2501.40	43.46	5.61	37.85	54.00	-10.54	125	131	Average	Horizontal	



TÜV Rheinland Taiwan Ltd.
No. 438-18, Sec. 2, Fenhiao, Linkou Dist., New Taipei City 244, Taiwan(R.O.C.)
Tel: +886-2172-1000 Fax: +886-2172-1322

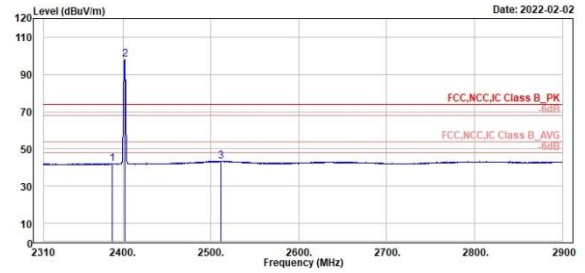

Freq	Level	Read	Level	Factor	Limit	Over	APos	TPos	Remark	Pol/Phase	Note
MHz	dBuV/m	dBuV	dB/m	dBuV/m	dB	cm	cm	deg			
1	2387.64	42.10	4.53	37.57	54.00	-11.90	398	137	Average	Vertical	
2 *	2402.00	97.89	60.26	37.63	54.00	43.89	398	137	Average	Vertical	
3	2511.19	43.44	5.58	37.86	54.00	-10.56	398	137	Average	Vertical	

GFSK
High Channel (Horizontal) Peak
High Channel (Vertical) Peak

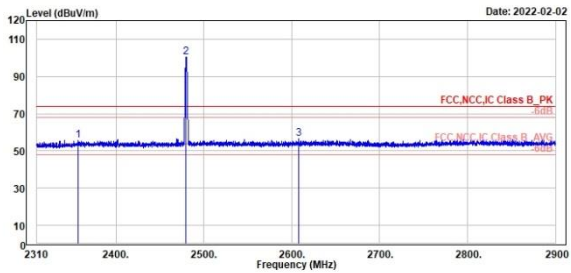

TÜV Rheinland Taiwan Ltd.
 No. 438-18, Sec. 2, Fenliao, Linkou Dist., New Taipei City 244, Taiwan(R.O.C.)
 Tel: +886-2172-1000 Fax: +886-2172-1322



Peak	Freq (MHz)	Level (dBuV/m)	Read Level (dBuV)	Level Factor (dB/m)	Limit Line (dBuV/m)	Over Limit (dB)	APos (cm)	TPos (deg)	Remark	Pol/Phase	Note
1	2356.73	55.60	18.19	37.41	74.00	-18.40	121	131	Peak	Horizontal	
2 *	2480.00	100.35	62.56	37.79	74.00	26.35	121	131	Peak	Horizontal	
3	2607.60	56.47	18.49	37.98	74.00	-17.53	121	131	Peak	Horizontal	

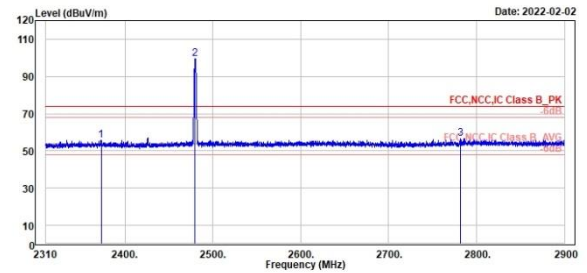

TÜV Rheinland Taiwan Ltd.
 No. 438-18, Sec. 2, Fenliao, Linkou Dist., New Taipei City 244, Taiwan(R.O.C.)
 Tel: +886-2172-1000 Fax: +886-2172-1322



Peak	Freq (MHz)	Level (dBuV/m)	Read Level (dBuV)	Level Factor (dB/m)	Limit Line (dBuV/m)	Over Limit (dB)	APos (cm)	TPos (deg)	Remark	Pol/Phase	Note
1	2373.01	55.04	18.35	37.49	74.00	-18.16	326	141	Peak	Vertical	
2 *	2480.00	99.58	61.79	37.79	74.00	25.58	326	141	Peak	Vertical	
3	2781.76	56.49	18.31	38.18	74.00	-17.51	326	141	Peak	Vertical	

GFSK

High Channel (Horizontal) Average

High Channel (Vertical) Average



TÜV Rheinland Taiwan Ltd.
No. 438-18, Sec. 2, Fenliao, Linkou Dist., New Taipei City 244, Taiwan(R.O.C.)
Tel: +886-2172-1000 Fax: +886-2172-1322

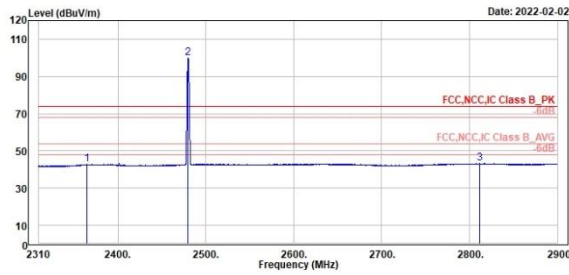

Freq	Level	Read	Level	Factor	Limit	Over	APos	TPos	Remark	Pol/Phase	Note
MHz	dBuV/m	dBuV	dB/m	dBuV/m	dB	cm	cm	deg			
1	2364.99	42.71	5.26	37.45	54.00	-11.29	121	131	Average	Horizontal	
2 *	2480.00	99.00	62.01	37.79	54.00	45.00	121	131	Average	Horizontal	
3	2811.38	43.24	5.04	38.20	54.00	-10.76	121	131	Average	Horizontal	



TÜV Rheinland Taiwan Ltd.
No. 438-18, Sec. 2, Fenliao, Linkou Dist., New Taipei City 244, Taiwan(R.O.C.)
Tel: +886-2172-1000 Fax: +886-2172-1322

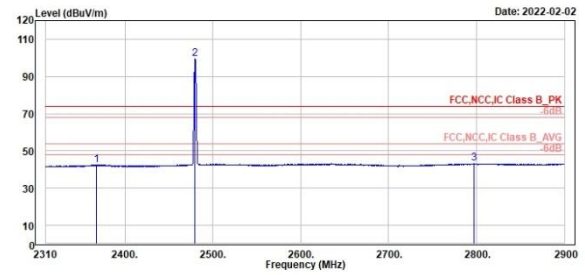

Freq	Level	Read	Level	Factor	Limit	Over	APos	TPos	Remark	Pol/Phase	Note
MHz	dBuV/m	dBuV	dB/m	dBuV/m	dB	cm	cm	deg			
1	2368.06	42.49	5.03	37.46	54.00	-11.51	326	141	Average	Vertical	
2 *	2480.00	99.27	61.48	37.79	54.00	45.27	326	141	Average	Vertical	
3	2797.10	43.25	5.05	38.20	54.00	-10.75	326	141	Average	Vertical	

8DPSK

Low Channel (Horizontal) Peak

Low Channel (Vertical) Peak

TÜVRheinland
TUV Rheinland Taiwan Ltd.
No. 438-18, Sec. 2, Fenliao, Linkou Dist., New Taipei City 244, Taiwan(R.O.C.)
Tel: +886-2172-1000 Fax: +886-2172-1322

TÜVRheinland
TUV Rheinland Taiwan Ltd.
No. 438-18, Sec. 2, Fenliao, Linkou Dist., New Taipei City 244, Taiwan(R.O.C.)
Tel: +886-2172-1000 Fax: +886-2172-1322

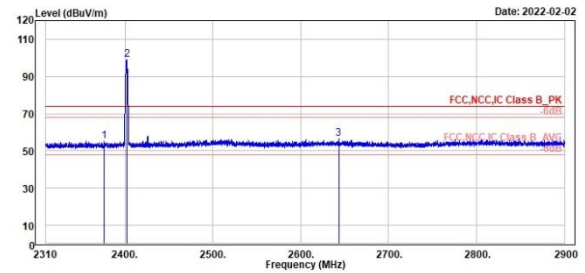
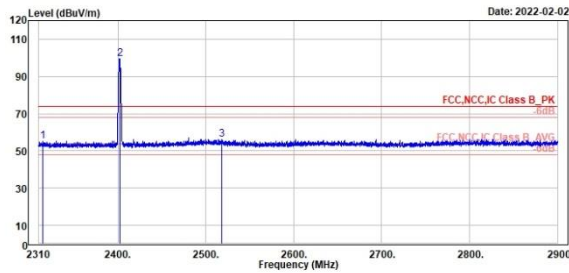

Freq	Level	Read	Limit	Over	APos	TPos	Remark	Pol/Phase	Note
MHz	dBuV/m	dBuV	dB/m	dBuV/m	dB	cm	deg		
1	2314.68	55.35	18.09	37.26	74.00	-18.65	124	138 Peak	Horizontal
2 *	2482.00	99.55	61.92	37.63	74.00	25.55	124	138 Peak	Horizontal
3	2518.62	56.23	18.36	37.87	74.00	-17.77	124	138 Peak	Horizontal

Freq	Level	Read	Limit	Over	APos	TPos	Remark	Pol/Phase	Note
MHz	dBuV/m	dBuV	dB/m	dBuV/m	dB	cm	deg		
1	2376.20	55.32	17.82	37.50	74.00	-18.68	398	138 Peak	Vertical
2 *	2482.00	98.96	61.33	37.63	74.00	24.96	398	138 Peak	Vertical
3	2643.11	56.67	18.65	38.02	74.00	-17.33	398	138 Peak	Vertical

8DPSK
Low Channel (Horizontal) Average
Low Channel (Vertical) Average

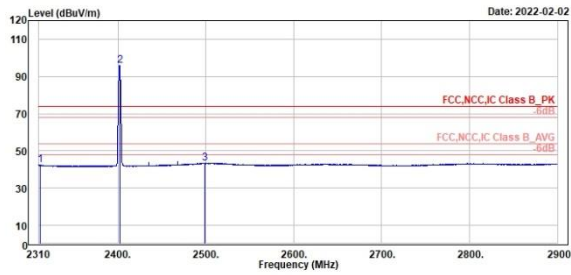

TÜV Rheinland Taiwan Ltd.
 No. 438-18, Sec. 2, Fenliao, Linkou Dist., New Taipei City 244, Taiwan(R.O.C.)
 Tel: +886-2172-1000 Fax: +886-2172-1322



1	2	3	4	5	6	7	8	9	10	11	12	13	14	15	16	17	18	19	20
MHz	Level	Read	Level	Factor	Limit	Over	Apos	TPos	Remark	Pol/Phase	Note								
MHz	dBuV/m	dBuV	dB/m	dBuV/m	dB	cm	deg												
2311.38	42.40	5.15	37.25	54.00	-11.60	124	130	Average	Horizontal										
2402.00	95.78	50.15	37.63	54.00	41.78	124	130	average	Horizontal										
2498.80	43.44	5.59	37.85	54.00	-10.56	124	130	Average	Horizontal										

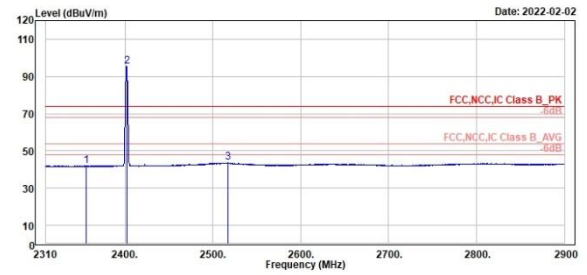

TÜV Rheinland Taiwan Ltd.
 No. 438-18, Sec. 2, Fenliao, Linkou Dist., New Taipei City 244, Taiwan(R.O.C.)
 Tel: +886-2172-1000 Fax: +886-2172-1322



1	2	3	4	5	6	7	8	9	10	11	12	13	14	15	16	17	18	19	20
MHz	Level	Read	Level	Factor	Limit	Over	Apos	TPos	Remark	Pol/Phase	Note								
MHz	dBuV/m	dBuV	dB/m	dBuV/m	dB	cm	deg												
2356.49	42.05	4.64	37.41	54.00	-11.95	398	138	Average	Vertical										
2402.00	95.23	57.60	37.63	54.00	41.23	398	138	Average	Vertical										
2516.85	43.63	5.76	37.87	54.00	-10.37	398	138	Average	Vertical										

8DPSK

High Channel (Horizontal) Peak

High Channel (Vertical) Peak



TÜV Rheinland Taiwan Ltd.
No. 438-18, Sec. 2, Fenliao, Linkou Dist., New Taipei City 244, Taiwan(R.O.C.)
Tel: +886-2172-1000 Fax: +886-2172-1322

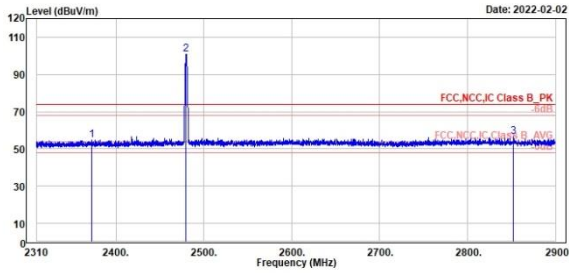

Peak	Freq (MHz)	Level (dBuV/m)	Read Level (dBuV)	Level Factor (dB/m)	Limit Line (dBuV/m)	Over Limit (dB)	APos (cm)	TPos (deg)	Remark	Pol/Phase	Note
1	2372.54	54.76	17.27	37.49	74.00	-19.24	299	55	Peak	Horizontal	
2 *	2480.00	100.64	62.85	37.79	74.00	26.64	299	55	Peak	Horizontal	
3	2852.33	56.73	18.55	38.18	74.00	-17.27	299	55	Peak	Horizontal	



TÜV Rheinland Taiwan Ltd.
No. 438-18, Sec. 2, Fenliao, Linkou Dist., New Taipei City 244, Taiwan(R.O.C.)
Tel: +886-2172-1000 Fax: +886-2172-1322

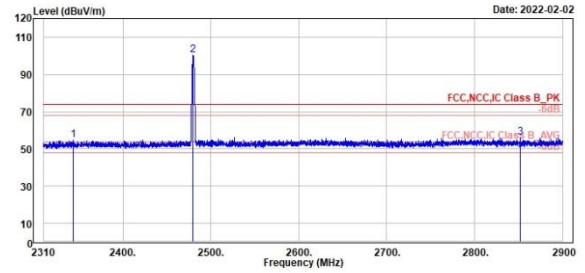

Peak	Freq (MHz)	Level (dBuV/m)	Read Level (dBuV)	Level Factor (dB/m)	Limit Line (dBuV/m)	Over Limit (dB)	APos (cm)	TPos (deg)	Remark	Pol/Phase	Note
1	2343.87	54.55	17.19	37.36	74.00	-19.45	327	142	Peak	Vertical	
2 *	2480.00	100.20	62.41	37.79	74.00	26.20	327	142	Peak	Vertical	
3	2851.74	56.12	17.94	38.18	74.00	-17.88	327	142	Peak	Vertical	

8DPSK

High Channel (Horizontal) Average

High Channel (Vertical) Average



TUV Rheinland Taiwan Ltd.
No. 438-18, Sec. 2, Fenliao, Linkou Dist., New Taipei City 244, Taiwan(R.O.C.)
Tel: +886-2172-1000 Fax: +886-2172-1322

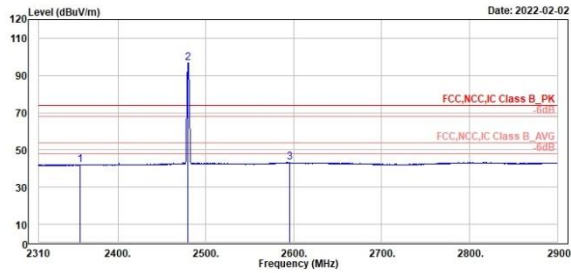

1	2	3	Read Level	Level Factor	Limit Line	Over Limit	APos	TPos	Remark	Pol/Phase	Note
MHz	dBuV/m	dBuV	dB/m	dBuV/m	dB	cm	deg				
2357.32	42.18	4.77	37.41	54.00	-11.82	299	55	Average	Horizontal		
2480.00	96.89	59.10	37.79	54.00	42.89	299	55	Average	Horizontal		
2595.56	43.24	5.28	37.96	54.00	-10.76	299	55	Average	Horizontal		



TUV Rheinland Taiwan Ltd.
No. 438-18, Sec. 2, Fenliao, Linkou Dist., New Taipei City 244, Taiwan(R.O.C.)
Tel: +886-2172-1000 Fax: +886-2172-1322

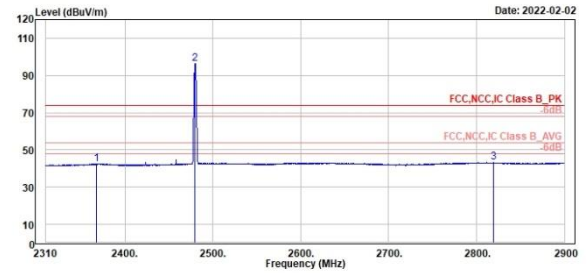

1	2	3	Read Level	Level Factor	Limit Line	Over Limit	APos	TPos	Remark	Pol/Phase	Note
MHz	dBuV/m	dBuV	dB/m	dBuV/m	dB	cm	deg				
2367.47	42.53	5.07	37.46	54.00	-11.47	327	142	Average	Vertical		
2480.00	96.41	58.62	37.79	54.00	42.41	327	142	Average	Vertical		
2819.41	43.16	4.97	38.19	54.00	-10.84	327	142	Average	Vertical		

Spurious Emissions, Tx Mode, 9kHz ~ 30MHz

8DPSK

Low Channel 9kHz~150kHz(Open)

Low Channel 150kHz~30MHz(Open)



TUV Rheinland Taiwan Ltd.
No. 458-18, Sec 2, Fenliao, Linkou Dist., New Taipei City 244, Taiwan(R.O.C.)
Tel:+886-2172-1000 Fax:+886-2172-1322

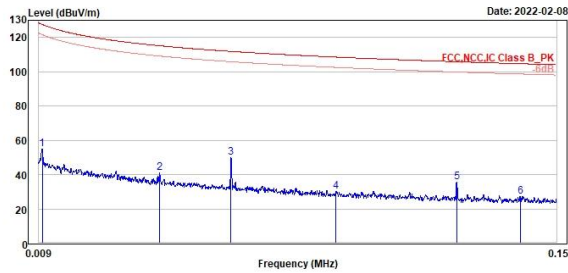

	Freq	Level	Read	Limit	Over	APos	TPos	Remark	Pol/Phase	Note
	MHz	dBuV/m	dBuV	dB/m	dBuV/m	dB	cm	deg		
1	0.01	54.76	37.02	17.74	127.60	-72.04	100	346 QP	Open	
2	0.04	41.02	21.59	19.43	115.14	-74.12	100	92 QP	Open	
3	0.06	49.68	30.58	19.10	111.83	-62.15	100	352 QP	Open	
4	0.09	30.30	11.82	18.48	108.52	-78.22	100	178 QP	Open	
5	0.12	35.77	17.43	18.34	105.81	-70.04	100	82 QP	Open	
6	0.14	27.27	6.87	18.40	104.67	-77.40	100	305 QP	Open	



TUV Rheinland Taiwan Ltd.
No. 458-18, Sec 2, Fenliao, Linkou Dist., New Taipei City 244, Taiwan(R.O.C.)
Tel:+886-2172-1000 Fax:+886-2172-1322

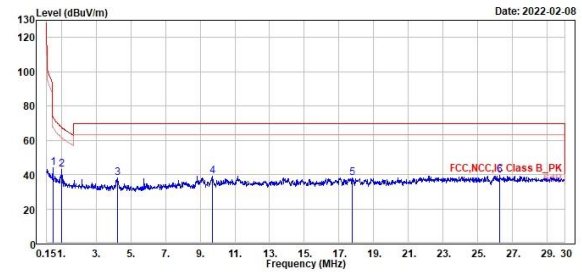

	Freq	Level	Read	Limit	Over	APos	TPos	Remark	Pol/Phase	Note
	MHz	dBuV/m	dBuV	dB/m	dBuV/m	dB	cm	deg		
1	0.51	44.00	25.09	18.99	73.40	-29.40	100	245 QP	Open	
2	1.02	43.17	23.86	19.31	67.47	-24.30	100	178 QP	Open	
3	4.24	38.15	18.73	19.42	69.50	-31.35	100	57 QP	Open	
4	9.70	38.99	17.73	21.26	69.50	-30.51	100	0 QP	Open	
5	17.75	38.19	16.29	21.90	69.50	-31.31	100	259 QP	Open	
6	26.27	39.50	17.21	22.29	69.50	-30.00	100	320 QP	Open	

8DPSK

Low Channel 9kHz~150kHz(Close)

Low Channel 150kHz~30MHz(Close)



TUV Rheinland Taiwan Ltd.
No. 458-18, Sec 2, Fenliao, Linkou Dist., New Taipei City 244, Taiwan(R.O.C.)
Tel: +886-2172-1000 Fax: +886-2172-1322

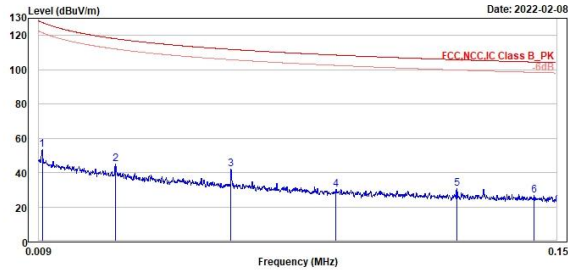

1	2	3	4	5	6
0.01	0.03	0.06	0.09	0.12	0.14
53.52	44.80	42.03	30.36	30.78	26.77
35.78	25.26	22.93	11.88	12.44	8.36
17.74	19.54	19.10	18.48	18.34	18.41
127.60	118.07	111.83	108.52	105.81	104.43
-74.88	-73.27	-69.80	-78.16	-75.03	-77.66
100	100	100	100	100	100
72 QP	89 QP	17 QP	257 QP	54 QP	156 QP
Close	Close	Close	Close	Close	Close



TUV Rheinland Taiwan Ltd.
No. 458-18, Sec 2, Fenliao, Linkou Dist., New Taipei City 244, Taiwan(R.O.C.)
Tel: +886-2172-1000 Fax: +886-2172-1322

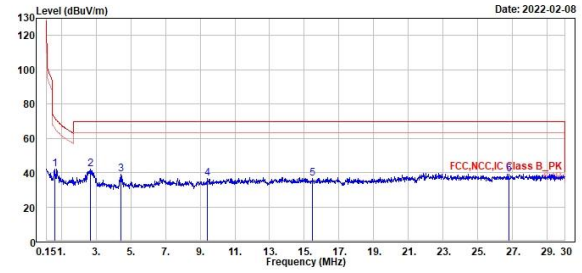

1	2	3	4	5	6
0.61	2.67	4.45	9.40	15.46	26.79
42.23	42.16	39.28	36.59	36.76	39.21
23.17	22.66	19.88	15.45	15.01	16.91
19.06	19.50	19.40	21.14	21.75	22.30
71.86	69.50	69.50	69.50	69.50	69.50
-29.63	-27.34	-30.22	-32.91	-32.74	-30.29
100	100	100	100	100	100
123 QP	89 QP	0 QP	234 QP	239 QP	20 QP
Close	Close	Close	Close	Close	Close

Spurious Emissions, Tx Mode, 30MHz ~ 1GHz
8DPSK
Low Channel (Horizontal)
Low Channel (Vertical)

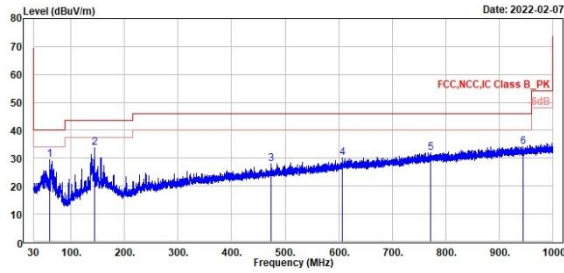

TÜV Rheinland Taiwan Ltd.
 No. 438-18, Sec. 2, Fenliao, Linkou Dist., New Taipei City 244, Taiwan(R.O.C.)
 Tel: +886-2172-1000 Fax: +886-2172-1322



Freq	Level	Read	Limit	Over	APos	TPos	Remark	Pol/Phase	Note
MHz	dBuV/m	dBuV	dB/m	dBuV/m	dB	cm	deg		
1	68.87	29.66	38.33	-8.67	48.00	-18.34	490	272 QP	Horizontal
2	143.59	33.71	41.30	-7.59	43.58	-9.79	290	273 QP	Horizontal
3	473.58	27.84	31.27	-3.43	46.00	-18.16	100	314 QP	Horizontal
4	687.44	29.98	31.08	-1.10	46.00	-16.02	200	75 QP	Horizontal
5	772.44	32.07	38.50	1.57	46.00	-13.93	300	53 QP	Horizontal
6	945.29	34.19	29.99	4.20	46.00	-11.81	200	368 QP	Horizontal

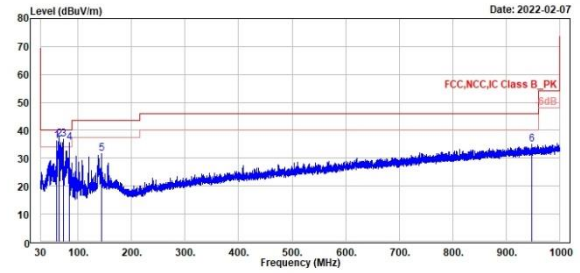

TÜV Rheinland Taiwan Ltd.
 No. 438-18, Sec. 2, Fenliao, Linkou Dist., New Taipei City 244, Taiwan(R.O.C.)
 Tel: +886-2172-1000 Fax: +886-2172-1322



Freq	Level	Read	Limit	Over	APos	TPos	Remark	Pol/Phase	Note
MHz	dBuV/m	dBuV	dB/m	dBuV/m	dB	cm	deg		
1	59.97	36.06	44.72	-8.66	48.00	-3.94	100	269 QP	Vertical
2	64.73	36.86	46.32	-9.46	48.00	-3.14	100	299 QP	Vertical
3	71.90	36.92	47.31	-10.39	48.00	-3.08	100	131 QP	Vertical
4	83.74	35.69	48.65	-12.96	48.00	-4.31	100	152 QP	Vertical
5	143.88	31.69	39.38	-7.61	43.58	-11.81	100	115 QP	Vertical
6	947.72	35.13	38.87	4.26	46.00	-18.87	179	368 QP	Vertical

Spurious Emissions, Tx Mode, 1GHz ~ 26.5GHz

GFSK

Low Channel (Horizontal)

Low Channel (Vertical)



TÜV Rheinland Taiwan Ltd.
No. 438-18, Sec. 2, Fenliao, Linkou Dist., New Taipei City 244, Taiwan(R.O.C.)
Tel: +886-2172-1000 Fax: +886-2172-1322

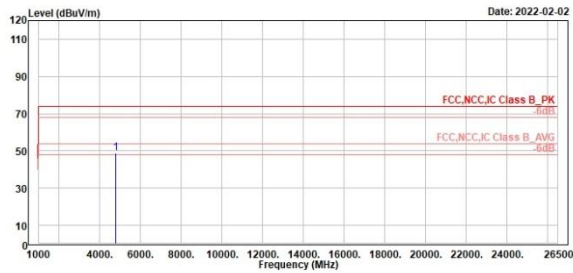

1	4884.00	48.82	58.69	-9.87	74.00	-25.18	308	360	Peak	Horizontal
---	---------	-------	-------	-------	-------	--------	-----	-----	------	------------



TÜV Rheinland Taiwan Ltd.
No. 438-18, Sec. 2, Fenliao, Linkou Dist., New Taipei City 244, Taiwan(R.O.C.)
Tel: +886-2172-1000 Fax: +886-2172-1322

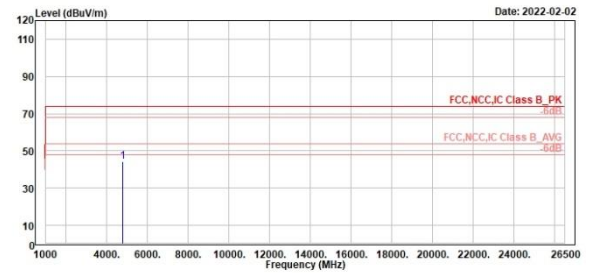

1	4884.00	44.40	54.27	-9.87	74.00	-29.60	300	35	Peak	Vertical
---	---------	-------	-------	-------	-------	--------	-----	----	------	----------

GFSK

Middle Channel (Horizontal)

Middle Channel (Vertical)



TÜV Rheinland Taiwan Ltd.
No. 438-18, Sec. 2, Fenliao, Linkou Dist., New Taipei City 244, Taiwan(R.O.C.)
Tel: +886-2172-1000 Fax: +886-2172-1322

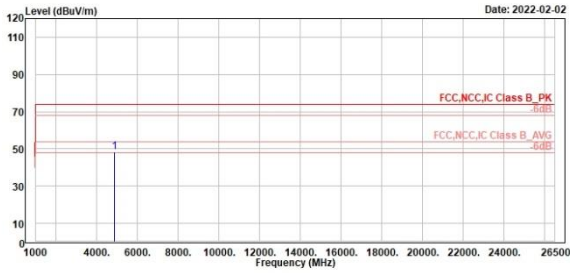

1	4882.00	48.55	58.33	-9.78	74.00	-25.45	149	360	Peak	Horizontal
---	---------	-------	-------	-------	-------	--------	-----	-----	------	------------



TÜV Rheinland Taiwan Ltd.
No. 438-18, Sec. 2, Fenliao, Linkou Dist., New Taipei City 244, Taiwan(R.O.C.)
Tel: +886-2172-1000 Fax: +886-2172-1322

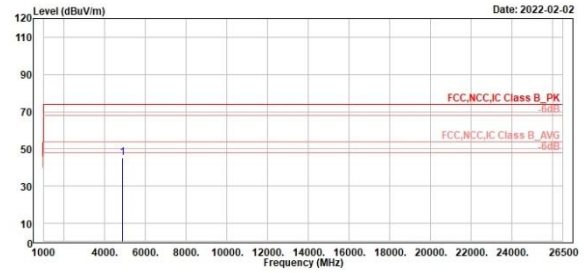

1	4882.00	45.00	54.78	-9.78	74.00	-29.00	300	83	Peak	Vertical
---	---------	-------	-------	-------	-------	--------	-----	----	------	----------

GFSK

High Channel (Horizontal)

High Channel (Vertical)



TÜV Rheinland Taiwan Ltd.
No. 438-18, Sec. 2, Fenliao, Linkou Dist., New Taipei City 244, Taiwan(R.O.C.)
Tel: +886-2172-1000 Fax: +886-2172-1322

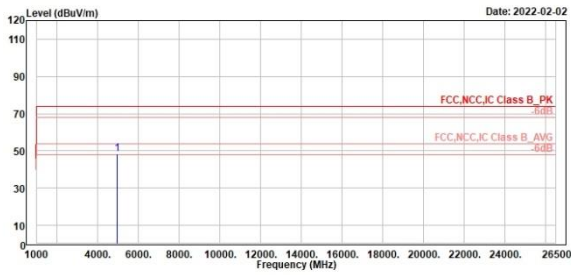

1	4960.00	48.15	57.69	-9.54	74.00	-25.85	200	360	Peak	Horizontal
---	---------	-------	-------	-------	-------	--------	-----	-----	------	------------



TÜV Rheinland Taiwan Ltd.
No. 438-18, Sec. 2, Fenliao, Linkou Dist., New Taipei City 244, Taiwan(R.O.C.)
Tel: +886-2172-1000 Fax: +886-2172-1322

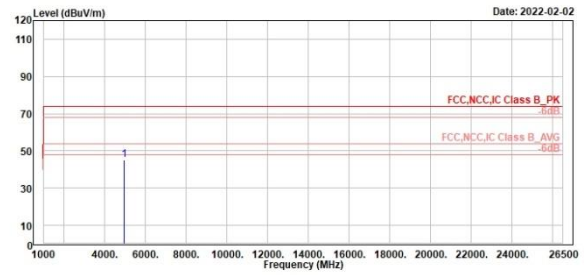

1	4960.00	44.97	54.51	-9.54	74.00	-29.03	400	58	Peak	Vertical
---	---------	-------	-------	-------	-------	--------	-----	----	------	----------

8DPSK

Low Channel (Horizontal)

Low Channel (Vertical)



TÜV Rheinland Taiwan Ltd.
No. 438-18, Sec. 2, Fenhiao, Linkou Dist., New Taipei City 244, Taiwan(R.O.C.)
Tel: +886-2172-1000 Fax: +886-2172-1322

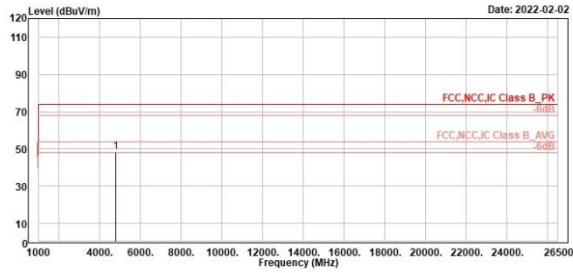

1	4884.00	48.30	58.17	-9.87	74.00	-25.70	200	0	Peak	Horizontal
---	---------	-------	-------	-------	-------	--------	-----	---	------	------------



TÜV Rheinland Taiwan Ltd.
No. 438-18, Sec. 2, Fenhiao, Linkou Dist., New Taipei City 244, Taiwan(R.O.C.)
Tel: +886-2172-1000 Fax: +886-2172-1322

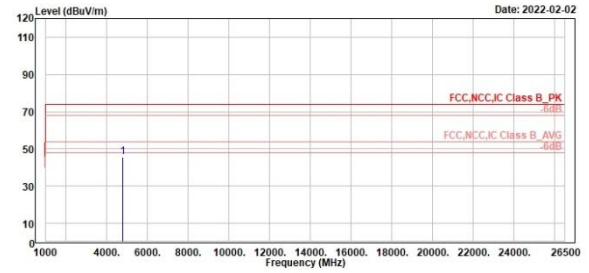

1	4884.00	45.68	55.55	-9.87	74.00	-28.32	300	50	Peak	Vertical
---	---------	-------	-------	-------	-------	--------	-----	----	------	----------

8DPSK

Middle Channel (Horizontal)

Middle Channel (Vertical)



TÜV Rheinland Taiwan Ltd.
No. 438-18, Sec. 2, Fenhiao, Linkou Dist., New Taipei City 244, Taiwan(R.O.C.)
Tel: +886-2172-1000 Fax: +886-2172-1322

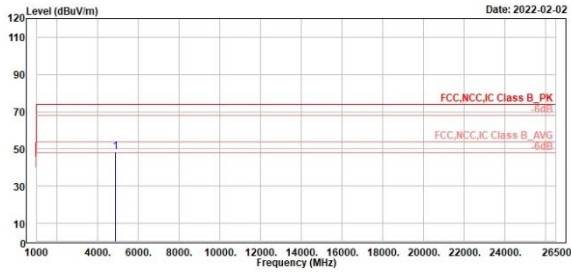

Freq	Level	Read Level	Factor	Limit Line	Over Limit	APos	TPos	Remark	Pol/Phase	Note
MHz	dBuV/m	dBuV	dB/m	dBuV/m	dB	cm	deg			
1 4882.00	48.26	58.04	-9.78	74.00	-25.74	119	360	Peak	Horizontal	



TÜV Rheinland Taiwan Ltd.
No. 438-18, Sec. 2, Fenhiao, Linkou Dist., New Taipei City 244, Taiwan(R.O.C.)
Tel: +886-2172-1000 Fax: +886-2172-1322

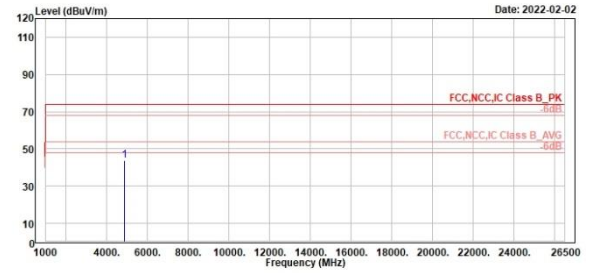

Freq	Level	Read Level	Factor	Limit Line	Over Limit	APos	TPos	Remark	Pol/Phase	Note
MHz	dBuV/m	dBuV	dB/m	dBuV/m	dB	cm	deg			
1 4882.00	43.86	53.64	-9.78	74.00	-30.14	300	84	Peak	Vertical	

8DPSK

High Channel (Horizontal)

High Channel (Vertical)



TÜV Rheinland Taiwan Ltd.
No. 438-18, Sec. 2, Fenhiao, Linkou Dist., New Taipei City 244, Taiwan(R.O.C.)
Tel: +886-2172-1000 Fax: +886-2172-1322

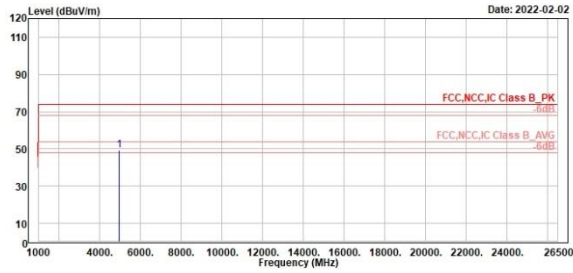

1	4960.00	49.26	58.80	-9.54	74.00	-24.74	259	0	Peak	Horizontal
---	---------	-------	-------	-------	-------	--------	-----	---	------	------------



TÜV Rheinland Taiwan Ltd.
No. 438-18, Sec. 2, Fenhiao, Linkou Dist., New Taipei City 244, Taiwan(R.O.C.)
Tel: +886-2172-1000 Fax: +886-2172-1322

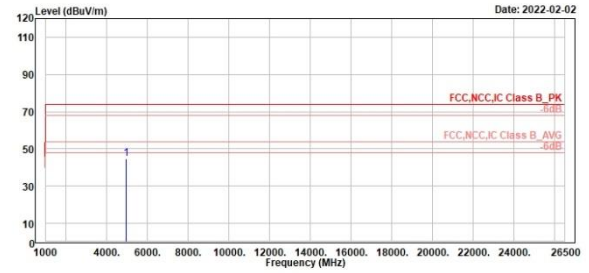

1	4960.00	44.86	54.40	-9.54	74.00	-29.14	480	234	Peak	Vertical
---	---------	-------	-------	-------	-------	--------	-----	-----	------	----------

Mains Conducted Emission, 150kHz ~ 30MHz

Worst Band

(Line)

(Neutral)



TÜV Rheinland Taiwan Ltd.
No. 458-18, Sec. 2, Fenhiao, Linkou Dist., New Taipei City 244, Taiwan(R.O.C.)
Tel: +886-2112-1000 Fax: +886-2112-1322

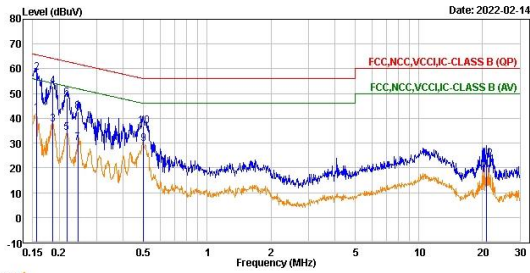

Trace: 1

Line	Freq	Level	Read Level	Factor	Limit	Over Limit	Remark	Pol/Phase	Note
	MHz	dBuV	dBuV	dB	dBuV	dB			
1	0.16	42.03	32.34	9.69	55.67	-13.64	Average	line1	
2	0.16	58.37	48.68	9.69	65.67	-7.30	QP	line1	
3	0.19	37.45	27.77	9.68	54.22	-16.77	Average	line1	
4	0.19	53.11	43.43	9.68	64.22	-11.11	QP	line1	
5	0.22	34.06	24.38	9.68	52.94	-18.88	Average	line1	
6	0.22	48.22	38.54	9.68	62.94	-14.72	QP	line1	
7	0.24	29.93	20.25	9.68	51.94	-22.01	Average	line1	
8	0.24	42.80	33.12	9.68	61.94	-19.14	QP	line1	
9	0.50	29.85	20.17	9.68	46.00	-16.15	Average	line1	
10	0.50	36.76	27.08	9.68	56.00	-19.24	QP	line1	
11	20.85	17.04	7.24	9.80	50.00	-32.96	Average	line1	
12	20.85	23.55	13.75	9.80	60.00	-36.45	QP	line1	



TÜV Rheinland Taiwan Ltd.
No. 458-18, Sec. 2, Fenhiao, Linkou Dist., New Taipei City 244, Taiwan(R.O.C.)
Tel: +886-2112-1000 Fax: +886-2112-1322

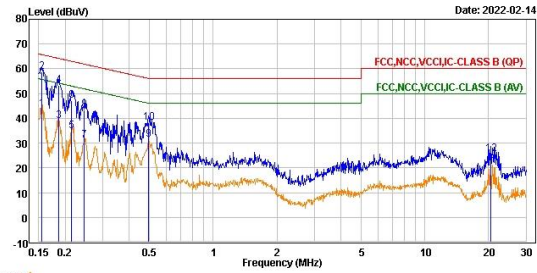

Trace: 1

Line	Freq	Level	Read Level	Factor	Limit	Over Limit	Remark	Pol/Phase	Note
	MHz	dBuV	dBuV	dB	dBuV	dB			
1	0.15	43.64	33.97	9.67	55.75	-12.11	Average	neutral	
2	0.15	58.65	48.98	9.67	65.75	-7.10	QP	neutral	
3	0.19	38.84	29.18	9.66	54.22	-15.38	Average	neutral	
4	0.19	53.15	43.49	9.66	64.22	-11.07	QP	neutral	
5	0.21	34.75	25.09	9.66	53.02	-18.27	Average	neutral	
6	0.21	47.28	37.62	9.66	63.02	-15.74	QP	neutral	
7	0.25	31.22	21.56	9.66	51.90	-20.68	Average	neutral	
8	0.25	43.52	33.86	9.66	61.90	-18.38	QP	neutral	
9	0.49	31.33	21.67	9.66	46.11	-14.78	Average	neutral	
10	0.49	38.24	28.58	9.66	56.11	-17.87	QP	neutral	
11	20.54	20.95	11.08	9.87	50.00	-29.05	Average	neutral	
12	20.54	25.43	15.56	9.87	60.00	-34.57	QP	neutral	