

FCC Test Report

Report No.: RF200513C01

FCC ID: A8J-EWS850AP

Test Model: EWS850AP

Series Model: ECW260 (refer to item 3.1 for more details)

Received Date: May 13, 2020

Test Date: May 18 ~ Jun. 08, 2020

Issued Date: Jun. 19, 2020

Applicant: EnGenius Technologies

Address: 1580 Scenic Avenue, Costa Mesa, CA92626

Issued By: Bureau Veritas Consumer Products Services (H.K.) Ltd., Taoyuan Branch
Lin Kou Laboratories

Lab Address: No. 47-2, 14th Ling, Chia Pau Vil., Lin Kou Dist., New Taipei City, Taiwan

Test Location: No. 19, Hwa Ya 2nd Rd., Wen Hwa Vil., Kwei Shan Dist., Taoyuan City
33383, TAIWAN

**FCC Registration /
Designation Number:** 788550 / TW0003



This report is for your exclusive use. Any copying or replication of this report to or for any other person or entity, or use of our name or trademark, is permitted only with our prior written permission. This report sets forth our findings solely with respect to the test samples identified herein. The results set forth in this report are not indicative or representative of the quality or characteristics of the lot from which a test sample was taken or any similar or identical product specifically and expressly noted. Our report includes all of the tests requested by you and the results thereof based upon the information that you provided to us. You have 60 days from date of issuance of this report to notify us of any material error or omission caused by our negligence, provided, however, that such notice shall be in writing and shall specifically address the issue you wish to raise. A failure to raise such issue within the prescribed time shall constitute your unqualified acceptance of the completeness of this report, the tests conducted and the correctness of the report contents. Unless specific mention, the uncertainty of measurement has been explicitly taken into account to declare the compliance or non-compliance to the specification.

Table of Contents

Release Control Record	4
1 Certificate of Conformity	5
2 Summary of Test Results	6
2.1 Measurement Uncertainty.....	6
2.2 Modification Record.....	6
3 General Information	7
3.1 General Description of EUT.....	7
3.2 Description of Test Modes.....	8
3.2.1 Test Mode Applicability and Tested Channel Detail.....	9
3.3 Duty Cycle of Test Signal.....	11
3.4 Description of Support Units.....	12
3.4.1 Configuration of System under Test.....	12
3.5 General Description of Applied Standards and References.....	12
4 Test Types and Results	13
4.1 Radiated Emission and Bandedge Measurement.....	13
4.1.1 Limits of Radiated Emission and Bandedge Measurement.....	13
4.1.2 Test Instruments.....	14
4.1.3 Test Procedures.....	15
4.1.4 Deviation from Test Standard.....	15
4.1.5 Test Setup.....	16
4.1.6 EUT Operating Conditions.....	17
4.1.7 Test Results.....	18
4.2 Conducted Emission Measurement.....	32
4.2.1 Limits of Conducted Emission Measurement.....	32
4.2.2 Test Instruments.....	32
4.2.3 Test Procedures.....	33
4.2.4 Deviation from Test Standard.....	33
4.2.5 Test Setup.....	33
4.2.6 EUT Operating Conditions.....	33
4.2.7 Test Results.....	34
4.3 6dB Bandwidth Measurement.....	36
4.3.1 Limits of 6dB Bandwidth Measurement.....	36
4.3.2 Test Setup.....	36
4.3.3 Test Instruments.....	36
4.3.4 Test Procedure.....	36
4.3.5 Deviation from Test Standard.....	36
4.3.6 EUT Operating Conditions.....	36
4.3.7 Test Result.....	37
4.4 Conducted Output Power Measurement.....	39
4.4.1 Limits of Conducted Output Power Measurement.....	39
4.4.2 Test Setup.....	39
4.4.3 Test Instruments.....	39
4.4.4 Test Procedures.....	39
4.4.5 Deviation from Test Standard.....	39
4.4.6 EUT Operating Conditions.....	39
4.4.7 Test Results.....	40
4.5 Power Spectral Density Measurement.....	44
4.5.1 Limits of Power Spectral Density Measurement.....	44
4.5.2 Test Setup.....	44
4.5.3 Test Instruments.....	44
4.5.4 Test Procedure.....	44
4.5.5 Deviation from Test Standard.....	45
4.5.6 EUT Operating Condition.....	45

4.5.7 Test Results	46
4.6 Conducted Out of Band Emission Measurement.....	49
4.6.1 Limits of Conducted Out of Band Emission Measurement	49
4.6.2 Test Setup.....	49
4.6.3 Test Instruments	49
4.6.4 Test Procedure	49
4.6.5 Deviation from Test Standard	49
4.6.6 EUT Operating Condition	49
4.6.7 Test Results	49
Annex A - Band Edge Measurement	58
5 Pictures of Test Arrangements.....	62
Appendix – Information of the Testing Laboratories	63

Release Control Record

Issue No.	Description	Date Issued
RF200513C01	Original release	Jun. 19, 2020

1 Certificate of Conformity

Product: AX1800 Outdoor Access Point

Brand: EnGenius

Test Model: EWS850AP

Series Model: ECW260 (refer to item 3.1 for more details)

Sample Status: Engineering sample

Applicant: EnGenius Technologies

Test Date: May 18 ~ Jun. 08, 2020

Standards: 47 CFR FCC Part 15, Subpart C (Section 15.247)
ANSI C63.10:2013

The above equipment has been tested by **Bureau Veritas Consumer Products Services (H.K.) Ltd., Taoyuan Branch**, and found compliance with the requirement of the above standards. The test record, data evaluation & Equipment Under Test (EUT) configurations represented herein are true and accurate accounts of the measurements of the sample's RF characteristics under the conditions specified in this report.

Prepared by : Celine Chou , **Date:** Jun. 19, 2020
Celine Chou / Senior Specialist

Approved by : Bruce Chen , **Date:** Jun. 19, 2020
Bruce Chen / Senior Project Engineer

2 Summary of Test Results

47 CFR FCC Part 15, Subpart C (Section 15.247)			
FCC Clause	Test Item	Result	Remarks
15.207	AC Power Conducted Emission	Pass	Meet the requirement of limit. Minimum passing margin is -6.08dB at 0.46322MHz.
15.205 / 15.209 / 15.247(d)	Radiated Emissions and Band Edge Measurement	Pass	Meet the requirement of limit. Minimum passing margin is -1.0dB at 2483.50MHz.
15.247(d)	Antenna Port Emission	Pass	Meet the requirement of limit.
15.247(a)(2)	6dB bandwidth	Pass	Meet the requirement of limit.
15.247(b)	Conducted power	Pass	Meet the requirement of limit.
15.247(e)	Power Spectral Density	Pass	Meet the requirement of limit.
15.203	Antenna Requirement	Pass	Antenna connector is brass not a standard connector.

Note:

- For 2.4G band compliance with rule 15.247(d) of the band-edge items, the test plots were recorded in Annex A. Test Procedures refer to report 4.1.3.
- Determining compliance based on the results of the compliance measurement, not taking into account measurement instrumentation uncertainty.

2.1 Measurement Uncertainty

Where relevant, the following measurement uncertainty levels have been estimated for tests performed on the EUT as specified in CISPR 16-4-2:

Measurement	Frequency	Expanded Uncertainty (k=2) (±)
Conducted Emissions at mains ports	150kHz ~ 30MHz	2.79 dB
Radiated Emissions up to 1 GHz	9kHz ~ 30MHz	3.04 dB
	30MHz ~ 200MHz	3.86 dB
	200MHz ~ 1000MHz	3.87 dB
Radiated Emissions above 1 GHz	1GHz ~ 18GHz	2.29 dB
	18GHz ~ 40GHz	2.29 dB

2.2 Modification Record

There were no modifications required for compliance.

3 General Information

3.1 General Description of EUT

Product	AX1800 Outdoor Access Point
Brand	EnGenius
Test Model	EWS850AP
Series Model	ECW260
Model Difference	Refer to note
Sample Status	Engineering sample
Power Supply Rating	54Vdc (POE)
Modulation Type	CCK, DQPSK, DBPSK for DSSS 256QAM, 64QAM, 16QAM, QPSK, BPSK for OFDM 1024QAM for OFDMA
Modulation Technology	DSSS, OFDM, OFDMA
Transfer Rate	802.11b: 11/5.5/2/1Mbps 802.11g: 54/48/36/24/18/12/9/6Mbps 802.11n: up to 400Mbps 802.11ax: up to 574Mbps
Operating Frequency	2412 ~ 2462MHz
Number of Channel	802.11b, 802.11g, 802.11n (HT20), 802.11n (VHT20), 802.11ax (HE20): 11 802.11n (HT40), 802.11n (VHT40), 802.11ax (HE40): 7
Output Power	CDD Mode: 375.027mW Beamforming Mode: 172.804mW
Antenna Type	Refer to note
Antenna Connector	Refer to note
Accessory Device	POE
Cable Supplied	1.75m non-shielded ground cable without core

Note:

- The EUT incorporates a MIMO function. Physically, the EUT provides 2 completed transmitters and 2 receivers.

Modulation Mode	Beamforming Mode	TX Function
802.11b	Not Support	2TX
802.11g	Not Support	2TX
802.11n (HT20)	Support	2TX
802.11n (HT40)	Support	2TX
802.11n (VHT20)	Support	2TX
802.11n (VHT40)	Support	2TX
802.11ax (HE20)	Support	2TX
802.11ax (HE40)	Support	2TX

* The bandwidth and modulation are similar for HT20/HT40 on 802.11n mode and VHT20/VHT40 on 802.11n mode and HE20/HE40 on 802.11ax mode. Therefore the investigated worst case is the representative mode in test report. (Final test mode refer section 3.2.1)

* For 802.11n, CDD mode and Beamforming mode are presented in power output test item. For other test items, CDD mode is the worst case for final tests after pretesting.

2. All models are listed as below. Model no.: EWS850AP was chosen for final test.

Brand	Model	Model difference
EnGenius	EWS850AP	Main test model
	ECW260	Series model for marking purpose

3. The EUT consumes power from the following PoE.

Brand	EnGenius
Model	EPA5006GR
Input Power	100-240Vac, 0.8A, 50-60Hz
Output Power	54Vdc, 0.6A PIN 4,5: 54Vdc PIN 7,8 RETURN
Power Line	0.5m non-shielded AC power cable without core

4. There are four radios for the EUT.

Radio	Function	TX/RX Function
1	WLAN 2.4G	2TX / 2RX
2	WLAN 5G	2TX / 2RX
3	Scanning	1RX only (TX disabled)
4	BT LE	1TX / 1RX

5. The EUT with follow antennas gain is listed as table below.

Ant. Type	Dipole					
Connector	brass					
Frequency (MHz)	2400MHz	2450MHz	2500MHz	5150MHz	5550MHz	5850MHz
Gain (dBi)	5.08	5.13	5.17	5.12	5.09	5.17

* The above Antenna information is declared by manufacturer and for more detailed features description, please refer to the manufacturer's specifications, the laboratory shall not be held responsible.

6. 2.4GHz (Radio 1) & 5GHz (Radio 2) & BT LE (Radio 4) technology can transmit at same time.

3.2 Description of Test Modes

11 channels are provided for 802.11b, 802.11g, 802.11n (HT20), 802.11n (VHT20), 802.11ax (HE20):

Channel	Frequency	Channel	Frequency
1	2412MHz	7	2442MHz
2	2417MHz	8	2447MHz
3	2422MHz	9	2452MHz
4	2427MHz	10	2457MHz
5	2432MHz	11	2462MHz
6	2437MHz		

7 channels are provided for 802.11n (HT40), 802.11n (VHT40), 802.11ax (HE40):

Channel	Frequency	Channel	Frequency
3	2422MHz	7	2442MHz
4	2427MHz	8	2447MHz
5	2432MHz	9	2452MHz
6	2437MHz		

3.2.1 Test Mode Applicability and Tested Channel Detail

EUT Configure Mode	Applicable to				Description
	RE≥1G	RE<1G	PLC	APCM	
-	√	√	√	√	-

Where RE≥1G: Radiated Emission above 1GHz & Bandedge Measurement
 RE<1G: Radiated Emission below 1GHz
 PLC: Power Line Conducted Emission
 APCM: Antenna Port Conducted Measurement

Note:

1. The EUT had been pre-tested on the positioned of each 3 axis. The worst case was found when positioned on **Z-plane**.
2. Radiated emission test (below 1GHz) and power line conducted emission test items chosen the worst maximum power.

Radiated Emission Test (Above 1GHz):

- Pre-Scan has been conducted to determine the worst-case mode from all possible combinations between available modulations, data rates and antenna ports (if EUT with antenna diversity architecture).
- Following channel(s) was (were) selected for the final test as listed below.

EUT Configure Mode	Mode	Available Channel	Tested Channel	Modulation Technology	Modulation Type	Data Rate (Mbps)
-	802.11b	1 to 11	1, 6, 11	DSSS	DBPSK	1.0
-	802.11g	1 to 11	1, 6, 11	OFDM	BPSK	6.0
-	802.11ax (HE20)	1 to 11	1, 6, 11	OFDM	OFDMA	MCS0
-	802.11ax (HE40)	3 to 9	3, 6, 9	OFDM	OFDMA	MCS0

Radiated Emission Test (Below 1GHz):

- Pre-Scan has been conducted to determine the worst-case mode from all possible combinations between available modulations, data rates and antenna ports (if EUT with antenna diversity architecture).
- Following channel(s) was (were) selected for the final test as listed below.

EUT Configure Mode	Mode	Available Channel	Tested Channel	Modulation Technology	Modulation Type	Data Rate (Mbps)
-	802.11g	1 to 11	6	OFDM	BPSK	6.0

Power Line Conducted Emission Test:

- Pre-Scan has been conducted to determine the worst-case mode from all possible combinations between available modulations, data rates and antenna ports (if EUT with antenna diversity architecture).
- Following channel(s) was (were) selected for the final test as listed below.

EUT Configure Mode	Mode	Available Channel	Tested Channel	Modulation Technology	Modulation Type	Data Rate (Mbps)
-	802.11g	1 to 11	6	OFDM	BPSK	6.0

Conducted Output Power Measurement:

- This item includes all test value of each mode, but only includes spectrum plot of worst value of each mode.
- Pre-Scan has been conducted to determine the worst-case mode from all possible combinations between available modulations, data rates and antenna ports (if EUT with antenna diversity architecture).
- Following channel(s) was (were) selected for the final test as listed below.

EUT Configure Mode	Mode	Available Channel	Tested Channel	Modulation Technology	Modulation Type	Data Rate (Mbps)
-	802.11b	1 to 11	1, 6, 11	DSSS	DBPSK	1.0
-	802.11g	1 to 11	1, 6, 11	OFDM	BPSK	6.0
-	802.11n (HT20)	1 to 11	1, 6, 11	OFDM	BPSK	6.5
-	802.11n (HT40)	3 to 9	3, 6, 9	OFDM	BPSK	13.5
-	802.11n (VHT20)	1 to 11	1, 6, 11	OFDM	BPSK	6.5
-	802.11n (VHT40)	3 to 9	3, 6, 9	OFDM	BPSK	13.5
-	802.11ax (HE20)	1 to 11	1, 6, 11	OFDM	OFDMA	MCS0
-	802.11ax (HE40)	3 to 9	3, 6, 9	OFDM	OFDMA	MCS0

Bandwidth, Power Spectral Density and Conducted Out of Band Emission Measurement:

- This item includes all test value of each mode, but only includes spectrum plot of worst value of each mode.
- Pre-Scan has been conducted to determine the worst-case mode from all possible combinations between available modulations, data rates and antenna ports (if EUT with antenna diversity architecture).
- Following channel(s) was (were) selected for the final test as listed below.

EUT Configure Mode	Mode	Available Channel	Tested Channel	Modulation Technology	Modulation Type	Data Rate (Mbps)
-	802.11b	1 to 11	1, 6, 11	DSSS	DBPSK	1.0
-	802.11g	1 to 11	1, 6, 11	OFDM	BPSK	6.0
-	802.11ax (HE20)	1 to 11	1, 6, 11	OFDM	OFDMA	MCS0
-	802.11ax (HE40)	3 to 9	3, 6, 9	OFDM	OFDMA	MCS0

Test Condition:

Applicable to	Environmental Conditions	Input Power (System)	Tested by
RE≥1G	23 deg. C, 66% RH	120Vac, 60Hz	Adair Peng
RE<1G	23 deg. C, 66% RH	120Vac, 60Hz	Adair Peng
PLC	23 deg. C, 66% RH	120Vac, 60Hz	Titan Hsu
APCM	25 deg. C, 60% RH	120Vac, 60Hz	Chris Lin

3.3 Duty Cycle of Test Signal

802.11b: Duty cycle of test signal is > 98%, duty factor is not required.

802.11g, 802.11ax (HE20), 802.11ax (HE40): Duty cycle of test signal is < 98%, duty factor is required.

802.11b: Duty cycle = $13.125/13.375 = 0.981$

802.11g: Duty cycle = $1.973/2.108 = 0.936$, Duty factor = $10 * \log(1/0.936) = 0.29$

802.11ax (HE20): Duty cycle = $5.424/5.712 = 0.950$, Duty factor = $10 * \log(1/0.950) = 0.22$

802.11ax (HE40): Duty cycle = $5.439/5.675 = 0.958$, Duty factor = $10 * \log(1/0.958) = 0.18$



3.4 Description of Support Units

The EUT has been tested as an independent unit together with other necessary accessories or support units. The following support units or accessories were used to form a representative test configuration during the tests.

ID	Product	Brand	Model No.	Serial No.	FCC ID	Remarks
A.	Notebook	DELL	E5410	1HC2XM1	FCC DoC Approved	-

Note:

1. All power cords of the above support units are non-shielded (1.8m).
2. Item A acted as a communication partner to transfer data.

ID	Cable Descriptions	Qty.	Length (m)	Shielding (Yes/No)	Cores (Qty.)	Remarks
1.	LAN cable	1	1.5	N	0	RJ45, Cat5e
2.	LAN cable	1	7	N	0	RJ45, Cat5e

3.4.1 Configuration of System under Test

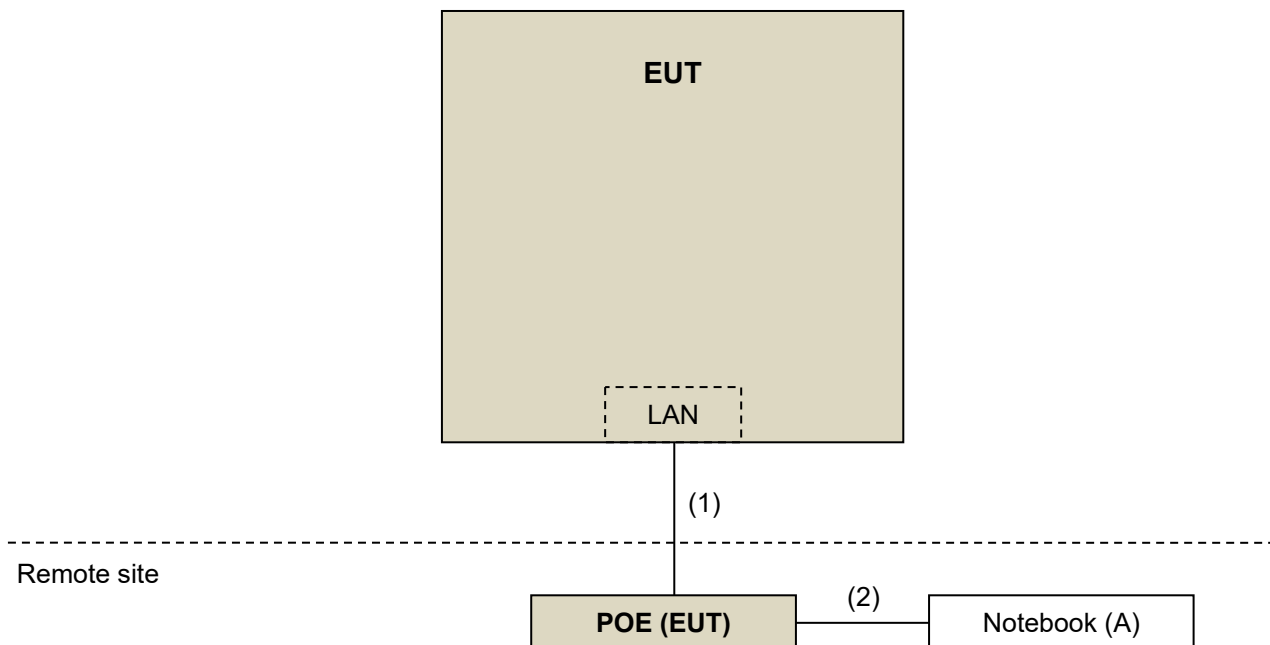

3.5 General Description of Applied Standards and References

The EUT is a RF Product. According to the specifications of the manufacturer, it must comply with the requirements of the following standards and references:

Test standard:

FCC Part 15, Subpart C (15.247)

ANSI C63.10-2013

All test items have been performed and recorded as per the above standards.

References Test Guidance:

KDB 558074 D01 15.247 Meas Guidance v05r02

KDB 662911 D01 Multiple Transmitter Output v02r01

All test items have been performed as a reference to the above KDB test guidance.

4 Test Types and Results

4.1 Radiated Emission and Bandedge Measurement

4.1.1 Limits of Radiated Emission and Bandedge Measurement

Radiated emissions which fall in the restricted bands must comply with the radiated emission limits specified as below table. Other emissions shall be at least 30dB below the highest level of the desired power:

Frequencies (MHz)	Field Strength (microvolts/meter)	Measurement Distance (meters)
0.009 ~ 0.490	2400/F(kHz)	300
0.490 ~ 1.705	24000/F(kHz)	30
1.705 ~ 30.0	30	30
30 ~ 88	100	3
88 ~ 216	150	3
216 ~ 960	200	3
Above 960	500	3

Note:

1. The lower limit shall apply at the transition frequencies.
2. Emission level (dBuV/m) = 20 log Emission level (uV/m).
3. For frequencies above 1000MHz, the field strength limits are based on average detector, however, the peak field strength of any emission shall not exceed the maximum permitted average limits, specified above by more than 20dB under any condition of modulation.

4.1.2 Test Instruments

Description & Manufacturer	Model No.	Serial No.	Cal. Date	Cal. Due
Test Receiver ROHDE & SCHWARZ	ESR3	102579	Jun. 27, 2019	Jun. 26, 2020
Spectrum Analyzer ROHDE & SCHWARZ	FSP40	100040	Sep. 23, 2019	Sep. 22, 2020
BILOG Antenna SCHWARZBECK	VULB9168	9168-171	Nov. 11, 2019	Nov. 10, 2020
HORN Antenna SCHWARZBECK	9120D	209	Nov. 24, 2019	Nov. 23, 2020
HORN Antenna SCHWARZBECK	BBHA 9170	BBHA9170241	Nov. 24, 2019	Nov. 23, 2020
Loop Antenna TESEQ	HLA 6121	45745	Jul. 01, 2019	Jun. 30, 2020
Preamplifier Agilent (Below 1GHz)	8447D	2944A10738	Aug. 20, 2019	Aug. 19, 2020
Preamplifier KEYSIGHT (Above 1GHz)	83017A	MY53270295	Jun. 11, 2019	Jun. 10, 2020
RF Coaxial Cable WOKEN With 5dB PAD	8D-FB	Cable-CH3-01	Aug. 20, 2019	Aug. 19, 2020
RF signal cable HUBER+SUHNER	SUCOFLEX 104	Cable-CH3-03 (223653/4)	Aug. 20, 2019	Aug. 19, 2020
RF signal cable HUBER+SUHNER& EMCI	SUCOFLEX 104&EMC104-SM-S M-8000	Cable-CH3-03 (309224+170907)	Aug. 20, 2019	Aug. 19, 2020
Software BV ADT	ADT_Radiated_ V7.6.15.9.5	NA	NA	NA
Antenna Tower inn-co GmbH	MA 4000	013303	NA	NA
Antenna Tower Controller BV ADT	AT100	AT93021702	NA	NA
Turn Table BV ADT	TT100	TT93021702	NA	NA
Turn Table Controller BV ADT	SC100	SC93021702	NA	NA
Boresight Antenna Fixture	FBA-01	FBA-SIP01	NA	NA
Pre-amplifier (18GHz-40GHz) EMC	EMC184045B	980175	Sep. 05, 2019	Sep. 04, 2020
USB Wideband Power Sensor KEYSIGHT	U2021XA	MY55050005/MY5519 0004/MY55190007/MY 55210005	Jul. 15, 2019	Jul. 14, 2020

Note: 1. The calibration interval of the above test instruments is 12 months and the calibrations are traceable to NML/ROC and NIST/USA.

2. The test was performed in HwaYa Chamber 3.

4.1.3 Test Procedures

For Radiated emission below 30MHz

- a. The EUT was placed on the top of a rotating table 0.8 meters above the ground at a 3 meter chamber room. The table was rotated 360 degrees to determine the position of the highest radiation.
- b. The EUT was set 3 meters away from the interference-receiving antenna, which was mounted on the top of a variable-height antenna tower.
- c. Parallel, perpendicular, and ground-parallel orientations of the antenna are set to make the measurement.
- d. For each suspected emission, the EUT was arranged to its worst case and the rotatable table was turned from 0 degrees to 360 degrees to find the maximum reading.
- e. The test-receiver system was set to Quasi-Peak Detect Function and Specified Bandwidth with Maximum Hold Mode.

Note:

1. The resolution bandwidth and video bandwidth of test receiver/spectrum analyzer is 9kHz at frequency below 30MHz.

For Radiated emission above 30MHz

- a. The EUT was placed on the top of a rotating table 0.8 meters (for 30MHz ~ 1GHz) / 1.5 meters (for above 1GHz) above the ground at 3 meter chamber room for test. The table was rotated 360 degrees to determine the position of the highest radiation.
- b. The EUT was set 3 meters away from the interference-receiving antenna, which was mounted on the top of a variable-height antenna tower.
- c. The height of antenna is varied from one meter to four meters above the ground to determine the maximum value of the field strength. Both horizontal and vertical polarizations of the antenna are set to make the measurement.
- d. For each suspected emission, the EUT was arranged to its worst case and then the antenna was tuned to heights from 1 meter to 4 meters and the rotatable table was turned from 0 degrees to 360 degrees to find the maximum reading.
- e. The test-receiver system was set to quasi-peak detect function and specified bandwidth with maximum hold mode when the test frequency is below 1 GHz.
- f. The test-receiver system was set to peak and average detect function and specified bandwidth with maximum hold mode when the test frequency is above 1 GHz. If the peak reading value also meets average limit, measurement with the average detector is unnecessary.

Note:

1. The resolution bandwidth and video bandwidth of test receiver/spectrum analyzer is 120kHz for Quasi-peak detection (QP) at frequency below 1GHz.
2. The resolution bandwidth of test receiver/spectrum analyzer is 1 MHz and the video bandwidth is 3 MHz for Peak detection (PK) at frequency above 1GHz.
3. The resolution bandwidth of test receiver/spectrum analyzer is 1MHz and the video bandwidth is $\geq 1/T$ (Duty cycle < 98%) or 10Hz (Duty cycle $\geq 98\%$) for Average detection (AV) at frequency above 1GHz. (802.11b: RBW = 1MHz, VBW = 10Hz; 802.11g: RBW = 1MHz, VBW = 1kHz; 802.11ax (HE20): RBW = 1MHz, VBW = 1kHz; 802.11ax (HE40): RBW = 1MHz, VBW = 1kHz)
4. All modes of operation were investigated and the worst-case emissions are reported.

4.1.4 Deviation from Test Standard

No deviation.

4.1.5 Test Setup

For Radiated emission below 30MHz

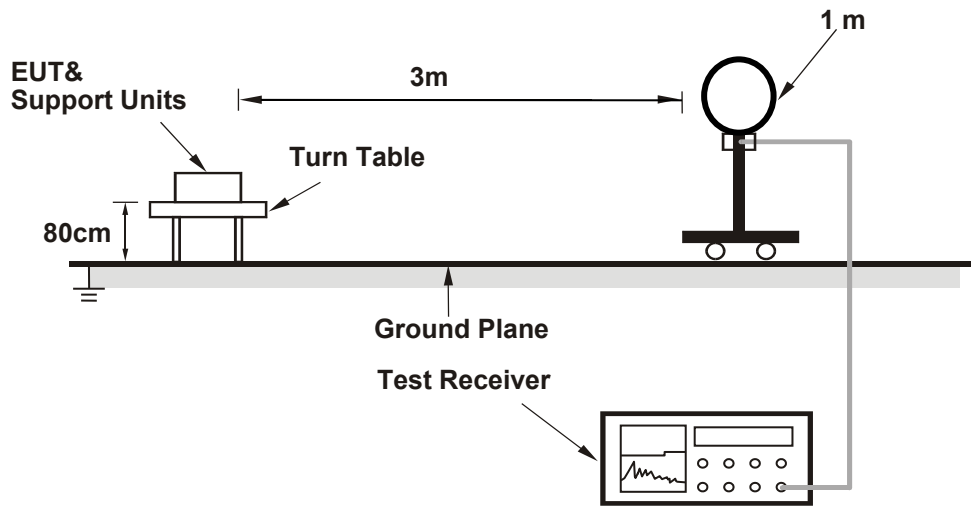

For Radiated emission 30MHz to 1GHz

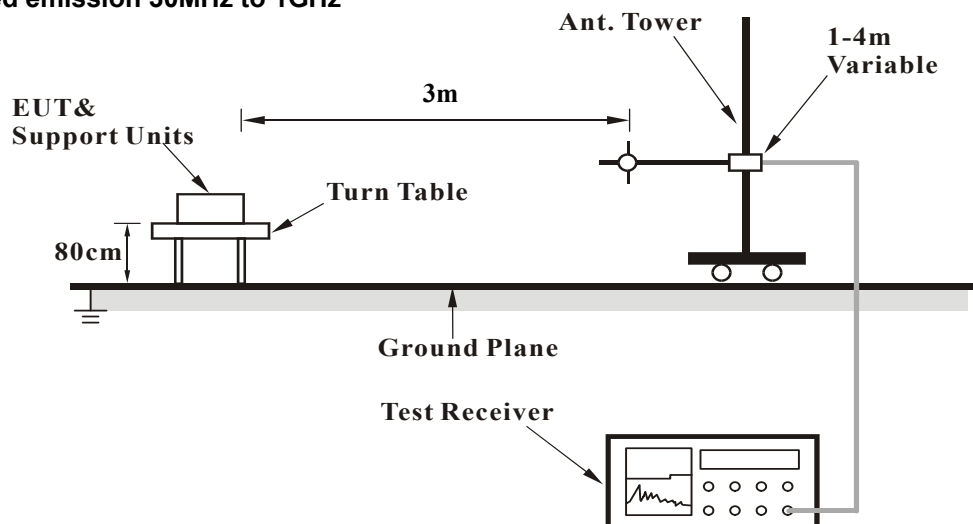

For Radiated emission above 1GHz

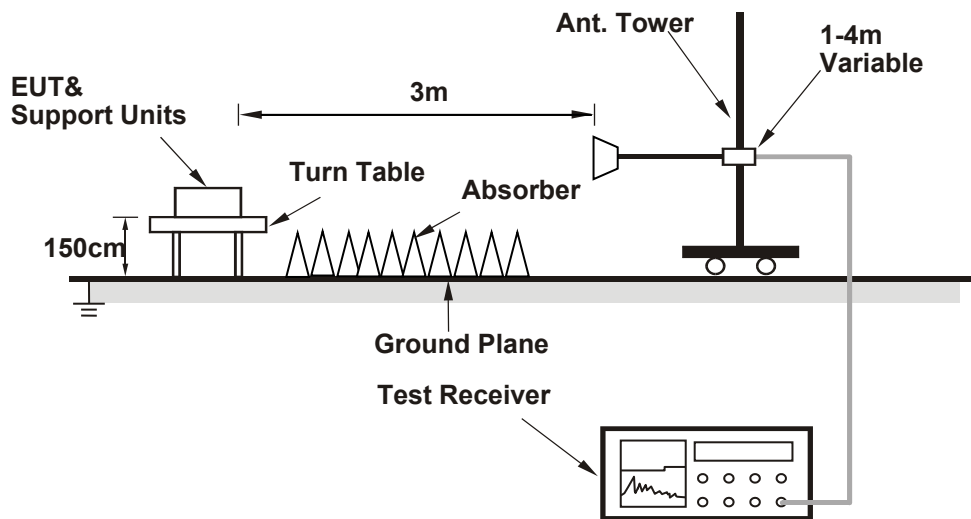

For the actual test configuration, please refer to the attached file (Test Setup Photo).

4.1.6 EUT Operating Conditions

- a. Placed the EUT on the testing table.
- b. Prepared a notebook to act as a communication partner and placed it outside of testing area.
- c. The communication partner connected with EUT via a RJ45 cable and ran a test program (provided by manufacturer) to enable EUT under transmission condition continuously at specific channel frequency.
- d. The communication partner sent data to EUT by command "PING".

4.1.7 Test Results

Above 1GHz Data:

802.11b

CHANNEL	TX Channel 1	DETECTOR FUNCTION	Peak (PK) Average (AV)
FREQUENCY RANGE	1GHz ~ 25GHz		

ANTENNA POLARITY & TEST DISTANCE: HORIZONTAL AT 3 M								
NO.	FREQ. (MHz)	EMISSION LEVEL (dBuV/m)	LIMIT (dBuV/m)	MARGIN (dB)	ANTENNA HEIGHT (m)	TABLE ANGLE (Degree)	RAW VALUE (dBuV)	CORRECTION FACTOR (dB/m)
1	2390.00	59.0 PK	74.0	-15.0	1.47 H	30	26.7	32.3
2	2390.00	46.4 AV	54.0	-7.6	1.47 H	30	14.1	32.3
3	*2412.00	101.8 PK			1.54 H	25	69.5	32.3
4	*2412.00	98.3 AV			1.54 H	25	66.0	32.3
5	4824.00	50.4 PK	74.0	-23.6	1.29 H	341	47.0	3.4
6	4824.00	45.1 AV	54.0	-8.9	1.29 H	341	41.7	3.4
ANTENNA POLARITY & TEST DISTANCE: VERTICAL AT 3 M								
NO.	FREQ. (MHz)	EMISSION LEVEL (dBuV/m)	LIMIT (dBuV/m)	MARGIN (dB)	ANTENNA HEIGHT (m)	TABLE ANGLE (Degree)	RAW VALUE (dBuV)	CORRECTION FACTOR (dB/m)
1	2390.00	61.1 PK	74.0	-12.9	1.58 V	0	28.8	32.3
2	2390.00	52.3 AV	54.0	-1.7	1.58 V	0	20.0	32.3
3	*2412.00	115.8 PK			1.71 V	16	83.5	32.3
4	*2412.00	112.0 AV			1.71 V	16	79.7	32.3
5	4824.00	52.0 PK	74.0	-22.0	1.52 V	190	48.6	3.4
6	4824.00	47.1 AV	54.0	-6.9	1.52 V	190	43.7	3.4

Remarks:

1. Emission Level(dBuV/m) = Raw Value(dBuV) + Correction Factor(dB/m).
2. Correction Factor(dB/m) = Antenna Factor(dB/m) + Cable Factor(dB) – Pre-Amplifier Factor(dB).
3. Margin value = Emission Level – Limit value.
4. The other emission levels were very low against the limit.
5. " * ": Fundamental frequency.

CHANNEL	TX Channel 6	DETECTOR FUNCTION	Peak (PK) Average (AV)
FREQUENCY RANGE	1GHz ~ 25GHz		

ANTENNA POLARITY & TEST DISTANCE: HORIZONTAL AT 3 M

NO.	FREQ. (MHz)	EMISSION LEVEL (dBuV/m)	LIMIT (dBuV/m)	MARGIN (dB)	ANTENNA HEIGHT (m)	TABLE ANGLE (Degree)	RAW VALUE (dBuV)	CORRECTION FACTOR (dB/m)
1	*2437.00	102.6 PK			1.21 H	19	70.3	32.3
2	*2437.00	98.8 AV			1.21 H	19	66.5	32.3
3	4874.00	49.6 PK	74.0	-24.4	1.21 H	342	45.9	3.7
4	4874.00	43.9 AV	54.0	-10.1	1.21 H	342	40.2	3.7

ANTENNA POLARITY & TEST DISTANCE: VERTICAL AT 3 M

NO.	FREQ. (MHz)	EMISSION LEVEL (dBuV/m)	LIMIT (dBuV/m)	MARGIN (dB)	ANTENNA HEIGHT (m)	TABLE ANGLE (Degree)	RAW VALUE (dBuV)	CORRECTION FACTOR (dB/m)
1	*2437.00	116.5 PK			1.59 V	11	84.2	32.3
2	*2437.00	112.5 AV			1.59 V	11	80.2	32.3
3	4874.00	54.0 PK	74.0	-20.0	1.54 V	190	50.3	3.7
4	4874.00	48.0 AV	54.0	-6.0	1.54 V	190	44.3	3.7

Remarks:

1. Emission Level(dBuV/m) = Raw Value(dBuV) + Correction Factor(dB/m).
2. Correction Factor(dB/m) = Antenna Factor(dB/m) + Cable Factor(dB) – Pre-Amplifier Factor(dB).
3. Margin value = Emission Level – Limit value.
4. The other emission levels were very low against the limit.
5. " * ": Fundamental frequency.

CHANNEL	TX Channel 11	DETECTOR FUNCTION	Peak (PK) Average (AV)
FREQUENCY RANGE	1GHz ~ 25GHz		

ANTENNA POLARITY & TEST DISTANCE: HORIZONTAL AT 3 M

NO.	FREQ. (MHz)	EMISSION LEVEL (dBuV/m)	LIMIT (dBuV/m)	MARGIN (dB)	ANTENNA HEIGHT (m)	TABLE ANGLE (Degree)	RAW VALUE (dBuV)	CORRECTION FACTOR (dB/m)
1	*2462.00	101.6 PK			1.24 H	23	69.2	32.4
2	*2462.00	98.1 AV			1.24 H	23	65.7	32.4
3	2483.50	59.8 PK	74.0	-14.2	1.40 H	12	27.4	32.4
4	2483.50	47.2 AV	54.0	-6.8	1.40 H	12	14.8	32.4
5	4924.00	48.1 PK	74.0	-25.9	1.15 H	346	44.3	3.8
6	4924.00	40.2 AV	54.0	-13.8	1.15 H	346	36.4	3.8

ANTENNA POLARITY & TEST DISTANCE: VERTICAL AT 3 M

NO.	FREQ. (MHz)	EMISSION LEVEL (dBuV/m)	LIMIT (dBuV/m)	MARGIN (dB)	ANTENNA HEIGHT (m)	TABLE ANGLE (Degree)	RAW VALUE (dBuV)	CORRECTION FACTOR (dB/m)
1	*2462.00	115.4 PK			1.72 V	343	83.0	32.4
2	*2462.00	111.7 AV			1.72 V	343	79.3	32.4
3	2483.50	62.6 PK	74.0	-11.4	1.54 V	14	30.2	32.4
4	2483.50	52.7 AV	54.0	-1.3	1.54 V	14	20.3	32.4
5	4924.00	49.5 PK	74.0	-24.5	1.47 V	193	45.7	3.8
6	4924.00	42.3 AV	54.0	-11.7	1.47 V	193	38.5	3.8

Remarks:

1. Emission Level(dBuV/m) = Raw Value(dBuV) + Correction Factor(dB/m).
2. Correction Factor(dB/m) = Antenna Factor(dB/m) + Cable Factor(dB) – Pre-Amplifier Factor(dB).
3. Margin value = Emission Level – Limit value.
4. The other emission levels were very low against the limit.
5. " * ": Fundamental frequency.

802.11g

CHANNEL	TX Channel 1	DETECTOR FUNCTION	Peak (PK) Average (AV)
FREQUENCY RANGE	1GHz ~ 25GHz		

ANTENNA POLARITY & TEST DISTANCE: HORIZONTAL AT 3 M								
NO.	FREQ. (MHz)	EMISSION LEVEL (dBuV/m)	LIMIT (dBuV/m)	MARGIN (dB)	ANTENNA HEIGHT (m)	TABLE ANGLE (Degree)	RAW VALUE (dBuV)	CORRECTION FACTOR (dB/m)
1	2390.00	58.6 PK	74.0	-15.4	1.21 H	28	26.3	32.3
2	2390.00	47.1 AV	54.0	-6.9	1.21 H	28	14.8	32.3
3	*2412.00	100.7 PK			1.20 H	28	68.4	32.3
4	*2412.00	90.5 AV			1.20 H	28	58.2	32.3
5	4824.00	46.2 PK	74.0	-27.8	1.35 H	308	42.8	3.4
6	4824.00	35.5 AV	54.0	-18.5	1.35 H	308	32.1	3.4

ANTENNA POLARITY & TEST DISTANCE: VERTICAL AT 3 M								
NO.	FREQ. (MHz)	EMISSION LEVEL (dBuV/m)	LIMIT (dBuV/m)	MARGIN (dB)	ANTENNA HEIGHT (m)	TABLE ANGLE (Degree)	RAW VALUE (dBuV)	CORRECTION FACTOR (dB/m)
1	2390.00	65.7 PK	74.0	-8.3	1.31 V	3	33.4	32.3
2	2390.00	52.8 AV	54.0	-1.2	1.31 V	3	20.5	32.3
3	*2412.00	116.0 PK			1.28 V	7	83.7	32.3
4	*2412.00	105.9 AV			1.28 V	7	73.6	32.3
5	4824.00	48.3 PK	74.0	-25.7	1.41 V	327	44.9	3.4
6	4824.00	35.7 AV	54.0	-18.3	1.41 V	327	32.3	3.4

Remarks:

1. Emission Level(dBuV/m) = Raw Value(dBuV) + Correction Factor(dB/m).
2. Correction Factor(dB/m) = Antenna Factor(dB/m) + Cable Factor(dB) – Pre-Amplifier Factor(dB).
3. Margin value = Emission Level – Limit value.
4. The other emission levels were very low against the limit.
5. " * ": Fundamental frequency.

CHANNEL	TX Channel 6	DETECTOR FUNCTION	Peak (PK) Average (AV)
FREQUENCY RANGE	1GHz ~ 25GHz		

ANTENNA POLARITY & TEST DISTANCE: HORIZONTAL AT 3 M

NO.	FREQ. (MHz)	EMISSION LEVEL (dBuV/m)	LIMIT (dBuV/m)	MARGIN (dB)	ANTENNA HEIGHT (m)	TABLE ANGLE (Degree)	RAW VALUE (dBuV)	CORRECTION FACTOR (dB/m)
1	*2437.00	103.5 PK			1.37 H	20	71.2	32.3
2	*2437.00	93.3 AV			1.37 H	20	61.0	32.3
3	4874.00	46.9 PK	74.0	-27.1	1.40 H	312	43.2	3.7
4	4874.00	37.2 AV	54.0	-16.8	1.40 H	312	33.5	3.7

ANTENNA POLARITY & TEST DISTANCE: VERTICAL AT 3 M

NO.	FREQ. (MHz)	EMISSION LEVEL (dBuV/m)	LIMIT (dBuV/m)	MARGIN (dB)	ANTENNA HEIGHT (m)	TABLE ANGLE (Degree)	RAW VALUE (dBuV)	CORRECTION FACTOR (dB/m)
1	*2437.00	119.8 PK			1.64 V	9	87.5	32.3
2	*2437.00	109.3 AV			1.64 V	9	77.0	32.3
3	4874.00	51.8 PK	74.0	-22.2	1.31 V	327	48.1	3.7
4	4874.00	38.0 AV	54.0	-16.0	1.31 V	327	34.3	3.7

Remarks:

1. Emission Level(dBuV/m) = Raw Value(dBuV) + Correction Factor(dB/m).
2. Correction Factor(dB/m) = Antenna Factor(dB/m) + Cable Factor(dB) – Pre-Amplifier Factor(dB).
3. Margin value = Emission Level – Limit value.
4. The other emission levels were very low against the limit.
5. " * ": Fundamental frequency.

CHANNEL	TX Channel 11	DETECTOR FUNCTION	Peak (PK) Average (AV)
FREQUENCY RANGE	1GHz ~ 25GHz		

ANTENNA POLARITY & TEST DISTANCE: HORIZONTAL AT 3 M

NO.	FREQ. (MHz)	EMISSION LEVEL (dBuV/m)	LIMIT (dBuV/m)	MARGIN (dB)	ANTENNA HEIGHT (m)	TABLE ANGLE (Degree)	RAW VALUE (dBuV)	CORRECTION FACTOR (dB/m)
1	*2462.00	98.2 PK			1.14 H	28	65.8	32.4
2	*2462.00	88.7 AV			1.14 H	28	56.3	32.4
3	2483.50	58.7 PK	74.0	-15.3	1.19 H	33	26.3	32.4
4	2483.50	47.2 AV	54.0	-6.8	1.19 H	33	14.8	32.4
5	4924.00	47.0 PK	74.0	-27.0	1.35 H	311	43.2	3.8
6	4924.00	36.4 AV	54.0	-17.6	1.35 H	311	32.6	3.8

ANTENNA POLARITY & TEST DISTANCE: VERTICAL AT 3 M

NO.	FREQ. (MHz)	EMISSION LEVEL (dBuV/m)	LIMIT (dBuV/m)	MARGIN (dB)	ANTENNA HEIGHT (m)	TABLE ANGLE (Degree)	RAW VALUE (dBuV)	CORRECTION FACTOR (dB/m)
1	*2462.00	114.0 PK			1.70 V	4	81.6	32.4
2	*2462.00	104.1 AV			1.70 V	4	71.7	32.4
3	2483.50	65.5 PK	74.0	-8.5	1.79 V	4	33.1	32.4
4	2483.50	53.0 AV	54.0	-1.0	1.79 V	4	20.6	32.4
5	4924.00	47.4 PK	74.0	-26.6	1.29 V	329	43.6	3.8
6	4924.00	35.2 AV	54.0	-18.8	1.29 V	329	31.4	3.8

Remarks:

1. Emission Level(dBuV/m) = Raw Value(dBuV) + Correction Factor(dB/m).
2. Correction Factor(dB/m) = Antenna Factor(dB/m) + Cable Factor(dB) – Pre-Amplifier Factor(dB).
3. Margin value = Emission Level – Limit value.
4. The other emission levels were very low against the limit.
5. " * ": Fundamental frequency.

802.11ax (HE20)

CHANNEL	TX Channel 1	DETECTOR FUNCTION	Peak (PK) Average (AV)
FREQUENCY RANGE	1GHz ~ 25GHz		

ANTENNA POLARITY & TEST DISTANCE: HORIZONTAL AT 3 M								
NO.	FREQ. (MHz)	EMISSION LEVEL (dBuV/m)	LIMIT (dBuV/m)	MARGIN (dB)	ANTENNA HEIGHT (m)	TABLE ANGLE (Degree)	RAW VALUE (dBuV)	CORRECTION FACTOR (dB/m)
1	2390.00	58.6 PK	74.0	-15.4	1.28 H	30	26.3	32.3
2	2390.00	47.1 AV	54.0	-6.9	1.28 H	30	14.8	32.3
3	*2412.00	102.0 PK			1.22 H	25	69.7	32.3
4	*2412.00	88.6 AV			1.22 H	25	56.3	32.3
5	4824.00	46.7 PK	74.0	-27.3	1.36 H	315	43.3	3.4
6	4824.00	35.9 AV	54.0	-18.1	1.36 H	315	32.5	3.4

ANTENNA POLARITY & TEST DISTANCE: VERTICAL AT 3 M								
NO.	FREQ. (MHz)	EMISSION LEVEL (dBuV/m)	LIMIT (dBuV/m)	MARGIN (dB)	ANTENNA HEIGHT (m)	TABLE ANGLE (Degree)	RAW VALUE (dBuV)	CORRECTION FACTOR (dB/m)
1	2390.00	64.0 PK	74.0	-10.0	1.51 V	360	31.7	32.3
2	2390.00	52.5 AV	54.0	-1.5	1.51 V	360	20.2	32.3
3	*2412.00	116.6 PK			1.47 V	11	84.3	32.3
4	*2412.00	103.0 AV			1.47 V	11	70.7	32.3
5	4824.00	47.0 PK	74.0	-27.0	2.10 V	347	43.6	3.4
6	4824.00	34.5 AV	54.0	-19.5	2.10 V	347	31.1	3.4

Remarks:

1. Emission Level(dBuV/m) = Raw Value(dBuV) + Correction Factor(dB/m).
2. Correction Factor(dB/m) = Antenna Factor(dB/m) + Cable Factor(dB) – Pre-Amplifier Factor(dB).
3. Margin value = Emission Level – Limit value.
4. The other emission levels were very low against the limit.
5. " * ": Fundamental frequency.

CHANNEL	TX Channel 6	DETECTOR FUNCTION	Peak (PK) Average (AV)
FREQUENCY RANGE	1GHz ~ 25GHz		

ANTENNA POLARITY & TEST DISTANCE: HORIZONTAL AT 3 M

NO.	FREQ. (MHz)	EMISSION LEVEL (dBuV/m)	LIMIT (dBuV/m)	MARGIN (dB)	ANTENNA HEIGHT (m)	TABLE ANGLE (Degree)	RAW VALUE (dBuV)	CORRECTION FACTOR (dB/m)
1	*2437.00	103.8 PK			1.21 H	24	71.5	32.3
2	*2437.00	91.9 AV			1.21 H	24	59.6	32.3
3	4874.00	46.7 PK	74.0	-27.3	1.37 H	310	43.0	3.7
4	4874.00	36.9 AV	54.0	-17.1	1.37 H	310	33.2	3.7

ANTENNA POLARITY & TEST DISTANCE: VERTICAL AT 3 M

NO.	FREQ. (MHz)	EMISSION LEVEL (dBuV/m)	LIMIT (dBuV/m)	MARGIN (dB)	ANTENNA HEIGHT (m)	TABLE ANGLE (Degree)	RAW VALUE (dBuV)	CORRECTION FACTOR (dB/m)
1	*2437.00	121.1 PK			1.59 V	9	88.8	32.3
2	*2437.00	108.4 AV			1.59 V	9	76.1	32.3
3	4874.00	49.7 PK	74.0	-24.3	1.32 V	337	46.0	3.7
4	4874.00	37.3 AV	54.0	-16.7	1.32 V	337	33.6	3.7

Remarks:

1. Emission Level(dBuV/m) = Raw Value(dBuV) + Correction Factor(dB/m).
2. Correction Factor(dB/m) = Antenna Factor(dB/m) + Cable Factor(dB) – Pre-Amplifier Factor(dB).
3. Margin value = Emission Level – Limit value.
4. The other emission levels were very low against the limit.
5. " * ": Fundamental frequency.

CHANNEL	TX Channel 11	DETECTOR FUNCTION	Peak (PK) Average (AV)
FREQUENCY RANGE	1GHz ~ 25GHz		

ANTENNA POLARITY & TEST DISTANCE: HORIZONTAL AT 3 M

NO.	FREQ. (MHz)	EMISSION LEVEL (dBuV/m)	LIMIT (dBuV/m)	MARGIN (dB)	ANTENNA HEIGHT (m)	TABLE ANGLE (Degree)	RAW VALUE (dBuV)	CORRECTION FACTOR (dB/m)
1	*2462.00	99.8 PK			1.31 H	13	67.4	32.4
2	*2462.00	86.6 AV			1.31 H	13	54.2	32.4
3	2483.50	58.7 PK	74.0	-15.3	1.35 H	16	26.3	32.4
4	2483.50	47.1 AV	54.0	-6.9	1.35 H	16	14.7	32.4
5	4924.00	45.9 PK	74.0	-28.1	1.32 H	309	42.1	3.8
6	4924.00	35.0 AV	54.0	-19.0	1.32 H	309	31.2	3.8

ANTENNA POLARITY & TEST DISTANCE: VERTICAL AT 3 M

NO.	FREQ. (MHz)	EMISSION LEVEL (dBuV/m)	LIMIT (dBuV/m)	MARGIN (dB)	ANTENNA HEIGHT (m)	TABLE ANGLE (Degree)	RAW VALUE (dBuV)	CORRECTION FACTOR (dB/m)
1	*2462.00	115.6 PK			1.97 V	345	83.2	32.4
2	*2462.00	102.0 AV			1.97 V	345	69.6	32.4
3	2483.50	66.9 PK	74.0	-7.1	1.88 V	13	34.5	32.4
4	2483.50	53.0 AV	54.0	-1.0	1.88 V	13	20.6	32.4
5	4924.00	46.9 PK	74.0	-27.1	1.41 V	2	43.1	3.8
6	4924.00	34.0 AV	54.0	-20.0	1.41 V	2	30.2	3.8

Remarks:

1. Emission Level(dBuV/m) = Raw Value(dBuV) + Correction Factor(dB/m).
2. Correction Factor(dB/m) = Antenna Factor(dB/m) + Cable Factor(dB) – Pre-Amplifier Factor(dB).
3. Margin value = Emission Level – Limit value.
4. The other emission levels were very low against the limit.
5. " * ": Fundamental frequency.

802.11ax (HE40)

CHANNEL	TX Channel 3	DETECTOR FUNCTION	Peak (PK) Average (AV)
FREQUENCY RANGE	1GHz ~ 25GHz		

ANTENNA POLARITY & TEST DISTANCE: HORIZONTAL AT 3 M

NO.	FREQ. (MHz)	EMISSION LEVEL (dBuV/m)	LIMIT (dBuV/m)	MARGIN (dB)	ANTENNA HEIGHT (m)	TABLE ANGLE (Degree)	RAW VALUE (dBuV)	CORRECTION FACTOR (dB/m)
1	2390.00	58.7 PK	74.0	-15.3	1.26 H	27	26.4	32.3
2	2390.00	47.0 AV	54.0	-7.0	1.26 H	27	14.7	32.3
3	*2422.00	97.1 PK			1.21 H	24	64.8	32.3
4	*2422.00	84.5 AV			1.21 H	24	52.2	32.3
5	4844.00	46.2 PK	74.0	-27.8	1.49 H	310	42.7	3.5
6	4844.00	34.9 AV	54.0	-19.1	1.49 H	310	31.4	3.5

ANTENNA POLARITY & TEST DISTANCE: VERTICAL AT 3 M

NO.	FREQ. (MHz)	EMISSION LEVEL (dBuV/m)	LIMIT (dBuV/m)	MARGIN (dB)	ANTENNA HEIGHT (m)	TABLE ANGLE (Degree)	RAW VALUE (dBuV)	CORRECTION FACTOR (dB/m)
1	2390.00	66.9 PK	74.0	-7.1	1.48 V	357	34.6	32.3
2	2390.00	52.7 AV	54.0	-1.3	1.48 V	357	20.4	32.3
3	*2422.00	110.6 PK			1.62 V	7	78.3	32.3
4	*2422.00	98.1 AV			1.62 V	7	65.8	32.3
5	4844.00	45.2 PK	74.0	-28.8	1.91 V	339	41.7	3.5
6	4844.00	33.9 AV	54.0	-20.1	1.91 V	339	30.4	3.5

Remarks:

1. Emission Level(dBuV/m) = Raw Value(dBuV) + Correction Factor(dB/m).
2. Correction Factor(dB/m) = Antenna Factor(dB/m) + Cable Factor(dB) – Pre-Amplifier Factor(dB).
3. Margin value = Emission Level – Limit value.
4. The other emission levels were very low against the limit.
5. " * ": Fundamental frequency.

CHANNEL	TX Channel 6	DETECTOR FUNCTION	Peak (PK) Average (AV)
FREQUENCY RANGE	1GHz ~ 25GHz		

ANTENNA POLARITY & TEST DISTANCE: HORIZONTAL AT 3 M

NO.	FREQ. (MHz)	EMISSION LEVEL (dBuV/m)	LIMIT (dBuV/m)	MARGIN (dB)	ANTENNA HEIGHT (m)	TABLE ANGLE (Degree)	RAW VALUE (dBuV)	CORRECTION FACTOR (dB/m)
1	*2437.00	96.7 PK			1.18 H	22	64.4	32.3
2	*2437.00	84.4 AV			1.18 H	22	52.1	32.3
3	2483.50	58.8 PK	74.0	-15.2	1.21 H	25	26.4	32.4
4	2483.50	47.3 AV	54.0	-6.7	1.21 H	25	14.9	32.4
5	4874.00	46.7 PK	74.0	-27.3	1.45 H	312	43.0	3.7
6	4874.00	35.2 AV	54.0	-18.8	1.45 H	312	31.5	3.7

ANTENNA POLARITY & TEST DISTANCE: VERTICAL AT 3 M

NO.	FREQ. (MHz)	EMISSION LEVEL (dBuV/m)	LIMIT (dBuV/m)	MARGIN (dB)	ANTENNA HEIGHT (m)	TABLE ANGLE (Degree)	RAW VALUE (dBuV)	CORRECTION FACTOR (dB/m)
1	*2437.00	110.7 PK			1.56 V	354	78.4	32.3
2	*2437.00	98.3 AV			1.56 V	354	66.0	32.3
3	2483.50	65.2 PK	74.0	-8.8	1.35 V	9	32.8	32.4
4	2483.50	52.7 AV	54.0	-1.3	1.35 V	9	20.3	32.4
5	4874.00	46.1 PK	74.0	-27.9	1.47 V	14	42.4	3.7
6	4874.00	34.4 AV	54.0	-19.6	1.47 V	14	30.7	3.7

Remarks:

1. Emission Level(dBuV/m) = Raw Value(dBuV) + Correction Factor(dB/m).
2. Correction Factor(dB/m) = Antenna Factor(dB/m) + Cable Factor(dB) – Pre-Amplifier Factor(dB).
3. Margin value = Emission Level – Limit value.
4. The other emission levels were very low against the limit.
5. " * ": Fundamental frequency.

CHANNEL	TX Channel 9	DETECTOR FUNCTION	Peak (PK) Average (AV)
FREQUENCY RANGE	1GHz ~ 25GHz		

ANTENNA POLARITY & TEST DISTANCE: HORIZONTAL AT 3 M

NO.	FREQ. (MHz)	EMISSION LEVEL (dBuV/m)	LIMIT (dBuV/m)	MARGIN (dB)	ANTENNA HEIGHT (m)	TABLE ANGLE (Degree)	RAW VALUE (dBuV)	CORRECTION FACTOR (dB/m)
1	*2452.00	94.0 PK			1.16 H	20	61.6	32.4
2	*2452.00	81.8 AV			1.16 H	20	49.4	32.4
3	2483.50	58.6 PK	74.0	-15.4	1.20 H	22	26.2	32.4
4	2483.50	47.4 AV	54.0	-6.6	1.20 H	22	15.0	32.4
5	4904.00	46.3 PK	74.0	-27.7	1.42 H	306	42.6	3.7
6	4904.00	34.8 AV	54.0	-19.2	1.42 H	306	31.1	3.7

ANTENNA POLARITY & TEST DISTANCE: VERTICAL AT 3 M

NO.	FREQ. (MHz)	EMISSION LEVEL (dBuV/m)	LIMIT (dBuV/m)	MARGIN (dB)	ANTENNA HEIGHT (m)	TABLE ANGLE (Degree)	RAW VALUE (dBuV)	CORRECTION FACTOR (dB/m)
1	*2452.00	108.0 PK			1.63 V	339	75.6	32.4
2	*2452.00	96.2 AV			1.63 V	339	63.8	32.4
3	2483.50	65.9 PK	74.0	-8.1	1.92 V	12	33.5	32.4
4	2483.50	52.4 AV	54.0	-1.6	1.92 V	12	20.0	32.4
5	4904.00	47.1 PK	74.0	-26.9	1.42 V	6	43.4	3.7
6	4904.00	34.2 AV	54.0	-19.8	1.42 V	6	30.5	3.7

Remarks:

1. Emission Level(dBuV/m) = Raw Value(dBuV) + Correction Factor(dB/m).
2. Correction Factor(dB/m) = Antenna Factor(dB/m) + Cable Factor(dB) – Pre-Amplifier Factor(dB).
3. Margin value = Emission Level – Limit value.
4. The other emission levels were very low against the limit.
5. " * ": Fundamental frequency.

Below 1GHz worst-case data:

802.11g

CHANNEL	TX Channel 6	DETECTOR FUNCTION	Quasi-Peak (QP)
FREQUENCY RANGE	9kHz ~ 1GHz		

ANTENNA POLARITY & TEST DISTANCE: HORIZONTAL AT 3 M								
NO.	FREQ. (MHz)	EMISSION LEVEL (dBuV/m)	LIMIT (dBuV/m)	MARGIN (dB)	ANTENNA HEIGHT (m)	TABLE ANGLE (Degree)	RAW VALUE (dBuV)	CORRECTION FACTOR (dB/m)
1	41.25	31.4 QP	40.0	-8.6	1.99 H	76	40.6	-9.2
2	110.13	37.4 QP	43.5	-6.1	1.49 H	324	49.2	-11.8
3	127.00	33.7 QP	43.5	-9.8	1.49 H	271	44.1	-10.4
4	146.68	32.3 QP	43.5	-11.2	1.00 H	231	41.0	-8.7
5	207.13	29.2 QP	43.5	-14.3	1.99 H	62	40.8	-11.6
6	441.90	30.2 QP	46.0	-15.8	1.99 H	83	33.0	-2.8

Remarks:

1. Emission Level(dBuV/m) = Raw Value(dBuV) + Correction Factor(dB/m).
2. Correction Factor(dB/m) = Antenna Factor(dB/m) + Cable Factor(dB) – Pre-Amplifier Factor(dB).
3. The other emission levels were very low against the limit of frequency range 30MHz ~ 1000MHz.
4. Margin value = Emission Level – Limit value.
5. The emission levels were very low against the limit of frequency range 9kHz ~ 30MHz: the amplitude of spurious emissions attenuated more than 20 dB below the permissible value to be report.

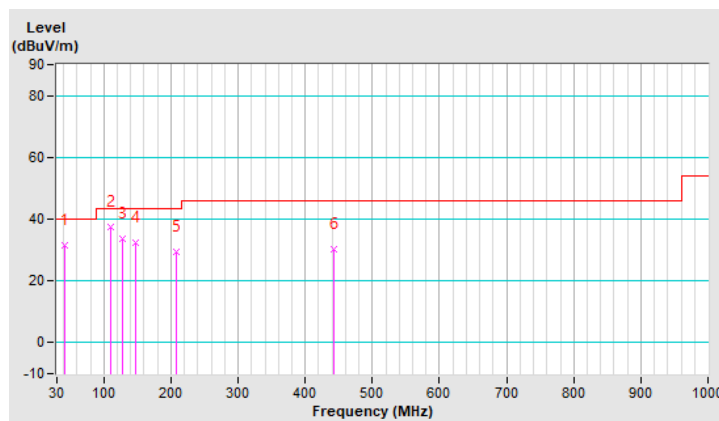

CHANNEL	TX Channel 6	DETECTOR FUNCTION	Quasi-Peak (QP)
FREQUENCY RANGE	9kHz ~ 1GHz		

ANTENNA POLARITY & TEST DISTANCE: VERTICAL AT 3 M								
NO.	FREQ. (MHz)	EMISSION LEVEL (dBuV/m)	LIMIT (dBuV/m)	MARGIN (dB)	ANTENNA HEIGHT (m)	TABLE ANGLE (Degree)	RAW VALUE (dBuV)	CORRECTION FACTOR (dB/m)
1	31.30	36.7 QP	40.0	-3.3	1.00 V	207	47.4	-10.7
2	59.52	36.2 QP	40.0	-3.8	1.00 V	2	45.4	-9.2
3	111.54	38.7 QP	43.5	-4.8	1.00 V	22	50.5	-11.8
4	149.49	35.7 QP	43.5	-7.8	1.00 V	149	44.2	-8.5
5	188.86	31.9 QP	43.5	-11.6	1.00 V	122	42.8	-10.9
6	448.93	34.7 QP	46.0	-11.3	1.00 V	181	37.3	-2.6

Remarks:

1. Emission Level(dBuV/m) = Raw Value(dBuV) + Correction Factor(dB/m).
2. Correction Factor(dB/m) = Antenna Factor(dB/m) + Cable Factor(dB) – Pre-Amplifier Factor(dB).
3. The other emission levels were very low against the limit of frequency range 30MHz ~ 1000MHz.
4. Margin value = Emission Level – Limit value.
5. The emission levels were very low against the limit of frequency range 9kHz ~ 30MHz: the amplitude of spurious emissions attenuated more than 20 dB below the permissible value to be report.

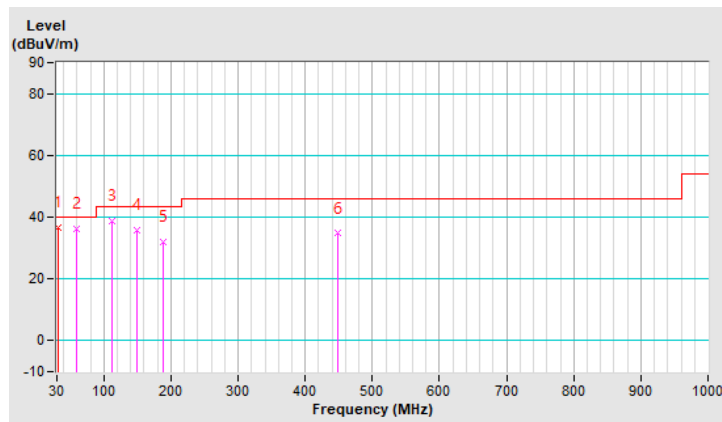

4.2 Conducted Emission Measurement

4.2.1 Limits of Conducted Emission Measurement

Frequency (MHz)	Conducted Limit (dBuV)	
	Quasi-peak	Average
0.15 - 0.5	66 - 56	56 - 46
0.50 - 5.0	56	46
5.0 - 30.0	60	50

Note: 1. The lower limit shall apply at the transition frequencies.
 2. The limit decreases in line with the logarithm of the frequency in the range of 0.15 to 0.50MHz.

4.2.2 Test Instruments

Description & Manufacturer	Model No.	Serial No.	Cal. Date	Cal. Due
Test Receiver ROHDE & SCHWARZ	ESCI	100613	Dec. 11, 2019	Dec. 10, 2020
RF signal cable Woken	5D-FB	Cable-cond1-01	Sep. 05, 2019	Sep. 04, 2020
LISN ROHDE & SCHWARZ (EUT)	ENV216	101826	Feb. 20, 2020	Feb. 19, 2021
LISN ROHDE & SCHWARZ (Peripheral)	ESH3-Z5	100311	Aug. 22, 2019	Aug. 21, 2020
Software ADT	BV ADT_Cond_ V7.3.7.4	NA	NA	NA

Note: 1. The calibration interval of the above test instruments is 12 months and the calibrations are traceable to NML/ROC and NIST/USA.
 2. The test was performed in HwaYa Shielded Room 1.
 3. The VCCI Site Registration No. is C-12040.

4.2.3 Test Procedures

- The EUT was placed 0.4 meters from the conducting wall of the shielded room with EUT being connected to the power mains through a line impedance stabilization network (LISN). Other support units were connected to the power mains through another LISN. The two LISNs provide 50 ohm/ 50uH of coupling impedance for the measuring instrument.
- Both lines of the power mains connected to the EUT were checked for maximum conducted interference.
- The frequency range from 150kHz to 30MHz was searched. Emission levels under (Limit - 20dB) was not recorded.

Note: The resolution bandwidth and video bandwidth of test receiver is 9kHz for quasi-peak detection (QP) and average detection (AV) at frequency 0.15MHz-30MHz.

4.2.4 Deviation from Test Standard

No deviation.

4.2.5 Test Setup

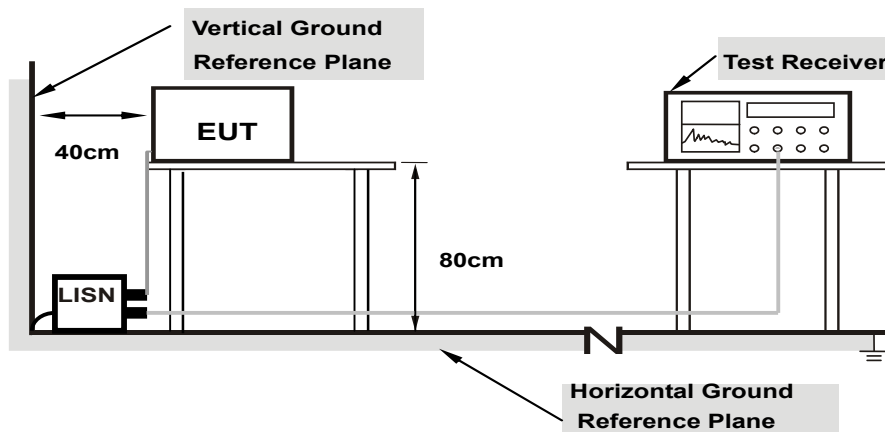

Note: 1.Support units were connected to second LISN.

For the actual test configuration, please refer to the attached file (Test Setup Photo).

4.2.6 EUT Operating Conditions

Same as 4.1.6.

4.2.7 Test Results

Worst-case data:

802.11g

Phase	Line (L)	Detector Function	Quasi-Peak (QP) / Average (AV)
-------	----------	-------------------	--------------------------------

No	Freq. [MHz]	Corr. Factor (dB)	Reading Value [dB (uV)]		Emission Level [dB (uV)]		Limit [dB (uV)]		Margin (dB)	
			Q.P.	AV.	Q.P.	AV.	Q.P.	AV.	Q.P.	AV.
			1	0.15000	9.63	43.99	29.29	53.62	38.92	66.00
2	0.16190	9.63	42.11	26.56	51.74	36.19	65.37	55.37	-13.63	-19.18
3	0.18200	9.62	38.13	23.59	47.75	33.21	64.39	54.39	-16.64	-21.18
4	0.21400	9.62	32.58	18.88	42.20	28.50	63.05	53.05	-20.85	-24.55
5	0.23351	9.63	30.84	18.46	40.47	28.09	62.32	52.32	-21.85	-24.23
6	0.46322	9.65	35.38	30.90	45.03	40.55	56.63	46.63	-11.60	-6.08

Remarks:

1. Q.P. and AV. are abbreviations of quasi-peak and average individually.
2. The emission levels of other frequencies were very low against the limit.
3. Margin value = Emission level - Limit value
4. Correction factor = Insertion loss + Cable loss
5. Emission Level = Correction Factor + Reading Value.

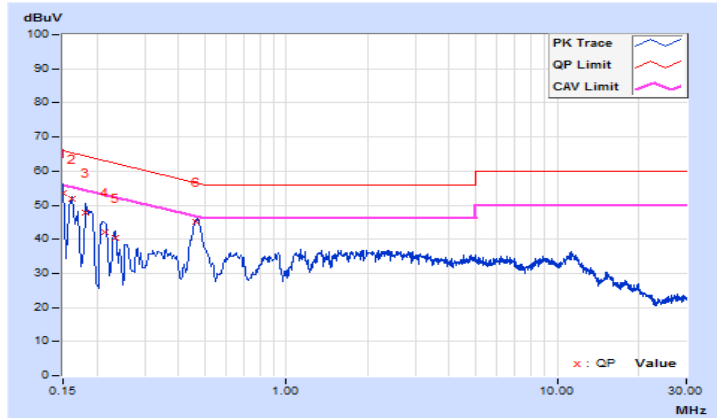

Phase	Neutral (N)	Detector Function	Quasi-Peak (QP) / Average (AV)
-------	-------------	-------------------	--------------------------------

No	Freq. [MHz]	Corr. Factor (dB)	Reading Value [dB (uV)]		Emission Level [dB (uV)]		Limit [dB (uV)]		Margin (dB)	
			Q.P.	AV.	Q.P.	AV.	Q.P.	AV.	Q.P.	AV.
			1	0.15687	9.66	43.50	28.72	53.16	38.38	65.63
2	0.17400	9.65	40.10	25.09	49.75	34.74	64.77	54.77	-15.02	-20.03
3	0.20600	9.64	34.50	20.01	44.14	29.65	63.37	53.37	-19.23	-23.72
4	0.22200	9.64	32.10	16.88	41.74	26.52	62.74	52.74	-21.00	-26.22
5	0.25000	9.65	28.25	16.20	37.90	25.85	61.76	51.76	-23.86	-25.91
6	0.47000	9.67	35.68	30.41	45.35	40.08	56.51	46.51	-11.16	-6.43

Remarks:

1. Q.P. and AV. are abbreviations of quasi-peak and average individually.
2. The emission levels of other frequencies were very low against the limit.
3. Margin value = Emission level - Limit value
4. Correction factor = Insertion loss + Cable loss
5. Emission Level = Correction Factor + Reading Value.

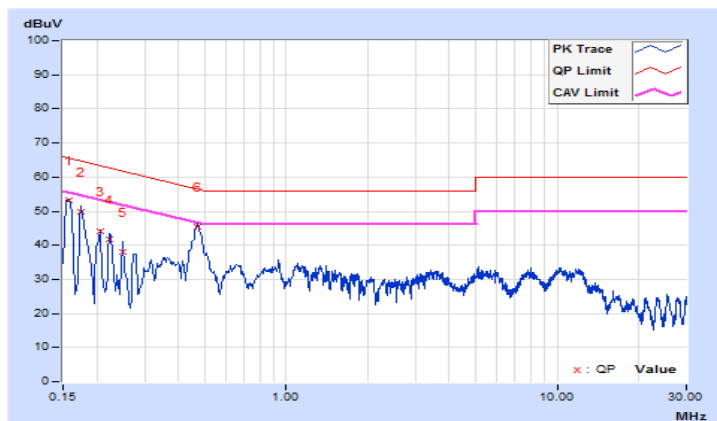

4.3 6dB Bandwidth Measurement

4.3.1 Limits of 6dB Bandwidth Measurement

The minimum of 6dB Bandwidth Measurement is 0.5 MHz.

4.3.2 Test Setup

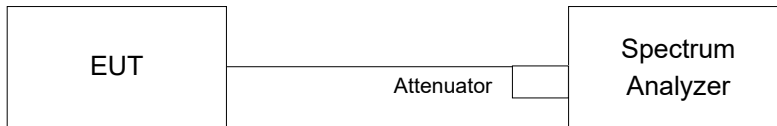

4.3.3 Test Instruments

Refer to section 4.1.2 to get information of above instrument.

4.3.4 Test Procedure

- Set resolution bandwidth (RBW) = 100kHz.
- Set the video bandwidth (VBW) $\geq 3 \times$ RBW, Detector = peak.
- Trace mode = max hold.
- Sweep = auto couple.
- Measure the maximum width of the emission that is constrained by the frequencies associated with the two amplitude points (upper and lower) that are attenuated by 6 dB relative to the maximum level measured in the fundamental emission.

4.3.5 Deviation from Test Standard

No deviation.

4.3.6 EUT Operating Conditions

The software provided by client to enable the EUT under transmission condition continuously at lowest, middle and highest channel frequencies individually.

4.3.7 Test Result

802.11b

Channel	Frequency (MHz)	6dB Bandwidth (MHz)		Minimum Limit (MHz)	Pass / Fail
		Chain 0	Chain 1		
1	2412	7.63	8.12	0.5	Pass
6	2437	8.14	8.10	0.5	Pass
11	2462	8.56	7.63	0.5	Pass

802.11g

Channel	Frequency (MHz)	6dB Bandwidth (MHz)		Minimum Limit (MHz)	Pass / Fail
		Chain 0	Chain 1		
1	2412	15.72	16.08	0.5	Pass
6	2437	16.31	15.80	0.5	Pass
11	2462	15.86	16.08	0.5	Pass

802.11ax (HE20)

Channel	Frequency (MHz)	6dB Bandwidth (MHz)		Minimum Limit (MHz)	Pass / Fail
		Chain 0	Chain 1		
1	2412	18.57	18.44	0.5	Pass
6	2437	18.78	18.48	0.5	Pass
11	2462	18.66	17.94	0.5	Pass

802.11ax (HE40)

Channel	Frequency (MHz)	6dB Bandwidth (MHz)		Minimum Limit (MHz)	Pass / Fail
		Chain 0	Chain 1		
3	2422	37.98	37.79	0.5	Pass
6	2437	37.80	37.78	0.5	Pass
9	2452	38.02	37.87	0.5	Pass

Spectrum Plot of Worst Value

802.11b

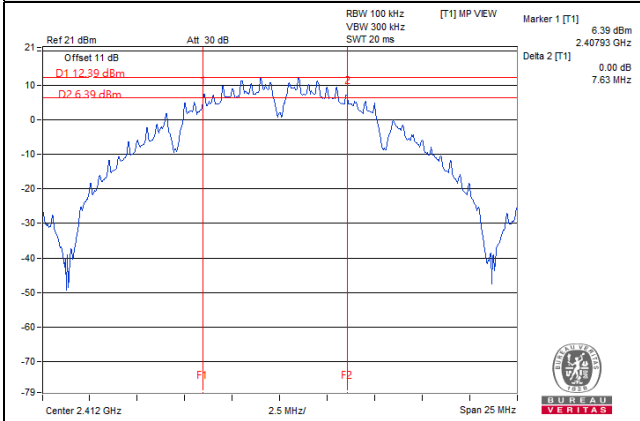

802.11g

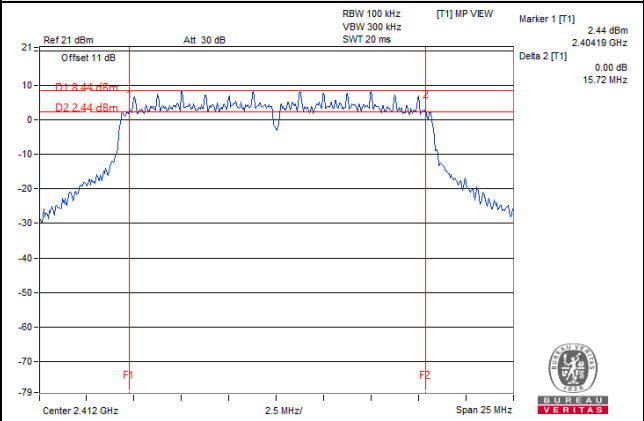

802.11ax (HE20)

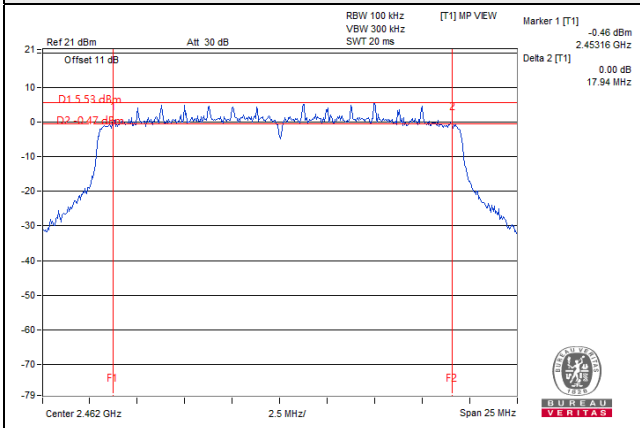

802.11ax (HE40)

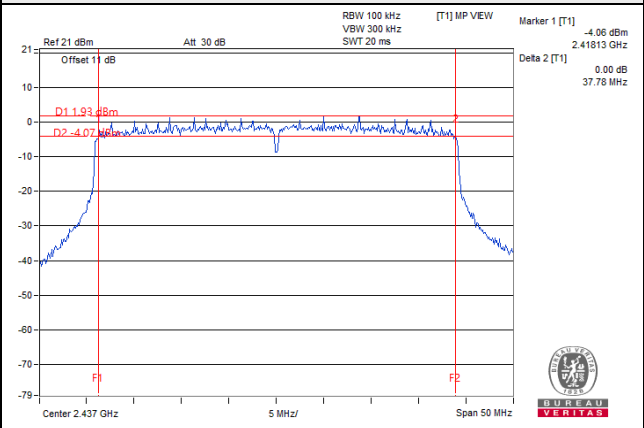

4.4 Conducted Output Power Measurement

4.4.1 Limits of Conducted Output Power Measurement

For systems using digital modulation in the 2400–2483.5 MHz bands: 1 Watt (30dBm)

Per KDB 662911 D01 Multiple Transmitter Output Method of conducted output power measurement on IEEE 802.11 devices,

Array Gain = 0 dB (i.e., no array gain) for $N_{ANT} \leq 4$;

Array Gain = 0 dB (i.e., no array gain) for channel widths ≥ 40 MHz for any N_{ANT} ;

Array Gain = $5 \log(N_{ANT}/N_{SS})$ dB or 3 dB, whichever is less for 20-MHz channel widths with $N_{ANT} \geq 5$.

For power measurements on all other devices: Array Gain = $10 \log(N_{ANT}/N_{SS})$ dB.

4.4.2 Test Setup

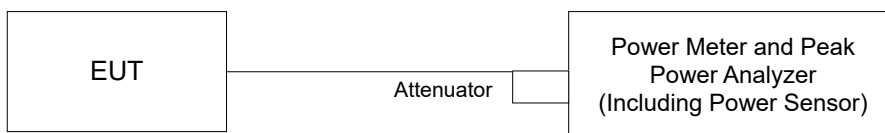

4.4.3 Test Instruments

Refer to section 4.1.2 to get information of above instrument.

4.4.4 Test Procedures

Average power sensor was used to perform output power measurement, trigger and gating function of wide band power meter is enabled to measure max output power of TX on burst. Duty factor is not added to measured value.

4.4.5 Deviation from Test Standard

No deviation.

4.4.6 EUT Operating Conditions

Same as item 4.3.6.

4.4.7 Test Results

CDD Mode

802.11b

Channel	Frequency (MHz)	Average Power (dBm)		Total Power (mW)	Total Power (dBm)	Limit (dBm)	Pass / Fail
		Chain 0	Chain 1				
1	2412	20.89	20.31	230.143	23.62	30.00	Pass
6	2437	22.99	22.44	374.455	25.73	30.00	Pass
11	2462	20.96	20.45	235.656	23.72	30.00	Pass

802.11g

Channel	Frequency (MHz)	Average Power (dBm)		Total Power (mW)	Total Power (dBm)	Limit (dBm)	Pass / Fail
		Chain 0	Chain 1				
1	2412	19.32	18.97	164.393	22.16	30.00	Pass
6	2437	22.94	22.51	375.027	25.74	30.00	Pass
11	2462	18.15	17.62	123.123	20.90	30.00	Pass

802.11n (HT20)

Channel	Frequency (MHz)	Average Power (dBm)		Total Power (mW)	Total Power (dBm)	Limit (dBm)	Pass / Fail
		Chain 0	Chain 1				
1	2412	17.45	16.92	104.794	20.20	30.00	Pass
6	2437	21.90	21.81	306.587	24.87	30.00	Pass
11	2462	15.55	15.25	69.389	18.41	30.00	Pass

802.11n (HT40)

Channel	Frequency (MHz)	Average Power (dBm)		Total Power (mW)	Total Power (dBm)	Limit (dBm)	Pass / Fail
		Chain 0	Chain 1				
3	2422	14.24	14.55	55.056	17.41	30.00	Pass
6	2437	16.04	15.78	78.023	18.92	30.00	Pass
9	2452	13.45	12.90	41.629	16.19	30.00	Pass

802.11n (VHT20)

Channel	Frequency (MHz)	Average Power (dBm)		Total Power (mW)	Total Power (dBm)	Limit (dBm)	Pass / Fail
		Chain 0	Chain 1				
1	2412	17.70	17.23	111.729	20.48	30.00	Pass
6	2437	22.22	22.02	325.946	25.13	30.00	Pass
11	2462	15.85	15.60	74.767	18.74	30.00	Pass

802.11n (VHT40)

Channel	Frequency (MHz)	Average Power (dBm)		Total Power (mW)	Total Power (dBm)	Limit (dBm)	Pass / Fail
		Chain 0	Chain 1				
3	2422	14.55	14.80	58.71	17.69	30.00	Pass
6	2437	16.34	16.05	83.324	19.21	30.00	Pass
9	2452	13.75	13.20	44.607	16.49	30.00	Pass

802.11ax (HE20)

Channel	Frequency (MHz)	Average Power (dBm)		Total Power (mW)	Total Power (dBm)	Limit (dBm)	Pass / Fail
		Chain 0	Chain 1				
1	2412	17.95	17.41	117.454	20.70	30.00	Pass
6	2437	22.42	22.33	345.584	25.39	30.00	Pass
11	2462	16.13	15.77	78.778	18.96	30.00	Pass

802.11ax (HE40)

Channel	Frequency (MHz)	Average Power (dBm)		Total Power (mW)	Total Power (dBm)	Limit (dBm)	Pass / Fail
		Chain 0	Chain 1				
3	2422	15.38	15.05	66.503	18.23	30.00	Pass
6	2437	16.55	16.23	87.161	19.40	30.00	Pass
9	2452	13.95	13.47	47.064	16.73	30.00	Pass

Beamforming Mode

802.11n (HT20)

Channel	Frequency (MHz)	Average Power (dBm)		Total Power (mW)	Total Power (dBm)	Limit (dBm)	Pass / Fail
		Chain 0	Chain 1				
1	2412	14.44	13.91	52.401	17.19	27.82	Pass
6	2437	18.89	18.80	153.304	21.86	27.82	Pass
11	2462	12.54	12.24	34.697	15.40	27.82	Pass

Note: Directional gain = $5.17\text{dBi} + 10\log(2) = 8.18\text{dBi} > 6\text{dBi}$, so the power limit shall be reduced to $30 - (8.18 - 6) = 27.82\text{dBi}$.

802.11n (HT40)

Channel	Frequency (MHz)	Average Power (dBm)		Total Power (mW)	Total Power (dBm)	Limit (dBm)	Pass / Fail
		Chain 0	Chain 1				
3	2422	11.23	11.54	27.53	14.40	27.82	Pass
6	2437	13.00	12.77	38.876	15.90	27.82	Pass
9	2452	10.44	9.89	20.816	13.18	27.82	Pass

Note: Directional gain = $5.17\text{dBi} + 10\log(2) = 8.18\text{dBi} > 6\text{dBi}$, so the power limit shall be reduced to $30 - (8.18 - 6) = 27.82\text{dBi}$.

802.11n (VHT20)

Channel	Frequency (MHz)	Average Power (dBm)		Total Power (mW)	Total Power (dBm)	Limit (dBm)	Pass / Fail
		Chain 0	Chain 1				
1	2412	14.69	14.22	55.868	17.47	27.82	Pass
6	2437	19.21	19.01	162.984	22.12	27.82	Pass
11	2462	12.84	12.59	37.386	15.73	27.82	Pass

Note: Directional gain = $5.17\text{dBi} + 10\log(2) = 8.18\text{dBi} > 6\text{dBi}$, so the power limit shall be reduced to $30 - (8.18 - 6) = 27.82\text{dBi}$.

802.11n (VHT40)

Channel	Frequency (MHz)	Average Power (dBm)		Total Power (mW)	Total Power (dBm)	Limit (dBm)	Pass / Fail
		Chain 0	Chain 1				
3	2422	11.54	11.79	29.357	14.68	27.82	Pass
6	2437	13.33	13.04	41.665	16.20	27.82	Pass
9	2452	10.74	10.19	22.305	13.48	27.82	Pass

Note: Directional gain = $5.17\text{dBi} + 10\log(2) = 8.18\text{dBi} > 6\text{dBi}$, so the power limit shall be reduced to $30 - (8.18 - 6) = 27.82\text{dBi}$.

802.11ax (HE20)

Channel	Frequency (MHz)	Average Power (dBm)		Total Power (mW)	Total Power (dBm)	Limit (dBm)	Pass / Fail
		Chain 0	Chain 1				
1	2412	14.94	14.40	58.731	17.69	27.82	Pass
6	2437	19.41	19.32	172.804	22.38	27.82	Pass
11	2462	13.12	12.76	39.392	15.95	27.82	Pass

Note: Directional gain = $5.17\text{dBi} + 10\log(2) = 8.18\text{dBi} > 6\text{dBi}$, so the power limit shall be reduced to $30 - (8.18 - 6) = 27.82\text{dBi}$.

802.11ax (HE40)

Channel	Frequency (MHz)	Average Power (dBm)		Total Power (mW)	Total Power (dBm)	Limit (dBm)	Pass / Fail
		Chain 0	Chain 1				
3	2422	12.37	12.04	33.254	15.22	27.82	Pass
6	2437	13.54	13.22	43.584	16.39	27.82	Pass
9	2452	10.94	10.46	23.534	13.72	27.82	Pass

Note: Directional gain = $5.17\text{dBi} + 10\log(2) = 8.18\text{dBi} > 6\text{dBi}$, so the power limit shall be reduced to $30 - (8.18 - 6) = 27.82\text{dBi}$.

4.5 Power Spectral Density Measurement

4.5.1 Limits of Power Spectral Density Measurement

The Maximum of Power Spectral Density Measurement is 8dBm in any 3 kHz.

4.5.2 Test Setup

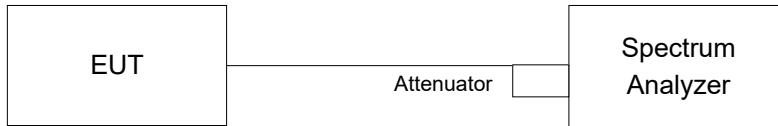

4.5.3 Test Instruments

Refer to section 4.1.2 to get information of above instrument.

4.5.4 Test Procedure

For Average Power (Duty cycle $\geq 98\%$)

- a. Set instrument center frequency to DTS channel center frequency.
- b. Set span to at least 1.5 times the OBW.
- c. Set RBW to: $3 \text{ kHz} \leq \text{RBW} \leq 100 \text{ kHz}$.
- d. Set VBW $\geq 3 \times \text{RBW}$.
- e. Detector = power averaging (RMS) or sample detector (when RMS not available).
- f. Ensure that the number of measurement points in the sweep $\geq 2 \times \text{span}/\text{RBW}$.
- g. Sweep time = auto couple.
- h. Employ trace averaging (RMS) mode over a minimum of 100 traces.
- i. Use the peak marker function to determine the maximum amplitude level.

For Average Power (Duty cycle $< 98\%$)

- a. Measure the duty cycle (x).
- b. Set instrument center frequency to DTS channel center frequency.
- c. Set span to at least 1.5 times the OBW.
- d. Set RBW to: $3 \text{ kHz} \leq \text{RBW} \leq 100 \text{ kHz}$.
- e. Set VBW $\geq 3 \times \text{RBW}$.
- f. Detector = power averaging (RMS) or sample detector (when RMS not available).
- g. Ensure that the number of measurement points in the sweep $\geq 2 \times \text{span}/\text{RBW}$.
- h. Sweep time = auto couple.
- i. Do not use sweep triggering. Allow sweep to "free run".
- j. Employ trace averaging (RMS) mode over a minimum of 100 traces.
- k. Use the peak marker function to determine the maximum amplitude level.
- l. Add $10 \log (1/x)$, where x is the duty cycle measured in step (a), to the measured PSD to compute the average PSD during the actual transmission time.

4.5.5 Deviation from Test Standard

No deviation.

4.5.6 EUT Operating Condition

Same as item 4.3.6

4.5.7 Test Results

802.11b

TX chain	Channel	Frequency (MHz)	PSD (dBm/3kHz)	10 log (N=2) dB	Total PSD (dBm/3kHz)	Limit (dBm/3kHz)	Pass / Fail
0	1	2412	-12.75	3.01	-9.74	5.82	Pass
	6	2437	-10.86	3.01	-7.85	5.82	Pass
	11	2462	-12.07	3.01	-9.06	5.82	Pass
1	1	2412	-12.78	3.01	-9.77	5.82	Pass
	6	2437	-10.85	3.01	-7.84	5.82	Pass
	11	2462	-12.85	3.01	-9.84	5.82	Pass

Note:

- Method E) 2) c) of power density measurement of KDB 662911 is using for calculating total power density, Measure and add $10 \log (N_{ANT})$ dB.
- Directional gain = $5.17\text{dBi} + 10\log(2) = 8.18\text{dBi} > 6\text{dBi}$, so the power density limit shall be reduced to $8 - (8.18 - 6) = 5.82\text{dBm}$.

802.11g

TX chain	Channel	Frequency (MHz)	PSD w/o Duty Factor (dBm/3kHz)	10 log (N=2) dB	Duty Factor (dB)	Total PSD With Duty Factor (dBm/3kHz)	Limit (dBm/3kHz)	Pass / Fail
0	1	2412	-17.57	3.01	0.29	-14.27	5.82	Pass
	6	2437	-14.83	3.01	0.29	-11.53	5.82	Pass
	11	2462	-18.84	3.01	0.29	-15.54	5.82	Pass
1	1	2412	-17.78	3.01	0.29	-14.48	5.82	Pass
	6	2437	-15.30	3.01	0.29	-12.00	5.82	Pass
	11	2462	-19.27	3.01	0.29	-15.97	5.82	Pass

Note:

- Method E) 2) c) of power density measurement of KDB 662911 is using for calculating total power density, Measure and add $10 \log (N_{ANT})$ dB.
- Directional gain = $5.17\text{dBi} + 10\log(2) = 8.18\text{dBi} > 6\text{dBi}$, so the power density limit shall be reduced to $8 - (8.18 - 6) = 5.82\text{dBm}$.
- Refer to section 3.3 for duty cycle spectrum plot.

802.11ax (HE20)

TX chain	Channel	Frequency (MHz)	PSD w/o Duty Factor (dBm/3kHz)	10 log (N=2) dB	Duty Factor (dB)	Total PSD With Duty Factor (dBm/3kHz)	Limit (dBm/3kHz)	Pass / Fail
0	1	2412	-21.06	3.01	0.22	-17.83	5.82	Pass
	6	2437	-16.29	3.01	0.22	-13.06	5.82	Pass
	11	2462	-23.60	3.01	0.22	-20.37	5.82	Pass
1	1	2412	-21.86	3.01	0.22	-18.63	5.82	Pass
	6	2437	-17.04	3.01	0.22	-13.81	5.82	Pass
	11	2462	-23.23	3.01	0.22	-20.00	5.82	Pass

Note:

- Method E) 2) c) of power density measurement of KDB 662911 is using for calculating total power density, Measure and add $10 \log (N_{ANT})$ dB.
- Directional gain = $5.17\text{dBi} + 10\log(2) = 8.18\text{dBi} > 6\text{dBi}$, so the power density limit shall be reduced to $8 - (8.18 - 6) = 5.82\text{dBm}$.
- Refer to section 3.3 for duty cycle spectrum plot.

802.11ax (HE40)

TX chain	Channel	Frequency (MHz)	PSD w/o Duty Factor (dBm/3kHz)	10 log (N=2) dB	Duty Factor (dB)	Total PSD With Duty Factor (dBm/3kHz)	Limit (dBm/3kHz)	Pass / Fail
0	3	2422	-26.46	3.01	0.18	-23.27	5.82	Pass
	6	2437	-25.36	3.01	0.18	-22.17	5.82	Pass
	9	2452	-27.67	3.01	0.18	-24.48	5.82	Pass
1	3	2422	-26.61	3.01	0.18	-23.42	5.82	Pass
	6	2437	-25.53	3.01	0.18	-22.34	5.82	Pass
	9	2452	-28.18	3.01	0.18	-24.99	5.82	Pass

Note:

- Method E) 2) c) of power density measurement of KDB 662911 is using for calculating total power density, Measure and add $10 \log (N_{ANT})$ dB.
- Directional gain = $5.17\text{dBi} + 10\log(2) = 8.18\text{dBi} > 6\text{dBi}$, so the power density limit shall be reduced to $8 - (8.18 - 6) = 5.82\text{dBm}$.
- Refer to section 3.3 for duty cycle spectrum plot.

Spectrum Plot of Worst Value

802.11b

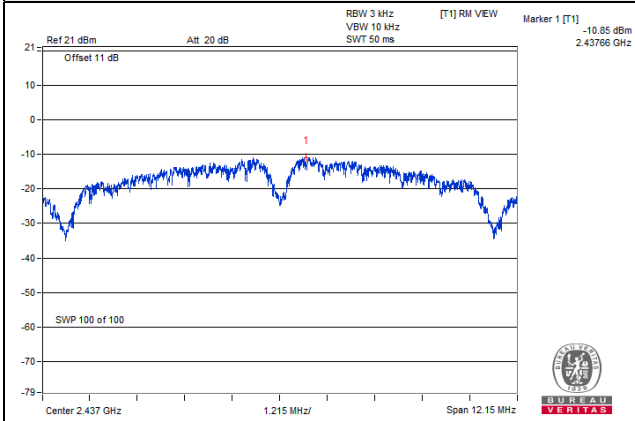

802.11g

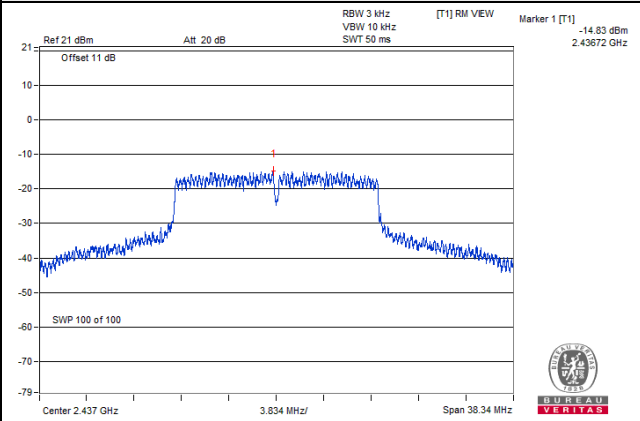

802.11ax (HE20)

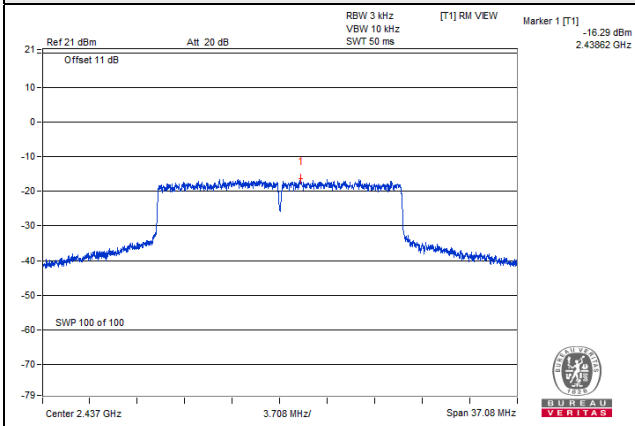

802.11ax (HE40)

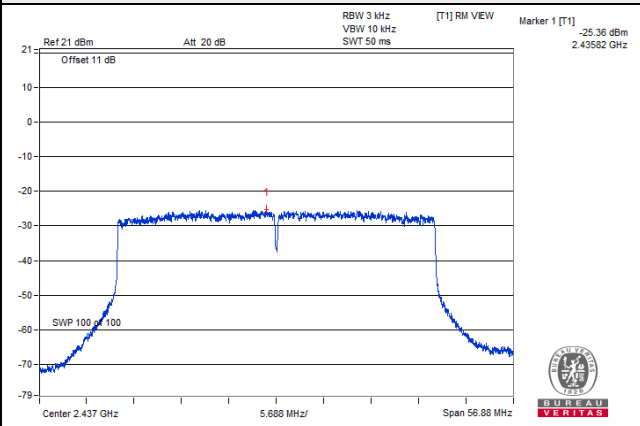

4.6 Conducted Out of Band Emission Measurement

4.6.1 Limits of Conducted Out of Band Emission Measurement

Below -30dB of the highest emission level of operating band (in 100kHz Resolution Bandwidth).

4.6.2 Test Setup

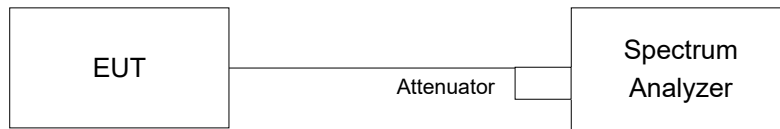

4.6.3 Test Instruments

Refer to section 4.1.2 to get information of above instrument.

4.6.4 Test Procedure

MEASUREMENT PROCEDURE REF

- Set the RBW = 100 kHz.
- Set the VBW \geq 300 kHz.
- Detector = peak.
- Sweep time = auto couple.
- Trace mode = max hold.
- Allow trace to fully stabilize.
- Use the peak marker function to determine the maximum power level in any 100 kHz band segment within the fundamental EBW.

MEASUREMENT PROCEDURE OOB

- Set RBW = 100 kHz.
- Set VBW \geq 300 kHz.
- Detector = peak.
- Sweep = auto couple.
- Trace Mode = max hold.
- Allow trace to fully stabilize.
- Use the peak marker function to determine the maximum amplitude level.

4.6.5 Deviation from Test Standard

No deviation.

4.6.6 EUT Operating Condition

Same as item 4.3.6

4.6.7 Test Results

The conducted emission test is performed on each TX port of operating mode without summing or adding 10log (N) since the limit is relative emission limit.

The spectrum plots are attached on the following pages. D1 line indicates the highest level, and D2 line indicates the 30dB offset below D1. It shows compliance with the requirement.

802.11b_Chain 0

CH 1

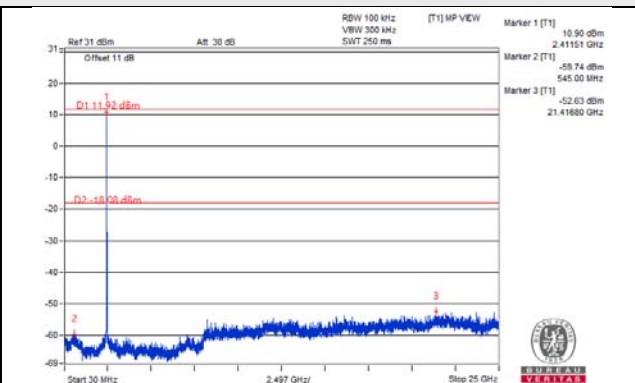
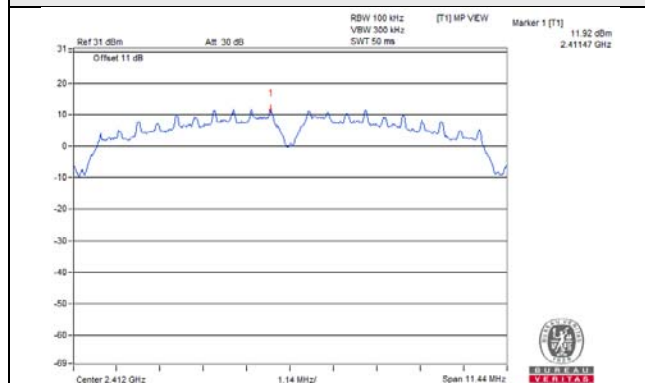

CH 6

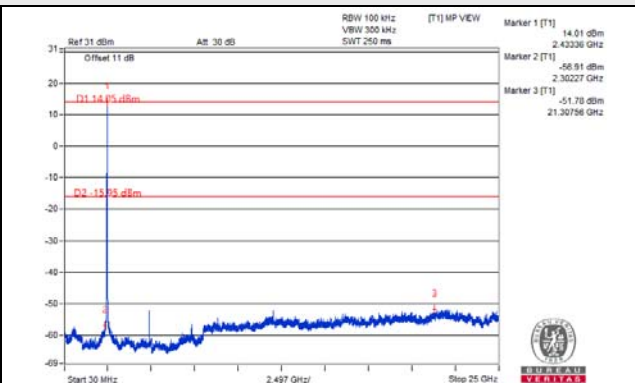
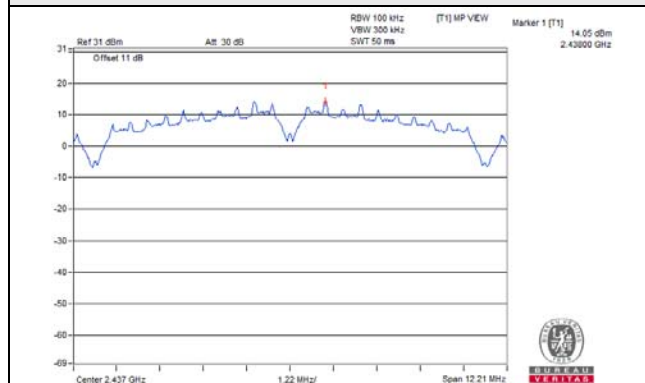

CH 11

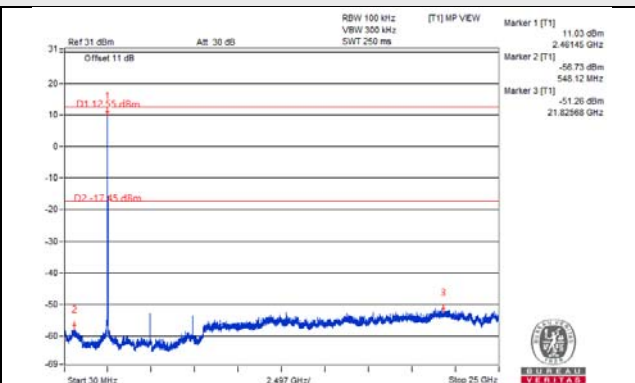
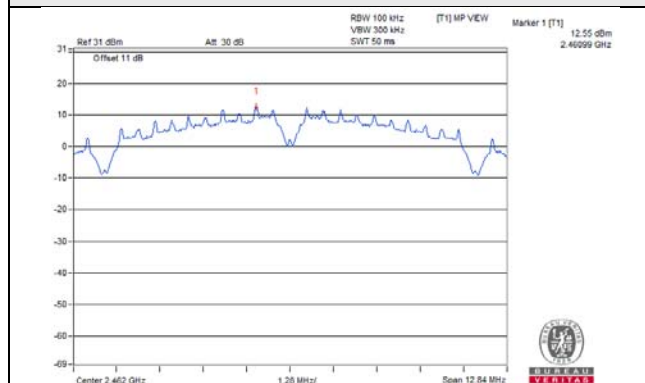

CH 1 Band edge

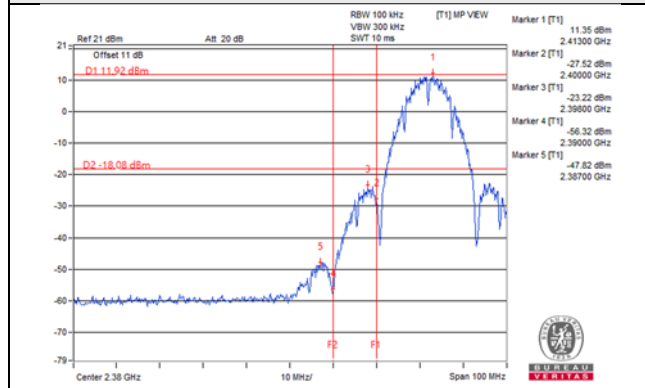

CH 11 Band edge

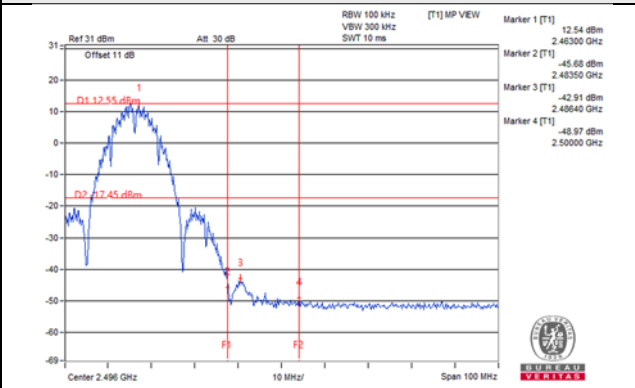

802.11b_Chain 1

CH 1

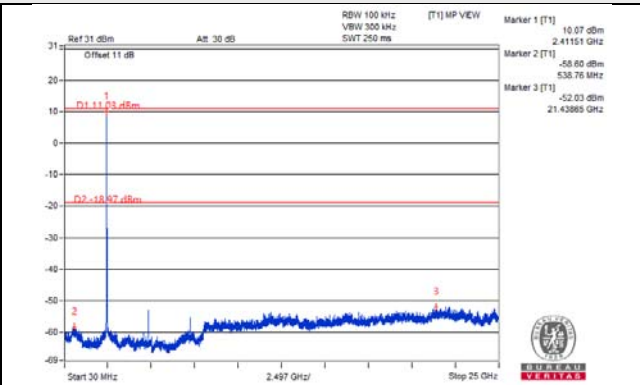
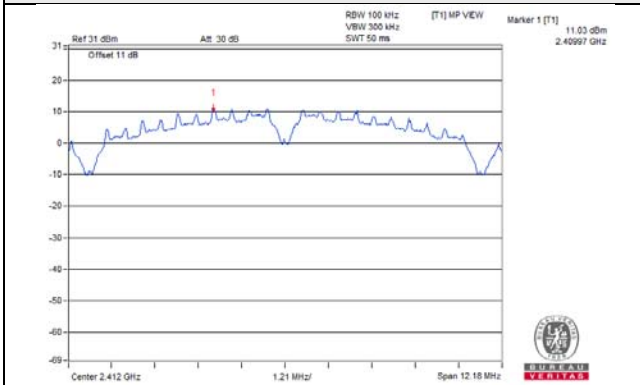

CH 6

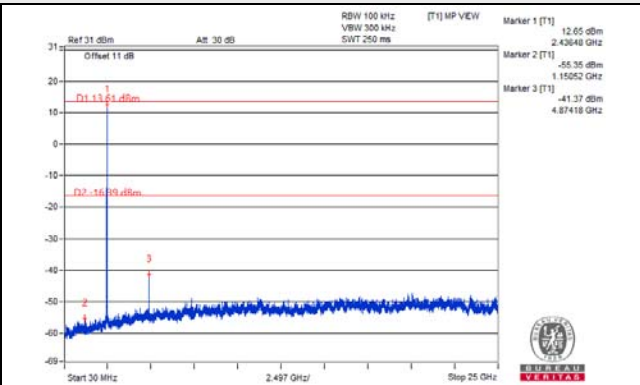
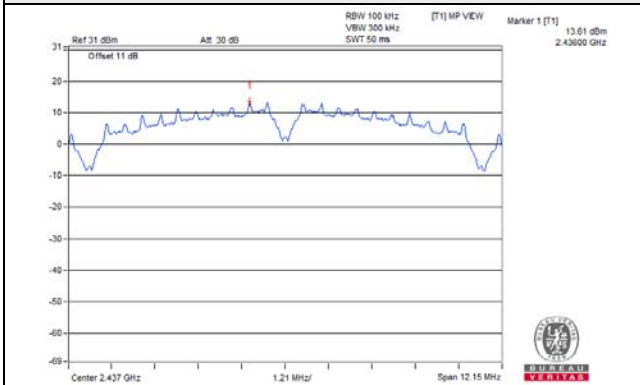

CH 11

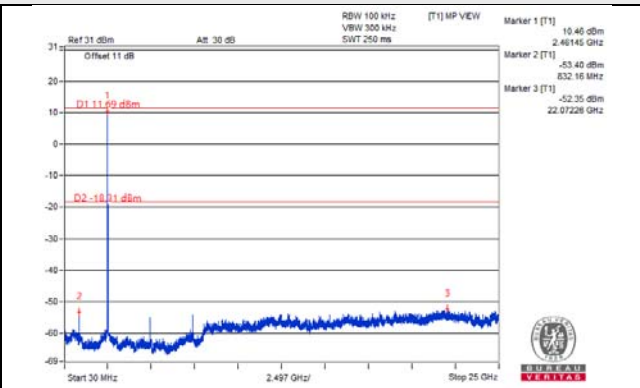
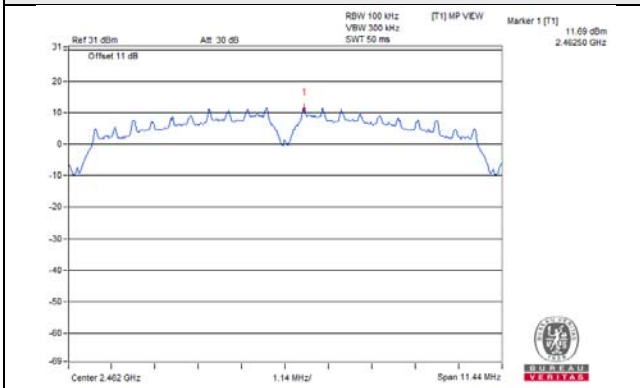

CH 1 Band edge

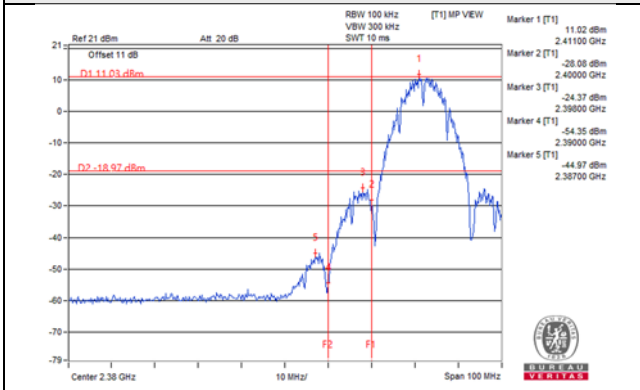

CH 11 Band edge

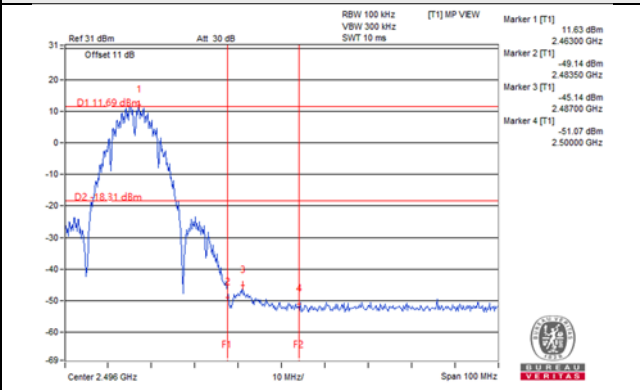

802.11g_Chain 0

CH 1

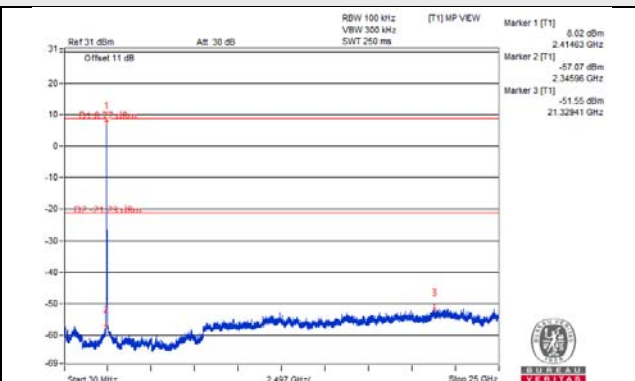
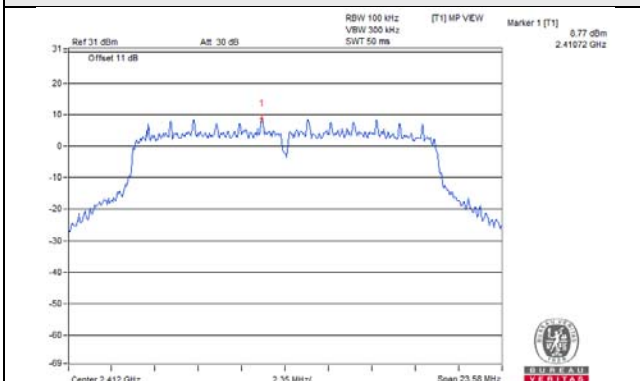

CH 6

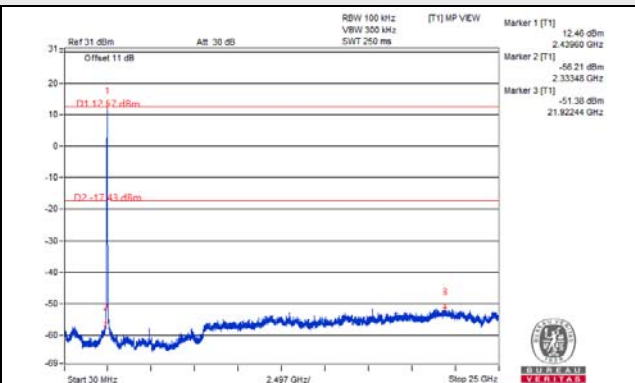
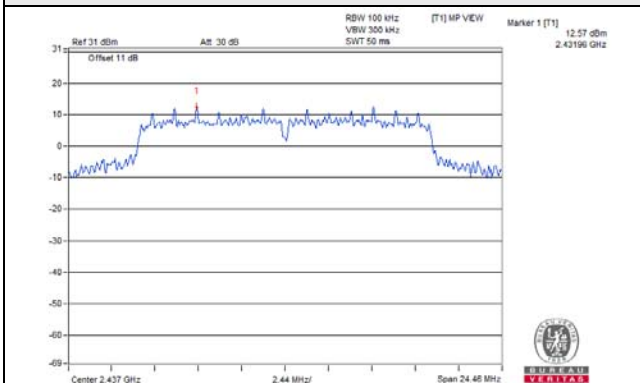

CH 11

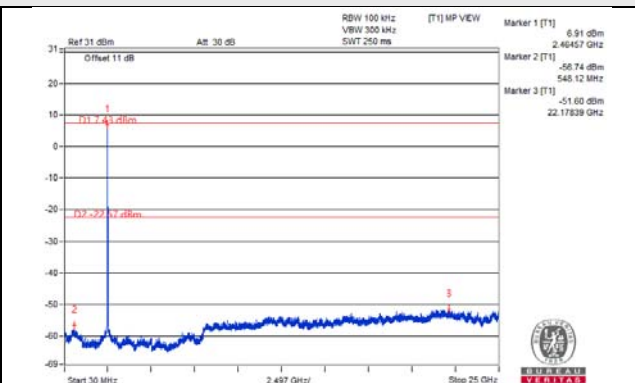
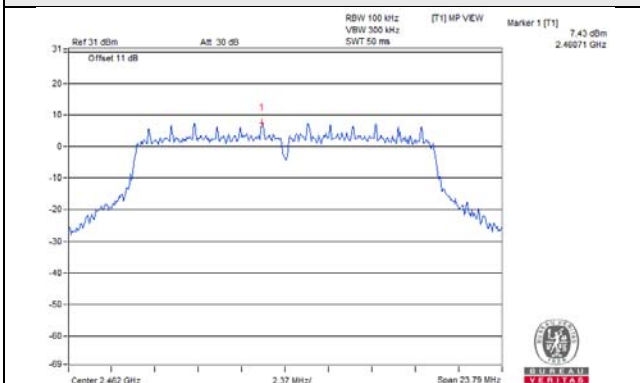

CH 1 Band edge

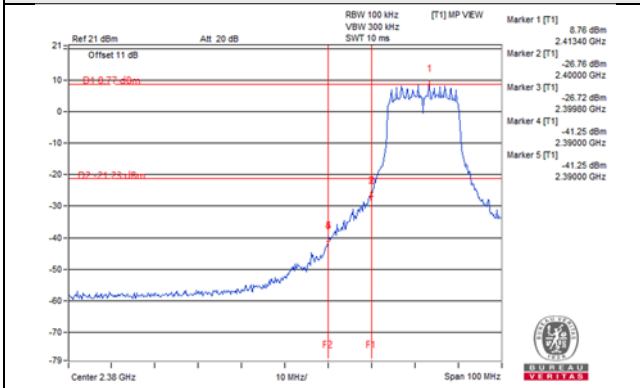

CH 11 Band edge

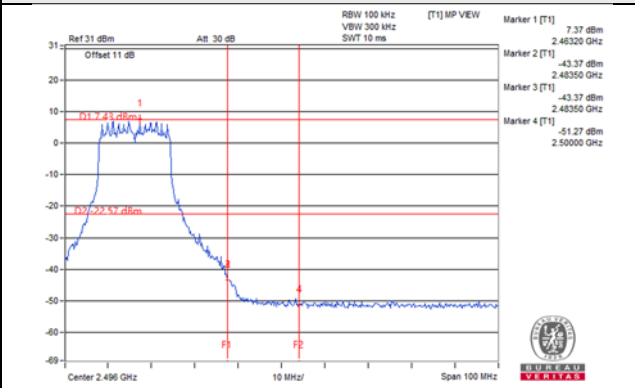

802.11g_Chain 1

CH 1

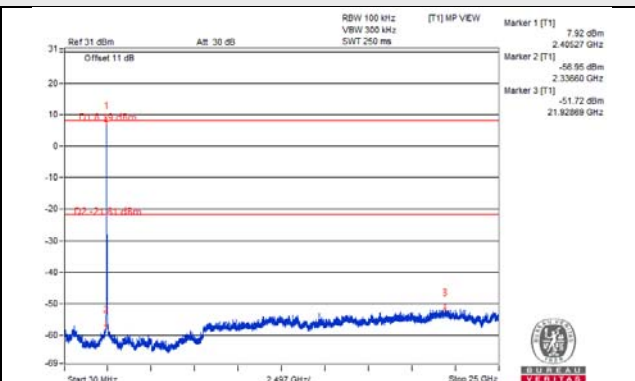
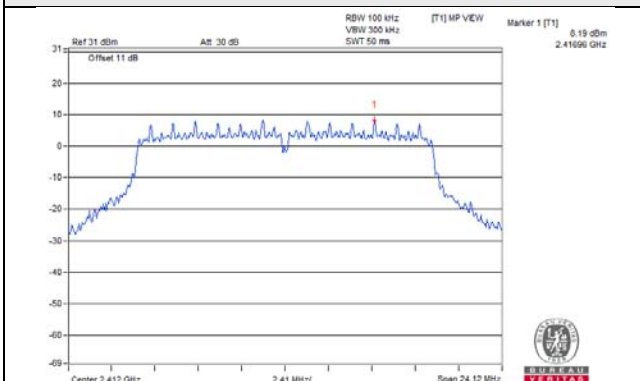

CH 6

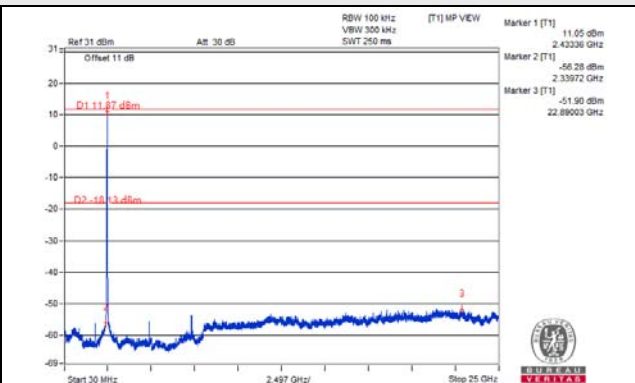
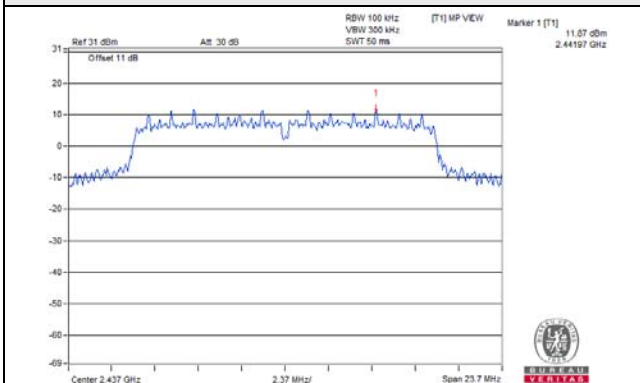

CH 11

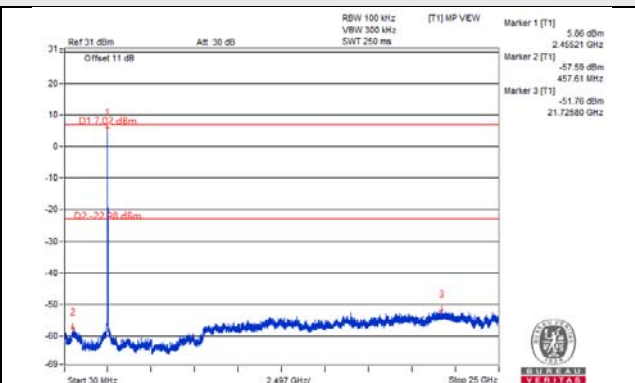
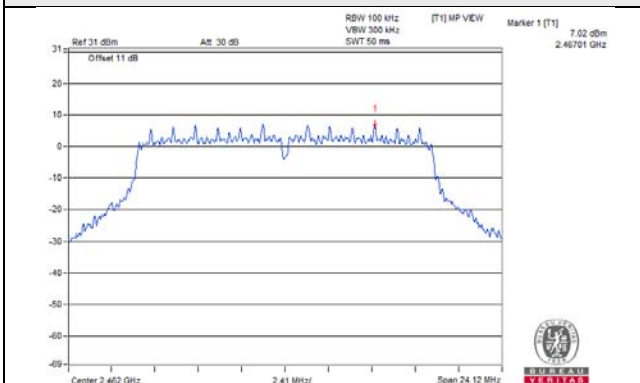

CH 1 Band edge

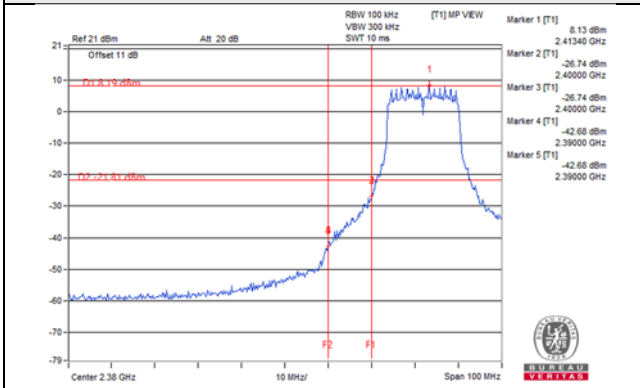

CH 11 Band edge

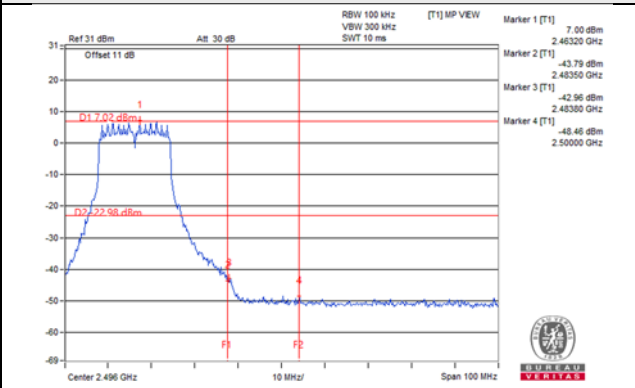

802.11ax (HE20)_Chain 0

CH 1

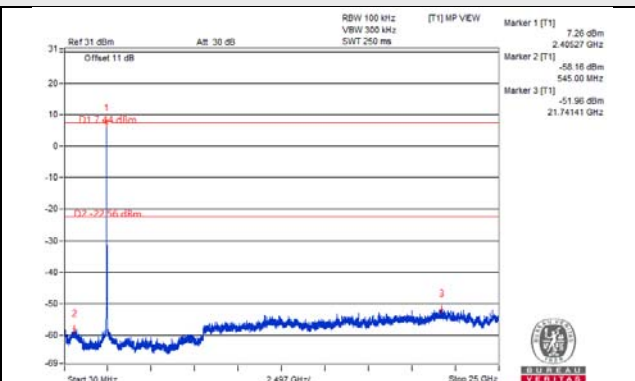
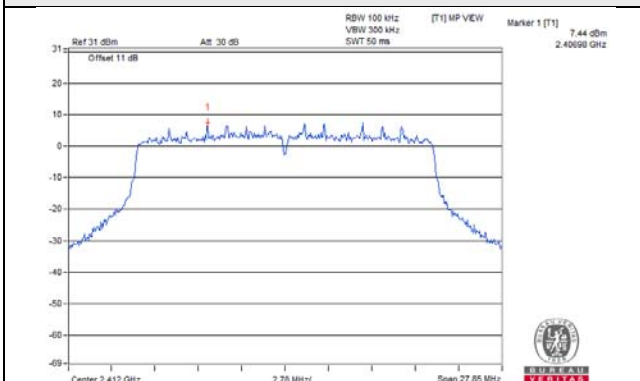

CH 6

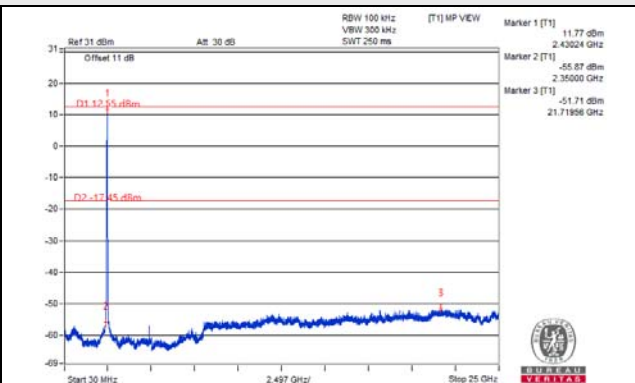
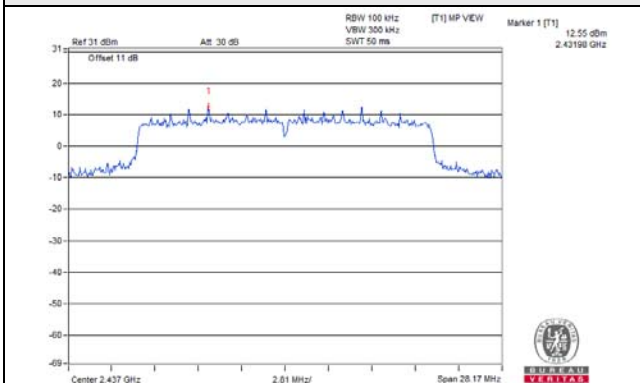

CH 11

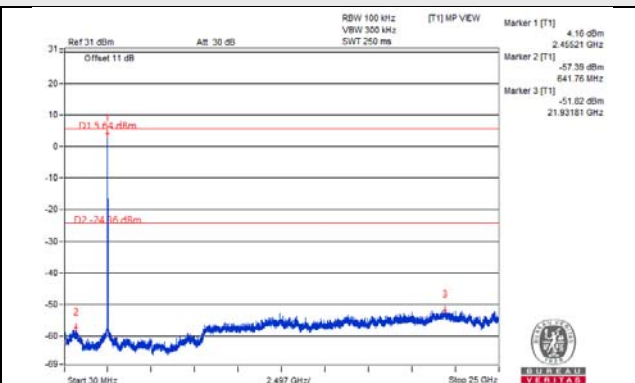
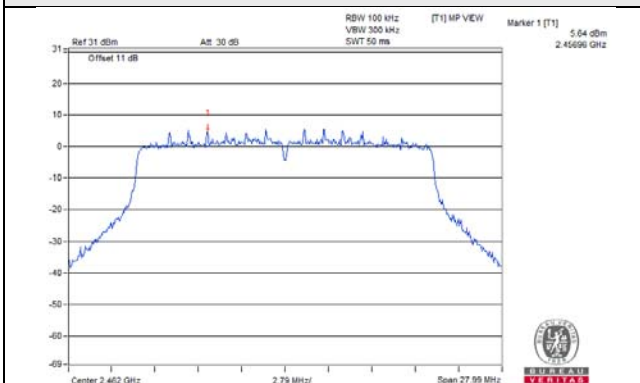

CH 1 Band edge

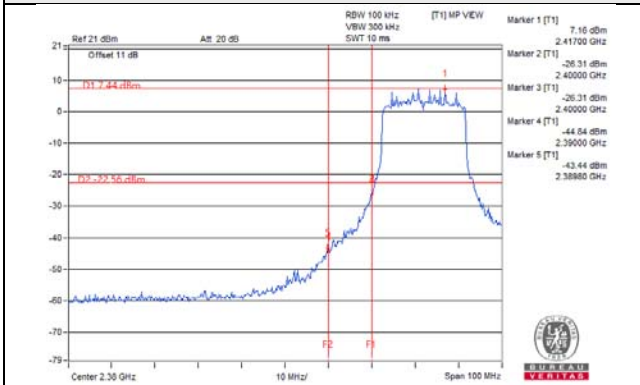

CH 11 Band edge

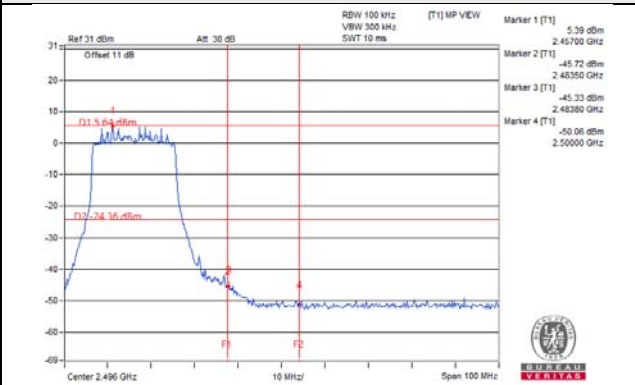

802.11ax (HE20)_Chain 1

CH 1

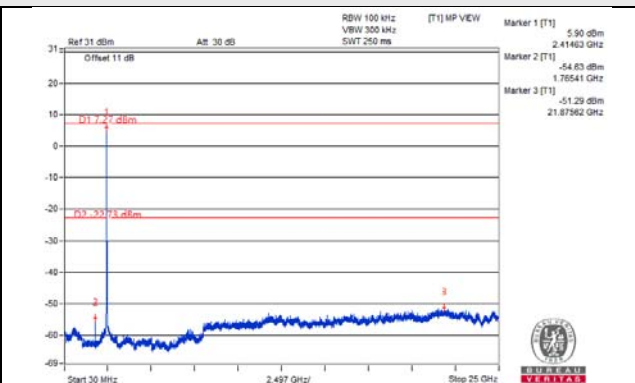
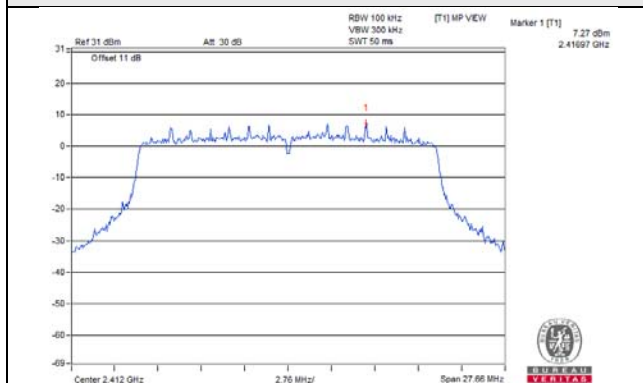

CH 6

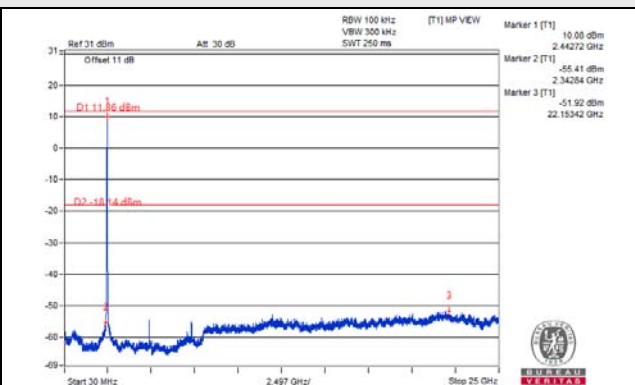
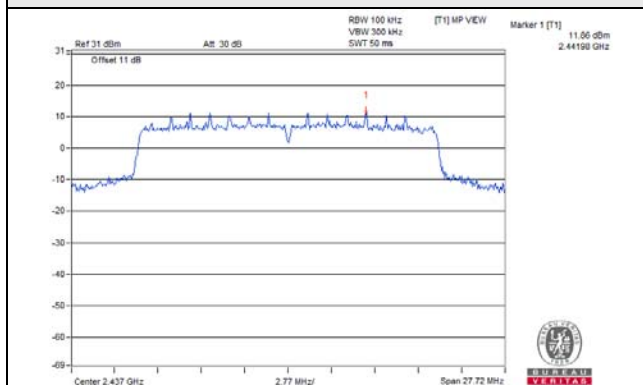

CH 11

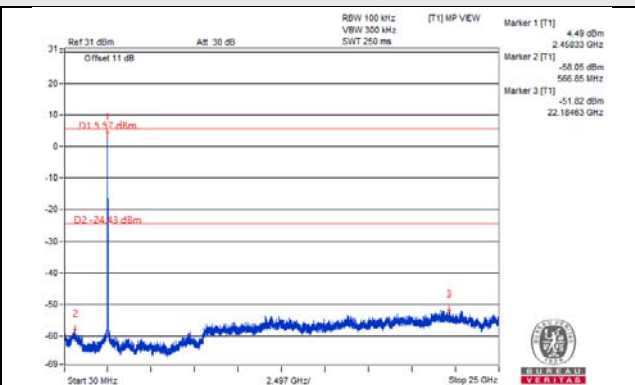
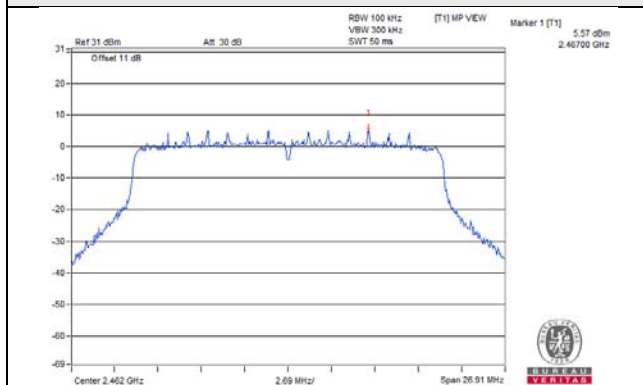

CH 1 Band edge

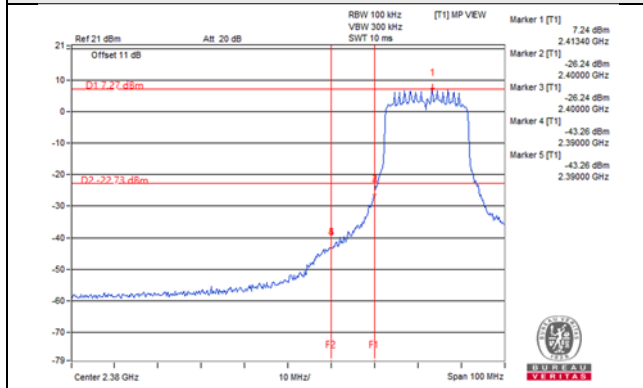

CH 11 Band edge

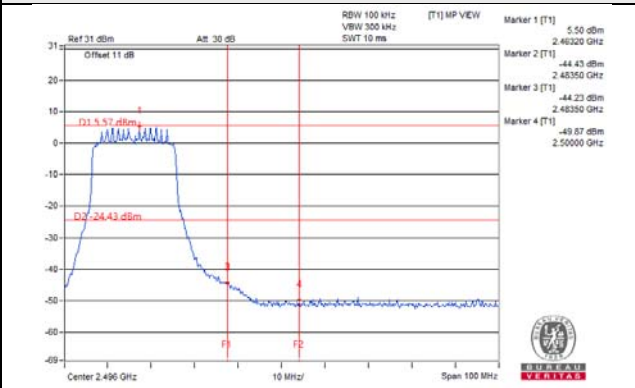

802.11ax (HE40)_Chain 0

CH 3

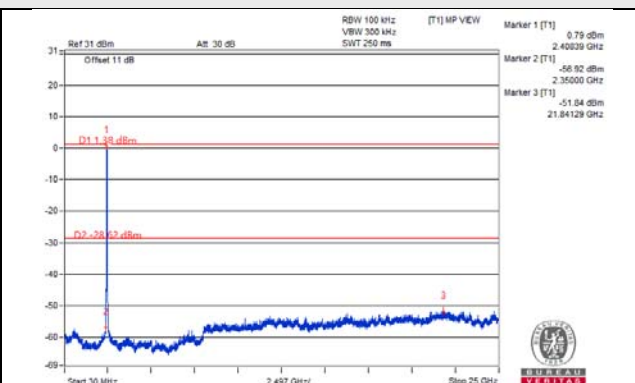
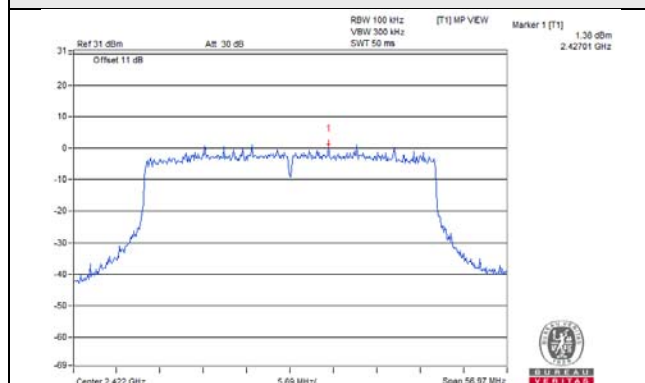

CH 6

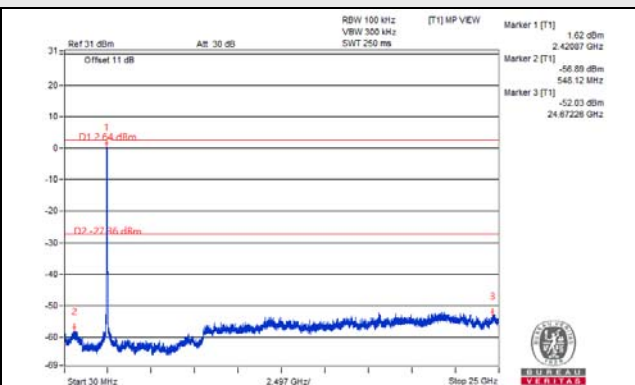
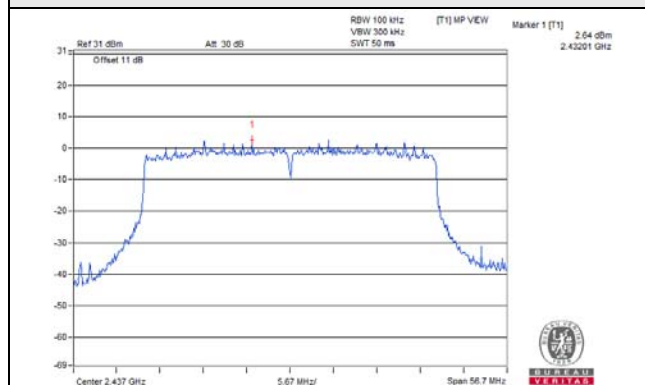

CH 9

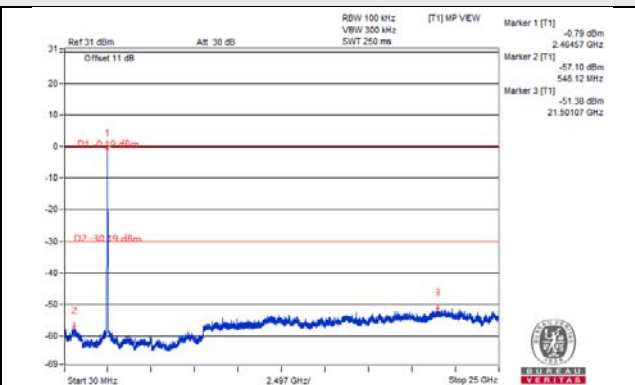
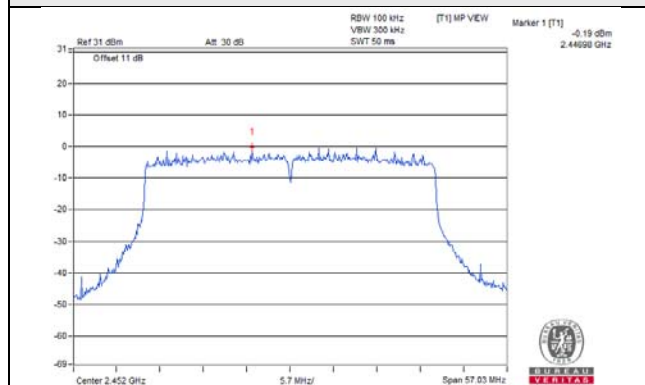

CH 3 Band edge

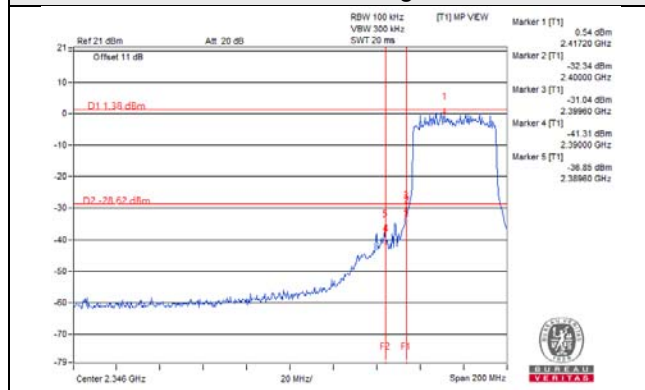

CH 9 Band edge

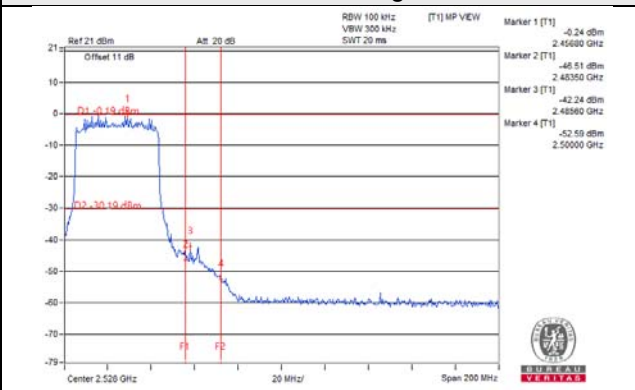

802.11ax (HE40)_Chain 1

CH 3

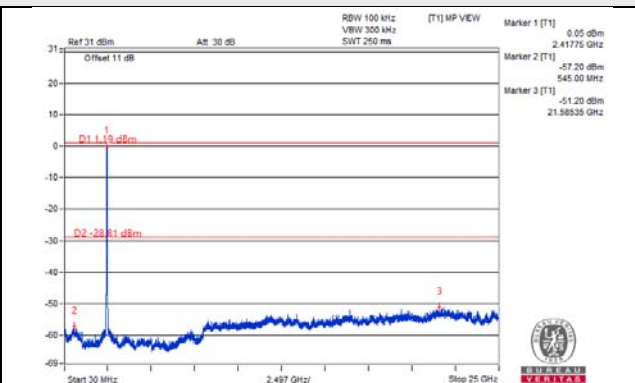
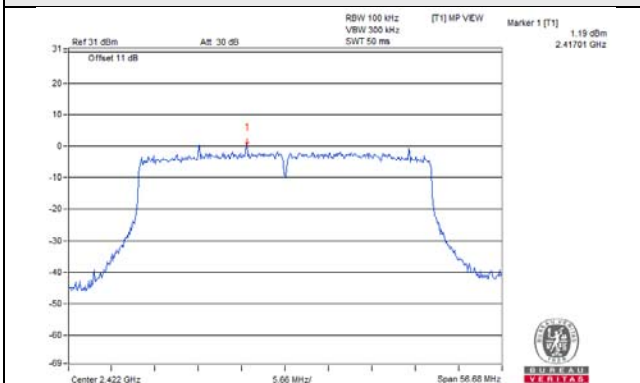

CH 6

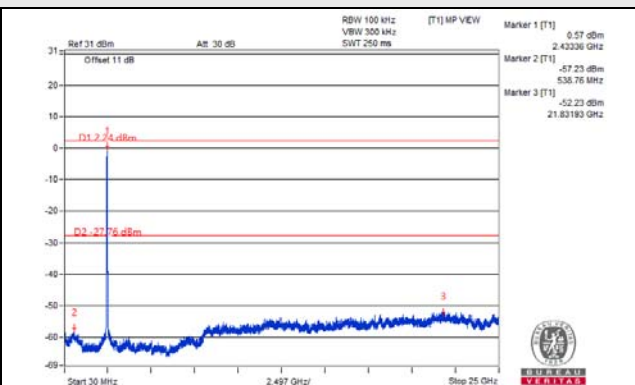
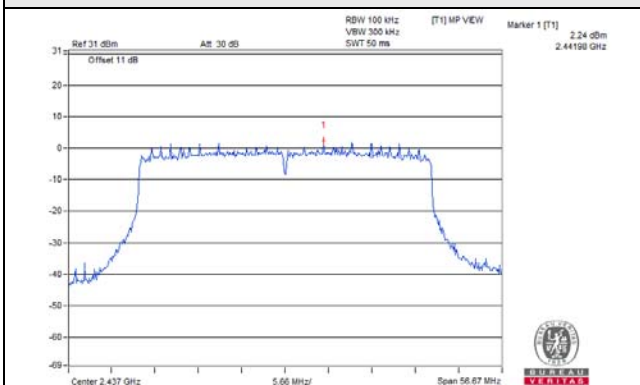

CH 9

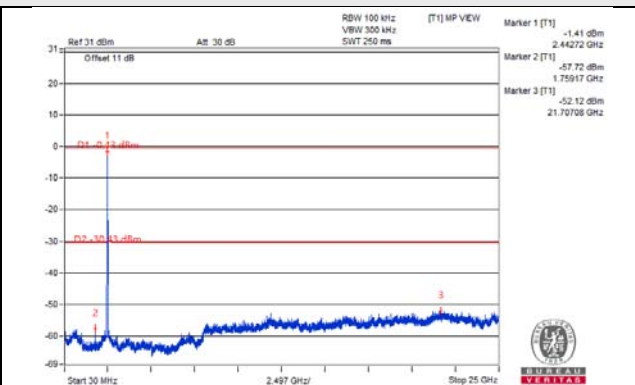
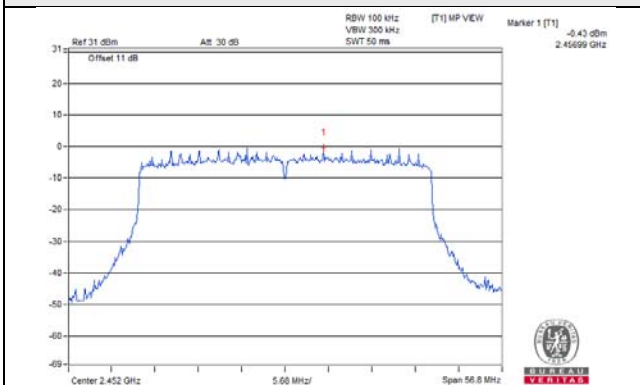

CH 3 Band edge

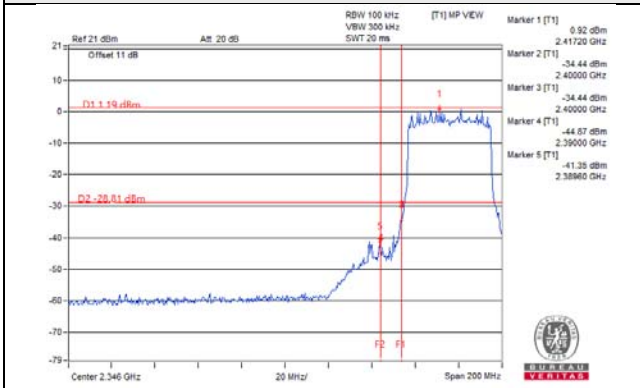

CH 9 Band edge

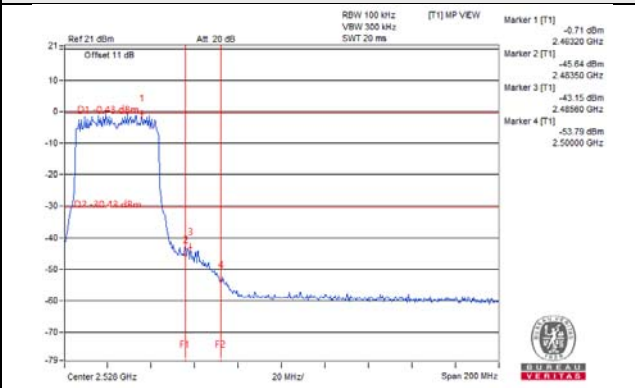

Annex A - Band Edge Measurement

802.11b

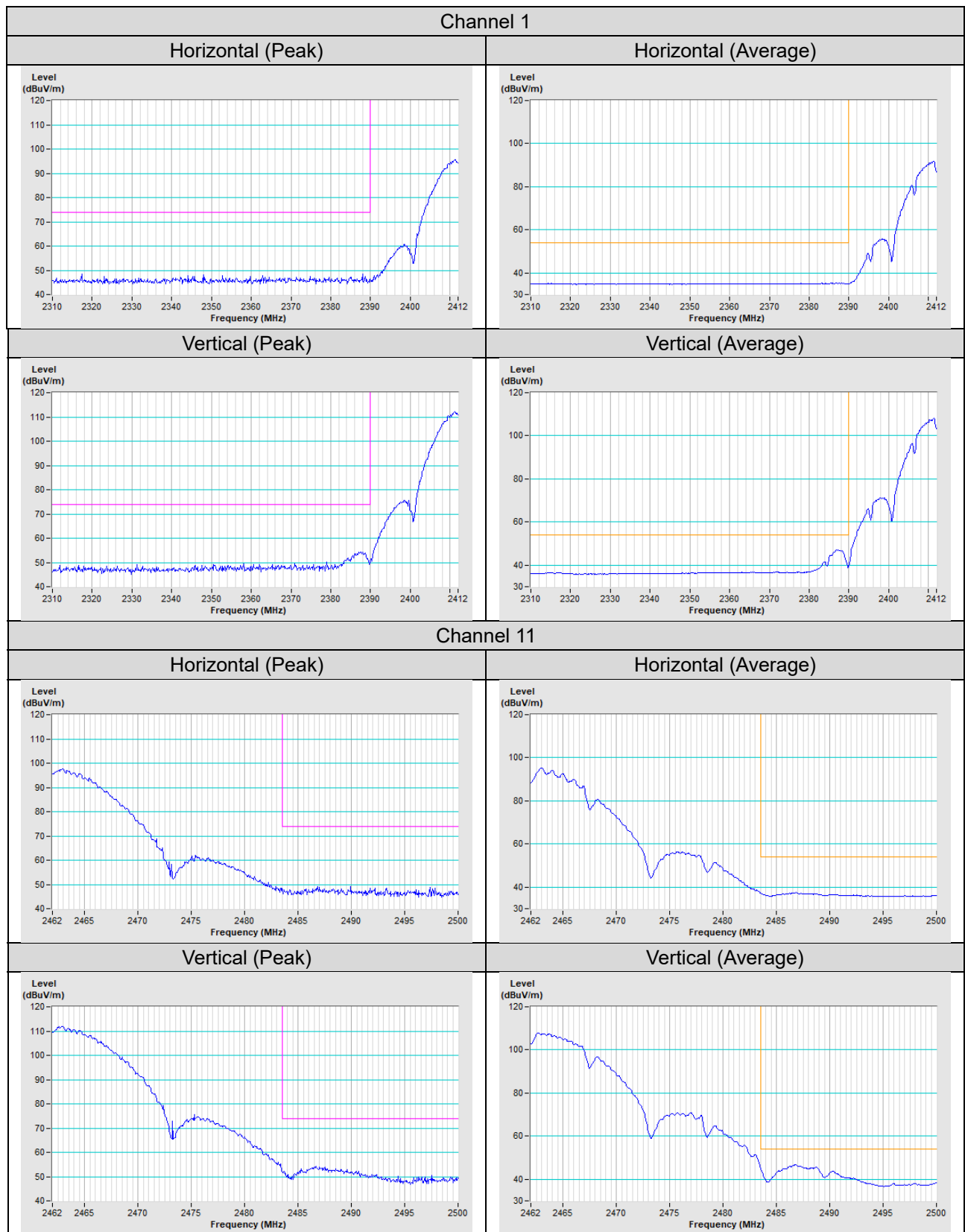

802.11g

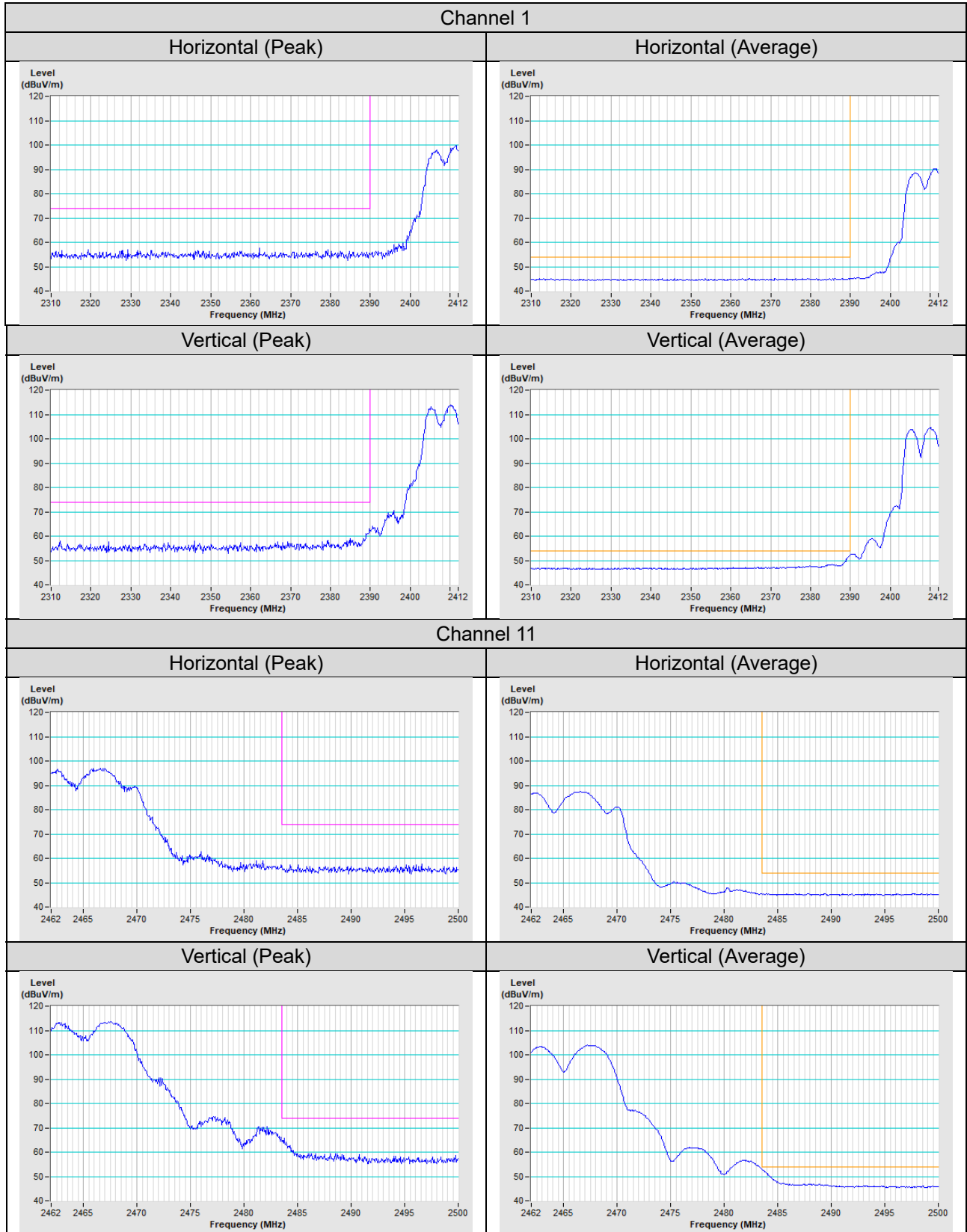

802.11ax (HE20)

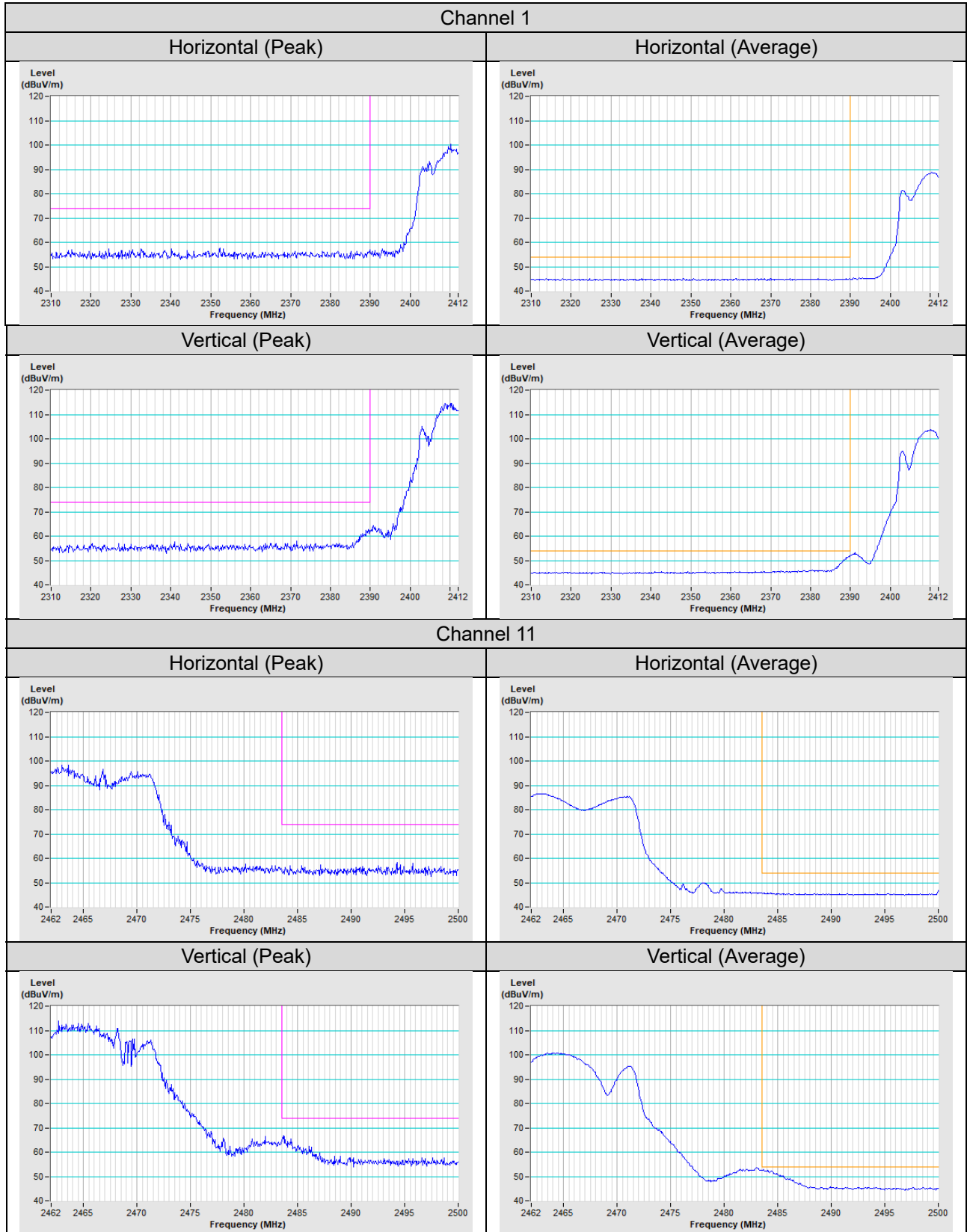

802.11ax (HE40)

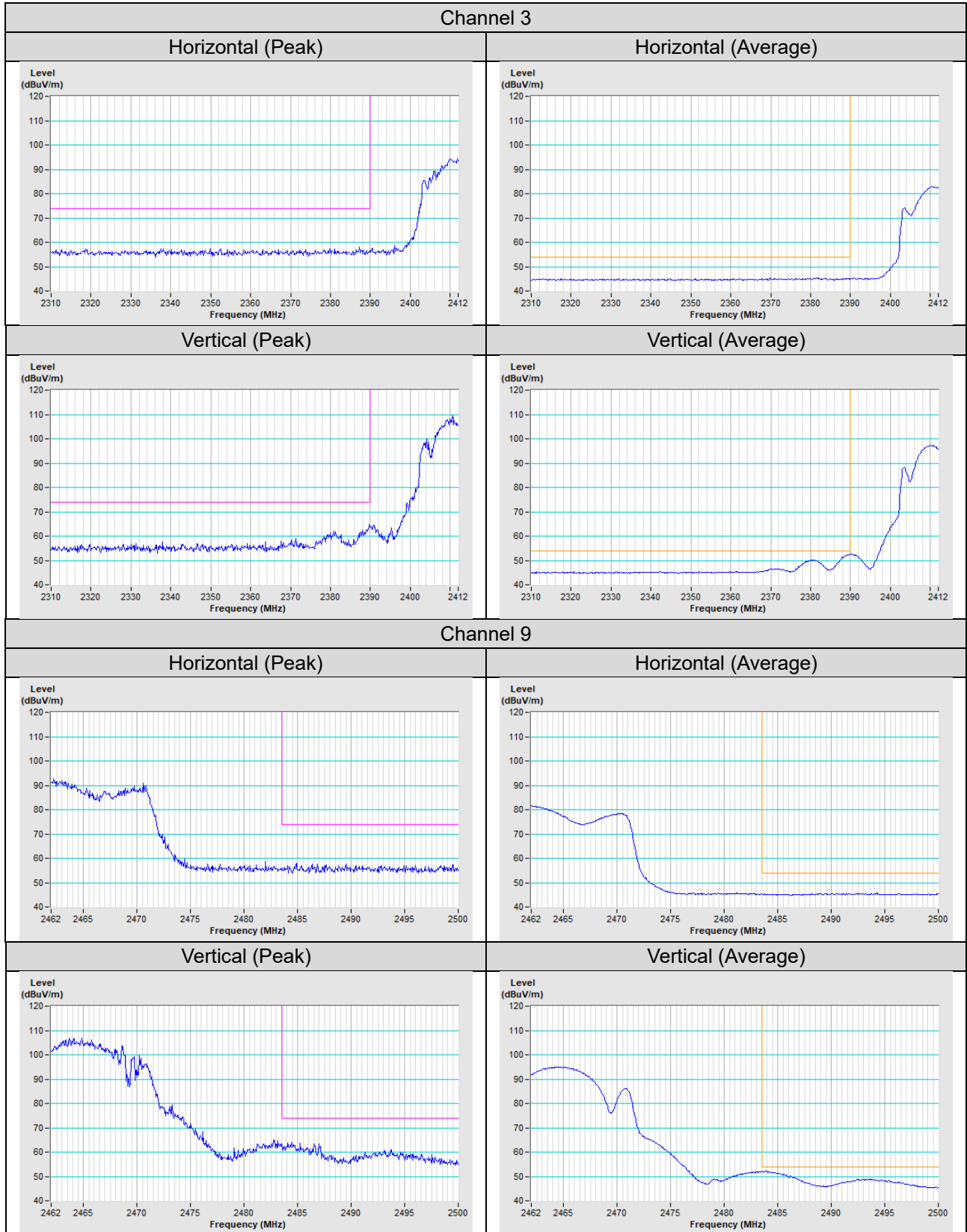

5 Pictures of Test Arrangements

Please refer to the attached file (Test Setup Photo).

Appendix – Information of the Testing Laboratories

We, Bureau Veritas Consumer Products Services (H.K.) Ltd., Taoyuan Branch, were founded in 1988 to provide our best service in EMC, Radio, Telecom and Safety consultation. Our laboratories are FCC recognized accredited test firms and accredited and approved according to ISO/IEC 17025.

If you have any comments, please feel free to contact us at the following:

Lin Kou EMC/RF Lab

Tel: 886-2-26052180

Fax: 886-2-26051924

Hsin Chu EMC/RF/Telecom Lab

Tel: 886-3-6668565

Fax: 886-3-6668323

Hwa Ya EMC/RF/Safety Lab

Tel: 886-3-3183232

Fax: 886-3-3270892

Email: service.adt@tw.bureauveritas.com

Web Site: www.bureauveritas-adt.com

The address and road map of all our labs can be found in our web site also.

--- END ---