

## FCC Test Report

**Report No.:** RF160719C17B-1

**FCC ID:** A8J-EWS550AP

**Model:** EWS550AP

**Received Date:** Jul. 19, 2016

**Test Date:** Jul. 21 ~ Aug. 23, 2016

**Issued Date:** Dec. 20, 2016

**Applicant:** EnGenius Technologies

**Address:** 1580 Scenic Avenue, Costa Mesa, CA92626

**Issued By:** Bureau Veritas Consumer Products Services (H.K.) Ltd., Taoyuan Branch

**Lab Address:** No. 47-2, 14th Ling, Chia Pau Vil., Lin Kou Dist., New Taipei City, Taiwan (R.O.C.)

**Test Location:** No.19, Hwa Ya 2nd Rd., Wen Hwa Vil., Kwei Shan Dist., Taoyuan City 33383, TAIWAN (R.O.C.)



This report is for your exclusive use. Any copying or replication of this report to or for any other person or entity, or use of our name or trademark, is permitted only with our prior written permission. This report sets forth our findings solely with respect to the test samples identified herein. The results set forth in this report are not indicative or representative of the quality or characteristics of the lot from which a test sample was taken or any similar or identical product unless specifically and expressly noted. Our report includes all of the tests requested by you and the results thereof based upon the information that you provided to us. You have 60 days from date of issuance of this report to notify us of any material error or omission caused by our negligence, provided, however, that such notice shall be in writing and shall specifically address the issue you wish to raise. A failure to raise such issue within the prescribed time shall constitute your unqualified acceptance of the completeness of this report, the tests conducted and the correctness of the report contents. Unless specific mention, the uncertainty of measurement has been explicitly taken into account to declare the compliance or non-compliance to the specification. The report must not be used by the client to claim product certification, approval, or endorsement by TAF or any government agencies.

## Table of Contents

<b>Release Control Record</b> .....	<b>4</b>
<b>1 Certificate of Conformity</b> .....	<b>5</b>
<b>2 Summary of Test Results</b> .....	<b>6</b>
2.1 Measurement Uncertainty.....	6
2.2 Modification Record.....	6
<b>3 General Information</b> .....	<b>7</b>
3.1 General Description of EUT.....	7
3.2 Description of Test Modes.....	9
3.2.1 Test Mode Applicability and Tested Channel Detail.....	10
3.3 Duty Cycle of Test Signal.....	12
3.4 Description of Support Units.....	14
3.4.1 Configuration of System under Test.....	14
3.5 General Description of Applied Standards.....	15
<b>4 Test Types and Results</b> .....	<b>16</b>
4.1 Radiated Emission and Bandedge Measurement.....	16
4.1.1 Limits of Radiated Emission and Bandedge Measurement.....	16
4.1.2 Test Instruments.....	17
4.1.3 Test Procedures.....	18
4.1.4 Deviation from Test Standard.....	18
4.1.5 Test Set Up.....	19
4.1.6 EUT Operating Conditions.....	20
4.1.7 Test Results.....	21
4.2 Conducted Emission Measurement.....	52
4.2.1 Limits of Conducted Emission Measurement.....	52
4.2.2 Test Instruments.....	52
4.2.3 Test Procedures.....	53
4.2.4 Deviation from Test Standard.....	53
4.2.5 Test Setup.....	53
4.2.6 EUT Operating Conditions.....	53
4.2.7 Test Results.....	54
4.3 Transmit Power Measurement.....	56
4.3.1 Limits of Transmit Power Measurement.....	56
4.3.2 Test Setup.....	56
4.3.3 Test Instruments.....	56
4.3.4 Test Procedure.....	57
4.3.5 Deviation from Test Standard.....	57
4.3.6 EUT Operating Conditions.....	57
4.3.7 Test Result.....	58
4.4 Occupied Bandwidth Measurement.....	64
4.4.1 Test Setup.....	64
4.4.2 Test Instruments.....	64
4.4.3 Test Procedure.....	64
4.4.4 Test Result.....	65
4.5 Peak Power Spectral Density Measurement.....	69
4.5.1 Limits of Peak Power Spectral Density Measurement.....	69
4.5.2 Test Setup.....	69
4.5.3 Test Instruments.....	69
4.5.4 Test Procedures.....	70
4.5.5 Deviation from Test Standard.....	70
4.5.6 EUT Operating Conditions.....	70
4.5.7 Test Results.....	71
4.6 Frequency Stability.....	79
4.6.1 Limits of Frequency Stability Measurement.....	79

4.6.2	Test Setup.....	79
4.6.3	Test Procedure .....	79
4.6.4	Deviation from Test Standard .....	79
4.6.5	EUT Operating Condition .....	79
4.6.6	Test Results .....	80
4.7	6dB Bandwidth Measurement.....	81
4.7.1	Limits of 6dB Bandwidth Measurement.....	81
4.7.2	Test Setup.....	81
4.7.3	Test Instruments .....	81
4.7.4	Test Procedure .....	81
4.7.5	Deviation from Test Standard .....	81
4.7.6	EUT Operating Condition .....	81
4.7.7	Test Results .....	82
<b>5</b>	<b>Pictures of Test Arrangements.....</b>	<b>86</b>
	<b>Annex A- Radiated Out of Band Emission (OOBE) Measurement (For U-NII-3 band).....</b>	<b>87</b>
	<b>Appendix – Information on the Testing Laboratories .....</b>	<b>92</b>

### Release Control Record

Issue No.	Description	Date Issued
RF160719C17B-1	Original release	Dec. 20, 2016

## 1 Certificate of Conformity

**Product:** Wireless AC1300 Managed Wall Plate Access Point

**Brand:** EnGenius

**Model:** EWS550AP

**Sample Status:** Engineering sample

**Applicant:** EnGenius Technologies

**Test Date:** Jul. 21 ~ Aug. 23, 2016

**Standards:** 47 CFR FCC Part 15, Subpart E (Section 15.407)  
ANSI C63.10:2013

The above equipment has been tested by **Bureau Veritas Consumer Products Services (H.K.) Ltd., Taoyuan Branch**, and found compliance with the requirement of the above standards. The test record, data evaluation & Equipment Under Test (EUT) configurations represented herein are true and accurate accounts of the measurements of the sample's EMC characteristics under the conditions specified in this report.

**Prepared by :**  , **Date:** Dec. 20, 2016  
Pettie Chen / Senior Specialist

**Approved by :**  , **Date:** Dec. 20, 2016  
Ken Liu / Senior Manager

## 2 Summary of Test Results

47 CFR FCC Part 15, Subpart E (Section 15.407)			
FCC Clause	Test Item	Result	Remarks
15.407(b)(6)	AC Power Conducted Emissions	Pass	Meet the requirement of limit. Minimum passing margin is -9.76dB at 0.40000MHz
15.407(b) (1/2/3/4(i/ii)/6)	Radiated Emissions & Band Edge Measurement	Pass	Meet the requirement of limit. Minimum passing margin is -1.3dB at 5150.00MHz
15.407(a)(1/2/3)	Max Average Transmit Power	Pass	Meet the requirement of limit.
---	Occupied Bandwidth Measurement	-	Reference only.
15.407(a)(1/2/3)	Peak Power Spectral Density	Pass	Meet the requirement of limit.
15.407(e)	6dB bandwidth	Pass	Meet the requirement of limit. (U-NII-3 Band only)
15.407(g)	Frequency Stability	Pass	Meet the requirement of limit.
15.203	Antenna Requirement	Pass	Antenna connector is IPEX not a standard connector.

\*For U-NII-3 band compliance with rule part 15.407(b)(4)(i), the OOB test plots were recorded in Annex A.

### 2.1 Measurement Uncertainty

Where relevant, the following measurement uncertainty levels have been estimated for tests performed on the EUT as specified in CISPR 16-4-2:

Measurement	Frequency	Expanded Uncertainty (k=2) ( $\pm$ )
Conducted Emissions at mains ports	150kHz ~ 30MHz	2.44 dB
Radiated Emissions up to 1 GHz	30MHz ~ 200MHz	3.86 dB
	200MHz ~ 1000MHz	3.87 dB
Radiated Emissions above 1 GHz	1GHz ~ 18GHz	2.29 dB
	18GHz ~ 40GHz	2.29 dB

### 2.2 Modification Record

There were no modifications required for compliance.

### 3 General Information

#### 3.1 General Description of EUT

Product	Wireless AC1300 Managed Wall Plate Access Point
Brand	EnGenius
Model	EWS550AP
Status of EUT	Engineering sample
Power Supply Rating	48Vdc or 54Vdc or 55Vdc (POE)
Modulation Type	256QAM, 64QAM, 16QAM, QPSK, BPSK for OFDM
Modulation Technology	OFDM
Transfer Rate	802.11a: 54.0/ 48.0/ 36.0/ 24.0/ 18.0/ 12.0/ 9.0/ 6.0Mbps 802.11n: up to 300Mbps 802.11ac: up to 867Mbps
Operating Frequency	5180 ~ 5240MHz, 5745 ~ 5825MHz
Number of Channel	5180 ~ 5240MHz: 4 for 802.11a, 802.11n (HT20), 802.11ac (VHT20) 2 for 802.11n (HT40), 802.11ac (VHT40) 1 for 802.11ac (VHT80) 5745 ~ 5825MHz: 5 for 802.11a, 802.11n (HT20), 802.11ac (VHT20) 2 for 802.11n (HT40), 802.11ac (VHT40) 1 for 802.11ac (VHT80)
Output Power	CDD Mode 5180 ~ 5240MHz: 201.915mW 5745 ~ 5825MHz: 195.961mW Beamforming Mode 5180 ~ 5240MHz: 193.223mW 5745 ~ 5825MHz: 205.196mW
Antenna Type	Refer to note
Antenna Connector	Refer to note
Accessory Device	NA
Data Cable Supplied	NA

**Note:**

- The EUT incorporates a MIMO function. Physically, the EUT provides 2 completed transmitters and 2 receivers.

Modulation Mode	TX Function	Beamforming
802.11a	2TX	Not Support
802.11n (HT20)	2TX	Support
802.11n (HT40)	2TX	Support
802.11ac (VHT20)	2TX	Support
802.11ac (VHT40)	2TX	Support
802.11ac (VHT80)	2TX	Support

\*The modulation and bandwidth are similar for 802.11n mode for HT20/HT40 and 802.11ac mode for VHT20/VHT40, therefore investigated worst case to representative mode in test report. (Final test mode refer section 3.2.1)

\* For 5GHz band, CDD mode is the worst case for final radiated emission below 1GHz and power line conducted emission tests after pretesting CDD mode and beamforming mode.

- The EUT with follow antennas gain is listed as table below.

Ant. No.	1	2	3	4	BT / Zigbee
Ant. Type	PIFA				
Frequency (MHz)	2400-2500		5150-5850		2400-2500
Gain (dBi)	3.67	4.31	5.72	5.99	3.51
Connector	IPEX				

- The EUT consumes power from the following POE. (Support unit only)

POE	
Brand	SENAO
Model	EPA5006GP
Input Power	100-240Vac, 0.8A, 50-60Hz
Output Power	54Vdc, 0.6A
Power Line	0.5m non-shielded Power cable without core

- 2.4GHz, 5GHz, BT LE or Zigbee technology can transmit at same time.

- The power setting are list as below:

CDD Mode						
	802.11a	802.11n (HT20)		802.11n (HT40)		802.11ac (VHT80)
CH 36	20	19.5	CH 38	17	CH 42	16.5
CH 40	20	20	CH 46	20	CH 155	19
CH 48	20	20	CH 151	20		
CH 149	20	20	CH 159	20		
CH 157	20	20				
CH 165	20	20				
Beamforming Mode						
	802.11n (HT20)		802.11n (HT40)		802.11ac (VHT80)	
CH 36	19	CH 38	16	CH 42	16	
CH 40	20	CH 46	20	CH 155	19	
CH 48	20	CH 151	20			
CH 149	20	CH 159	20			
CH 157	20					
CH 165	20					



### 3.2 Description of Test Modes

#### For 5180 ~ 5240MHz

4 channels are provided for 802.11a, 802.11n (HT20), 802.11ac (VHT20):

Channel	Frequency	Channel	Frequency
36	5180 MHz	44	5220 MHz
40	5200 MHz	48	5240 MHz

2 channels are provided for 802.11n (HT40), 802.11ac (VHT40):

Channel	Frequency	Channel	Frequency
38	5190 MHz	46	5230 MHz

1 channel is provided for 802.11ac (VHT80):

Channel	Frequency
42	5210MHz

#### For 5745 ~ 5825MHz:

5 channels are provided for 802.11a, 802.11n (HT20), 802.11ac (VHT20):

Channel	Frequency	Channel	Frequency
149	5745MHz	161	5805MHz
153	5765MHz	165	5825MHz
157	5785MHz		

2 channels are provided for 802.11n (HT40), 802.11ac (VHT40):

Channel	Frequency	Channel	Frequency
151	5755MHz	159	5795MHz

1 channel is provided for 802.11ac (VHT80):

Channel	Frequency
155	5775MHz

### 3.2.1 Test Mode Applicability and Tested Channel Detail

EUT CONFIGURE MODE	APPLICABLE TO				DESCRIPTION
	RE $\geq$ 1G	RE<1G	PLC	APCM	
-	√	√	√	√	-

Where **RE $\geq$ 1G**: Radiated Emission above 1GHz & Bandedge Measurement  
**RE<1G**: Radiated Emission below 1GHz  
**PLC**: Power Line Conducted Emission  
**APCM**: Antenna Port Conducted Measurement

Note: The EUT had been pre-tested on the positioned of each 3 axis. The worst case was found when positioned on **Z-plane**.

#### Radiated Emission Test (Above 1GHz):

- Pre-Scan has been conducted to determine the worst-case mode from all possible combinations between available modulations, data rates and antenna ports (if EUT with antenna diversity architecture).
- Following channel(s) was (were) selected for the final test as listed below.

EUT CONFIGURE MODE	MODE	FREQ. BAND (MHz)	AVAILABLE CHANNEL	TESTED CHANNEL	MODULATION TECHNOLOGY	MODULATION TYPE	DATA RATE (Mbps)
-	802.11a	5180-5240	36 to 48	36, 40, 48	OFDM	BPSK	6.0
-	802.11n (HT20)		36 to 48	36, 40, 48	OFDM	BPSK	6.5
-	802.11n (HT40)		38 to 46	38, 46	OFDM	BPSK	13.5
-	802.11ac (VHT80)		42	42	OFDM	BPSK	58.5
-	802.11a	5745-5825	149 to 165	149, 157, 165	OFDM	BPSK	6.0
-	802.11n (HT20)		149 to 165	149, 157, 165	OFDM	BPSK	6.5
-	802.11n (HT40)		151 to 159	151, 159	OFDM	BPSK	13.5
-	802.11ac (VHT80)		155	155	OFDM	BPSK	58.5

#### Radiated Emission Test (Below 1GHz):

- Pre-Scan has been conducted to determine the worst-case mode from all possible combinations between available modulations, data rates and antenna ports (if EUT with antenna diversity architecture).
- Following channel(s) was (were) selected for the final test as listed below.

EUT CONFIGURE MODE	MODE	FREQ. BAND (MHz)	AVAILABLE CHANNEL	TESTED CHANNEL	MODULATION TECHNOLOGY	MODULATION TYPE	DATA RATE (Mbps)
-	802.11a	5180-5240	36 to 48	36	OFDM	BPSK	6.0
	802.11a	5745-5825	149 to 165		OFDM	BPSK	6.0

### Power Line Conducted Emission Test:

- Pre-Scan has been conducted to determine the worst-case mode from all possible combinations between available modulations, data rates and antenna ports (if EUT with antenna diversity architecture).
- Following channel(s) was (were) selected for the final test as listed below.

EUT CONFIGURE MODE	MODE	FREQ. BAND (MHz)	AVAILABLE CHANNEL	TESTED CHANNEL	MODULATION TECHNOLOGY	MODULATION TYPE	DATA RATE (Mbps)
-	802.11a	5180-5240	36 to 48	36	OFDM	BPSK	6.0
	802.11a	5745-5825	149 to 165		OFDM	BPSK	6.0

### Antenna Port Conducted Measurement:

- This item includes all test value of each mode, but only includes spectrum plot of worst value of each mode.
- Pre-Scan has been conducted to determine the worst-case mode from all possible combinations between available modulations, data rates and antenna ports (if EUT with antenna diversity architecture).
- Following channel(s) was (were) selected for the final test as listed below.

EUT CONFIGURE MODE	MODE	FREQ. BAND (MHz)	AVAILABLE CHANNEL	TESTED CHANNEL	MODULATION TECHNOLOGY	MODULATION TYPE	DATA RATE (Mbps)
-	802.11a	5180-5240	36 to 48	36, 40, 48	OFDM	BPSK	6.0
-	802.11n (HT20)		36 to 48	36, 40, 48	OFDM	BPSK	6.5
-	802.11n (HT40)		38 to 46	38, 46	OFDM	BPSK	13.5
-	802.11ac (VHT80)		42	42	OFDM	BPSK	58.5
-	802.11a	5745-5825	149 to 165	149, 157, 165	OFDM	BPSK	6.0
-	802.11n (HT20)		149 to 165	149, 157, 165	OFDM	BPSK	6.5
-	802.11n (HT40)		151 to 159	151, 159	OFDM	BPSK	13.5
-	802.11ac (VHT80)		155	155	OFDM	BPSK	58.5

### Test Condition:

APPLICABLE TO	ENVIRONMENTAL CONDITIONS	INPUT POWER (POE)	TESTED BY
RE $\geq$ 1G	19deg. C, 70%RH	54Vdc	Jones Chang
RE<1G	19deg. C, 70%RH	54Vdc	Jones Chang
PLC	20deg. C, 70%RH	54Vdc	Jones Chang
APCM	25deg. C, 60%RH	54Vdc	Antony Lee

### 3.3 Duty Cycle of Test Signal

#### CDD Mode

Duty cycle of test signal is > 98%, duty factor is not required.

Duty cycle of test signal is < 98 %, duty factor is required.

802.11a: Duty cycle =  $2.007/2.119 = 0.947$ , Duty factor =  $10 * \log(1/0.947) = 0.24$

802.11n (HT20): Duty cycle =  $4.940/5.042 = 0.980$

802.11n (HT40): Duty cycle =  $2.395/2.493 = 0.961$ , Duty factor =  $10 * \log(1/0.961) = 0.17$

802.11ac (VHT80): Duty cycle =  $1.127/1.227 = 0.919$ , Duty factor =  $10 * \log(1/0.919) = 0.37$

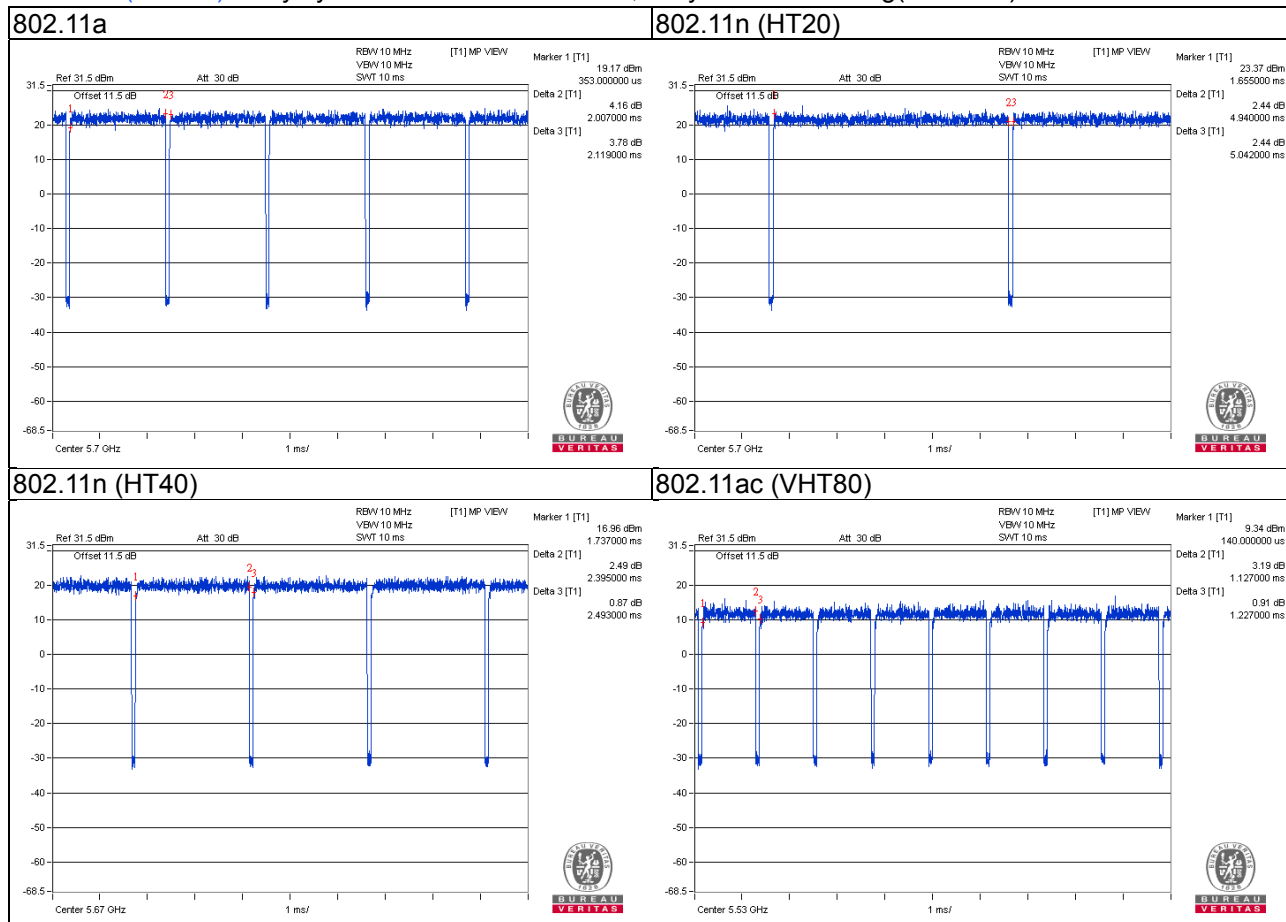

### Beamforming Mode

802.11n (HT20): Duty cycle of test signal is > 98 %, duty factor is not required.

802.11n (HT40), 802.11ac (VHT80): Duty cycle of test signal is < 98 %, duty factor is required.

802.11n (HT20): Duty cycle =  $4.990/5.085 = 0.981$

802.11n (HT40): Duty cycle =  $2.420/2.513 = 0.963$ , Duty factor =  $10 * \log( 1/ 0.963 ) = 0.16$

802.11ac (VHT80): Duty cycle =  $1.134/1.239 = 0.915$ , Duty factor =  $10 * \log( 1/ 0.915 ) = 0.38$

802.11ac (VHT20)

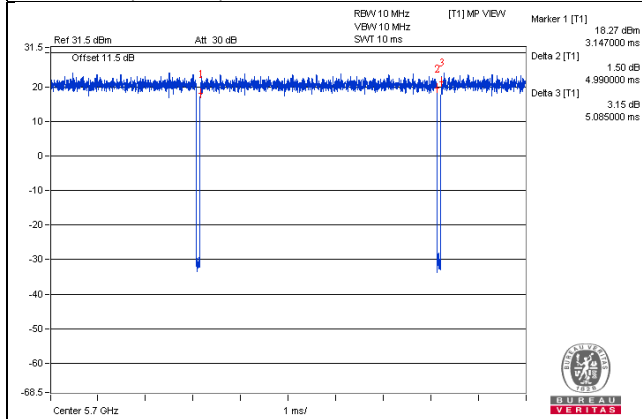

802.11ac (VHT40)

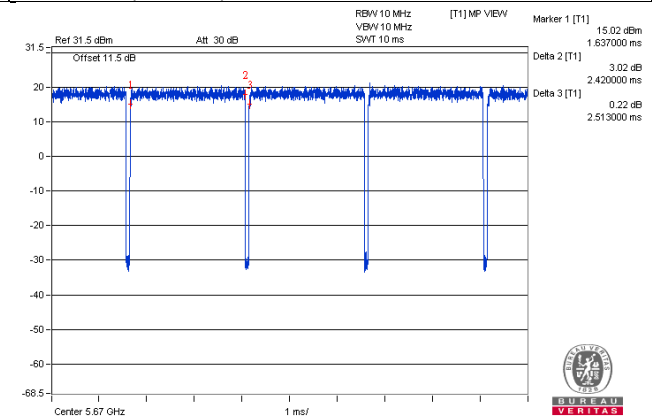

802.11ac (VHT80)

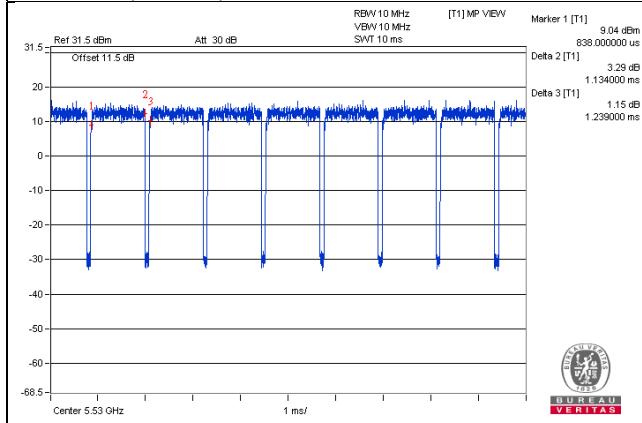

### 3.4 Description of Support Units

The EUT has been tested as an independent unit together with other necessary accessories or support units. The following support units or accessories were used to form a representative test configuration during the tests.

ID	Product	Brand	Model No.	Serial No.	FCC ID	Remarks
A.	Notebook	DELL	E5410	1HC2XM1	FCC DoC Approved	-
B.	POE	SENAO	EPA5006GP	N/A	N/A	Provided by manufacturer
C.	Load	N/A	N/A	N/A	N/A	-

Note:

1. All power cords of the above support units are non-shielded (1.8m).
2. Item A acted as communication partner to transfer data.

ID	Descriptions	Qty.	Length (m)	Shielding (Yes/No)	Cores (Qty.)	Remarks
1.	RJ45 Cable	4	1.8	N	0	Cat5e
2.	RJ45 Cable	1	3	N	0	Cat5e
3.	RJ45 Cable	1	3	N	0	Cat5e

#### 3.4.1 Configuration of System under Test

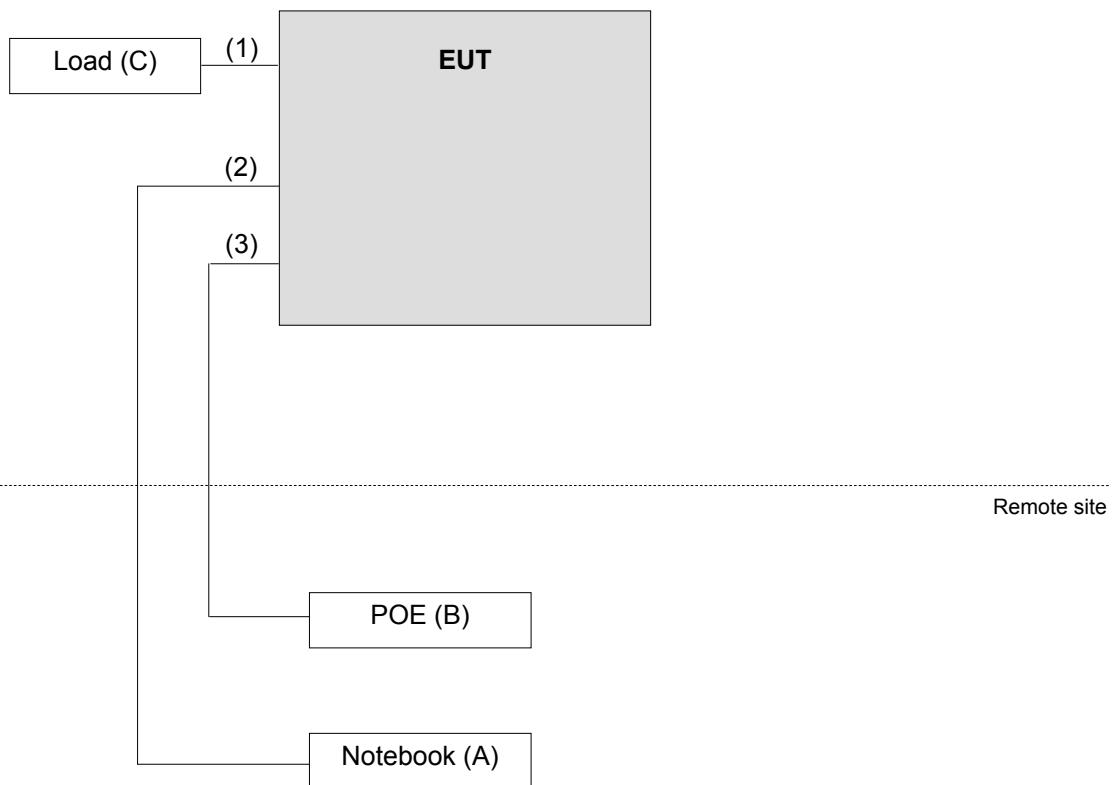

### 3.5 General Description of Applied Standards

The EUT is a RF Product. According to the specifications of the manufacturer, it must comply with the requirements of the following standards:

**FCC Part 15, Subpart E (15.407)**

**KDB 789033 D02 General UNII Test Procedure New Rules v01r03**

**KDB 662911 D01 Multiple Transmitter Output v02r01**

ANSI C63.10-2013

All test items have been performed and recorded as per the above standards.

Note: The EUT is also considered as a kind of computer peripheral, because the connection to computer is necessary for typical use. It has been verified to comply with the requirements of FCC Part 15, Subpart B, Class B (DoC). The test report has been issued separately.

## 4 Test Types and Results

### 4.1 Radiated Emission and Bandedge Measurement

#### 4.1.1 Limits of Radiated Emission and Bandedge Measurement

Radiated emissions which fall in the restricted bands must comply with the radiated emission limits specified as below table.

Frequencies (MHz)	Field Strength (microvolts/meter)	Measurement Distance (meters)
0.009 ~ 0.490	2400/F(kHz)	300
0.490 ~ 1.705	24000/F(kHz)	30
1.705 ~ 30.0	30	30
30 ~ 88	100	3
88 ~ 216	150	3
216 ~ 960	200	3
Above 960	500	3

#### NOTE:

- The lower limit shall apply at the transition frequencies.
- Emission level (dBuV/m) = 20 log Emission level (uV/m).
- For frequencies above 1000MHz, the field strength limits are based on average detector, however, the peak field strength of any emission shall not exceed the maximum permitted average limits, specified above by more than 20dB under any condition of modulation.

Limits of unwanted emission out of the restricted bands

Applicable To		Limit	
789033 D02 General UNII Test Procedure New Rules v01r03		Field Strength at 3m	
		PK:74 (dBuV/m)	AV:54 (dBuV/m)
Frequency Band	Applicable To	EIRP Limit	Equivalent Field Strength at 3m
5150~5250 MHz	15.407(b)(1)	PK:-27 (dBm/MHz)	PK:68.2(dBuV/m)
5250~5350 MHz	15.407(b)(2)		
5470~5725 MHz	15.407(b)(3)		
5725~5850 MHz	<input checked="" type="checkbox"/> 15.407(b)(4)(i)	PK:-27 (dBm/MHz) <sup>*1</sup> PK:10 (dBm/MHz) <sup>*2</sup> PK:15.6 (dBm/MHz) <sup>*3</sup> PK:27 (dBm/MHz) <sup>*4</sup>	PK: 68.2(dBuV/m) <sup>*1</sup> PK:105.2 (dBuV/m) <sup>*2</sup> PK: 110.8(dBuV/m) <sup>*3</sup> PK:122.2 (dBuV/m) <sup>*4</sup>
	<input type="checkbox"/> 15.407(b)(4)(ii)	Emission limits in section 15.247(d)	
<sup>*1</sup> beyond 75 MHz or more above of the band edge. <sup>*3</sup> below the band edge increasing linearly to a level of 15.6 dBm/MHz at 5 MHz above.		<sup>*2</sup> below the band edge increasing linearly to 10 dBm/MHz at 25 MHz above. <sup>*4</sup> from 5 MHz above or below the band edge increasing linearly to a level of 27 dBm/MHz at the band edge.	

**Note:** The following formula is used to convert the equipment isotropic radiated power (eirp) to field strength:

$$E = \frac{1000000\sqrt{30P}}{3} \mu\text{V/m, where P is the eirp (Watts).}$$



#### 4.1.2 Test Instruments

Description & Manufacturer	Model No.	Serial No.	Cal. Date	Cal. Due
Test Receiver ROHDE & SCHWARZ	ESIB7	100187	Apr. 18, 2016	Apr. 17, 2017
Spectrum Analyzer ROHDE & SCHWARZ	FSP40	100041	Sep. 02, 2015	Sep. 01, 2016
BILOG Antenna SCHWARZBECK	VULB9168	9168-171	Jan. 07, 2016	Jan. 06, 2017
HORN Antenna SCHWARZBECK	9120D	209	Jan. 20, 2016	Jan. 19, 2017
HORN Antenna SCHWARZBECK	BBHA 9170	BBHA9170241	Jan. 18, 2016	Jan. 17, 2017
Preamplifier Agilent	8447D	2944A10738	Oct. 18, 2015	Oct. 17, 2016
Preamplifier Agilent	8449B	3008A01964	Aug. 22, 2015	Aug. 21, 2016
			Aug. 22, 2016	Aug. 21, 2017
RF signal cable HUBER+SUHNER	SUCOFLEX 104	Cable-CH3-03 (214378)	Aug. 22, 2015	Aug. 21, 2016
			Aug. 22, 2016	Aug. 21, 2017
RF signal cable HUBER+SUHNER	SUCOFLEX 106	Cable-CH3-03 (309224+12738)	Aug. 22, 2015	Aug. 21, 2016
			Aug. 22, 2016	Aug. 21, 2017
Software BV ADT	ADT_Radiated_ V7.6.15.9.4	NA	NA	NA
Antenna Tower inn-co GmbH	MA 4000	013303	NA	NA
Antenna Tower Controller BV ADT	AT100	AT93021702	NA	NA
Turn Table BV ADT	TT100	TT93021702	NA	NA
Turn Table Controller BV ADT	SC100	SC93021702	NA	NA
26GHz ~ 40GHz Amplifier	EM26400	815221	Oct. 18, 2015	Oct. 17, 2016
High Speed Peak Power Meter	ML2495A	0824011	Jul. 09, 2016	Jul. 08, 2017
Power Sensor	MA2411B	0738171	Jul. 09, 2016	Jul. 08, 2017
WIT Standard Temperature And Humidity Chamber	TH-4S-C	W981030	Jun. 08, 2016	Jun. 07, 2017

- Note:
1. The calibration interval of the above test instruments is 12 months and the calibrations are traceable to NML/ROC and NIST/USA.
  2. The test was performed in HwaYa Chamber 3.
  3. The horn antenna and preamplifier (model: 8449B) are used only for the measurement of emission frequency above 1GHz if tested.
  4. The FCC Site Registration No. is 988962.
  5. The IC Site Registration No. is IC 7450F-3.

### 4.1.3 Test Procedures

#### For Radiated emission below 30MHz

- a. The EUT was placed on the top of a rotating table 0.8 meters above the ground at a 3 meter chamber room. The table was rotated 360 degrees to determine the position of the highest radiation.
- b. The EUT was set 3 meters away from the interference-receiving antenna, which was mounted on the top of a variable-height antenna tower.
- c. Both X and Y axes of the antenna are set to make the measurement.
- d. For each suspected emission, the EUT was arranged to its worst case and the rotatable table was turned from 0 degrees to 360 degrees to find the maximum reading.
- e. The test-receiver system was set to Quasi-Peak Detect Function and Specified Bandwidth with Maximum Hold Mode.

#### NOTE:

1. The resolution bandwidth and video bandwidth of test receiver/spectrum analyzer is 9kHz at frequency below 30MHz.

#### For Radiated emission above 30MHz

- a. The EUT was placed on the top of a rotating table 0.8 meters (for 30MHz ~ 1GHz) / 1.5 meters (for above 1GHz) above the ground at 3 meter chamber room for test. The table was rotated 360 degrees to determine the position of the highest radiation.
- b. The EUT was set 3 meters away from the interference-receiving antenna, which was mounted on the top of a variable-height antenna tower.
- c. The height of antenna is varied from one meter to four meters above the ground to determine the maximum value of the field strength. Both horizontal and vertical polarizations of the antenna are set to make the measurement.
- d. For each suspected emission, the EUT was arranged to its worst case and then the antenna was tuned to heights from 1 meter to 4 meters and the rotatable table was turned from 0 degrees to 360 degrees to find the maximum reading.
- e. The test-receiver system was set to quasi-peak detect function and specified bandwidth with maximum hold mode when the test frequency is below 1 GHz.
- f. The test-receiver system was set to peak and average detect function and specified bandwidth with maximum hold mode when the test frequency is above 1 GHz. If the peak reading value also meets average limit, measurement with the average detector is unnecessary.

#### Note:

1. The resolution bandwidth and video bandwidth of test receiver/spectrum analyzer is 120kHz for Quasi-peak detection (QP) at frequency below 1GHz.
2. The resolution bandwidth of test receiver/spectrum analyzer is 1 MHz and the video bandwidth is 3 MHz for Peak detection (PK) at frequency above 1GHz.
3. The resolution bandwidth of test receiver/spectrum analyzer is 1MHz and the video bandwidth is  $\geq 1/T$  (Duty cycle < 98%) or 10Hz (Duty cycle  $\geq 98\%$ ) for Average detection (AV) at frequency above 1GHz.
4. All modes of operation were investigated and the worst-case emissions are reported.

### 4.1.4 Deviation from Test Standard

No deviation.

#### 4.1.5 Test Set Up

##### For Radiated emission below 30MHz

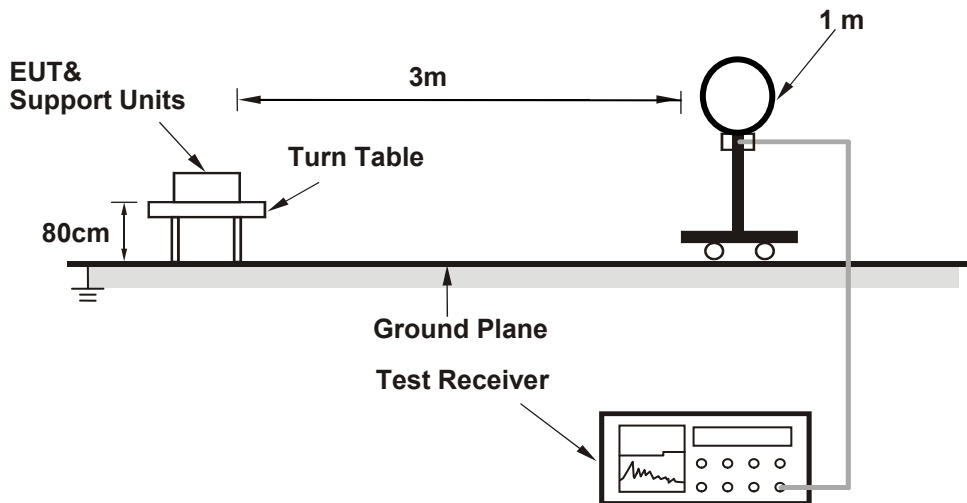

##### For Radiated emission 30MHz to 1GHz

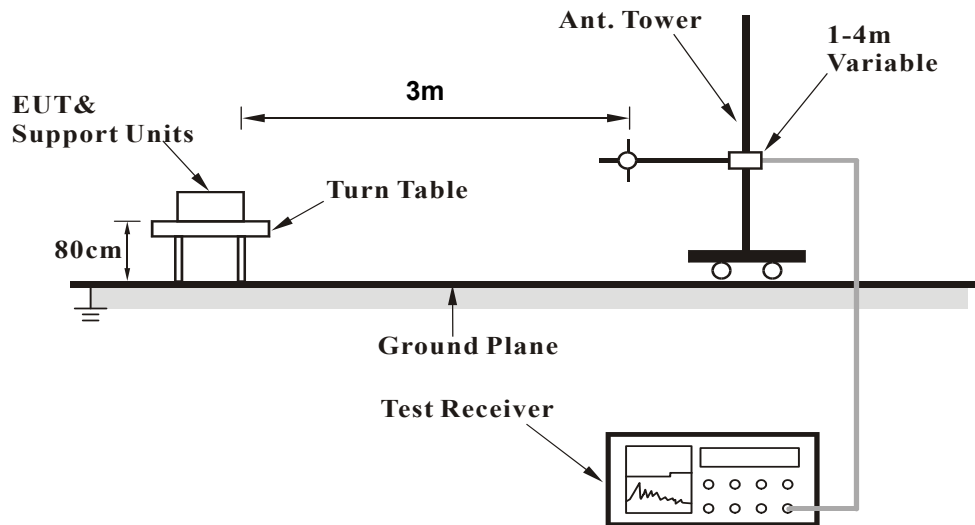

**For Radiated emission above 1GHz**

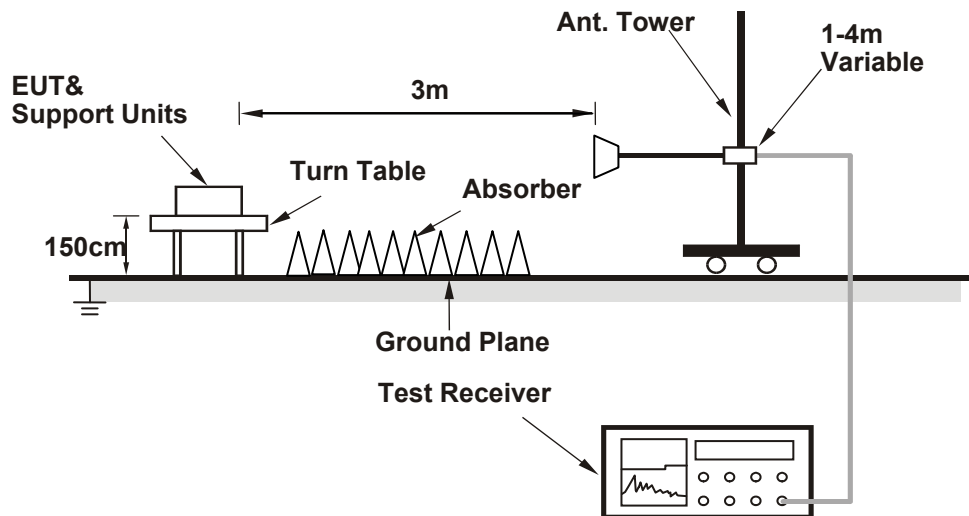

For the actual test configuration, please refer to the attached file (Test Setup Photo).

**4.1.6 EUT Operating Conditions**

- a. Placed the EUT on the testing table.
- b. Prepared a notebook to act as a communication partner and placed it outside of testing area.
- c. The communication partner connected with EUT via a RJ45 cable and ran a test program (provided by manufacturer) to enable EUT under transmission condition continuously at specific channel frequency.
- d. The communication partner sent data to EUT by command "PING".

#### 4.1.7 Test Results

Above 1GHz Worst-Case Data:

CDD Mode

802.11a

CHANNEL	TX Channel 36	DETECTOR FUNCTION	Peak (PK)
FREQUENCY RANGE	1GHz ~ 40GHz		Average (AV)

ANTENNA POLARITY & TEST DISTANCE: HORIZONTAL AT 3 M								
NO.	FREQ. (MHz)	EMISSION LEVEL (dBuV/m)	LIMIT (dBuV/m)	MARGIN (dB)	ANTENNA HEIGHT (m)	TABLE ANGLE (Degree)	RAW VALUE (dBuV)	CORRECTION FACTOR (dB/m)
1	5150.00	69.0 PK	74.0	-5.0	1.73 H	15	63.00	6.00
2	5150.00	52.5 AV	54.0	-1.5	1.73 H	15	46.50	6.00
3	*5180.00	117.7 PK			1.80 H	2	78.30	39.40
4	*5180.00	107.6 AV			1.80 H	2	68.20	39.40
5	#10360.00	60.7 PK	74.0	-13.3	1.96 H	221	42.90	17.80
6	#10360.00	48.3 AV	54.0	-5.7	1.96 H	221	30.50	17.80
ANTENNA POLARITY & TEST DISTANCE: VERTICAL AT 3 M								
NO.	FREQ. (MHz)	EMISSION LEVEL (dBuV/m)	LIMIT (dBuV/m)	MARGIN (dB)	ANTENNA HEIGHT (m)	TABLE ANGLE (Degree)	RAW VALUE (dBuV)	CORRECTION FACTOR (dB/m)
1	5150.00	69.0 PK	74.0	-5.0	1.44 V	349	63.00	6.00
2	5150.00	51.6 AV	54.0	-2.4	1.44 V	349	45.60	6.00
3	*5180.00	114.6 PK			1.68 V	342	75.20	39.40
4	*5180.00	105.7 AV			1.68 V	342	66.30	39.40
5	#10360.00	60.3 PK	74.0	-13.7	1.78 V	251	42.50	17.80
6	#10360.00	46.8 AV	54.0	-7.2	1.78 V	251	29.00	17.80

Remarks:

1. Emission Level(dBuV/m) = Raw Value(dBuV) + Correction Factor(dB/m)
2. Correction Factor(dB/m) = Antenna Factor(dB/m) + Cable Factor(dB)
3. The other emission levels were very low against the limit.
4. Margin value = Emission Level – Limit value
5. " \* ": Fundamental frequency.
6. " # ": The radiated frequency is out of the restricted band.

CHANNEL	TX Channel 40	DETECTOR	Peak (PK)
FREQUENCY RANGE	1GHz ~ 40GHz	FUNCTION	Average (AV)

**ANTENNA POLARITY & TEST DISTANCE: HORIZONTAL AT 3 M**

NO.	FREQ. (MHz)	EMISSION LEVEL (dBuV/m)	LIMIT (dBuV/m)	MARGIN (dB)	ANTENNA HEIGHT (m)	TABLE ANGLE (Degree)	RAW VALUE (dBuV)	CORRECTION FACTOR (dB/m)
1	*5200.00	117.4 PK			1.89 H	345	77.90	39.50
2	*5200.00	107.8 AV			1.89 H	345	68.30	39.50
3	#10400.00	64.1 PK	74.0	-9.9	2.00 H	346	46.40	17.70
4	#10400.00	48.7 AV	54.0	-5.3	2.00 H	346	31.00	17.70

**ANTENNA POLARITY & TEST DISTANCE: VERTICAL AT 3 M**

NO.	FREQ. (MHz)	EMISSION LEVEL (dBuV/m)	LIMIT (dBuV/m)	MARGIN (dB)	ANTENNA HEIGHT (m)	TABLE ANGLE (Degree)	RAW VALUE (dBuV)	CORRECTION FACTOR (dB/m)
1	*5200.00	117.3 PK			1.97 V	342	77.80	39.50
2	*5200.00	106.5 AV			1.97 V	342	67.00	39.50
3	#10400.00	59.8 PK	74.0	-14.2	2.19 V	288	42.10	17.70
4	#10400.00	46.9 AV	54.0	-7.1	2.19 V	288	29.20	17.70

Remarks:

1. Emission Level(dBuV/m) = Raw Value(dBuV) + Correction Factor(dB/m)
2. Correction Factor(dB/m) = Antenna Factor(dB/m) + Cable Factor(dB)
3. The other emission levels were very low against the limit.
4. Margin value = Emission Level – Limit value
5. " \* ": Fundamental frequency.
6. " # ": The radiated frequency is out of the restricted band.

CHANNEL	TX Channel 48	DETECTOR FUNCTION	Peak (PK)
FREQUENCY RANGE	1GHz ~ 40GHz		Average (AV)

**ANTENNA POLARITY & TEST DISTANCE: HORIZONTAL AT 3 M**

NO.	FREQ. (MHz)	EMISSION LEVEL (dBuV/m)	LIMIT (dBuV/m)	MARGIN (dB)	ANTENNA HEIGHT (m)	TABLE ANGLE (Degree)	RAW VALUE (dBuV)	CORRECTION FACTOR (dB/m)
1	*5240.00	117.4 PK			1.82 H	338	77.80	39.60
2	*5240.00	107.5 AV			1.82 H	338	67.90	39.60
3	5350.00	57.4 PK	74.0	-16.6	2.31 H	322	50.90	6.50
4	5350.00	46.4 AV	54.0	-7.6	2.31 H	322	39.90	6.50
5	#10480.00	62.4 PK	74.0	-11.6	2.11 H	323	43.70	18.70
6	#10480.00	49.5 AV	54.0	-4.5	2.11 H	323	30.80	18.70

**ANTENNA POLARITY & TEST DISTANCE: VERTICAL AT 3 M**

NO.	FREQ. (MHz)	EMISSION LEVEL (dBuV/m)	LIMIT (dBuV/m)	MARGIN (dB)	ANTENNA HEIGHT (m)	TABLE ANGLE (Degree)	RAW VALUE (dBuV)	CORRECTION FACTOR (dB/m)
1	*5240.00	117.2 PK			3.40 V	343	77.60	39.60
2	*5240.00	106.9 AV			3.40 V	343	67.30	39.60
3	5350.00	57.4 PK	74.0	-16.6	1.90 V	295	50.90	6.50
4	5350.00	46.4 AV	54.0	-7.6	1.90 V	295	39.90	6.50
5	#10480.00	61.3 PK	74.0	-12.7	1.80 V	255	42.60	18.70
6	#10480.00	48.0 AV	54.0	-6.0	1.80 V	255	29.30	18.70

Remarks:

1. Emission Level(dBuV/m) = Raw Value(dBuV) + Correction Factor(dB/m)
2. Correction Factor(dB/m) = Antenna Factor(dB/m) + Cable Factor(dB)
3. The other emission levels were very low against the limit.
4. Margin value = Emission Level – Limit value
5. " \* ": Fundamental frequency.
6. " # ": The radiated frequency is out of the restricted band.

CHANNEL	TX Channel 149	DETECTOR FUNCTION	Peak (PK)
FREQUENCY RANGE	1GHz ~ 40GHz		Average (AV)

ANTENNA POLARITY & TEST DISTANCE: HORIZONTAL AT 3 M								
NO.	FREQ. (MHz)	EMISSION LEVEL (dBuV/m)	LIMIT (dBuV/m)	MARGIN (dB)	ANTENNA HEIGHT (m)	TABLE ANGLE (Degree)	RAW VALUE (dBuV)	CORRECTION FACTOR (dB/m)
1	#5614.40	58.8 PK	68.2	-9.4	2.02 H	331	51.70	7.10
2	*5745.00	115.2 PK			2.02 H	331	74.70	40.50
3	*5745.00	104.6 AV			2.02 H	331	64.10	40.50
4	#5992.00	60.3 PK	68.2	-7.9	2.02 H	331	52.40	7.90
5	11490.00	61.3 PK	74.0	-12.7	1.60 H	131	42.60	18.70
6	11490.00	48.2 AV	54.0	-5.8	1.60 H	131	29.50	18.70
ANTENNA POLARITY & TEST DISTANCE: VERTICAL AT 3 M								
NO.	FREQ. (MHz)	EMISSION LEVEL (dBuV/m)	LIMIT (dBuV/m)	MARGIN (dB)	ANTENNA HEIGHT (m)	TABLE ANGLE (Degree)	RAW VALUE (dBuV)	CORRECTION FACTOR (dB/m)
1	#5601.60	57.5 PK	68.2	-10.7	3.16 V	353	50.40	7.10
2	*5745.00	115.1 PK			3.16 V	353	74.60	40.50
3	*5745.00	104.4 AV			3.16 V	353	63.90	40.50
4	#5951.20	58.4 PK	68.2	-9.8	3.16 V	353	50.70	7.70
5	11490.00	61.3 PK	74.0	-12.7	2.16 V	141	42.60	18.70
6	11490.00	48.0 AV	54.0	-6.0	2.16 V	141	29.30	18.70

Remarks:

1. Emission Level(dBuV/m) = Raw Value(dBuV) + Correction Factor(dB/m)
2. Correction Factor(dB/m) = Antenna Factor(dB/m) + Cable Factor(dB)
3. The other emission levels were very low against the limit.
4. Margin value = Emission Level – Limit value
5. " \* ": Fundamental frequency.
6. " # ": The radiated frequency is out of the restricted band.



CHANNEL	TX Channel 157	DETECTOR FUNCTION	Peak (PK)
FREQUENCY RANGE	1GHz ~ 40GHz		Average (AV)

**ANTENNA POLARITY & TEST DISTANCE: HORIZONTAL AT 3 M**

NO.	FREQ. (MHz)	EMISSION LEVEL (dBuV/m)	LIMIT (dBuV/m)	MARGIN (dB)	ANTENNA HEIGHT (m)	TABLE ANGLE (Degree)	RAW VALUE (dBuV)	CORRECTION FACTOR (dB/m)
1	#5610.40	56.7 PK	68.2	-11.5	2.25 H	50	49.60	7.10
2	*5785.00	114.4 PK			2.25 H	50	73.80	40.60
3	*5785.00	104.0 AV			2.25 H	50	63.40	40.60
4	#5941.60	58.5 PK	68.2	-9.7	2.25 H	50	50.80	7.70
5	11570.00	60.9 PK	74.0	-13.1	1.85 H	113	42.20	18.70
6	11570.00	48.1 AV	54.0	-5.9	1.85 H	113	29.40	18.70

**ANTENNA POLARITY & TEST DISTANCE: VERTICAL AT 3 M**

NO.	FREQ. (MHz)	EMISSION LEVEL (dBuV/m)	LIMIT (dBuV/m)	MARGIN (dB)	ANTENNA HEIGHT (m)	TABLE ANGLE (Degree)	RAW VALUE (dBuV)	CORRECTION FACTOR (dB/m)
1	#5609.60	57.6 PK	68.2	-10.6	3.09 V	342	50.50	7.10
2	*5785.00	115.0 PK			3.09 V	342	74.40	40.60
3	*5785.00	104.6 AV			3.09 V	342	64.00	40.60
4	#5983.20	59.3 PK	68.2	-8.9	3.09 V	342	51.40	7.90
5	11570.00	60.1 PK	74.0	-13.9	1.88 V	289	41.40	18.70
6	11570.00	47.4 AV	54.0	-6.6	1.88 V	289	28.70	18.70

Remarks:

1. Emission Level(dBuV/m) = Raw Value(dBuV) + Correction Factor(dB/m)
2. Correction Factor(dB/m) = Antenna Factor(dB/m) + Cable Factor(dB)
3. The other emission levels were very low against the limit.
4. Margin value = Emission Level – Limit value
5. " \* ": Fundamental frequency.

CHANNEL	TX Channel 165	DETECTOR FUNCTION	Peak (PK)
FREQUENCY RANGE	1GHz ~ 40GHz		Average (AV)

ANTENNA POLARITY & TEST DISTANCE: HORIZONTAL AT 3 M								
NO.	FREQ. (MHz)	EMISSION LEVEL (dBuV/m)	LIMIT (dBuV/m)	MARGIN (dB)	ANTENNA HEIGHT (m)	TABLE ANGLE (Degree)	RAW VALUE (dBuV)	CORRECTION FACTOR (dB/m)
1	#5618.40	57.0 PK	68.2	-11.2	1.94 H	355	49.90	7.10
2	*5825.00	114.4 PK			1.94 H	355	73.80	40.60
3	*5825.00	104.5 AV			1.94 H	355	63.90	40.60
4	#5965.60	58.4 PK	68.2	-9.8	1.94 H	355	50.60	7.80
5	11650.00	62.0 PK	74.0	-12.0	1.78 H	322	42.80	19.20
6	11650.00	49.2 AV	54.0	-4.8	1.78 H	322	30.00	19.20

ANTENNA POLARITY & TEST DISTANCE: VERTICAL AT 3 M								
NO.	FREQ. (MHz)	EMISSION LEVEL (dBuV/m)	LIMIT (dBuV/m)	MARGIN (dB)	ANTENNA HEIGHT (m)	TABLE ANGLE (Degree)	RAW VALUE (dBuV)	CORRECTION FACTOR (dB/m)
1	#5605.60	56.5 PK	68.2	-11.7	3.29 V	343	49.40	7.10
2	*5825.00	114.8 PK			3.29 V	343	74.20	40.60
3	*5825.00	104.4 AV			3.29 V	343	63.80	40.60
4	#5971.20	58.0 PK	68.2	-10.2	3.29 V	343	50.20	7.80
5	11650.00	60.7 PK	74.0	-13.3	2.10 V	275	41.50	19.20
6	11650.00	47.8 AV	54.0	-6.2	2.10 V	275	28.60	19.20

Remarks:

1. Emission Level(dBuV/m) = Raw Value(dBuV) + Correction Factor(dB/m)
2. Correction Factor(dB/m) = Antenna Factor(dB/m) + Cable Factor(dB)
3. The other emission levels were very low against the limit.
4. Margin value = Emission Level – Limit value
5. " \* ": Fundamental frequency.
6. " # ": The radiated frequency is out of the restricted band.

802.11n (HT20)

CHANNEL	TX Channel 36	DETECTOR FUNCTION	Peak (PK) Average (AV)
FREQUENCY RANGE	1GHz ~ 40GHz		

ANTENNA POLARITY & TEST DISTANCE: HORIZONTAL AT 3 M

NO.	FREQ. (MHz)	EMISSION LEVEL (dBuV/m)	LIMIT (dBuV/m)	MARGIN (dB)	ANTENNA HEIGHT (m)	TABLE ANGLE (Degree)	RAW VALUE (dBuV)	CORRECTION FACTOR (dB/m)
1	5150.00	68.4 PK	74.0	-5.6	1.98 H	351	62.40	6.00
2	5150.00	52.5 AV	54.0	-1.5	1.98 H	351	46.50	6.00
3	*5180.00	117.1 PK			2.12 H	3	77.70	39.40
4	*5180.00	107.3 AV			2.12 H	3	67.90	39.40
5	#10360.00	61.1 PK	74.0	-12.9	1.98 H	347	43.30	17.80
6	#10360.00	48.2 AV	54.0	-5.8	1.98 H	347	30.40	17.80

ANTENNA POLARITY & TEST DISTANCE: VERTICAL AT 3 M

NO.	FREQ. (MHz)	EMISSION LEVEL (dBuV/m)	LIMIT (dBuV/m)	MARGIN (dB)	ANTENNA HEIGHT (m)	TABLE ANGLE (Degree)	RAW VALUE (dBuV)	CORRECTION FACTOR (dB/m)
1	5150.00	63.2 PK	74.0	-10.8	2.34 V	315	57.20	6.00
2	5150.00	50.1 AV	54.0	-3.9	2.34 V	315	44.10	6.00
3	*5180.00	115.4 PK			3.13 V	325	76.00	39.40
4	*5180.00	105.1 AV			3.13 V	325	65.70	39.40
5	#10360.00	59.9 PK	74.0	-14.1	1.36 V	299	42.10	17.80
6	#10360.00	46.9 AV	54.0	-7.1	1.36 V	299	29.10	17.80

Remarks:

1. Emission Level(dBuV/m) = Raw Value(dBuV) + Correction Factor(dB/m)
2. Correction Factor(dB/m) = Antenna Factor(dB/m) + Cable Factor(dB)
3. The other emission levels were very low against the limit.
4. Margin value = Emission Level – Limit value
5. " \* ": Fundamental frequency.
6. " # ": The radiated frequency is out of the restricted band.

CHANNEL	TX Channel 40	DETECTOR	Peak (PK)
FREQUENCY RANGE	1GHz ~ 40GHz	FUNCTION	Average (AV)

**ANTENNA POLARITY & TEST DISTANCE: HORIZONTAL AT 3 M**

NO.	FREQ. (MHz)	EMISSION LEVEL (dBuV/m)	LIMIT (dBuV/m)	MARGIN (dB)	ANTENNA HEIGHT (m)	TABLE ANGLE (Degree)	RAW VALUE (dBuV)	CORRECTION FACTOR (dB/m)
1	*5200.00	118.2 PK			1.97 H	359	78.70	39.50
2	*5200.00	107.8 AV			1.97 H	359	68.30	39.50
3	#10400.00	60.2 PK	74.0	-13.8	2.33 H	179	42.50	17.70
4	#10400.00	47.1 AV	54.0	-6.9	2.33 H	179	29.40	17.70

**ANTENNA POLARITY & TEST DISTANCE: VERTICAL AT 3 M**

NO.	FREQ. (MHz)	EMISSION LEVEL (dBuV/m)	LIMIT (dBuV/m)	MARGIN (dB)	ANTENNA HEIGHT (m)	TABLE ANGLE (Degree)	RAW VALUE (dBuV)	CORRECTION FACTOR (dB/m)
1	*5200.00	116.4 PK			3.13 V	325	76.90	39.50
2	*5200.00	106.0 AV			3.13 V	325	66.50	39.50
3	#10400.00	60.0 PK	74.0	-14.0	2.13 V	323	42.30	17.70
4	#10400.00	47.3 AV	54.0	-6.7	2.13 V	323	29.60	17.70

Remarks:

1. Emission Level(dBuV/m) = Raw Value(dBuV) + Correction Factor(dB/m)
2. Correction Factor(dB/m) = Antenna Factor(dB/m) + Cable Factor(dB)
3. The other emission levels were very low against the limit.
4. Margin value = Emission Level – Limit value
5. " \* ": Fundamental frequency.
6. " # ": The radiated frequency is out of the restricted band.

CHANNEL	TX Channel 48	DETECTOR FUNCTION	Peak (PK)
FREQUENCY RANGE	1GHz ~ 40GHz		Average (AV)

**ANTENNA POLARITY & TEST DISTANCE: HORIZONTAL AT 3 M**

NO.	FREQ. (MHz)	EMISSION LEVEL (dBuV/m)	LIMIT (dBuV/m)	MARGIN (dB)	ANTENNA HEIGHT (m)	TABLE ANGLE (Degree)	RAW VALUE (dBuV)	CORRECTION FACTOR (dB/m)
1	*5240.00	117.7 PK			2.00 H	8	78.10	39.60
2	*5240.00	106.9 AV			2.00 H	8	67.30	39.60
3	5400.00	62.3 PK	74.0	-11.7	1.89 H	344	55.60	6.70
4	5400.00	49.2 AV	54.0	-4.8	1.89 H	344	42.50	6.70
5	#10480.00	61.8 PK	74.0	-12.2	2.50 H	189	43.10	18.70
6	#10480.00	49.0 AV	54.0	-5.0	2.50 H	189	30.30	18.70

**ANTENNA POLARITY & TEST DISTANCE: VERTICAL AT 3 M**

NO.	FREQ. (MHz)	EMISSION LEVEL (dBuV/m)	LIMIT (dBuV/m)	MARGIN (dB)	ANTENNA HEIGHT (m)	TABLE ANGLE (Degree)	RAW VALUE (dBuV)	CORRECTION FACTOR (dB/m)
1	*5240.00	118.0 PK			3.14 V	337	78.40	39.60
2	*5240.00	107.0 AV			3.14 V	337	67.40	39.60
3	5400.00	61.2 PK	74.0	-12.8	2.41 V	279	54.50	6.70
4	5400.00	48.6 AV	54.0	-5.4	2.41 V	279	41.90	6.70
5	#10480.00	61.2 PK	74.0	-12.8	1.47 V	256	42.50	18.70
6	#10480.00	48.0 AV	54.0	-6.0	1.47 V	256	29.30	18.70

Remarks:

1. Emission Level(dBuV/m) = Raw Value(dBuV) + Correction Factor(dB/m)
2. Correction Factor(dB/m) = Antenna Factor(dB/m) + Cable Factor(dB)
3. The other emission levels were very low against the limit.
4. Margin value = Emission Level – Limit value
5. " \* ": Fundamental frequency.
6. " # ": The radiated frequency is out of the restricted band.

CHANNEL	TX Channel 149	DETECTOR FUNCTION	Peak (PK)
FREQUENCY RANGE	1GHz ~ 40GHz		Average (AV)

**ANTENNA POLARITY & TEST DISTANCE: HORIZONTAL AT 3 M**

NO.	FREQ. (MHz)	EMISSION LEVEL (dBuV/m)	LIMIT (dBuV/m)	MARGIN (dB)	ANTENNA HEIGHT (m)	TABLE ANGLE (Degree)	RAW VALUE (dBuV)	CORRECTION FACTOR (dB/m)
1	#5618.40	58.1 PK	68.2	-10.1	2.22 H	9	51.00	7.10
2	*5745.00	114.5 PK			2.22 H	9	74.00	40.50
3	*5745.00	104.6 AV			2.22 H	9	64.10	40.50
4	#5959.20	59.0 PK	68.2	-9.2	2.22 H	9	51.30	7.70
5	11490.00	61.9 PK	74.0	-12.1	1.66 H	284	43.20	18.70
6	11490.00	48.8 AV	54.0	-5.2	1.66 H	284	30.10	18.70

**ANTENNA POLARITY & TEST DISTANCE: VERTICAL AT 3 M**

NO.	FREQ. (MHz)	EMISSION LEVEL (dBuV/m)	LIMIT (dBuV/m)	MARGIN (dB)	ANTENNA HEIGHT (m)	TABLE ANGLE (Degree)	RAW VALUE (dBuV)	CORRECTION FACTOR (dB/m)
1	#5608.00	56.8 PK	68.2	-11.4	3.09 V	330	49.70	7.10
2	*5745.00	113.9 PK			3.09 V	330	73.40	40.50
3	*5745.00	103.0 AV			3.09 V	330	62.50	40.50
4	#5964.80	57.9 PK	68.2	-10.3	3.09 V	330	50.10	7.80
5	11490.00	59.8 PK	74.0	-14.2	2.09 V	33	41.10	18.70
6	11490.00	47.0 AV	54.0	-7.0	2.09 V	33	28.30	18.70

Remarks:

1. Emission Level(dBuV/m) = Raw Value(dBuV) + Correction Factor(dB/m)
2. Correction Factor(dB/m) = Antenna Factor(dB/m) + Cable Factor(dB)
3. The other emission levels were very low against the limit.
4. Margin value = Emission Level – Limit value
5. " \* ": Fundamental frequency.
6. " # ": The radiated frequency is out of the restricted band.

CHANNEL	TX Channel 157	DETECTOR FUNCTION	Peak (PK)
FREQUENCY RANGE	1GHz ~ 40GHz		Average (AV)

**ANTENNA POLARITY & TEST DISTANCE: HORIZONTAL AT 3 M**

NO.	FREQ. (MHz)	EMISSION LEVEL (dBuV/m)	LIMIT (dBuV/m)	MARGIN (dB)	ANTENNA HEIGHT (m)	TABLE ANGLE (Degree)	RAW VALUE (dBuV)	CORRECTION FACTOR (dB/m)
1	#5628.80	57.2 PK	68.2	-11.0	2.12 H	359	50.10	7.10
2	*5785.00	113.9 PK			2.12 H	359	73.30	40.60
3	*5785.00	103.3 AV			2.12 H	359	62.70	40.60
4	#5972.80	58.3 PK	68.2	-9.9	2.12 H	359	50.40	7.90
5	11570.00	62.0 PK	74.0	-12.0	1.85 H	277	43.30	18.70
6	11570.00	48.9 AV	54.0	-5.1	1.85 H	277	30.20	18.70

**ANTENNA POLARITY & TEST DISTANCE: VERTICAL AT 3 M**

NO.	FREQ. (MHz)	EMISSION LEVEL (dBuV/m)	LIMIT (dBuV/m)	MARGIN (dB)	ANTENNA HEIGHT (m)	TABLE ANGLE (Degree)	RAW VALUE (dBuV)	CORRECTION FACTOR (dB/m)
1	#5634.40	56.7 PK	68.2	-11.5	3.10 V	341	49.60	7.10
2	*5785.00	114.2 PK			3.10 V	341	73.60	40.60
3	*5785.00	103.9 AV			3.10 V	341	63.30	40.60
4	#5985.60	58.8 PK	68.2	-9.4	3.10 V	341	50.90	7.90
5	11570.00	60.2 PK	74.0	-13.8	2.01 V	182	41.50	18.70
6	11570.00	47.1 AV	54.0	-6.9	2.01 V	182	28.40	18.70

Remarks:

1. Emission Level(dBuV/m) = Raw Value(dBuV) + Correction Factor(dB/m)
2. Correction Factor(dB/m) = Antenna Factor(dB/m) + Cable Factor(dB)
3. The other emission levels were very low against the limit.
4. Margin value = Emission Level – Limit value
5. " \* ": Fundamental frequency.

CHANNEL	TX Channel 165	DETECTOR FUNCTION	Peak (PK)
FREQUENCY RANGE	1GHz ~ 40GHz		Average (AV)

**ANTENNA POLARITY & TEST DISTANCE: HORIZONTAL AT 3 M**

NO.	FREQ. (MHz)	EMISSION LEVEL (dBuV/m)	LIMIT (dBuV/m)	MARGIN (dB)	ANTENNA HEIGHT (m)	TABLE ANGLE (Degree)	RAW VALUE (dBuV)	CORRECTION FACTOR (dB/m)
1	#5632.00	58.3 PK	68.2	-9.9	2.47 H	345	51.20	7.10
2	*5825.00	115.7 PK			2.47 H	355	75.10	40.60
3	*5825.00	105.5 AV			2.47 H	355	64.90	40.60
4	#5976.80	59.4 PK	68.2	-8.8	2.47 H	345	51.50	7.90
5	11650.00	61.9 PK	74.0	-12.1	1.56 H	302	42.70	19.20
6	11650.00	49.0 AV	54.0	-5.0	1.56 H	302	29.80	19.20

**ANTENNA POLARITY & TEST DISTANCE: VERTICAL AT 3 M**

NO.	FREQ. (MHz)	EMISSION LEVEL (dBuV/m)	LIMIT (dBuV/m)	MARGIN (dB)	ANTENNA HEIGHT (m)	TABLE ANGLE (Degree)	RAW VALUE (dBuV)	CORRECTION FACTOR (dB/m)
1	#5641.60	56.2 PK	68.2	-12.0	3.22 V	334	49.10	7.10
2	*5825.00	113.6 PK			3.22 V	334	73.00	40.60
3	*5825.00	103.1 AV			3.22 V	334	62.50	40.60
4	#5990.40	58.0 PK	68.2	-10.2	3.22 V	334	50.10	7.90
5	11650.00	61.0 PK	74.0	-13.0	1.96 V	40	41.80	19.20
6	11650.00	48.2 AV	54.0	-5.8	1.96 V	40	29.00	19.20

Remarks:

1. Emission Level(dBuV/m) = Raw Value(dBuV) + Correction Factor(dB/m)
2. Correction Factor(dB/m) = Antenna Factor(dB/m) + Cable Factor(dB)
3. The other emission levels were very low against the limit.
4. Margin value = Emission Level – Limit value
5. " \* ": Fundamental frequency.
6. " # ": The radiated frequency is out of the restricted band.



802.11n (HT40)

CHANNEL	TX Channel 38	DETECTOR FUNCTION	Peak (PK) Average (AV)
FREQUENCY RANGE	1GHz ~ 40GHz		

ANTENNA POLARITY & TEST DISTANCE: HORIZONTAL AT 3 M

NO.	FREQ. (MHz)	EMISSION LEVEL (dBuV/m)	LIMIT (dBuV/m)	MARGIN (dB)	ANTENNA HEIGHT (m)	TABLE ANGLE (Degree)	RAW VALUE (dBuV)	CORRECTION FACTOR (dB/m)
1	5150.00	66.9 PK	74.0	-7.1	1.90 H	11	60.90	6.00
2	5150.00	52.6 AV	54.0	-1.4	1.90 H	11	46.60	6.00
3	*5190.00	111.9 PK			1.85 H	4	72.50	39.40
4	*5190.00	102.3 AV			1.85 H	4	62.90	39.40
5	#10360.00	61.2 PK	74.0	-12.8	1.68 H	204	43.40	17.80
6	#10360.00	48.1 AV	54.0	-5.9	1.68 H	204	30.30	17.80

ANTENNA POLARITY & TEST DISTANCE: VERTICAL AT 3 M

NO.	FREQ. (MHz)	EMISSION LEVEL (dBuV/m)	LIMIT (dBuV/m)	MARGIN (dB)	ANTENNA HEIGHT (m)	TABLE ANGLE (Degree)	RAW VALUE (dBuV)	CORRECTION FACTOR (dB/m)
1	5150.00	64.9 PK	74.0	-9.1	2.13 V	337	58.90	6.00
2	5150.00	51.6 AV	54.0	-2.4	2.13 V	337	45.60	6.00
3	*5190.00	110.6 PK			2.11 V	342	71.20	39.40
4	*5190.00	101.7 AV			2.11 V	342	62.30	39.40
5	#10380.00	59.4 PK	74.0	-14.6	1.68 V	321	41.70	17.70
6	#10380.00	46.6 AV	54.0	-7.4	1.68 V	321	28.90	17.70

Remarks:

1. Emission Level(dBuV/m) = Raw Value(dBuV) + Correction Factor(dB/m)
2. Correction Factor(dB/m) = Antenna Factor(dB/m) + Cable Factor(dB)
3. The other emission levels were very low against the limit.
4. Margin value = Emission Level – Limit value
5. " \* ": Fundamental frequency.
6. " # ": The radiated frequency is out of the restricted band.

CHANNEL	TX Channel 46	DETECTOR FUNCTION	Peak (PK)
FREQUENCY RANGE	1GHz ~ 40GHz		Average (AV)

**ANTENNA POLARITY & TEST DISTANCE: HORIZONTAL AT 3 M**

NO.	FREQ. (MHz)	EMISSION LEVEL (dBuV/m)	LIMIT (dBuV/m)	MARGIN (dB)	ANTENNA HEIGHT (m)	TABLE ANGLE (Degree)	RAW VALUE (dBuV)	CORRECTION FACTOR (dB/m)
1	*5230.00	115.7 PK			1.89 H	6	76.10	39.60
2	*5230.00	105.9 AV			1.89 H	6	66.30	39.60
3	5400.00	65.8 PK	74.0	-8.2	1.90 H	313	59.50	6.30
4	5400.00	51.1 AV	54.0	-2.9	1.90 H	313	44.40	6.70
5	#10460.00	60.7 PK	74.0	-13.3	1.69 H	46	42.20	18.50
6	#10460.00	47.9 AV	54.0	-6.1	1.69 H	46	29.40	18.50

**ANTENNA POLARITY & TEST DISTANCE: VERTICAL AT 3 M**

NO.	FREQ. (MHz)	EMISSION LEVEL (dBuV/m)	LIMIT (dBuV/m)	MARGIN (dB)	ANTENNA HEIGHT (m)	TABLE ANGLE (Degree)	RAW VALUE (dBuV)	CORRECTION FACTOR (dB/m)
1	*5230.00	114.4 PK			1.99 V	338	74.80	39.60
2	*5230.00	105.3 AV			1.99 V	338	65.70	39.60
3	5400.00	59.2 PK	74.0	-14.8	2.19 V	255	52.50	6.70
4	5400.00	47.8 AV	54.0	-6.2	2.19 V	255	41.10	6.70
5	#10460.00	59.5 PK	74.0	-14.5	1.59 V	133	41.00	18.50
6	#10460.00	46.7 AV	54.0	-7.3	1.59 V	133	28.20	18.50

Remarks:

1. Emission Level(dBuV/m) = Raw Value(dBuV) + Correction Factor(dB/m)
2. Correction Factor(dB/m) = Antenna Factor(dB/m) + Cable Factor(dB)
3. The other emission levels were very low against the limit.
4. Margin value = Emission Level – Limit value
5. " \* ": Fundamental frequency.
6. " # ": The radiated frequency is out of the restricted band.

CHANNEL	TX Channel 151	DETECTOR	Peak (PK)
FREQUENCY RANGE	1GHz ~ 40GHz	FUNCTION	Average (AV)

**ANTENNA POLARITY & TEST DISTANCE: HORIZONTAL AT 3 M**

NO.	FREQ. (MHz)	EMISSION LEVEL (dBuV/m)	LIMIT (dBuV/m)	MARGIN (dB)	ANTENNA HEIGHT (m)	TABLE ANGLE (Degree)	RAW VALUE (dBuV)	CORRECTION FACTOR (dB/m)
1	#5644.00	58.8 PK	68.2	-9.4	1.86 H	8	51.70	7.10
2	*5755.00	112.5 PK			1.86 H	8	71.90	40.60
3	*5755.00	103.3 AV			1.86 H	8	62.70	40.60
4	#5959.20	60.1 PK	68.2	-8.1	1.86 H	8	52.40	7.70
5	11510.00	61.3 PK	74.0	-12.7	1.77 H	111	42.60	18.70
6	11510.00	48.5 AV	54.0	-5.5	1.77 H	111	29.80	18.70

**ANTENNA POLARITY & TEST DISTANCE: VERTICAL AT 3 M**

NO.	FREQ. (MHz)	EMISSION LEVEL (dBuV/m)	LIMIT (dBuV/m)	MARGIN (dB)	ANTENNA HEIGHT (m)	TABLE ANGLE (Degree)	RAW VALUE (dBuV)	CORRECTION FACTOR (dB/m)
1	#5628.00	56.3 PK	68.2	-11.9	3.16 V	335	49.20	7.10
2	*5755.00	111.9 PK			3.16 V	335	71.30	40.60
3	*5755.00	102.5 AV			3.16 V	335	61.90	40.60
4	#5957.60	57.5 PK	68.2	-10.7	3.16 V	335	49.80	7.70
5	11510.00	60.0 PK	74.0	-14.0	1.79 V	66	41.30	18.70
6	11510.00	46.8 AV	54.0	-7.2	1.79 V	66	28.10	18.70

**Remarks:**

1. Emission Level(dBuV/m) = Raw Value(dBuV) + Correction Factor(dB/m)
2. Correction Factor(dB/m) = Antenna Factor(dB/m) + Cable Factor(dB)
3. The other emission levels were very low against the limit.
4. Margin value = Emission Level – Limit value
5. " \* ": Fundamental frequency.
6. " # ": The radiated frequency is out of the restricted band.

CHANNEL	TX Channel 159	DETECTOR FUNCTION	Peak (PK)
FREQUENCY RANGE	1GHz ~ 40GHz		Average (AV)

**ANTENNA POLARITY & TEST DISTANCE: HORIZONTAL AT 3 M**

NO.	FREQ. (MHz)	EMISSION LEVEL (dBuV/m)	LIMIT (dBuV/m)	MARGIN (dB)	ANTENNA HEIGHT (m)	TABLE ANGLE (Degree)	RAW VALUE (dBuV)	CORRECTION FACTOR (dB/m)
1	#5644.80	58.2 PK	68.2	-10.0	2.00 H	355	51.10	7.10
2	*5795.00	110.4 PK			2.00 H	355	69.80	40.60
3	*5795.00	100.9 AV			2.00 H	355	60.30	40.60
4	#5981.60	59.4 PK	68.2	-8.8	2.00 H	355	51.50	7.90
5	11590.00	61.0 PK	74.0	-13.0	1.69 H	287	42.20	18.80
6	11590.00	47.8 AV	54.0	-6.2	1.69 H	287	29.00	18.80

**ANTENNA POLARITY & TEST DISTANCE: VERTICAL AT 3 M**

NO.	FREQ. (MHz)	EMISSION LEVEL (dBuV/m)	LIMIT (dBuV/m)	MARGIN (dB)	ANTENNA HEIGHT (m)	TABLE ANGLE (Degree)	RAW VALUE (dBuV)	CORRECTION FACTOR (dB/m)
1	#5612.00	57.5 PK	68.2	-10.7	3.12 V	354	50.40	7.10
2	*5795.00	111.0 PK			3.12 V	354	70.40	40.60
3	*5795.00	101.7 AV			3.12 V	354	61.10	40.60
4	#5962.40	57.9 PK	68.2	-10.3	3.12 V	354	50.10	7.80
5	11590.00	60.7 PK	74.0	-13.3	2.22 V	33	41.90	18.80
6	11590.00	47.6 AV	54.0	-6.4	2.22 V	33	28.80	18.80

Remarks:

1. Emission Level(dBuV/m) = Raw Value(dBuV) + Correction Factor(dB/m)
2. Correction Factor(dB/m) = Antenna Factor(dB/m) + Cable Factor(dB)
3. The other emission levels were very low against the limit.
4. Margin value = Emission Level – Limit value
5. " \* ": Fundamental frequency.
6. " # ": The radiated frequency is out of the restricted band.

802.11ac (VHT80)

CHANNEL	TX Channel 42	DETECTOR FUNCTION	Peak (PK) Average (AV)
FREQUENCY RANGE	1GHz ~ 40GHz		

ANTENNA POLARITY & TEST DISTANCE: HORIZONTAL AT 3 M

NO.	FREQ. (MHz)	EMISSION LEVEL (dBuV/m)	LIMIT (dBuV/m)	MARGIN (dB)	ANTENNA HEIGHT (m)	TABLE ANGLE (Degree)	RAW VALUE (dBuV)	CORRECTION FACTOR (dB/m)
1	5150.00	65.4 PK	74.0	-8.6	2.32 H	307	59.40	6.00
2	<b>5150.00</b>	<b>52.7 AV</b>	<b>54.0</b>	<b>-1.3</b>	<b>2.32 H</b>	<b>307</b>	<b>46.70</b>	<b>6.00</b>
3	*5210.00	108.1 PK			2.02 H	333	68.60	39.50
4	*5210.00	98.4 AV			2.02 H	333	58.90	39.50
5	5350.00	59.1 PK	74.0	-14.9	1.78 H	345	52.60	6.50
6	5350.00	46.6 AV	54.0	-7.4	1.78 H	345	40.10	6.50
7	#10420.00	60.0 PK	74.0	-14.0	2.54 H	152	42.10	17.90
8	#10420.00	46.9 AV	54.0	-7.1	2.54 H	152	29.00	17.90

ANTENNA POLARITY & TEST DISTANCE: VERTICAL AT 3 M

NO.	FREQ. (MHz)	EMISSION LEVEL (dBuV/m)	LIMIT (dBuV/m)	MARGIN (dB)	ANTENNA HEIGHT (m)	TABLE ANGLE (Degree)	RAW VALUE (dBuV)	CORRECTION FACTOR (dB/m)
1	5150.00	63.6 PK	74.0	-10.4	2.10 V	337	57.60	6.00
2	5150.00	50.9 AV	54.0	-3.1	2.10 V	337	44.90	6.00
3	*5210.00	106.6 PK			2.18 V	340	67.10	39.50
4	*5210.00	96.8 AV			2.18 V	340	57.30	39.50
5	5350.00	60.1 PK	74.0	-13.9	1.89 V	347	53.60	6.50
6	5350.00	46.5 AV	54.0	-7.5	1.89 V	347	40.00	6.50
7	#10420.00	59.2 PK	74.0	-14.8	1.55 V	19	41.30	17.90
8	#10420.00	46.4 AV	54.0	-7.6	1.55 V	19	28.50	17.90

Remarks:

1. Emission Level(dBuV/m) = Raw Value(dBuV) + Correction Factor(dB/m)
2. Correction Factor(dB/m) = Antenna Factor(dB/m) + Cable Factor(dB)
3. The other emission levels were very low against the limit.
4. Margin value = Emission Level – Limit value
5. " \* ": Fundamental frequency.
6. " # ": The radiated frequency is out of the restricted band.

CHANNEL	TX Channel 155	DETECTOR FUNCTION	Peak (PK)
FREQUENCY RANGE	1GHz ~ 40GHz		Average (AV)

**ANTENNA POLARITY & TEST DISTANCE: HORIZONTAL AT 3 M**

NO.	FREQ. (MHz)	EMISSION LEVEL (dBuV/m)	LIMIT (dBuV/m)	MARGIN (dB)	ANTENNA HEIGHT (m)	TABLE ANGLE (Degree)	RAW VALUE (dBuV)	CORRECTION FACTOR (dB/m)
1	#5632.00	59.4 PK	68.2	-8.8	1.86 H	356	52.30	7.10
2	#5650.00	66.8 PK	68.2	-1.4	1.76 H	342	59.70	7.10
3	*5775.00	117.8 PK			1.86 H	358	77.20	40.60
4	*5775.00	108.7 AV			1.86 H	358	68.10	40.60
5	#5930.00	65.4 PK	68.2	-2.8	2.56 H	345	57.70	7.70
6	#5957.60	60.2 PK	68.2	-8.0	1.86 H	356	52.50	7.70
7	11550.00	59.7 PK	74.0	-14.3	1.60 H	258	41.10	18.60
8	11550.00	46.9 AV	54.0	-7.1	1.60 H	258	28.30	18.60

**ANTENNA POLARITY & TEST DISTANCE: VERTICAL AT 3 M**

NO.	FREQ. (MHz)	EMISSION LEVEL (dBuV/m)	LIMIT (dBuV/m)	MARGIN (dB)	ANTENNA HEIGHT (m)	TABLE ANGLE (Degree)	RAW VALUE (dBuV)	CORRECTION FACTOR (dB/m)
1	#5643.20	61.9 PK	68.2	-6.3	3.13 V	349	54.80	7.10
2	#5650.00	62.5 PK	68.2	-5.7	2.67 V	289	55.40	7.10
3	*5775.00	106.7 PK			3.13 V	349	66.10	40.60
4	*5775.00	96.3 AV			3.13 V	349	55.70	40.60
5	#5925.00	60.4 PK	68.2	-7.8	2.78 V	324	52.70	7.70
6	#5978.40	59.7 PK	68.2	-8.5	3.13 V	349	51.80	7.90
7	11550.00	59.6 PK	74.0	-14.4	1.70 V	123	41.00	18.60
8	11550.00	46.4 AV	54.0	-7.6	1.70 V	123	27.80	18.60

Remarks:

1. Emission Level(dBuV/m) = Raw Value(dBuV) + Correction Factor(dB/m)
2. Correction Factor(dB/m) = Antenna Factor(dB/m) + Cable Factor(dB)
3. The other emission levels were very low against the limit.
4. Margin value = Emission Level – Limit value
5. " \* ": Fundamental frequency.
6. " # ": The radiated frequency is out of the restricted band.

Beamforming Mode

802.11n (HT20)

CHANNEL	TX Channel 36	DETECTOR FUNCTION	Peak (PK)
FREQUENCY RANGE	1GHz ~ 40GHz		Average (AV)

ANTENNA POLARITY & TEST DISTANCE: HORIZONTAL AT 3 M

NO.	FREQ. (MHz)	EMISSION LEVEL (dBuV/m)	LIMIT (dBuV/m)	MARGIN (dB)	ANTENNA HEIGHT (m)	TABLE ANGLE (Degree)	RAW VALUE (dBuV)	CORRECTION FACTOR (dB/m)
1	5150.00	69.0 PK	74.0	-5.0	2.28 H	348	64.20	4.80
2	5150.00	49.0 AV	54.0	-5.0	2.28 H	348	44.20	4.80
3	*5180.00	118.2 PK			1.16 H	5	79.50	38.70
4	*5180.00	105.5 AV			1.16 H	5	66.80	38.70
5	#10360.00	59.9 PK	74.0	-14.1	1.85 H	332	42.30	17.60
6	#10360.00	46.3 AV	54.0	-7.7	1.85 H	332	28.70	17.60

ANTENNA POLARITY & TEST DISTANCE: VERTICAL AT 3 M

NO.	FREQ. (MHz)	EMISSION LEVEL (dBuV/m)	LIMIT (dBuV/m)	MARGIN (dB)	ANTENNA HEIGHT (m)	TABLE ANGLE (Degree)	RAW VALUE (dBuV)	CORRECTION FACTOR (dB/m)
1	5150.00	64.4 PK	74.0	-9.6	2.41 V	342	59.60	4.80
2	5150.00	47.2 AV	54.0	-6.8	2.41 V	342	42.40	4.80
3	*5180.00	117.8 PK			1.74 V	343	79.10	38.70
4	*5180.00	105.3 AV			1.74 V	343	66.60	38.70
5	#10360.00	59.4 PK	74.0	-14.6	2.29 V	168	41.80	17.60
6	#10360.00	46.3 AV	54.0	-7.7	2.29 V	168	28.70	17.60

Remarks:

1. Emission Level(dBuV/m) = Raw Value(dBuV) + Correction Factor(dB/m)
2. Correction Factor(dB/m) = Antenna Factor(dB/m) + Cable Factor(dB)
3. The other emission levels were very low against the limit.
4. Margin value = Emission Level – Limit value
5. " \* ": Fundamental frequency.
6. " # ": The radiated frequency is out of the restricted band.

CHANNEL	TX Channel 40	DETECTOR	Peak (PK)
FREQUENCY RANGE	1GHz ~ 40GHz	FUNCTION	Average (AV)

**ANTENNA POLARITY & TEST DISTANCE: HORIZONTAL AT 3 M**

NO.	FREQ. (MHz)	EMISSION LEVEL (dBuV/m)	LIMIT (dBuV/m)	MARGIN (dB)	ANTENNA HEIGHT (m)	TABLE ANGLE (Degree)	RAW VALUE (dBuV)	CORRECTION FACTOR (dB/m)
1	*5200.00	121.7 PK			1.31 H	353	83.00	38.70
2	*5200.00	109.7 AV			1.31 H	353	71.00	38.70
3	#10400.00	59.4 PK	74.0	-14.6	2.84 H	251	41.80	17.60
4	#10400.00	46.7 AV	54.0	-7.3	2.84 H	251	29.10	17.60

**ANTENNA POLARITY & TEST DISTANCE: VERTICAL AT 3 M**

NO.	FREQ. (MHz)	EMISSION LEVEL (dBuV/m)	LIMIT (dBuV/m)	MARGIN (dB)	ANTENNA HEIGHT (m)	TABLE ANGLE (Degree)	RAW VALUE (dBuV)	CORRECTION FACTOR (dB/m)
1	*5200.00	119.6 PK			1.47 V	349	80.90	38.70
2	*5200.00	106.6 AV			1.47 V	349	67.90	38.70
3	#10400.00	59.5 PK	74.0	-14.5	2.64 V	236	41.90	17.60
4	#10400.00	46.4 AV	54.0	-7.6	2.64 V	236	28.80	17.60

Remarks:

1. Emission Level(dBuV/m) = Raw Value(dBuV) + Correction Factor(dB/m)
2. Correction Factor(dB/m) = Antenna Factor(dB/m) + Cable Factor(dB)
3. The other emission levels were very low against the limit.
4. Margin value = Emission Level – Limit value
5. " \* ": Fundamental frequency.
6. " # ": The radiated frequency is out of the restricted band.



CHANNEL	TX Channel 48	DETECTOR FUNCTION	Peak (PK)
FREQUENCY RANGE	1GHz ~ 40GHz		Average (AV)

ANTENNA POLARITY & TEST DISTANCE: HORIZONTAL AT 3 M

NO.	FREQ. (MHz)	EMISSION LEVEL (dBuV/m)	LIMIT (dBuV/m)	MARGIN (dB)	ANTENNA HEIGHT (m)	TABLE ANGLE (Degree)	RAW VALUE (dBuV)	CORRECTION FACTOR (dB/m)
1	*5240.00	120.8 PK			1.30 H	356	81.90	38.90
2	*5240.00	108.3 AV			1.30 H	356	69.40	38.90
3	5350.00	58.0 PK	74.0	-16.0	1.54 H	2	52.50	5.50
4	5350.00	45.2 AV	54.0	-8.8	1.54 H	2	39.70	5.50
5	#10480.00	60.6 PK	74.0	-13.4	2.24 H	210	42.20	18.40
6	#10480.00	47.0 AV	54.0	-7.0	2.24 H	210	28.60	18.40

ANTENNA POLARITY & TEST DISTANCE: VERTICAL AT 3 M

NO.	FREQ. (MHz)	EMISSION LEVEL (dBuV/m)	LIMIT (dBuV/m)	MARGIN (dB)	ANTENNA HEIGHT (m)	TABLE ANGLE (Degree)	RAW VALUE (dBuV)	CORRECTION FACTOR (dB/m)
1	*5240.00	118.9 PK			1.44 V	348	80.00	38.90
2	*5240.00	105.9 AV			1.44 V	348	67.00	38.90
3	5350.00	57.3 PK	74.0	-16.7	2.87 V	25	51.80	5.50
4	5350.00	45.2 AV	54.0	-8.8	2.87 V	25	39.70	5.50
5	#10480.00	59.8 PK	74.0	-14.2	1.63 V	282	41.40	18.40
6	#10480.00	46.8 AV	54.0	-7.2	1.63 V	282	28.40	18.40

Remarks:

1. Emission Level(dBuV/m) = Raw Value(dBuV) + Correction Factor(dB/m)
2. Correction Factor(dB/m) = Antenna Factor(dB/m) + Cable Factor(dB)
3. The other emission levels were very low against the limit.
4. Margin value = Emission Level – Limit value
5. " \* ": Fundamental frequency.
6. " # ": The radiated frequency is out of the restricted band.

CHANNEL	TX Channel 149	DETECTOR FUNCTION	Peak (PK)
FREQUENCY RANGE	1GHz ~ 40GHz		Average (AV)

**ANTENNA POLARITY & TEST DISTANCE: HORIZONTAL AT 3 M**

NO.	FREQ. (MHz)	EMISSION LEVEL (dBuV/m)	LIMIT (dBuV/m)	MARGIN (dB)	ANTENNA HEIGHT (m)	TABLE ANGLE (Degree)	RAW VALUE (dBuV)	CORRECTION FACTOR (dB/m)
1	#5625.00	66.4 PK	68.2	-1.8	1.59 H	11	60.30	6.10
2	#5632.00	65.5 PK	68.2	-2.7	1.28 H	7	59.40	6.10
3	*5745.00	118.6 PK			1.28 H	7	78.60	40.00
4	*5745.00	106.2 AV			1.28 H	7	66.20	40.00
5	#5944.80	59.1 PK	68.2	-9.1	1.28 H	7	52.50	6.60
6	11490.00	60.8 PK	74.0	-13.2	2.58 H	219	41.50	19.30
7	11490.00	47.9 AV	54.0	-6.1	2.58 H	219	28.60	19.30

**ANTENNA POLARITY & TEST DISTANCE: VERTICAL AT 3 M**

NO.	FREQ. (MHz)	EMISSION LEVEL (dBuV/m)	LIMIT (dBuV/m)	MARGIN (dB)	ANTENNA HEIGHT (m)	TABLE ANGLE (Degree)	RAW VALUE (dBuV)	CORRECTION FACTOR (dB/m)
1	#5608.80	57.7 PK	68.2	-10.5	2.98 V	334	51.60	6.10
2	*5745.00	117.6 PK			2.98 V	334	77.60	40.00
3	*5745.00	105.3 AV			2.98 V	334	65.30	40.00
4	#5968.80	58.7 PK	68.2	-9.5	2.98 V	334	52.00	6.70
5	11490.00	61.0 PK	74.0	-13.0	3.01 V	143	41.70	19.30
6	11490.00	47.6 AV	54.0	-6.4	3.01 V	143	28.30	19.30

Remarks:

1. Emission Level(dBuV/m) = Raw Value(dBuV) + Correction Factor(dB/m)
2. Correction Factor(dB/m) = Antenna Factor(dB/m) + Cable Factor(dB)
3. The other emission levels were very low against the limit.
4. Margin value = Emission Level – Limit value
5. " \* ": Fundamental frequency.
6. " # ": The radiated frequency is out of the restricted band.

CHANNEL	TX Channel 157	DETECTOR FUNCTION	Peak (PK)
FREQUENCY RANGE	1GHz ~ 40GHz		Average (AV)

**ANTENNA POLARITY & TEST DISTANCE: HORIZONTAL AT 3 M**

NO.	FREQ. (MHz)	EMISSION LEVEL (dBuV/m)	LIMIT (dBuV/m)	MARGIN (dB)	ANTENNA HEIGHT (m)	TABLE ANGLE (Degree)	RAW VALUE (dBuV)	CORRECTION FACTOR (dB/m)
1	#5622.40	59.3 PK	68.2	-8.9	1.43 H	321	53.20	6.10
2	*5785.00	116.5 PK			1.43 H	321	76.40	40.10
3	*5785.00	104.5 AV			1.43 H	321	64.40	40.10
4	#5929.60	58.7 PK	68.2	-9.5	1.43 H	321	52.10	6.60
5	11570.00	60.7 PK	74.0	-13.3	1.73 H	256	41.50	19.20
6	11570.00	47.6 AV	54.0	-6.4	1.73 H	256	28.40	19.20

**ANTENNA POLARITY & TEST DISTANCE: VERTICAL AT 3 M**

NO.	FREQ. (MHz)	EMISSION LEVEL (dBuV/m)	LIMIT (dBuV/m)	MARGIN (dB)	ANTENNA HEIGHT (m)	TABLE ANGLE (Degree)	RAW VALUE (dBuV)	CORRECTION FACTOR (dB/m)
1	#5647.20	58.6 PK	68.2	-9.6	2.72 V	16	52.50	6.10
2	*5785.00	115.7 PK			2.72 V	16	75.60	40.10
3	*5785.00	104.9 AV			2.72 V	16	64.80	40.10
4	#5931.20	59.0 PK	68.2	-9.2	2.72 V	16	52.40	6.60
5	11570.00	60.8 PK	74.0	-13.2	2.96 V	262	41.60	19.20
6	11570.00	47.6 AV	54.0	-6.4	2.96 V	262	28.40	19.20

Remarks:

1. Emission Level(dBuV/m) = Raw Value(dBuV) + Correction Factor(dB/m)
2. Correction Factor(dB/m) = Antenna Factor(dB/m) + Cable Factor(dB)
3. The other emission levels were very low against the limit.
4. Margin value = Emission Level – Limit value
5. " \* ": Fundamental frequency.

CHANNEL	TX Channel 165	DETECTOR FUNCTION	Peak (PK)
FREQUENCY RANGE	1GHz ~ 40GHz		Average (AV)

ANTENNA POLARITY & TEST DISTANCE: HORIZONTAL AT 3 M

NO.	FREQ. (MHz)	EMISSION LEVEL (dBuV/m)	LIMIT (dBuV/m)	MARGIN (dB)	ANTENNA HEIGHT (m)	TABLE ANGLE (Degree)	RAW VALUE (dBuV)	CORRECTION FACTOR (dB/m)
1	#5600.80	58.3 PK	68.2	-9.9	1.43 H	3	52.20	6.10
2	*5825.00	117.6 PK			1.43 H	3	77.50	40.10
3	*5825.00	106.4 AV			1.43 H	3	66.30	40.10
4	#5982.40	59.5 PK	68.2	-8.7	1.43 H	3	52.80	6.70
5	11650.00	60.5 PK	74.0	-13.5	1.97 H	298	41.20	19.30
6	11650.00	47.5 AV	54.0	-6.5	1.97 H	298	28.20	19.30

ANTENNA POLARITY & TEST DISTANCE: VERTICAL AT 3 M

NO.	FREQ. (MHz)	EMISSION LEVEL (dBuV/m)	LIMIT (dBuV/m)	MARGIN (dB)	ANTENNA HEIGHT (m)	TABLE ANGLE (Degree)	RAW VALUE (dBuV)	CORRECTION FACTOR (dB/m)
1	#5604.80	58.2 PK	68.2	-10.0	1.32 V	320	52.10	6.10
2	*5825.00	112.0 PK			1.32 V	320	71.90	40.10
3	*5825.00	101.2 AV			1.32 V	320	61.10	40.10
4	#5964.80	58.9 PK	68.2	-9.3	1.32 V	320	52.20	6.70
5	11650.00	60.7 PK	74.0	-13.3	2.84 V	286	41.40	19.30
6	11650.00	47.5 AV	54.0	-6.5	2.84 V	286	28.20	19.30

Remarks:

1. Emission Level(dBuV/m) = Raw Value(dBuV) + Correction Factor(dB/m)
2. Correction Factor(dB/m) = Antenna Factor(dB/m) + Cable Factor(dB)
3. The other emission levels were very low against the limit.
4. Margin value = Emission Level – Limit value
5. " \* ": Fundamental frequency.
6. " # ": The radiated frequency is out of the restricted band.

802.11n (HT40)

CHANNEL	TX Channel 38	DETECTOR FUNCTION	Peak (PK) Average (AV)
FREQUENCY RANGE	1GHz ~ 40GHz		

ANTENNA POLARITY & TEST DISTANCE: HORIZONTAL AT 3 M

NO.	FREQ. (MHz)	EMISSION LEVEL (dBuV/m)	LIMIT (dBuV/m)	MARGIN (dB)	ANTENNA HEIGHT (m)	TABLE ANGLE (Degree)	RAW VALUE (dBuV)	CORRECTION FACTOR (dB/m)
1	5150.00	70.4 PK	74.0	-3.6	1.11 H	347	64.40	6.00
2	5150.00	52.2 AV	54.0	-1.8	1.11 H	347	46.20	6.00
3	*5190.00	116.3 PK			1.71 H	352	76.90	39.40
4	*5190.00	102.6 AV			1.71 H	352	63.20	39.40
5	#10380.00	59.5 PK	74.0	-14.5	2.24 H	273	41.80	17.70
6	#10380.00	46.3 AV	54.0	-7.7	2.24 H	273	28.60	17.70

ANTENNA POLARITY & TEST DISTANCE: VERTICAL AT 3 M

NO.	FREQ. (MHz)	EMISSION LEVEL (dBuV/m)	LIMIT (dBuV/m)	MARGIN (dB)	ANTENNA HEIGHT (m)	TABLE ANGLE (Degree)	RAW VALUE (dBuV)	CORRECTION FACTOR (dB/m)
1	5150.00	70.2 PK	74.0	-3.8	1.41 V	345	64.20	6.00
2	5150.00	48.3 AV	54.0	-5.7	1.41 V	345	42.30	6.00
3	*5190.00	110.8 PK			1.55 V	344	71.40	39.40
4	*5190.00	100.3 AV			1.55 V	344	60.90	39.40
5	#10380.00	59.4 PK	74.0	-14.6	2.23 V	265	41.70	17.70
6	#10380.00	46.5 AV	54.0	-7.5	2.23 V	265	28.80	17.70

Remarks:

1. Emission Level(dBuV/m) = Raw Value(dBuV) + Correction Factor(dB/m)
2. Correction Factor(dB/m) = Antenna Factor(dB/m) + Cable Factor(dB)
3. The other emission levels were very low against the limit.
4. Margin value = Emission Level – Limit value
5. " \* ": Fundamental frequency.
6. " # ": The radiated frequency is out of the restricted band.

CHANNEL	TX Channel 46	DETECTOR FUNCTION	Peak (PK)
FREQUENCY RANGE	1GHz ~ 40GHz		Average (AV)

ANTENNA POLARITY & TEST DISTANCE: HORIZONTAL AT 3 M

NO.	FREQ. (MHz)	EMISSION LEVEL (dBuV/m)	LIMIT (dBuV/m)	MARGIN (dB)	ANTENNA HEIGHT (m)	TABLE ANGLE (Degree)	RAW VALUE (dBuV)	CORRECTION FACTOR (dB/m)
1	*5230.00	117.4 PK			1.26 H	337	78.50	38.90
2	*5230.00	104.8 AV			1.26 H	337	65.90	38.90
3	5350.00	56.3 PK	74.0	-17.7	1.89 H	340	50.80	5.50
4	5350.00	44.2 AV	54.0	-9.8	1.89 H	340	38.70	5.50
5	#10460.00	59.7 PK	74.0	-14.3	2.64 H	193	41.50	18.20
6	#10460.00	46.6 AV	54.0	-7.4	2.64 H	193	28.40	18.20

ANTENNA POLARITY & TEST DISTANCE: VERTICAL AT 3 M

NO.	FREQ. (MHz)	EMISSION LEVEL (dBuV/m)	LIMIT (dBuV/m)	MARGIN (dB)	ANTENNA HEIGHT (m)	TABLE ANGLE (Degree)	RAW VALUE (dBuV)	CORRECTION FACTOR (dB/m)
1	*5230.00	115.1 PK			1.69 V	348	76.20	38.90
2	*5230.00	105.9 AV			1.69 V	348	67.00	38.90
3	5350.00	56.9 PK	74.0	-17.1	2.23 V	352	51.40	5.50
4	5350.00	44.6 AV	54.0	-9.4	2.23 V	352	39.10	5.50
5	#10460.00	59.5 PK	74.0	-14.5	2.86 V	273	41.30	18.20
6	#10460.00	46.6 AV	54.0	-7.4	2.86 V	273	28.40	18.20

Remarks:

1. Emission Level(dBuV/m) = Raw Value(dBuV) + Correction Factor(dB/m)
2. Correction Factor(dB/m) = Antenna Factor(dB/m) + Cable Factor(dB)
3. The other emission levels were very low against the limit.
4. Margin value = Emission Level – Limit value
5. " \* ": Fundamental frequency.
6. " # ": The radiated frequency is out of the restricted band.

CHANNEL	TX Channel 151	DETECTOR FUNCTION	Peak (PK)
FREQUENCY RANGE	1GHz ~ 40GHz		Average (AV)

ANTENNA POLARITY & TEST DISTANCE: HORIZONTAL AT 3 M								
NO.	FREQ. (MHz)	EMISSION LEVEL (dBuV/m)	LIMIT (dBuV/m)	MARGIN (dB)	ANTENNA HEIGHT (m)	TABLE ANGLE (Degree)	RAW VALUE (dBuV)	CORRECTION FACTOR (dB/m)
1	#5615.20	57.8 PK	68.2	-10.4	1.61 H	0	51.70	6.10
2	*5755.00	114.8 PK			1.61 H	0	74.80	40.00
3	*5755.00	102.3 AV			1.61 H	0	62.30	40.00
4	#5947.20	58.9 PK	68.2	-9.3	1.61 H	0	52.30	6.60
5	11510.00	62.0 PK	74.0	-12.0	1.87 H	180	42.70	19.30
6	11510.00	47.6 AV	54.0	-6.4	1.87 H	180	28.30	19.30
ANTENNA POLARITY & TEST DISTANCE: VERTICAL AT 3 M								
NO.	FREQ. (MHz)	EMISSION LEVEL (dBuV/m)	LIMIT (dBuV/m)	MARGIN (dB)	ANTENNA HEIGHT (m)	TABLE ANGLE (Degree)	RAW VALUE (dBuV)	CORRECTION FACTOR (dB/m)
1	#5643.20	57.9 PK	68.2	-10.3	1.24 V	357	51.80	6.10
2	*5755.00	113.3 PK			1.24 V	357	73.30	40.00
3	*5755.00	99.7 AV			1.24 V	357	59.70	40.00
4	#5940.00	59.7 PK	68.2	-8.5	1.24 V	357	53.10	6.60
5	11510.00	61.4 PK	74.0	-12.6	1.68 V	284	42.10	19.30
6	11510.00	47.7 AV	54.0	-6.3	1.68 V	284	28.40	19.30

Remarks:

1. Emission Level(dBuV/m) = Raw Value(dBuV) + Correction Factor(dB/m)
2. Correction Factor(dB/m) = Antenna Factor(dB/m) + Cable Factor(dB)
3. The other emission levels were very low against the limit.
4. Margin value = Emission Level – Limit value
5. " \* ": Fundamental frequency.
6. " # ": The radiated frequency is out of the restricted band.

CHANNEL	TX Channel 159	DETECTOR FUNCTION	Peak (PK)
FREQUENCY RANGE	1GHz ~ 40GHz		Average (AV)

**ANTENNA POLARITY & TEST DISTANCE: HORIZONTAL AT 3 M**

NO.	FREQ. (MHz)	EMISSION LEVEL (dBuV/m)	LIMIT (dBuV/m)	MARGIN (dB)	ANTENNA HEIGHT (m)	TABLE ANGLE (Degree)	RAW VALUE (dBuV)	CORRECTION FACTOR (dB/m)
1	#5608.80	57.9 PK	68.2	-10.3	1.33 H	9	51.80	6.10
2	*5795.00	114.6 PK			1.33 H	9	74.50	40.10
3	*5795.00	101.9 AV			1.33 H	9	61.80	40.10
4	#5976.80	58.9 PK	68.2	-9.3	1.33 H	9	52.20	6.70
5	11590.00	60.6 PK	74.0	-13.4	1.74 H	186	41.40	19.20
6	11590.00	47.5 AV	54.0	-6.5	1.74 H	186	28.30	19.20

**ANTENNA POLARITY & TEST DISTANCE: VERTICAL AT 3 M**

NO.	FREQ. (MHz)	EMISSION LEVEL (dBuV/m)	LIMIT (dBuV/m)	MARGIN (dB)	ANTENNA HEIGHT (m)	TABLE ANGLE (Degree)	RAW VALUE (dBuV)	CORRECTION FACTOR (dB/m)
1	#5611.20	57.4 PK	68.2	-10.8	1.21 V	358	51.30	6.10
2	*5795.00	111.7 PK			1.21 V	358	71.60	40.10
3	*5795.00	101.0 AV			1.21 V	358	60.90	40.10
4	#5984.00	58.5 PK	68.2	-9.7	1.21 V	358	51.80	6.70
5	11590.00	60.4 PK	74.0	-13.6	1.68 V	126	41.20	19.20
6	11590.00	47.6 AV	54.0	-6.4	1.68 V	126	28.40	19.20

Remarks:

1. Emission Level(dBuV/m) = Raw Value(dBuV) + Correction Factor(dB/m)
2. Correction Factor(dB/m) = Antenna Factor(dB/m) + Cable Factor(dB)
3. The other emission levels were very low against the limit.
4. Margin value = Emission Level – Limit value
5. " \* ": Fundamental frequency.
6. " # ": The radiated frequency is out of the restricted band.



802.11ac (VHT80)

CHANNEL	TX Channel 42	DETECTOR FUNCTION	Peak (PK)
FREQUENCY RANGE	1GHz ~ 40GHz		Average (AV)

ANTENNA POLARITY & TEST DISTANCE: HORIZONTAL AT 3 M

NO.	FREQ. (MHz)	EMISSION LEVEL (dBuV/m)	LIMIT (dBuV/m)	MARGIN (dB)	ANTENNA HEIGHT (m)	TABLE ANGLE (Degree)	RAW VALUE (dBuV)	CORRECTION FACTOR (dB/m)
1	5150.00	71.8 PK	74.0	-2.2	1.89 H	0	65.80	6.00
2	5150.00	50.5 AV	54.0	-3.5	1.89 H	0	44.50	6.00
3	*5210.00	110.1 PK			1.88 H	4	70.60	39.50
4	*5210.00	98.2 AV			1.88 H	4	58.70	39.50
5	5350.00	57.3 PK	74.0	-16.7	2.01 H	22	50.80	6.50
6	5350.00	44.0 AV	54.0	-10.0	2.01 H	22	37.50	6.50
7	#10420.00	59.6 PK	74.0	-14.4	1.95 H	183	41.70	17.90
8	#10420.00	46.6 AV	54.0	-7.4	1.95 H	183	28.70	17.90

ANTENNA POLARITY & TEST DISTANCE: VERTICAL AT 3 M

NO.	FREQ. (MHz)	EMISSION LEVEL (dBuV/m)	LIMIT (dBuV/m)	MARGIN (dB)	ANTENNA HEIGHT (m)	TABLE ANGLE (Degree)	RAW VALUE (dBuV)	CORRECTION FACTOR (dB/m)
1	5150.00	66.6 PK	74.0	-7.4	1.48 V	344	60.60	6.00
2	5150.00	48.1 AV	54.0	-5.9	1.48 V	344	42.10	6.00
3	*5210.00	106.6 PK			1.46 V	359	67.10	39.50
4	*5210.00	95.0 AV			1.46 V	359	55.50	39.50
5	5350.00	57.6 PK	74.0	-16.4	1.57 V	325	51.10	6.50
6	5350.00	44.1 AV	54.0	-9.9	1.57 V	325	37.60	6.50
7	#10420.00	59.5 PK	74.0	-14.5	2.23 V	229	41.60	17.90
8	#10420.00	46.6 AV	54.0	-7.4	2.23 V	229	28.70	17.90

Remarks:

1. Emission Level(dBuV/m) = Raw Value(dBuV) + Correction Factor(dB/m)
2. Correction Factor(dB/m) = Antenna Factor(dB/m) + Cable Factor(dB)
3. The other emission levels were very low against the limit.
4. Margin value = Emission Level – Limit value
5. " \* ": Fundamental frequency.
6. " # ": The radiated frequency is out of the restricted band.

CHANNEL	TX Channel 155	DETECTOR FUNCTION	Peak (PK)
FREQUENCY RANGE	1GHz ~ 40GHz		Average (AV)

ANTENNA POLARITY & TEST DISTANCE: HORIZONTAL AT 3 M								
NO.	FREQ. (MHz)	EMISSION LEVEL (dBuV/m)	LIMIT (dBuV/m)	MARGIN (dB)	ANTENNA HEIGHT (m)	TABLE ANGLE (Degree)	RAW VALUE (dBuV)	CORRECTION FACTOR (dB/m)
1	#5640.00	57.9 PK	68.2	-10.3	1.66 H	326	51.80	6.10
2	*5775.00	109.3 PK			1.66 H	326	69.30	40.00
3	*5775.00	97.3 AV			1.66 H	326	57.30	40.00
4	#5964.00	58.6 PK	68.2	-9.6	1.66 H	326	51.90	6.70
5	11550.00	60.7 PK	74.0	-13.3	1.64 H	284	41.50	19.20
6	11550.00	47.6 AV	54.0	-6.4	1.64 H	284	28.40	19.20

ANTENNA POLARITY & TEST DISTANCE: VERTICAL AT 3 M								
NO.	FREQ. (MHz)	EMISSION LEVEL (dBuV/m)	LIMIT (dBuV/m)	MARGIN (dB)	ANTENNA HEIGHT (m)	TABLE ANGLE (Degree)	RAW VALUE (dBuV)	CORRECTION FACTOR (dB/m)
1	#5641.60	58.5 PK	68.2	-9.7	2.79 V	3	52.40	6.10
2	*5775.00	105.3 PK			2.79 V	3	65.30	40.00
3	*5775.00	94.1 AV			2.79 V	3	54.10	40.00
4	#5947.20	58.9 PK	68.2	-9.3	2.79 V	3	52.30	6.60
5	11550.00	61.2 PK	74.0	-12.8	1.96 V	201	42.00	19.20
6	11550.00	47.4 AV	54.0	-6.6	1.96 V	201	28.20	19.20

Remarks:

1. Emission Level(dBuV/m) = Raw Value(dBuV) + Correction Factor(dB/m)
2. Correction Factor(dB/m) = Antenna Factor(dB/m) + Cable Factor(dB)
3. The other emission levels were very low against the limit.
4. Margin value = Emission Level – Limit value
5. " \* ": Fundamental frequency.
6. " # ": The radiated frequency is out of the restricted band.

Below 1GHz Worst-Case Data:

CDD Mode

802.11a

CHANNEL	TX Channel 36	DETECTOR FUNCTION	Quasi-Peak (QP)
FREQUENCY RANGE	30MHz ~ 1GHz		

ANTENNA POLARITY & TEST DISTANCE: HORIZONTAL AT 3 M								
NO.	FREQ. (MHz)	EMISSION LEVEL (dBuV/m)	LIMIT (dBuV/m)	MARGIN (dB)	ANTENNA HEIGHT (m)	TABLE ANGLE (Degree)	RAW VALUE (dBuV)	CORRECTION FACTOR (dB/m)
1	57.12	30.7 QP	40.0	-9.3	2.00 H	197	45.30	-14.60
2	140.72	27.8 QP	43.5	-15.7	2.00 H	102	42.30	-14.50
3	167.94	29.1 QP	43.5	-14.4	1.50 H	279	43.20	-14.10
4	294.32	25.4 QP	46.0	-20.6	1.00 H	252	37.80	-12.40
5	350.71	25.3 QP	46.0	-20.7	1.00 H	130	36.60	-11.30
6	399.31	25.5 QP	46.0	-20.5	1.00 H	127	35.70	-10.20
ANTENNA POLARITY & TEST DISTANCE: VERTICAL AT 3 M								
NO.	FREQ. (MHz)	EMISSION LEVEL (dBuV/m)	LIMIT (dBuV/m)	MARGIN (dB)	ANTENNA HEIGHT (m)	TABLE ANGLE (Degree)	RAW VALUE (dBuV)	CORRECTION FACTOR (dB/m)
1	47.40	35.9 QP	40.0	-4.1	1.00 V	18	50.40	-14.50
2	80.45	31.0 QP	40.0	-9.0	1.00 V	186	49.70	-18.70
3	154.33	29.0 QP	43.5	-14.5	1.00 V	154	42.80	-13.80
4	177.67	29.4 QP	43.5	-14.1	1.00 V	153	44.20	-14.80
5	235.99	27.5 QP	46.0	-18.5	1.00 V	171	42.70	-15.20
6	498.47	28.5 QP	46.0	-17.5	1.00 V	264	36.70	-8.20

Remarks:

1. Emission Level(dBuV/m) = Raw Value(dBuV) + Correction Factor(dB/m)
2. Correction Factor(dB/m) = Antenna Factor(dB/m) + Cable Factor(dB)
3. The other emission levels were very low against the limit.
4. Margin value = Emission Level – Limit value

## 4.2 Conducted Emission Measurement

### 4.2.1 Limits of Conducted Emission Measurement

Frequency (MHz)	Conducted Limit (dBuV)	
	Quasi-peak	Average
0.15 - 0.5	66 - 56	56 - 46
0.50 - 5.0	56	46
5.0 - 30.0	60	50

- Note:** 1. The lower limit shall apply at the transition frequencies.  
 2. The limit decreases in line with the logarithm of the frequency in the range of 0.15 to 0.50MHz.

### 4.2.2 Test Instruments

Description & Manufacturer	Model No.	Serial No.	Cal. Date	Cal. Due
Test Receiver ROHDE & SCHWARZ	ESCS30	100289	Dec. 23, 2015	Dec. 22, 2016
RF signal cable (with 10dB PAD) Woken	5D-FB	Cable-cond2-01	Dec. 26, 2015	Dec. 25, 2016
LISN ROHDE & SCHWARZ (EUT)	ESH2-Z5	100100	Jan. 11, 2016	Jan. 10, 2017
LISN ROHDE & SCHWARZ (Peripheral)	ESH3-Z5	100312	Jul. 26, 2016	Jul. 25, 2017
Software ADT	BV ADT_Cond_ V7.3.7.3	NA	NA	NA

- Note:** 1. The calibration interval of the above test instruments is 12 months and the calibrations are traceable to NML/ROC and NIST/USA.  
 2. The test was performed in HwaYa Shielded Room 2.  
 3. The VCCI Site Registration No. is C-2047.

#### 4.2.3 Test Procedures

- The EUT was placed 0.4 meters from the conducting wall of the shielded room with EUT being connected to the power mains through a line impedance stabilization network (LISN). Other support units were connected to the power mains through another LISN. The two LISNs provide 50 ohm/ 50uH of coupling impedance for the measuring instrument.
- Both lines of the power mains connected to the EUT were checked for maximum conducted interference.
- The frequency range from 150kHz to 30MHz was searched. Emission levels under (Limit - 20dB) was not recorded.

**NOTE:** The resolution bandwidth and video bandwidth of test receiver is 9kHz for quasi-peak detection (QP) and average detection (AV) at frequency 0.15MHz-30MHz.

#### 4.2.4 Deviation from Test Standard

No deviation.

#### 4.2.5 Test Setup

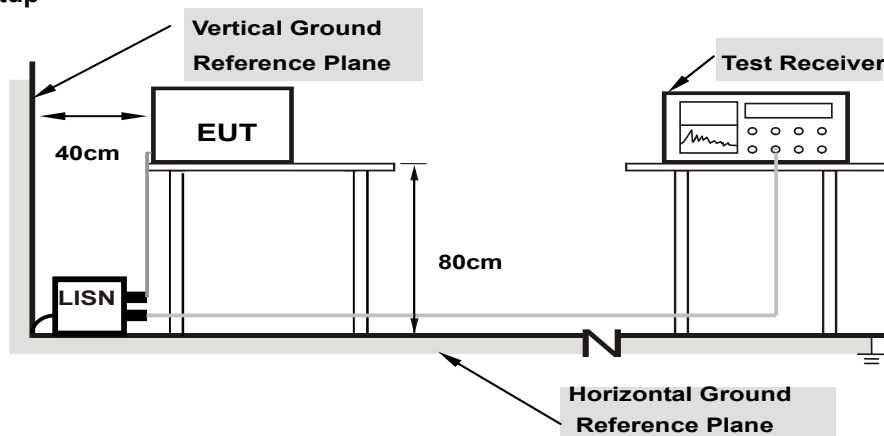

**Note:** 1.Support units were connected to second LISN.

For the actual test configuration, please refer to the attached file (Test Setup Photo).

#### 4.2.6 EUT Operating Conditions

Same as 4.1.6.

### 4.2.7 Test Results

#### CDD Mode

Phase	Line (L)	Detector Function	Quasi-Peak (QP) / Average (AV)
-------	----------	-------------------	--------------------------------

No	Freq. [MHz]	Corr. Factor (dB)	Reading Value [dB (uV)]		Emission Level [dB (uV)]		Limit [dB (uV)]		Margin (dB)	
			Q.P.	AV.	Q.P.	AV.	Q.P.	AV.	Q.P.	AV.
			1	0.15000	10.12	35.19	22.94	45.31	33.06	66.00
2	0.16562	10.13	32.99	22.39	43.12	32.52	65.18	55.18	-22.06	-22.66
3	0.40391	10.19	25.25	19.48	35.44	29.67	57.77	47.77	-22.33	-18.10
4	4.54297	10.36	19.08	17.24	29.44	27.60	56.00	46.00	-26.56	-18.40
5	16.41016	10.56	25.61	25.58	36.17	36.14	60.00	50.00	-23.83	-13.86
6	25.75000	10.49	27.69	25.78	38.18	36.27	60.00	50.00	-21.82	-13.73

#### Remarks:

1. Q.P. and AV. are abbreviations of quasi-peak and average individually.
2. The emission levels of other frequencies were very low against the limit.
3. Margin value = Emission level - Limit value
4. Correction factor = Insertion loss + Cable loss
5. Emission Level = Correction Factor + Reading Value.

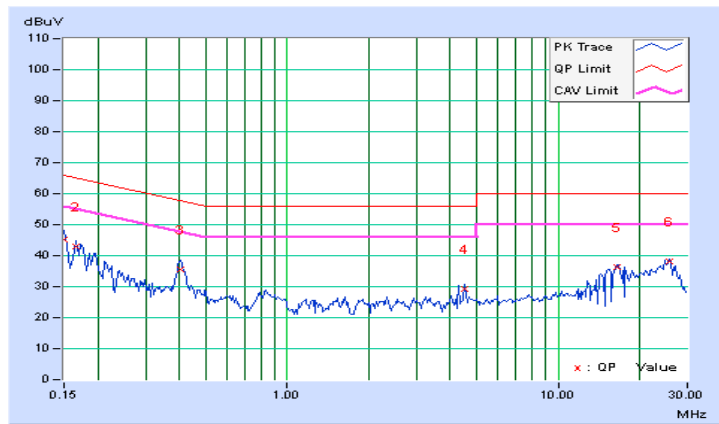

Phase	Neutral (N)	Detector Function	Quasi-Peak (QP) / Average (AV)
-------	-------------	-------------------	--------------------------------

No	Freq. [MHz]	Corr. Factor (dB)	Reading Value [dB (uV)]		Emission Level [dB (uV)]		Limit [dB (uV)]		Margin (dB)	
			Q.P.	AV.	Q.P.	AV.	Q.P.	AV.	Q.P.	AV.
			1	0.15000	10.13	35.19	22.58	45.32	32.71	66.00
2	0.16953	10.14	32.42	22.81	42.56	32.95	64.98	54.98	-22.42	-22.03
<b>3</b>	<b>0.40000</b>	<b>10.19</b>	<b>28.38</b>	<b>27.90</b>	<b>38.57</b>	<b>38.09</b>	<b>57.85</b>	<b>47.85</b>	<b>-19.28</b>	<b>-9.76</b>
4	4.29297	10.40	20.39	19.84	30.79	30.24	56.00	46.00	-25.21	-15.76
5	16.66406	10.70	25.95	25.69	36.65	36.39	60.00	50.00	-23.35	-13.61
6	25.75391	10.64	27.62	26.90	38.26	37.54	60.00	50.00	-21.74	-12.46

Remarks:

1. Q.P. and AV. are abbreviations of quasi-peak and average individually.
2. The emission levels of other frequencies were very low against the limit.
3. Margin value = Emission level - Limit value
4. Correction factor = Insertion loss + Cable loss
5. Emission Level = Correction Factor + Reading Value.

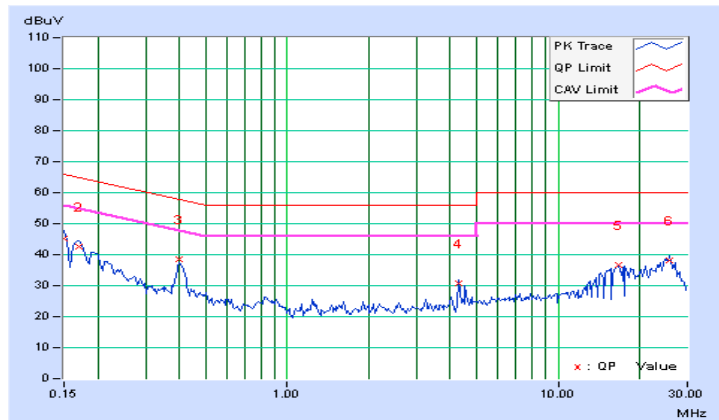

### 4.3 Transmit Power Measurement

#### 4.3.1 Limits of Transmit Power Measurement

Operation Band	EUT Category		LIMIT
U-NII-1		Outdoor Access Point	1 Watt (30 dBm) (Max. e.i.r.p $\leq$ 125mW(21 dBm) at any elevation angle above 30 degrees as measured from the horizon)
		Fixed point-to-point Access Point	1 Watt (30 dBm)
	√	Indoor Access Point	1 Watt (30 dBm)
		Mobile and Portable client device	250mW (24 dBm)
U-NII-2A	---		250mW (24 dBm) or 11 dBm+10 log B*
U-NII-2C	---		250mW (24 dBm) or 11 dBm+10 log B*
U-NII-3	√		1 Watt (30 dBm)

\*B is the 26 dB emission bandwidth in megahertz

Per KDB 662911 Method of conducted output power measurement on IEEE 802.11 devices,

Array Gain = 0 dB (i.e., no array gain) for  $N_{ANT} \leq 4$ ;

Array Gain = 0 dB (i.e., no array gain) for channel widths  $\geq 40$  MHz for any  $N_{ANT}$ ;

Array Gain =  $5 \log(N_{ANT}/N_{SS})$  dB or 3 dB, whichever is less for 20-MHz channel widths with  $N_{ANT} \geq 5$ .

For power measurements on all other devices: Array Gain =  $10 \log(N_{ANT}/N_{SS})$  dB.

#### 4.3.2 Test Setup

For Power Output Measurement

802.11a, 802.11n (HT20), 802.11n (HT40)

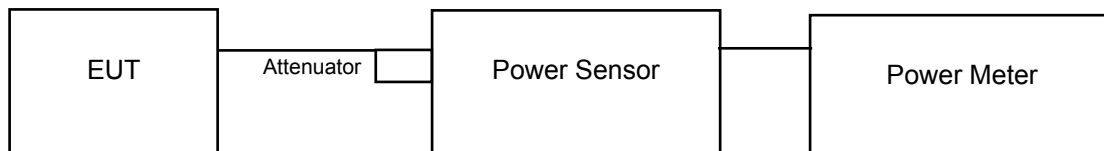

802.11ac (VHT80)

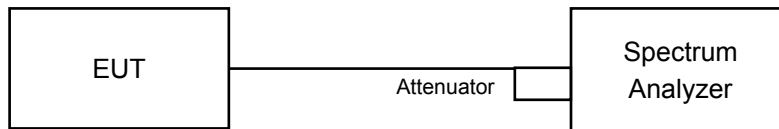

For 26dB Bandwidth

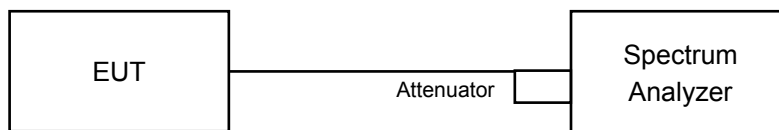

#### 4.3.3 Test Instruments

Refer to section 4.1.2 to get information of above instrument.



#### 4.3.4 Test Procedure

##### For Average Power Measurement

##### For 802.11a, 802.11n (HT20), 802.11n (HT40)

Method PM is used to perform output power measurement, trigger and gating function of wide band power meter is enabled to measure max output power of TX on burst. Duty factor is not added to measured value.

##### For 802.11ac (VHT80)

- a. Set span to encompass the entire 26 dB EBW (or, alternatively, the entire 99% occupied bandwidth) of the signal.
- b. Set sweep trigger to "free run".
- c. Set RBW = 1 MHz.
- d. Set VBW  $\geq$  3 MHz
- e. Number of points in sweep  $\geq$  2 Span / RBW.
- f. Sweep time  $\leq$  (number of points in sweep) \* T
- g. Using emission bandwidth to determine the frequency span for integration the channel bandwidth.
- h. Detector = RMS.
- i. Trace mode = max hold.
- j. Allow max hold to run for at least 60 seconds, or longer as needed to allow the trace to stabilize.
- k. Compute power by integrating the spectrum across the EBW (or, alternatively, the entire 99% occupied bandwidth) of the signal using the instrument's band power measurement function with band limits set equal to the EBW (or occupied bandwidth) band edges. If the instrument does not have a band power function, sum the spectrum levels (in power units) at 1 MHz intervals extending across the EBW (or, alternatively, the entire 99% occupied bandwidth) of the spectrum.

##### For 26dB Bandwidth

- a. Set RBW = approximately 1% of the emission bandwidth.
- b. Set the VBW > RBW.
- c. Detector = Peak.
- d. Trace mode = max hold.
- e. Measure the maximum width of the emission that is 26 dB down from the peak of the emission. Compare this with the RBW setting of the analyzer. Readjust RBW and repeat measurement as needed until the RBW/EBW ratio is approximately 1%.

#### 4.3.5 Deviation from Test Standard

No deviation.

#### 4.3.6 EUT Operating Conditions

The software provided by client to enable the EUT under transmission condition continuously at lowest, middle and highest channel frequencies individually.

#### 4.3.7 Test Result

Power Output:

CDD Mode

802.11a

Chan.	Freq. (MHz)	Maximum Conducted Power (dBm)		Total Power (mW)	Total Power (dBm)	Power Limit (dBm)	Pass / Fail
		Chain 0	Chain 1				
36	5180	19.83	20.10	198.49	22.98	30	Pass
40	5200	19.93	20.15	<b>201.915</b>	23.05	30	Pass
48	5240	19.70	19.83	189.486	22.78	30	Pass
149	5745	19.50	19.78	184.185	22.65	30	Pass
157	5785	19.70	19.76	187.949	22.74	30	Pass
165	5825	19.75	19.82	190.346	22.80	30	Pass

802.11n (HT20)

Chan.	Freq. (MHz)	Maximum Conducted Power (dBm)		Total Power (mW)	Total Power (dBm)	Power Limit (dBm)	Pass / Fail
		Chain 0	Chain 1				
36	5180	19.60	19.58	181.983	22.60	30	Pass
40	5200	19.89	20.10	199.828	23.01	30	Pass
48	5240	19.70	19.88	190.600	22.80	30	Pass
149	5745	19.64	19.74	186.234	22.70	30	Pass
157	5785	19.86	19.85	193.433	22.87	30	Pass
165	5825	19.87	19.85	193.656	22.87	30	Pass

802.11n (HT40)

Chan.	Freq. (MHz)	Maximum Conducted Power (dBm)		Total Power (mW)	Total Power (dBm)	Power Limit (dBm)	Pass / Fail
		Chain 0	Chain 1				
38	5190	17.06	17.28	104.272	20.18	30	Pass
46	5230	19.82	20.08	197.799	22.96	30	Pass
151	5755	19.85	19.78	191.665	22.83	30	Pass
159	5795	20.02	19.80	<b>195.961</b>	22.92	30	Pass

802.11ac (VHT80)

Chan.	Freq. (MHz)	Maximum Conducted Power (dBm)		Total Power (mW)	Total Power (dBm)	Power Limit (dBm)	Pass / Fail
		Chain 0	Chain 1				
42	5210	16.13	16.43	84.974	19.29	30	Pass
155	5775	18.66	18.70	147.582	21.69	30	Pass

### Beamforming Mode

#### 802.11n (HT20)

Chan.	Freq. (MHz)	Maximum Conducted Power (dBm)		Total Power (mW)	Total Power (dBm)	Power Limit (dBm)	Pass / Fail
		Chain 0	Chain 1				
36	5180	19.09	18.83	157.48	21.97	27.13	Pass
40	5200	19.90	19.80	<b>193.223</b>	22.86	27.13	Pass
48	5240	19.79	19.32	180.787	22.57	27.13	Pass
149	5745	20.31	19.80	202.898	23.07	27.13	Pass
157	5785	20.24	19.97	204.994	23.12	27.13	Pass
165	5825	20.34	19.80	203.642	23.09	27.13	Pass

Note: Directional gain =  $10 \log[(10^{G1/20} + 10^{G2/20} + \dots + 10^{GN/20})^2/2] = 8.87 \text{ dBi} > 6\text{dBi}$ , so the power limit shall be reduced to  $30 - (8.87 - 6) = 27.13\text{dBm}$ .

#### 802.11n (HT40)

Chan.	Freq. (MHz)	Maximum Conducted Power (dBm)		Total Power (mW)	Total Power (dBm)	Power Limit (dBm)	Pass / Fail
		Chain 0	Chain 1				
38	5190	16.14	16.17	82.515	19.17	27.13	Pass
46	5230	19.92	19.70	191.500	22.82	27.13	Pass
151	5755	20.24	19.81	201.401	23.04	27.13	Pass
159	5795	20.22	20.00	<b>205.196</b>	23.12	27.13	Pass

Note: Directional gain =  $10 \log[(10^{G1/20} + 10^{G2/20} + \dots + 10^{GN/20})^2/2] = 8.87 \text{ dBi} > 6\text{dBi}$ , so the power limit shall be reduced to  $30 - (8.87 - 6) = 27.13\text{dBm}$ .

#### 802.11ac (VHT80)

Chan.	Freq. (MHz)	Maximum Conducted Power (dBm)		Total Power (mW)	Total Power (dBm)	Power Limit (dBm)	Pass / Fail
		Chain 0	Chain 1				
42	5210	15.78	15.93	77.018	18.87	27.13	Pass
155	5775	19.31	18.82	161.518	22.08	27.13	Pass

Note: Directional gain =  $10 \log[(10^{G1/20} + 10^{G2/20} + \dots + 10^{GN/20})^2/2] = 8.87 \text{ dBi} > 6\text{dBi}$ , so the power limit shall be reduced to  $30 - (8.87 - 6) = 27.13\text{dBm}$ .

26dB Bandwidth:

CDD Mode

802.11a

Chan.	Freq. (MHz)	26dBc Bandwidth (MHz)		Pass / Fail
		Chain 0	Chain 1	
36	5180	19.97	19.36	Pass
40	5200	20.26	19.64	Pass
48	5240	19.62	19.24	Pass

802.11n (HT20)

Chan.	Freq. (MHz)	26dBc Bandwidth (MHz)		Pass / Fail
		Chain 0	Chain 1	
36	5180	20.46	20.42	Pass
40	5200	20.61	20.50	Pass
48	5240	20.79	20.37	Pass

802.11n (HT40)

Chan.	Freq. (MHz)	26dBc Bandwidth (MHz)		Pass / Fail
		Chain 0	Chain 1	
38	5190	40.74	40.55	Pass
46	5230	40.82	40.77	Pass

802.11ac (VHT80)

Chan.	Freq. (MHz)	26dBc Bandwidth (MHz)		Pass / Fail
		Chain 0	Chain 1	
42	5210	84.50	83.43	Pass

**Spectrum Plot of Worst Value**

**802.11a**

**802.11n (HT20)**

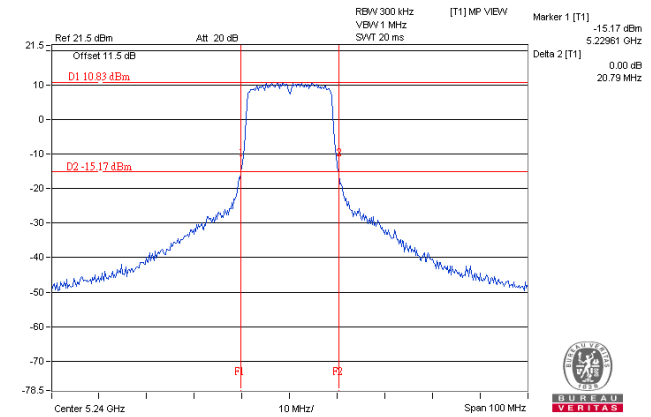
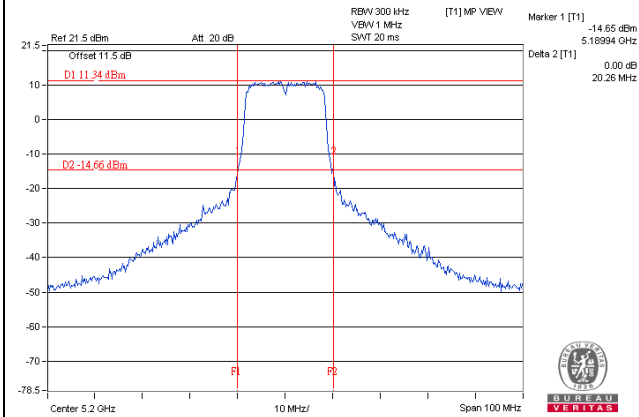

**802.11n (HT40)**

**802.11ac (VHT80)**

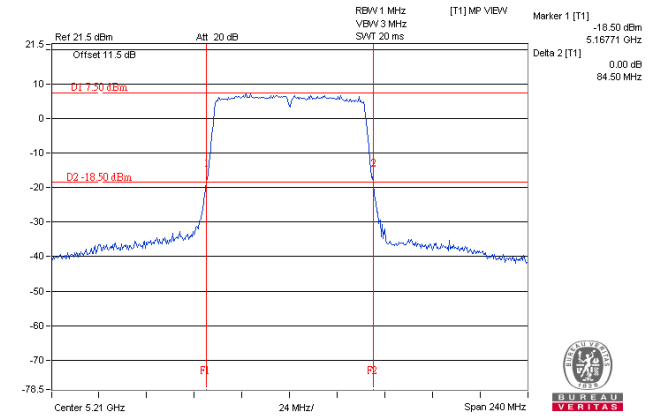
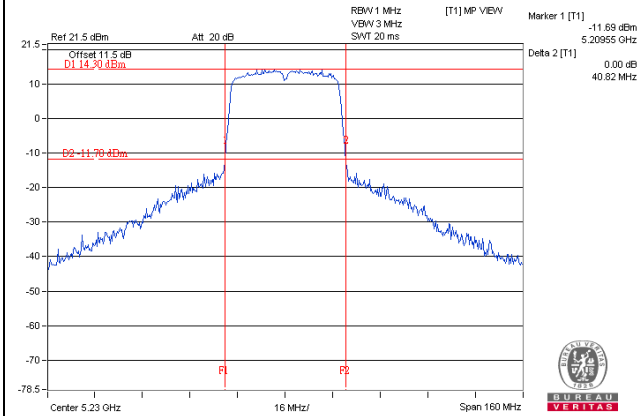

### Beamforming Mode

#### 802.11n (HT20)

Chan.	Freq. (MHz)	26dBc Bandwidth (MHz)		Pass / Fail
		Chain 0	Chain 1	
36	5180	20.36	20.45	Pass
40	5200	20.42	20.43	Pass
48	5240	20.35	20.50	Pass

#### 802.11n (HT40)

Chan.	Freq. (MHz)	26dBc Bandwidth (MHz)		Pass / Fail
		Chain 0	Chain 1	
38	5190	40.72	40.79	Pass
46	5230	40.93	41.00	Pass

#### 802.11ac (VHT80)

Chan.	Freq. (MHz)	26dBc Bandwidth (MHz)		Pass / Fail
		Chain 0	Chain 1	
42	5210	84.10	83.84	Pass

**Spectrum Plot of Worst Value**

**802.11n (HT20)**

**802.11n (HT40)**

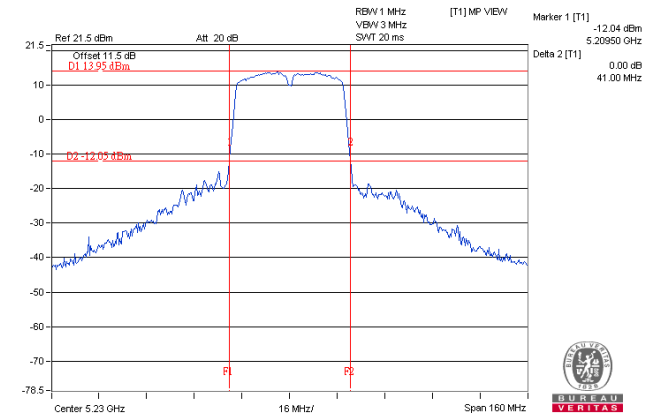
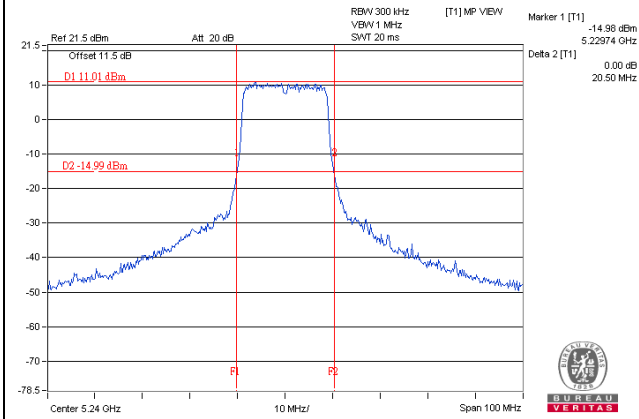

**802.11ac (VHT80)**

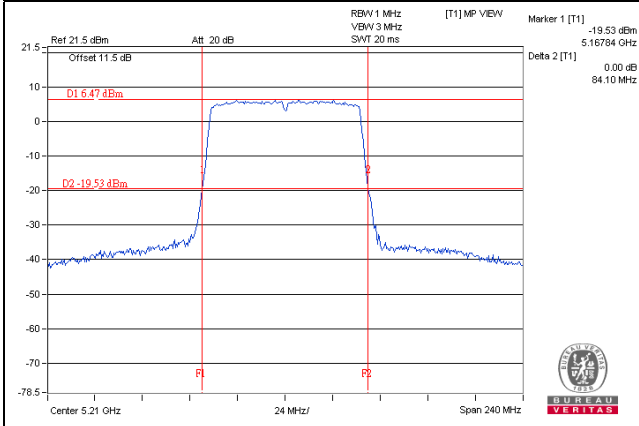

## 4.4 Occupied Bandwidth Measurement

### 4.4.1 Test Setup

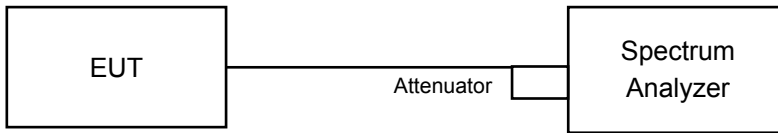

### 4.4.2 Test Instruments

Refer to section 4.1.2 to get information of above instrument.

### 4.4.3 Test Procedure

The transmitter output was connected to the spectrum analyzer through an attenuator. The bandwidth of the fundamental frequency was measured by spectrum analyzer with resolution bandwidth in the range of 1% to 5% of the anticipated emission bandwidth, and a video bandwidth at least 3x the resolution bandwidth and set the detector to Sample. The width of a frequency band such that, below the lower and above the upper frequency limits, the mean powers emitted are each equal to a specified percentage 0.5 %of the total mean power of a given emission.



#### 4.4.4 Test Result

##### CDD Mode

##### 802.11a

Chan.	Freq. (MHz)	Occupied Bandwidth (MHz)	
		Chain 0	Chain 1
36	5180	16.44	16.44
40	5200	16.44	16.44
48	5240	16.44	16.44
149	5745	16.52	16.43
157	5785	16.56	16.44
165	5825	16.56	16.44

##### 802.11n (HT20)

Chan.	Freq. (MHz)	Occupied Bandwidth (MHz)	
		Chain 0	Chain 1
36	5180	17.64	17.64
40	5200	17.76	17.64
48	5240	17.64	17.64
149	5745	17.76	17.64
157	5785	17.64	17.64
165	5825	17.76	17.64

##### 802.11n (HT40)

Chan.	Freq. (MHz)	Occupied Bandwidth (MHz)	
		Chain 0	Chain 1
38	5190	36.12	36.24
46	5230	36.24	36.12
151	5755	36.24	36.36
159	5795	36.24	36.24

##### 802.11ac (VHT80)

Chan.	Freq. (MHz)	Occupied Bandwidth (MHz)	
		Chain 0	Chain 1
42	5210	75.88	75.88
155	5775	75.88	76.08

### Spectrum Plot of Worst Value

802.11a

802.11n (HT20)

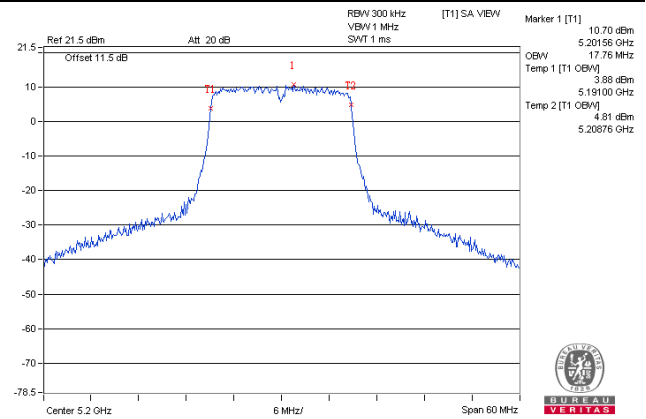
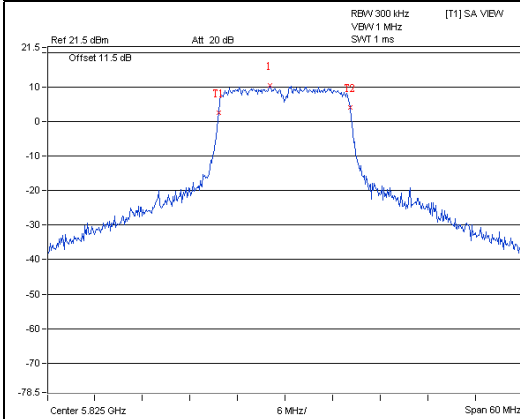

802.11n (HT40)

802.11ac (VHT80)

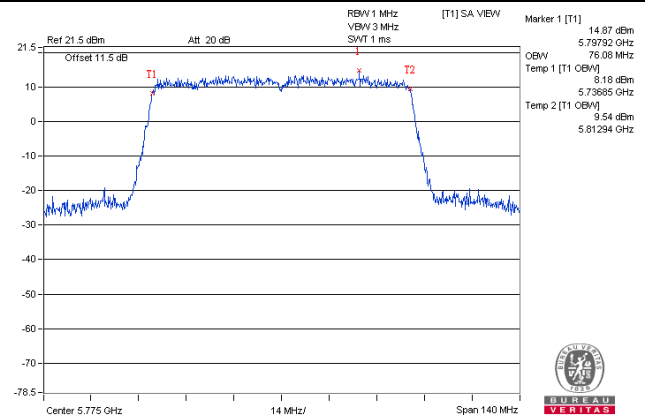
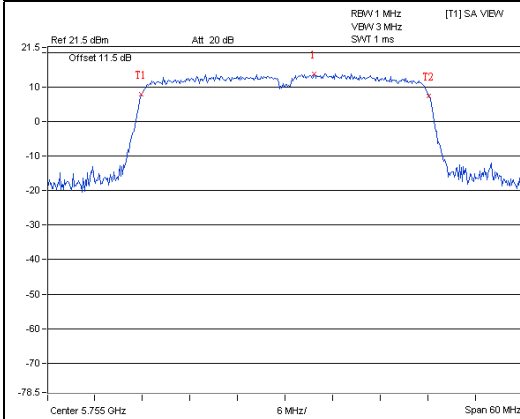

Beamforming Mode

802.11n (HT20)

Chan.	Freq. (MHz)	Occupied Bandwidth (MHz)	
		Chain 0	Chain 1
36	5180	17.64	17.64
40	5200	17.64	17.64
48	5240	17.64	17.64
149	5745	17.56	17.56
157	5785	17.64	17.64
165	5825	17.64	17.64

802.11n (HT40)

Chan.	Freq. (MHz)	Occupied Bandwidth (MHz)	
		Chain 0	Chain 1
38	5190	36.12	36.12
46	5230	36.12	36.12
151	5755	36.12	36.12
159	5795	36.12	36.12

802.11ac (VHT80)

Chan.	Freq. (MHz)	Occupied Bandwidth (MHz)	
		Chain 0	Chain 1
42	5210	75.88	75.60
155	5775	75.88	75.88

### Spectrum Plot of Worst Value

802.11n (HT20)

802.11n (HT40)

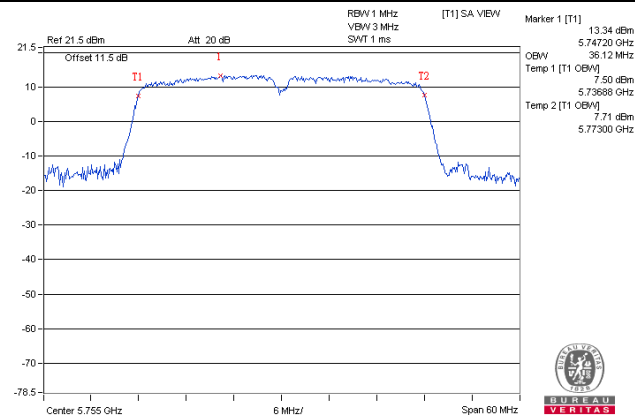
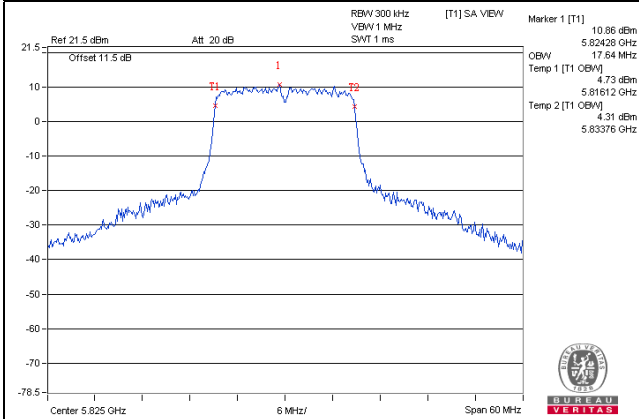

802.11ac (VHT80)

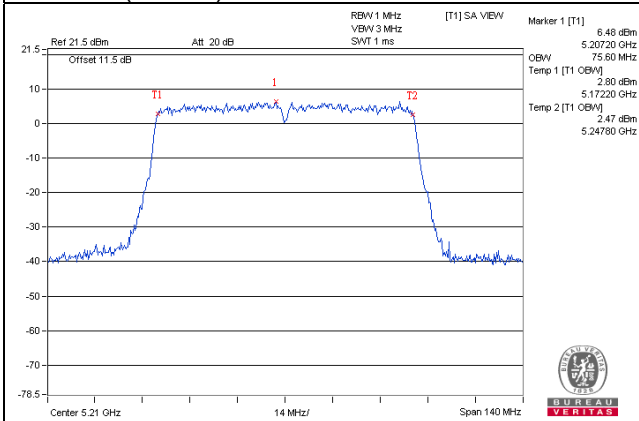

## 4.5 Peak Power Spectral Density Measurement

### 4.5.1 Limits of Peak Power Spectral Density Measurement

Operation Band	EUT Category		LIMIT
U-NII-1		Outdoor Access Point	17dBm/ MHz
		Fixed point-to-point Access Point	
	√	Indoor Access Point	11dBm/ MHz
		Mobile and Portable client device	
U-NII-2A	---		11dBm/ MHz
U-NII-2C	---		11dBm/ MHz
U-NII-3	√		30dBm/ 500kHz

### 4.5.2 Test Setup

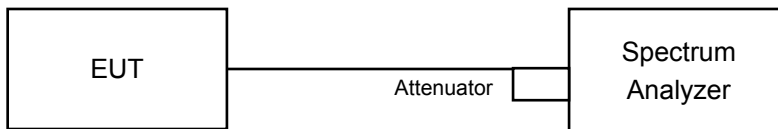

### 4.5.3 Test Instruments

Refer to section 4.1.2 to get information of above instrument.

#### 4.5.4 Test Procedures

##### For U-NII-1 band:

Using method SA-1, Duty cycle >98%:

- a. Set span to encompass the entire emission bandwidth (EBW) of the signal.
- b. Set RBW = 1 MHz, Set VBW  $\geq$  3 MHz, Detector = RMS
- c. Sweep time = auto, trigger set to "free run".
- d. Trace average at least 100 traces in power averaging mode.
- e. Record the max value

Using method SA-2, Duty cycle <98%

- a. Set span to encompass the entire emission bandwidth (EBW) of the signal.
- b. Set RBW = 1 MHz, Set VBW  $\geq$  3 MHz, Detector = RMS
- c. Sweep time = auto, trigger set to "free run".
- d. Trace average at least 100 traces in power averaging mode.
- e. Record the max value and add  $10 \log (1/\text{duty cycle})$

##### For U-NII-3 band:

Duty cycle >98%

- a. Set span to encompass the entire emission bandwidth (EBW) of the signal.
- b. Set RBW = 300 kHz, Set VBW  $\geq$  1 MHz, Detector = RMS
- c. Use the peak marker function to determine the maximum power level in any 300 kHz band segment within the fundamental EBW.
- d. Scale the observed power level to an equivalent value in 500 kHz by adjusting (reducing) the measured power by a bandwidth correction factor (BWCF) where  $\text{BWCF} = 10\log(500 \text{ kHz}/300\text{kHz})$
- e. Sweep time = auto, trigger set to "free run".
- f. Trace average at least 100 traces in power averaging mode.
- g. Record the max value

Duty cycle <98%

- a. Set span to encompass the entire emission bandwidth (EBW) of the signal.
- b. Set RBW = 300 kHz, Set VBW  $\geq$  1 MHz, Detector = RMS
- c. Use the peak marker function to determine the maximum power level in any 300 kHz band segment within the fundamental EBW.
- d. Scale the observed power level to an equivalent value in 500 kHz by adjusting (reducing) the measured power by a bandwidth correction factor (BWCF) where  $\text{BWCF} = 10\log(500 \text{ kHz}/300\text{kHz})$
- e. Sweep time = auto, trigger set to "free run".
- f. Trace average at least 100 traces in power averaging mode.
- g. Record the max value and add  $10 \log (1/\text{duty cycle})$

#### 4.5.5 Deviation from Test Standard

No deviation.

#### 4.5.6 EUT Operating Conditions

Same as Item 4.3.6.

#### 4.5.7 Test Results

For U-NII-1 Band

CDD Mode

802.11a

Chan.	Freq. (MHz)	PSD (dBm)		Total PSD w/o duty factor (dBm)	Duty factor	Total PSD with duty factor (dBm)	Max. Limit (dBm)	Pass / Fail
		Chain 0	Chain 1					
36	5180	6.75	6.74	9.75	0.24	9.99	14.13	Pass
40	5200	6.77	6.81	9.80	0.24	10.04	14.13	Pass
48	5240	6.38	6.59	9.49	0.24	9.73	14.13	Pass

Note:

- Method 1 of power density measurement of KDB 662911 is using for calculating total power density. Total power density is summing entire spectra across corresponding frequency bins on the various outputs by computer.
- Directional gain =  $10 \log[(10^{G1/20} + 10^{G2/20} + \dots + 10^{GN/20})^2/2] = 8.87 \text{ dBi} > 6\text{dBi}$ , so the power density limit shall be reduced to  $17-(8.87-6) = 14.13\text{dBm}$ .
- Refer to section 3.3 for duty cycle spectrum plot.

802.11n (HT20)

Chan.	Freq. (MHz)	PSD (dBm)		Total PSD (dBm)	Max. Limit (dBm)	Pass / Fail
		Chain 0	Chain 1			
36	5180	6.18	6.19	9.20	14.13	Pass
40	5200	6.65	6.75	9.71	14.13	Pass
48	5240	6.38	6.40	9.40	14.13	Pass

Note:

- Method 1 of power density measurement of KDB 662911 is using for calculating total power density. Total power density is summing entire spectra across corresponding frequency bins on the various outputs by computer.
- Directional gain =  $10 \log[(10^{G1/20} + 10^{G2/20} + \dots + 10^{GN/20})^2/2] = 8.87 \text{ dBi} > 6\text{dBi}$ , so the power density limit shall be reduced to  $17-(8.87-6) = 14.13\text{dBm}$ .

802.11n (HT40)

Chan.	Freq. (MHz)	PSD (dBm)		Total PSD w/o duty factor (dBm)	Duty factor	Total PSD with duty factor (dBm)	Max. Limit (dBm)	Pass / Fail
		Chain 0	Chain 1					
38	5190	1.03	1.06	4.06	0.17	4.23	14.13	Pass
46	5230	3.76	3.98	6.88	0.17	7.05	14.13	Pass

Note:

- Method 1 of power density measurement of KDB 662911 is using for calculating total power density. Total power density is summing entire spectra across corresponding frequency bins on the various outputs by computer.
- Directional gain =  $10 \log[(10^{G1/20} + 10^{G2/20} + \dots + 10^{GN/20})^2/2] = 8.87 \text{ dBi} > 6\text{dBi}$ , so the power density limit shall be reduced to  $17-(8.87-6) = 14.13\text{dBm}$ .
- Refer to section 3.3 for duty cycle spectrum plot.

802.11ac (VHT80)

Chan.	Freq. (MHz)	PSD (dBm)		Total PSD w/o duty factor (dBm)	Duty factor	Total PSD with duty factor (dBm)	Max. Limit (dBm)	Pass / Fail
		Chain 0	Chain 1					
42	5210	-3.64	-3.18	-0.4	0.37	-0.03	14.13	Pass

Note:

- Method 1 of power density measurement of KDB 662911 is using for calculating total power density. Total power density is summing entire spectra across corresponding frequency bins on the various outputs by computer.
- Directional gain =  $10 \log[(10^{G1/20} + 10^{G2/20} + \dots + 10^{GN/20})^2/2] = 8.87 \text{ dBi} > 6 \text{ dBi}$ , so the power density limit shall be reduced to  $17 - (8.87 - 6) = 14.13 \text{ dBm}$ .
- Refer to section 3.3 for duty cycle spectrum plot.

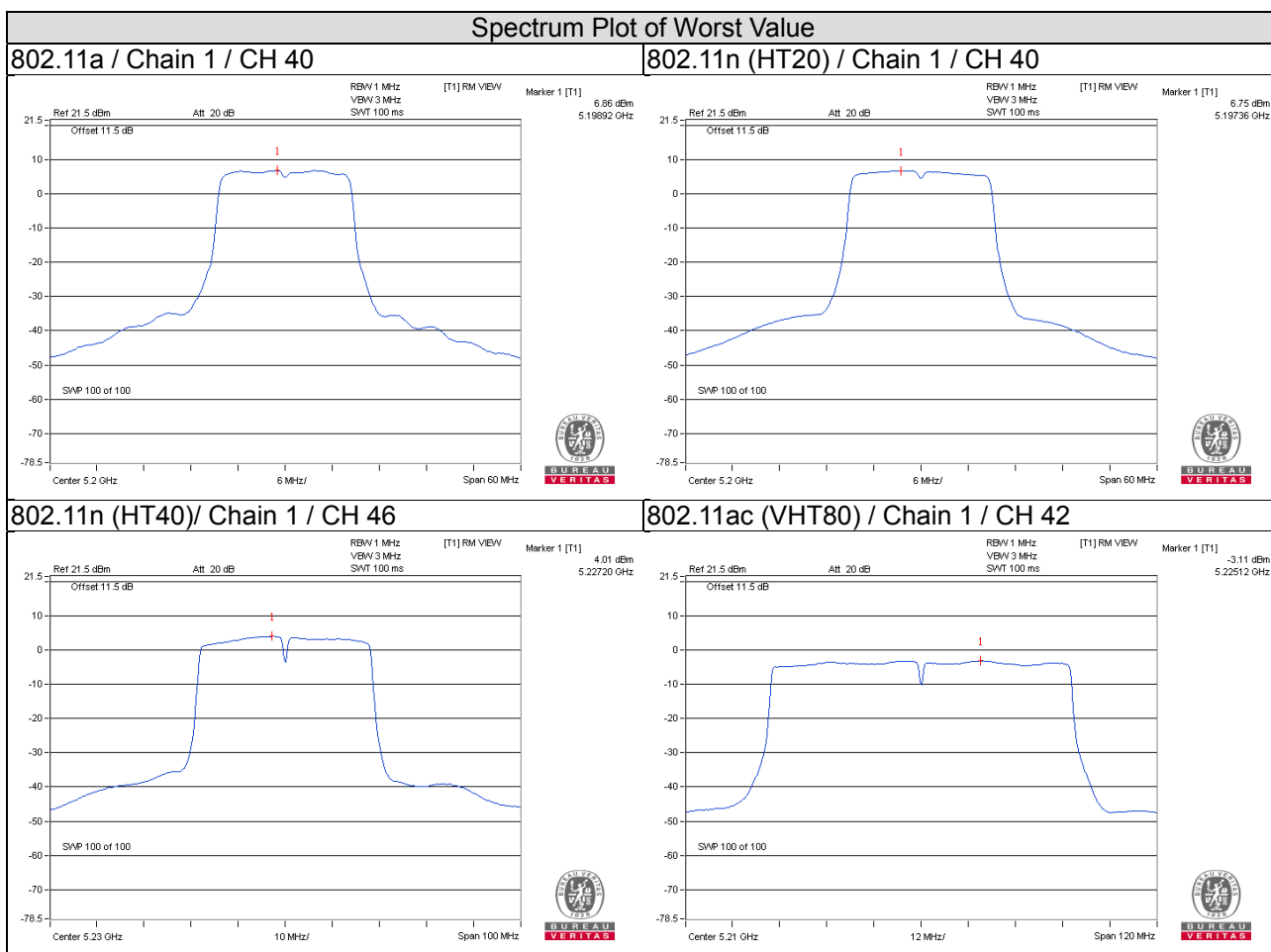



## Beamforming Mode

### 802.11n (HT20)

Chan.	Freq. (MHz)	PSD (dBm)		Total PSD (dBm)	Max. Limit (dBm)	Pass / Fail
		Chain 0	Chain 1			
36	5180	5.58	6.06	8.84	14.13	Pass
40	5200	6.51	6.82	9.68	14.13	Pass
48	5240	6.13	6.31	9.23	14.13	Pass

Note:

- Method 1 of power density measurement of KDB 662911 is using for calculating total power density. Total power density is summing entire spectra across corresponding frequency bins on the various outputs by computer.
- Directional gain =  $10 \log[(10^{G1/20} + 10^{G2/20} + \dots + 10^{GN/20})^2/2] = 8.87 \text{ dBi} > 6\text{dBi}$ , so the power density limit shall be reduced to  $17-(8.87-6) = 14.13\text{dBm}$ .

### 802.11n (HT40)

Chan.	Freq. (MHz)	PSD (dBm)		Total PSD w/o duty factor (dBm)	Duty factor	Total PSD with duty factor (dBm)	Max. Limit (dBm)	Pass / Fail
		Chain 0	Chain 1					
38	5190	-0.12	0.15	3.03	0.16	3.19	14.13	Pass
46	5230	3.68	3.64	6.67	0.16	6.83	14.13	Pass

Note:

- Method 1 of power density measurement of KDB 662911 is using for calculating total power density. Total power density is summing entire spectra across corresponding frequency bins on the various outputs by computer.
- Directional gain =  $10 \log[(10^{G1/20} + 10^{G2/20} + \dots + 10^{GN/20})^2/2] = 8.87 \text{ dBi} > 6\text{dBi}$ , so the power density limit shall be reduced to  $17-(8.87-6) = 14.13\text{dBm}$ .
- Refer to section 3.3 for duty cycle spectrum plot.

### 802.11ac (VHT80)

Chan.	Freq. (MHz)	PSD (dBm)		Total PSD w/o duty factor (dBm)	Duty factor	Total PSD with duty factor (dBm)	Max. Limit (dBm)	Pass / Fail
		Chain 0	Chain 1					
42	5210	-4.12	-3.85	-0.97	0.38	-0.59	14.13	Pass

Note:

- Method 1 of power density measurement of KDB 662911 is using for calculating total power density. Total power density is summing entire spectra across corresponding frequency bins on the various outputs by computer.
- Directional gain =  $10 \log[(10^{G1/20} + 10^{G2/20} + \dots + 10^{GN/20})^2/2] = 8.87 \text{ dBi} > 6\text{dBi}$ , so the power density limit shall be reduced to  $17-(8.87-6) = 14.13\text{dBm}$ .
- Refer to section 3.3 for duty cycle spectrum plot.

### Spectrum Plot of Worst Value

802.11n (HT20) / Chain 1 / CH 40

802.11n (HT40) / Chain 0 / CH 46

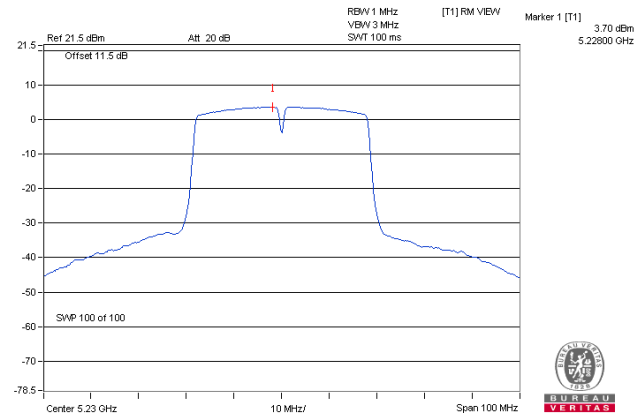
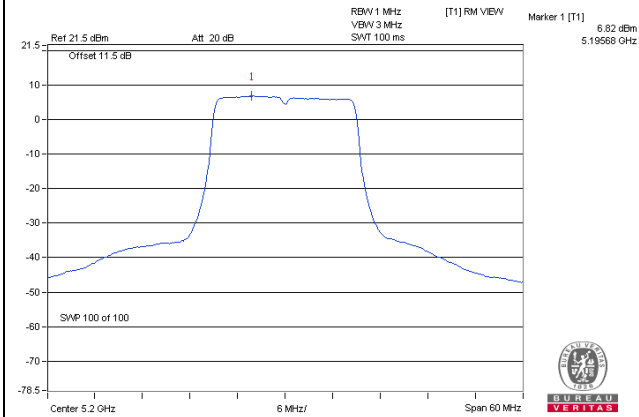

802.11ac (VHT80) / Chain 1 / CH 42

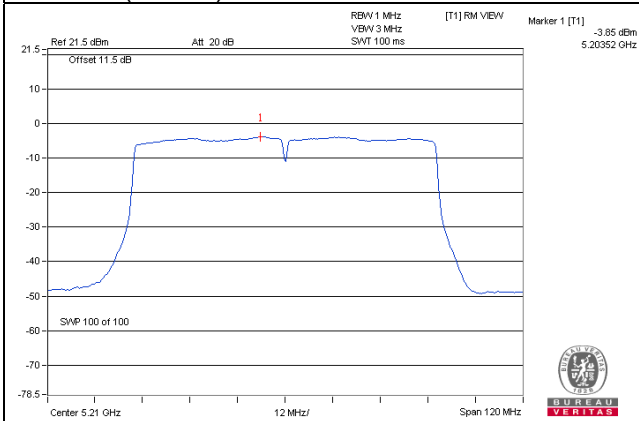

For U-NII-3 Band

CDD Mode

802.11a

TX chain	Chan.	Freq. (MHz)	PSD (dBm/300 kHz)	PSD (dBm/500 kHz)	10 log (N=2) dB	Duty factor	Total PSD (dBm/500 kHz)	Limit (dBm/500 kHz)	Pass / Fail
0	149	5745	-1.84	0.38	3.01	0.24	3.63	27.13	Pass
	157	5785	-1.99	0.23	3.01	0.24	3.48	27.13	Pass
	165	5825	-2.12	0.10	3.01	0.24	3.35	27.13	Pass
1	149	5745	-1.87	0.35	3.01	0.24	3.60	27.13	Pass
	157	5785	-1.75	0.47	3.01	0.24	3.72	27.13	Pass
	165	5825	-2.04	0.18	3.01	0.24	3.43	27.13	Pass

Note:

1. Directional gain =  $10 \log[(10^{G1/20} + 10^{G2/20} + \dots + 10^{GN/20})^2/2] = 8.87 \text{ dBi} > 6\text{dBi}$  , so the power density limit shall be reduced to  $30-(8.87-6) = 27.13\text{dBm}$ .
2. Refer to section 3.3 for duty cycle spectrum plot.

802.11n (HT20)

TX chain	Chan.	Freq. (MHz)	PSD (dBm/300 kHz)	PSD (dBm/500 kHz)	10 log (N=2) dB	Total PSD (dBm/500 kHz)	Limit (dBm/500 kHz)	Pass / Fail
0	149	5745	-2.21	0.01	3.01	3.02	27.13	Pass
	157	5785	-2.08	0.14	3.01	3.15	27.13	Pass
	165	5825	-2.54	-0.32	3.01	2.69	27.13	Pass
1	149	5745	-1.88	0.34	3.01	3.35	27.13	Pass
	157	5785	-1.97	0.25	3.01	3.26	27.13	Pass
	165	5825	-2.10	0.12	3.01	3.13	27.13	Pass

Note:

1. Directional gain =  $10 \log[(10^{G1/20} + 10^{G2/20} + \dots + 10^{GN/20})^2/2] = 8.87 \text{ dBi} > 6\text{dBi}$  , so the power density limit shall be reduced to  $30-(8.87-6) = 27.13\text{dBm}$ .

802.11n (HT40)

TX chain	Chan.	Freq. (MHz)	PSD (dBm/300 kHz)	PSD (dBm/500 kHz)	10 log (N=2) dB	Duty factor	Total PSD (dBm/500 kHz)	Limit (dBm/500 kHz)	Pass / Fail
0	151	5755	-5.06	-2.84	3.01	0.17	0.34	27.13	Pass
	159	5795	-5.20	-2.98	3.01	0.17	0.20	27.13	Pass
1	151	5755	-4.94	-2.72	3.01	0.17	0.46	27.13	Pass
	159	5795	-4.91	-2.69	3.01	0.17	0.49	27.13	Pass

Note:

1. Directional gain =  $10 \log[(10^{G1/20} + 10^{G2/20} + \dots + 10^{GN/20})^2/2] = 8.87 \text{ dBi} > 6\text{dBi}$  , so the power density limit shall be reduced to  $30-(8.87-6) = 27.13\text{dBm}$ .
2. Refer to section 3.3 for duty cycle spectrum plot.

### 802.11ac (VHT80)

TX chain	Chan.	Freq. (MHz)	PSD (dBm/300 kHz)	PSD (dBm/500 kHz)	10 log (N=2) dB	Duty factor	Total PSD (dBm/500 kHz)	Limit (dBm/500 kHz)	Pass / Fail
0	155	5775	-10.55	-8.33	3.01	0.37	-4.95	27.13	Pass
1	155	5775	-9.76	-7.54	3.01	0.37	-4.16	27.13	Pass

**Note:**

1. Directional gain =  $10 \log[(10^{G1/20} + 10^{G2/20} + \dots + 10^{GN/20})^2/2] = 8.87 \text{ dBi} > 6 \text{ dBi}$ , so the power density limit shall be reduced to  $30 - (8.87 - 6) = 27.13 \text{ dBm}$ .
2. Refer to section 3.3 for duty cycle spectrum plot.

### Spectrum Plot of Worst Value

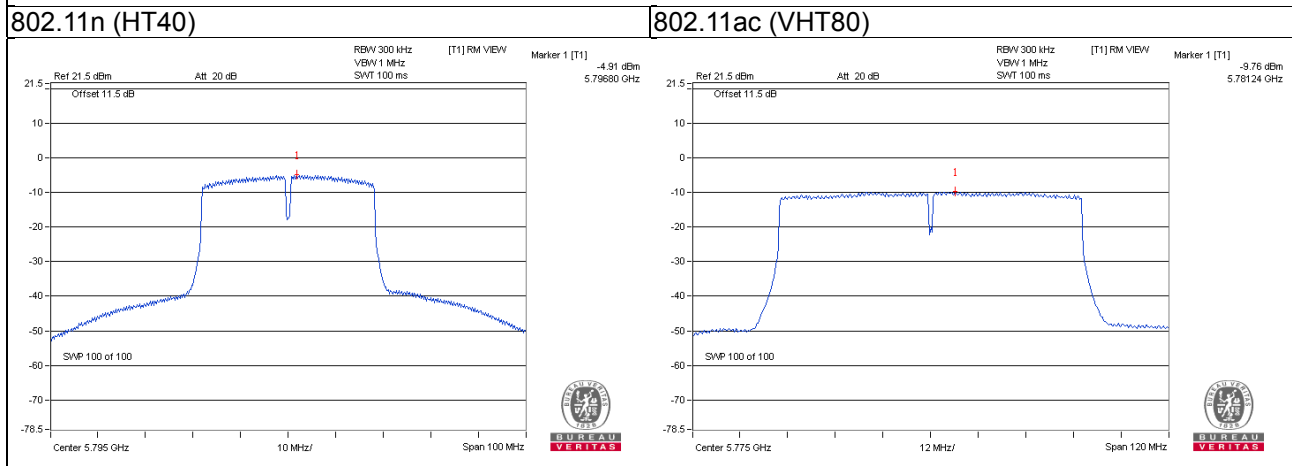
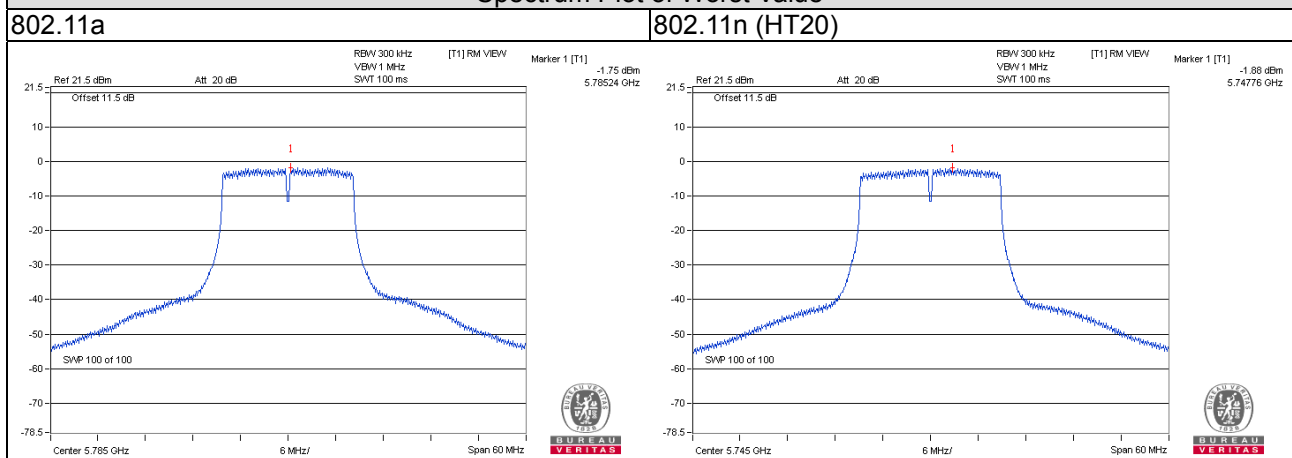

### Beamforming Mode

#### 802.11n (HT20)

TX chain	Chan.	Freq. (MHz)	PSD (dBm/300 kHz)	PSD (dBm/500 kHz)	10 log (N=2) dB	Total PSD (dBm/500 kHz)	Limit (dBm/500 kHz)	Pass / Fail
0	149	5745	-1.86	0.36	3.01	3.37	27.13	Pass
	157	5785	-1.66	0.56	3.01	3.57	27.13	Pass
	165	5825	-1.81	0.41	3.01	3.42	27.13	Pass
1	149	5745	-1.87	0.35	3.01	3.36	27.13	Pass
	157	5785	-1.75	0.47	3.01	3.48	27.13	Pass
	165	5825	-1.84	0.38	3.01	3.39	27.13	Pass

Note: Directional gain =  $10 \log[(10^{G1/20} + 10^{G2/20} + \dots + 10^{GN/20})^2/2] = 8.87 \text{ dBi} > 6\text{dBi}$ , so the power density limit shall be reduced to  $30-(8.87-6) = 27.13\text{dBm}$ .

#### 802.11n (HT40)

TX chain	Chan.	Freq. (MHz)	PSD (dBm/300 kHz)	PSD (dBm/500 kHz)	10 log (N=2) dB	Duty factor	Total PSD (dBm/500 kHz)	Limit (dBm/500 kHz)	Pass / Fail
0	151	5755	-4.90	-2.68	3.01	0.16	0.50	27.13	Pass
	159	5795	-4.90	-2.68	3.01	0.16	0.50	27.13	Pass
1	151	5755	-4.89	-2.67	3.01	0.16	0.51	27.13	Pass
	159	5795	-4.78	-2.56	3.01	0.16	0.62	27.13	Pass

Note:

1. Directional gain =  $10 \log[(10^{G1/20} + 10^{G2/20} + \dots + 10^{GN/20})^2/2] = 8.87 \text{ dBi} > 6\text{dBi}$ , so the power density limit shall be reduced to  $30-(8.87-6) = 27.13\text{dBm}$ .
2. Refer to section 3.3 for duty cycle spectrum plot.

#### 802.11ac (VHT80)

TX chain	Chan.	Freq. (MHz)	PSD (dBm/300 kHz)	PSD (dBm/500 kHz)	10 log (N=2) dB	Duty factor	Total PSD (dBm/500 kHz)	Limit (dBm/500 kHz)	Pass / Fail
0	155	5775	-9.89	-7.67	3.01	0.38	-4.28	27.13	Pass
1	155	5775	-9.70	-7.48	3.01	0.38	-4.09	27.13	Pass

Note:

1. Directional gain =  $10 \log[(10^{G1/20} + 10^{G2/20} + \dots + 10^{GN/20})^2/2] = 8.87 \text{ dBi} > 6\text{dBi}$ , so the power density limit shall be reduced to  $30-(8.87-6) = 27.13\text{dBm}$ .
2. Refer to section 3.3 for duty cycle spectrum plot.

### Spectrum Plot of Worst Value

**802.11n (HT20)**

**802.11n (HT40)**

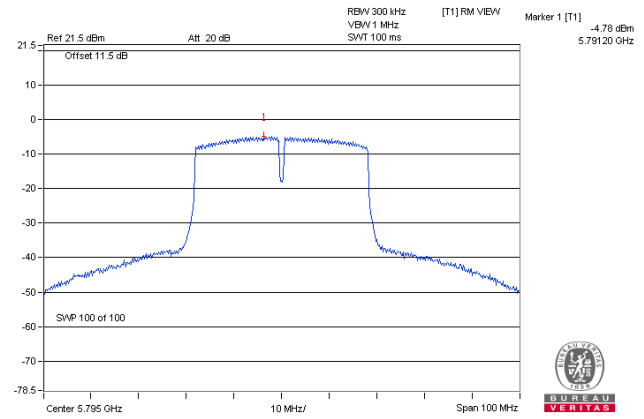
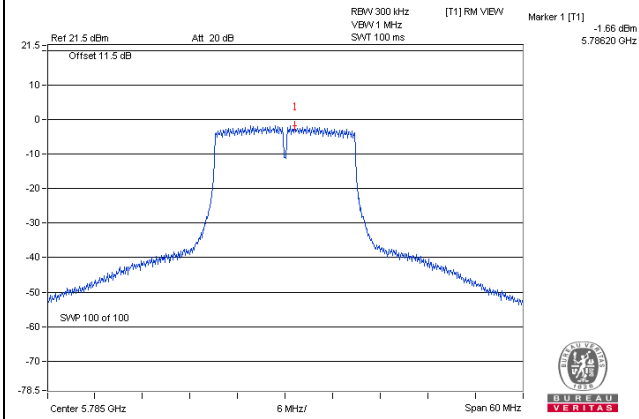

**802.11ac (VHT80)**

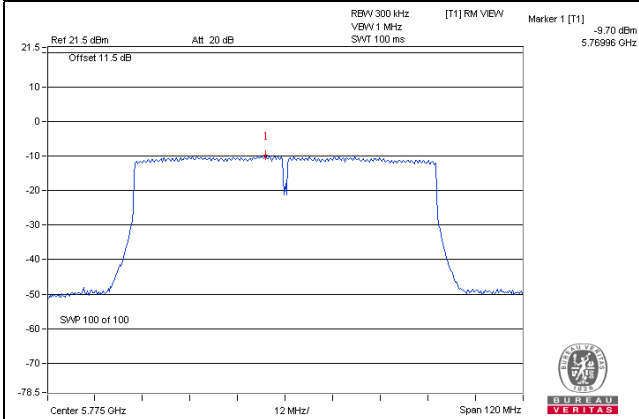

## 4.6 Frequency Stability

### 4.6.1 Limits of Frequency Stability Measurement

The frequency of the carrier signal shall be maintained within band of operation

### 4.6.2 Test Setup

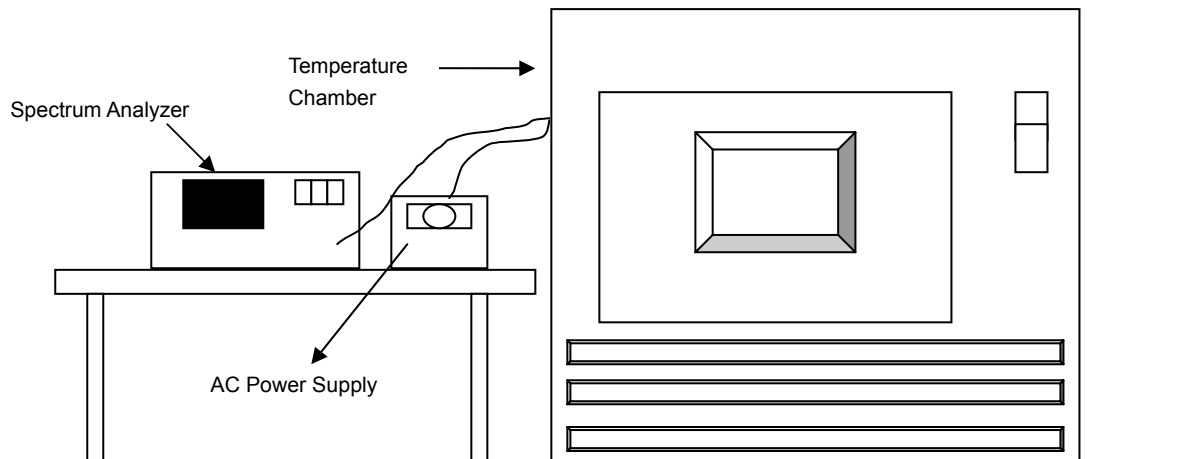

### 4.6.3 Test Procedure

- The EUT was placed inside the environmental test chamber and powered by nominal AC voltage.
- Turn the EUT on and couple its output to a spectrum analyzer.
- Turn the EUT off and set the chamber to the highest temperature specified.
- Allow sufficient time (approximately 30 min) for the temperature of the chamber to stabilize, turn the EUT on and measure the operating frequency after 2, 5, and 10 minutes.
- Repeat step 2 and 3 with the temperature chamber set to the lowest temperature.
- The test chamber was allowed to stabilize at +20 degree C for a minimum of 30 minutes. The supply voltage was then adjusted on the EUT from 85% to 115% and the frequency record.

### 4.6.4 Deviation from Test Standard

No deviation.

### 4.6.5 EUT Operating Condition

Set the EUT transmit at un-modulation mode to test frequency stability.

#### 4.6.6 Test Results

Frequency Stability Versus Temp.									
Operating Frequency: 5180MHz									
Temp. (°C)	Power Supply (Vac)	0 Minute		2 Minute		5 Minute		10 Minute	
		Measured Frequency (MHz)	Result	Measured Frequency (MHz)	Result	Measured Frequency (MHz)	Result	Measured Frequency (MHz)	Result
50	120	5179.9942	-0.00011	5179.9913	-0.00017	5179.9947	-0.00010	5179.9935	-0.00013
40	120	5180.0141	0.00027	5180.0175	0.00034	5180.0173	0.00033	5180.0139	0.00027
30	120	5180.0089	0.00017	5180.0102	0.00020	5180.0083	0.00016	5180.0089	0.00017
20	120	5179.9968	-0.00006	5179.9983	-0.00003	5179.9993	-0.00001	5179.9974	-0.00005
10	120	5180.0044	0.00008	5180.0065	0.00013	5180.0082	0.00016	5180.0088	0.00017
0	120	5179.9821	-0.00035	5179.9811	-0.00036	5179.9806	-0.00037	5179.9821	-0.00035
-10	120	5179.989	-0.00021	5179.9858	-0.00027	5179.9894	-0.00020	5179.9876	-0.00024
-20	120	5180.0195	0.00038	5180.0209	0.00040	5180.0205	0.00040	5180.0229	0.00044
-30	120	5179.9941	-0.00011	5179.9982	-0.00003	5179.9937	-0.00012	5179.9979	-0.00004

Frequency Stability Versus Voltage									
Operating Frequency: 5180MHz									
Temp. (°C)	Power Supply (Vac)	0 Minute		2 Minute		5 Minute		10 Minute	
		Measured Frequency (MHz)	Result	Measured Frequency (MHz)	Result	Measured Frequency (MHz)	Result	Measured Frequency (MHz)	Result
20	138	5179.9973	-0.00005	5179.998	-0.00004	5179.9989	-0.00002	5179.9974	-0.00005
	120	5179.9968	-0.00006	5179.9983	-0.00003	5179.9993	-0.00001	5179.9974	-0.00005
	102	5179.9965	-0.00007	5179.9984	-0.00003	5179.9987	-0.00003	5179.9971	-0.00006



## 4.7 6dB Bandwidth Measurement

### 4.7.1 Limits of 6dB Bandwidth Measurement

The minimum of 6dB Bandwidth Measurement is 0.5MHz.

### 4.7.2 Test Setup

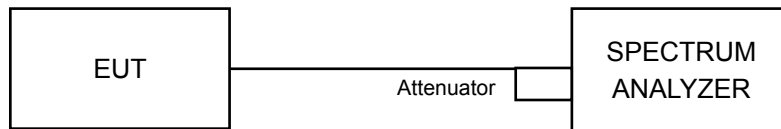

### 4.7.3 Test Instruments

Refer to section 4.1.2 to get information of above instrument.

### 4.7.4 Test Procedure

#### MEASUREMENT PROCEDURE REF

- Set resolution bandwidth (RBW) = 100kHz
- Set the video bandwidth (VBW)  $\geq 3 \times$  RBW, Detector = Peak.
- Trace mode = max hold.
- Sweep = auto couple.
- Measure the maximum width of the emission that is constrained by the frequencies associated with the two amplitude points (upper and lower) that are attenuated by 6 dB relative to the maximum level measured in the fundamental emission

### 4.7.5 Deviation from Test Standard

No deviation.

### 4.7.6 EUT Operating Condition

The software provided by client to enable the EUT under transmission condition continuously at lowest, middle and highest channel frequencies individually.

#### 4.7.7 Test Results

##### CDD Mode

##### 802.11a

Channel	Frequency (MHz)	6dB Bandwidth (MHz)		Minimum Limit (MHz)	Pass / Fail
		Chain 0	Chain 1		
149	5745	16.38	16.37	0.5	Pass
157	5785	16.40	16.40	0.5	Pass
165	5825	16.41	16.40	0.5	Pass

##### 802.11n (HT20)

Channel	Frequency (MHz)	6dB Bandwidth (MHz)		Minimum Limit (MHz)	Pass / Fail
		Chain 0	Chain 1		
149	5745	17.64	17.65	0.5	Pass
157	5785	17.64	17.63	0.5	Pass
165	5825	17.64	17.63	0.5	Pass

##### 802.11n (HT40)

Channel	Frequency (MHz)	6dB Bandwidth (MHz)		Minimum Limit (MHz)	Pass / Fail
		Chain 0	Chain 1		
151	5755	35.22	35.49	0.5	Pass
159	5795	35.27	35.28	0.5	Pass

##### 802.11ac (VHT80)

Channel	Frequency (MHz)	6dB Bandwidth (MHz)		Minimum Limit (MHz)	Pass / Fail
		Chain 0	Chain 1		
155	5775	76.42	75.72	0.5	Pass

Spectrum Plot of Worst Value

802.11a

802.11n (HT20)

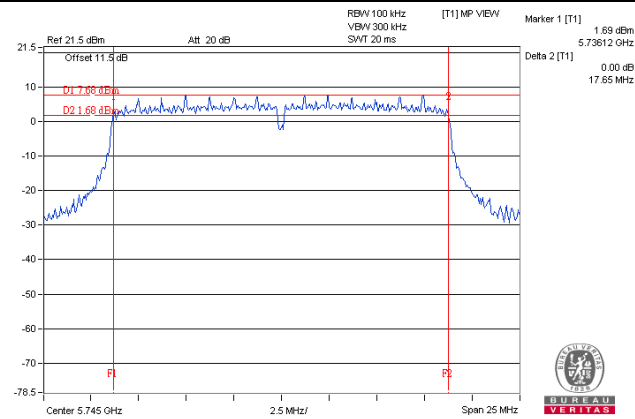
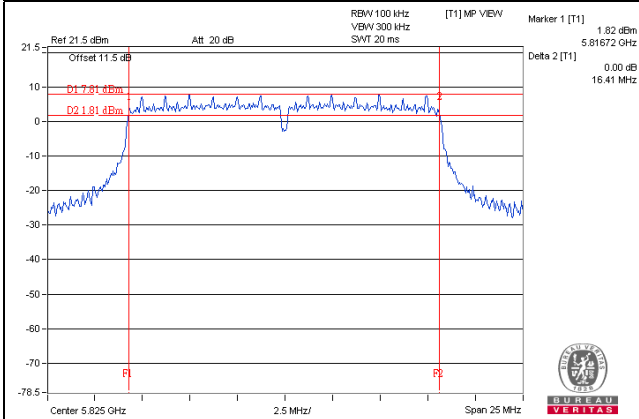

802.11n (HT40)

802.11ac (VHT80)

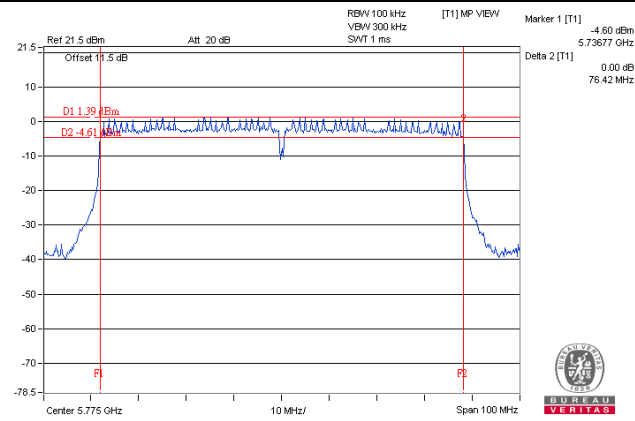
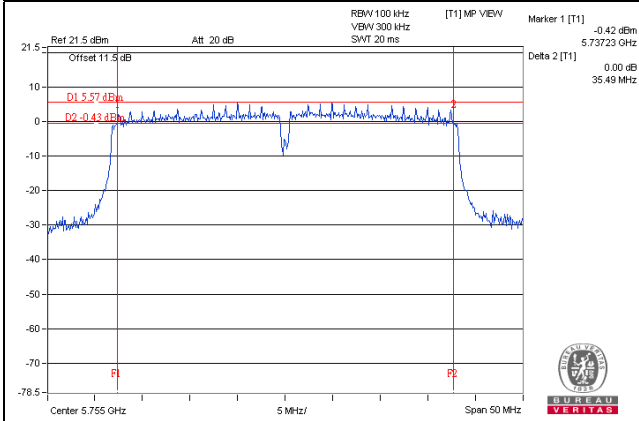

Beamforming Mode

802.11n (HT20)

Channel	Frequency (MHz)	6dB Bandwidth (MHz)		Minimum Limit (MHz)	Pass / Fail
		Chain 0	Chain 1		
149	5745	17.60	17.60	0.5	Pass
157	5785	17.62	17.62	0.5	Pass
165	5825	17.62	17.60	0.5	Pass

802.11n (HT40)

Channel	Frequency (MHz)	6dB Bandwidth (MHz)		Minimum Limit (MHz)	Pass / Fail
		Chain 0	Chain 1		
151	5755	35.24	35.23	0.5	Pass
159	5795	35.27	35.22	0.5	Pass

802.11ac (VHT80)

Channel	Frequency (MHz)	6dB Bandwidth (MHz)		Minimum Limit (MHz)	Pass / Fail
		Chain 0	Chain 1		
155	5775	76.24	76.22	0.5	Pass

### Spectrum Plot of Worst Value

**802.11n (HT20)**

**802.11n (HT40)**

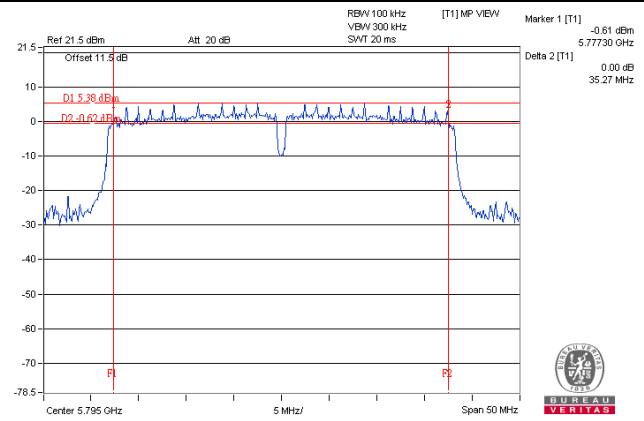
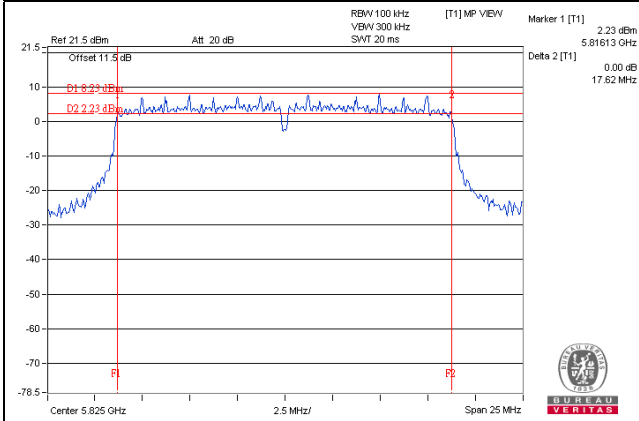

**802.11ac (VHT80)**

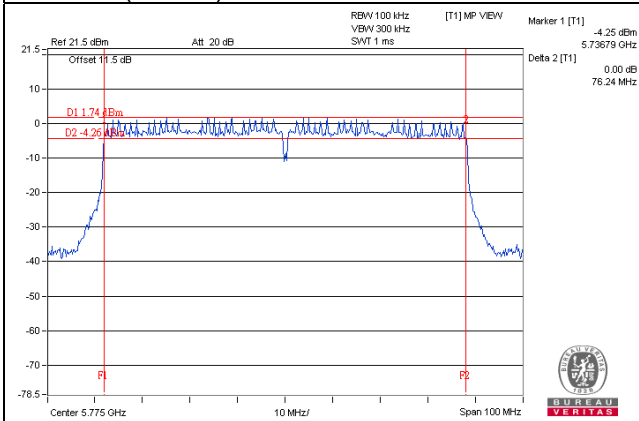

## 5 Pictures of Test Arrangements

Please refer to the attached file (Test Setup Photo).

### Annex A- Radiated Out of Band Emission (OOBE) Measurement (For U-NII-3 band)

CDD Mode

802.11a

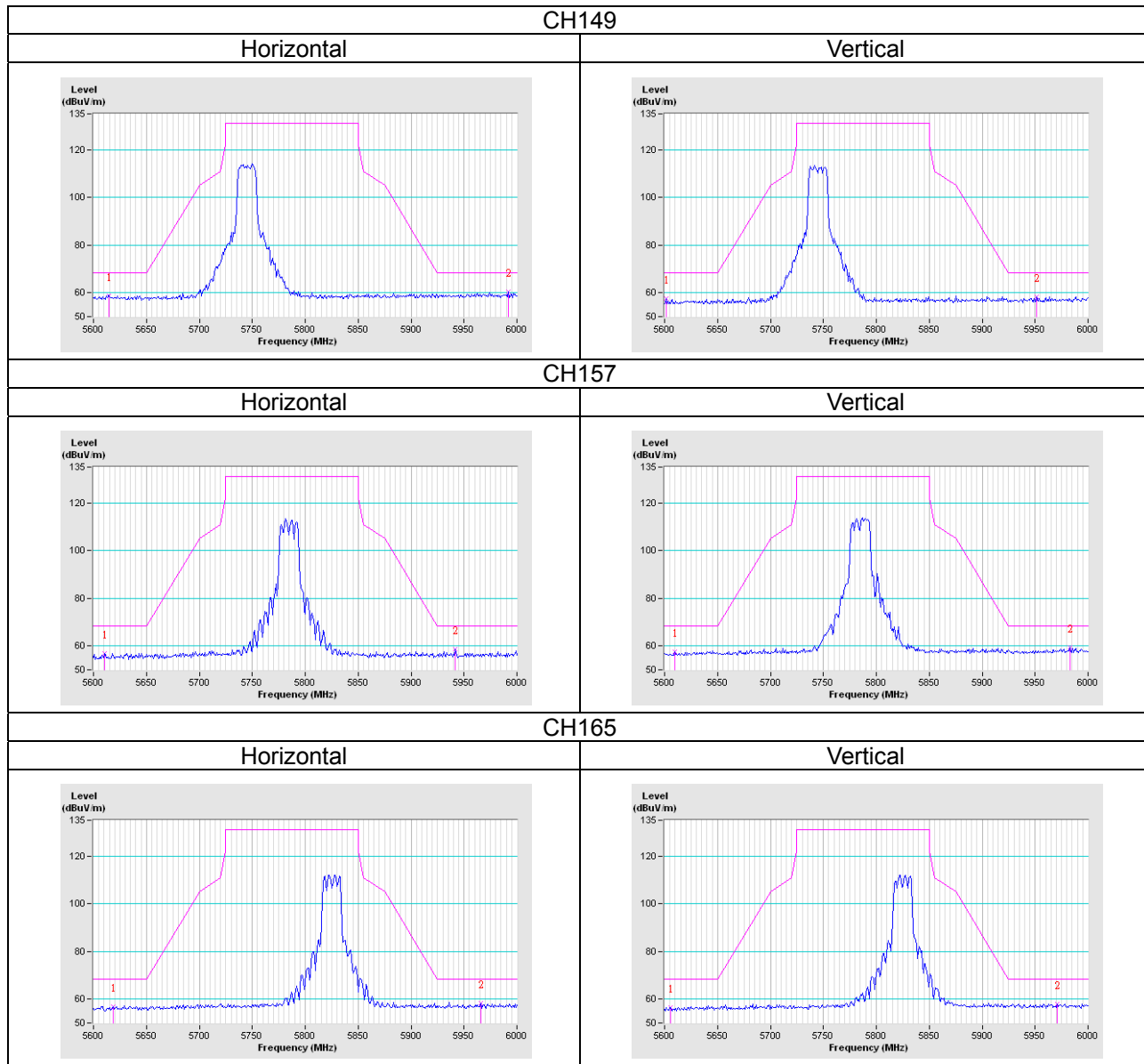

802.11n (HT20)

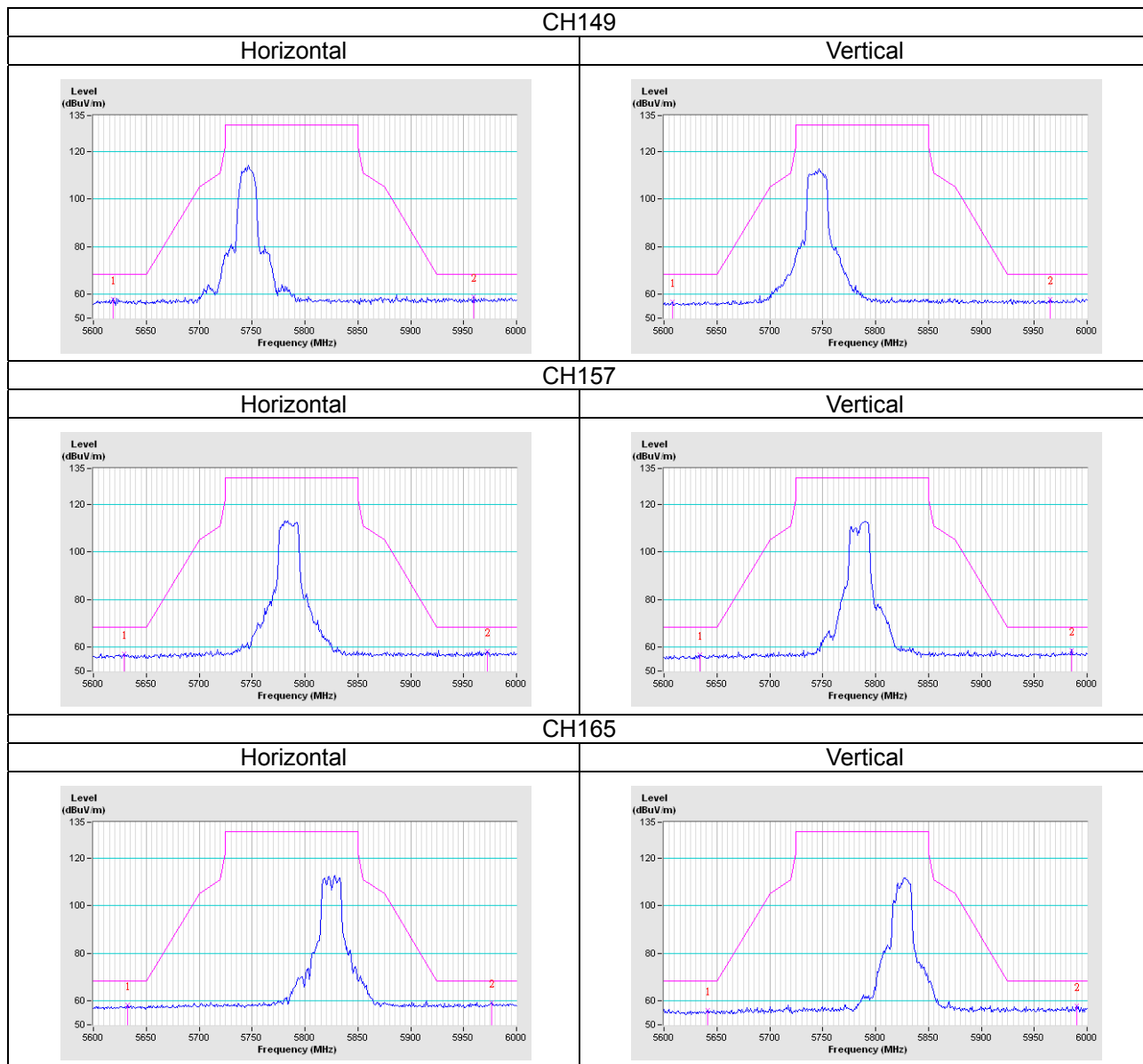



802.11n (HT40)

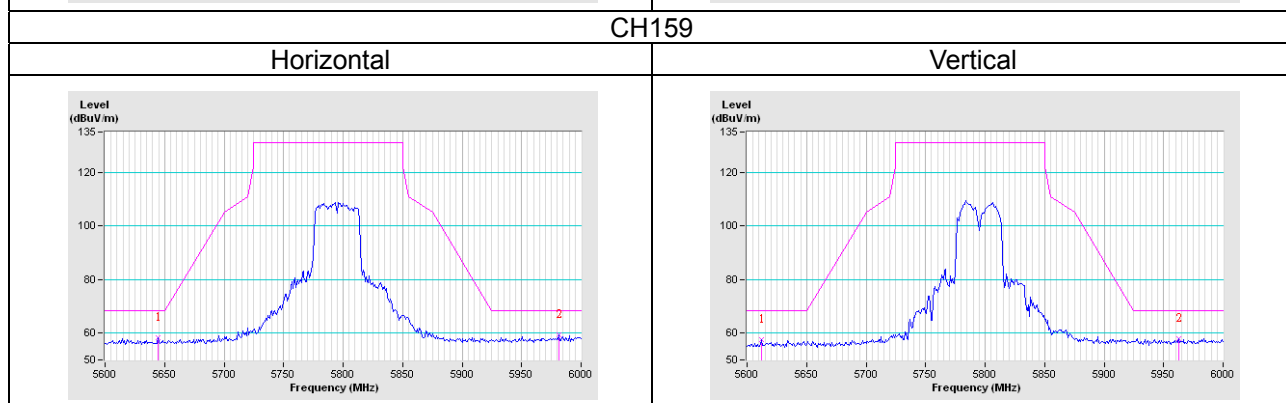
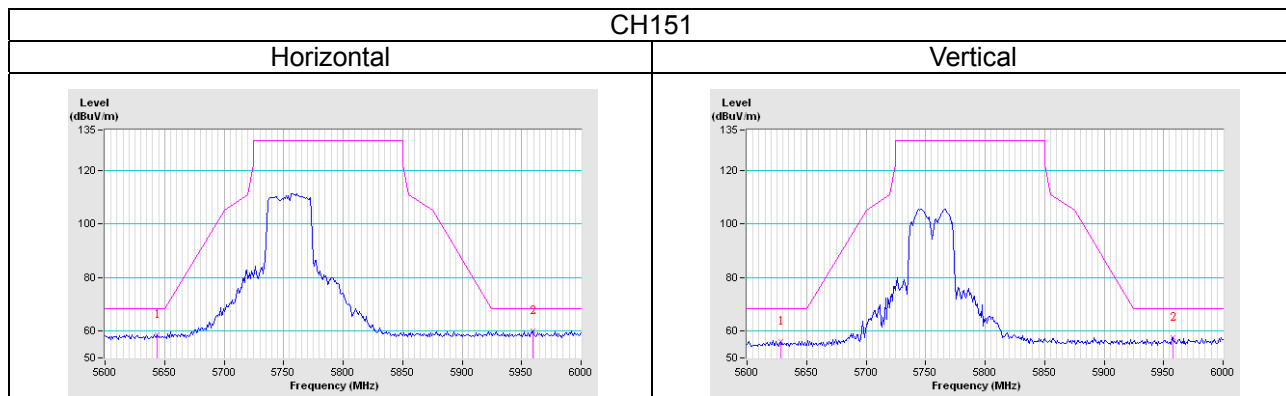

802.11ac (VHT80)

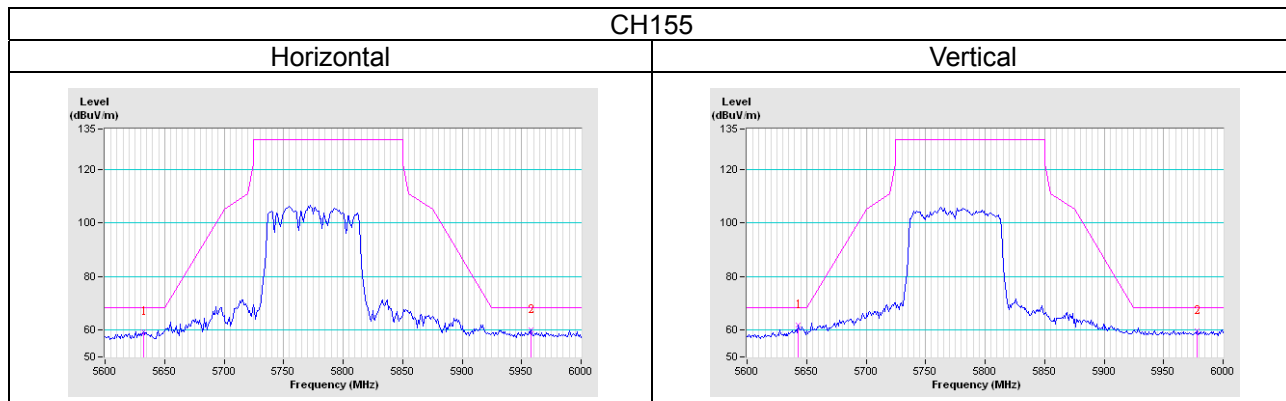

Beamforming Mode

802.11n (HT20)

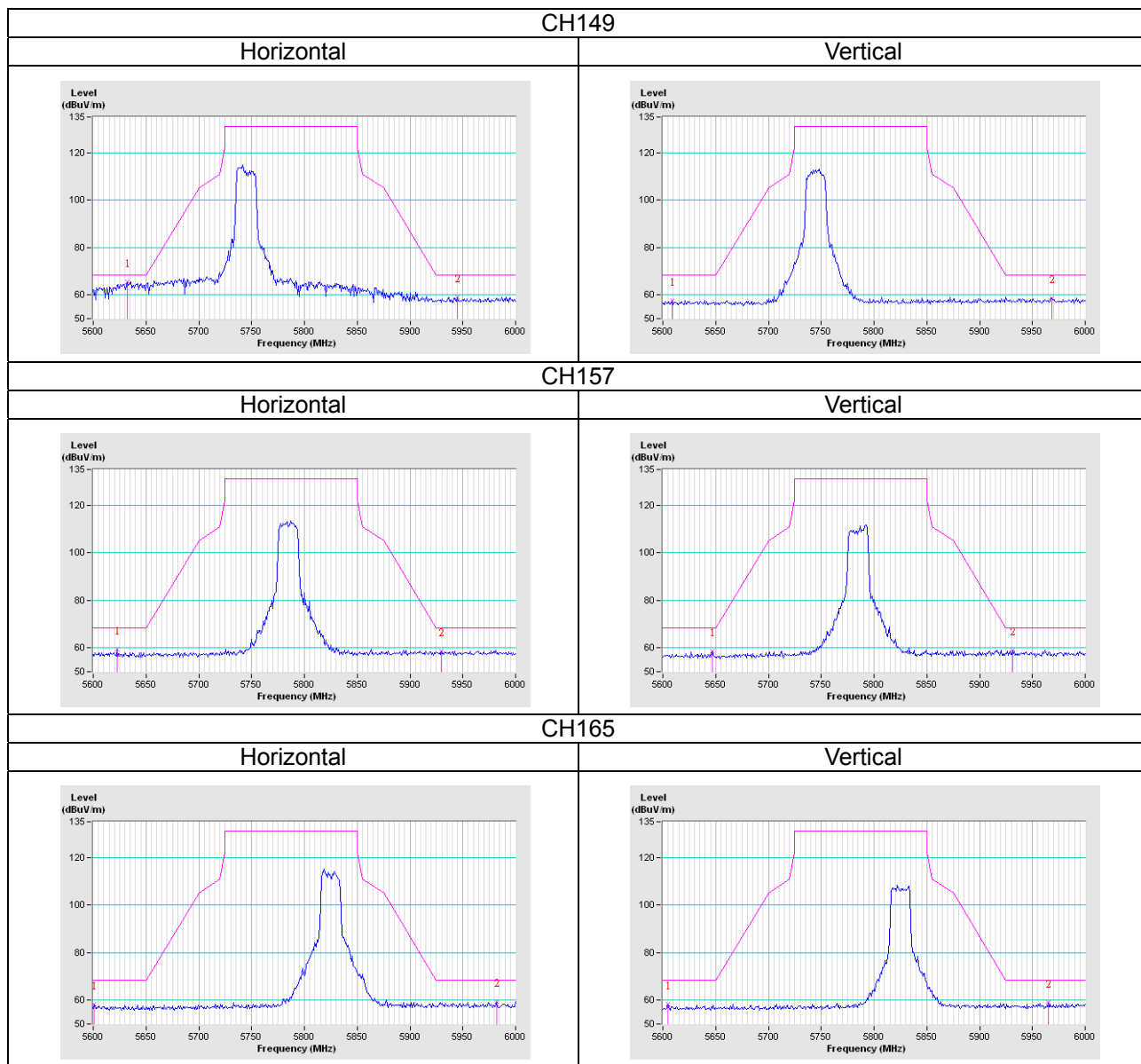

802.11n (HT40)

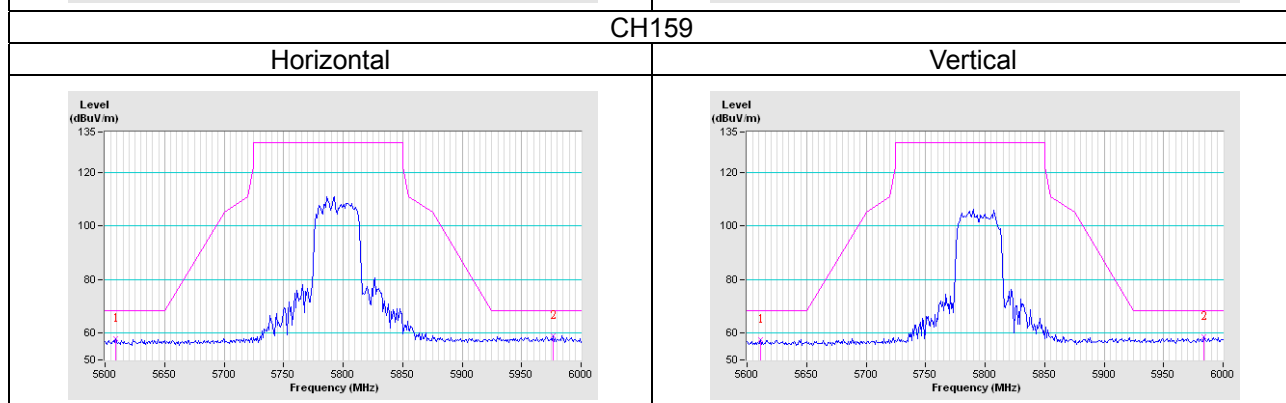
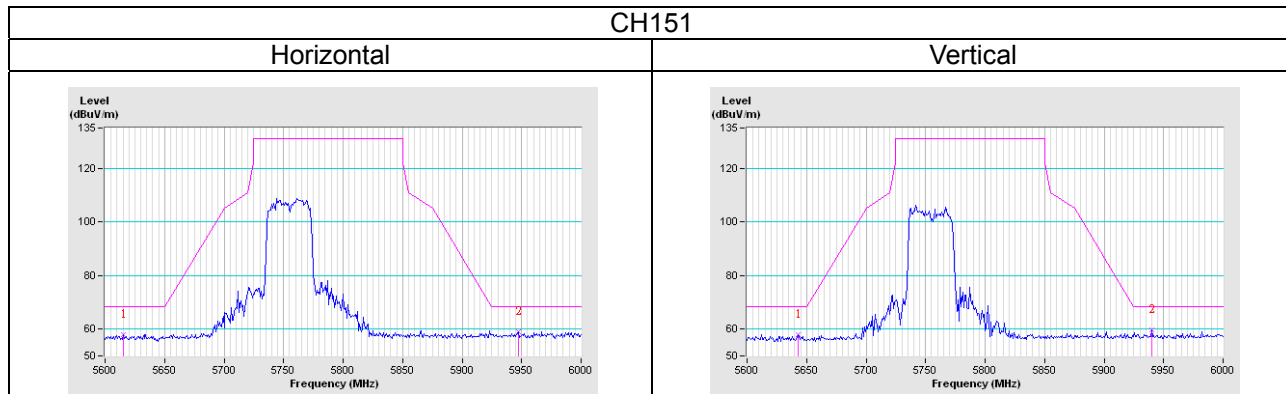

802.11ac (VHT80)

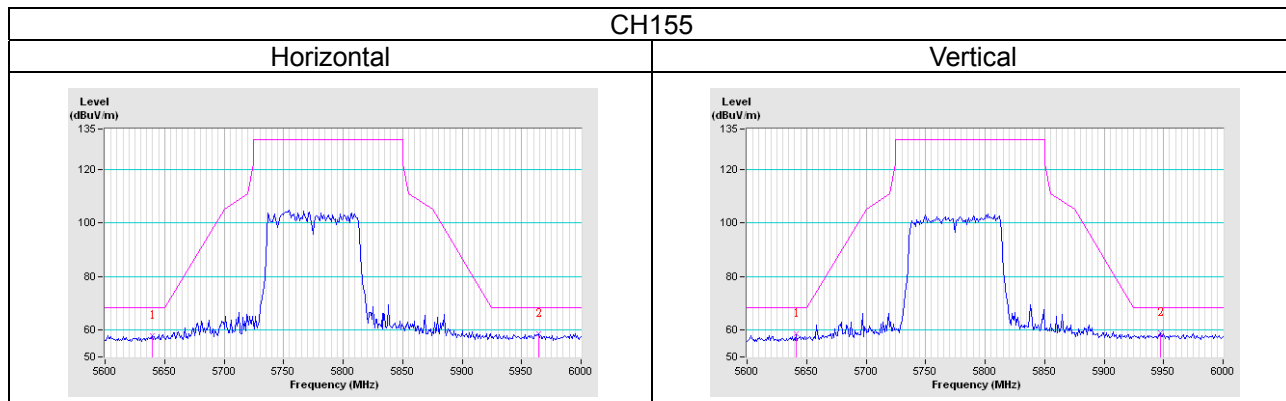

## Appendix – Information on the Testing Laboratories

We, Bureau Veritas Consumer Products Services (H.K.) Ltd., Taoyuan Branch, were founded in 1988 to provide our best service in EMC, Radio, Telecom and Safety consultation. Our laboratories are accredited and approved according to ISO/IEC 17025.

If you have any comments, please feel free to contact us at the following:

**Linko EMC/RF Lab**

Tel: 886-2-26052180

Fax: 886-2-26051924

**Hsin Chu EMC/RF/Telecom Lab**

Tel: 886-3-6668565

Fax: 886-3-6668323

**Hwa Ya EMC/RF/Safety Lab**

Tel: 886-3-3183232

Fax: 886-3-3270892

**Email:** [service.adt@tw.bureauveritas.com](mailto:service.adt@tw.bureauveritas.com)

**Web Site:** [www.bureauveritas-adt.com](http://www.bureauveritas-adt.com)

The address and road map of all our labs can be found in our web site also.

--- END ---