

## FCC Test Report

**Report No.:** RF150702C09A-1

**FCC ID:** A8J-EWS510AP

**Test Model:** EWS510AP

**Received Date:** Jun. 29, 2015

**Test Date:** Jun. 29 ~ Jul. 29, 2015 (all tests, except radiated emission below 1GHz and conducted emission items)

Feb. 18 ~ Feb. 19, 2016 (Radiated emission below 1GHz and conducted emission items)

**Issued Date:** Mar. 03, 2016

**Applicant:** EnGenius Technologies

**Address:** 1580 Scenic Avenue, Costa Mesa, CA92626

**Issued By:** Bureau Veritas Consumer Products Services (H.K.) Ltd., Taoyuan Branch

**Lab Address:** No. 47-2, 14th Ling, Chia Pau Vil., Lin Kou Dist., New Taipei City, Taiwan

**Test Location:** No. 19, Hwa Ya 2nd Rd., Wen Hwa Vil., Kwei Shan Dist., Taoyuan City 33383, TAIWAN (R.O.C.)



This report is for your exclusive use. Any copying or replication of this report to or for any other person or entity, or use of our name or trademark, is permitted only with our prior written permission. This report sets forth our findings solely with respect to the test samples identified herein. The results set forth in this report are not indicative or representative of the quality or characteristics of the lot from which a test sample was taken or any similar or identical product unless specifically and expressly noted. Our report includes all of the tests requested by you and the results thereof based upon the information that you provided to us. You have 60 days from date of issuance of this report to notify us of any material error or omission caused by our negligence, provided, however, that such notice shall be in writing and shall specifically address the issue you wish to raise. A failure to raise such issue within the prescribed time shall constitute your unqualified acceptance of the completeness of this report, the tests conducted and the correctness of the report contents. Unless specific mention, the uncertainty of measurement has been explicitly taken into account to declare the compliance or non-compliance to the specification. The report must not be used by the client to claim product certification, approval, or endorsement by TAF or any government agencies.

## Table of Contents

<b>Release Control Record</b> .....	<b>4</b>
<b>1 Certificate of Conformity</b> .....	<b>5</b>
<b>2 Summary of Test Results</b> .....	<b>6</b>
2.1 Measurement Uncertainty.....	6
2.2 Modification Record.....	6
<b>3 General Information</b> .....	<b>7</b>
3.1 General Description of EUT.....	7
3.2 Description of Test Modes.....	9
3.2.1 Test Mode Applicability and Tested Channel Detail.....	10
3.3 Duty Cycle of Test Signal.....	12
3.4 Description of Support Units.....	13
3.4.1 Configuration of System under Test.....	14
3.5 General Description of Applied Standard.....	15
<b>4 Test Types and Results</b> .....	<b>16</b>
4.1 Radiated Emission and Bandedge Measurement.....	16
4.1.1 Limits of Radiated Emission and Bandedge Measurement.....	16
4.1.2 Test Instruments.....	17
4.1.3 Test Procedure.....	19
4.1.4 Deviation from Test Standard.....	19
4.1.5 Test Setup.....	20
4.1.6 EUT Operating Conditions.....	20
4.1.7 Test Results.....	21
4.2 Conducted Emission Measurement.....	39
4.2.1 Limits of Conducted Emission Measurement.....	39
4.2.2 Test Instruments.....	39
4.2.3 Test Procedure.....	40
4.2.4 Deviation from Test Standard.....	40
4.2.5 Test Setup.....	40
4.2.6 EUT Operating Conditions.....	40
4.2.7 Test Results.....	41
4.3 Transmit Power Measurement.....	45
4.3.1 Limits of Transmit Power Measurement.....	45
4.3.2 Test Setup.....	45
4.3.3 Test Instruments.....	45
4.3.4 Test Procedure.....	46
4.3.5 Deviation from Test Standard.....	46
4.3.6 EUT Operating Conditions.....	46
4.3.7 Test Result.....	47
4.4 Peak Power Spectral Density Measurement.....	52
4.4.1 Limits of Peak Power Spectral Density Measurement.....	52
4.4.2 Test Setup.....	52
4.4.3 Test Instruments.....	52
4.4.4 Test Procedure.....	52
4.4.5 Deviation from Test Standard.....	53
4.4.6 EUT Operating Condition.....	53
4.4.7 Test Results.....	54
4.5 Frequency Stability.....	58
4.5.1 Limits of Frequency Stability Measurement.....	58
4.5.2 Test Setup.....	58
4.5.3 Test Instruments.....	58
4.5.4 Test Procedure.....	58
4.5.5 Deviation from Test Standard.....	58
4.5.6 EUT Operating Condition.....	58



4.5.7 Test Results .....	59
4.6 6dB Bandwidth Measurement.....	60
4.6.1 Limits of 6dB Bandwidth Measurement.....	60
4.6.2 Test Setup.....	60
4.6.3 Test Instruments .....	60
4.6.4 Test Procedure .....	60
4.6.5 Deviation from Test Standard .....	60
4.6.6 EUT Operating Condition .....	60
4.6.7 Test Results .....	61
<b>5 Pictures of Test Arrangements.....</b>	<b>63</b>
<b>Appendix – Information on the Testing Laboratories .....</b>	<b>64</b>



### Release Control Record

Issue No.	Description	Date Issued
RF150702C09A-1	Original release.	Mar. 03, 2016

## 1 Certificate of Conformity

**Product:** Dual Band Wireless N600 Managed Wall Plate Access Point

**Brand:** EnGenius

**Test Model:** EWS510AP

**Sample Status:** Engineering sample

**Applicant:** EnGenius Technologies

**Test Date:** Jun. 29 ~ Jul. 29, 2015 (all tests, except radiated emission below 1GHz and conducted emission items)

Feb. 18 ~ Feb. 19, 2016 (Radiated emission below 1GHz and conducted emission items)

**Standard:** 47 CFR FCC Part 15, Subpart E (Section 15.407)

ANSI C63.10:2013

The above equipment has been tested by **Bureau Veritas Consumer Products Services (H.K.) Ltd., Taoyuan Branch**, and found compliance with the requirement of the above standards. The test record, data evaluation & Equipment Under Test (EUT) configurations represented herein are true and accurate accounts of the measurements of the sample's EMC characteristics under the Conditions specified in this report.

**Prepared by :**  , **Date:** Mar. 03, 2016  
Ivy Lin / Specialist

**Approved by :**  , **Date:** Mar. 03, 2016  
Ken Liu / Senior Manager

## 2 Summary of Test Results

47 CFR FCC Part 15, Subpart E (SECTION 15.407)			
FCC Clause	Test Item	Result	Remarks
15.407(b)(6)	AC Power Conducted Emissions	PASS	Meet the requirement of limit. Minimum passing margin is -16.07dB at 0.53672MHz.
15.407(b) (1/2/3/4/6)	Radiated Emissions & Band Edge Measurement	PASS	Meet the requirement of limit. Minimum passing margin is -1.0dB at 5150.00MHz.
15.407(a)(1/2 /3)	Max Average Transmit Power	PASS	Meet the requirement of limit.
15.407(a)(1/2 /3)	Peak Power Spectral Density	PASS	Meet the requirement of limit.
15.407(e)	6dB bandwidth	PASS	Meet the requirement of limit. (U-NII-3 Band only)
15.407(g)	Frequency Stability	PASS	Meet the requirement of limit.
15.203	Antenna Requirement	PASS	Antenna connector is IPEX not a standard connector.

### 3 General Information

#### 3.1 General Description of EUT

Product	Dual Band Wireless N600 Managed Wall Plate Access Point
Brand	EnGenius
Test Model	EWS510AP
Status of EUT	Engineering sample
Power Supply Rating	48Vdc from adapter 48Vdc from PoE
Modulation Type	64QAM, 16QAM, QPSK, BPSK
Modulation Technology	OFDM
Transfer Rate	802.11a: 54.0/ 48.0/ 36.0/ 24.0/ 18.0/ 12.0/ 9.0/ 6.0Mbps 802.11n: up to 300.0Mbps
Operating Frequency	5180 ~ 5240MHz & 5745 ~ 5825MHz
Number of Channel	5180 ~ 5240MHz: 4 for 802.11a, 802.11n (HT20) 2 for 802.11n (HT40) 5745 ~ 5825MHz: 5 for 802.11a, 802.11n (HT20) 2 for 802.11n (HT40)
Output Power	5180 ~ 5240MHz: 168.104mW 5745 ~ 5825MHz: 141.274mW
Antenna Type	Refer to Note
Antenna Connector	Refer to Note
Accessory Device	NA
Data Cable Supplied	NA

**Note:**

1. This report is prepared for FCC class II permissive change. This report is issued as a supplementary report of BV ADT report no.: RF150702C09-1. The difference compared with the original design is changing the PCBA placement of primary GND (PoE GND) and chassis GND for isolation except RF portion. RF result is confirmed not to be affected after the test. Therefore, the radiated emissions test above 1GHz is kept and the conducted emissions & radiated emissions tests below 1GHz were retested in this report

3. The EUT consumes power from the following adapter & PoE.

Adapter (Support unit only)	
Brand	Powertron Electronics Corp.
Model	PA1040-480IB080
Input Power	100-240Vac, 50-60Hz, 1.5A
Output Power	48Vdc, 0.8A, 38.4W Max
Power Line	1.6m power cable with 1 core attached on adapter

PoE (Support unit only)	
Brand	EnGenius
Model	EPE-48GR
Power Rating	48Vdc, 0.38A, 18.24W

4. The following antennas were provided to the EUT.

Type	Gain(dBi)		Connector
	2.4GHz Band	5GHz Band	
Printed	Ant. 1: 4.2dBi	Ant. 3: 5.2dBi	IPEX
	Ant. 2: 5.5dBi	Ant. 4: 5.3dBi	

5. The above EUT information is declared by manufacturer and for more detailed features description, please refer to the manufacturer's specifications or user's manual.



### 3.2 Description of Test Modes

#### FOR 5180 ~ 5240MHz

4 channels are provided for 802.11a, 802.11n (HT20):

Channel	Frequency	Channel	Frequency
36	5180 MHz	44	5220 MHz
40	5200 MHz	48	5240 MHz

2 channels are provided for 802.11n (HT40):

Channel	Frequency	Channel	Frequency
38	5190 MHz	46	5230 MHz

#### FOR 5745 ~ 5825MHz:

5 channels are provided for 802.11a, 802.11n (HT20):

Channel	Frequency	Channel	Frequency
149	5745MHz	161	5805MHz
153	5765MHz	165	5825MHz
157	5785MHz		

2 channels are provided for 802.11n (HT40):

Channel	Frequency	Channel	Frequency
151	5755MHz	159	5795MHz

### 3.2.1 Test Mode Applicability and Tested Channel Detail

EUT CONFIGURE MODE	APPLICABLE TO				DESCRIPTION
	RE $\geq$ 1G	RE $<$ 1G	PLC	APCM	
A	√	√	√	√	Power from adapter
B	-	√	√	-	Power from PoE

Where **RE $\geq$ 1G**: Radiated Emission above 1GHz      **RE $<$ 1G**: Radiated Emission below 1GHz  
**PLC**: Power Line Conducted Emission      **APCM**: Antenna Port Conducted Measurement

Note: 1. "-" means no effect.  
 2. The EUT is only positioned on Z-plane to use.

#### **Radiated Emission Test (Above 1GHz):**

- Pre-Scan has been conducted to determine the worst-case mode from all possible combinations between available modulations, data rates and antenna ports (if EUT with antenna diversity architecture).
- Following channel(s) was (were) selected for the final test as listed below.

EUT CONFIGURE MODE	MODE	FREQ. BAND (MHz)	AVAILABLE CHANNEL	TESTED CHANNEL	MODULATION TECHNOLOGY	MODULATION TYPE	DATA RATE (Mbps)
A	802.11a	5180-5240	36 to 48	36, 40, 48	OFDM	BPSK	6.0
A	802.11n (HT20)		36 to 48	36, 40, 48	OFDM	BPSK	6.5
A	802.11n (HT40)		38 to 46	38, 46	OFDM	BPSK	15.0
A	802.11a	5745-5825	149 to 165	149, 157, 165	OFDM	BPSK	6.0
A	802.11n (HT20)		149 to 165	149, 157, 165	OFDM	BPSK	6.5
A	802.11n (HT40)		151 to 159	151, 159	OFDM	BPSK	15.0

#### **Radiated Emission Test (Below 1GHz):**

- Pre-Scan has been conducted to determine the worst-case mode from all possible combinations between available modulations, data rates and antenna ports (if EUT with antenna diversity architecture).
- Following channel(s) was (were) selected for the final test as listed below.

EUT CONFIGURE MODE	MODE	FREQ. BAND (MHz)	AVAILABLE CHANNEL	TESTED CHANNEL	MODULATION TECHNOLOGY	MODULATION TYPE	DATA RATE (Mbps)
A, B	802.11a	5180-5320 5745-5825	36 to 64 149 to 165	40	OFDM	BPSK	6.0

**Power Line Conducted Emission Test:**

- Pre-Scan has been conducted to determine the worst-case mode from all possible combinations between available modulations, data rates and antenna ports (if EUT with antenna diversity architecture).
- Following channel(s) was (were) selected for the final test as listed below.

EUT CONFIGURE MODE	MODE	FREQ. BAND (MHz)	AVAILABLE CHANNEL	TESTED CHANNEL	MODULATION TECHNOLOGY	MODULATION TYPE	DATA RATE (Mbps)
A, B	802.11a	5180-5320 5745-5825	36 to 64 149 to 165	40	OFDM	BPSK	6.0

**Antenna Port Conducted Measurement:**

- This item includes all test value of each mode, but only includes spectrum plot of worst value of each mode.
- Pre-Scan has been conducted to determine the worst-case mode from all possible combinations between available modulations, data rates and antenna ports (if EUT with antenna diversity architecture).
- Following channel(s) was (were) selected for the final test as listed below.

EUT CONFIGURE MODE	MODE	FREQ. BAND (MHz)	AVAILABLE CHANNEL	TESTED CHANNEL	MODULATION TECHNOLOGY	MODULATION TYPE	DATA RATE (Mbps)
A	802.11a	5180-5240	36 to 48	36, 40, 48	OFDM	BPSK	6.0
A	802.11n (HT20)		36 to 48	36, 40, 48	OFDM	BPSK	6.5
A	802.11n (HT40)		38 to 46	38, 46	OFDM	BPSK	15.0
A	802.11a	5745-5825	149 to 165	149, 157, 165	OFDM	BPSK	6.0
A	802.11n (HT20)		149 to 165	149, 157, 165	OFDM	BPSK	6.5
A	802.11n (HT40)		151 to 159	151, 159	OFDM	BPSK	15.0

**Test Condition:**

APPLICABLE TO	ENVIRONMENTAL CONDITIONS	INPUT POWER	TESTED BY
RE $\geq$ 1G	20deg. C, 66%RH, 18deg. C, 70%RH	120Vac, 60Hz	Jones Chang, Nick Hsu
RE $<$ 1G	16deg. C, 70%RH	120Vac, 60Hz 48Vdc	Nick Hsu
PLC	16deg. C, 70%RH	120Vac, 60Hz 48Vdc	Nick Hsu
APCM	25deg. C, 60%RH	120Vac, 60Hz	Leo Tsai

### 3.3 Duty Cycle of Test Signal

Duty cycle of test signal is < 98%, duty factor shall be considered.

**802.11a:** Duty cycle =  $1.357/1.404 = 0.967$ , Duty factor =  $10 * \log(1/0.967) = 0.15$

**802.11n (HT20):** Duty cycle =  $1.264/1.337 = 0.945$ , Duty factor =  $10 * \log(1/0.945) = 0.24$

**802.11n (HT40):** Duty cycle =  $0.631/0.664 = 0.950$ , Duty factor =  $10 * \log(1/0.950) = 0.22$



### 3.4 Description of Support Units

The EUT has been tested as an independent unit together with other necessary accessories or support units. The following support units or accessories were used to form a representative test configuration during the tests.

ID	Product	Brand	Model No.	Serial No.	FCC ID	Remarks
A.	Notebook	DELL	D531	CN-0XM006-4864 3-81U-2610	QDS-BRCM1020	-
B.	Load	NA	NA	NA	NA	-
C.	PoE	EnGenius	EPE-48GR	NA	NA	Supplied by the manufacturer
D.	Adapter	Powertron Electronics Corp.	PA1040-480IB080	NA	NA	Supplied by the manufacturer

Note:

1. All power cords of the above support units are non-shielded (1.8m).
2. Item A acted as a communication partner to transfer data.

ID	Descriptions	Qty.	Length (m)	Shielding (Yes/No)	Cores (Qty.)	Remarks
1.	LAN cable	1	10	N	0	Cat5e
2.	LAN cable	1	1.8	N	0	Cat5e
3.	DC cable	1	1.6	N	1	Attached on adapter
4.	LAN cable	6	1.8	N	0	Cat5e

Note: The core(s) is(are) originally attached to the cable(s).

### 3.4.1 Configuration of System under Test

#### <Adapter Mode>

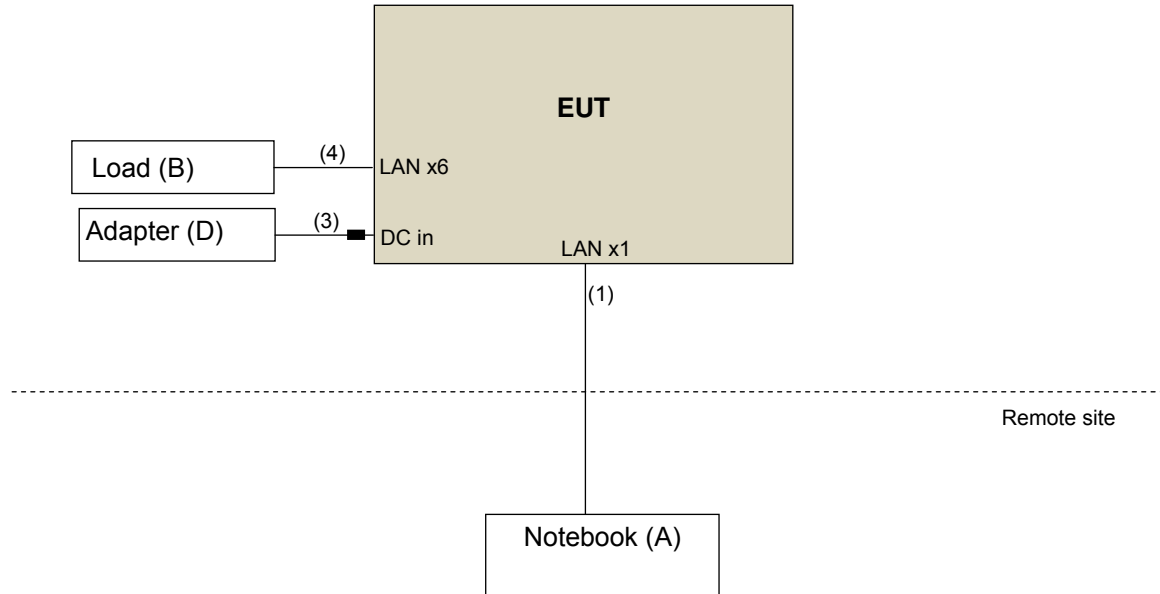

#### <PoE Mode>

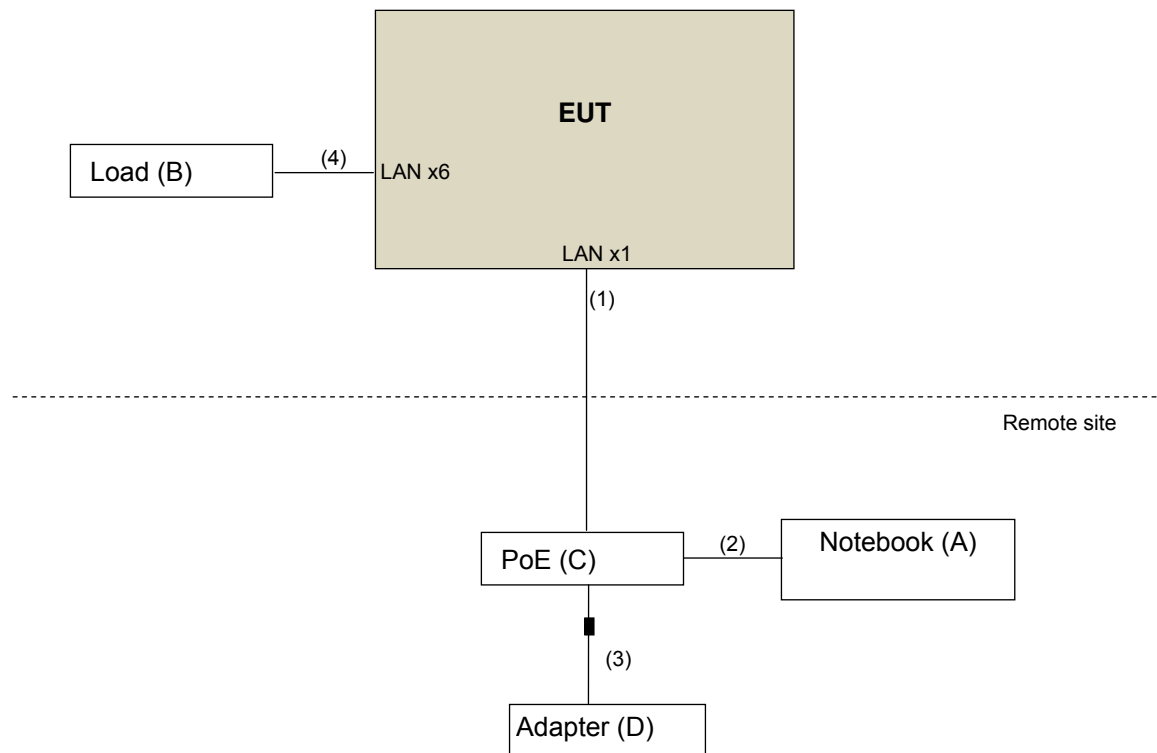

### 3.5 General Description of Applied Standard

The EUT is a RF Product. According to the specifications of the manufacturer, it must comply with the requirements of the following standards:

**FCC Part 15, Subpart E (15.407)**  
**789033 D02 General UNII Test Procedure New Rules v01r01**  
**662911 D01 Multiple Transmitter Output v02r01**  
ANSI C63.10-2013

All test items have been performed and recorded as per the above standards.

**NOTE:** The EUT has been verified to comply with the requirements of FCC Part 15, Subpart B, Class B (DoC). The test report has been issued separately.

## 4 Test Types and Results

### 4.1 Radiated Emission and Bandedge Measurement

#### 4.1.1 Limits of Radiated Emission and Bandedge Measurement

Radiated emissions which fall in the restricted bands must comply with the radiated emission limits specified as below table.

Frequencies (MHz)	Field Strength (microvolts/meter)	Measurement Distance (meters)
0.009 ~ 0.490	2400/F(kHz)	300
0.490 ~ 1.705	24000/F(kHz)	30
1.705 ~ 30.0	30	30
30 ~ 88	100	3
88 ~ 216	150	3
216 ~ 960	200	3
Above 960	500	3

#### NOTE:

1. The lower limit shall apply at the transition frequencies.
2. Emission level (dBuV/m) = 20 log Emission level (uV/m).
3. For frequencies above 1000MHz, the field strength limits are based on average detector, however, the peak field strength of any emission shall not exceed the maximum permitted average limits, specified above by more than 20dB under any Condition of modulation.

#### LIMITS OF UNWANTED EMISSION OUT OF THE RESTRICTED BANDS

APPLICABLE TO	LIMIT	
789033 D02 General UNII Test Procedure New Rules v01r01	FIELD STRENGTH AT 3m	
	PK:74 (dBuV/m)	AV:54 (dBuV/m)
APPLICABLE TO	EIRP LIMIT	EQUIVALENT FIELD STRENGTH AT 3m
15.407(b)(1)	PK:-27 (dBm/MHz)	PK:68.2(dBuV/m)
15.407(b)(2)		
15.407(b)(3)		
15.407(b)(4)	PK:-27 (dBm/MHz) <sup>*1</sup> PK:-17 (dBm/MHz) <sup>*2</sup>	PK: 68.2(dBuV/m) <sup>*1</sup> PK:78.2 (dBuV/m) <sup>*2</sup>

**NOTE:** <sup>\*1</sup> beyond 10MHz of the band edge <sup>\*2</sup> within 10 MHz of band edge

The following formula is used to convert the equipment isotropic radiated power (eirp) to field strength:

$$E = \frac{1000000\sqrt{30P}}{3} \mu\text{V/m, where P is the eirp (Watts).}$$





4.1.2 Test Instruments

Test Date: Jun. 29 ~ Jul. 29, 2015

Description & Manufacturer	Model No.	Serial No.	Cal. Date	Cal. Due
Test Receiver ROHDE & SCHWARZ	ESIB7	100187	Apr. 10, 2015	Apr. 09, 2016
Spectrum Analyzer ROHDE & SCHWARZ	FSP40	100041	Aug. 29, 2014	Aug. 28, 2015
BILOG Antenna SCHWARZBECK	VULB9168	9168-160	Feb. 05, 2015	Feb. 04, 2016
HORN Antenna SCHWARZBECK	9120D	209	Feb. 09, 2015	Feb. 08, 2016
HORN Antenna SCHWARZBECK	BBHA 9170	BBHA9170241	Feb. 09, 2015	Feb. 08, 2016
Preamplifier Agilent	8447D	2944A10738	Oct.18, 2014	Oct. 17, 2015
Preamplifier Agilent	8449B	3008A01964	Aug. 22, 2014	Aug. 21, 2015
RF signal cable HUBER+SUHNNER	SUCOFLEX 104	214378/4	Aug. 22, 2014	Aug. 21, 2015
RF signal cable HUBER+SUHNNER	SUCOFLEX 106	12738/6 +309224/4	Aug. 22, 2014	Aug. 21, 2015
Software BV ADT	ADT_Radiated_ V7.6.15.9.4	NA	NA	NA
Antenna Tower inn-co GmbH	MA 4000	013303	NA	NA
Antenna Tower Controller BV ADT	AT100	AT93021702	NA	NA
Turn Table BV ADT	TT100	TT93021702	NA	NA
Turn Table Controller BV ADT	SC100	SC93021702	NA	NA
26GHz ~ 40GHz Amplifier	EM26400	815221	Oct. 18, 2014	Oct. 17, 2015
High Speed Peak Power Meter	ML2495A	0824011	Jul. 26, 2014	Jul. 25, 2015
			Jul. 09, 2015	Jul. 08, 2016
Power Sensor	MA2411B	0738171	Jul. 26, 2014	Jul. 25, 2015
			Jul. 09, 2015	Jul. 08, 2016
WIT Standard Temperature And Humidity Chamber	TH-4S-C	W981030	Jun. 08, 2015	Jun. 07, 2016

- Note:
1. The calibration interval of the above test instruments is 12 months and the calibrations are traceable to NML/ROC and NIST/USA.
  2. The test was performed in HwaYa Chamber 3.
  3. The horn antenna and HP preamplifier (model: 8449B) are used only for the measurement of emission frequency above 1GHz if tested.
  4. The FCC Site Registration No. is 988962.
  5. The IC Site Registration No. is IC 7450F-3.



A D T

Test Date: Feb. 18, 2016

Description & Manufacturer	Model No.	Serial No.	Cal. Date	Cal. Due
Test Receiver ROHDE & SCHWARZ	ESIB7	100187	Apr. 10, 2015	Apr. 09, 2016
Spectrum Analyzer ROHDE & SCHWARZ	FSP40	100041	Sep. 02, 2015	Sep. 01, 2016
BILOG Antenna SCHWARZBECK	VULB9168	9168-151	Jan. 07, 2016	Jan. 06, 2017
HORN Antenna SCHWARZBECK	9120D	209	Jan. 20, 2016	Jan. 19, 2017
HORN Antenna SCHWARZBECK	BBHA 9170	BBHA9170241	Jan. 18, 2016	Jan. 17, 2017
Preamplifier Agilent	8447D	2944A10738	Oct.18, 2015	Oct. 17, 2016
Preamplifier Agilent	8449B	3008A01964	Aug. 22, 2015	Aug. 21, 2016
RF signal cable HUBER+SUHNER	SUCOFLEX 104	Cable-CH3-03 (214378)	Aug. 22, 2015	Aug. 21, 2016
RF signal cable HUBER+SUHNER	SUCOFLEX 106	Cable-CH3-03 (309224+12738)	Aug. 22, 2015	Aug. 21, 2016
Software BV ADT	ADT_Radiated_ V7.6.15.9.4	NA	NA	NA
Antenna Tower inn-co GmbH	MA 4000	013303	NA	NA
Antenna Tower Controller BV ADT	AT100	AT93021702	NA	NA
Turn Table BV ADT	TT100	TT93021702	NA	NA
Turn Table Controller BV ADT	SC100	SC93021702	NA	NA

- Note:
1. The calibration interval of the above test instruments is 12 months and the calibrations are traceable to NML/ROC and NIST/USA.
  2. The test was performed in HwaYa Chamber 3.
  3. The horn antenna and preamplifier (model: 8449B) are used only for the measurement of emission frequency above 1GHz if tested.
  4. The FCC Site Registration No. is 988962.
  5. The IC Site Registration No. is IC 7450F-3.

#### 4.1.3 Test Procedure

- a. The EUT was placed on the top of a rotating table 0.8 meters (for below 1GHz) / 1.5 meters (for above 1GHz) above the ground at 3 meter chamber room for test. The table was rotated 360 degrees to determine the position of the highest radiation.
- b. The EUT was set 3 meters away from the interference-receiving antenna, which was mounted on the top of a variable-height antenna tower.
- c. The height of antenna is varied from one meter to four meters above the ground to determine the maximum value of the field strength. Both horizontal and vertical polarizations of the antenna are set to make the measurement.
- d. For each suspected emission, the EUT was arranged to its worst case and then the antenna was tuned to heights from 1 meter to 4 meters and the rotatable table was turned from 0 degrees to 360 degrees to find the maximum reading.
- e. The test-receiver system was set to quasi-peak detect function and specified bandwidth with maximum hold mode when the test frequency is below 1 GHz.
- f. The test-receiver system was set to peak and average detect function and specified bandwidth with maximum hold mode when the test frequency is above 1 GHz. If the peak reading value also meets average limit, measurement with the average detector is unnecessary.

**Note:**

1. The resolution bandwidth and video bandwidth of test receiver/spectrum analyzer is 120kHz for Quasi-peak detection (QP) at frequency below 1GHz.
2. The resolution bandwidth of test receiver/spectrum analyzer is 1 MHz and the video bandwidth is 3 MHz for Peak detection (PK) at frequency above 1GHz.
3. The resolution bandwidth of test receiver/spectrum analyzer is 1MHz and the video bandwidth is 3MHz for RMS Average (Duty cycle < 98%) for Average detection (AV) at frequency above 1GHz, then the measurement results was added to a correction factor ( $10 \log(1/\text{duty cycle})$ ).
4. The resolution bandwidth of test receiver/spectrum analyzer is 1MHz and the video bandwidth is 10Hz (Duty cycle  $\geq 98\%$ ) for Average detection (AV) at frequency above 1GHz.
5. All modes of operation were investigated and the worst-case emissions are reported.

#### 4.1.4 Deviation from Test Standard

No deviation.

#### 4.1.5 Test Setup

##### <Frequency Range below 1GHz>

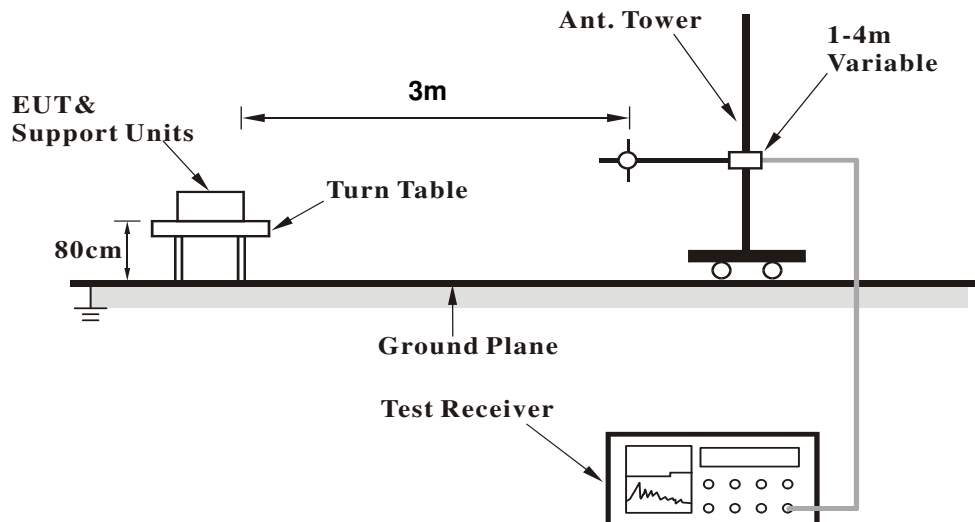

##### <Frequency Range above 1GHz>

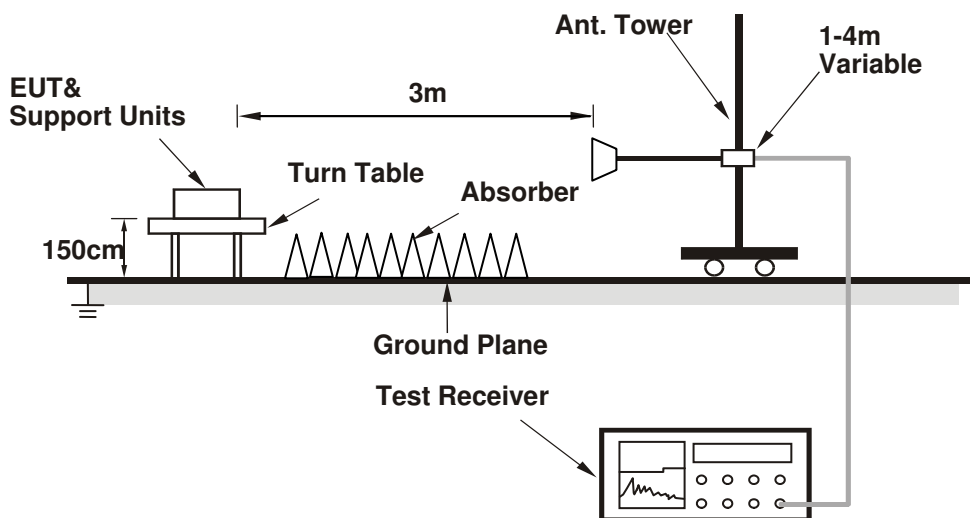

For the actual test configuration, please refer to the attached file (Test Setup Photo).

#### 4.1.6 EUT Operating Conditions

- Placed the EUT on the testing table.
- Prepared notebook to act as communication partner and placed it outside of testing area.
- The communication partner connected with EUT via a RJ45 cable and ran a test program (provided by manufacturer) to enable EUT under transmission condition continuously at specific channel frequency.
- The communication partner sent data to EUT by command "PING".



4.1.7 Test Results

**ABOVE 1GHz DATA**

<b>CHANNEL</b>	TX Channel 40	<b>DETECTOR FUNCTION</b>	Peak (PK)
<b>FREQUENCY RANGE</b>	1GHz ~ 40GHz		Average (AV)

**ANTENNA POLARITY & TEST DISTANCE: HORIZONTAL AT 3 M**

NO.	FREQ. (MHz)	EMISSION LEVEL (dBuV/m)	LIMIT (dBuV/m)	MARGIN (dB)	ANTENNA HEIGHT (m)	TABLE ANGLE (Degree)	RAW VALUE (dBuV)	CORRECTION FACTOR (dB/m)
1	*5200.00	109.0 PK			2.26 H	354	69.40	39.60
2	*5200.00	98.7 AV			2.26 H	354	59.10	39.60
3	#10400.00	60.3 PK	74.0	-13.7	1.12 H	60	41.80	18.50
4	#10400.00	48.1 AV	54.0	-5.9	1.12 H	60	29.60	18.50

**ANTENNA POLARITY & TEST DISTANCE: VERTICAL AT 3 M**

NO.	FREQ. (MHz)	EMISSION LEVEL (dBuV/m)	LIMIT (dBuV/m)	MARGIN (dB)	ANTENNA HEIGHT (m)	TABLE ANGLE (Degree)	RAW VALUE (dBuV)	CORRECTION FACTOR (dB/m)
1	*5200.00	113.4 PK			1.87 V	13	73.80	39.60
2	*5200.00	103.2 AV			1.87 V	13	63.60	39.60
3	#10400.00	60.3 PK	74.0	-13.7	1.72 V	320	41.80	18.50
4	#10400.00	48.2 AV	54.0	-5.8	1.72 V	320	29.70	18.50

**REMARKS:**

1. Emission Level(dBuV/m) = Raw Value(dBuV) + Correction Factor(dB/m)
2. Correction Factor(dB/m) = Antenna Factor(dB/m) + Cable Factor(dB)
3. The other emission levels were very low against the limit.
4. Margin value = Emission Level – Limit value
5. " \* ": Fundamental frequency.
6. " # ": The radiated frequency is out of the restricted band.

<b>CHANNEL</b>	TX Channel 48	<b>DETECTOR FUNCTION</b>	Peak (PK)
<b>FREQUENCY RANGE</b>	1GHz ~ 40GHz		Average (AV)

**ANTENNA POLARITY & TEST DISTANCE: HORIZONTAL AT 3 M**

NO.	FREQ. (MHz)	EMISSION LEVEL (dBuV/m)	LIMIT (dBuV/m)	MARGIN (dB)	ANTENNA HEIGHT (m)	TABLE ANGLE (Degree)	RAW VALUE (dBuV)	CORRECTION FACTOR (dB/m)
1	*5240.00	108.0 PK			1.00 H	125	68.40	39.60
2	*5240.00	97.8 AV			1.00 H	125	58.20	39.60
3	5350.00	58.6 PK	74.0	-15.4	1.09 H	113	52.50	6.10
4	5350.00	45.5 AV	54.0	-8.5	1.09 H	113	39.40	6.10
5	#10480.00	61.2 PK	74.0	-12.8	1.28 H	285	42.20	19.00
6	#10480.00	47.9 AV	54.0	-6.1	1.28 H	285	28.90	19.00

**ANTENNA POLARITY & TEST DISTANCE: VERTICAL AT 3 M**

NO.	FREQ. (MHz)	EMISSION LEVEL (dBuV/m)	LIMIT (dBuV/m)	MARGIN (dB)	ANTENNA HEIGHT (m)	TABLE ANGLE (Degree)	RAW VALUE (dBuV)	CORRECTION FACTOR (dB/m)
1	*5240.00	114.9 PK			2.22 V	18	75.30	39.60
2	*5240.00	104.5 AV			2.22 V	18	64.90	39.60
3	5350.00	59.9 PK	74.0	-14.1	2.04 V	3	53.80	6.10
4	5350.00	47.2 AV	54.0	-6.8	2.04 V	3	41.10	6.10
5	#10480.00	60.2 PK	74.0	-13.8	1.54 V	276	41.20	19.00
6	#10480.00	48.4 AV	54.0	-5.6	1.54 V	276	29.40	19.00

**REMARKS:**

1. Emission Level(dBuV/m) = Raw Value(dBuV) + Correction Factor(dB/m)
2. Correction Factor(dB/m) = Antenna Factor(dB/m) + Cable Factor(dB)
3. The other emission levels were very low against the limit.
4. Margin value = Emission Level – Limit value
5. " \* ": Fundamental frequency.
6. " # ": The radiated frequency is out of the restricted band.

**802.11n (HT20)**

<b>CHANNEL</b>	TX Channel 36	<b>DETECTOR FUNCTION</b>	Peak (PK)
<b>FREQUENCY RANGE</b>	1GHz ~ 40GHz		Average (AV)

**ANTENNA POLARITY & TEST DISTANCE: HORIZONTAL AT 3 M**

NO.	FREQ. (MHz)	EMISSION LEVEL (dBuV/m)	LIMIT (dBuV/m)	MARGIN (dB)	ANTENNA HEIGHT (m)	TABLE ANGLE (Degree)	RAW VALUE (dBuV)	CORRECTION FACTOR (dB/m)
1	5150.00	59.2 PK	74.0	-14.8	1.25 H	126	53.20	6.00
2	5150.00	45.8 AV	54.0	-8.2	1.25 H	126	39.80	6.00
3	*5180.00	102.9 PK			1.46 H	145	63.40	39.50
4	*5180.00	92.8 AV			1.46 H	145	53.30	39.50
5	#10360.00	60.0 PK	74.0	-14.0	1.21 H	140	41.60	18.40
6	#10360.00	47.3 AV	54.0	-6.7	1.21 H	140	28.90	18.40

**ANTENNA POLARITY & TEST DISTANCE: VERTICAL AT 3 M**

NO.	FREQ. (MHz)	EMISSION LEVEL (dBuV/m)	LIMIT (dBuV/m)	MARGIN (dB)	ANTENNA HEIGHT (m)	TABLE ANGLE (Degree)	RAW VALUE (dBuV)	CORRECTION FACTOR (dB/m)
1	5150.00	68.8 PK	74.0	-5.2	1.72 V	334	62.80	6.00
2	5150.00	53.0 AV	54.0	-1.0	1.72 V	334	47.00	6.00
3	*5180.00	109.5 PK			1.06 V	33	70.00	39.50
4	*5180.00	99.4 AV			1.06 V	33	59.90	39.50
5	#10360.00	59.8 PK	74.0	-14.2	1.47 V	216	41.40	18.40
6	#10360.00	47.2 AV	54.0	-6.8	1.47 V	216	28.80	18.40

**REMARKS:**

1. Emission Level(dBuV/m) = Raw Value(dBuV) + Correction Factor(dB/m)
2. Correction Factor(dB/m) = Antenna Factor(dB/m) + Cable Factor(dB)
3. The other emission levels were very low against the limit.
4. Margin value = Emission Level – Limit value
5. " \* ": Fundamental frequency.
6. " # ": The radiated frequency is out of the restricted band.



<b>CHANNEL</b>	TX Channel 40	<b>DETECTOR FUNCTION</b>	Peak (PK)
<b>FREQUENCY RANGE</b>	1GHz ~ 40GHz		Average (AV)

**ANTENNA POLARITY & TEST DISTANCE: HORIZONTAL AT 3 M**

NO.	FREQ. (MHz)	EMISSION LEVEL (dBuV/m)	LIMIT (dBuV/m)	MARGIN (dB)	ANTENNA HEIGHT (m)	TABLE ANGLE (Degree)	RAW VALUE (dBuV)	CORRECTION FACTOR (dB/m)
1	*5200.00	106.0 PK			1.00 H	127	66.40	39.60
2	*5200.00	96.7 AV			1.00 H	127	57.10	39.60
3	#10400.00	60.4 PK	74.0	-13.6	1.19 H	303	41.90	18.50
4	#10400.00	47.9 AV	54.0	-6.1	1.19 H	303	29.40	18.50

**ANTENNA POLARITY & TEST DISTANCE: VERTICAL AT 3 M**

NO.	FREQ. (MHz)	EMISSION LEVEL (dBuV/m)	LIMIT (dBuV/m)	MARGIN (dB)	ANTENNA HEIGHT (m)	TABLE ANGLE (Degree)	RAW VALUE (dBuV)	CORRECTION FACTOR (dB/m)
1	*5200.00	112.6 PK			2.14 V	22	73.00	39.60
2	*5200.00	102.3 AV			2.14 V	22	62.70	39.60
3	#10400.00	61.3 PK	74.0	-12.7	1.03 V	89	42.80	18.50
4	#10400.00	48.1 AV	54.0	-5.9	1.03 V	89	29.60	18.50

**REMARKS:**

1. Emission Level(dBuV/m) = Raw Value(dBuV) + Correction Factor(dB/m)
2. Correction Factor(dB/m) = Antenna Factor(dB/m) + Cable Factor(dB)
3. The other emission levels were very low against the limit.
4. Margin value = Emission Level – Limit value
5. " \* ": Fundamental frequency.
6. " # ": The radiated frequency is out of the restricted band.



<b>CHANNEL</b>	TX Channel 48	<b>DETECTOR FUNCTION</b>	Peak (PK)
<b>FREQUENCY RANGE</b>	1GHz ~ 40GHz		Average (AV)

**ANTENNA POLARITY & TEST DISTANCE: HORIZONTAL AT 3 M**

NO.	FREQ. (MHz)	EMISSION LEVEL (dBuV/m)	LIMIT (dBuV/m)	MARGIN (dB)	ANTENNA HEIGHT (m)	TABLE ANGLE (Degree)	RAW VALUE (dBuV)	CORRECTION FACTOR (dB/m)
1	*5240.00	107.2 PK			1.00 H	126	67.60	39.60
2	*5240.00	97.2 AV			1.00 H	126	57.60	39.60
3	5350.00	58.1 PK	74.0	-15.9	1.19 H	113	52.00	6.10
4	5350.00	45.2 AV	54.0	-8.8	1.19 H	113	39.10	6.10
5	#10480.00	60.0 PK	74.0	-14.0	1.28 H	282	41.00	19.00
6	#10480.00	47.4 AV	54.0	-6.6	1.28 H	282	28.40	19.00

**ANTENNA POLARITY & TEST DISTANCE: VERTICAL AT 3 M**

NO.	FREQ. (MHz)	EMISSION LEVEL (dBuV/m)	LIMIT (dBuV/m)	MARGIN (dB)	ANTENNA HEIGHT (m)	TABLE ANGLE (Degree)	RAW VALUE (dBuV)	CORRECTION FACTOR (dB/m)
1	*5240.00	114.4 PK			2.22 V	11	74.80	39.60
2	*5240.00	104.0 AV			2.22 V	11	64.40	39.60
3	5350.00	59.4 PK	74.0	-14.6	1.89 V	7	53.30	6.10
4	5350.00	46.8 AV	54.0	-7.2	1.89 V	7	40.70	6.10
5	#10480.00	60.8 PK	74.0	-13.2	1.03 V	15	41.80	19.00
6	#10480.00	48.2 AV	54.0	-5.8	1.03 V	15	29.20	19.00

**REMARKS:**

1. Emission Level(dBuV/m) = Raw Value(dBuV) + Correction Factor(dB/m)
2. Correction Factor(dB/m) = Antenna Factor(dB/m) + Cable Factor(dB)
3. The other emission levels were very low against the limit.
4. Margin value = Emission Level – Limit value
5. " \* ": Fundamental frequency.
6. " # ": The radiated frequency is out of the restricted band.

**802.11n (HT40)**

<b>CHANNEL</b>	TX Channel 38	<b>DETECTOR FUNCTION</b>	Peak (PK)
<b>FREQUENCY RANGE</b>	1GHz ~ 40GHz		Average (AV)

**ANTENNA POLARITY & TEST DISTANCE: HORIZONTAL AT 3 M**

NO.	FREQ. (MHz)	EMISSION LEVEL (dBuV/m)	LIMIT (dBuV/m)	MARGIN (dB)	ANTENNA HEIGHT (m)	TABLE ANGLE (Degree)	RAW VALUE (dBuV)	CORRECTION FACTOR (dB/m)
1	5150.00	66.1 PK	74.0	-7.9	2.14 H	11	60.10	6.00
2	5150.00	50.6 AV	54.0	-3.4	2.14 H	11	44.60	6.00
3	*5190.00	101.8 PK			2.27 H	353	62.30	39.50
4	*5190.00	92.1 AV			2.27 H	353	52.60	39.50
5	#10380.00	59.5 PK	74.0	-14.5	1.95 H	302	41.00	18.50
6	#10380.00	48.1 AV	54.0	-5.9	1.95 H	302	29.60	18.50

**ANTENNA POLARITY & TEST DISTANCE: VERTICAL AT 3 M**

NO.	FREQ. (MHz)	EMISSION LEVEL (dBuV/m)	LIMIT (dBuV/m)	MARGIN (dB)	ANTENNA HEIGHT (m)	TABLE ANGLE (Degree)	RAW VALUE (dBuV)	CORRECTION FACTOR (dB/m)
1	5150.00	70.9 PK	74.0	-3.1	2.10 V	17	64.90	6.00
2	5150.00	52.4 AV	54.0	-1.6	2.10 V	17	46.40	6.00
3	*5190.00	106.4 PK			1.63 V	334	66.90	39.50
4	*5190.00	96.7 AV			1.63 V	334	57.20	39.50
5	#10380.00	60.5 PK	74.0	-13.5	1.40 V	288	42.00	18.50
6	#10380.00	47.6 AV	54.0	-6.4	1.40 V	288	29.10	18.50

**REMARKS:**

1. Emission Level(dBuV/m) = Raw Value(dBuV) + Correction Factor(dB/m)
2. Correction Factor(dB/m) = Antenna Factor(dB/m) + Cable Factor(dB)
3. The other emission levels were very low against the limit.
4. Margin value = Emission Level – Limit value
5. " \* ": Fundamental frequency.
6. " # ": The radiated frequency is out of the restricted band.

<b>CHANNEL</b>	TX Channel 46	<b>DETECTOR FUNCTION</b>	Peak (PK)
<b>FREQUENCY RANGE</b>	1GHz ~ 40GHz		Average (AV)

**ANTENNA POLARITY & TEST DISTANCE: HORIZONTAL AT 3 M**

NO.	FREQ. (MHz)	EMISSION LEVEL (dBuV/m)	LIMIT (dBuV/m)	MARGIN (dB)	ANTENNA HEIGHT (m)	TABLE ANGLE (Degree)	RAW VALUE (dBuV)	CORRECTION FACTOR (dB/m)
1	5150.00	57.4 PK	74.0	-16.6	1.19 H	144	51.40	6.00
2	5150.00	46.1 AV	54.0	-7.9	1.19 H	144	40.10	6.00
3	*5230.00	104.2 PK			1.00 H	126	64.60	39.60
4	*5230.00	95.1 AV			1.00 H	126	55.50	39.60
5	#10460.00	59.4 PK	74.0	-14.6	1.07 H	72	40.50	18.90
6	#10460.00	47.1 AV	54.0	-6.9	1.07 H	72	28.20	18.90

**ANTENNA POLARITY & TEST DISTANCE: VERTICAL AT 3 M**

NO.	FREQ. (MHz)	EMISSION LEVEL (dBuV/m)	LIMIT (dBuV/m)	MARGIN (dB)	ANTENNA HEIGHT (m)	TABLE ANGLE (Degree)	RAW VALUE (dBuV)	CORRECTION FACTOR (dB/m)
1	5150.00	64.3 PK	74.0	-9.7	1.99 V	17	58.30	6.00
2	5150.00	52.5 AV	54.0	-1.5	1.99 V	17	46.50	6.00
3	*5230.00	110.2 PK			2.13 V	12	70.60	39.60
4	*5230.00	100.5 AV			2.13 V	12	60.90	39.60
5	#10460.00	59.2 PK	74.0	-14.8	1.71 V	165	40.30	18.90
6	#10460.00	47.9 AV	54.0	-6.1	1.71 V	165	29.00	18.90

**REMARKS:**

1. Emission Level(dBuV/m) = Raw Value(dBuV) + Correction Factor(dB/m)
2. Correction Factor(dB/m) = Antenna Factor(dB/m) + Cable Factor(dB)
3. The other emission levels were very low against the limit.
4. Margin value = Emission Level – Limit value
5. " \* ": Fundamental frequency.
6. " # ": The radiated frequency is out of the restricted band.

**802.11a**

<b>CHANNEL</b>	TX Channel 149	<b>DETECTOR FUNCTION</b>	Peak (PK)
<b>FREQUENCY RANGE</b>	1GHz ~ 40GHz		Average (AV)

<b>ANTENNA POLARITY &amp; TEST DISTANCE: HORIZONTAL AT 3 M</b>								
NO.	FREQ. (MHz)	EMISSION LEVEL (dBuV/m)	LIMIT (dBuV/m)	MARGIN (dB)	ANTENNA HEIGHT (m)	TABLE ANGLE (Degree)	RAW VALUE (dBuV)	CORRECTION FACTOR (dB/m)
1	#5714.90	63.9 PK	74.0	-10.1	1.00 H	300	57.10	6.80
2	#5714.90	48.8 AV	54.0	-5.2	1.00 H	300	42.00	6.80
3	#5722.90	69.3 PK	78.2	-8.9	1.03 H	276	62.50	6.80
4	#5725.00	56.6 PK	78.2	-21.6	1.00 H	306	49.80	6.80
5	*5745.00	107.5 PK			1.02 H	302	67.10	40.40
6	*5745.00	97.6 AV			1.02 H	302	57.20	40.40
7	11490.00	59.6 PK	74.0	-14.4	1.30 H	310	41.20	18.40
8	11490.00	47.0 AV	54.0	-7.0	1.30 H	310	28.60	18.40
<b>ANTENNA POLARITY &amp; TEST DISTANCE: VERTICAL AT 3 M</b>								
NO.	FREQ. (MHz)	EMISSION LEVEL (dBuV/m)	LIMIT (dBuV/m)	MARGIN (dB)	ANTENNA HEIGHT (m)	TABLE ANGLE (Degree)	RAW VALUE (dBuV)	CORRECTION FACTOR (dB/m)
1	#5714.90	68.5 PK	74.0	-5.5	1.60 V	328	61.70	6.80
2	#5714.90	52.0 AV	54.0	-2.0	1.60 V	328	45.20	6.80
3	#5722.90	76.9 PK	78.2	-1.3	1.60 V	322	70.10	6.80
4	#5725.00	60.2 PK	78.2	-18.0	1.58 V	326	53.40	6.80
5	*5745.00	111.7 PK			1.67 V	323	71.30	40.40
6	*5745.00	101.2 AV			1.67 V	323	60.80	40.40
7	11490.00	61.0 PK	74.0	-13.0	1.00 V	358	42.60	18.40
8	11490.00	48.4 AV	54.0	-5.6	1.00 V	358	30.00	18.40

**REMARKS:**

1. Emission Level(dBuV/m) = Raw Value(dBuV) + Correction Factor(dB/m)
2. Correction Factor(dB/m) = Antenna Factor(dB/m) + Cable Factor(dB)
3. The other emission levels were very low against the limit.
4. Margin value = Emission Level – Limit value
5. " \* ": Fundamental frequency.
6. " # ": The radiated frequency is out of the restricted band.

<b>CHANNEL</b>	TX Channel 157	<b>DETECTOR FUNCTION</b>	Peak (PK)
<b>FREQUENCY RANGE</b>	1GHz ~ 40GHz		Average (AV)

**ANTENNA POLARITY & TEST DISTANCE: HORIZONTAL AT 3 M**

NO.	FREQ. (MHz)	EMISSION LEVEL (dBuV/m)	LIMIT (dBuV/m)	MARGIN (dB)	ANTENNA HEIGHT (m)	TABLE ANGLE (Degree)	RAW VALUE (dBuV)	CORRECTION FACTOR (dB/m)
1	*5785.00	109.5 PK			1.02 H	303	69.00	40.50
2	*5785.00	99.5 AV			1.02 H	303	59.00	40.50
3	11570.00	60.3 PK	74.0	-13.7	1.13 H	306	41.90	18.40
4	11570.00	48.3 AV	54.0	-5.7	1.13 H	306	29.90	18.40

**ANTENNA POLARITY & TEST DISTANCE: VERTICAL AT 3 M**

NO.	FREQ. (MHz)	EMISSION LEVEL (dBuV/m)	LIMIT (dBuV/m)	MARGIN (dB)	ANTENNA HEIGHT (m)	TABLE ANGLE (Degree)	RAW VALUE (dBuV)	CORRECTION FACTOR (dB/m)
1	*5785.00	111.3 PK			1.46 V	2	70.80	40.50
2	*5785.00	101.1 AV			1.46 V	2	60.60	40.50
3	11570.00	60.6 PK	74.0	-13.4	1.05 V	56	42.20	18.40
4	11570.00	48.8 AV	54.0	-5.2	1.05 V	56	30.40	18.40

**REMARKS:**

1. Emission Level(dBuV/m) = Raw Value(dBuV) + Correction Factor(dB/m)
2. Correction Factor(dB/m) = Antenna Factor(dB/m) + Cable Factor(dB)
3. The other emission levels were very low against the limit.
4. Margin value = Emission Level – Limit value
5. " \* ": Fundamental frequency.



<b>CHANNEL</b>	TX Channel 165	<b>DETECTOR FUNCTION</b>	Peak (PK)
<b>FREQUENCY RANGE</b>	1GHz ~ 40GHz		Average (AV)

**ANTENNA POLARITY & TEST DISTANCE: HORIZONTAL AT 3 M**

NO.	FREQ. (MHz)	EMISSION LEVEL (dBuV/m)	LIMIT (dBuV/m)	MARGIN (dB)	ANTENNA HEIGHT (m)	TABLE ANGLE (Degree)	RAW VALUE (dBuV)	CORRECTION FACTOR (dB/m)
1	*5825.00	109.5 PK			1.10 H	300	69.00	40.50
2	*5825.00	99.9 AV			1.10 H	300	59.40	40.50
3	#5850.00	53.1 PK	78.2	-25.1	1.10 H	328	46.20	6.90
4	#5852.10	73.1 PK	78.2	-5.1	1.00 H	297	66.10	7.00
5	#5860.10	62.2 PK	74.0	-11.8	1.00 H	303	55.20	7.00
6	#5860.10	48.2 AV	54.0	-5.8	1.00 H	303	41.20	7.00
7	11650.00	61.7 PK	74.0	-12.3	1.00 H	310	42.80	18.90
8	11650.00	48.6 AV	54.0	-5.4	1.00 H	310	29.70	18.90

**ANTENNA POLARITY & TEST DISTANCE: VERTICAL AT 3 M**

NO.	FREQ. (MHz)	EMISSION LEVEL (dBuV/m)	LIMIT (dBuV/m)	MARGIN (dB)	ANTENNA HEIGHT (m)	TABLE ANGLE (Degree)	RAW VALUE (dBuV)	CORRECTION FACTOR (dB/m)
1	*5825.00	111.7 PK			1.71 V	0	71.20	40.50
2	*5825.00	101.6 AV			1.71 V	0	61.10	40.50
3	#5850.00	55.5 PK	78.2	-22.7	1.64 V	0	48.60	6.90
4	#5852.10	73.0 PK	78.2	-5.2	1.45 V	0	66.00	7.00
5	#5860.10	64.1 PK	74.0	-9.9	1.71 V	0	57.10	7.00
6	#5860.10	49.3 AV	54.0	-4.7	1.71 V	0	42.30	7.00
7	11650.00	60.4 PK	74.0	-13.6	1.25 V	58	41.50	18.90
8	11650.00	47.7 AV	54.0	-6.3	1.25 V	58	28.80	18.90

**REMARKS:**

1. Emission Level(dBuV/m) = Raw Value(dBuV) + Correction Factor(dB/m)
2. Correction Factor(dB/m) = Antenna Factor(dB/m) + Cable Factor(dB)
3. The other emission levels were very low against the limit.
4. Margin value = Emission Level – Limit value
5. " \* ": Fundamental frequency.
6. " # ": The radiated frequency is out of the restricted band.

**802.11n (HT20)**

<b>CHANNEL</b>	TX Channel 149	<b>DETECTOR FUNCTION</b>	Peak (PK)
<b>FREQUENCY RANGE</b>	1GHz ~ 40GHz		Average (AV)

**ANTENNA POLARITY & TEST DISTANCE: HORIZONTAL AT 3 M**

NO.	FREQ. (MHz)	EMISSION LEVEL (dBuV/m)	LIMIT (dBuV/m)	MARGIN (dB)	ANTENNA HEIGHT (m)	TABLE ANGLE (Degree)	RAW VALUE (dBuV)	CORRECTION FACTOR (dB/m)
1	#5714.90	64.3 PK	74.0	-9.7	1.97 H	286	57.50	6.80
2	#5714.90	48.6 AV	54.0	-5.4	1.97 H	286	41.80	6.80
3	#5722.90	71.6 PK	78.2	-6.6	1.86 H	304	64.80	6.80
4	#5725.00	57.0 PK	78.2	-21.2	2.00 H	315	50.20	6.80
5	*5745.00	106.9 PK			2.03 H	290	66.50	40.40
6	*5745.00	97.0 AV			2.03 H	290	56.60	40.40
7	11490.00	58.8 PK	74.0	-15.2	2.14 H	304	40.40	18.40
8	11490.00	46.5 AV	54.0	-7.5	2.14 H	304	28.10	18.40

**ANTENNA POLARITY & TEST DISTANCE: VERTICAL AT 3 M**

NO.	FREQ. (MHz)	EMISSION LEVEL (dBuV/m)	LIMIT (dBuV/m)	MARGIN (dB)	ANTENNA HEIGHT (m)	TABLE ANGLE (Degree)	RAW VALUE (dBuV)	CORRECTION FACTOR (dB/m)
1	#5714.90	67.9 PK	74.0	-6.1	2.06 V	356	61.10	6.80
2	#5714.90	52.4 AV	54.0	-1.6	2.06 V	356	45.60	6.80
3	#5722.90	77.0 PK	78.2	-1.2	1.63 V	1	70.20	6.80
4	#5725.00	55.3 PK	78.2	-22.9	1.96 V	351	48.50	6.80
5	*5745.00	108.1 PK			1.47 V	14	67.70	40.40
6	*5745.00	98.4 AV			1.47 V	14	58.00	40.40
7	11490.00	58.8 PK	74.0	-15.2	1.95 V	280	40.40	18.40
8	11490.00	46.5 AV	54.0	-7.5	1.95 V	280	28.10	18.40

**REMARKS:**

1. Emission Level(dBuV/m) = Raw Value(dBuV) + Correction Factor(dB/m)
2. Correction Factor(dB/m) = Antenna Factor(dB/m) + Cable Factor(dB)
3. The other emission levels were very low against the limit.
4. Margin value = Emission Level – Limit value
5. " \* ": Fundamental frequency.
6. " # ": The radiated frequency is out of the restricted band.





<b>CHANNEL</b>	TX Channel 157	<b>DETECTOR FUNCTION</b>	Peak (PK)
<b>FREQUENCY RANGE</b>	1GHz ~ 40GHz		Average (AV)

**ANTENNA POLARITY & TEST DISTANCE: HORIZONTAL AT 3 M**

NO.	FREQ. (MHz)	EMISSION LEVEL (dBuV/m)	LIMIT (dBuV/m)	MARGIN (dB)	ANTENNA HEIGHT (m)	TABLE ANGLE (Degree)	RAW VALUE (dBuV)	CORRECTION FACTOR (dB/m)
1	*5785.00	109.9 PK			1.02 H	297	69.40	40.50
2	*5785.00	99.5 AV			1.02 H	297	59.00	40.50
3	11570.00	61.1 PK	74.0	-12.9	1.01 H	309	42.70	18.40
4	11570.00	48.0 AV	54.0	-6.0	1.01 H	309	29.60	18.40

**ANTENNA POLARITY & TEST DISTANCE: VERTICAL AT 3 M**

NO.	FREQ. (MHz)	EMISSION LEVEL (dBuV/m)	LIMIT (dBuV/m)	MARGIN (dB)	ANTENNA HEIGHT (m)	TABLE ANGLE (Degree)	RAW VALUE (dBuV)	CORRECTION FACTOR (dB/m)
1	*5785.00	112.3 PK			1.57 V	0	71.80	40.50
2	*5785.00	102.2 AV			1.57 V	0	61.70	40.50
3	11570.00	60.8 PK	74.0	-13.2	1.92 V	293	42.40	18.40
4	11570.00	48.1 AV	54.0	-5.9	1.92 V	293	29.70	18.40

**REMARKS:**

1. Emission Level(dBuV/m) = Raw Value(dBuV) + Correction Factor(dB/m)
2. Correction Factor(dB/m) = Antenna Factor(dB/m) + Cable Factor(dB)
3. The other emission levels were very low against the limit.
4. Margin value = Emission Level – Limit value
5. " \* ": Fundamental frequency.



<b>CHANNEL</b>	TX Channel 165	<b>DETECTOR FUNCTION</b>	Peak (PK)
<b>FREQUENCY RANGE</b>	1GHz ~ 40GHz		Average (AV)

**ANTENNA POLARITY & TEST DISTANCE: HORIZONTAL AT 3 M**

NO.	FREQ. (MHz)	EMISSION LEVEL (dBuV/m)	LIMIT (dBuV/m)	MARGIN (dB)	ANTENNA HEIGHT (m)	TABLE ANGLE (Degree)	RAW VALUE (dBuV)	CORRECTION FACTOR (dB/m)
1	*5825.00	110.2 PK			1.00 H	298	69.70	40.50
2	*5825.00	99.9 AV			1.00 H	298	59.40	40.50
3	#5850.00	54.4 PK	78.2	-23.8	1.00 H	331	47.50	6.90
4	#5852.10	70.7 PK	78.2	-7.5	1.00 H	339	63.70	7.00
5	#5860.10	70.2 PK	74.0	-3.8	1.00 H	298	63.20	7.00
6	#5860.10	49.3 AV	54.0	-4.7	1.00 H	298	42.30	7.00
7	11650.00	61.3 PK	74.0	-12.7	1.00 H	72	42.40	18.90
8	11650.00	48.1 AV	54.0	-5.9	1.00 H	72	29.20	18.90

**ANTENNA POLARITY & TEST DISTANCE: VERTICAL AT 3 M**

NO.	FREQ. (MHz)	EMISSION LEVEL (dBuV/m)	LIMIT (dBuV/m)	MARGIN (dB)	ANTENNA HEIGHT (m)	TABLE ANGLE (Degree)	RAW VALUE (dBuV)	CORRECTION FACTOR (dB/m)
1	*5825.00	110.1 PK			1.49 V	7	69.60	40.50
2	*5825.00	99.9 AV			1.49 V	7	59.40	40.50
3	#5850.00	56.6 PK	78.2	-21.6	1.45 V	0	49.70	6.90
4	#5852.10	75.2 PK	78.2	-3.0	1.45 V	3	68.20	7.00
5	#5860.10	63.5 PK	74.0	-10.5	1.11 V	10	56.50	7.00
6	#5860.10	48.0 AV	54.0	-6.0	1.11 V	10	41.00	7.00
7	11650.00	59.7 PK	74.0	-14.3	1.31 V	318	40.80	18.90
8	11650.00	47.7 AV	54.0	-6.3	1.31 V	318	28.80	18.90

**REMARKS:**

1. Emission Level(dBuV/m) = Raw Value(dBuV) + Correction Factor(dB/m)
2. Correction Factor(dB/m) = Antenna Factor(dB/m) + Cable Factor(dB)
3. The other emission levels were very low against the limit.
4. Margin value = Emission Level – Limit value
5. " \* ": Fundamental frequency.
6. " # ": The radiated frequency is out of the restricted band.

**802.11n (HT40)**

<b>CHANNEL</b>	TX Channel 151	<b>DETECTOR FUNCTION</b>	Peak (PK)
<b>FREQUENCY RANGE</b>	1GHz ~ 40GHz		Average (AV)

**ANTENNA POLARITY & TEST DISTANCE: HORIZONTAL AT 3 M**

NO.	FREQ. (MHz)	EMISSION LEVEL (dBuV/m)	LIMIT (dBuV/m)	MARGIN (dB)	ANTENNA HEIGHT (m)	TABLE ANGLE (Degree)	RAW VALUE (dBuV)	CORRECTION FACTOR (dB/m)
1	#5714.90	66.1 PK	74.0	-7.9	1.02 H	303	59.30	6.80
2	#5714.90	49.4 AV	54.0	-4.6	1.02 H	303	42.60	6.80
3	#5722.90	65.7 PK	78.2	-12.5	1.00 H	312	58.90	6.80
4	#5725.00	49.7 PK	78.2	-28.5	1.66 H	299	42.90	6.80
5	*5755.00	100.2 PK			1.08 H	304	59.70	40.50
6	*5755.00	90.8 AV			1.08 H	304	50.30	40.50
7	11510.00	58.3 PK	74.0	-15.7	1.46 H	279	40.00	18.30
8	11510.00	46.5 AV	54.0	-7.5	1.46 H	279	28.20	18.30

**ANTENNA POLARITY & TEST DISTANCE: VERTICAL AT 3 M**

NO.	FREQ. (MHz)	EMISSION LEVEL (dBuV/m)	LIMIT (dBuV/m)	MARGIN (dB)	ANTENNA HEIGHT (m)	TABLE ANGLE (Degree)	RAW VALUE (dBuV)	CORRECTION FACTOR (dB/m)
1	#5714.90	69.0 PK	74.0	-5.0	1.81 V	2	62.20	6.80
2	#5714.90	52.6 AV	54.0	-1.4	1.81 V	2	45.80	6.80
3	#5722.90	73.7 PK	78.2	-4.5	2.06 V	0	66.90	6.80
4	#5725.00	56.6 PK	78.2	-21.6	2.05 V	0	49.80	6.80
5	*5755.00	103.3 PK			1.34 V	20	62.80	40.50
6	*5755.00	94.1 AV			1.34 V	20	53.60	40.50
7	11510.00	59.0 PK	74.0	-15.0	1.06 V	172	40.70	18.30
8	11510.00	47.3 AV	54.0	-6.7	1.06 V	172	29.00	18.30

**REMARKS:**

1. Emission Level(dBuV/m) = Raw Value(dBuV) + Correction Factor(dB/m)
2. Correction Factor(dB/m) = Antenna Factor(dB/m) + Cable Factor(dB)
3. The other emission levels were very low against the limit.
4. Margin value = Emission Level – Limit value
5. " \* ": Fundamental frequency.
6. " # ": The radiated frequency is out of the restricted band.



<b>CHANNEL</b>	TX Channel 159	<b>DETECTOR FUNCTION</b>	Peak (PK)
<b>FREQUENCY RANGE</b>	1GHz ~ 40GHz		Average (AV)

**ANTENNA POLARITY & TEST DISTANCE: HORIZONTAL AT 3 M**

NO.	FREQ. (MHz)	EMISSION LEVEL (dBuV/m)	LIMIT (dBuV/m)	MARGIN (dB)	ANTENNA HEIGHT (m)	TABLE ANGLE (Degree)	RAW VALUE (dBuV)	CORRECTION FACTOR (dB/m)
1	*5795.00	107.0 PK			1.03 H	305	66.50	40.50
2	*5795.00	96.8 AV			1.03 H	305	56.30	40.50
3	#5850.00	50.1 PK	78.2	-28.1	1.19 H	281	43.20	6.90
4	#5852.10	64.5 PK	78.2	-13.7	1.25 H	298	57.50	7.00
5	#5860.10	65.2 PK	74.0	-8.8	1.00 H	297	58.20	7.00
6	#5860.10	49.1 AV	54.0	-4.9	1.00 H	297	42.10	7.00
7	11590.00	59.2 PK	74.0	-14.8	1.15 H	19	40.70	18.50
8	11590.00	47.8 AV	54.0	-6.2	1.15 H	19	29.30	18.50

**ANTENNA POLARITY & TEST DISTANCE: VERTICAL AT 3 M**

NO.	FREQ. (MHz)	EMISSION LEVEL (dBuV/m)	LIMIT (dBuV/m)	MARGIN (dB)	ANTENNA HEIGHT (m)	TABLE ANGLE (Degree)	RAW VALUE (dBuV)	CORRECTION FACTOR (dB/m)
1	*5795.00	106.2 PK			1.01 V	20	65.70	40.50
2	*5795.00	97.4 AV			1.01 V	20	56.90	40.50
3	#5850.00	50.1 PK	78.2	-28.1	1.00 V	50	43.20	6.90
4	#5852.10	65.0 PK	78.2	-13.2	1.00 V	57	58.00	7.00
5	#5860.10	61.6 PK	74.0	-12.4	1.00 V	57	54.60	7.00
6	#5860.10	47.4 AV	54.0	-6.6	1.00 V	57	40.40	7.00
7	11590.00	59.3 PK	74.0	-14.7	1.15 V	55	40.80	18.50
8	11590.00	47.4 AV	54.0	-6.6	1.15 V	55	28.90	18.50

**REMARKS:**

1. Emission Level(dBuV/m) = Raw Value(dBuV) + Correction Factor(dB/m)
2. Correction Factor(dB/m) = Antenna Factor(dB/m) + Cable Factor(dB)
3. The other emission levels were very low against the limit.
4. Margin value = Emission Level – Limit value
5. " \* ": Fundamental frequency.
6. " # ": The radiated frequency is out of the restricted band.

**BELOW 1GHz WORST-CASE DATA**
**Test Mode A**
**802.11a**

<b>CHANNEL</b>	TX Channel 40	<b>DETECTOR FUNCTION</b>	Quasi-Peak (QP)
<b>FREQUENCY RANGE</b>	30MHz ~ 1GHz		

**ANTENNA POLARITY & TEST DISTANCE: HORIZONTAL AT 3 M**

NO.	FREQ. (MHz)	EMISSION LEVEL (dBuV/m)	LIMIT (dBuV/m)	MARGIN (dB)	ANTENNA HEIGHT (m)	TABLE ANGLE (Degree)	RAW VALUE (dBuV)	CORRECTION FACTOR (dB/m)
1	57.12	31.6 QP	40.0	-8.4	2.00 H	45	46.20	-14.60
2	156.28	30.1 QP	43.5	-13.4	2.00 H	96	43.80	-13.70
3	222.38	29.6 QP	46.0	-16.4	1.50 H	203	45.80	-16.20
4	313.77	34.2 QP	46.0	-11.8	1.01 H	109	46.00	-11.80
5	374.04	33.7 QP	46.0	-12.3	1.01 H	133	44.30	-10.60
6	500.42	30.1 QP	46.0	-15.9	1.50 H	186	38.20	-8.10

**ANTENNA POLARITY & TEST DISTANCE: VERTICAL AT 3 M**

NO.	FREQ. (MHz)	EMISSION LEVEL (dBuV/m)	LIMIT (dBuV/m)	MARGIN (dB)	ANTENNA HEIGHT (m)	TABLE ANGLE (Degree)	RAW VALUE (dBuV)	CORRECTION FACTOR (dB/m)
1	53.23	37.8 QP	40.0	-2.2	1.00 V	9	52.00	-14.20
2	148.50	31.6 QP	43.5	-11.9	1.00 V	123	45.40	-13.80
3	193.22	30.4 QP	43.5	-13.1	1.00 V	68	46.50	-16.10
4	313.77	30.4 QP	46.0	-15.6	1.50 V	320	42.20	-11.80
5	374.04	31.2 QP	46.0	-14.8	1.50 V	59	41.80	-10.60
6	477.09	28.0 QP	46.0	-18.0	1.00 V	333	36.50	-8.50

**REMARKS:**

1. Emission Level(dBuV/m) = Raw Value(dBuV) + Correction Factor(dB/m)
2. Correction Factor(dB/m) = Antenna Factor(dB/m) + Cable Factor(dB)
3. The other emission levels were very low against the limit.
4. Margin value = Emission Level – Limit value

**Test Mode B**
**802.11a**

<b>CHANNEL</b>	TX Channel 40	<b>DETECTOR FUNCTION</b>	Quasi-Peak (QP)
<b>FREQUENCY RANGE</b>	30MHz ~ 1GHz		

**ANTENNA POLARITY & TEST DISTANCE: HORIZONTAL AT 3 M**

NO.	FREQ. (MHz)	EMISSION LEVEL (dBuV/m)	LIMIT (dBuV/m)	MARGIN (dB)	ANTENNA HEIGHT (m)	TABLE ANGLE (Degree)	RAW VALUE (dBuV)	CORRECTION FACTOR (dB/m)
1	57.12	31.5 QP	40.0	-8.5	2.00 H	41	46.10	-14.60
2	97.95	31.2 QP	43.5	-12.3	2.00 H	243	50.30	-19.10
3	150.45	34.8 QP	43.5	-8.7	1.02 H	94	48.70	-13.90
4	237.94	25.4 QP	46.0	-20.6	1.02 H	215	40.10	-14.70
5	375.98	33.0 QP	46.0	-13.0	2.00 H	186	43.60	-10.60
6	827.06	39.6 QP	46.0	-6.4	2.00 H	210	41.10	-1.50

**ANTENNA POLARITY & TEST DISTANCE: VERTICAL AT 3 M**

NO.	FREQ. (MHz)	EMISSION LEVEL (dBuV/m)	LIMIT (dBuV/m)	MARGIN (dB)	ANTENNA HEIGHT (m)	TABLE ANGLE (Degree)	RAW VALUE (dBuV)	CORRECTION FACTOR (dB/m)
1	45.00	37.1 QP	40.0	-2.9	1.02 V	16	51.80	-14.70
2	70.73	35.0 QP	40.0	-5.0	1.50 V	5	51.30	-16.30
3	150.45	36.4 QP	43.5	-7.1	1.00 V	312	50.30	-13.90
4	374.04	31.9 QP	46.0	-14.1	1.00 V	140	42.50	-10.60
5	624.85	29.1 QP	46.0	-16.9	1.50 V	7	34.20	-5.10
6	836.78	38.6 QP	46.0	-7.4	1.00 V	283	40.00	-1.40

**REMARKS:**

1. Emission Level(dBuV/m) = Raw Value(dBuV) + Correction Factor(dB/m)
2. Correction Factor(dB/m) = Antenna Factor(dB/m) + Cable Factor(dB)
3. The other emission levels were very low against the limit.
4. Margin value = Emission Level – Limit value

## 4.2 Conducted Emission Measurement

### 4.2.1 Limits of Conducted Emission Measurement

Frequency (MHz)	Conducted Limit (dBuV)	
	Quasi-peak	Average
0.15 - 0.5	66 - 56	56 - 46
0.50 - 5.0	56	46
5.0 - 30.0	60	50

- Note: 1. The lower limit shall apply at the transition frequencies.  
 2. The limit decreases in line with the logarithm of the frequency in the range of 0.15 to 0.50MHz.

### 4.2.2 Test Instruments

Test Date: Feb. 19, 2016

Description & Manufacturer	Model No.	Serial No.	Cal. Date	Cal. Due
Test Receiver ROHDE & SCHWARZ	ESCS 30	100288	Apr. 27, 2015	Apr. 26, 2016
RF signal cable (with 10dB PAD) Woken	5D-FB	Cable-cond2-01	Dec. 26, 2015	Dec. 25, 2016
LISN ROHDE & SCHWARZ (EUT)	ESH2-Z5	100100	Jan. 11, 2016	Jan. 10, 2017
LISN ROHDE & SCHWARZ (Peripheral)	ESH3-Z5	100312	Jul. 21, 2015	Jul. 20, 2016
Software ADT	BV ADT_Cond_ V7.3.7.3	NA	NA	NA

- Note: 1. The calibration interval of the above test instruments is 12 months and the calibrations are traceable to NML/ROC and NIST/USA.  
 2. The test was performed in HwaYa Shielded Room 2.  
 3. The VCCI Site Registration No. is C-2047.

#### 4.2.3 Test Procedure

- a. The EUT was placed 0.4 meters from the conducting wall of the shielded room with EUT being connected to the power mains through a line impedance stabilization network (LISN). Other support units were connected to the power mains through another LISN. The two LISNs provide 50 ohm/ 50uH of coupling impedance for the measuring instrument.
- b. Both lines of the power mains connected to the EUT were checked for maximum conducted interference.
- c. The frequency range from 150kHz to 30MHz was searched. Emission levels under (Limit - 20dB) was not recorded.

**NOTE:** The resolution bandwidth and video bandwidth of test receiver is 9kHz for quasi-peak detection (QP) and average detection (AV) at frequency 0.15MHz-30MHz.

#### 4.2.4 Deviation from Test Standard

No deviation.

#### 4.2.5 Test Setup



4.2.7 Test Results

Test Mode A

802.11a

Phase	Line (L)	Detector Function	Quasi-Peak (QP) / Average (AV)
-------	----------	-------------------	--------------------------------

No	Freq. [MHz]	Corr. Factor (dB)	Reading Value		Emission Level		Limit		Margin	
			[dB (uV)]		[dB (uV)]		[dB (uV)]		(dB)	
			Q.P.	AV.	Q.P.	AV.	Q.P.	AV.	Q.P.	AV.
1	0.15272	10.18	25.45	15.28	35.63	25.46	65.85	55.85	-30.22	-30.39
2	0.20614	10.21	18.59	9.84	28.80	20.05	63.36	53.36	-34.56	-33.31
3	0.54063	10.26	18.91	13.36	29.17	23.62	56.00	46.00	-26.83	-22.38
4	1.23828	10.33	12.01	7.51	22.34	17.84	56.00	46.00	-33.66	-28.16
5	2.72656	10.39	11.47	6.56	21.86	16.95	56.00	46.00	-34.14	-29.05
6	20.05078	10.68	15.56	8.68	26.24	19.36	60.00	50.00	-33.76	-30.64

REMARKS:

1. Q.P. and AV. are abbreviations of quasi-peak and average individually.
2. The emission levels of other frequencies were very low against the limit.
3. Margin value = Emission level - Limit value
4. Correction factor = Insertion loss + Cable loss
5. Emission Level = Correction Factor + Reading Value.

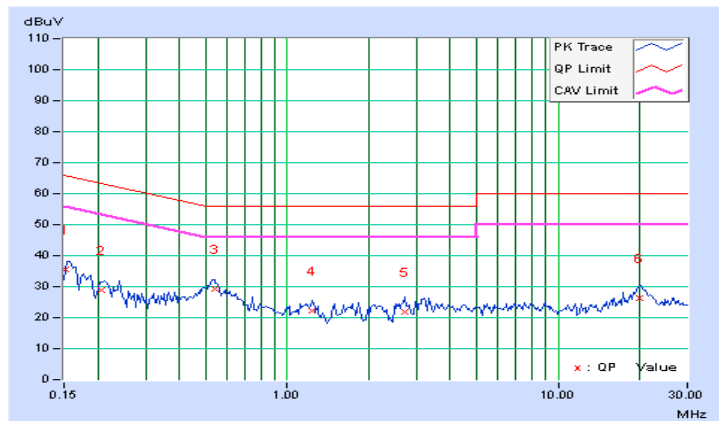

Phase	Neutral (N)	Detector Function	Quasi-Peak (QP) / Average (AV)
-------	-------------	-------------------	--------------------------------

No	Freq. [MHz]	Corr. Factor (dB)	Reading Value		Emission Level		Limit		Margin	
			[dB (uV)]		[dB (uV)]		[dB (uV)]		(dB)	
			Q.P.	AV.	Q.P.	AV.	Q.P.	AV.	Q.P.	AV.
1	0.15391	10.19	24.54	14.16	34.73	24.35	65.79	55.79	-31.06	-31.44
2	0.17870	10.20	21.18	11.66	31.38	21.86	64.55	54.55	-33.17	-32.69
3	0.53273	10.30	19.25	14.12	29.55	24.42	56.00	46.00	-26.45	-21.58
4	1.68359	10.37	10.32	6.55	20.69	16.92	56.00	46.00	-35.31	-29.08
5	2.19141	10.42	10.21	6.28	20.63	16.70	56.00	46.00	-35.37	-29.30
6	20.28125	10.88	12.52	5.82	23.40	16.70	60.00	50.00	-36.60	-33.30

**REMARKS:**

1. Q.P. and AV. are abbreviations of quasi-peak and average individually.
2. The emission levels of other frequencies were very low against the limit.
3. Margin value = Emission level - Limit value
4. Correction factor = Insertion loss + Cable loss
5. Emission Level = Correction Factor + Reading Value.

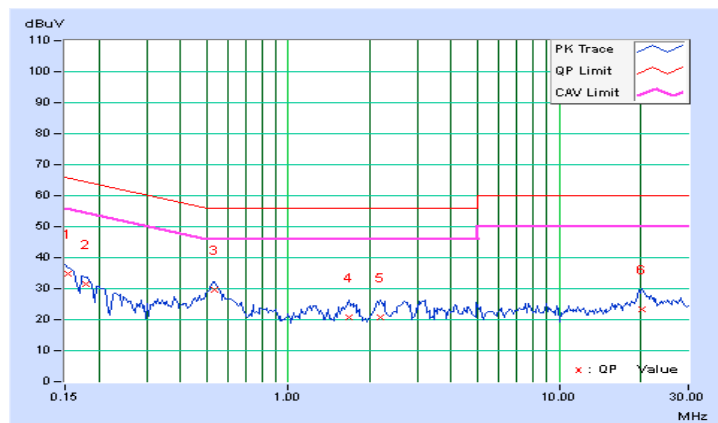

**Test Mode B**  
**802.11a**

Phase	Line (L)	Detector Function	Quasi-Peak (QP) / Average (AV)
-------	----------	-------------------	--------------------------------

No	Freq. [MHz]	Corr. Factor (dB)	Reading Value		Emission Level		Limit		Margin	
			[dB (uV)]		[dB (uV)]		[dB (uV)]		(dB)	
			Q.P.	AV.	Q.P.	AV.	Q.P.	AV.	Q.P.	AV.
1	0.15781	10.18	25.46	18.51	35.64	28.69	65.58	55.58	-29.93	-26.88
2	0.18516	10.20	20.91	14.29	31.11	24.49	64.25	54.25	-33.14	-29.76
<b>3</b>	<b>0.53672</b>	<b>10.26</b>	<b>24.33</b>	<b>19.67</b>	<b>34.59</b>	<b>29.93</b>	<b>56.00</b>	<b>46.00</b>	<b>-21.41</b>	<b>-16.07</b>
4	1.18359	10.32	14.57	10.21	24.89	20.53	56.00	46.00	-31.11	-25.47
5	3.13672	10.40	13.82	8.49	24.22	18.89	56.00	46.00	-31.78	-27.11
6	20.11719	10.68	14.07	7.16	24.75	17.84	60.00	50.00	-35.25	-32.16

**REMARKS:**

1. Q.P. and AV. are abbreviations of quasi-peak and average individually.
2. The emission levels of other frequencies were very low against the limit.
3. Margin value = Emission level - Limit value
4. Correction factor = Insertion loss + Cable loss
5. Emission Level = Correction Factor + Reading Value.

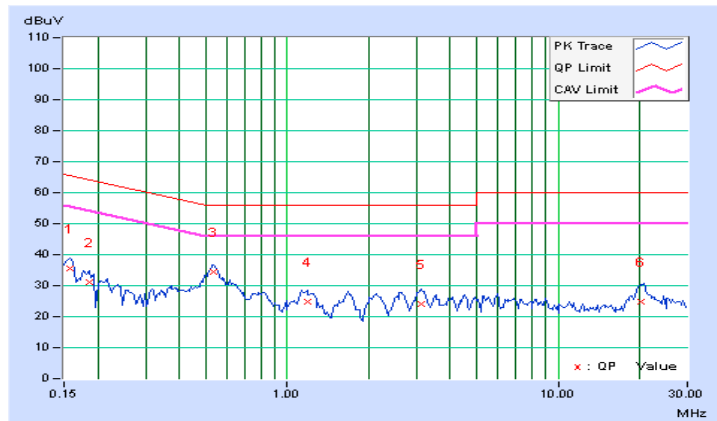

Phase	Neutral (N)	Detector Function	Quasi-Peak (QP) / Average (AV)
-------	-------------	-------------------	--------------------------------

No	Freq. [MHz]	Corr. Factor (dB)	Reading Value [dB (uV)]		Emission Level [dB (uV)]		Limit [dB (uV)]		Margin (dB)	
			Q.P.	AV.	Q.P.	AV.	Q.P.	AV.	Q.P.	AV.
			1	0.15382	10.19	25.02	16.06	35.21	26.25	65.79
2	0.54063	10.30	23.50	18.32	33.80	28.62	56.00	46.00	-22.20	-17.38
3	1.09878	10.30	11.31	6.92	21.61	17.22	56.00	46.00	-34.39	-28.78
4	1.62891	10.37	14.14	10.00	24.51	20.37	56.00	46.00	-31.49	-25.63
5	3.01953	10.48	13.27	8.38	23.75	18.86	56.00	46.00	-32.25	-27.14
6	20.25391	10.88	12.10	4.95	22.98	15.83	60.00	50.00	-37.02	-34.17

**REMARKS:**

1. Q.P. and AV. are abbreviations of quasi-peak and average individually.
2. The emission levels of other frequencies were very low against the limit.
3. Margin value = Emission level - Limit value
4. Correction factor = Insertion loss + Cable loss
5. Emission Level = Correction Factor + Reading Value.

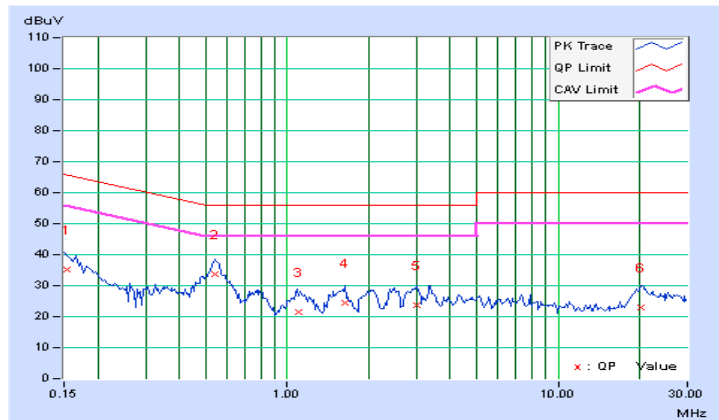

### 4.3 Transmit Power Measurement

#### 4.3.1 Limits of Transmit Power Measurement

Operation Band	EUT Category	LIMIT
U-NII-1	Outdoor Access Point	1 Watt (30 dBm) (Max. e.i.r.p)

\*B is the 26 dB emission bandwidth in megahertz

Per KDB 662911 Method of conducted output power measurement on IEEE 802.11 devices,

Array Gain = 0 dB (i.e., no array gain) for  $N_{ANT} \leq 4$ ;

Array Gain = 0 dB (i.e., no array gain) for channel widths  $\geq 40$  MHz for any  $N_{ANT}$ ;

Array Gain =  $5 \log(N_{ANT}/N_{SS})$  dB or 3 dB, whichever is less for 20-MHz channel widths with  $N_{ANT} \geq 5$ .

For power measurements on all other devices: Array Gain =  $10 \log(N_{ANT}/N_{SS})$  dB.

#### 4.3.2 Test Setup

#### 4.3.3 Test Instruments

Refer to section 4.1.2 to get information of above instrument.

#### 4.3.4 Test Procedure

##### **FOR AVERAGE POWER MEASUREMENT**

Method PM is used to perform output power measurement, trigger and gating function of wide band power meter is enabled to measure max output power of TX on burst. Duty factor is not added to measured value.

##### **FOR OCCUPIED BANDWIDTH**

The transmitter output was connected to the spectrum analyzer through an attenuator. The bandwidth of the fundamental frequency was measured by spectrum analyzer with 300 kHz RBW and 1MHz VBW. The width of a frequency band such that, below the lower and above the upper frequency limits, the mean powers emitted are each equal to a specified percentage 0.5 % of the total mean power of a given emission

#### 4.3.5 Deviation from Test Standard

No deviation.

#### 4.3.6 EUT Operating Conditions

The software provided by client to enable the EUT under transmission Condition continuously at lowest, middle and highest channel frequencies individually.

#### 4.3.7 Test Result

#### POWER OUTPUT:

##### 802.11a

Chan.	Chan. Freq. (MHz)	Maximum Conducted Power (dBm)		Total Power (mW)	Total Power (dBm)	Power Limit (dBm)	Pass / Fail
		Chain 0	Chain 1				
36	5180	16.18	16.23	83.471	19.22	30.00	Pass
40	5200	19.18	19.31	<b>168.104</b>	22.26	30.00	Pass
48	5240	18.76	18.89	152.608	21.84	30.00	Pass
149	5745	17.39	16.61	100.642	20.03	30.00	Pass
157	5785	18.84	18.11	<b>141.274</b>	21.50	30.00	Pass
165	5825	18.45	18.03	133.517	21.26	30.00	Pass

##### 802.11n (HT20)

Chan.	Chan. Freq. (MHz)	Maximum Conducted Power (dBm)		Total Power (mW)	Total Power (dBm)	Power Limit (dBm)	Pass / Fail
		Chain 0	Chain 1				
36	5180	16.53	15.77	82.735	19.18	30.00	Pass
40	5200	19.08	19.12	162.568	22.11	30.00	Pass
48	5240	18.85	18.78	152.245	21.83	30.00	Pass
149	5745	17.03	15.68	87.449	19.42	30.00	Pass
157	5785	18.80	17.80	136.114	21.34	30.00	Pass
165	5825	18.53	18.19	137.202	21.37	30.00	Pass

##### 802.11n (HT40)

Chan.	Chan. Freq. (MHz)	Maximum Conducted Power (dBm)		Total Power (mW)	Total Power (dBm)	Power Limit (dBm)	Pass / Fail
		Chain 0	Chain 1				
38	5190	14.21	14.59	55.137	17.41	30.00	Pass
46	5230	18.21	18.81	142.255	21.53	30.00	Pass
151	5755	14.47	14.80	58.19	17.65	30.00	Pass
159	5795	18.82	17.76	135.912	21.33	30.00	Pass

**26dB BANDWIDTH:**
**802.11a**

Channel	Channel Frequency (MHz)	26dBc Bandwidth (MHz)		Pass / Fail
		Chain 0	Chain 1	
36	5180	29.08	28.38	PASS
40	5200	39.39	38.83	PASS
48	5240	38.21	36.51	PASS

**802.11n (HT20)**

Channel	Channel Frequency (MHz)	26dBc Bandwidth (MHz)		Pass / Fail
		Chain 0	Chain 1	
36	5180	29.80	26.66	PASS
40	5200	42.46	40.37	PASS
48	5240	38.68	38.39	PASS

**802.11n (HT40)**

Channel	Channel Frequency (MHz)	26dBc Bandwidth (MHz)		Pass / Fail
		Chain 0	Chain 1	
38	5190	50.85	51.36	PASS
46	5230	85.21	87.22	PASS



### SPECTRUM PLOT OF WORST VALUE

802.11a

802.11n (HT20)

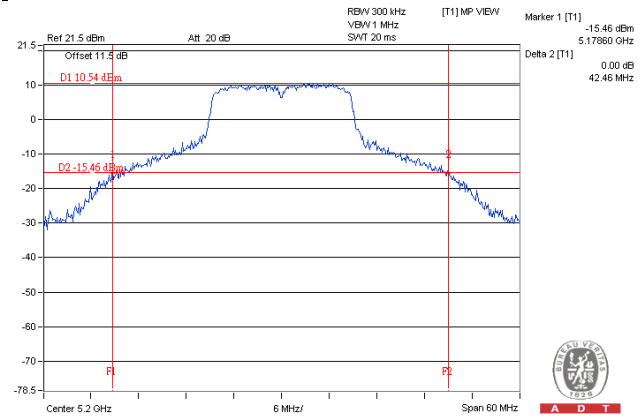
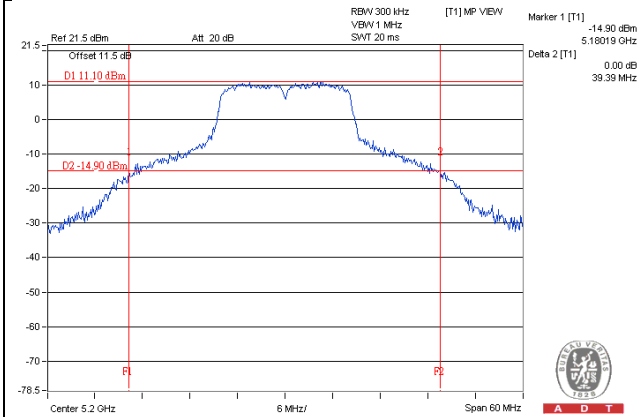

802.11n (HT40)

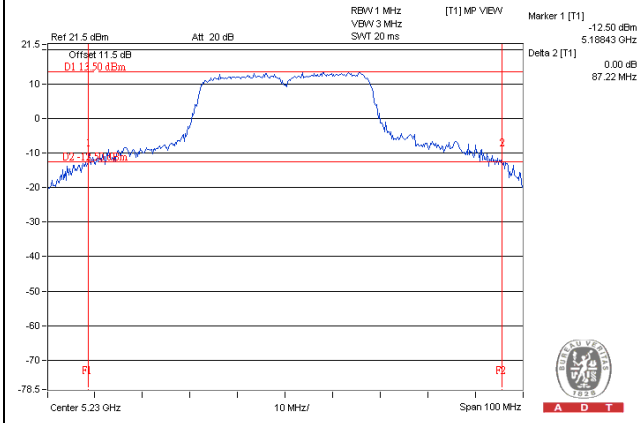

**Occupied Bandwidth:**
**802.11a**

Channel	Channel Frequency (MHz)	Occupied Bandwidth (MHz)		Pass / Fail
		Chain 0	Chain 1	
36	5180	17.04	17.04	Pass
40	5200	20.52	20.40	Pass
48	5240	19.44	18.60	Pass
149	5745	17.30	16.78	Pass
157	5785	19.80	17.16	Pass
165	5825	19.92	17.28	Pass

**802.11n (HT20)**

Channel	Channel Frequency (MHz)	Occupied Bandwidth (MHz)		Pass / Fail
		Chain 0	Chain 1	
36	5180	18.24	18.00	Pass
40	5200	22.08	21.12	Pass
48	5240	19.32	19.44	Pass
149	5745	18.12	18.09	Pass
157	5785	20.04	18.12	Pass
165	5825	20.40	18.24	Pass

**802.11n (HT40)**

Channel	Channel Frequency (MHz)	Occupied Bandwidth (MHz)		Pass / Fail
		Chain 0	Chain 1	
38	5190	37.08	37.08	Pass
46	5230	38.16	38.64	Pass
151	5755	37.44	37.20	Pass
159	5795	38.40	37.56	Pass

**SPECTRUM PLOT OF WORST VALUE**

**802.11a**

**802.11n (HT20)**

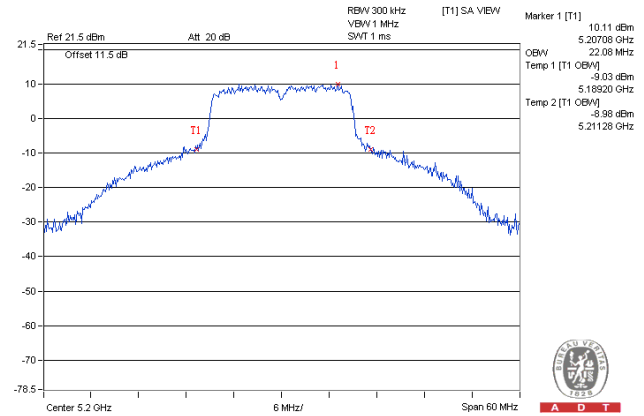
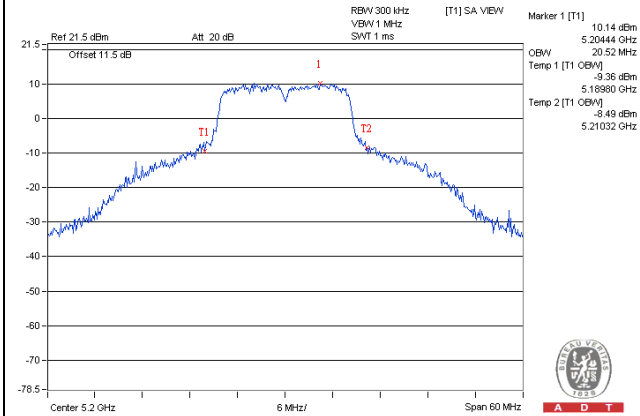

**802.11n (HT40)**

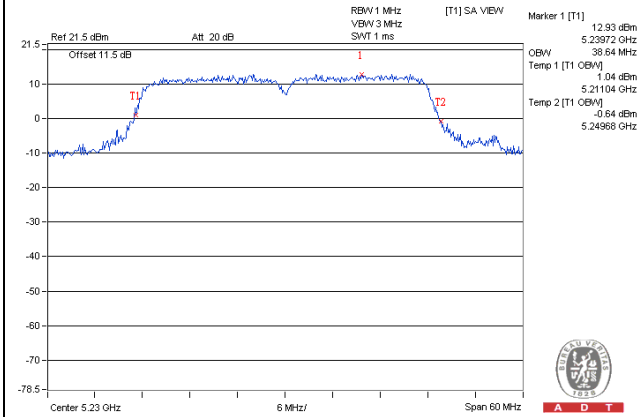

## 4.4 Peak Power Spectral Density Measurement

### 4.4.1 Limits of Peak Power Spectral Density Measurement

Operation Band	EUT Category		LIMIT
U-NII-1		Outdoor Access Point	17dBm/ MHz
		Fixed point-to-point Access Point	
	√	Indoor Access Point	
		Mobile and Portable client device	11dBm/ MHz
U-NII-2A	---		11dBm/ MHz
U-NII-2C	---		11dBm/ MHz
U-NII-3	√		30dBm/ 500kHz

### 4.4.2 Test Setup

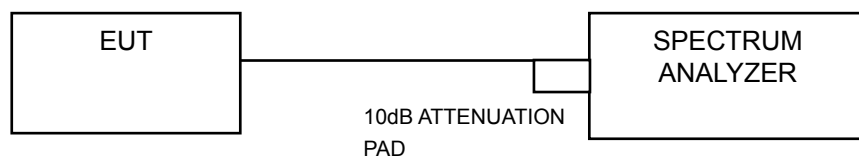

### 4.4.3 Test Instruments

Refer to section 4.1.2 to get information of above instrument.

### 4.4.4 Test Procedure

#### For U-NII-1 band:

Using method SA-2

- 1) Set span to encompass the entire emission bandwidth (EBW) of the signal.
- 2) Set RBW = 1MHz, Set VBW  $\geq$  3MHz, Detector = RMS
- 3) Set Channel power measure = 1MHz
- 4) Sweep time = auto, trigger set to "free run".
- 5) Trace average at least 100 traces in power averaging mode.
- 6) Record the max value and add  $10 \log (1/\text{duty cycle})$

#### For U-NII-3 band:

- 1) Set span to encompass the entire emission bandwidth (EBW) of the signal.
- 2) Set RBW = 500 kHz, Set VBW  $\geq$  3 RBW, Detector = RMS
- 3) Sweep time = auto, trigger set to "free run".
- 4) Trace average at least 100 traces in power averaging mode.
- 5) Record the max value and add  $10 \log (1/\text{duty cycle})$
- 6) Scale the observed power level to an equivalent value in 500 kHz by adjusting (reducing) the measured power by a bandwidth correction factor (BWCF) where  $\text{BWCF} = 10 \log (500\text{kHz}/300\text{kHz})$



4.4.5 Deviation from Test Standard

No deviation.

4.4.6 EUT Operating Condition

Same as Item 4.3.6.

4.4.7 Test Results

**For U-NII-1 Band**

**802.11a**

Chan.	Freq. (MHz)	PSD (dBm)		Total PSD w/o Duty Factor (dBm)	Duty Factor	Total PSD with Duty Factor (dBm)	Max. Limit (dBm)	Pass / Fail
		Chain 0	Chain 1					
36	5180	3.84	3.98	6.92	0.15	7.07	14.74	Pass
40	5200	6.54	5.99	9.28	0.15	9.43	14.74	Pass
48	5240	5.67	5.33	8.51	0.15	8.66	14.74	Pass

**NOTE:** 1. Method 1 of power density measurement of KDB 662911 is using for calculating total power density. Total power density is summing entire spectra across corresponding frequency bins on the various outputs by computer.

**2. For U-NII-1 Band:**

Directional gain =  $10 \log[(10^{G1/20} + 10^{G2/20} + \dots + 10^{GN/20})^2/2]$  = 8.26 dBi > 6dBi, so the power density limit shall be reduced to  $17-(8.26-6) = 14.74\text{dBm}$ .

**802.11n (HT20)**

Chan.	Freq. (MHz)	PSD (dBm)		Total PSD w/o Duty Factor (dBm)	Duty Factor	Total PSD with Duty Factor (dBm)	Max. Limit (dBm)	Pass / Fail
		Chain 0	Chain 1					
36	5180	3.07	2.05	5.61	0.24	5.85	14.74	Pass
40	5200	6.06	5.79	8.94	0.24	9.18	14.74	Pass
48	5240	5.04	5.26	8.17	0.24	8.41	14.74	Pass

**NOTE:** 1. Method 1 of power density measurement of KDB 662911 is using for calculating total power density. Total power density is summing entire spectra across corresponding frequency bins on the various outputs by computer.

**2. For U-NII-1 Band:**

Directional gain =  $10 \log[(10^{G1/20} + 10^{G2/20} + \dots + 10^{GN/20})^2/2]$  = 8.26 dBi > 6dBi, so the power density limit shall be reduced to  $17-(8.26-6) = 14.74\text{dBm}$ .

**802.11n (HT40)**

Chan.	Freq. (MHz)	PSD (dBm)		Total PSD w/o Duty Factor (dBm)	Duty Factor	Total PSD with Duty Factor (dBm)	Max. Limit (dBm)	Pass / Fail
		Chain 0	Chain 1					
38	5190	-1.79	-1.58	1.33	0.22	1.55	14.74	Pass
46	5230	2.48	2.80	5.66	0.22	5.88	14.74	Pass

**NOTE:** 1. Method 1 of power density measurement of KDB 662911 is using for calculating total power density. Total power density is summing entire spectra across corresponding frequency bins on the various outputs by computer.

**2. For U-NII-1 Band:**

Directional gain =  $10 \log[(10^{G1/20} + 10^{G2/20} + \dots + 10^{GN/20})^2/2]$  = 8.26 dBi > 6dBi, so the power density limit shall be reduced to  $17-(8.26-6) = 14.74\text{dBm}$ .

### SPECTRUM PLOT OF WORST VALUE

802.11a

802.11n (HT20)

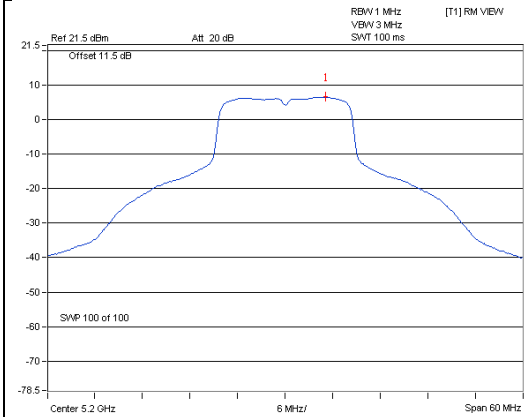

A D T

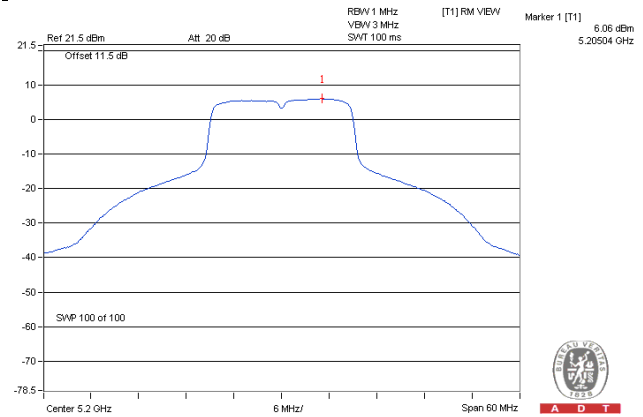

A D T

802.11n (HT40)

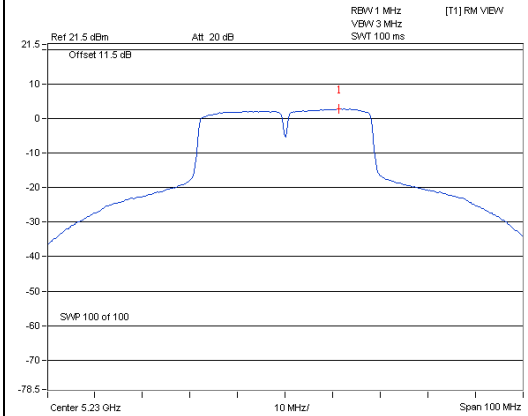

A D T

## For U-NII-3 Band

### 802.11a

TX chain	Chan.	Freq. (MHz)	PSD (dBm /300kHz)	PSD (dBm /500kHz)	10 log (N=2) dB	Duty Factor	Total PSD (dBm /500kHz)	Limit (dBm /500kHz)	Pass /Fail
0	149	5745	-3.56	-1.34	3.01	0.15	1.82	27.74	Pass
	157	5785	-2.07	0.15	3.01	0.15	3.31	27.74	Pass
	165	5825	-1.70	0.52	3.01	0.15	3.68	27.74	Pass
1	149	5745	-5.28	-3.06	3.01	0.15	0.10	27.74	Pass
	157	5785	-3.30	-1.08	3.01	0.15	2.08	27.74	Pass
	165	5825	-2.78	-0.56	3.01	0.15	2.60	27.74	Pass

**NOTE:** Directional gain =  $10 \log[(10^{G1/20} + 10^{G2/20} + \dots + 10^{GN/20})^2/2] = 8.26 \text{ dBi} > 6\text{dB}$ , so the power density limit shall be reduced to  $30 - (8.26 - 6) = 27.74\text{dBm}$ .

### 802.11n (HT20)

TX chain	Chan.	Freq. (MHz)	PSD (dBm /300kHz)	PSD (dBm /500kHz)	10 log (N=2) dB	Duty Factor	Total PSD (dBm /500kHz)	Limit (dBm /500kHz)	Pass /Fail
0	149	5745	-4.22	-2.00	3.01	0.24	1.25	27.74	Pass
	157	5785	-2.26	-0.04	3.01	0.24	3.21	27.74	Pass
	165	5825	-2.37	-0.15	3.01	0.24	3.10	27.74	Pass
1	149	5745	-5.25	-3.03	3.01	0.24	0.22	27.74	Pass
	157	5785	-3.61	-1.39	3.01	0.24	1.86	27.74	Pass
	165	5825	-3.38	-1.16	3.01	0.24	2.09	27.74	Pass

**NOTE:** Directional gain =  $10 \log[(10^{G1/20} + 10^{G2/20} + \dots + 10^{GN/20})^2/2] = 8.26 \text{ dBi} > 6\text{dB}$ , so the power density limit shall be reduced to  $30 - (8.26 - 6) = 27.74\text{dBm}$ .

### 802.11n (HT40)

TX chain	Chan.	Freq. (MHz)	PSD (dBm /300kHz)	PSD (dBm /500kHz)	10 log (N=2) dB	Duty Factor	Total PSD (dBm /500kHz)	Limit (dBm /500kHz)	Pass /Fail
0	151	5755	-10.65	-8.43	3.01	0.22	-5.20	27.74	Pass
	159	5795	-6.17	-3.95	3.01	0.22	-0.72	27.74	Pass
1	151	5755	-11.46	-9.24	3.01	0.22	-6.01	27.74	Pass
	159	5795	-7.17	-4.95	3.01	0.22	-1.72	27.74	Pass

**NOTE:** Directional gain =  $10 \log[(10^{G1/20} + 10^{G2/20} + \dots + 10^{GN/20})^2/2] = 8.26 \text{ dBi} > 6\text{dB}$ , so the power density limit shall be reduced to  $30 - (8.26 - 6) = 27.74\text{dBm}$ .

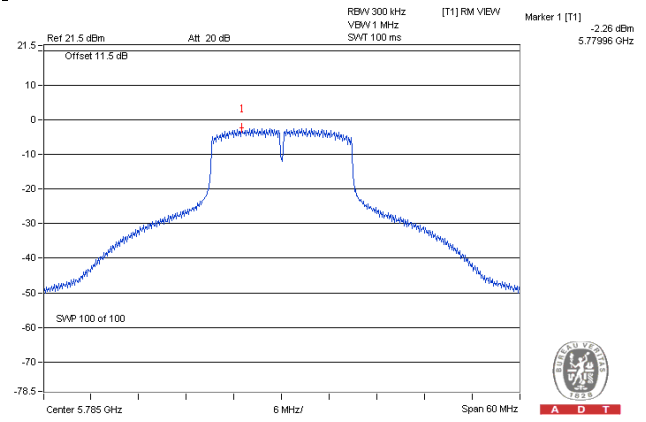
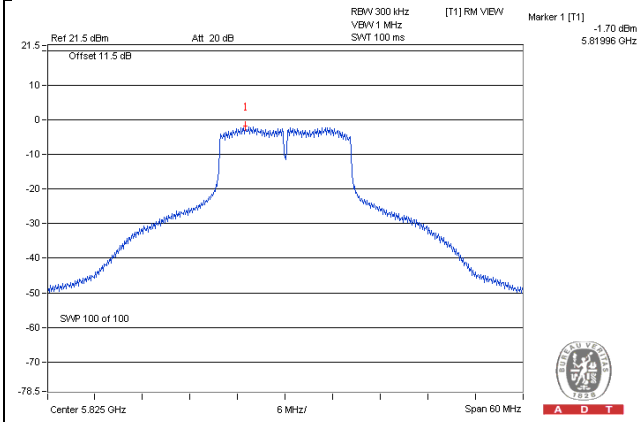
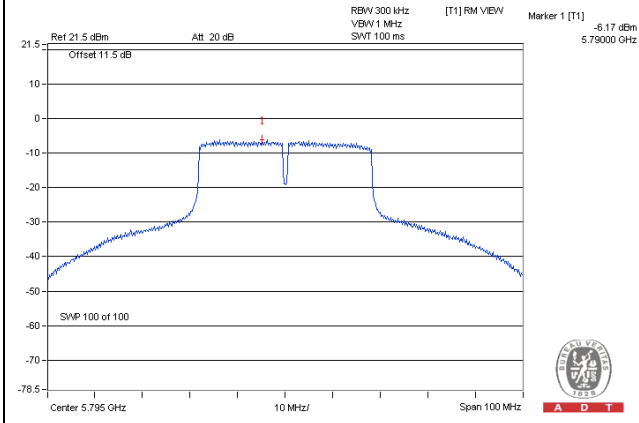

**SPECTRUM PLOT OF WORST VALUE****802.11a****802.11n (HT20)****802.11n (HT40)**

## 4.5 Frequency Stability

### 4.5.1 Limits of Frequency Stability Measurement

The frequency of the carrier signal shall be maintained within band of operation

### 4.5.2 Test Setup

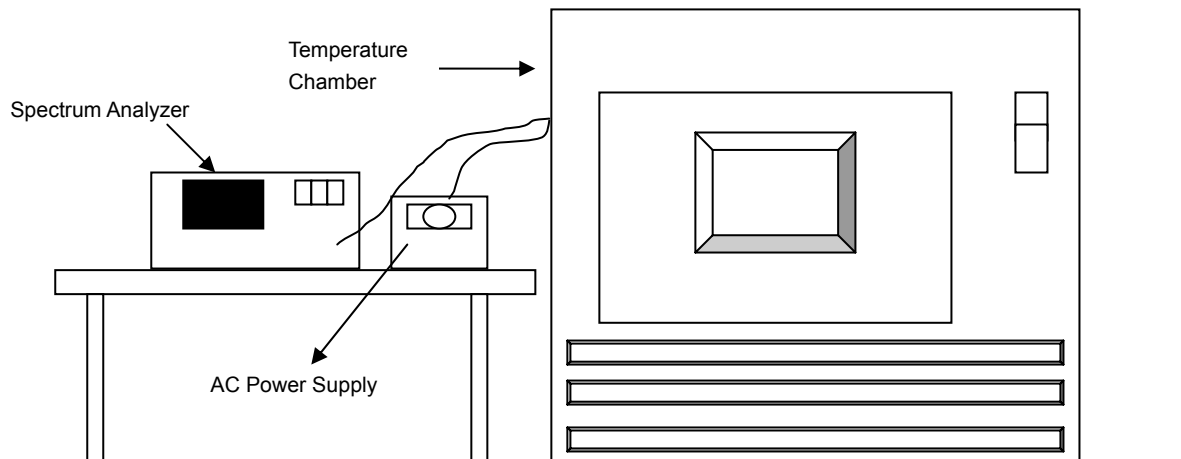

### 4.5.3 Test Instruments

Refer to section 4.1.2 to get information of above instrument.

### 4.5.4 Test Procedure

- The EUT was placed inside the environmental test chamber and powered by nominal AC voltage.
- Turn the EUT on and couple its output to a spectrum analyzer.
- Turn the EUT off and set the chamber to the highest temperature specified.
- Allow sufficient time (approximately 30 min) for the temperature of the chamber to stabilize, turn the EUT on and measure the operating frequency after 2, 5, and 10 minutes.
- Repeat step 2 and 3 with the temperature chamber set to the lowest temperature.
- The test chamber was allowed to stabilize at +20 degree C for a minimum of 30 minutes. The supply voltage was then adjusted on the EUT from 85% to 115% and the frequency record.

### 4.5.5 Deviation from Test Standard

No deviation.

### 4.5.6 EUT Operating Condition

Set the EUT transmit at un-modulation mode to test frequency stability.



#### 4.5.7 Test Results

FREQUEMNCY STABILITY VERSUS TEMP.

OPERATING FREQUENCY: 5240MHz

TEMP.  
(

## 4.6 6dB Bandwidth Measurement

### 4.6.1 Limits of 6dB Bandwidth Measurement

The minimum of 6dB Bandwidth Measurement is 0.5MHz.

### 4.6.2 Test Setup

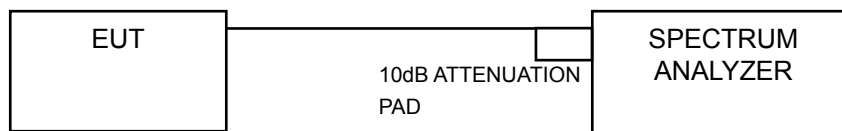

### 4.6.3 Test Instruments

Refer to section 4.1.2 to get information of above instrument.

### 4.6.4 Test Procedure

#### MEASUREMENT PROCEDURE REF

- Set resolution bandwidth (RBW) = 100kHz
- Set the video bandwidth (VBW)  $\geq 3 \times$  RBW, Detector = Peak.
- Trace mode = max hold.
- Sweep = auto couple.
- Measure the maximum width of the emission that is constrained by the frequencies associated with the two amplitude points (upper and lower) that are attenuated by 6 dB relative to the maximum level measured in the fundamental emission

### 4.6.5 Deviation from Test Standard

No deviation.

### 4.6.6 EUT Operating Condition

The software provided by client to enable the EUT under transmission Condition continuously at lowest, middle and highest channel frequencies individually.

#### 4.6.7 Test Results

##### 802.11a

Channel	Frequency (MHz)	6dB Bandwidth (MHz)		Minimum Limit (MHz)	Pass / Fail
		Chain 0	Chain 1		
149	5745	16.35	16.34	0.5	PASS
157	5785	16.37	16.35	0.5	PASS
165	5825	15.51	16.31	0.5	PASS

##### 802.11n (HT20)

Channel	Frequency (MHz)	6dB Bandwidth (MHz)		Minimum Limit (MHz)	Pass / Fail
		Chain 0	Chain 1		
149	5745	16.50	17.33	0.5	PASS
157	5785	16.06	16.73	0.5	PASS
165	5825	16.96	17.08	0.5	PASS

##### 802.11n (HT40)

Channel	Frequency (MHz)	6dB Bandwidth (MHz)		Minimum Limit (MHz)	Pass / Fail
		Chain 0	Chain 1		
151	5755	36.06	35.89	0.5	PASS
159	5795	36.01	35.90	0.5	PASS

### SPECTRUM PLOT OF WORST VALUE

802.11a

802.11n (HT20)

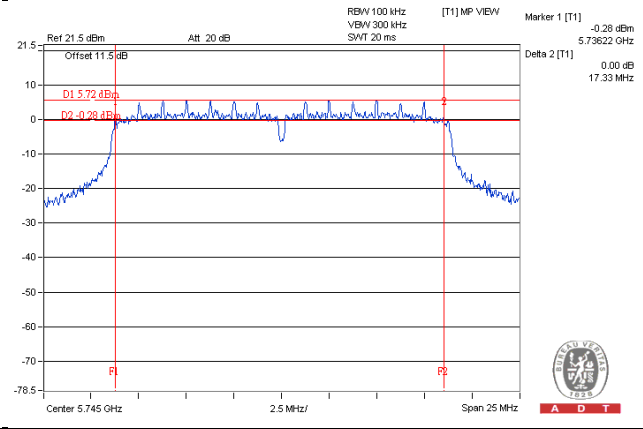
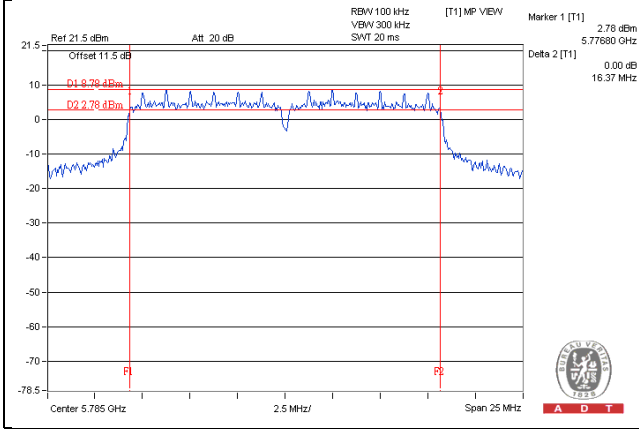

802.11n (HT40)

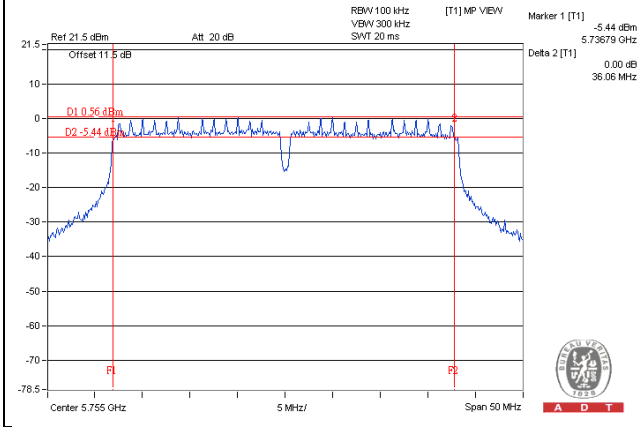

## 5 Pictures of Test Arrangements

Please refer to the attached file (Test Setup Photo).

## Appendix – Information on the Testing Laboratories

We, Bureau Veritas Consumer Products Services (H.K.) Ltd., Taoyuan Branch, were founded in 1988 to provide our best service in EMC, Radio, Telecom and Safety consultation. Our laboratories are accredited and approved according to ISO/IEC 17025.

If you have any comments, please feel free to contact us at the following:

**Linko EMC/RF Lab**

Tel: 886-2-26052180

Fax: 886-2-26051924

**Hsin Chu EMC/RF/Telecom Lab**

Tel: 886-3-6668565

Fax: 886-3-6668323

**Hwa Ya EMC/RF/Safety**

Tel: 886-3-3183232

Fax: 886-3-3270892

**Email:** [service.adt@tw.bureauveritas.com](mailto:service.adt@tw.bureauveritas.com)

**Web Site:** [www.bureauveritas-adt.com](http://www.bureauveritas-adt.com)

The address and road map of all our labs can be found in our web site also.

--- END ---