

FCC Test Report

Report No.: RF150702C09A

FCC ID: A8J-EWS510AP

Test Model: EWS510AP

Received Date: Jun. 29, 2015

Test Date: Jul. 09 ~ Jul. 29, 2015 (all tests, except radiated emission below 1GHz and conducted emission items)

Feb. 18 ~ Feb. 19, 2016 (Radiated emission below 1GHz and conducted emission items)

Issued Date: Mar. 03, 2016

Applicant: EnGenius Technologies

Address: 1580 Scenic Avenue, Costa Mesa, CA92626

Issued By: Bureau Veritas Consumer Products Services (H.K.) Ltd., Taoyuan Branch

Lab Address: No. 47-2, 14th Ling, Chia Pau Vil., Lin Kou Dist., New Taipei City, Taiwan

Test Location: No. 19, Hwa Ya 2nd Rd., Wen Hwa Vil., Kwei Shan Dist., Taoyuan City 33383, TAIWAN (R.O.C.)



This report is for your exclusive use. Any copying or replication of this report to or for any other person or entity, or use of our name or trademark, is permitted only with our prior written permission. This report sets forth our findings solely with respect to the test samples identified herein. The results set forth in this report are not indicative or representative of the quality or characteristics of the lot from which a test sample was taken or any similar or identical product unless specifically and expressly noted. Our report includes all of the tests requested by you and the results thereof based upon the information that you provided to us. You have 60 days from date of issuance of this report to notify us of any material error or omission caused by our negligence, provided, however, that such notice shall be in writing and shall specifically address the issue you wish to raise. A failure to raise such issue within the prescribed time shall constitute your unqualified acceptance of the completeness of this report, the tests conducted and the correctness of the report contents. Unless specific mention, the uncertainty of measurement has been explicitly taken into account to declare the compliance or non-compliance to the specification. This report should not be used by the client to claim product certification, approval, or endorsement by TAF or any government agencies.

Table of Contents

Release Control Record	4
1 Certificate of Conformity	5
2 Summary of Test Results	6
2.1 Measurement Uncertainty.....	6
2.2 Modification Record.....	6
3 General Information	7
3.1 General Description of EUT.....	7
3.2 Description of Test Modes.....	8
3.2.1 Test Mode Applicability and Tested Channel Detail.....	9
3.3 Duty Cycle of Test Signal.....	11
3.4 Description of Support Units.....	12
3.4.1 Configuration of System under Test.....	13
3.5 General Description of Applied Standards.....	14
4 Test Types and Results	15
4.1 Radiated Emission and Bandedge Measurement.....	15
4.1.1 Limits of Radiated Emission and Bandedge Measurement.....	15
4.1.2 Test Instruments.....	16
4.1.3 Test Procedures.....	18
4.1.4 Deviation from Test Standard.....	18
4.1.5 Test Set Up.....	19
4.1.6 EUT Operating Conditions.....	19
4.1.7 Test Results.....	20
4.2 Conducted Emission Measurement.....	34
4.2.1 Limits of Conducted Emission Measurement.....	34
4.2.2 Test Instruments.....	34
4.2.3 Test Procedures.....	35
4.2.4 Deviation from Test Standard.....	35
4.2.5 Test Setup.....	35
4.2.6 EUT Operating Conditions.....	35
4.2.7 Test Results.....	36
4.3 6dB Bandwidth Measurement.....	40
4.3.1 Limits of 6dB Bandwidth Measurement.....	40
4.3.2 Test Setup.....	40
4.3.3 Test Instruments.....	40
4.3.4 Test Procedure.....	40
4.3.5 Deviation from Test Standard.....	40
4.3.6 EUT Operating Conditions.....	40
4.3.7 Test Result.....	41
4.4 Conducted Output Power Measurement.....	43
4.4.1 Limits of Conducted Output Power Measurement.....	43
4.4.2 Test Setup.....	43
4.4.3 Test Instruments.....	43
4.4.4 Test Procedures.....	43
4.4.5 Deviation from Test Standard.....	43
4.4.6 EUT Operating Conditions.....	43
4.4.7 Test Results.....	44
4.5 Power Spectral Density Measurement.....	46
4.5.1 Limits of Power Spectral Density Measurement.....	46
4.5.2 Test Setup.....	46
4.5.3 Test Instruments.....	46
4.5.4 Test Procedure.....	46
4.5.5 Deviation from Test Standard.....	46
4.5.6 EUT Operating Condition.....	46



4.5.7 Test Results	47
4.6 Conducted Out of Band Emission Measurement.....	49
4.6.1 Limits of Conducted Out of Band Emission Measurement	49
4.6.2 Test Setup.....	49
4.6.3 Test Instruments	49
4.6.4 Test Procedure	49
4.6.5 Deviation from Test Standard	49
4.6.6 EUT Operating Condition	49
4.6.7 Test Results	49
5 Pictures of Test Arrangements.....	58
Appendix – Information on the Testing Laboratories	59



A D T

Release Control Record

Issue No.	Description	Date Issued
RF150702C09A	Original release.	Mar. 03, 2016



1 Certificate of Conformity

Product: Dual Band Wireless N600 Managed Wall Plate Access Point
Brand: EnGenius
Test Model: EWS510AP
Sample Status: Engineering sample
Applicant: EnGenius Technologies
Test Date: Jul. 09 ~ Jul. 29, 2015 (all tests, except radiated emission below 1GHz and conducted emission items)
Feb. 18 ~ Feb. 19, 2016 (Radiated emission below 1GHz and conducted emission items)
Standards: 47 CFR FCC Part 15, Subpart C (Section 15.247)
ANSI C63.10:2013

The above equipment has been tested by **Bureau Veritas Consumer Products Services (H.K.) Ltd., Taoyuan Branch**, and found compliance with the requirement of the above standards. The test record, data evaluation & Equipment Under Test (EUT) configurations represented herein are true and accurate accounts of the measurements of the sample's EMC characteristics under the conditions specified in this report.

Prepared by : Wey Lin , **Date:** Mar. 03, 2016
Wey Lin / Specialist

Approved by : Ken Liu , **Date:** Mar. 03, 2016
Ken Liu / Senior Manager

2 Summary of Test Results

47 CFR FCC Part 15, Subpart C (SECTION 15.247)			
FCC Clause	Test Item	Result	Remarks
15.207	AC Power Conducted Emission	PASS	Meet the requirement of limit. Minimum passing margin is -16.50dB at 0.53281MHz.
15.205 / 15.209 / 15.247(d)	Radiated Emissions and Band Edge Measurement	PASS	Meet the requirement of limit. Minimum passing margin is -1.0dB at 2483.50MHz.
15.247(d)	Antenna Port Emission	PASS	Meet the requirement of limit.
15.247(a)(2)	6dB bandwidth	PASS	Meet the requirement of limit.
15.247(b)	Conducted power	PASS	Meet the requirement of limit.
15.247(e)	Power Spectral Density	PASS	Meet the requirement of limit.
15.203	Antenna Requirement	PASS	Antenna connector is IPEX not a standard connector.

3 General Information

3.1 General Description of EUT

Product	Dual Band Wireless N600 Managed Wall Plate Access Point
Brand	EnGenius
Test Model	EWS510AP
Status of EUT	Engineering sample
Power Supply Rating	48Vdc from adapter 48Vdc from PoE
Modulation Type	CCK, DQPSK, DBPSK for DSSS 64QAM, 16QAM, QPSK, BPSK for OFDM
Modulation Technology	DSSS, OFDM
Transfer Rate	802.11b: 11.0/ 5.5/ 2.0/ 1.0Mbps 802.11g: 54.0/ 48.0/ 36.0/ 24.0/ 18.0/ 12.0/ 9.0/ 6.0Mbps 802.11n: up to 300.0Mbps
Operating Frequency	2412 ~ 2462MHz
Number of Channel	11 for 802.11b, 802.11g, 802.11n (HT20) 7 for 802.11n (HT40)
Output Power	482.178mW
Antenna Type	Refer to Note
Antenna Connector	Refer to Note
Accessory Device	NA
Data Cable Supplied	NA

Note:

1. This report is prepared for FCC class II permissive change. This report is issued as a supplementary report of BV ADT report no.: RF150702C09. The difference compared with the original design is changing the PCBA placement of primary GND (PoE GND) and chassis GND for isolation except RF portion. RF result is confirmed not to be affected after the test. Therefore, the radiated emissions test above 1GHz is kept and the conducted emissions & radiated emissions tests below 1GHz were retested in this report

PoE (Support unit only)	
Brand	EnGenius
Model	EPE-48GR
Power Rating	48Vdc, 0.38A, 18.24W

4. The following antennas were provided to the EUT.

Type	Gain(dBi)		Connector
	2.4GHz Band	5GHz Band	
Printed	Ant. 1: 4.2dBi	Ant. 3: 5.2dBi	IPEX
	Ant. 2: 5.5dBi	Ant. 4: 5.3dBi	

5. The above EUT information is declared by manufacturer and for more detailed features description, please refer to the manufacturer's specifications or user's manual.

3.2 Description of Test Modes

11 channels are provided for 802.11b, 802.11g and 802.11n (HT20):

Channel	Frequency	Channel	Frequency
1	2412MHz	7	2442MHz
2	2417MHz	8	2447MHz
3	2422MHz	9	2452MHz
4	2427MHz	10	2457MHz
5	2432MHz	11	2462MHz
6	2437MHz		

7 channels are provided for 802.11n (HT40):

Channel	Frequency	Channel	Frequency
3	2422MHz	7	2442MHz
4	2427MHz	8	2447MHz
5	2432MHz	9	2452MHz
6	2437MHz		

3.2.1 Test Mode Applicability and Tested Channel Detail

EUT CONFIGURE MODE	APPLICABLE TO				DESCRIPTION
	RE \geq 1G	RE $<$ 1G	PLC	APCM	
A	√	√	√	√	Power from adapter
B	-	√	√	-	Power from PoE

Where **RE \geq 1G**: Radiated Emission above 1GHz & Bandedge Measurement
RE $<$ 1G: Radiated Emission below 1GHz
PLC: Power Line Conducted Emission
APCM: Antenna Port Conducted Measurement

Note: 1. "-" means no effect.
 2. The EUT is only positioned on Z-plane to use.

Radiated Emission Test (Above 1GHz):

- Pre-Scan has been conducted to determine the worst-case mode from all possible combinations between available modulations, data rates and antenna ports (if EUT with antenna diversity architecture).
- Following channel(s) was (were) selected for the final test as listed below.

EUT CONFIGURE MODE	MODE	AVAILABLE CHANNEL	TESTED CHANNEL	MODULATION TECHNOLOGY	MODULATION TYPE	DATA RATE (Mbps)
A	802.11b	1 to 11	1, 6, 11	DSSS	DBPSK	1.0
A	802.11g	1 to 11	1, 6, 11	OFDM	BPSK	6.0
A	802.11n (HT20)	1 to 11	1, 6, 11	OFDM	BPSK	7.2
A	802.11n (HT40)	3 to 9	3, 6, 9	OFDM	BPSK	15.0

Radiated Emission Test (Below 1GHz):

- Pre-Scan has been conducted to determine the worst-case mode from all possible combinations between available modulations, data rates and antenna ports (if EUT with antenna diversity architecture).
- Following channel(s) was (were) selected for the final test as listed below.

EUT CONFIGURE MODE	MODE	AVAILABLE CHANNEL	TESTED CHANNEL	MODULATION TECHNOLOGY	MODULATION TYPE	DATA RATE (Mbps)
A, B	802.11g	1 to 11	6	OFDM	BPSK	6.0

Power Line Conducted Emission Test:

- Pre-Scan has been conducted to determine the worst-case mode from all possible combinations between available modulations, data rates and antenna ports (if EUT with antenna diversity architecture).
- Following channel(s) was (were) selected for the final test as listed below.

EUT CONFIGURE MODE	MODE	AVAILABLE CHANNEL	TESTED CHANNEL	MODULATION TECHNOLOGY	MODULATION TYPE	DATA RATE (Mbps)
A, B	802.11g	1 to 11	6	OFDM	BPSK	6.0

Antenna Port Conducted Measurement:

- This item includes all test value of each mode, but only includes spectrum plot of worst value of each mode.
- Pre-Scan has been conducted to determine the worst-case mode from all possible combinations between available modulations, data rates and antenna ports (if EUT with antenna diversity architecture).
- Following channel(s) was (were) selected for the final test as listed below.

EUT CONFIGURE MODE	MODE	AVAILABLE CHANNEL	TESTED CHANNEL	MODULATION TECHNOLOGY	MODULATION TYPE	DATA RATE (Mbps)
A	802.11b	1 to 11	1, 6, 11	DSSS	DBPSK	1.0
A	802.11g	1 to 11	1, 6, 11	OFDM	BPSK	6.0
A	802.11n (HT20)	1 to 11	1, 6, 11	OFDM	BPSK	7.2
A	802.11n (HT40)	3 to 9	3, 6, 9	OFDM	BPSK	15.0

Test Condition:

APPLICABLE TO	ENVIRONMENTAL CONDITIONS	INPUT POWER	TESTED BY
RE≥1G	20deg. C, 66%RH	120Vac, 60Hz	Nick Hsu
RE<1G	16deg. C, 70%RH	120Vac, 60Hz 48Vdc	Nick Hsu
PLC	16deg. C, 70%RH	120Vac, 60Hz 48Vdc	Nick Hsu
APCM	25deg. C, 60%RH	120Vac, 60Hz	Leo Tsai

3.3 Duty Cycle of Test Signal

802.11b: Duty cycle of test signal is 100 %, duty factor is not required.

Duty cycle of test signal is < 98%, duty factor shall be considered.

802.11g: Duty cycle = $1.360/1.410 = 0.965$, Duty factor = $10 * \log(1/0.965) = 0.16$

802.11n (HT20): Duty cycle = $1.271/1.325 = 0.959$, Duty factor = $10 * \log(1/0.959) = 0.18$

802.11n (HT40): Duty cycle = $0.630/0.680 = 0.926$, Duty factor = $10 * \log(1/0.926) = 0.33$

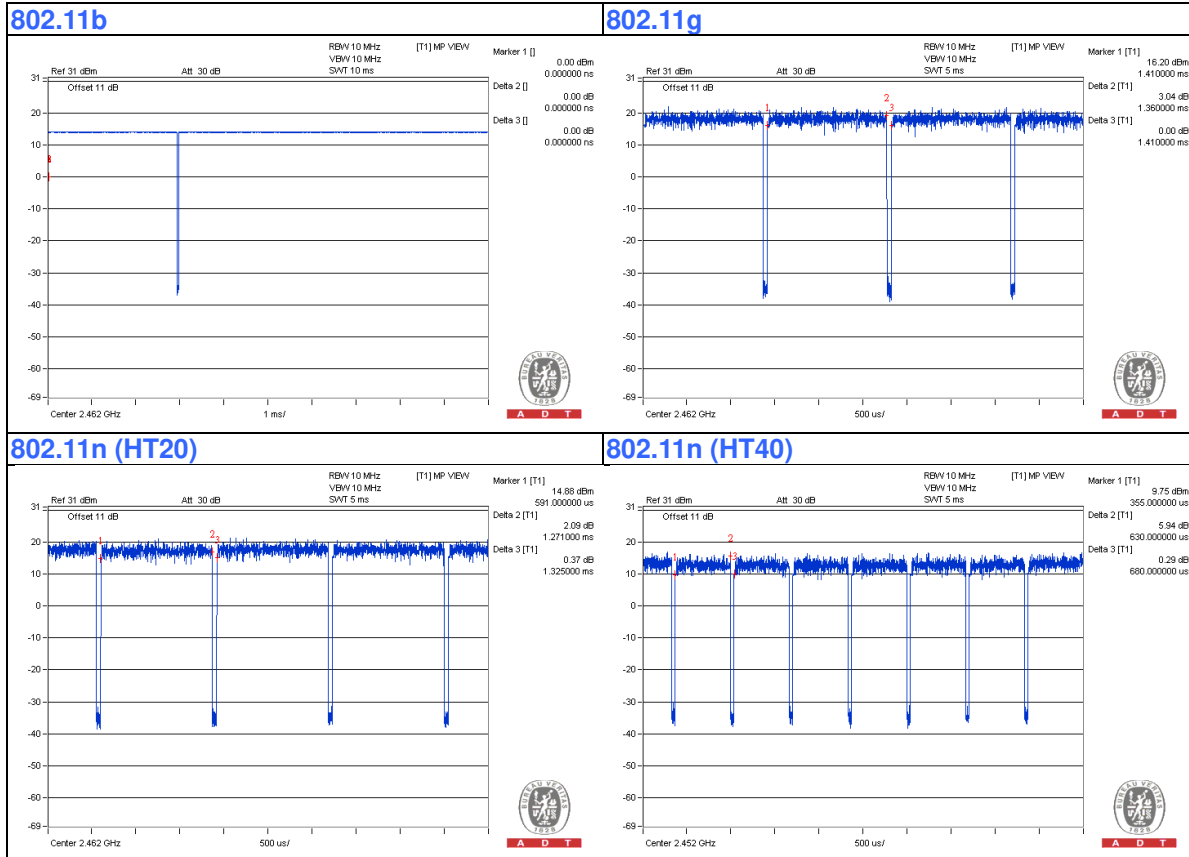

3.4 Description of Support Units

The EUT has been tested as an independent unit together with other necessary accessories or support units. The following support units or accessories were used to form a representative test configuration during the tests.

ID	Product	Brand	Model No.	Serial No.	FCC ID	Remarks
A.	Notebook	DELL	D531	CN-0XM006-4864 3-81U-2610	QDS-BRCM1020	-
B.	Load	NA	NA	NA	NA	-
C.	PoE	EnGenius	EPE-48GR	NA	NA	Supplied by the manufacturer
D.	Adapter	Powertron Electronics Corp.	PA1040-480IB080	NA	NA	Supplied by the manufacturer

Note:

1. All power cords of the above support units are non-shielded (1.8m).
2. Item A acted as a communication partner to transfer data.

ID	Descriptions	Qty.	Length (m)	Shielding (Yes/No)	Cores (Qty.)	Remarks
1.	LAN cable	1	10	N	0	Cat5e
2.	LAN cable	1	1.8	N	0	Cat5e
3.	DC cable	1	1.6	N	1	Attached on adapter
4.	LAN cable	6	1.8	N	0	Cat5e

Note: The core(s) is(are) originally attached to the cable(s).

3.4.1 Configuration of System under Test

<Adapter Mode>

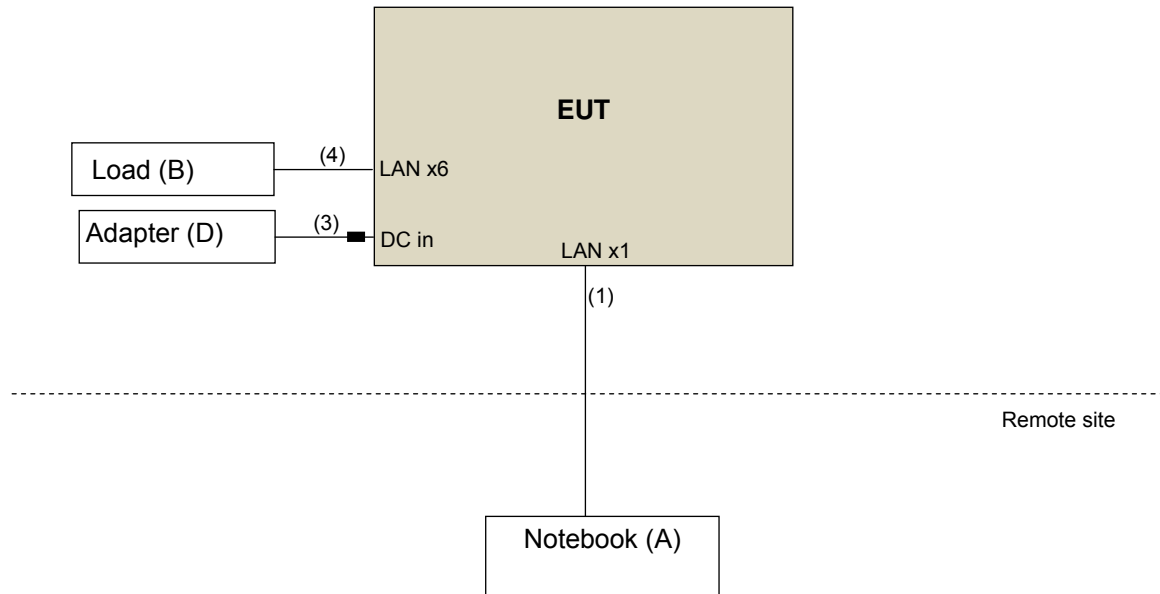

<PoE Mode>

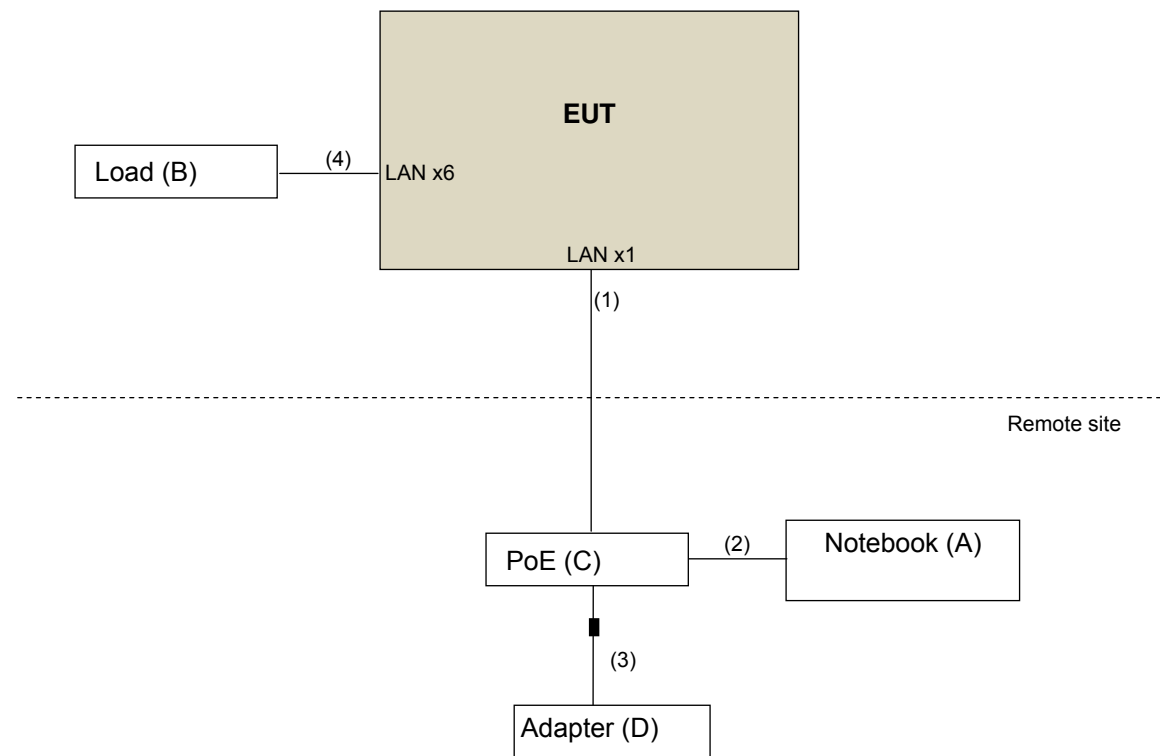

3.5 General Description of Applied Standards

The EUT is a RF Product. According to the specifications of the manufacturer, it must comply with the requirements of the following standards:

FCC Part 15, Subpart C (15.247)
558074 D01 DTS Meas Guidance v03r04
662911 D01 Multiple Transmitter Output v02r01
ANSI C63.10-2013

All test items have been performed and recorded as per the above standards.

NOTE: The EUT has been verified to comply with the requirements of FCC Part 15, Subpart B, Class B (DoC). The test report has been issued separately.

4 Test Types and Results

4.1 Radiated Emission and Bandedge Measurement

4.1.1 Limits of Radiated Emission and Bandedge Measurement

Radiated emissions which fall in the restricted bands must comply with the radiated emission limits specified as below table. Other emissions shall be at least 20dB below the highest level of the desired power:

Frequencies (MHz)	Field Strength (microvolts/meter)	Measurement Distance (meters)
0.009 ~ 0.490	2400/F(kHz)	300
0.490 ~ 1.705	24000/F(kHz)	30
1.705 ~ 30.0	30	30
30 ~ 88	100	3
88 ~ 216	150	3
216 ~ 960	200	3
Above 960	500	3

NOTE:

1. The lower limit shall apply at the transition frequencies.
2. Emission level (dBuV/m) = 20 log Emission level (uV/m).
3. For frequencies above 1000MHz, the field strength limits are based on average detector, however, the peak field strength of any emission shall not exceed the maximum permitted average limits, specified above by more than 20dB under any condition of modulation.



4.1.2 Test Instruments

Test Date: Jul. 09 ~ Jul. 29, 2015

Description & Manufacturer	Model No.	Serial No.	Cal. Date	Cal. Due
Test Receiver ROHDE & SCHWARZ	ESIB7	100187	Apr. 10, 2015	Apr. 09, 2016
Spectrum Analyzer ROHDE & SCHWARZ	FSP40	100041	Aug. 29, 2014	Aug. 28, 2015
BILOG Antenna SCHWARZBECK	VULB9168	9168-160	Feb. 05, 2015	Feb. 04, 2016
HORN Antenna SCHWARZBECK	9120D	209	Feb. 09, 2015	Feb. 08, 2016
HORN Antenna SCHWARZBECK	BBHA 9170	BBHA9170241	Feb. 09, 2015	Feb. 08, 2016
Preamplifier Agilent	8447D	2944A10738	Oct.18, 2014	Oct. 17, 2015
Preamplifier Agilent	8449B	3008A01964	Aug. 22, 2014	Aug. 21, 2015
RF signal cable HUBER+SUHNNER	SUCOFLEX 104	214378/4	Aug. 22, 2014	Aug. 21, 2015
RF signal cable HUBER+SUHNNER	SUCOFLEX 106	12738/6 +309224/4	Aug. 22, 2014	Aug. 21, 2015
Software BV ADT	ADT_Radiated_ V7.6.15.9.4	NA	NA	NA
Antenna Tower inn-co GmbH	MA 4000	013303	NA	NA
Antenna Tower Controller BV ADT	AT100	AT93021702	NA	NA
Turn Table BV ADT	TT100	TT93021702	NA	NA
Turn Table Controller BV ADT	SC100	SC93021702	NA	NA
High Speed Peak Power Meter	ML2495A	0824011	Jul. 09, 2015	Jul. 08, 2016
Power Sensor	MA2411B	0738171	Jul. 09, 2015	Jul. 08, 2016

Note: 1. The calibration interval of the above test instruments is 12 months and the calibrations are traceable to NML/ROC and NIST/USA.

2. The test was performed in HwaYa Chamber 3.

3. The horn antenna and HP preamplifier (model: 8449B) are used only for the measurement of emission frequency above 1GHz if tested.

4. The FCC Site Registration No. is 988962.

5. The IC Site Registration No. is IC 7450F-3.



Test Date: Feb. 18, 2016

Description & Manufacturer	Model No.	Serial No.	Cal. Date	Cal. Due
Test Receiver ROHDE & SCHWARZ	ESIB7	100187	Apr. 10, 2015	Apr. 09, 2016
Spectrum Analyzer ROHDE & SCHWARZ	FSP40	100041	Sep. 02, 2015	Sep. 01, 2016
BILOG Antenna SCHWARZBECK	VULB9168	9168-151	Jan. 07, 2016	Jan. 06, 2017
HORN Antenna SCHWARZBECK	9120D	209	Jan. 20, 2016	Jan. 19, 2017
HORN Antenna SCHWARZBECK	BBHA 9170	BBHA9170241	Jan. 18, 2016	Jan. 17, 2017
Preamplifier Agilent	8447D	2944A10738	Oct.18, 2015	Oct. 17, 2016
Preamplifier Agilent	8449B	3008A01964	Aug. 22, 2015	Aug. 21, 2016
RF signal cable HUBER+SUHNER	SUCOFLEX 104	Cable-CH3-03 (214378)	Aug. 22, 2015	Aug. 21, 2016
RF signal cable HUBER+SUHNER	SUCOFLEX 106	Cable-CH3-03 (309224+12738)	Aug. 22, 2015	Aug. 21, 2016
Software BV ADT	ADT_Radiated_ V7.6.15.9.4	NA	NA	NA
Antenna Tower inn-co GmbH	MA 4000	013303	NA	NA
Antenna Tower Controller BV ADT	AT100	AT93021702	NA	NA
Turn Table BV ADT	TT100	TT93021702	NA	NA
Turn Table Controller BV ADT	SC100	SC93021702	NA	NA

- Note: 1. The calibration interval of the above test instruments is 12 months and the calibrations are traceable to NML/ROC and NIST/USA.
2. The test was performed in HwaYa Chamber 3.
3. The horn antenna and preamplifier (model: 8449B) are used only for the measurement of emission frequency above 1GHz if tested.
4. The FCC Site Registration No. is 988962.
5. The IC Site Registration No. is IC 7450F-3.

4.1.3 Test Procedures

- a. The EUT was placed on the top of a rotating table 0.8 meters (for below 1GHz) / 1.5 meters (for above 1GHz) above the ground at 3 meter chamber room for test. The table was rotated 360 degrees to determine the position of the highest radiation.
- b. The EUT was set 3 meters away from the interference-receiving antenna, which was mounted on the top of a variable-height antenna tower.
- c. The height of antenna is varied from one meter to four meters above the ground to determine the maximum value of the field strength. Both horizontal and vertical polarizations of the antenna are set to make the measurement.
- d. For each suspected emission, the EUT was arranged to its worst case and then the antenna was tuned to heights from 1 meter to 4 meters and the rotatable table was turned from 0 degrees to 360 degrees to find the maximum reading.
- e. The test-receiver system was set to quasi-peak detect function and specified bandwidth with maximum hold mode when the test frequency is below 1 GHz.
- f. The test-receiver system was set to peak and average detect function and specified bandwidth with maximum hold mode when the test frequency is above 1 GHz. If the peak reading value also meets average limit, measurement with the average detector is unnecessary.

Note:

1. The resolution bandwidth and video bandwidth of test receiver/spectrum analyzer is 120kHz for Quasi-peak detection (QP) at frequency below 1GHz.
2. The resolution bandwidth of test receiver/spectrum analyzer is 1 MHz and the video bandwidth is 3 MHz for Peak detection (PK) at frequency above 1GHz.
3. The resolution bandwidth of test receiver/spectrum analyzer is 1MHz and the video bandwidth is 3MHz for RMS Average (Duty cycle < 98%) for Average detection (AV) at frequency above 1GHz, then the measurement results was added to a correction factor ($10 \log(1/\text{duty cycle})$).
4. The resolution bandwidth of test receiver/spectrum analyzer is 1MHz and the video bandwidth is 10Hz (Duty cycle $\geq 98\%$) for Average detection (AV) at frequency above 1GHz.
5. All modes of operation were investigated and the worst-case emissions are reported.

4.1.4 Deviation from Test Standard

No deviation.

4.1.5 Test Set Up

<Frequency Range below 1GHz>

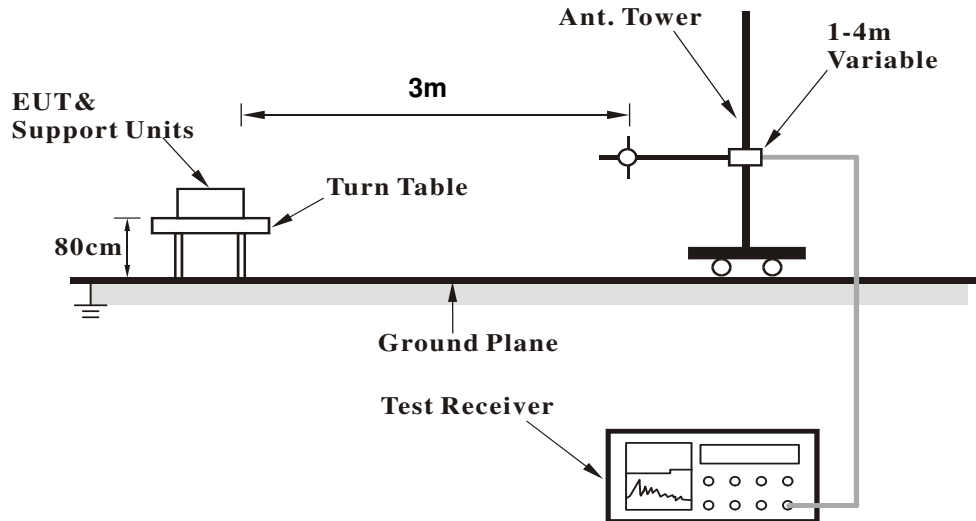

<Frequency Range above 1GHz>

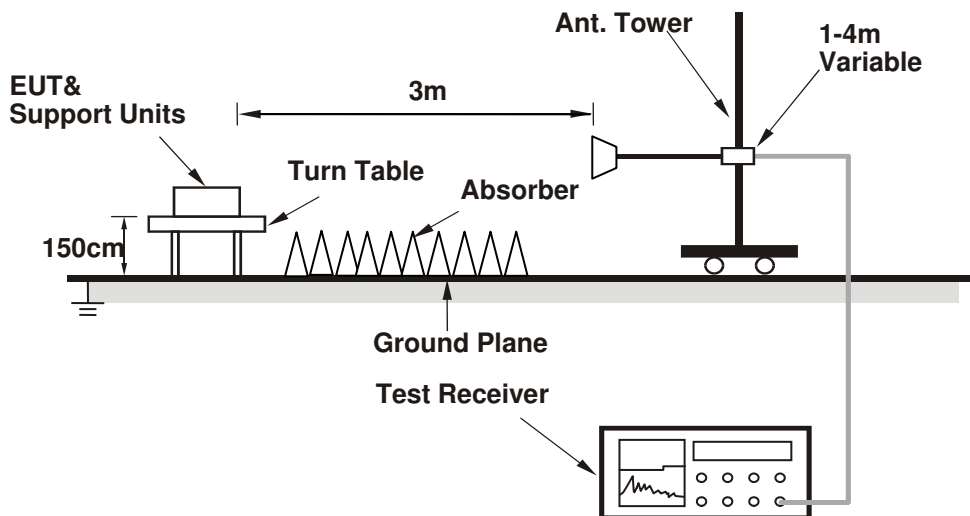

For the actual test configuration, please refer to the attached file (Test Setup Photo).

4.1.6 EUT Operating Conditions

- Placed the EUT on the testing table.
- Prepared notebook to act as communication partner and placed it outside of testing area.
- The communication partner connected with EUT via a RJ45 cable and ran a test program (provided by manufacturer) to enable EUT under transmission condition continuously at specific channel frequency.
- The communication partner sent data to EUT by command "PING".



4.1.7 Test Results

Above 1GHz Data

CHANNEL	TX Channel 6	DETECTOR FUNCTION	Peak (PK)
FREQUENCY RANGE	1GHz ~ 25GHz		Average (AV)

ANTENNA POLARITY & TEST DISTANCE: HORIZONTAL AT 3 M

NO.	FREQ. (MHz)	EMISSION LEVEL (dBuV/m)	LIMIT (dBuV/m)	MARGIN (dB)	ANTENNA HEIGHT (m)	TABLE ANGLE (Degree)	RAW VALUE (dBuV)	CORRECTION FACTOR (dB/m)
1	*2437.00	99.4 PK			1.32 H	292	65.90	33.50
2	*2437.00	95.8 AV			1.32 H	292	62.30	33.50
3	4874.00	55.6 PK	74.0	-18.4	1.87 H	303	50.30	5.30
4	4874.00	52.7 AV	54.0	-1.3	1.87 H	303	47.40	5.30

ANTENNA POLARITY & TEST DISTANCE: VERTICAL AT 3 M

NO.	FREQ. (MHz)	EMISSION LEVEL (dBuV/m)	LIMIT (dBuV/m)	MARGIN (dB)	ANTENNA HEIGHT (m)	TABLE ANGLE (Degree)	RAW VALUE (dBuV)	CORRECTION FACTOR (dB/m)
1	*2437.00	99.1 PK			1.36 V	20	65.60	33.50
2	*2437.00	95.5 AV			1.36 V	20	62.00	33.50
3	4874.00	53.3 PK	74.0	-20.7	1.55 V	290	48.00	5.30
4	4874.00	49.7 AV	54.0	-4.3	1.55 V	290	44.40	5.30

REMARKS:

1. Emission Level(dBuV/m) = Raw Value(dBuV) + Correction Factor(dB/m)
2. Correction Factor(dB/m) = Antenna Factor(dB/m) + Cable Factor(dB)
3. The other emission levels were very low against the limit.
4. Margin value = Emission Level – Limit value
5. " * ": Fundamental frequency.

CHANNEL	TX Channel 11	DETECTOR FUNCTION	Peak (PK)
FREQUENCY RANGE	1GHz ~ 25GHz		Average (AV)

ANTENNA POLARITY & TEST DISTANCE: HORIZONTAL AT 3 M

NO.	FREQ. (MHz)	EMISSION LEVEL (dBuV/m)	LIMIT (dBuV/m)	MARGIN (dB)	ANTENNA HEIGHT (m)	TABLE ANGLE (Degree)	RAW VALUE (dBuV)	CORRECTION FACTOR (dB/m)
1	*2462.00	96.4 PK			1.14 H	289	63.00	33.40
2	*2462.00	92.7 AV			1.14 H	289	59.30	33.40
3	2483.50	57.5 PK	74.0	-16.5	1.32 H	265	24.00	33.50
4	2483.50	45.6 AV	54.0	-8.4	1.32 H	265	12.10	33.50
5	4924.00	55.4 PK	74.0	-18.6	1.79 H	307	49.90	5.50
6	4924.00	52.7 AV	54.0	-1.3	1.79 H	307	47.20	5.50

ANTENNA POLARITY & TEST DISTANCE: VERTICAL AT 3 M

NO.	FREQ. (MHz)	EMISSION LEVEL (dBuV/m)	LIMIT (dBuV/m)	MARGIN (dB)	ANTENNA HEIGHT (m)	TABLE ANGLE (Degree)	RAW VALUE (dBuV)	CORRECTION FACTOR (dB/m)
1	*2462.00	96.0 PK			1.68 V	86	62.60	33.40
2	*2462.00	92.7 AV			1.68 V	86	59.30	33.40
3	2483.50	57.8 PK	74.0	-16.2	1.31 V	174	24.30	33.50
4	2483.50	45.5 AV	54.0	-8.5	1.31 V	174	12.00	33.50
5	4924.00	52.7 PK	74.0	-21.3	1.59 V	341	47.20	5.50
6	4924.00	48.9 AV	54.0	-5.1	1.59 V	341	43.40	5.50

REMARKS:

1. Emission Level(dBuV/m) = Raw Value(dBuV) + Correction Factor(dB/m)
2. Correction Factor(dB/m) = Antenna Factor(dB/m) + Cable Factor(dB)
3. The other emission levels were very low against the limit.
4. Margin value = Emission Level – Limit value
5. " * ": Fundamental frequency.

802.11g

CHANNEL	TX Channel 1	DETECTOR FUNCTION	Peak (PK)
FREQUENCY RANGE	1GHz ~ 25GHz		Average (AV)

ANTENNA POLARITY & TEST DISTANCE: HORIZONTAL AT 3 M

NO.	FREQ. (MHz)	EMISSION LEVEL (dBuV/m)	LIMIT (dBuV/m)	MARGIN (dB)	ANTENNA HEIGHT (m)	TABLE ANGLE (Degree)	RAW VALUE (dBuV)	CORRECTION FACTOR (dB/m)
1	2240.00	51.1 PK	74.0	-22.9	1.76 H	317	51.60	-0.50
2	2240.00	47.2 AV	54.0	-6.8	1.76 H	317	47.70	-0.50
3	2390.00	68.2 PK	74.0	-5.8	1.80 H	322	35.70	32.50
4	2390.00	52.4 AV	54.0	-1.6	1.80 H	322	19.90	32.50
5	*2412.00	105.1 PK			1.31 H	327	72.50	32.60
6	*2412.00	95.5 AV			1.31 H	327	62.90	32.60
7	4824.00	55.2 PK	74.0	-18.8	1.65 H	349	49.30	5.90
8	4824.00	42.2 AV	54.0	-11.8	1.65 H	349	36.30	5.90

ANTENNA POLARITY & TEST DISTANCE: VERTICAL AT 3 M

NO.	FREQ. (MHz)	EMISSION LEVEL (dBuV/m)	LIMIT (dBuV/m)	MARGIN (dB)	ANTENNA HEIGHT (m)	TABLE ANGLE (Degree)	RAW VALUE (dBuV)	CORRECTION FACTOR (dB/m)
1	2240.00	46.4 PK	74.0	-27.6	1.00 V	116	46.90	-0.50
2	2240.00	41.6 AV	54.0	-12.4	1.00 V	116	42.10	-0.50
3	2390.00	64.9 PK	74.0	-9.1	1.52 V	321	32.40	32.50
4	2390.00	51.9 AV	54.0	-2.1	1.52 V	321	19.40	32.50
5	*2412.00	105.2 PK			1.83 V	339	72.60	32.60
6	*2412.00	95.4 AV			1.83 V	339	62.80	32.60
7	4824.00	51.6 PK	74.0	-22.4	1.00 V	350	45.70	5.90
8	4824.00	38.8 AV	54.0	-15.2	1.00 V	350	32.90	5.90

REMARKS:

1. Emission Level(dBuV/m) = Raw Value(dBuV) + Correction Factor(dB/m)
2. Correction Factor(dB/m) = Antenna Factor(dB/m) + Cable Factor(dB)
3. The other emission levels were very low against the limit.
4. Margin value = Emission Level – Limit value
5. " * ": Fundamental frequency.

CHANNEL	TX Channel 6	DETECTOR FUNCTION	Peak (PK)
FREQUENCY RANGE	1GHz ~ 25GHz		Average (AV)

ANTENNA POLARITY & TEST DISTANCE: HORIZONTAL AT 3 M

NO.	FREQ. (MHz)	EMISSION LEVEL (dBuV/m)	LIMIT (dBuV/m)	MARGIN (dB)	ANTENNA HEIGHT (m)	TABLE ANGLE (Degree)	RAW VALUE (dBuV)	CORRECTION FACTOR (dB/m)
1	2240.00	49.9 PK	74.0	-24.1	1.76 H	330	51.70	-1.80
2	2240.00	44.5 AV	54.0	-9.5	1.76 H	330	46.30	-1.80
3	*2437.00	109.2 PK			1.00 H	322	75.70	33.50
4	*2437.00	100.1 AV			1.00 H	322	66.60	33.50
5	4874.00	60.4 PK	74.0	-13.6	1.83 H	0	55.10	5.30
6	4874.00	46.9 AV	54.0	-7.1	1.83 H	0	41.60	5.30

ANTENNA POLARITY & TEST DISTANCE: VERTICAL AT 3 M

NO.	FREQ. (MHz)	EMISSION LEVEL (dBuV/m)	LIMIT (dBuV/m)	MARGIN (dB)	ANTENNA HEIGHT (m)	TABLE ANGLE (Degree)	RAW VALUE (dBuV)	CORRECTION FACTOR (dB/m)
1	2240.00	43.7 PK	74.0	-30.3	1.00 V	85	45.50	-1.80
2	2240.00	36.3 AV	54.0	-17.7	1.00 V	85	38.10	-1.80
3	*2437.00	107.6 PK			1.61 V	339	74.10	33.50
4	*2437.00	97.7 AV			1.61 V	339	64.20	33.50
5	4874.00	57.1 PK	74.0	-16.9	1.15 V	348	51.80	5.30
6	4874.00	43.7 AV	54.0	-10.3	1.15 V	348	38.40	5.30

REMARKS:

1. Emission Level(dBuV/m) = Raw Value(dBuV) + Correction Factor(dB/m)
2. Correction Factor(dB/m) = Antenna Factor(dB/m) + Cable Factor(dB)
3. The other emission levels were very low against the limit.
4. Margin value = Emission Level – Limit value
5. " * ": Fundamental frequency.

CHANNEL	TX Channel 11	DETECTOR FUNCTION	Peak (PK)
FREQUENCY RANGE	1GHz ~ 25GHz		Average (AV)

ANTENNA POLARITY & TEST DISTANCE: HORIZONTAL AT 3 M

NO.	FREQ. (MHz)	EMISSION LEVEL (dBuV/m)	LIMIT (dBuV/m)	MARGIN (dB)	ANTENNA HEIGHT (m)	TABLE ANGLE (Degree)	RAW VALUE (dBuV)	CORRECTION FACTOR (dB/m)
1	*2462.00	102.9 PK			1.00 H	319	69.50	33.40
2	*2462.00	93.7 AV			1.00 H	319	60.30	33.40
3	2483.50	70.3 PK	74.0	-3.7	1.00 H	269	36.80	33.50
4	2483.50	53.0 AV	54.0	-1.0	1.00 H	269	19.50	33.50
5	4924.00	55.4 PK	74.0	-18.6	1.78 H	1	49.90	5.50
6	4924.00	41.5 AV	54.0	-12.5	1.78 H	1	36.00	5.50

ANTENNA POLARITY & TEST DISTANCE: VERTICAL AT 3 M

NO.	FREQ. (MHz)	EMISSION LEVEL (dBuV/m)	LIMIT (dBuV/m)	MARGIN (dB)	ANTENNA HEIGHT (m)	TABLE ANGLE (Degree)	RAW VALUE (dBuV)	CORRECTION FACTOR (dB/m)
1	*2462.00	103.4 PK			1.22 V	328	70.00	33.40
2	*2462.00	94.0 AV			1.22 V	328	60.60	33.40
3	2483.50	72.2 PK	74.0	-1.8	1.07 V	341	38.70	33.50
4	2483.50	52.8 AV	54.0	-1.2	1.07 V	341	19.30	33.50
5	4924.00	53.4 PK	74.0	-20.6	1.07 V	343	47.90	5.50
6	4924.00	40.4 AV	54.0	-13.6	1.07 V	343	34.90	5.50

REMARKS:

1. Emission Level(dBuV/m) = Raw Value(dBuV) + Correction Factor(dB/m)
2. Correction Factor(dB/m) = Antenna Factor(dB/m) + Cable Factor(dB)
3. The other emission levels were very low against the limit.
4. Margin value = Emission Level – Limit value
5. " * ": Fundamental frequency.

802.11n (HT20)

CHANNEL	TX Channel 1	DETECTOR FUNCTION	Peak (PK)
FREQUENCY RANGE	1GHz ~ 25GHz		Average (AV)

ANTENNA POLARITY & TEST DISTANCE: HORIZONTAL AT 3 M

NO.	FREQ. (MHz)	EMISSION LEVEL (dBuV/m)	LIMIT (dBuV/m)	MARGIN (dB)	ANTENNA HEIGHT (m)	TABLE ANGLE (Degree)	RAW VALUE (dBuV)	CORRECTION FACTOR (dB/m)
1	2390.00	70.7 PK	74.0	-3.3	1.04 H	294	37.50	33.20
2	2390.00	52.2 AV	54.0	-1.8	1.04 H	294	19.00	33.20
3	*2412.00	105.0 PK			1.02 H	291	71.70	33.30
4	*2412.00	95.5 AV			1.02 H	291	62.20	33.30
5	4824.00	52.5 PK	74.0	-21.5	1.78 H	295	47.30	5.20
6	4824.00	39.1 AV	54.0	-14.9	1.78 H	295	33.90	5.20

ANTENNA POLARITY & TEST DISTANCE: VERTICAL AT 3 M

NO.	FREQ. (MHz)	EMISSION LEVEL (dBuV/m)	LIMIT (dBuV/m)	MARGIN (dB)	ANTENNA HEIGHT (m)	TABLE ANGLE (Degree)	RAW VALUE (dBuV)	CORRECTION FACTOR (dB/m)
1	2390.00	65.4 PK	74.0	-8.6	1.54 V	343	32.20	33.20
2	2390.00	50.9 AV	54.0	-3.1	1.54 V	343	17.70	33.20
3	*2412.00	102.1 PK			1.40 V	9	68.80	33.30
4	*2412.00	92.3 AV			1.40 V	9	59.00	33.30
5	4824.00	51.7 PK	74.0	-22.3	1.70 V	291	46.50	5.20
6	4824.00	38.4 AV	54.0	-15.6	1.70 V	291	33.20	5.20

REMARKS:

1. Emission Level(dBuV/m) = Raw Value(dBuV) + Correction Factor(dB/m)
2. Correction Factor(dB/m) = Antenna Factor(dB/m) + Cable Factor(dB)
3. The other emission levels were very low against the limit.
4. Margin value = Emission Level – Limit value
5. " * ": Fundamental frequency.

CHANNEL	TX Channel 6	DETECTOR FUNCTION	Peak (PK)
FREQUENCY RANGE	1GHz ~ 25GHz		Average (AV)

ANTENNA POLARITY & TEST DISTANCE: HORIZONTAL AT 3 M

NO.	FREQ. (MHz)	EMISSION LEVEL (dBuV/m)	LIMIT (dBuV/m)	MARGIN (dB)	ANTENNA HEIGHT (m)	TABLE ANGLE (Degree)	RAW VALUE (dBuV)	CORRECTION FACTOR (dB/m)
1	*2437.00	109.7 PK			1.15 H	291	76.20	33.50
2	*2437.00	99.8 AV			1.15 H	291	66.30	33.50
3	4874.00	61.6 PK	74.0	-12.4	1.92 H	357	56.30	5.30
4	4874.00	47.6 AV	54.0	-6.4	1.92 H	357	42.30	5.30

ANTENNA POLARITY & TEST DISTANCE: VERTICAL AT 3 M

NO.	FREQ. (MHz)	EMISSION LEVEL (dBuV/m)	LIMIT (dBuV/m)	MARGIN (dB)	ANTENNA HEIGHT (m)	TABLE ANGLE (Degree)	RAW VALUE (dBuV)	CORRECTION FACTOR (dB/m)
1	*2437.00	108.5 PK			1.62 V	333	75.00	33.50
2	*2437.00	98.5 AV			1.62 V	333	65.00	33.50
3	4874.00	56.5 PK	74.0	-17.5	1.00 V	339	51.20	5.30
4	4874.00	43.8 AV	54.0	-10.2	1.00 V	339	38.50	5.30

REMARKS:

1. Emission Level(dBuV/m) = Raw Value(dBuV) + Correction Factor(dB/m)
2. Correction Factor(dB/m) = Antenna Factor(dB/m) + Cable Factor(dB)
3. The other emission levels were very low against the limit.
4. Margin value = Emission Level – Limit value
5. " * ": Fundamental frequency.

CHANNEL	TX Channel 11	DETECTOR FUNCTION	Peak (PK)
FREQUENCY RANGE	1GHz ~ 25GHz		Average (AV)

ANTENNA POLARITY & TEST DISTANCE: HORIZONTAL AT 3 M

NO.	FREQ. (MHz)	EMISSION LEVEL (dBuV/m)	LIMIT (dBuV/m)	MARGIN (dB)	ANTENNA HEIGHT (m)	TABLE ANGLE (Degree)	RAW VALUE (dBuV)	CORRECTION FACTOR (dB/m)
1	*2462.00	102.4 PK			1.00 H	289	69.00	33.40
2	*2462.00	92.9 AV			1.00 H	289	59.50	33.40
3	2483.50	72.9 PK	74.0	-1.1	1.00 H	288	39.40	33.50
4	2483.50	51.5 AV	54.0	-2.5	1.00 H	288	18.00	33.50
5	4924.00	54.8 PK	74.0	-19.2	1.71 H	0	49.30	5.50
6	4924.00	41.0 AV	54.0	-13.0	1.71 H	0	35.50	5.50

ANTENNA POLARITY & TEST DISTANCE: VERTICAL AT 3 M

NO.	FREQ. (MHz)	EMISSION LEVEL (dBuV/m)	LIMIT (dBuV/m)	MARGIN (dB)	ANTENNA HEIGHT (m)	TABLE ANGLE (Degree)	RAW VALUE (dBuV)	CORRECTION FACTOR (dB/m)
1	*2462.00	103.6 PK			1.23 V	9	70.20	33.40
2	*2462.00	94.1 AV			1.23 V	9	60.70	33.40
3	2483.50	72.3 PK	74.0	-1.7	1.22 V	328	38.80	33.50
4	2483.50	51.6 AV	54.0	-2.4	1.22 V	328	18.10	33.50
5	4924.00	53.4 PK	74.0	-20.6	1.06 V	346	47.90	5.50
6	4924.00	39.0 AV	54.0	-15.0	1.06 V	346	33.50	5.50

REMARKS:

1. Emission Level(dBuV/m) = Raw Value(dBuV) + Correction Factor(dB/m)
2. Correction Factor(dB/m) = Antenna Factor(dB/m) + Cable Factor(dB)
3. The other emission levels were very low against the limit.
4. Margin value = Emission Level – Limit value
5. " * ": Fundamental frequency.

802.11n (HT40)

CHANNEL	TX Channel 3	DETECTOR FUNCTION	Peak (PK)
FREQUENCY RANGE	1GHz ~ 25GHz		Average (AV)

ANTENNA POLARITY & TEST DISTANCE: HORIZONTAL AT 3 M

NO.	FREQ. (MHz)	EMISSION LEVEL (dBuV/m)	LIMIT (dBuV/m)	MARGIN (dB)	ANTENNA HEIGHT (m)	TABLE ANGLE (Degree)	RAW VALUE (dBuV)	CORRECTION FACTOR (dB/m)
1	2390.00	71.2 PK	74.0	-2.8	1.30 H	321	38.70	32.50
2	2390.00	52.6 AV	54.0	-1.4	1.30 H	321	20.10	32.50
3	*2422.00	97.8 PK			1.01 H	293	65.20	32.60
4	*2422.00	88.9 AV			1.01 H	293	56.30	32.60
5	4844.00	47.7 PK	74.0	-26.3	1.22 H	289	41.80	5.90
6	4844.00	36.4 AV	54.0	-17.6	1.22 H	289	30.50	5.90

ANTENNA POLARITY & TEST DISTANCE: VERTICAL AT 3 M

NO.	FREQ. (MHz)	EMISSION LEVEL (dBuV/m)	LIMIT (dBuV/m)	MARGIN (dB)	ANTENNA HEIGHT (m)	TABLE ANGLE (Degree)	RAW VALUE (dBuV)	CORRECTION FACTOR (dB/m)
1	2390.00	65.8 PK	74.0	-8.2	1.40 V	30	33.30	32.50
2	2390.00	50.7 AV	54.0	-3.3	1.40 V	30	18.20	32.50
3	*2422.00	96.0 PK			1.41 V	358	63.40	32.60
4	*2422.00	86.9 AV			1.41 V	358	54.30	32.60
5	4844.00	47.5 PK	74.0	-26.5	1.13 V	242	41.60	5.90
6	4844.00	35.9 AV	54.0	-18.1	1.13 V	242	30.00	5.90

REMARKS:

1. Emission Level(dBuV/m) = Raw Value(dBuV) + Correction Factor(dB/m)
2. Correction Factor(dB/m) = Antenna Factor(dB/m) + Cable Factor(dB)
3. The other emission levels were very low against the limit.
4. Margin value = Emission Level – Limit value
5. " * ": Fundamental frequency.

CHANNEL	TX Channel 6	DETECTOR FUNCTION	Peak (PK)
FREQUENCY RANGE	1GHz ~ 25GHz		Average (AV)

ANTENNA POLARITY & TEST DISTANCE: HORIZONTAL AT 3 M

NO.	FREQ. (MHz)	EMISSION LEVEL (dBuV/m)	LIMIT (dBuV/m)	MARGIN (dB)	ANTENNA HEIGHT (m)	TABLE ANGLE (Degree)	RAW VALUE (dBuV)	CORRECTION FACTOR (dB/m)
1	2390.00	67.9 PK	74.0	-6.1	1.02 H	304	35.40	32.50
2	2390.00	52.4 AV	54.0	-1.6	1.02 H	304	19.90	32.50
3	*2437.00	99.7 PK			1.16 H	317	67.00	32.70
4	*2437.00	91.2 AV			1.16 H	317	58.50	32.70
5	4874.00	51.6 PK	74.0	-22.4	1.47 H	294	45.70	5.90
6	4874.00	39.6 AV	54.0	-14.4	1.47 H	294	33.70	5.90

ANTENNA POLARITY & TEST DISTANCE: VERTICAL AT 3 M

NO.	FREQ. (MHz)	EMISSION LEVEL (dBuV/m)	LIMIT (dBuV/m)	MARGIN (dB)	ANTENNA HEIGHT (m)	TABLE ANGLE (Degree)	RAW VALUE (dBuV)	CORRECTION FACTOR (dB/m)
1	2390.00	63.6 PK	74.0	-10.4	1.60 V	342	31.10	32.50
2	2390.00	50.3 AV	54.0	-3.7	1.60 V	342	17.80	32.50
3	*2437.00	98.0 PK			1.59 V	329	65.30	32.70
4	*2437.00	89.0 AV			1.59 V	329	56.30	32.70
5	4874.00	51.8 PK	74.0	-22.2	1.58 V	285	45.90	5.90
6	4874.00	38.3 AV	54.0	-15.7	1.58 V	285	32.40	5.90

REMARKS:

1. Emission Level(dBuV/m) = Raw Value(dBuV) + Correction Factor(dB/m)
2. Correction Factor(dB/m) = Antenna Factor(dB/m) + Cable Factor(dB)
3. The other emission levels were very low against the limit.
4. Margin value = Emission Level – Limit value
5. " * ": Fundamental frequency.

CHANNEL	TX Channel 9	DETECTOR FUNCTION	Peak (PK)
FREQUENCY RANGE	1GHz ~ 25GHz		Average (AV)

ANTENNA POLARITY & TEST DISTANCE: HORIZONTAL AT 3 M

NO.	FREQ. (MHz)	EMISSION LEVEL (dBuV/m)	LIMIT (dBuV/m)	MARGIN (dB)	ANTENNA HEIGHT (m)	TABLE ANGLE (Degree)	RAW VALUE (dBuV)	CORRECTION FACTOR (dB/m)
1	*2452.00	97.6 PK			1.29 H	316	64.90	32.70
2	*2452.00	89.2 AV			1.29 H	316	56.50	32.70
3	2483.50	72.8 PK	74.0	-1.2	1.00 H	288	40.10	32.70
4	2483.50	51.9 AV	54.0	-2.1	1.00 H	288	19.20	32.70
5	4904.00	50.2 PK	74.0	-23.8	1.79 H	291	44.40	5.80
6	4904.00	38.2 AV	54.0	-15.8	1.79 H	291	32.40	5.80

ANTENNA POLARITY & TEST DISTANCE: VERTICAL AT 3 M

NO.	FREQ. (MHz)	EMISSION LEVEL (dBuV/m)	LIMIT (dBuV/m)	MARGIN (dB)	ANTENNA HEIGHT (m)	TABLE ANGLE (Degree)	RAW VALUE (dBuV)	CORRECTION FACTOR (dB/m)
1	*2452.00	97.7 PK			1.53 V	343	65.00	32.70
2	*2452.00	89.0 AV			1.53 V	343	56.30	32.70
3	2483.50	71.1 PK	74.0	-2.9	1.51 V	312	38.40	32.70
4	2483.50	52.2 AV	54.0	-1.8	1.51 V	312	19.50	32.70
5	4904.00	49.2 PK	74.0	-24.8	1.68 V	299	43.40	5.80
6	4904.00	37.3 AV	54.0	-16.7	1.68 V	299	31.50	5.80

REMARKS:

1. Emission Level(dBuV/m) = Raw Value(dBuV) + Correction Factor(dB/m)
2. Correction Factor(dB/m) = Antenna Factor(dB/m) + Cable Factor(dB)
3. The other emission levels were very low against the limit.
4. Margin value = Emission Level – Limit value
5. " * ": Fundamental frequency.

Below 1GHz Data:
Test Mode A
802.11g

CHANNEL	TX Channel 6	DETECTOR FUNCTION	Quasi-Peak (QP)
FREQUENCY RANGE	30MHz ~ 1GHz		

ANTENNA POLARITY & TEST DISTANCE: HORIZONTAL AT 3 M

NO.	FREQ. (MHz)	EMISSION LEVEL (dBuV/m)	LIMIT (dBuV/m)	MARGIN (dB)	ANTENNA HEIGHT (m)	TABLE ANGLE (Degree)	RAW VALUE (dBuV)	CORRECTION FACTOR (dB/m)
1	57.12	31.6 QP	40.0	-8.4	2.00 H	36	46.20	-14.60
2	152.39	28.8 QP	43.5	-14.7	1.00 H	105	42.60	-13.80
3	220.44	29.5 QP	46.0	-16.5	1.50 H	196	45.70	-16.20
4	315.71	33.4 QP	46.0	-12.6	1.00 H	107	45.20	-11.80
5	374.04	33.7 QP	46.0	-12.3	1.00 H	133	44.30	-10.60
6	500.42	29.5 QP	46.0	-16.5	1.50 H	195	37.60	-8.10

ANTENNA POLARITY & TEST DISTANCE: VERTICAL AT 3 M

NO.	FREQ. (MHz)	EMISSION LEVEL (dBuV/m)	LIMIT (dBuV/m)	MARGIN (dB)	ANTENNA HEIGHT (m)	TABLE ANGLE (Degree)	RAW VALUE (dBuV)	CORRECTION FACTOR (dB/m)
1	53.23	37.4 QP	40.0	-2.6	1.00 V	345	51.60	-14.20
2	148.50	31.7 QP	43.5	-11.8	1.00 V	309	45.50	-13.80
3	193.22	30.2 QP	43.5	-13.3	1.00 V	101	46.30	-16.10
4	313.77	32.0 QP	46.0	-14.0	1.51 V	331	43.80	-11.80
5	374.04	30.8 QP	46.0	-15.2	1.51 V	70	41.40	-10.60
6	500.42	29.0 QP	46.0	-17.0	1.00 V	63	37.10	-8.10

REMARKS:

1. Emission Level(dBuV/m) = Raw Value(dBuV) + Correction Factor(dB/m)
2. Correction Factor(dB/m) = Antenna Factor(dB/m) + Cable Factor(dB)
3. The other emission levels were very low against the limit.
4. Margin value = Emission Level – Limit value

Test Mode B
802.11g

CHANNEL	TX Channel 6	DETECTOR FUNCTION	Quasi-Peak (QP)
FREQUENCY RANGE	30MHz ~ 1GHz		

ANTENNA POLARITY & TEST DISTANCE: HORIZONTAL AT 3 M

NO.	FREQ. (MHz)	EMISSION LEVEL (dBuV/m)	LIMIT (dBuV/m)	MARGIN (dB)	ANTENNA HEIGHT (m)	TABLE ANGLE (Degree)	RAW VALUE (dBuV)	CORRECTION FACTOR (dB/m)
1	57.12	31.6 QP	40.0	-8.4	2.00 H	44	46.20	-14.60
2	97.95	29.6 QP	43.5	-13.9	2.00 H	229	48.70	-19.10
3	152.39	34.7 QP	43.5	-8.8	2.00 H	89	48.50	-13.80
4	375.98	33.5 QP	46.0	-12.5	2.00 H	181	44.10	-10.60
5	848.45	33.8 QP	46.0	-12.2	2.00 H	98	34.90	-1.10
6	875.67	36.0 QP	46.0	-10.0	1.00 H	16	36.70	-0.70

ANTENNA POLARITY & TEST DISTANCE: VERTICAL AT 3 M

NO.	FREQ. (MHz)	EMISSION LEVEL (dBuV/m)	LIMIT (dBuV/m)	MARGIN (dB)	ANTENNA HEIGHT (m)	TABLE ANGLE (Degree)	RAW VALUE (dBuV)	CORRECTION FACTOR (dB/m)
1	45.29	35.7 QP	40.0	-4.3	1.00 V	278	50.50	-14.80
2	70.73	35.3 QP	40.0	-4.7	2.00 V	4	51.60	-16.30
3	152.39	35.0 QP	43.5	-8.5	1.00 V	314	48.80	-13.80
4	375.98	31.0 QP	46.0	-15.0	1.49 V	27	41.60	-10.60
5	624.85	27.9 QP	46.0	-18.1	1.49 V	354	33.00	-5.10
6	875.67	32.4 QP	46.0	-13.6	2.00 V	358	33.10	-0.70

REMARKS:

1. Emission Level(dBuV/m) = Raw Value(dBuV) + Correction Factor(dB/m)
2. Correction Factor(dB/m) = Antenna Factor(dB/m) + Cable Factor(dB)
3. The other emission levels were very low against the limit.
4. Margin value = Emission Level – Limit value

4.2 Conducted Emission Measurement

4.2.1 Limits of Conducted Emission Measurement

Frequency (MHz)	Conducted Limit (dBuV)	
	Quasi-peak	Average
0.15 - 0.5	66 - 56	56 - 46
0.50 - 5.0	56	46
5.0 - 30.0	60	50

Note: 1. The lower limit shall apply at the transition frequencies.

2. The limit decreases in line with the logarithm of the frequency in the range of 0.15 to 0.50MHz.

4.2.2 Test Instruments

Test Date: Feb. 19, 2016

Description & Manufacturer	Model No.	Serial No.	Cal. Date	Cal. Due
Test Receiver ROHDE & SCHWARZ	ESCS 30	100288	Apr. 27, 2015	Apr. 26, 2016
RF signal cable (with 10dB PAD) Woken	5D-FB	Cable-cond2-01	Dec. 26, 2015	Dec. 25, 2016
LISN ROHDE & SCHWARZ (EUT)	ESH2-Z5	100100	Jan. 11, 2016	Jan. 10, 2017
LISN ROHDE & SCHWARZ (Peripheral)	ESH3-Z5	100312	Jul. 21, 2015	Jul. 20, 2016
Software ADT	BV ADT_Cond_ V7.3.7.3	NA	NA	NA

Note: 1. The calibration interval of the above test instruments is 12 months and the calibrations are traceable to NML/ROC and NIST/USA.

2. The test was performed in HwaYa Shielded Room 2.

3. The VCCI Site Registration No. is C-2047.

4.2.3 Test Procedures

- a. The EUT was placed 0.4 meters from the conducting wall of the shielded room with EUT being connected to the power mains through a line impedance stabilization network (LISN). Other support units were connected to the power mains through another LISN. The two LISNs provide 50 ohm/ 50uH of coupling impedance for the measuring instrument.
- b. Both lines of the power mains connected to the EUT were checked for maximum conducted interference.
- c. The frequency range from 150kHz to 30MHz was searched. Emission levels under (Limit - 20dB) was not recorded.

NOTE: The resolution bandwidth and video bandwidth of test receiver is 9kHz for quasi-peak detection (QP) and average detection (AV) at frequency 0.15MHz-30MHz.

4.2.4 Deviation from Test Standard

No deviation.

4.2.5 Test Setup

4.2.7 Test Results

Test Mode A 802.11g

Phase	Line (L)	Detector Function	Quasi-Peak (QP) / Average (AV)
-------	----------	-------------------	--------------------------------

No	Freq. [MHz]	Corr. Factor (dB)	Reading Value [dB (uV)]		Emission Level [dB (uV)]		Limit [dB (uV)]		Margin (dB)	
			Q.P.	AV.	Q.P.	AV.	Q.P.	AV.	Q.P.	AV.
			1	0.15000	10.18	25.28	13.21	35.46	23.39	66.00
2	0.18128	10.20	21.19	12.33	31.39	22.53	64.43	54.43	-33.04	-31.90
3	0.53281	10.26	19.29	14.22	29.55	24.48	56.00	46.00	-26.45	-21.52
4	2.07422	10.38	11.69	9.72	22.07	20.10	56.00	46.00	-33.93	-25.90
5	3.16406	10.40	10.45	4.73	20.85	15.13	56.00	46.00	-35.15	-30.87
6	20.33594	10.67	13.99	7.02	24.66	17.69	60.00	50.00	-35.34	-32.31

REMARKS:

1. Q.P. and AV. are abbreviations of quasi-peak and average individually.
2. The emission levels of other frequencies were very low against the limit.
3. Margin value = Emission level - Limit value
4. Correction factor = Insertion loss + Cable loss
5. Emission Level = Correction Factor + Reading Value.

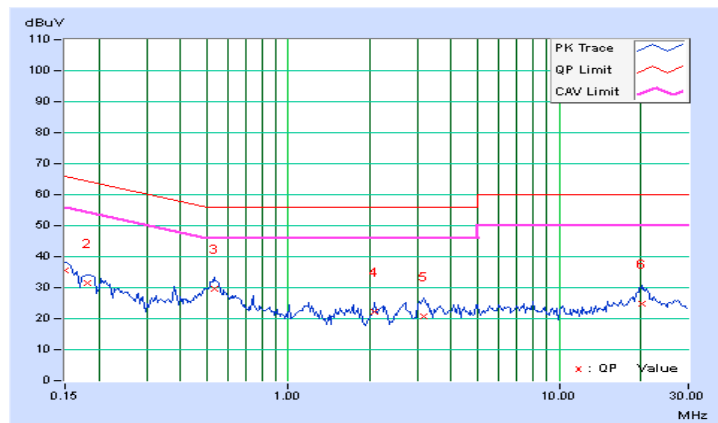

Phase	Neutral (N)	Detector Function	Quasi-Peak (QP) / Average (AV)
-------	-------------	-------------------	--------------------------------

No	Freq. [MHz]	Corr. Factor (dB)	Reading Value		Emission Level		Limit		Margin	
			[dB (uV)]		[dB (uV)]		[dB (uV)]		(dB)	
			Q.P.	AV.	Q.P.	AV.	Q.P.	AV.	Q.P.	AV.
1	0.15000	10.19	26.87	14.58	37.06	24.77	66.00	56.00	-28.94	-31.23
2	0.18125	10.20	24.47	11.21	34.67	21.41	64.43	54.43	-29.76	-33.02
3	0.53281	10.30	18.93	13.86	29.23	24.16	56.00	46.00	-26.77	-21.84
4	1.73438	10.38	11.94	7.60	22.32	17.98	56.00	46.00	-33.68	-28.02
5	2.64453	10.46	10.52	6.39	20.98	16.85	56.00	46.00	-35.02	-29.15
6	20.27344	10.88	12.40	5.64	23.28	16.52	60.00	50.00	-36.72	-33.48

REMARKS:

1. Q.P. and AV. are abbreviations of quasi-peak and average individually.
2. The emission levels of other frequencies were very low against the limit.
3. Margin value = Emission level - Limit value
4. Correction factor = Insertion loss + Cable loss
5. Emission Level = Correction Factor + Reading Value.

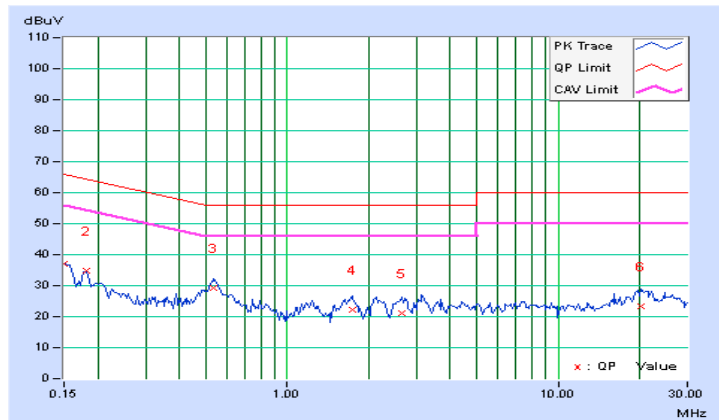

Test Mode B
802.11g

Phase	Line (L)	Detector Function	Quasi-Peak (QP) / Average (AV)
-------	----------	-------------------	--------------------------------

No	Freq. [MHz]	Corr. Factor (dB)	Reading Value [dB (uV)]		Emission Level [dB (uV)]		Limit [dB (uV)]		Margin (dB)	
			Q.P.	AV.	Q.P.	AV.	Q.P.	AV.	Q.P.	AV.
			1	0.15781	10.18	25.68	18.51	35.86	28.69	65.58
2	0.18270	10.20	20.91	14.57	31.11	24.77	64.36	54.36	-33.25	-29.59
3	0.54063	10.26	23.96	18.82	34.22	29.08	56.00	46.00	-21.78	-16.92
4	1.61328	10.35	12.21	8.08	22.56	18.43	56.00	46.00	-33.44	-27.57
5	3.08203	10.40	13.50	9.07	23.90	19.47	56.00	46.00	-32.10	-26.53
6	20.41406	10.67	13.89	7.71	24.56	18.38	60.00	50.00	-35.44	-31.62

REMARKS:

1. Q.P. and AV. are abbreviations of quasi-peak and average individually.
2. The emission levels of other frequencies were very low against the limit.
3. Margin value = Emission level - Limit value
4. Correction factor = Insertion loss + Cable loss
5. Emission Level = Correction Factor + Reading Value.

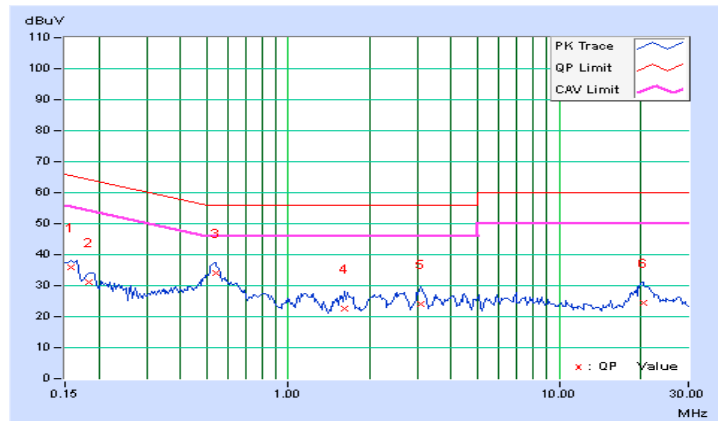

Phase	Neutral (N)	Detector Function	Quasi-Peak (QP) / Average (AV)
-------	-------------	-------------------	--------------------------------

No	Freq. [MHz]	Corr. Factor (dB)	Reading Value [dB (uV)]		Emission Level [dB (uV)]		Limit [dB (uV)]		Margin (dB)	
			Q.P.	AV.	Q.P.	AV.	Q.P.	AV.	Q.P.	AV.
			1	0.15391	10.19	25.08	15.94	35.27	26.13	65.79
2	0.18243	10.20	21.39	13.91	31.59	24.11	64.37	54.37	-32.79	-30.27
3	0.53281	10.30	23.90	19.20	34.20	29.50	56.00	46.00	-21.80	-16.50
4	1.66016	10.37	14.47	10.58	24.84	20.95	56.00	46.00	-31.16	-25.05
5	3.10938	10.49	14.19	9.43	24.68	19.92	56.00	46.00	-31.32	-26.08
6	20.56250	10.88	12.30	6.50	23.18	17.38	60.00	50.00	-36.82	-32.62

REMARKS:

1. Q.P. and AV. are abbreviations of quasi-peak and average individually.
2. The emission levels of other frequencies were very low against the limit.
3. Margin value = Emission level - Limit value
4. Correction factor = Insertion loss + Cable loss
5. Emission Level = Correction Factor + Reading Value.

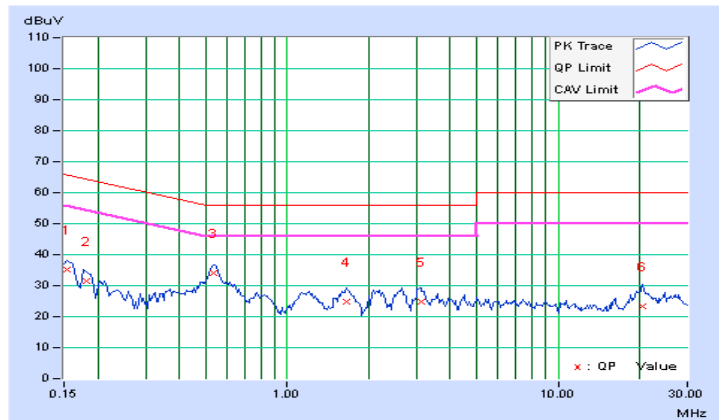

4.3 6dB Bandwidth Measurement

4.3.1 Limits of 6dB Bandwidth Measurement

The minimum of 6dB Bandwidth Measurement is 0.5 MHz.

4.3.2 Test Setup

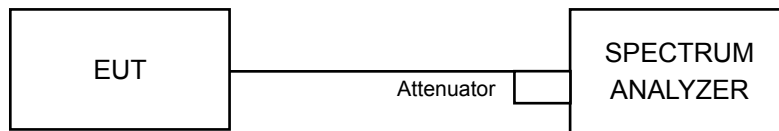

4.3.3 Test Instruments

Refer to section 4.1.2 to get information of above instrument.

4.3.4 Test Procedure

- a. Set resolution bandwidth (RBW) = 100kHz
- b. Set the video bandwidth (VBW) $\geq 3 \times$ RBW, Detector = Peak.
- c. Trace mode = max hold.
- d. Sweep = auto couple.
- e. Measure the maximum width of the emission that is constrained by the frequencies associated with the two amplitude points (upper and lower) that are attenuated by 6 dB relative to the maximum level measured in the fundamental emission

4.3.5 Deviation from Test Standard

No deviation.

4.3.6 EUT Operating Conditions

The software provided by client to enable the EUT under transmission condition continuously at lowest, middle and highest channel frequencies individually.

4.3.7 Test Result

802.11b

Channel	Frequency (MHz)	6dB Bandwidth (MHz)		Minimum Limit (MHz)	Pass / Fail
		CHAIN 0	CHAIN 1		
1	2412	10.10	10.12	0.5	PASS
6	2437	10.12	10.13	0.5	PASS
11	2462	10.14	10.12	0.5	PASS

802.11g

Channel	Frequency (MHz)	6dB Bandwidth (MHz)		Minimum Limit (MHz)	Pass / Fail
		CHAIN 0	CHAIN 1		
1	2412	16.37	16.40	0.5	PASS
6	2437	16.39	16.37	0.5	PASS
11	2462	16.39	16.39	0.5	PASS

802.11n (HT20)

Channel	Frequency (MHz)	6dB Bandwidth (MHz)		Minimum Limit (MHz)	Pass / Fail
		CHAIN 0	CHAIN 1		
1	2412	17.57	17.37	0.5	PASS
6	2437	17.60	17.58	0.5	PASS
11	2462	17.31	17.60	0.5	PASS

802.11n (HT40)

Channel	Frequency (MHz)	6dB Bandwidth (MHz)		Minimum Limit (MHz)	Pass / Fail
		CHAIN 0	CHAIN 1		
3	2422	36.50	36.49	0.5	Pass
6	2437	36.46	36.48	0.5	Pass
9	2452	36.45	36.47	0.5	Pass

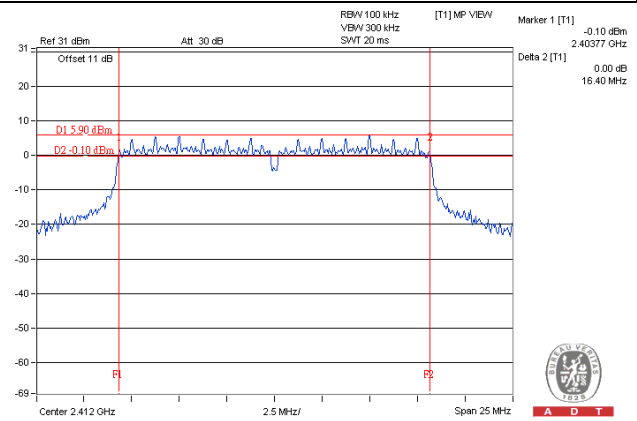
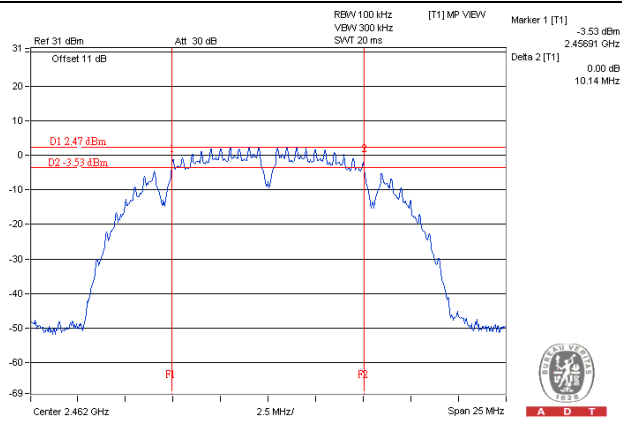
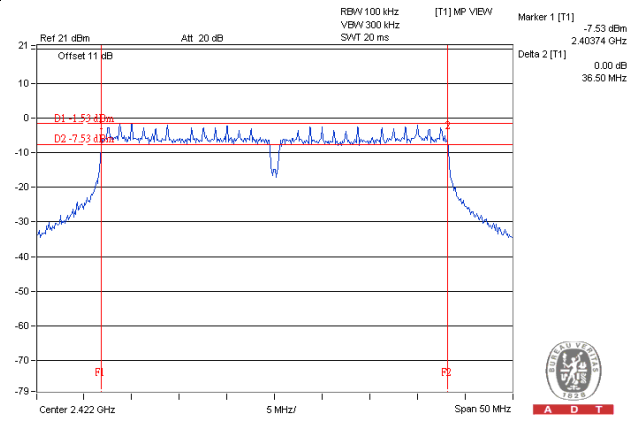
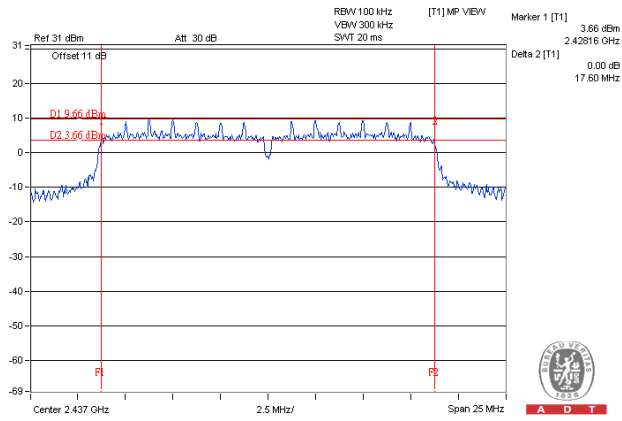
Spectrum Plot of Worst Value**802.11b****802.11g****802.11n (HT20)****802.11n (HT40)**

4.4 Conducted Output Power Measurement

4.4.1 Limits of Conducted Output Power Measurement

For systems using digital modulation in the 2400–2483.5 MHz bands: 1 Watt (30dBm)

Per KDB 662911 D01 Multiple Transmitter Output Method of conducted output power measurement on IEEE 802.11 devices,

Array Gain = 0 dB (i.e., no array gain) for $N_{ANT} \leq 4$;

Array Gain = 0 dB (i.e., no array gain) for channel widths ≥ 40 MHz for any N_{ANT} ;

Array Gain = $5 \log(N_{ANT}/N_{SS})$ dB or 3 dB, whichever is less for 20-MHz channel widths with $N_{ANT} \geq 5$.

For power measurements on all other devices: Array Gain = $10 \log(N_{ANT}/N_{SS})$ dB.

4.4.2 Test Setup

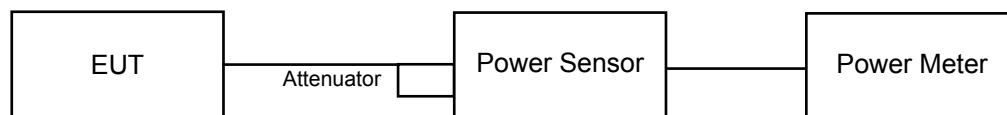

4.4.3 Test Instruments

Refer to section 4.1.2 to get information of above instrument.

4.4.4 Test Procedures

A peak / average power sensor was used on the output port of the EUT. A power meter was used to read the response of the peak / average power sensor. Record the power level.

4.4.5 Deviation from Test Standard

No deviation.

4.4.6 EUT Operating Conditions

Same as Item 4.3.6.

4.4.7 Test Results

FOR PEAK POWER

802.11b

Chan.	Freq. (MHz)	Peak Power (dBm)		Total Power (mW)	Total Power (dBm)	Limit (dBm)	Pass / Fail
		Chain 0	Chain 1				
1	2412	17.09	17.21	103.77	20.16	30	Pass
6	2437	15.70	16.05	77.426	18.89	30	Pass
11	2462	14.40	15.33	61.661	17.90	30	Pass

802.11g

Chan.	Freq. (MHz)	Peak Power (dBm)		Total Power (mW)	Total Power (dBm)	Limit (dBm)	Pass / Fail
		Chain 0	Chain 1				
1	2412	22.34	22.22	338.121	25.29	30	Pass
6	2437	24.13	23.49	482.178	26.83	30	Pass
11	2462	20.71	21.36	254.534	24.06	30	Pass

802.11n (HT20)

Chan.	Freq. (MHz)	Peak Power (dBm)		Total Power (mW)	Total Power (dBm)	Limit (dBm)	Pass / Fail
		Chain 0	Chain 1				
1	2412	21.47	21.05	267.631	24.28	30	Pass
6	2437	24.15	23.42	479.802	26.81	30	Pass
11	2462	21.56	20.75	262.069	24.18	30	Pass

802.11n (HT40)

Chan.	Freq. (MHz)	Peak Power (dBm)		Total Power (mW)	Total Power (dBm)	Limit (dBm)	Pass / Fail
		Chain 0	Chain 1				
3	2422	20.41	19.50	199.026	22.99	30	Pass
6	2437	21.75	20.87	271.804	24.34	30	Pass
9	2452	20.47	20.74	230.006	23.62	30	Pass

FOR AVERAGE POWER
802.11b

Chan.	Frequency (MHz)	Avg. Power (dBm)		Total Power (mW)	Total Power (dBm)
		Chain 0	Chain 1		
1	2412	14.78	15.06	62.124	17.93
6	2437	13.41	13.80	45.916	16.62
11	2462	12.07	13.14	36.712	15.65

802.11g

Chan.	Frequency (MHz)	Avg. Power (dBm)		Total Power (mW)	Total Power (dBm)
		Chain 0	Chain 1		
1	2412	16.33	16.36	86.205	19.36
6	2437	19.97	18.99	178.562	22.52
11	2462	14.73	14.87	60.407	17.81

802.11n (HT20)

Chan.	Frequency (MHz)	Avg. Power (dBm)		Total Power (mW)	Total Power (dBm)
		Chain 0	Chain 1		
1	2412	14.42	14.51	55.918	17.48
6	2437	19.75	18.97	173.292	22.39
11	2462	14.22	14.43	54.157	17.34

802.11n (HT40)

Chan.	Frequency (MHz)	Avg. Power (dBm)		Total Power (mW)	Total Power (dBm)
		Chain 0	Chain 1		
3	2422	12.27	12.95	36.590	15.63
6	2437	14.78	14.53	58.440	17.67
9	2452	13.17	13.04	40.886	16.12

4.5 Power Spectral Density Measurement

4.5.1 Limits of Power Spectral Density Measurement

The Maximum of Power Spectral Density Measurement is 8dBm.

4.5.2 Test Setup

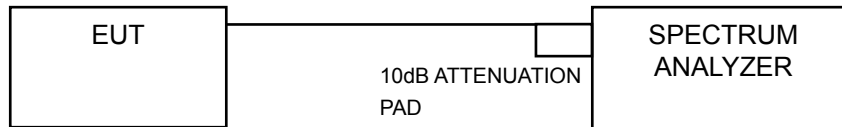

4.5.3 Test Instruments

Refer to section 4.1.2 to get information of above instrument.

4.5.4 Test Procedure

- a. Set analyzer center frequency to DTS channel center frequency.
- b. Set the span to 1.5 times the DTS bandwidth.
- c. Set the RBW to: $3 \text{ kHz} \leq \text{RBW} \leq 100 \text{ kHz}$.
- d. Set the VBW $\geq 3 \times \text{RBW}$.
- e. Detector = peak.
- f. Sweep time = auto couple.
- g. Trace mode = max hold.
- h. Allow trace to fully stabilize.
- i. Use the peak marker function to determine the maximum amplitude level within the RBW.

4.5.5 Deviation from Test Standard

No deviation.

4.5.6 EUT Operating Condition

Same as Item 4.3.6

4.5.7 Test Results

802.11b

TX chain	Channel	Freq. (MHz)	PSD (dBm)	10 log (N=2) dB	Total PSD (dBm)	Limit (dBm)	Pass /Fail
0	1	2412	-9.49	3.01	-6.48	6.12	Pass
	6	2437	-9.66	3.01	-6.65	6.12	Pass
	11	2462	-12.02	3.01	-9.01	6.12	Pass
1	1	2412	-8.83	3.01	-5.82	6.12	Pass
	6	2437	-9.57	3.01	-6.56	6.12	Pass
	11	2462	-10.33	3.01	-7.32	6.12	Pass

NOTE: Directional gain = $10 \log[(10^{G1/20} + 10^{G2/20} + \dots + 10^{GN/20})^2/2] = 7.88 \text{ dBi}$, so the power density limit shall be reduced to $8-(7.88-6) = 6.12 \text{ dBm}$.

802.11g

TX chain	Channel	Freq. (MHz)	PSD (dBm)	10 log (N=2) dB	Total PSD (dBm)	Limit (dBm)	Pass /Fail
0	1	2412	-7.54	3.01	-4.37	6.12	Pass
	6	2437	-5.34	3.01	-2.17	6.12	Pass
	11	2462	-9.94	3.01	-6.77	6.12	Pass
1	1	2412	-8.56	3.01	-5.39	6.12	Pass
	6	2437	-5.56	3.01	-2.39	6.12	Pass
	11	2462	-10.41	3.01	-7.24	6.12	Pass

NOTE: Directional gain = $10 \log[(10^{G1/20} + 10^{G2/20} + \dots + 10^{GN/20})^2/2] = 7.88 \text{ dBi}$, so the power density limit shall be reduced to $8-(7.88-6) = 6.12 \text{ dBm}$.

802.11n (HT20)

TX chain	Channel	Freq. (MHz)	PSD (dBm)	10 log (N=2) dB	Total PSD (dBm)	Limit (dBm)	Pass /Fail
0	1	2412	-10.60	3.01	-7.59	6.12	Pass
	6	2437	-4.77	3.01	-1.76	6.12	Pass
	11	2462	-10.33	3.01	-7.32	6.12	Pass
1	1	2412	-10.84	3.01	-7.83	6.12	Pass
	6	2437	-6.36	3.01	-3.35	6.12	Pass
	11	2462	-10.20	3.01	-7.19	6.12	Pass

NOTE: Directional gain = $10 \log[(10^{G1/20} + 10^{G2/20} + \dots + 10^{GN/20})^2/2] = 7.88 \text{ dBi}$, so the power density limit shall be reduced to $8-(7.88-6) = 6.12 \text{ dBm}$.

802.11n (HT40)

TX chain	Channel	Freq. (MHz)	PSD (dBm)	10 log (N=2) dB	Total PSD (dBm)	Limit (dBm)	Pass /Fail
0	3	2422	-16.94	3.01	-13.60	6.12	Pass
	6	2437	-13.51	3.01	-10.17	6.12	Pass
	9	2452	-12.72	3.01	-9.38	6.12	Pass
1	3	2422	-14.60	3.01	-11.26	6.12	Pass
	6	2437	-13.18	3.01	-9.84	6.12	Pass
	9	2452	-15.35	3.01	-12.01	6.12	Pass

NOTE: Directional gain = $10 \log[(10^{G1/20} + 10^{G2/20} + \dots + 10^{GN/20})^2/3] = 7.88 \text{ dBi}$, so the power density limit shall be reduced to $8-(7.88-6) = 6.12 \text{ dBm}$.

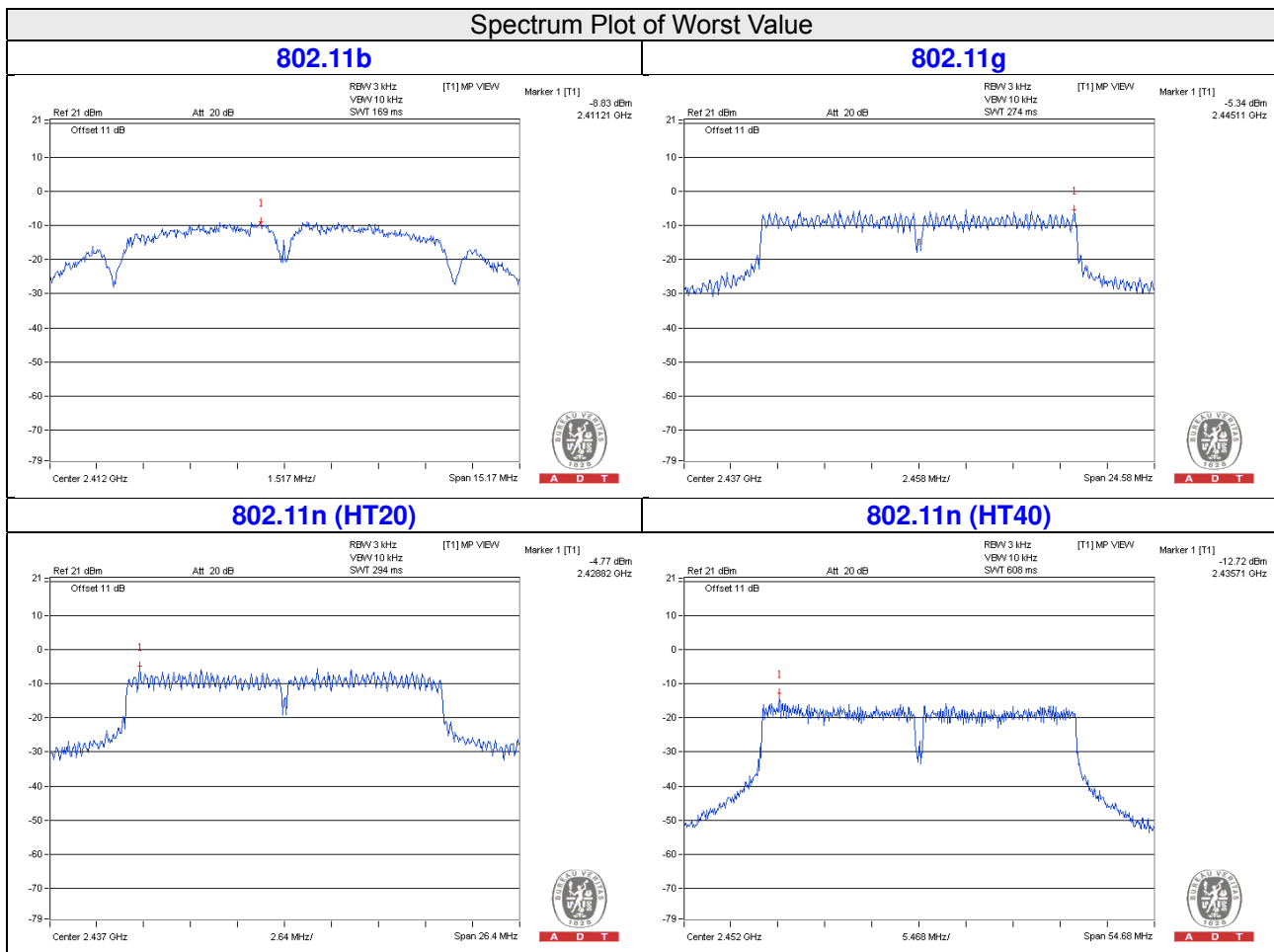

4.6 Conducted Out of Band Emission Measurement

4.6.1 Limits of Conducted Out of Band Emission Measurement

Below 20dB of the highest emission level of operating band (in 100kHz Resolution Bandwidth).

4.6.2 Test Setup

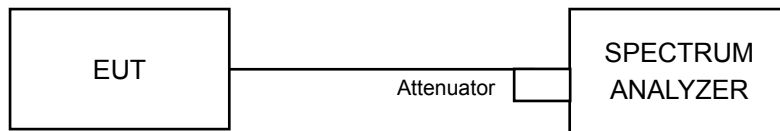

4.6.3 Test Instruments

Refer to section 4.1.2 to get information of above instrument.

4.6.4 Test Procedure

MEASUREMENT PROCEDURE REF

1. Set the RBW = 100 kHz.
2. Set the VBW \geq 300 kHz.
3. Detector = peak.
4. Sweep time = auto couple.
5. Trace mode = max hold.
6. Allow trace to fully stabilize.
7. Use the peak marker function to determine the maximum power level in any 100 kHz band segment within the fundamental EBW.

MEASUREMENT PROCEDURE OOB

1. Set RBW = 100 kHz.
2. Set VBW \geq 300 kHz.
3. Detector = peak.
4. Sweep = auto couple.
5. Trace Mode = max hold.
6. Allow trace to fully stabilize.
7. Use the peak marker function to determine the maximum amplitude level.

4.6.5 Deviation from Test Standard

No deviation.

4.6.6 EUT Operating Condition

Same as Item 4.3.6

4.6.7 Test Results

The spectrum plots are attached on the following pages. D1 line indicates the highest level, and D2 line indicates the 20dB offset below D1. It shows compliance with the requirement.

802.11b: CHAIN 0

CH 1

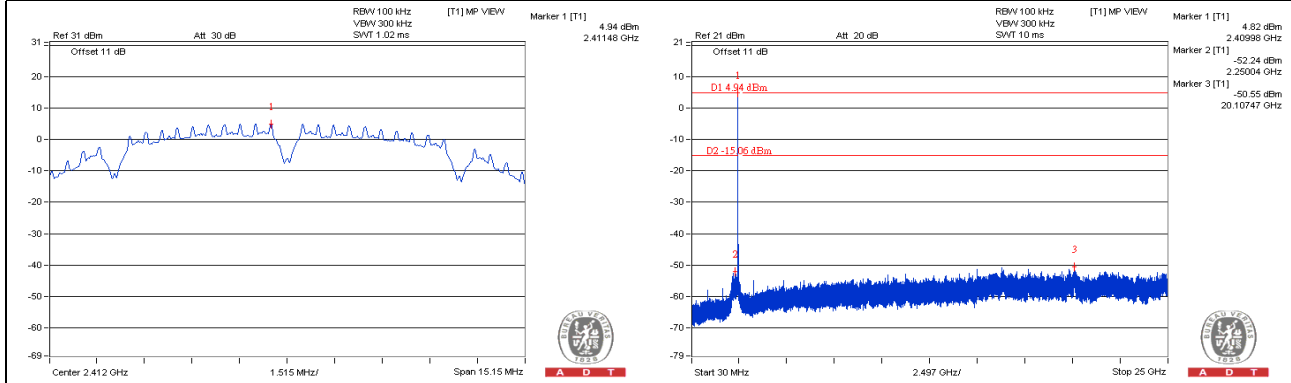

CH 6

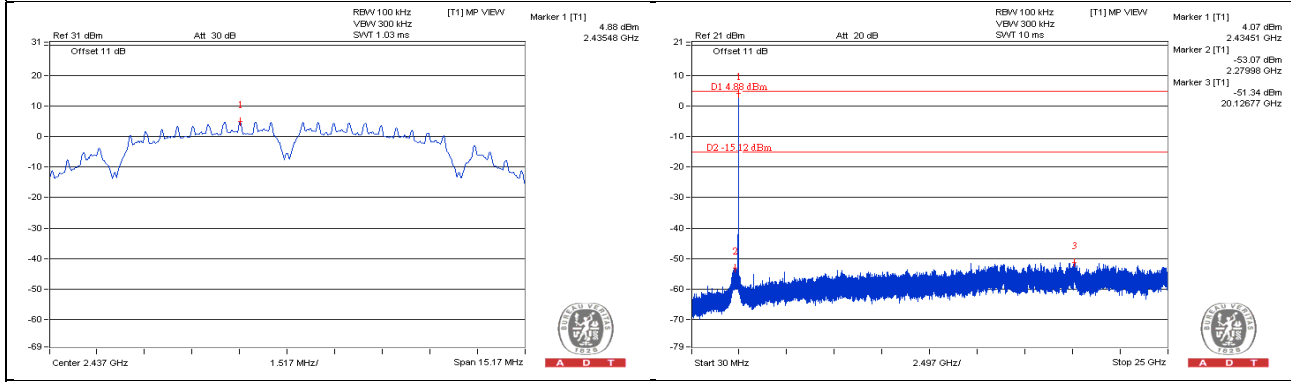

CH 11

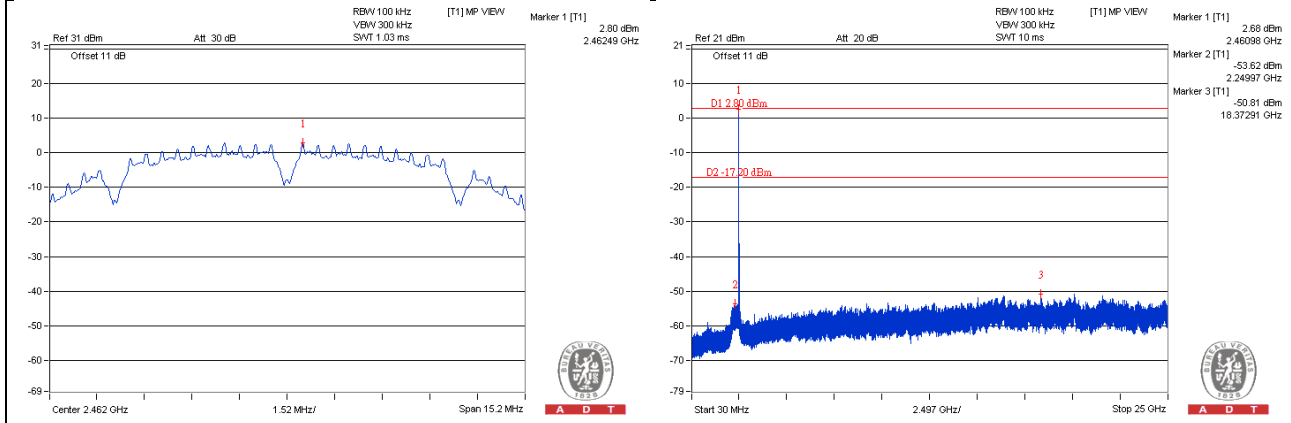

CH 1 Band edge

CH 11 Band edge

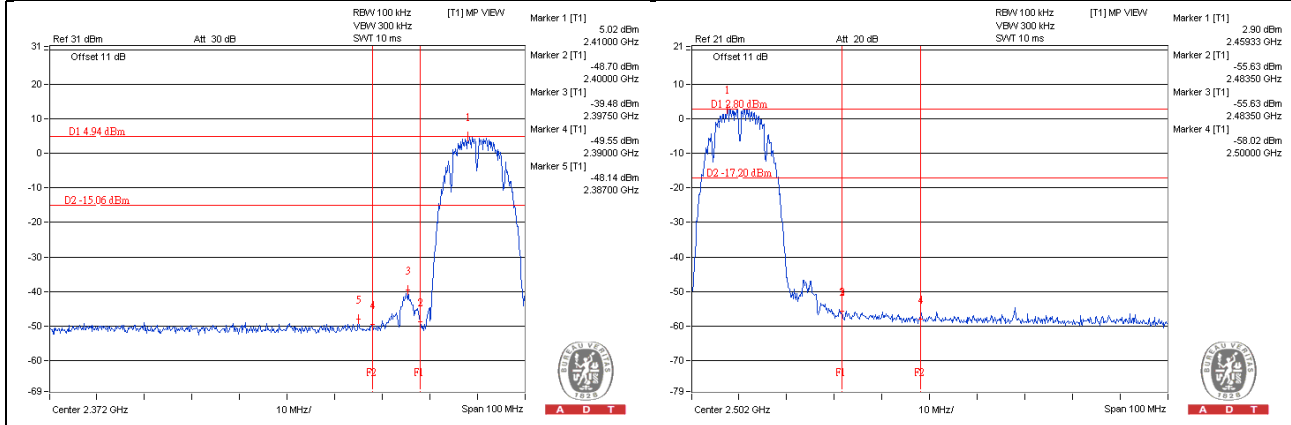

CHAIN 1

CH 1

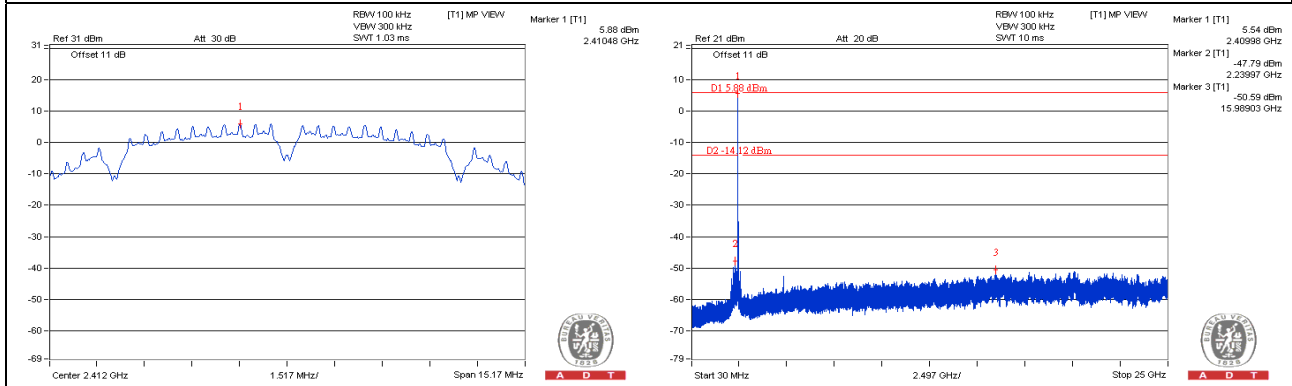

CH 6

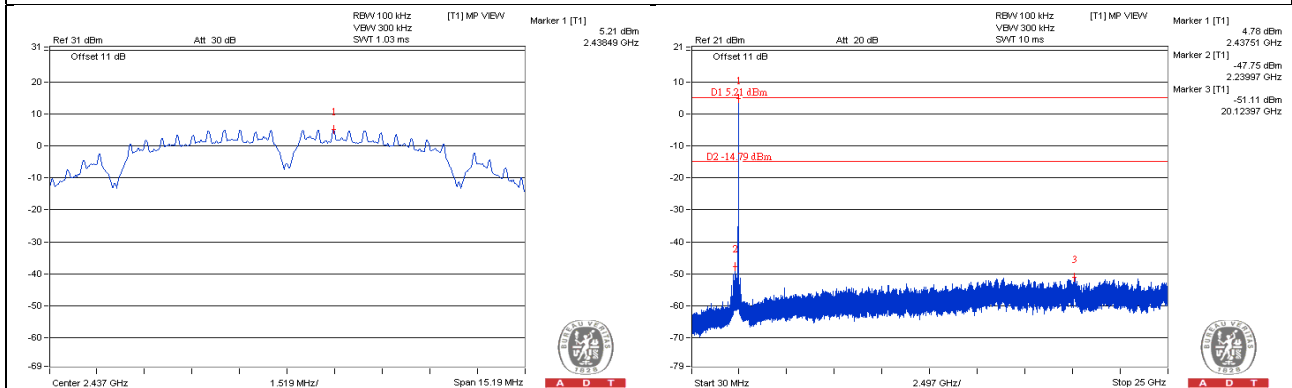

CH 11

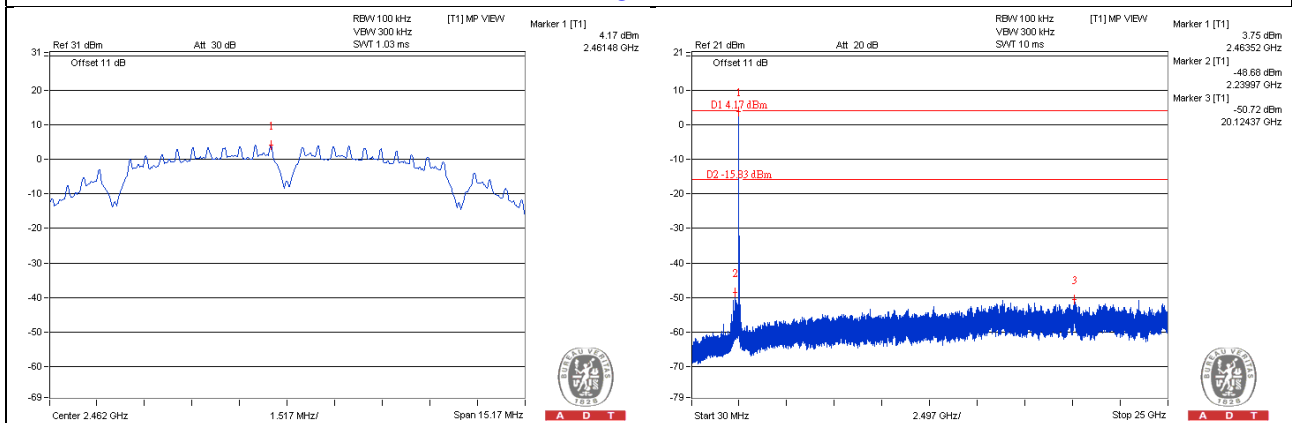

CH 1 Band edge

CH 11 Band edge

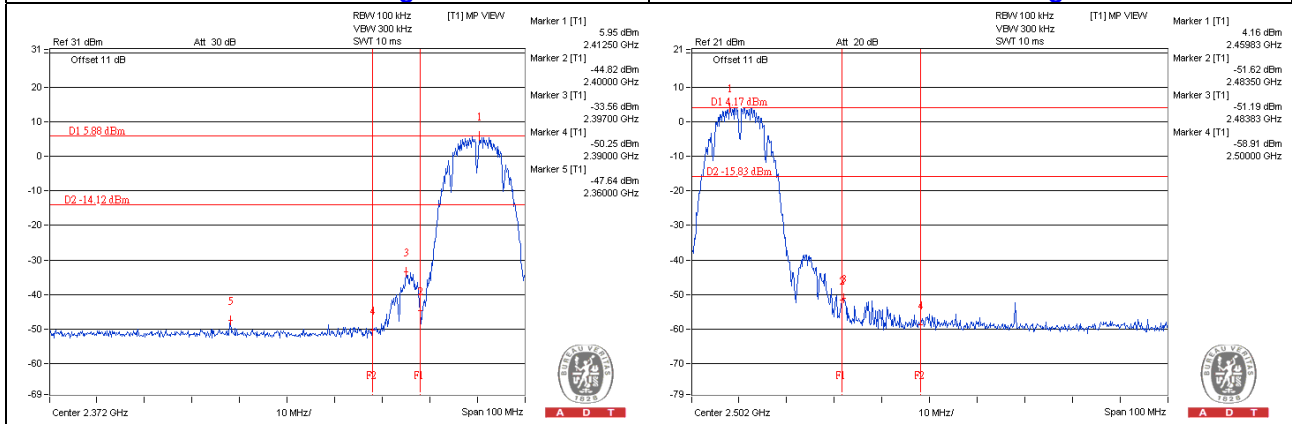

802.11g: CHAIN 0

CH 1

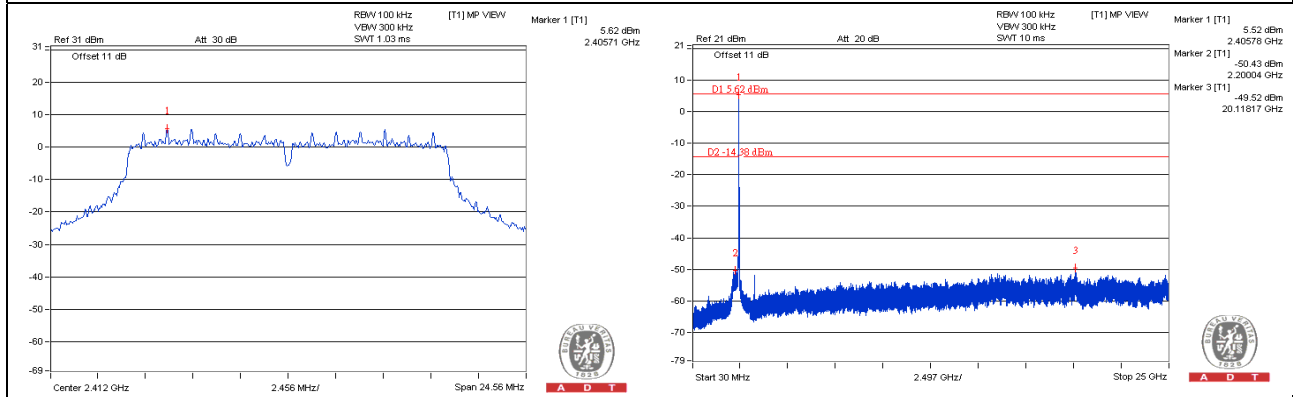

CH 6

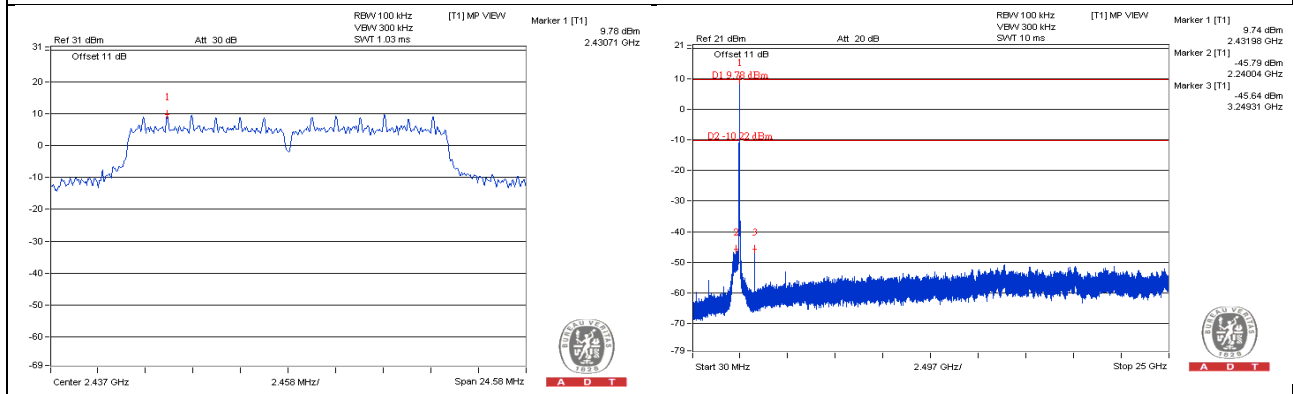

CH 11

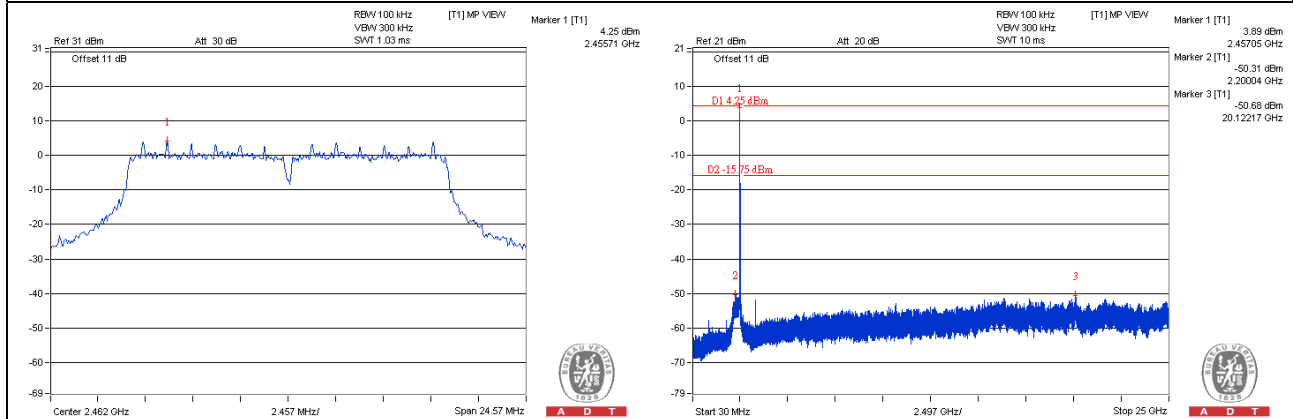

CH 1 Band edge

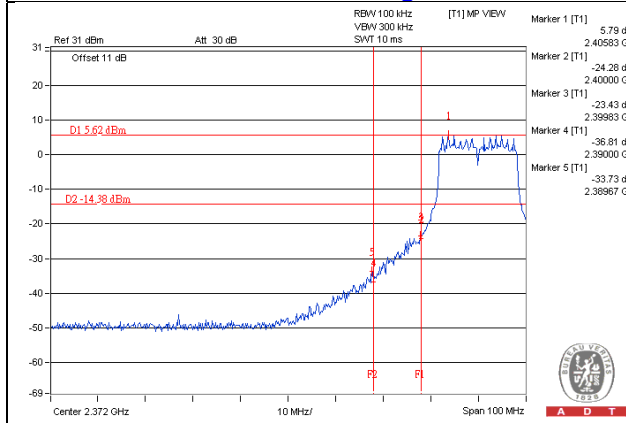

CH 11 Band edge

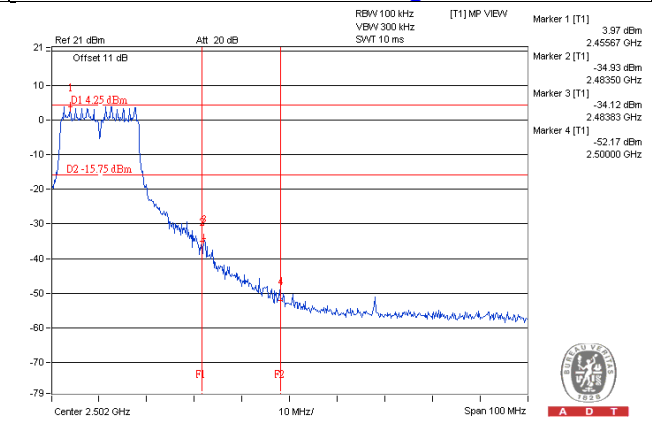

CHAIN 1

CH 1

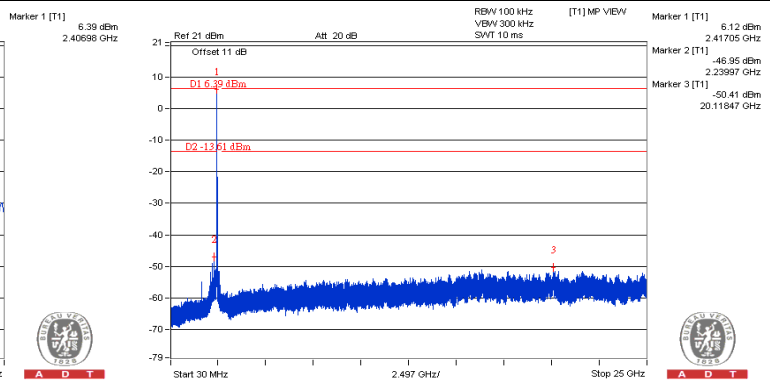
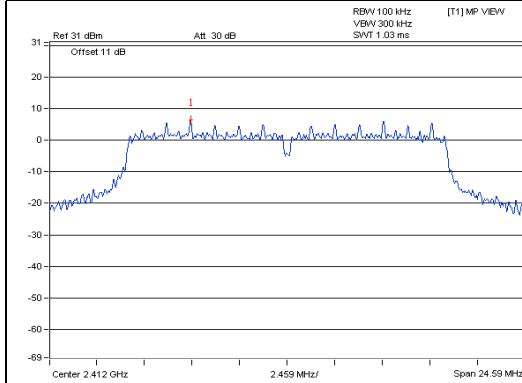

CH 6

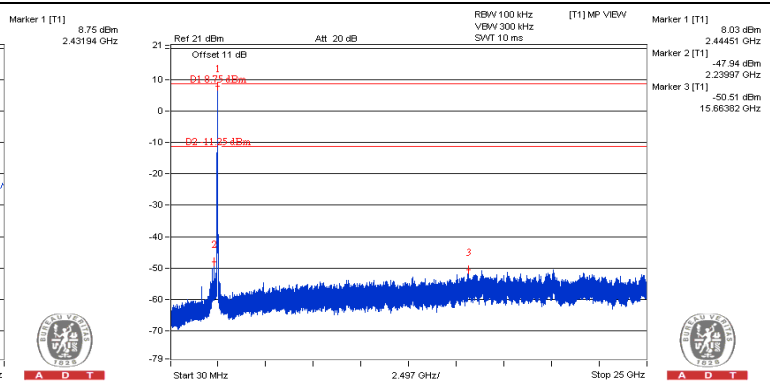
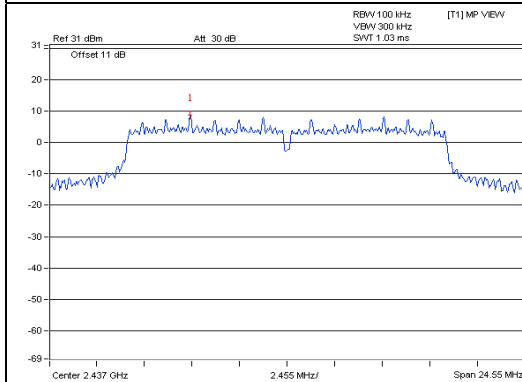

CH 11

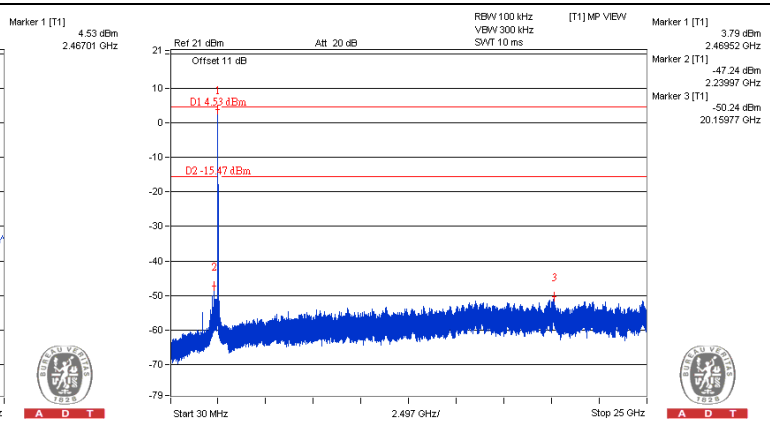
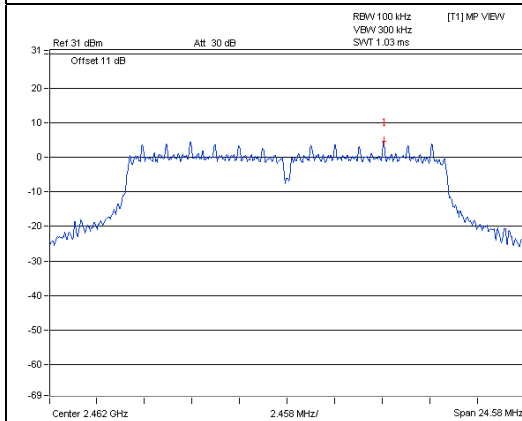

CH 1 Band edge

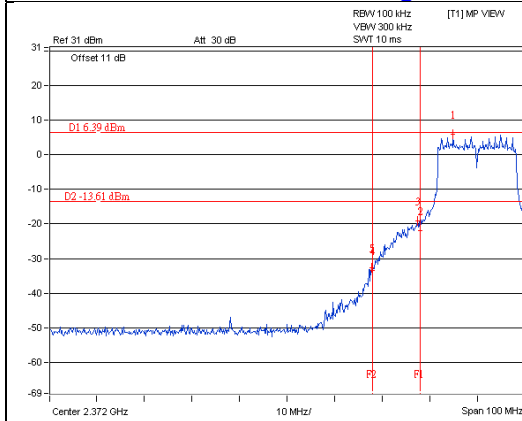

CH 11 Band edge

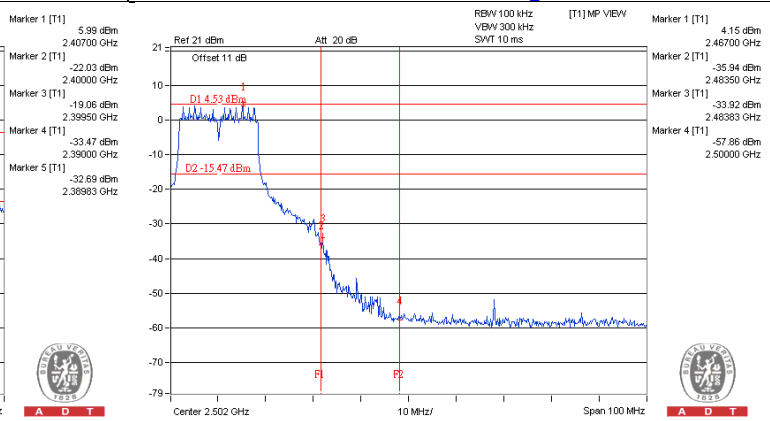

802.11n (HT20): CHAIN 0

CH 1

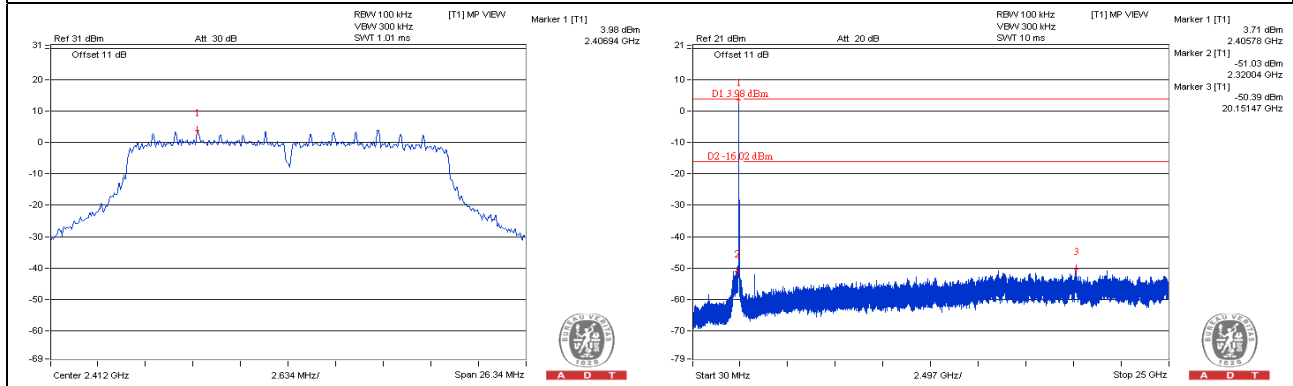

CH 6

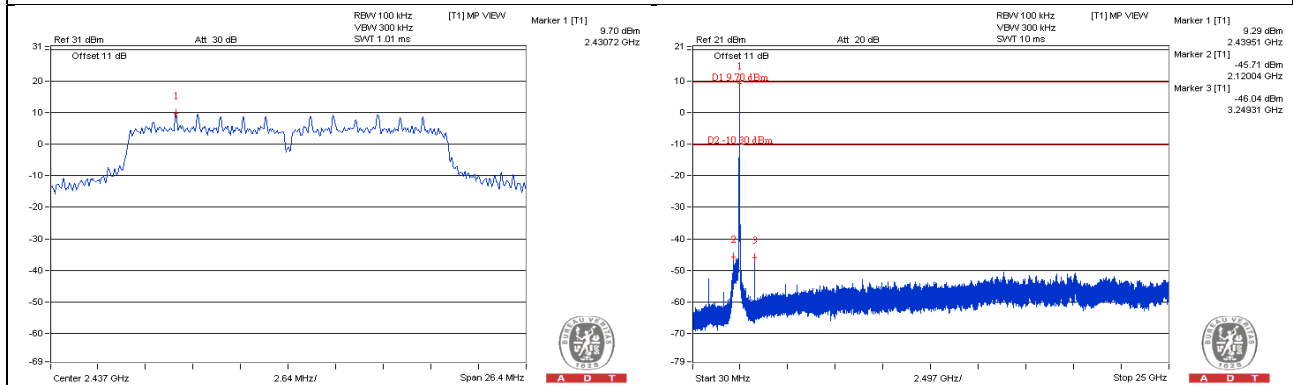

CH 11

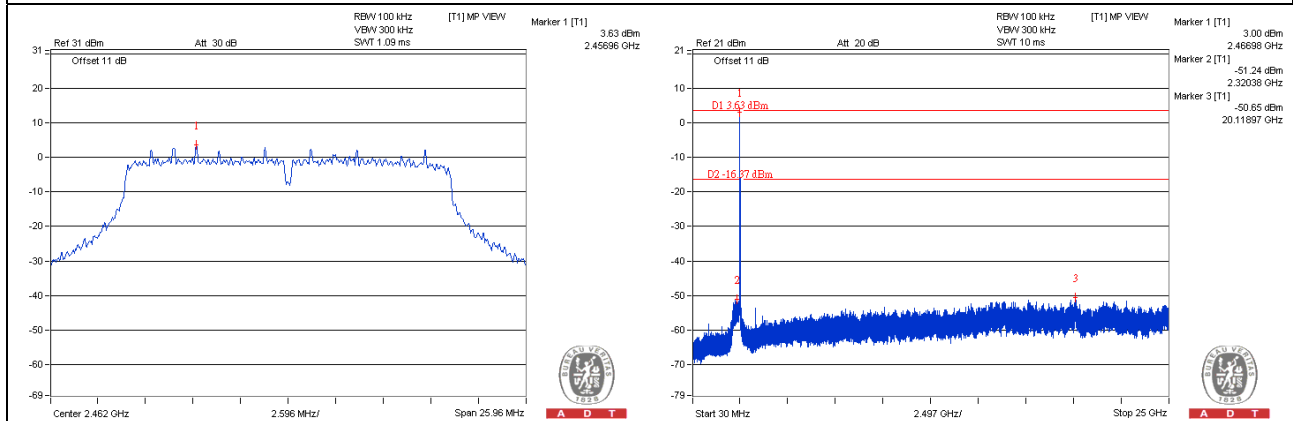

CH 1 Band edge

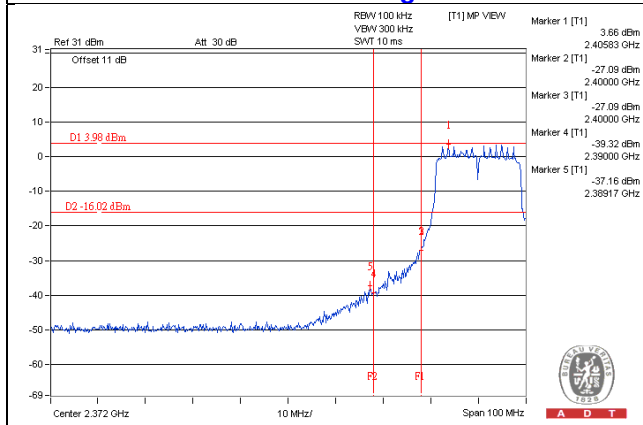

CH 11 Band edge

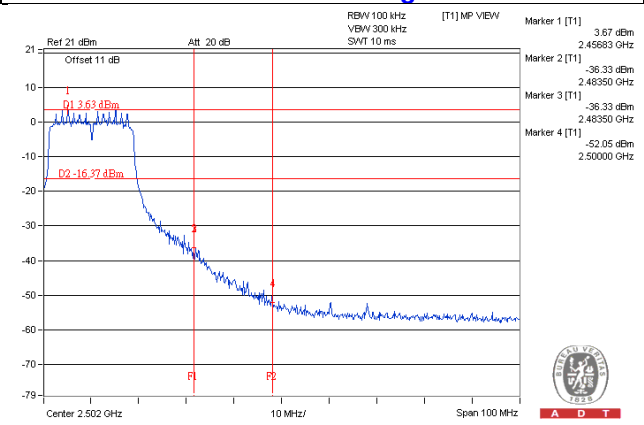

CHAIN 1

CH 1

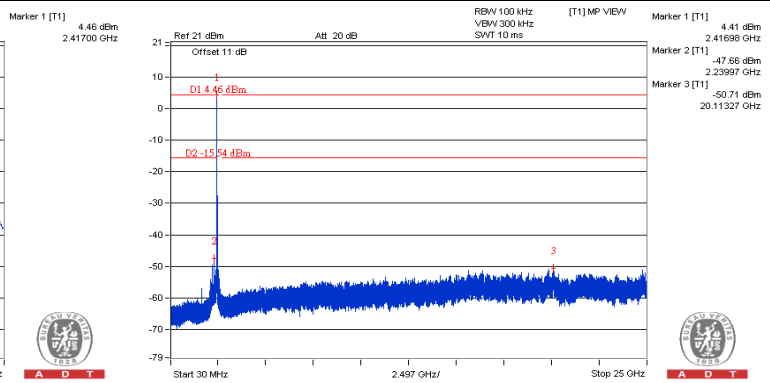
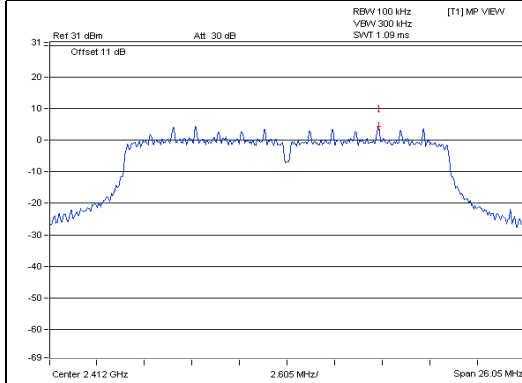

CH 6

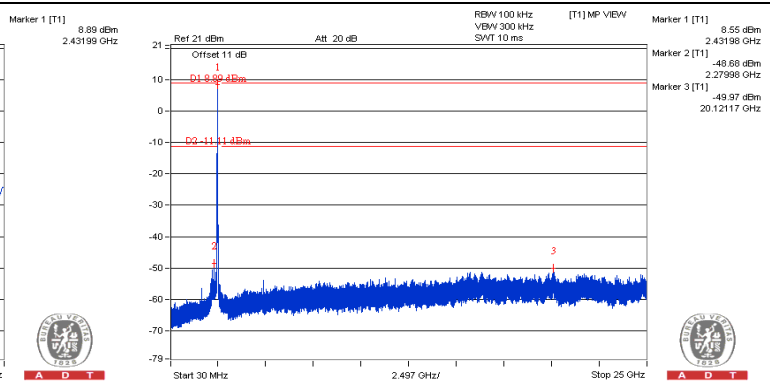
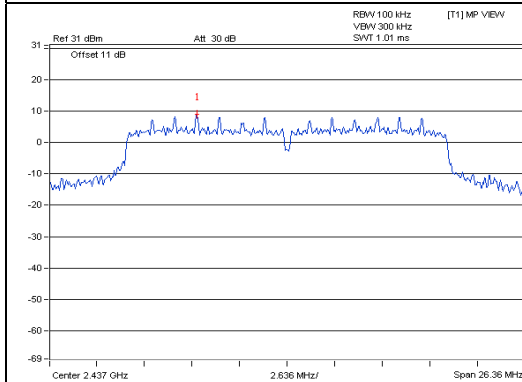

CH 11

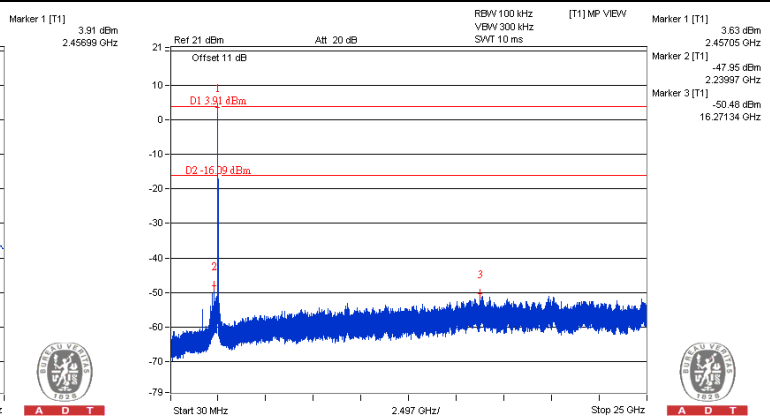
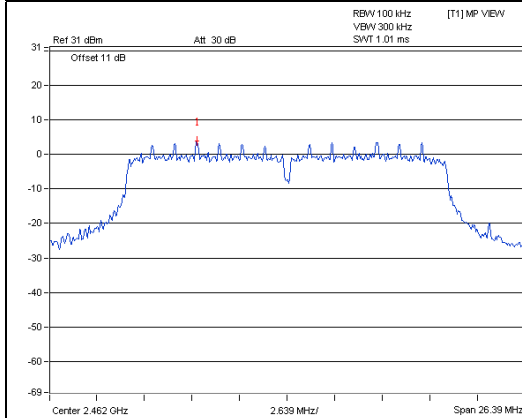

CH 1 Band edge

CH 11 Band edge

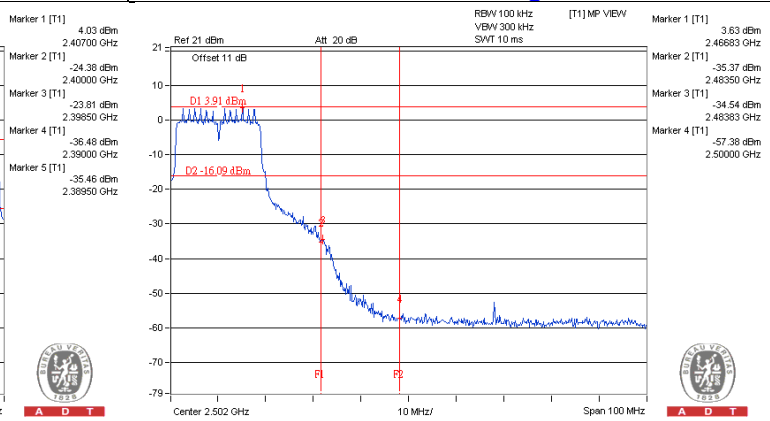
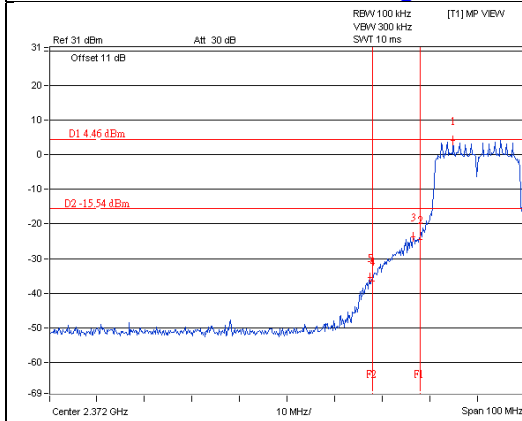

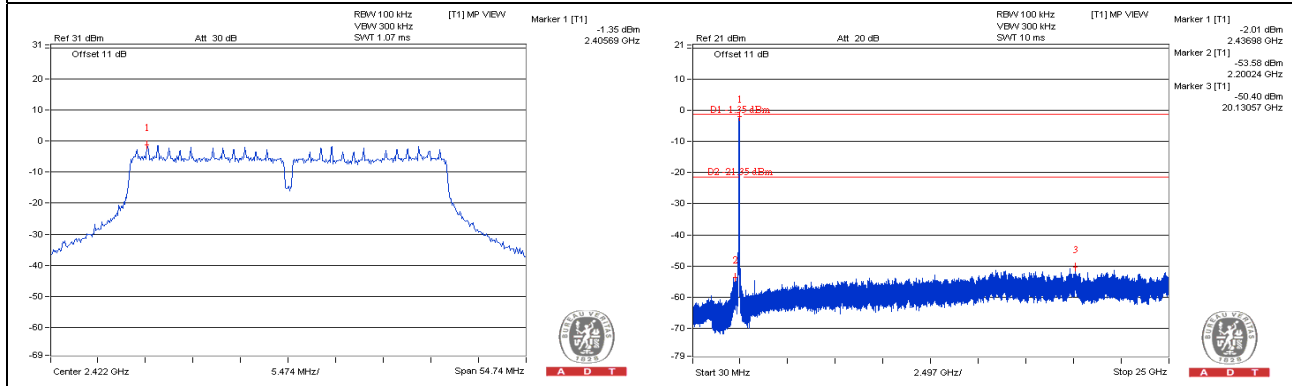
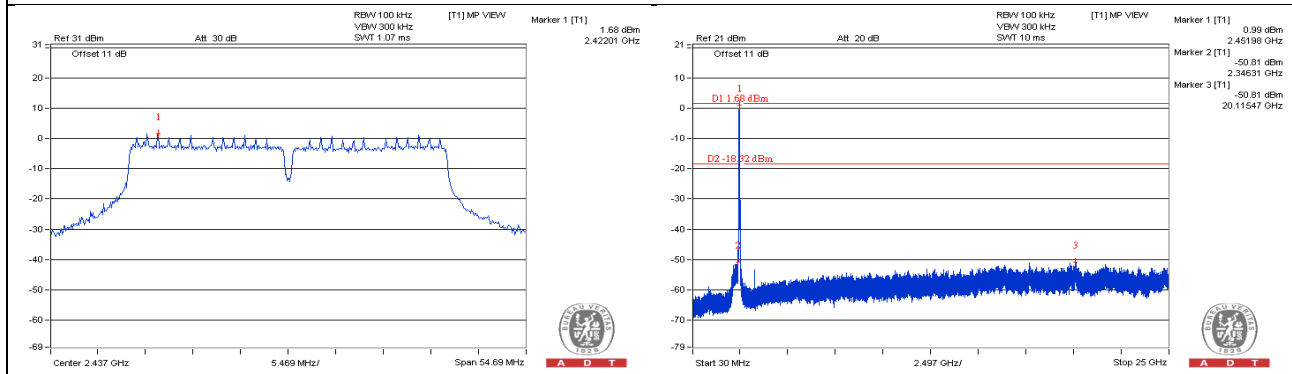
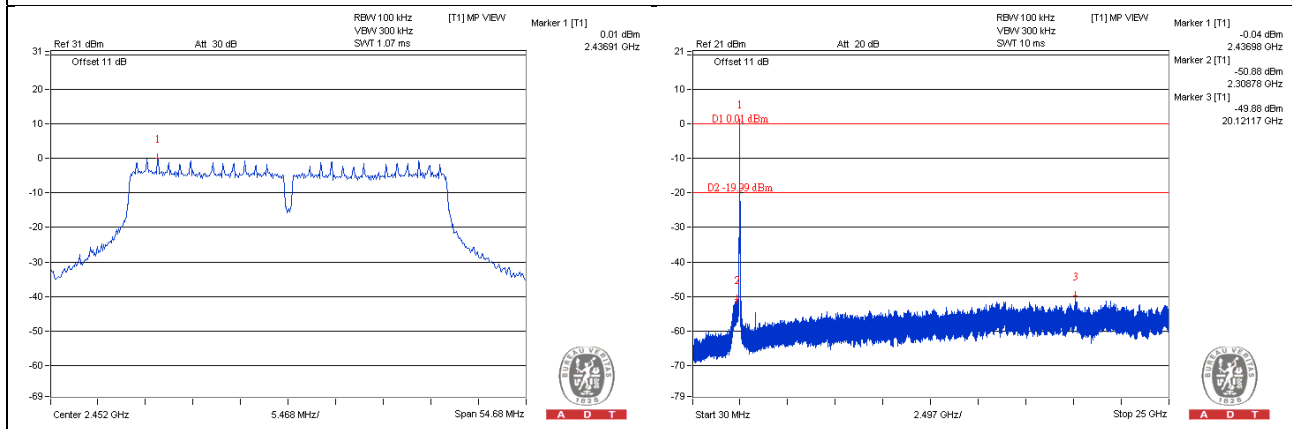
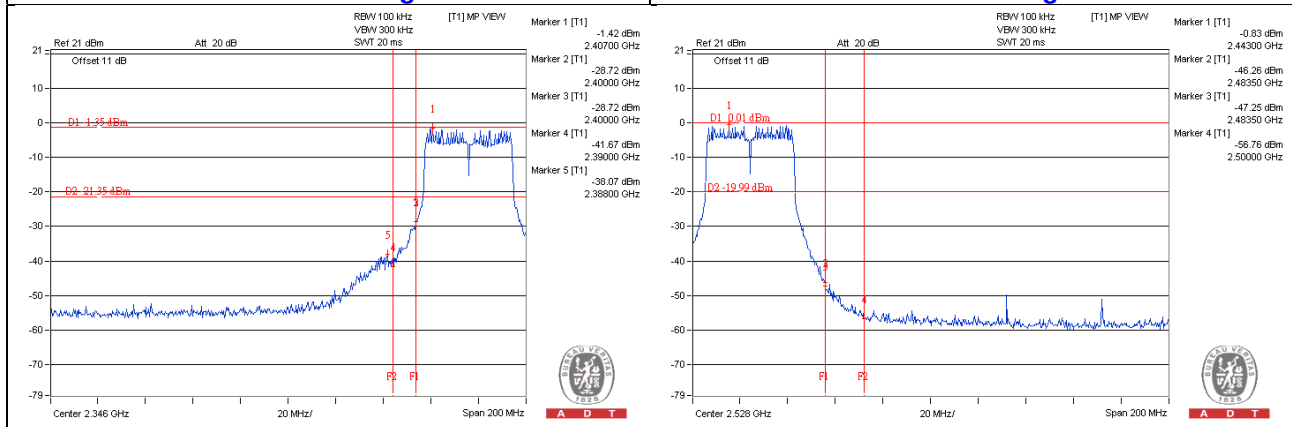
802.11n (HT40): CHAIN 0
CH 3

CH 6

CH 9

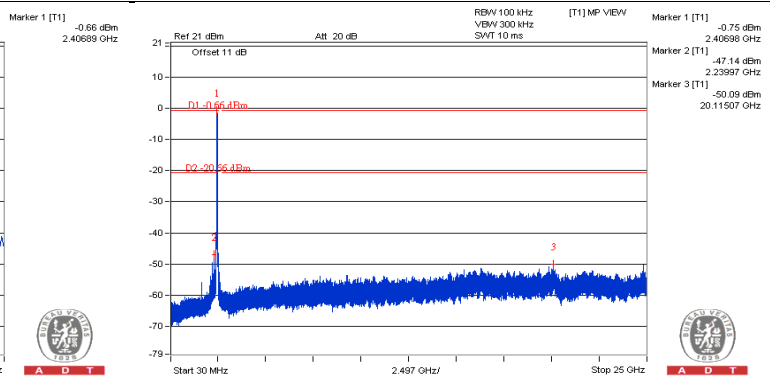
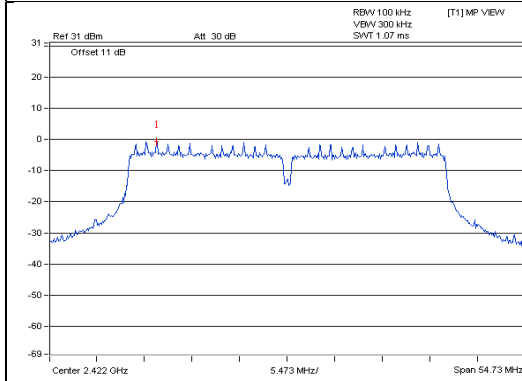
CH 3 Band edge
CH 9 Band edge

CHAIN 1

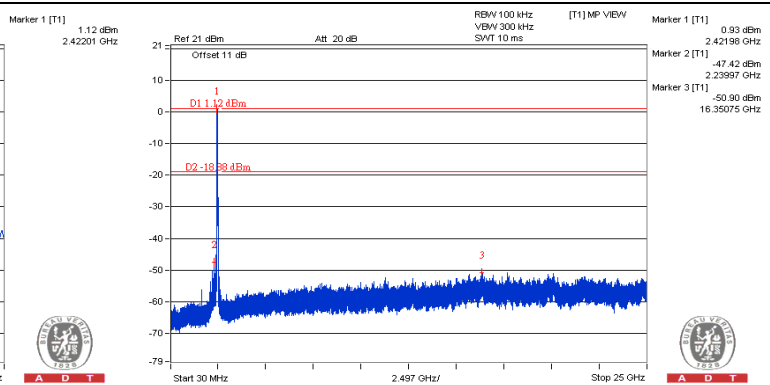
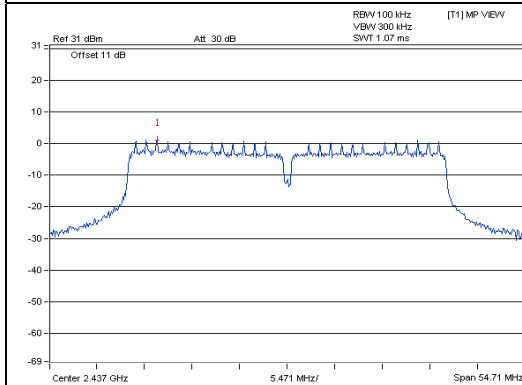
CH 3



CH 6



CH 9

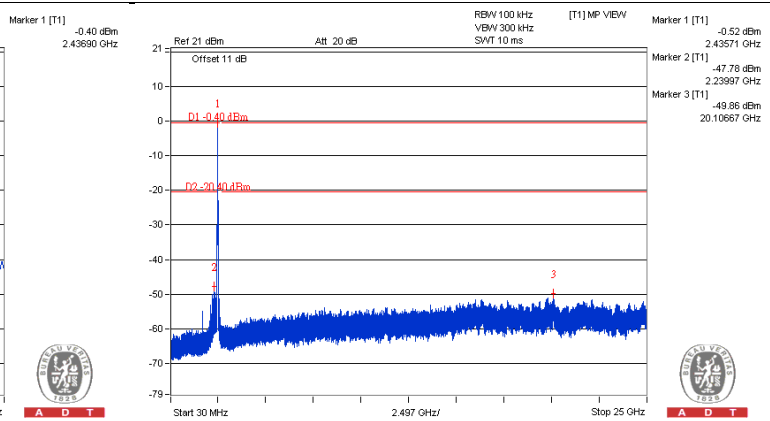
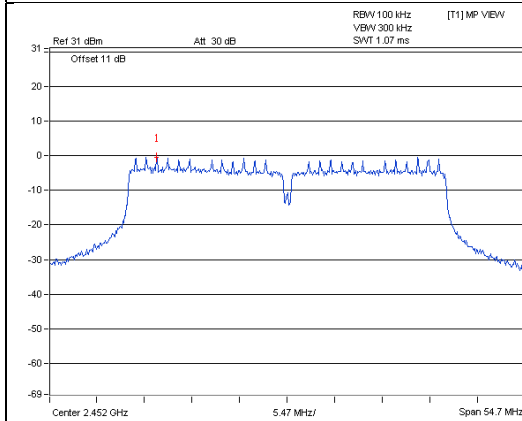

CH 3 Band edge

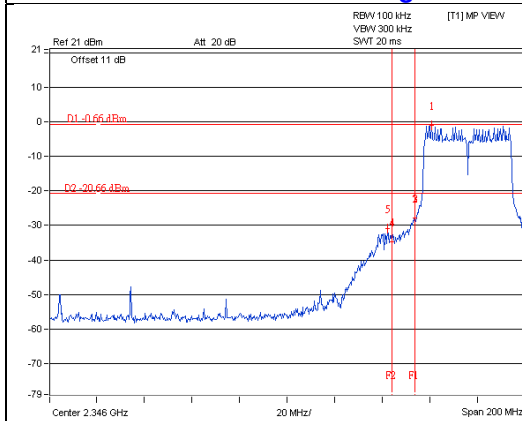

CH 9 Band edge

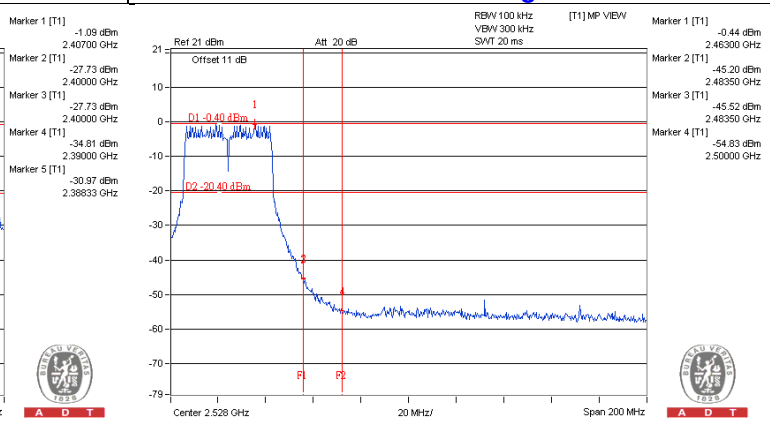

5 Pictures of Test Arrangements

Please refer to the attached file (Test Setup Photo).

Appendix – Information on the Testing Laboratories

We, Bureau Veritas Consumer Products Services (H.K.) Ltd., Taoyuan Branch, were founded in 1988 to provide our best service in EMC, Radio, Telecom and Safety consultation. Our laboratories are accredited and approved according to ISO/IEC 17025.

If you have any comments, please feel free to contact us at the following:

Linko EMC/RF Lab

Tel: 886-2-26052180

Fax: 886-2-26051924

Hsin Chu EMC/RF/Telecom Lab

Tel: 886-3-6668565

Fax: 886-3-6668323

Hwa Ya EMC/RF/Safety Lab

Tel: 886-3-3183232

Fax: 886-3-3270892

Email: service.adt@tw.bureauveritas.com

Web Site: www.bureauveritas-adt.com

The address and road map of all our labs can be found in our web site also.

--- END ---