



# DFS TEST REPORT

**REPORT NO.:** RF130820C06-2

**MODEL NO.:** EUB1200AC

**FCC ID:** A8J-EUB1200AC-1

**RECEIVED:** Aug. 20, 2013

**TESTED:** Sep. 19, 2013

**ISSUED:** Sep. 26, 2013

**APPLICANT:** EnGenius Technologies

**ADDRESS:** 1580 Scenic Avenue, Costa Mesa, CA92626

**ISSUED BY:** Bureau Veritas Consumer Products Services (H.K.)  
Ltd., Taoyuan Branch

**LAB ADDRESS:** No. 47, 14th Ling, Chia Pau Vil., Lin Kou Dist., New  
Taipei City, Taiwan ( R.O.C. )

**TEST LOCATION:** No. 19, Hwa Ya 2nd Rd, Wen Hwa Tsuen, Kwei  
Shan Hsiang, Taoyuan Hsien 333, Taiwan, R.O.C.

This report should not be used by the client to  
claim product certification, approval, or  
endorsement by TAF or any government agencies.



This report is for your exclusive use. Any copying or replication of this report to or for any other person or entity, or use of our name or trademark, is permitted only with our prior written permission. This report sets forth our findings solely with respect to the test samples identified herein. The results set forth in this report are not indicative or representative of the quality or characteristics of the lot from which a test sample was taken or any similar or identical product unless specifically and expressly noted. Our report includes all of the tests requested by you and the results thereof based upon the information that you provided to us. You have 60 days from date of issuance of this report to notify us of any material error or omission caused by our negligence, provided, however, that such notice shall be in writing and shall specifically address the issue you wish to raise. A failure to raise such issue within the prescribed time shall constitute your unqualified acceptance of the completeness of this report, the tests conducted and the correctness of the report contents. Unless specific mention, the uncertainty of measurement has been explicitly taken into account to declare the compliance or non-compliance to the specification.



## TABLE OF CONTENTS

RELEASE CONTROL RECORD .....	3
1 CERTIFICATION.....	4
2 EUT INFORMATION.....	5
2.1 OPERATING FREQUENCY BANDS AND MODE OF EUT .....	5
2.2 EUT SOFTWARE AND FIRMWARE VERSION.....	5
2.3 DESCRIPTION OF AVAILABLE ANTENNAS TO THE EUT .....	5
2.4 EUT MAXIMUM AND MINIMUM CONDUCTED POWER.....	6
2.5 EUT MAXIMUM AND MINIMUM E.I.R.P. POWER.....	8
2.6 TRANSMIT POWER CONTROL (TPC) .....	10
2.7 STATEMENT OF MAUNFACTURER.....	10
3 U-NII DFS RULE REQUIREMENTS.....	11
3.1 WORKING MODES AND REQUIRED TEST ITEMS .....	11
3.2 TEST LIMITS AND RADAR SIGNAL PARAMETERS .....	12
4 TEST & SUPPORT EQUIPMENT LIST .....	14
4.1 TEST INSTRUMENTS.....	14
4.2 DESCRIPTION OF SUPPORT UNITS .....	14
5 TEST PROCEDURE.....	15
5.1 ADT DFS MEASUREMENT SYSTEM:.....	15
5.2 CALIBRATION OF DFS DETECTION THRESHOLD LEVEL: .....	16
5.3 DEVIATION FROM TEST STANDARD.....	16
5.4 RADIATED TEST SETUP CONFIGURATION .....	17
5.4.1 CLIENT WITHOUT RADAR DETECTION MODE.....	17
6 TEST RESULTS .....	18
6.1 SUMMARY OF TEST RESULTS .....	18
6.2 TEST RESULTS .....	19
6.2.1 TEST MODE: DEVICE OPERATING IN CLIENT WITHOUT RADAR DETECTION MODE.....	19
6.2.2 CHANNEL CLOSING TRANSMISSION AND CHANNEL MOVE TIME .	20
6.2.3 NON- OCCUPANCY PERIOD .....	23
6.2.4 NON-ASSOCIATED TEST.....	25
6.2.5 NON- CO-CHANNEL TEST .....	25
7 INFORMATION ON THE TESTING LABORATORIES.....	26



## RELEASE CONTROL RECORD

ISSUE NO.	REASON FOR CHANGE	DATE ISSUED
RF130820C06-2	Original release	Sep. 26, 2013



# 1 CERTIFICATION

**PRODUCT:** Dual Band Wireless-AC USB Adapter

**MODEL:** EUB1200AC

**BRAND:** EnGenius

**APPLICANT:** EnGenius Technologies

**TEST SAMPLE:** ENGINEERING SAMPLE

**TESTED:** Sep. 19, 2013

**STANDARDS:** **FCC Part 15, Subpart E (Section 15.407)**

FCC 06-96

The above equipment (Model: EUB1200AC) has been tested by **Bureau Veritas Consumer Products Services (H.K.) Ltd., Taoyuan Branch**, and found compliance with the requirement of the above standards. The test record, data evaluation & Equipment Under Test (EUT) configurations represented herein are true and accurate accounts of the measurements of the sample's EMC characteristics under the conditions specified in this report.

**PREPARED BY** :  , **DATE** : Sep. 26, 2013

Pettie Chen / Senior Specialist

**APPROVED BY** :  , **DATE** : Sep. 26, 2013

Ken Liu / Senior Manager

## 2 EUT INFORMATION

### 2.1 OPERATING FREQUENCY BANDS AND MODE OF EUT

**TABLE 1: OPERATING FREQUENCY BANDS AND MODE OF EUT**

OPERATIONAL MODE	OPERATING FREQUENCY RANGE	
	5250~5350MHz	5470~5725MHz
Client without radar detection and ad hoc function	✓	✓

\*The EUT doesn't operate in 5600 ~ 5650MHz via software controls.

### 2.2 EUT SOFTWARE AND FIRMWARE VERSION

**TABLE 2: THE EUT SOFTWARE/FIRMWARE VERSION**

NO.	PRODUCT	MODEL NO.	SOFTWARE/FIRMWARE VERSION
1	Dual Band Wireless-AC USB Adapter	EUB1200AC	1024.3.718.2013

### 2.3 DESCRIPTION OF AVAILABLE ANTENNAS TO THE EUT

**TABLE 3: ANTENNA LIST**

ANT NO.	ANTENNA TYPE	OPERATION FREQUENCY RANGE (MHz)	MAX. GAIN (dBi)
1	Printed	5250-5725MHz	4

## 2.4 EUT MAXIMUM AND MINIMUM CONDUCTED POWER

**TABLE 4: THE MEASURED CONDUCTED OUTPUT POWER**

### 802.11a

ANT NO.	FREQUENCY BAND (MHz)	MAX. POWER	
		OUTPUT POWER(dBm)	OUTPUT POWER(mW)
1	5250~5350	16.92	49.204
1	5470~5725	12.80	19.055

### 802.11n (20MHz): 1TX

ANT NO.	FREQUENCY BAND (MHz)	MAX. POWER	
		OUTPUT POWER(dBm)	OUTPUT POWER(mW)
1	5250~5350	16.74	47.206
1	5470~5725	13.25	21.135

### 802.11n (20MHz): 2TX

ANT NO.	FREQUENCY BAND (MHz)	MAX. POWER	
		OUTPUT POWER(dBm)	OUTPUT POWER(mW)
1	5250~5350	17.87	61.262
1	5470~5725	16.65	46.249

**802.11n (40MHz): 1TX**

ANT NO.	FREQUENCY BAND (MHz)	MAX. POWER	
		OUTPUT POWER(dBm)	OUTPUT POWER(mW)
1	5250~5350	15.54	35.810
1	5470~5725	11.80	15.136

**802.11n (40MHz): 2TX**

ANT NO.	FREQUENCY BAND (MHz)	MAX. POWER	
		OUTPUT POWER(dBm)	OUTPUT POWER(mW)
1	5250~5350	17.41	55.066
1	5470~5725	15.54	35.827

**802.11ac (80MHz): 1TX**

ANT NO.	FREQUENCY BAND (MHz)	MAX. POWER	
		OUTPUT POWER(dBm)	OUTPUT POWER(mW)
1	5250~5350	15.57	36.058
1	5470~5725	12.29	16.943

**802.11ac (80MHz): 2TX**

ANT NO.	FREQUENCY BAND (MHz)	MAX. POWER	
		OUTPUT POWER(dBm)	OUTPUT POWER(mW)
1	5250~5350	17.94	62.166
1	5470~5725	15.05	31.966

## 2.5 EUT MAXIMUM AND MINIMUM E.I.R.P. POWER

**TABLE 5: THE E.I.R.P OUTPUT POWER LIST**

**802.11a**

ANT NO.	FREQUENCY BAND (MHz)	MAX. POWER	
		OUTPUT POWER(dBm)	OUTPUT POWER(mW)
1	5250~5350	20.92	123.595
1	5470~5725	16.80	47.863

**802.11n (20MHz): 1TX**

ANT NO.	FREQUENCY BAND (MHz)	MAX. POWER	
		OUTPUT POWER(dBm)	OUTPUT POWER(mW)
1	5250~5350	20.74	118.577
1	5470~5725	17.25	53.088

**802.11n (20MHz): 2TX**

ANT NO.	FREQUENCY BAND (MHz)	MAX. POWER	
		OUTPUT POWER(dBm)	OUTPUT POWER(mW)
1	5250~5350	21.87	153.815
1	5470~5725	20.65	116.145



**802.11n (40MHz): 1TX**

ANT NO.	FREQUENCY BAND (MHz)	MAX. POWER	
		OUTPUT POWER(dBm)	OUTPUT POWER(mW)
1	5250~5350	19.54	89.950
1	5470~5725	15.80	38.019

**802.11n (40MHz): 2TX**

ANT NO.	FREQUENCY BAND (MHz)	MAX. POWER	
		OUTPUT POWER(dBm)	OUTPUT POWER(mW)
1	5250~5350	21.41	138.357
1	5470~5725	19.54	89.950

**802.11ac (80MHz): 1TX**

ANT NO.	FREQUENCY BAND (MHz)	MAX. POWER	
		OUTPUT POWER(dBm)	OUTPUT POWER(mW)
1	5250~5350	19.57	90.573
1	5470~5725	16.29	42.560

**802.11ac (80MHz): 2TX**

ANT NO.	FREQUENCY BAND (MHz)	MAX. POWER	
		OUTPUT POWER(dBm)	OUTPUT POWER(mW)
1	5250~5350	21.94	156.315
1	5470~5725	19.05	80.353



## 2.6 TRANSMIT POWER CONTROL (TPC)

U-NII devices operating in the 5.25-5.35 GHz band and the 5.47-5.725 GHz band shall employ a TPC mechanism. The U-NII device is required to have the capability to operate at least 6 dB below the mean EIRP value of 30 dBm. A TPC mechanism is not required for systems with an e.i.r.p. of less than 500 mW.

Maximum EIRP of this device is 123.595 mW which less than 500mW, therefore it's not require TPC function.

## 2.7 STATEMENT OF MAUNFACTURER

Manufacturer statement confirming that information regarding the parameters of the detected Radar Waveforms is not available to the end user. **And the device doesn't have Ad Hoc mode on DFS frequency band.**

### 3 U-NII DFS RULE REQUIREMENTS

#### 3.1 WORKING MODES AND REQUIRED TEST ITEMS

The manufacturer shall state whether the UUT is capable of operating as a Master and/or a Client. If the UUT is capable of operating in more than one operating mode then each operating mode shall be tested separately. See tables 1 and 2 for the applicability of DFS requirements for each of the operational modes.

**TABLE 6: APPLICABILITY OF DFS REQUIREMENTS PRIOR TO USE A CHANNEL**

REQUIREMENT	OPERATIONAL MODE		
	MASTER	CLIENT WITHOUT RADAR DETECTION	CLIENT WITH RADAR DETECTION
Non-Occupancy Period	✓	Not required	✓
DFS Detection Threshold	✓	Not required	✓
Channel Availability Check Time	✓	Not required	Not required
Uniform Spreading	✓	Not required	Not required
U-NII Detection Bandwidth	✓	Not required	✓

**TABLE 7: APPLICABILITY OF DFS REQUIREMENTS DURING NORMAL OPERATION**

REQUIREMENT	OPERATIONAL MODE		
	MASTER	CLIENT WITHOUT RADAR DETECTION	CLIENT WITH RADAR DETECTION
DFS Detection Threshold	✓	Not required	✓
Channel Closing Transmission Time	✓	✓	✓
Channel Move Time	✓	✓	✓
U-NII Detection Bandwidth	✓	Not required	✓

### 3.2 TEST LIMITS AND RADAR SIGNAL PARAMETERS

#### DETECTION THRESHOLD VALUES

**TABLE 8: DFS DETECTION THRESHOLDS FOR MASTER DEVICES AND CLIENT DEVICES WITH RADAR DETECTION**

MAXIMUM TRANSMIT POWER	VALUE (SEE Note 1 and 2)
≥ 200 milliwatt	-64 dBm
< 200 milliwatt	-62 dBm

**Note 1:** This is the level at the input of the receiver assuming a 0 dBi receive antenna.

**Note 2:** Throughout these test procedures an additional 1 dB has been added to the amplitude of the test transmission waveforms to account for variations in measurement equipment. This will ensure that the test signal is at or above the detection threshold level to trigger a DFS response.

**TABLE 9: DFS RESPONSE REQUIREMENT VALUES**

PARAMETER	VALUE
Non-occupancy period	Minimum 30 minutes
Channel Availability Check Time	60 seconds
Channel Move Time	10 seconds See Note 1.
Channel Closing Transmission Time	200 milliseconds + an aggregate of 60 milliseconds over remaining 10 second period. See Notes 1 and 2.
U-NII Detection Bandwidth	Minimum 80% of the UNII 99% transmission power bandwidth. See Note 3.

**Note 1:** The instant that the Channel Move Time and the Channel Closing Transmission Time begins is as follows:

For the Short Pulse Radar Test Signals this instant is the end of the Burst.

For the Frequency Hopping radar Test Signal, this instant is the end of the last radar Burst generated.

For the Long Pulse Radar Test Signal this instant is the end of the 12 second period defining the Radar Waveform.

**Note 2:** The Channel Closing Transmission Time is comprised of 200 milliseconds starting at the beginning of the Channel Move Time plus any additional intermittent control signals required to facilitate a Channel move (an aggregate of 60 milliseconds) during the remainder of the 10 second period. The aggregate duration of control signals will not count quiet periods in between transmissions.

**Note 3:** During the U-NII Detection Bandwidth detection test, radar type 1 is used and for each frequency step the minimum percentage of detection is 90 percent. Measurements are performed with no data traffic.

## **PARAMETERS OF DFS TEST SIGNALS**

Step intervals of 0.1 microsecond for Pulse Width, 1 microsecond for PRI, 1 MHz for chirp width and 1 for the number of pulses will be utilized for the random determination of specific test waveforms.

**TABLE 10: SHORT PULSE RADAR TEST WAVEFORMS**

<b>RADAR TYPE</b>	<b>PULSE WIDTH (μsec)</b>	<b>PRI (μsec)</b>	<b>NUMBER OF PULSES</b>	<b>MINIMUM PERCENTAGE OF SUCCESSFUL DETECTION</b>	<b>MINIMUM NUMBER OF TRIALS</b>
1	1	1428	18	60%	30
2	1-5	150-230	23-29	60%	30
3	6-10	200-500	16-18	60%	30
4	11-20	200-500	12-16	60%	30
Aggregate (Radar Types 1-4)				80%	120

**TABLE 11: LONG PULSE RADAR TEST WAVEFORM**

<b>RADAR TYPE</b>	<b>PULSE WIDTH (μsec)</b>	<b>CHIRP WIDTH (MHz)</b>	<b>PRI (μsec)</b>	<b>NUMBER OF PULSES PER BURST</b>	<b>NUMBER OF BURSTS</b>	<b>MINIMUM PERCENTAGE OF SUCCESSFUL DETECTION</b>	<b>MINIMUM NUMBER OF TRIALS</b>
5	50-100	5-20	1000-2000	1-3	8-20	80%	30

**TABLE 12: FREQUENCY HOPPING RADAR TEST WAVEFORM**

<b>RADAR TYPE</b>	<b>PULSE WIDTH (μsec)</b>	<b>PRI (μsec)</b>	<b>PULSES PER HOP</b>	<b>HOPPING RATE (kHz)</b>	<b>HOPPING SEQUENCE LENGTH (msec)</b>	<b>MINIMUM PERCENTAGE OF SUCCESSFUL DETECTION</b>	<b>MINIMUM NUMBER OF TRIALS</b>
6	1	333	9	0.333	300	70%	30

## 4 TEST & SUPPORT EQUIPMENT LIST

### 4.1 TEST INSTRUMENTS

**TABLE 1: TEST INSTRUMENTS LIST**

DESCRIPTION & MANUFACTURER	MODEL NO.	BRAND	DATE OF CALIBRATION	DUE DATE OF CALIBRATION
R&S Spectrum analyzer	FSP40	R&S	2013/01/28	2014/01/27
Signal generator	8645A	Agilent	2013/06/25	2014/06/24
Oscilloscope	TDS 5104	Tektronix	2013/03/08	2014/03/07

### 4.2 DESCRIPTION OF SUPPORT UNITS

**TABLE 2: SUPPORT UNIT INFORMATION**

NO.	PRODUCT	BRAND	MODEL NO.	FCC ID	GAIN
1	Router	D-Link	DIR-868L	RRK2012060056-1	5G Ant gain: 3.428dB Maximum EIRP: 27.64dBm

**NOTE:** This device was functioned as a  Master  Slave device during the DFS test.

**TABLE 3: SOFTWARE/FIRMWARE INFORMATION**

NO.	PRODUCT	MODEL NO.	SOFTWARE/FIRMWARE VERSION
1.	Router	DIR-868L	1.00

## 5 TEST PROCEDURE

### 5.1 ADT DFS MEASUREMENT SYSTEM:

A complete ADT DFS Measurement System consists of two subsystems: (1) the Radar Signal Generating Subsystem and (2) the Traffic Monitoring Subsystem. The control PC is necessary for generating the Radar waveforms in Table 6, 7 and 8. The traffic monitoring subsystem is specified to the type of unit under test (UUT).

#### Radiated setup configuration of ADT DFS Measurement System

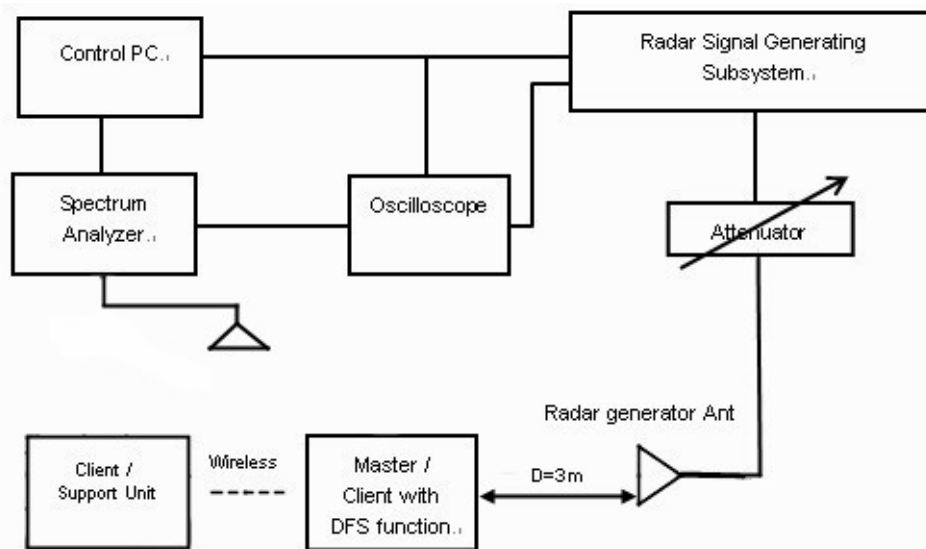

The test transmission will always be from the Master Device to the Client Device. While the Client device is set up to associate with the Master device and play the MPEG file (6  $\frac{1}{2}$  Magic Hours) from Master device, the designated MPEG test file and instructions are located at:

<http://ntiacsd.ntia.doc.gov/dfs/>.

## 5.2 CALIBRATION OF DFS DETECTION THRESHOLD LEVEL:

The measured channel is 5500MHz, 5510MHz and 5530MHz. The radar signal was the same as transmitted channels, and injected into the antenna of AP (master) or Client Device with Radar Detection, measured the channel closing transmission time and channel move time. The calibrated conducted detection threshold level is set to -64dBm. The tested level is lower than required level hence it provides margin to the limit.

### Radiated setup configuration of Calibration of DFS Detection Threshold Level

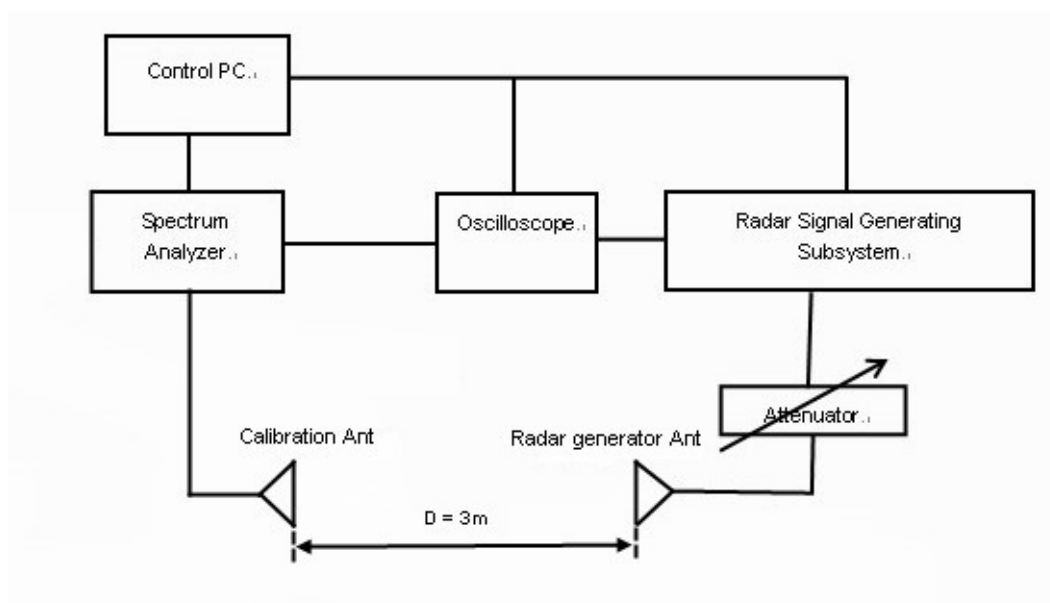

## 5.3 DEVIATION FROM TEST STANDARD

No deviation.



## 5.4 RADIATED TEST SETUP CONFIGURATION

### 5.4.1 CLIENT WITHOUT RADAR DETECTION MODE

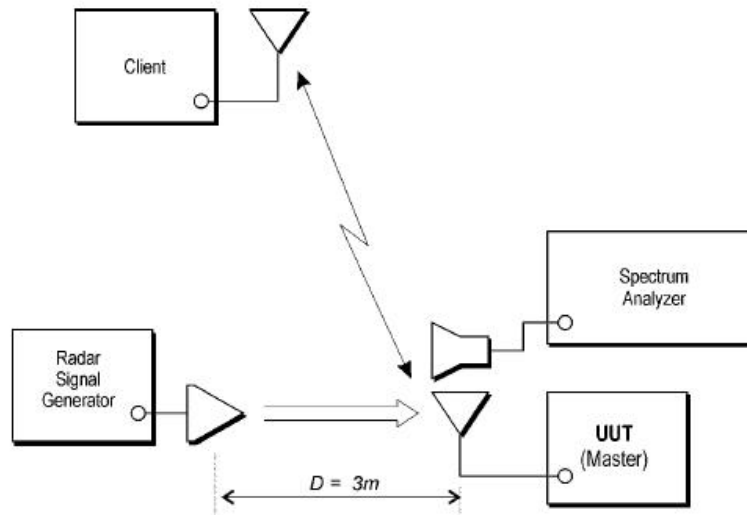

The UUT is a U-NII Device operating in Client mode without radar detection. The radar test signals are injected into the Master Device.

## 6 TEST RESULTS

### 6.1 SUMMARY OF TEST RESULTS

CLAUSE	TEST PARAMETER	REMARKS	PASS/FAIL
15.407	DFS Detection Threshold	Not Applicable	NA
15.407	Channel Availability Check Time	Not Applicable	NA
15.407	Channel Move Time	Applicable	Pass
15.407	Channel Closing Transmission Time	Applicable	Pass
15.407	Non- Occupancy Period	Applicable	Pass
15.407	Uniform Spreading	Not Applicable	NA
15.407	U-NII Detection Bandwidth	Not Applicable	NA
15.407	Non-associated test	Applicable	Pass
15.407	Non-Co-Channel test	Applicable	Pass

## 6.2 TEST RESULTS

### 6.2.1 TEST MODE: DEVICE OPERATING IN CLIENT WITHOUT RADAR DETECTION MODE.

Client with injection at the Master. (The radar test signals are injected into the Master Device)

#### DFS DETECTION THRESHOLD

The Required detection threshold is -64 dBm. The tested level is lower than required level hence it provides margin to the limit.

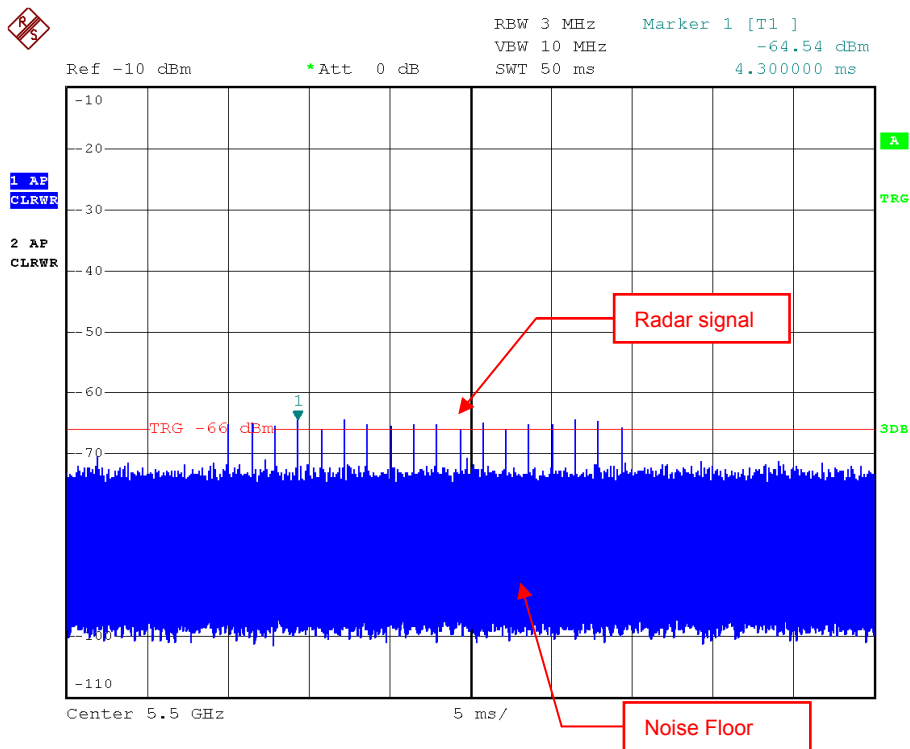

Radar Signal 1

## 6.2.2 CHANNEL CLOSING TRANSMISSION AND CHANNEL MOVE TIME

### RADAR SIGNAL 1

#### 802.11an 20MHz

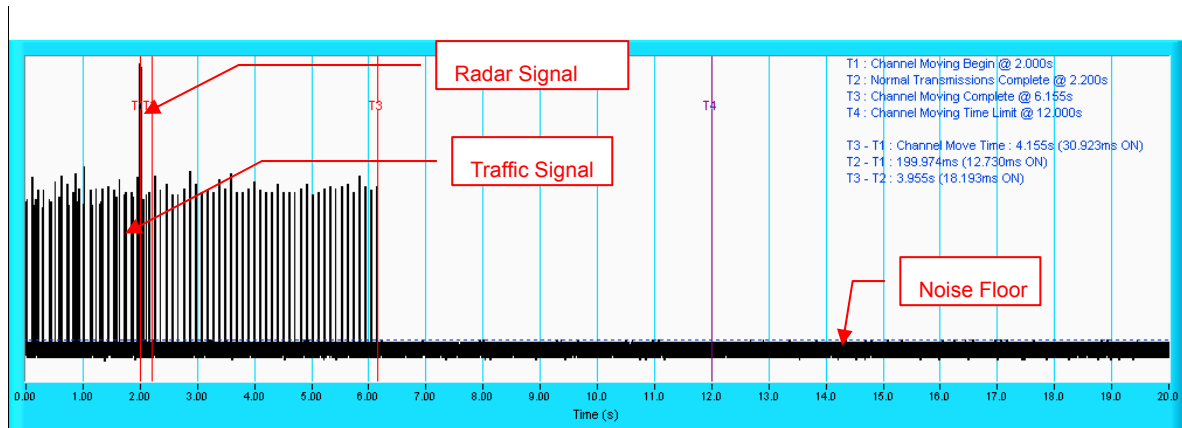

**NOTE:** T1 denotes the start of Channel Move Time upon the end of the last Radar burst. T2 denotes the data transmission time of 200ms from T1. T3 denotes the end of Channel Move Time. T4 denotes the 10 second from T1 to observe the aggregate duration of transmissions.

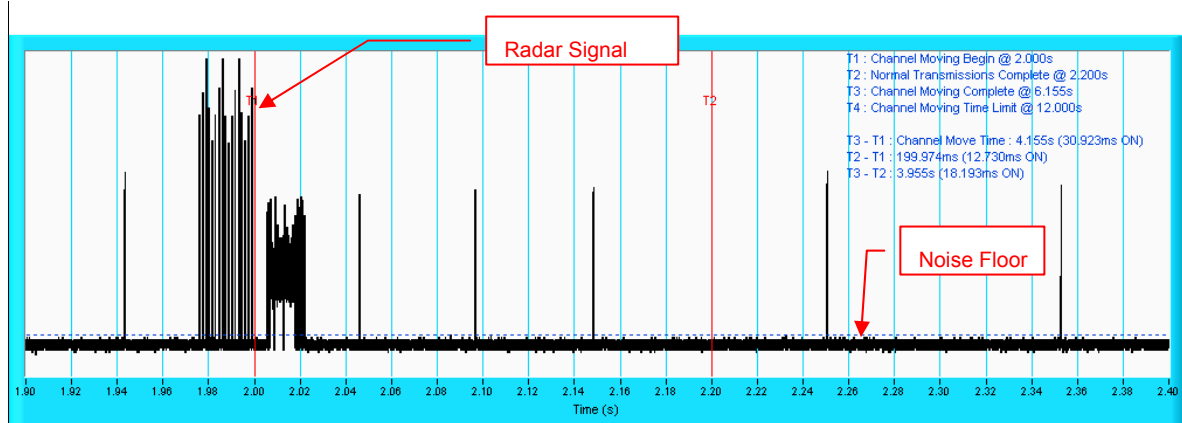

**NOTE:** An expanded plot for the device vacates the channel in the required 500ms.

## RADAR SIGNAL 1

### 802.11an 40MHz

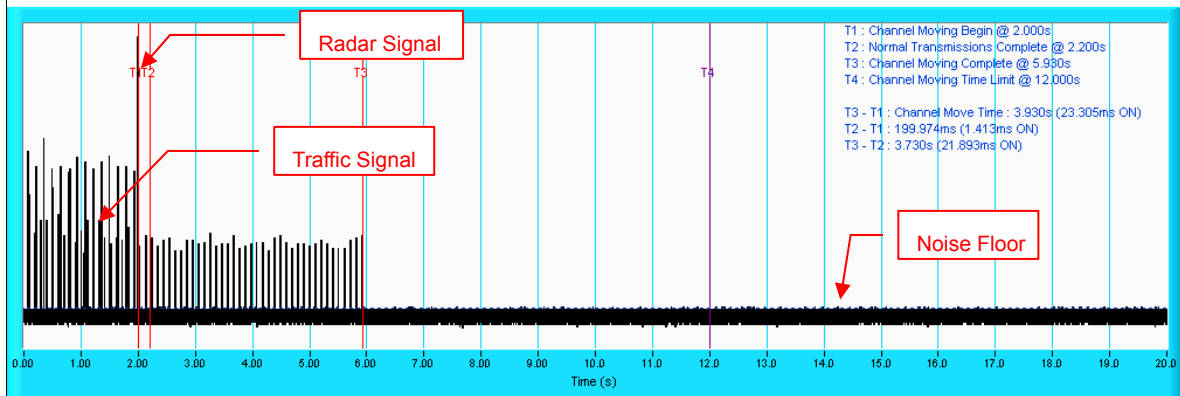

**NOTE:** T1 denotes the start of Channel Move Time upon the end of the last Radar burst. T2 denotes the data transmission time of 200ms from T1. T3 denotes the end of Channel Move Time. T4 denotes the 10 second from T1 to observe the aggregate duration of transmissions.

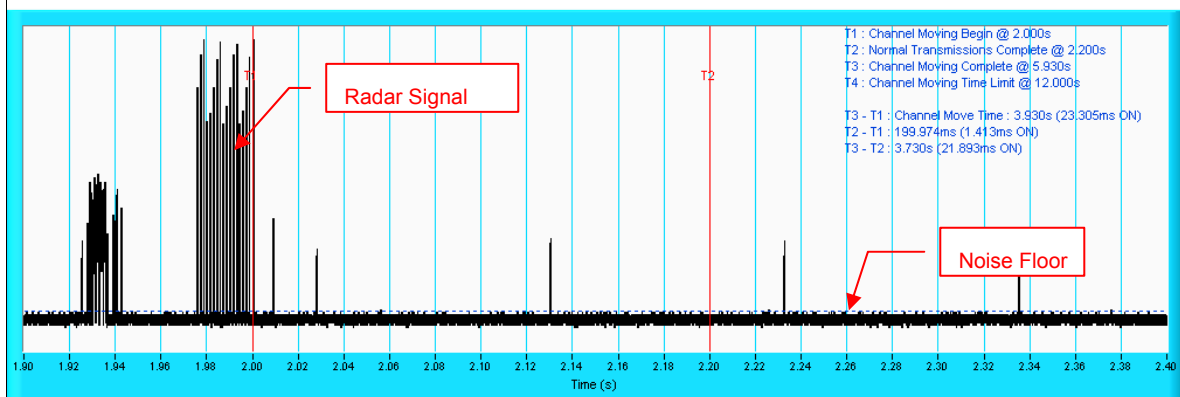

**NOTE:** An expanded plot for the device vacates the channel in the required 500ms.

## RADAR SIGNAL 1

### 802.11ac 80MHz

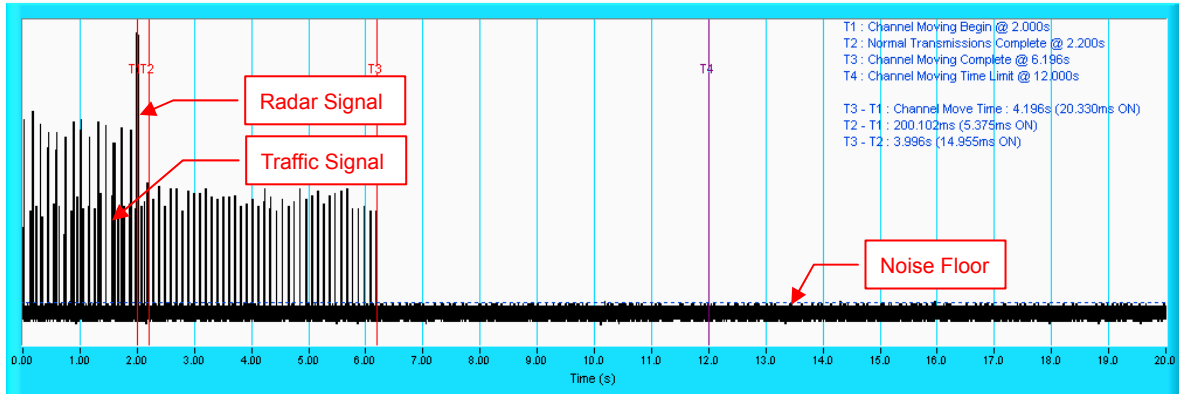

**NOTE:** T1 denotes the start of Channel Move Time upon the end of the last Radar burst. T2 denotes the data transmission time of 200ms from T1. T3 denotes the end of Channel Move Time. T4 denotes the 10 second from T1 to observe the aggregate duration of transmissions.

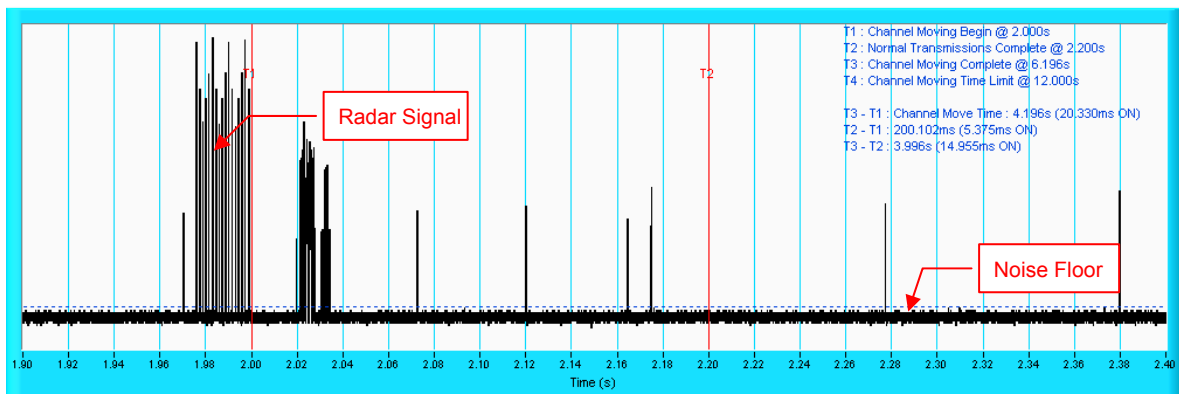

**NOTE:** An expanded plot for the device vacates the channel in the required 500ms.

### 6.2.3 NON- OCCUPANCY PERIOD

**Associate test:**

During the 30 minutes observation time, UUT did not make any transmissions on a channel after a radar signal was detected on that channel by either the Channel Availability Check or the In-Service Monitoring.

1) EUT (Client) links with master on 5500MHz.

Waveform of EUT links up with Master

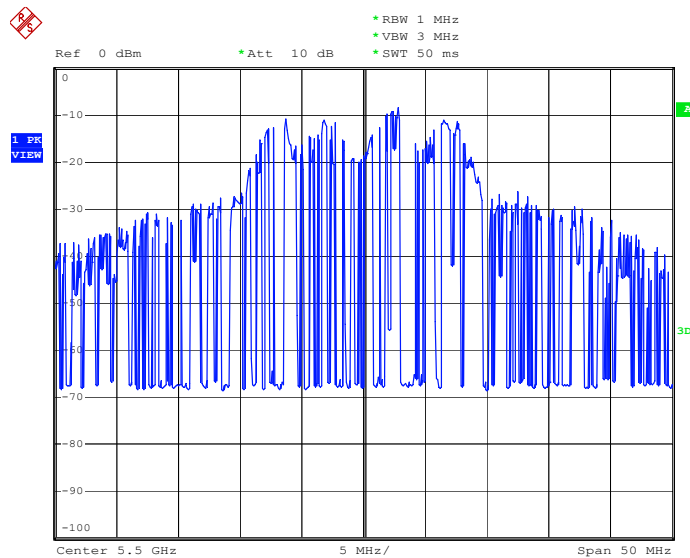

2) Client plays specified files via master.

Waveform of transmission

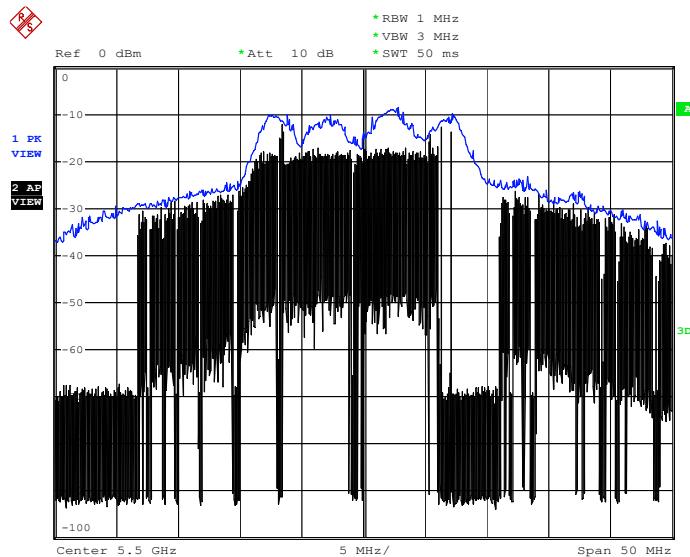

3) Radar signal 1 is applied to the Master device and WiFi traffic signal stop immediately.

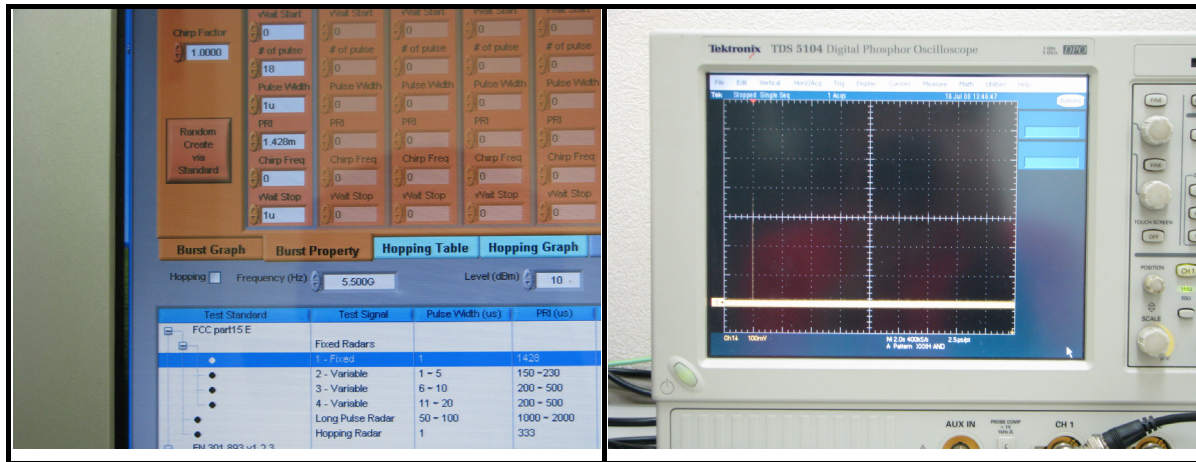

4) 5500MHz has been monitored in 30 minutes period. In this period, no any transmission occurs.

Plot of 30minutes period

802.11n 20MHz

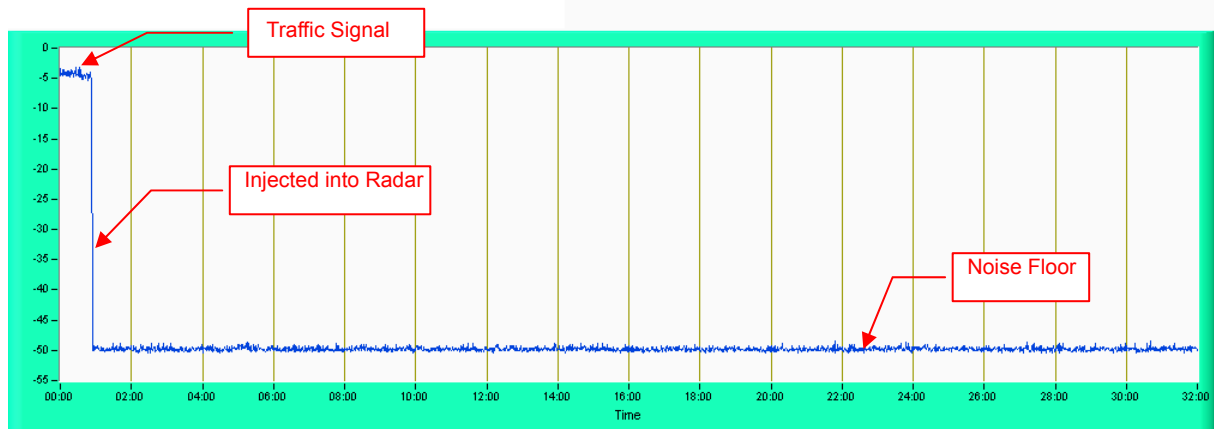

**NOTE:** Test setup photos are shown on Test set up photo.pdf



## 6.2.4 NON-ASSOCIATED TEST

Master was off.

During the 30 minutes observation time, The UUT did not make any transmissions in the DFS band after UUT power up.

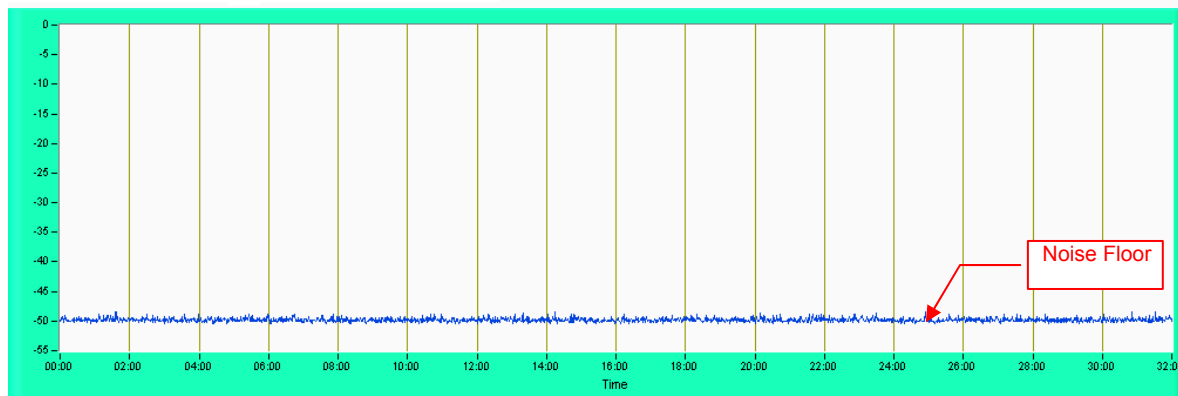

## 6.2.5 NON- CO-CHANNEL TEST

The UUT was investigated after radar was detected and confirmed that no co-channel operation with radars.



## 7 INFORMATION ON THE TESTING LABORATORIES

We, Bureau Veritas Consumer Products Services (H.K.) Ltd., Taoyuan Branch, were founded in 1988 to provide our best service in EMC, Radio, Telecom and Safety consultation. Our laboratories are accredited and approved according to ISO/IEC 17025.

If you have any comments, please feel free to contact us at the following:

**Linko EMC/RF Lab:**  
Tel: 886-2-26052180  
Fax: 886-2-26051924

**Hsin Chu EMC/RF Lab:**  
Tel: 886-3-5935343  
Fax: 886-3-5935342

**Hwa Ya EMC/RF/Safety Telecom Lab:**  
Tel: 886-3-3183232  
Fax: 886-3-3270892

**Email:** [service.adt@tw.bureauveritas.com](mailto:service.adt@tw.bureauveritas.com)

**Web Site:** [www.bureauveritas-adt.com](http://www.bureauveritas-adt.com)

The address and road map of all our labs can be found in our web site also.

---END---