



A D T

FCC Test Report

Report No.: RF130107C03C

FCC ID: A8J-ENS500

Test Model: ENS500EXT

Series Model: ENS500

Received Date: Jan. 14, 2016

Test Date: Feb. 02 ~ Feb. 23, 2016

Issued Date: Mar. 04, 2016

Applicant: EnGenius Technologies

Address: 1580 Scenic Avenue, Costa Mesa, CA92626

Issued By: Bureau Veritas Consumer Products Services (H.K.) Ltd., Taoyuan Branch

Lab Address: No. 47-2, 14th Ling, Chia Pau Vil., Lin Kou Dist., New Taipei City, Taiwan, R.O.C.

Test Location: No.19, Hwa Ya 2nd Rd., Wen Hwa Vil., Kwei Shan Dist., Taoyuan City 33383, TAIWAN (R.O.C.)



This report is for your exclusive use. Any copying or replication of this report to or for any other person or entity, or use of our name or trademark, is permitted only with our prior written permission. This report sets forth our findings solely with respect to the test samples identified herein. The results set forth in this report are not indicative or representative of the quality or characteristics of the lot from which a test sample was taken or any similar or identical product unless specifically and expressly noted. Our report includes all of the tests requested by you and the results thereof based upon the information that you provided to us. You have 60 days from date of issuance of this report to notify us of any material error or omission caused by our negligence, provided, however, that such notice shall be in writing and shall specifically address the issue you wish to raise. A failure to raise such issue within the prescribed time shall constitute your unqualified acceptance of the completeness of this report, the tests conducted and the correctness of the report contents. Unless specifically mentioned, the uncertainty of measurement has been explicitly taken into account to declare the compliance or non-compliance to the specification. The report must not be used by the client to claim product certification, approval, or endorsement by TAF or any government agencies.

Table of Contents

Release Control Record	4
1 Certificate of Conformity	5
2 Summary of Test Results	6
2.1 Measurement Uncertainty.....	6
2.2 Modification Record.....	6
3 General Information	7
3.1 General Description of EUT.....	7
3.2 Description of Test Modes.....	8
3.2.1 Test Mode Applicability and Tested Channel Detail.....	9
3.3 Duty Cycle of Test Signal.....	11
3.4 Description of Support Units.....	12
3.4.1 Configuration of System under Test.....	12
3.5 General Description of Applied Standards.....	12
4 Test Types and Results	13
4.1 Radiated Emission and Bandedge Measurement.....	13
4.1.1 Limits of Radiated Emission and Bandedge Measurement.....	13
4.1.2 Test Instruments.....	14
4.1.3 Test Procedures.....	15
4.1.4 Deviation from Test Standard.....	15
4.1.5 Test Set Up.....	16
4.1.6 EUT Operating Conditions.....	16
4.1.7 Test Results.....	17
4.2 Conducted Emission Measurement.....	35
4.2.1 Limits of Conducted Emission Measurement.....	35
4.2.2 Test Instruments.....	35
4.2.3 Test Procedures.....	36
4.2.4 Deviation from Test Standard.....	36
4.2.5 Test Setup.....	36
4.2.6 EUT Operating Conditions.....	36
4.2.7 Test Results.....	37
4.3 Transmit Power Measurement.....	41
4.3.1 Limits of Transmit Power Measurement.....	41
4.3.2 Test Setup.....	41
4.3.3 Test Instruments.....	41
4.3.4 Test Procedure.....	41
4.3.5 Deviation from Test Standard.....	41
4.3.6 EUT Operating Conditions.....	41
4.3.7 Test Result.....	42
4.4 Peak Power Spectral Density Measurement.....	47
4.4.1 Limits of Peak Power Spectral Density Measurement.....	47
4.4.2 Test Setup.....	47
4.4.3 Test Instruments.....	47
4.4.4 Test Procedures.....	48
4.4.5 Deviation from Test Standard.....	48
4.4.6 EUT Operating Conditions.....	48
4.4.7 Test Results.....	49
4.5 Frequency Stability.....	53
4.5.1 Limits of Frequency Stability Measurement.....	53
4.5.2 Test Setup.....	53
4.5.3 Test Instruments.....	53
4.5.4 Test Procedure.....	53
4.5.5 Deviation from Test Standard.....	53
4.5.6 EUT Operating Condition.....	53



4.5.7 Test Results	54
4.6 6dB Bandwidth Measurement.....	55
4.6.1 Limits of 6dB Bandwidth Measurement.....	55
4.6.2 Test Setup.....	55
4.6.3 Test Instruments	55
4.6.4 Test Procedure	55
4.6.5 Deviation from Test Standard	55
4.6.6 EUT Operating Condition	55
4.6.7 Test Results	56
5 Pictures of Test Arrangements.....	58
Appendix – Information on the Testing Laboratories	59



A D T

Release Control Record

Issue No.	Description	Date Issued
RF130107C03C	Original release	Mar. 04, 2016

1 Certificate of Conformity

Product: LONG RANGE WIRELESS 11N AP/CB

Brand: EnGenius

Test Model: ENS500EXT

Series Model: ENS500

Sample Status: Engineering Sample

Applicant: EnGenius Technologies

Test Date: Feb. 02 ~ Feb. 23, 2016

Standards: 47 CFR FCC Part 15, Subpart E (Section 15.407)
ANSI C63.10:2013

The above equipment has been tested by **Bureau Veritas Consumer Products Services (H.K.) Ltd., Taoyuan Branch**, and found compliance with the requirement of the above standards. The test record, data evaluation & Equipment Under Test (EUT) configurations represented herein are true and accurate accounts of the measurements of the sample's EMC characteristics under the conditions specified in this report.

Prepared by : Celine Chou , **Date:** Mar. 04, 2016
Celine Chou / Specialist

Approved by : Ken Liu , **Date:** Mar. 04, 2016
Ken Liu / Senior Manager

2 Summary of Test Results

47 CFR FCC Part 15, Subpart E (Section 15.407)			
FCC Clause	Test Item	Result	Remarks
15.207 15.407(b)(6)	AC Power Conducted Emissions	Pass	Meet the requirement of limit. Minimum passing margin is -6.78dB at 0.29063MHz.
15.407(b) (1/2/3/4/6)	Radiated Emissions & Band Edge Measurement	Pass	Meet the requirement of limit. Minimum passing margin is -1.0dB at 5714.90MHz, 5722.90MHz and 5700.00MHz.
15.407(a)(1/2 /3)	Max Average Transmit Power	Pass	Meet the requirement of limit.
15.407(a)(1/2 /3)	Peak Power Spectral Density	Pass	Meet the requirement of limit.
15.407(e)	6dB bandwidth	Pass	Meet the requirement of limit. (U-NII-3 Band only)
15.407(g)	Frequency Stability	Pass	Meet the requirement of limit.
15.203	Antenna Requirement	Pass	Antenna connector is RSMA not a standard connector.

2.1 Measurement Uncertainty

Where relevant, the following measurement uncertainty levels have been estimated for tests performed on the EUT as specified in CISPR 16-4-2:

Measurement	Frequency	Expanded Uncertainty (k=2) (±)
Conducted Emissions at mains ports	150kHz ~ 30MHz	2.44 dB
Radiated Emissions up to 1 GHz	30MHz ~ 200MHz	3.86 dB
	200MHz ~ 1000MHz	3.87 dB
Radiated Emissions above 1 GHz	1GHz ~ 18GHz	2.29 dB
	18GHz ~ 40GHz	2.29 dB

2.2 Modification Record

There were no modifications required for compliance.

3 General Information

3.1 General Description of EUT

Product	LONG RANGE WIRELESS 11N AP/CB
Brand	EnGenius
Test Model	ENS500EXT
Series Model	ENS500
Status of EUT	Engineering Sample
Power Supply Rating	24Vdc (POE)
Modulation Type	64QAM, 16QAM, QPSK, BPSK for OFDM
Modulation Technology	OFDM
Transfer Rate	802.11a: 54.0/ 48.0/ 36.0/ 24.0/ 18.0/ 12.0/ 9.0/ 6.0Mbps 802.11n: up to 300.0Mbps
Operating Frequency	5180 ~ 5240MHz, 5745 ~ 5825MHz
Number of Channel	5180 ~ 5240MHz: 4 for 802.11a, 802.11n (HT20) 2 for 802.11n (HT40) 5745 ~ 5825MHz: 5 for 802.11a, 802.11n (HT20) 2 for 802.11n (HT40)
Output Power	5180 ~ 5240MHz: 192.295mW 5745 ~ 5825MHz: 178.202mW
Antenna Type	Dipole antenna with 5dBi gain
Antenna Connector	RSMA
Accessory Device	POE
Data Cable Supplied	NA

Note:

- This report is prepared for FCC class II permissive change.
- This report is issued as a supplementary report to the original BV ADT report no.: RF130107C03. The differences compared with the original report are list as below. All test data had been re-tested.
 - Adding a POE.
 - Updating U-NII-3 band to new rules.
 - Changing EUT category from Outdoor Access Point to Indoor Access Point. (adding U-NII-1 band)
 - Changing EUT's product name.
- The following models are electrically identical, different model names are for marketing purpose.

Brand	Model
EnGenius	ENS500
EnGenius	ENS500EXT

* The model of the ENS500EXT was chosen for final test.

- The EUT incorporates a MIMO function. Physically, the EUT provides 2 completed transmitters and 2 receivers.

Modulation Mode	TX Function
802.11a	2TX
802.11n (HT20)	2TX
802.11n (HT40)	2TX

5. The EUT consumes power from the following POE. (The new POE is POE 2)

POE 1	
Brand:	EnGenius
Model:	EPE-1212
Input:	24Vdc, 0.6A
POE 1's Adapter	
Brand:	Powertron Electronics Corp.
Model:	PA1015-3HU
Input:	100-240Vdc, 50-60Hz, 0.4A
Output:	24Vdc, 0.6A, 14.4W Max
Power Line:	1.5m cable without core attached on adapter

POE 2	
Brand:	EnGenius
Model:	EPA-2406
Input:	100-240Vdc, 50-60Hz, 0.4A
Output:	24Vdc, 0.6A, 14.4W Max

3.2 Description of Test Modes

For 5180 ~ 5240MHz

4 channels are provided for 802.11a, 802.11n (HT20):

Channel	Frequency	Channel	Frequency
36	5180 MHz	44	5220 MHz
40	5200 MHz	48	5240 MHz

2 channels are provided for 802.11n (HT40):

Channel	Frequency	Channel	Frequency
38	5190 MHz	46	5230 MHz

For 5745 ~ 5825MHz:

5 channels are provided for 802.11a, 802.11n (HT20):

Channel	Frequency	Channel	Frequency
149	5745MHz	161	5805MHz
153	5765MHz	165	5825MHz
157	5785MHz		

2 channels are provided for 802.11n (HT40):

Channel	Frequency	Channel	Frequency
151	5755MHz	159	5795MHz

3.2.1 Test Mode Applicability and Tested Channel Detail

EUT CONFIGURE MODE	APPLICABLE TO				DESCRIPTION
	RE \geq 1G	RE $<$ 1G	PLC	APCM	
A	√	√	√	√	Power from POE 1
B	-	√	√	-	Power from POE 2

Where **RE \geq 1G**: Radiated Emission above 1GHz & Bandedge Measurement
RE $<$ 1G: Radiated Emission below 1GHz
PLC: Power Line Conducted Emission
APCM: Antenna Port Conducted Measurement

Note:

1. The EUT had been pre-tested on the positioned of each 3 axis. The worst case was found when positioned on **Z-plane**.
2. "-" means no effect.

Radiated Emission Test (Above 1GHz):

- Pre-Scan has been conducted to determine the worst-case mode from all possible combinations between available modulations, data rates and antenna ports (if EUT with antenna diversity architecture).
- Following channel(s) was (were) selected for the final test as listed below.

EUT CONFIGURE MODE	MODE	FREQ. BAND (MHz)	AVAILABLE CHANNEL	TESTED CHANNEL	MODULATION TECHNOLOGY	MODULATION TYPE	DATA RATE (Mbps)
A	802.11a	5180-5240	36 to 48	36, 40, 48	OFDM	BPSK	6.0
A	802.11n (HT20)		36 to 48	36, 40, 48	OFDM	BPSK	7.2
A	802.11n (HT40)		38 to 46	38, 46	OFDM	BPSK	15.0
A	802.11a	5745-5825	149 to 165	149, 157, 165	OFDM	BPSK	6.0
A	802.11n (HT20)		149 to 165	149, 157, 165	OFDM	BPSK	7.2
A	802.11n (HT40)		151 to 159	151, 159	OFDM	BPSK	15.0

Radiated Emission Test (Below 1GHz):

- Pre-Scan has been conducted to determine the worst-case mode from all possible combinations between available modulations, data rates and antenna ports (if EUT with antenna diversity architecture).
- Following channel(s) was (were) selected for the final test as listed below.

EUT CONFIGURE MODE	MODE	FREQ. BAND (MHz)	AVAILABLE CHANNEL	TESTED CHANNEL	MODULATION TECHNOLOGY	MODULATION TYPE	DATA RATE (Mbps)
A, B	802.11a	5180-5240	36 to 48	36	OFDM	BPSK	6.0
	802.11a	5745-5825	149 to 165		OFDM	BPSK	6.0

Power Line Conducted Emission Test:

- Pre-Scan has been conducted to determine the worst-case mode from all possible combinations between available modulations, data rates and antenna ports (if EUT with antenna diversity architecture).
- Following channel(s) was (were) selected for the final test as listed below.

EUT CONFIGURE MODE	MODE	FREQ. BAND (MHz)	AVAILABLE CHANNEL	TESTED CHANNEL	MODULATION TECHNOLOGY	MODULATION TYPE	DATA RATE (Mbps)
A, B	802.11a	5180-5240	36 to 48	36	OFDM	BPSK	6.0
	802.11a	5745-5825	149 to 165		OFDM	BPSK	6.0

Antenna Port Conducted Measurement:

- This item includes all test value of each mode, but only includes spectrum plot of worst value of each mode.
- Pre-Scan has been conducted to determine the worst-case mode from all possible combinations between available modulations, data rates and antenna ports (if EUT with antenna diversity architecture).
- Following channel(s) was (were) selected for the final test as listed below.

EUT CONFIGURE MODE	MODE	FREQ. BAND (MHz)	AVAILABLE CHANNEL	TESTED CHANNEL	MODULATION TECHNOLOGY	MODULATION TYPE	DATA RATE (Mbps)
A	802.11a	5180-5240	36 to 48	36, 40, 48	OFDM	BPSK	6.0
A	802.11n (HT20)		36 to 48	36, 40, 48	OFDM	BPSK	7.2
A	802.11n (HT40)		38 to 46	38, 46	OFDM	BPSK	15.0
A	802.11a	5745-5825	149 to 165	149, 157, 165	OFDM	BPSK	6.0
A	802.11n (HT20)		149 to 165	149, 157, 165	OFDM	BPSK	7.2
A	802.11n (HT40)		151 to 159	151, 159	OFDM	BPSK	15.0

Test Condition:

APPLICABLE TO	ENVIRONMENTAL CONDITIONS	INPUT POWER	TESTED BY
RE \geq 1G	16deg. C, 70%RH	24Vdc	Nick Hsu
RE $<$ 1G	21deg. C, 70%RH	24Vdc	Jones Chang
PLC	16deg. C, 70%RH	24Vdc	Nick Hsu
APCM	25deg. C, 60%RH	24Vdc	Antony Lee

3.3 Duty Cycle of Test Signal

802.11a: Duty cycle of test signal is > 98 %, duty factor is not required.

802.11n (HT20), 802.11n (HT40): Duty cycle of test signal is < 98 %, duty factor is required.

802.11n (HT20): Duty cycle = $1.250/1.325 = 0.943$, Duty factor = $10 * \log(1/0.943) = 0.25$

802.11n (HT40): Duty cycle = $0.575/0.662 = 0.869$, Duty factor = $10 * \log(1/0.869) = 0.61$



3.4 Description of Support Units

The EUT has been tested as an independent unit together with other necessary accessories or support units. The following support units or accessories were used to form a representative test configuration during the tests.

ID	Product	Brand	Model No.	Serial No.	FCC ID	Remarks
A.	Notebook	DELL	E5410	1HC2XM1	FCC DoC Approved	-

Note:

1. All power cords of the above support units are non-shielded (1.8m).
2. Items A acted as communication partners to transfer data.

ID	Descriptions	Qty.	Length (m)	Shielding (Yes/No)	Cores (Qty.)	Remarks
1.	LAN cable	1	10	N	0	-
2.	LAN cable	1	1.8	N	0	-

3.4.1 Configuration of System under Test

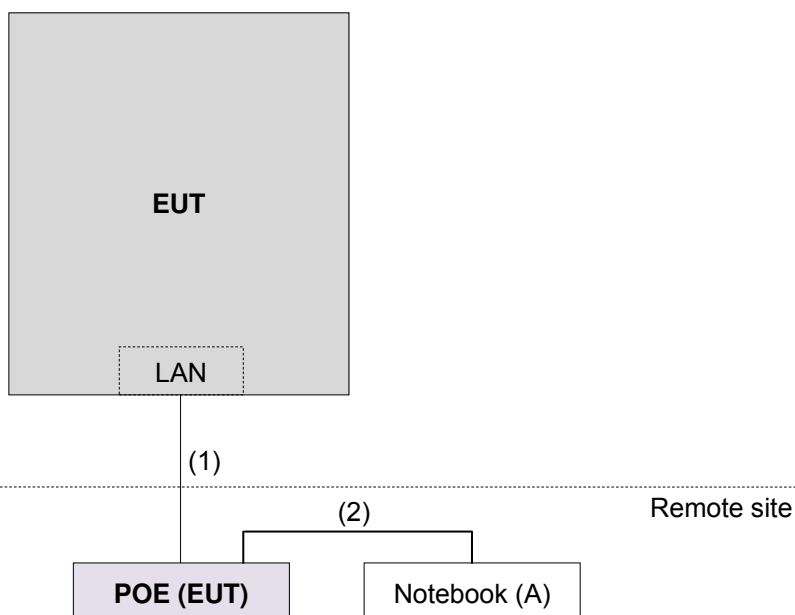

3.5 General Description of Applied Standards

The EUT is a RF Product. According to the specifications of the manufacturer, it must comply with the requirements of the following standards:

FCC Part 15, Subpart E (15.407)

789033 D02 General UNII Test Procedures New Rules v01r01

662911 D01 Multiple Transmitter Output v02r01

ANSI C63.10-2013

All test items have been performed and recorded as per the above standards.

Note: The EUT is also considered as a kind of computer peripheral, because the connection to computer is necessary for typical use. It has been verified to comply with the requirements of FCC Part 15, Subpart B, Class B (DoC). The test report has been issued separately.

4 Test Types and Results

4.1 Radiated Emission and Bandedge Measurement

4.1.1 Limits of Radiated Emission and Bandedge Measurement

Radiated emissions which fall in the restricted bands must comply with the radiated emission limits specified as below table.

Frequencies (MHz)	Field Strength (microvolts/meter)	Measurement Distance (meters)
0.009 ~ 0.490	2400/F(kHz)	300
0.490 ~ 1.705	24000/F(kHz)	30
1.705 ~ 30.0	30	30
30 ~ 88	100	3
88 ~ 216	150	3
216 ~ 960	200	3
Above 960	500	3

NOTE:

1. The lower limit shall apply at the transition frequencies.
2. Emission level (dBuV/m) = 20 log Emission level (uV/m).
3. For frequencies above 1000MHz, the field strength limits are based on average detector, however, the peak field strength of any emission shall not exceed the maximum permitted average limits, specified above by more than 20dB under any condition of modulation.

LIMITS OF UNWANTED EMISSION OUT OF THE RESTRICTED BANDS

APPLICABLE TO	LIMIT	
789033 D02 General UNII Test Procedures New Rules v01r01	FIELD STRENGTH AT 3m	
	PK:74 (dBµV/m)	AV:54 (dBµV/m)
APPLICABLE TO	EIRP LIMIT	EQUIVALENT FIELD STRENGTH AT 3m
15.407(b)(1)	PK:-27 (dBm/MHz)	PK:68.2 (dBµV/m)
15.407(b)(2)		
15.407(b)(3)		
15.407(b)(4)	PK:-27 (dBm/MHz) ^{*1} PK:-17 (dBm/MHz) ^{*2}	PK: 68.2 (dBµV/m) ^{*1} PK: 78.2 (dBµV/m) ^{*2}

NOTE: ^{*1} beyond 10MHz of the band edge ^{*2} within 10 MHz of band edge

The following formula is used to convert the equipment isotropic radiated power (eirp) to field strength:

$$E = \frac{1000000 \sqrt{30P}}{3} \mu\text{V/m, where P is the eirp (Watts).}$$

4.1.2 Test Instruments

Description & Manufacturer	Model No.	Serial No.	Cal. Date	Cal. Due
Test Receiver ROHDE & SCHWARZ	ESIB7	100187	Apr. 10, 2015	Apr. 09, 2016
Spectrum Analyzer ROHDE & SCHWARZ	FSP40	100041	Sep. 02, 2015	Sep. 01, 2016
BILOG Antenna SCHWARZBECK	VULB9168	9168-151	Jan. 07, 2016	Jan. 06, 2017
HORN Antenna SCHWARZBECK	9120D	209	Jan. 20, 2016	Jan. 19, 2017
HORN Antenna SCHWARZBECK	BBHA 9170	BBHA9170241	Jan. 18, 2016	Jan. 17, 2017
Preamplifier Agilent	8447D	2944A10738	Oct.18, 2015	Oct. 17, 2016
Preamplifier Agilent	8449B	3008A01964	Aug. 22, 2015	Aug. 21, 2016
RF signal cable HUBER+SUHNER	SUCOFLEX 104	Cable-CH3-03 (214378)	Aug. 22, 2015	Aug. 21, 2016
RF signal cable HUBER+SUHNER	SUCOFLEX 106	Cable-CH3-03 (309224+12738)	Aug. 22, 2015	Aug. 21, 2016
Software BV ADT	ADT_Radiated_ V7.6.15.9.4	NA	NA	NA
Antenna Tower inn-co GmbH	MA 4000	013303	NA	NA
Antenna Tower Controller BV ADT	AT100	AT93021702	NA	NA
Turn Table BV ADT	TT100	TT93021702	NA	NA
Turn Table Controller BV ADT	SC100	SC93021702	NA	NA
26GHz ~ 40GHz Amplifier	EM26400	815221	Oct. 18, 2015	Oct. 17, 2016
High Speed Peak Power Meter	ML2495A	0824011	Jul. 09, 2015	Jul. 08, 2016
Power Sensor	MA2411B	0738171	Jul. 09, 2015	Jul. 08, 2016
WIT Standard Temperature And Humidity Chamber	TH-4S-C	W981030	Jun. 08, 2015	Jun. 07, 2016

- Note: 1. The calibration interval of the above test instruments is 12 months and the calibrations are traceable to NML/ROC and NIST/USA.
 2. The test was performed in HwaYa Chamber 3.
 3. The horn antenna and preamplifier (model: 8449B) are used only for the measurement of emission frequency above 1GHz if tested.
 4. The FCC Site Registration No. is 988962.
 5. The IC Site Registration No. is IC 7450F-3.

4.1.3 Test Procedures

- a. The EUT was placed on the top of a rotating table 0.8 meters (for below 1GHz) / 1.5 meters (for above 1GHz) above the ground at 3 meter chamber room for test. The table was rotated 360 degrees to determine the position of the highest radiation.
- b. The EUT was set 3 meters away from the interference-receiving antenna, which was mounted on the top of a variable-height antenna tower.
- c. The height of antenna is varied from one meter to four meters above the ground to determine the maximum value of the field strength. Both horizontal and vertical polarizations of the antenna are set to make the measurement.
- d. For each suspected emission, the EUT was arranged to its worst case and then the antenna was tuned to heights from 1 meter to 4 meters and the rotatable table was turned from 0 degrees to 360 degrees to find the maximum reading.
- e. The test-receiver system was set to quasi-peak detect function and specified bandwidth with maximum hold mode when the test frequency is below 1 GHz.
- f. The test-receiver system was set to peak and average detect function and specified bandwidth with maximum hold mode when the test frequency is above 1 GHz. If the peak reading value also meets average limit, measurement with the average detector is unnecessary.

Note:

1. The resolution bandwidth and video bandwidth of test receiver/spectrum analyzer is 120kHz for Quasi-peak detection (QP) at frequency below 1GHz.
2. The resolution bandwidth of test receiver/spectrum analyzer is 1 MHz and the video bandwidth is 3 MHz for Peak detection (PK) at frequency above 1GHz.
3. The resolution bandwidth of test receiver/spectrum analyzer is 1MHz and the video bandwidth is 3MHz for RMS Average (Duty cycle < 98%) for Average detection (AV) at frequency above 1GHz, then the measurement results was added to a correction factor ($10 \log(1/\text{duty cycle})$).
4. The resolution bandwidth of test receiver/spectrum analyzer is 1MHz and the video bandwidth is 10Hz (Duty cycle $\geq 98\%$) for Average detection (AV) at frequency above 1GHz.
5. All modes of operation were investigated and the worst-case emissions are reported.

4.1.4 Deviation from Test Standard

No deviation.

4.1.5 Test Set Up

<Frequency Range below 1GHz>

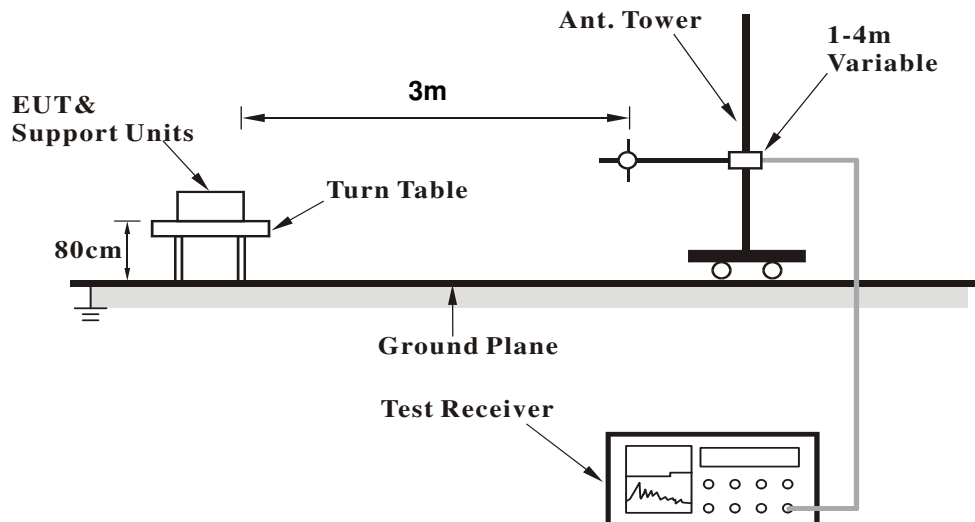

<Frequency Range above 1GHz>

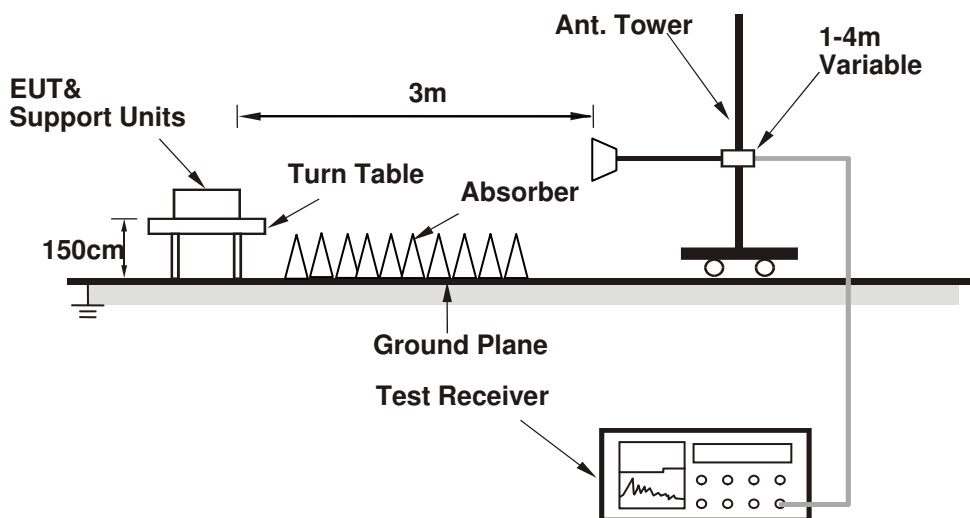

For the actual test configuration, please refer to the attached file (Test Setup Photo)

4.1.6 EUT Operating Conditions

- Placed the EUT on the testing table.
- Prepared notebook to act as communication partner and placed it outside of testing area.
- The communication partner connected with EUT via a RJ45 cable and ran a test program (provided by manufacturer) to enable EUT under transmission condition continuously at specific channel frequency.
- The communication partner sent data to EUT by command "PING".

4.1.7 Test Results

Above 1GHz Worst-Case Data:

802.11a

CHANNEL	TX Channel 36	DETECTOR	Peak (PK)
FREQUENCY RANGE	1GHz ~ 40GHz	FUNCTION	Average (AV)

ANTENNA POLARITY & TEST DISTANCE: HORIZONTAL AT 3 M

NO.	FREQ. (MHz)	EMISSION LEVEL (dBuV/m)	LIMIT (dBuV/m)	MARGIN (dB)	ANTENNA HEIGHT (m)	TABLE ANGLE (Degree)	RAW VALUE (dBuV)	CORRECTION FACTOR (dB/m)
1	5150.00	57.3 PK	74.0	-16.7	1.91 H	323	51.30	6.00
2	5150.00	44.5 AV	54.0	-9.5	1.91 H	323	38.50	6.00
3	*5180.00	99.9 PK			1.00 H	14	60.50	39.40
4	*5180.00	90.5 AV			1.00 H	14	51.10	39.40
5	#10360.00	59.4 PK	74.0	-14.6	1.25 H	256	41.60	17.80
6	#10360.00	46.6 AV	54.0	-7.4	1.25 H	256	28.80	17.80

ANTENNA POLARITY & TEST DISTANCE: VERTICAL AT 3 M

NO.	FREQ. (MHz)	EMISSION LEVEL (dBuV/m)	LIMIT (dBuV/m)	MARGIN (dB)	ANTENNA HEIGHT (m)	TABLE ANGLE (Degree)	RAW VALUE (dBuV)	CORRECTION FACTOR (dB/m)
1	5150.00	67.6 PK	74.0	-6.4	1.43 V	335	61.60	6.00
2	5150.00	52.2 AV	54.0	-1.8	1.43 V	335	46.20	6.00
3	*5180.00	115.6 PK			1.54 V	140	76.20	39.40
4	*5180.00	105.7 AV			1.54 V	140	66.30	39.40
5	#10360.00	58.4 PK	74.0	-15.6	2.62 V	0	40.60	17.80
6	#10360.00	46.9 AV	54.0	-7.1	2.62 V	0	29.10	17.80

Remarks:

1. Emission Level(dBuV/m) = Raw Value(dBuV) + Correction Factor(dB/m)
2. Correction Factor(dB/m) = Antenna Factor(dB/m) + Cable Factor(dB)
3. The other emission levels were very low against the limit.
4. Margin value = Emission Level – Limit value
5. " * ": Fundamental frequency.
6. " # ": The radiated frequency is out of the restricted band.

CHANNEL	TX Channel 40	DETECTOR FUNCTION	Peak (PK)
FREQUENCY RANGE	1GHz ~ 40GHz		Average (AV)

ANTENNA POLARITY & TEST DISTANCE: HORIZONTAL AT 3 M								
NO.	FREQ. (MHz)	EMISSION LEVEL (dBuV/m)	LIMIT (dBuV/m)	MARGIN (dB)	ANTENNA HEIGHT (m)	TABLE ANGLE (Degree)	RAW VALUE (dBuV)	CORRECTION FACTOR (dB/m)
1	*5200.00	100.8 PK			1.00 H	14	61.30	39.50
2	*5200.00	91.1 AV			1.00 H	14	51.60	39.50
3	5456.00	57.8 PK	74.0	-16.2	1.06 H	311	50.90	6.90
4	5456.00	45.4 AV	54.0	-8.6	1.06 H	311	38.50	6.90
5	#10400.00	58.5 PK	74.0	-15.5	1.33 H	221	40.80	17.70
6	#10400.00	45.9 AV	54.0	-8.1	1.33 H	221	28.20	17.70

ANTENNA POLARITY & TEST DISTANCE: VERTICAL AT 3 M								
NO.	FREQ. (MHz)	EMISSION LEVEL (dBuV/m)	LIMIT (dBuV/m)	MARGIN (dB)	ANTENNA HEIGHT (m)	TABLE ANGLE (Degree)	RAW VALUE (dBuV)	CORRECTION FACTOR (dB/m)
1	5120.00	62.0 PK	74.0	-12.0	1.42 V	17	56.00	6.00
2	5120.00	51.1 AV	54.0	-2.9	1.42 V	17	45.10	6.00
3	*5200.00	117.4 PK			1.56 V	20	77.90	39.50
4	*5200.00	107.8 AV			1.56 V	20	68.30	39.50
5	5456.00	63.4 PK	74.0	-10.6	1.85 V	82	56.50	6.90
6	5456.00	52.9 AV	54.0	-1.1	1.85 V	82	46.00	6.90
7	#10400.00	59.3 PK	74.0	-14.7	1.84 V	241	41.60	17.70
8	#10400.00	46.3 AV	54.0	-7.7	1.84 V	241	28.60	17.70

Remarks:

1. Emission Level(dBuV/m) = Raw Value(dBuV) + Correction Factor(dB/m)
2. Correction Factor(dB/m) = Antenna Factor(dB/m) + Cable Factor(dB)
3. The other emission levels were very low against the limit.
4. Margin value = Emission Level – Limit value
5. " * ": Fundamental frequency.
6. " # ": The radiated frequency is out of the restricted band.

CHANNEL	TX Channel 48	DETECTOR FUNCTION	Peak (PK)
FREQUENCY RANGE	1GHz ~ 40GHz		Average (AV)

ANTENNA POLARITY & TEST DISTANCE: HORIZONTAL AT 3 M

NO.	FREQ. (MHz)	EMISSION LEVEL (dBuV/m)	LIMIT (dBuV/m)	MARGIN (dB)	ANTENNA HEIGHT (m)	TABLE ANGLE (Degree)	RAW VALUE (dBuV)	CORRECTION FACTOR (dB/m)
1	*5240.00	104.1 PK			1.01 H	354	64.50	39.60
2	*5240.00	93.8 AV			1.01 H	354	54.20	39.60
3	5456.00	58.2 PK	74.0	-15.8	1.18 H	324	51.30	6.90
4	5456.00	45.6 AV	54.0	-8.4	1.18 H	324	38.70	6.90
5	#10480.00	60.7 PK	74.0	-13.3	1.38 H	264	42.00	18.70
6	#10480.00	47.0 AV	54.0	-7.0	1.38 H	264	28.30	18.70

ANTENNA POLARITY & TEST DISTANCE: VERTICAL AT 3 M

NO.	FREQ. (MHz)	EMISSION LEVEL (dBuV/m)	LIMIT (dBuV/m)	MARGIN (dB)	ANTENNA HEIGHT (m)	TABLE ANGLE (Degree)	RAW VALUE (dBuV)	CORRECTION FACTOR (dB/m)
1	*5240.00	119.3 PK			1.60 V	139	79.70	39.60
2	*5240.00	109.7 AV			1.60 V	139	70.10	39.60
3	5456.00	62.8 PK	74.0	-11.2	1.62 V	3	55.90	6.90
4	5456.00	52.8 AV	54.0	-1.2	1.62 V	3	45.90	6.90
5	#10480.00	63.5 PK	74.0	-10.5	1.69 V	205	44.80	18.70
6	#10480.00	48.8 AV	54.0	-5.2	1.69 V	205	30.10	18.70

Remarks:

1. Emission Level(dBuV/m) = Raw Value(dBuV) + Correction Factor(dB/m)
2. Correction Factor(dB/m) = Antenna Factor(dB/m) + Cable Factor(dB)
3. The other emission levels were very low against the limit.
4. Margin value = Emission Level – Limit value
5. " * ": Fundamental frequency.
6. " # ": The radiated frequency is out of the restricted band.

CHANNEL	TX Channel 149	DETECTOR FUNCTION	Peak (PK)
FREQUENCY RANGE	1GHz ~ 40GHz		Average (AV)

ANTENNA POLARITY & TEST DISTANCE: HORIZONTAL AT 3 M

NO.	FREQ. (MHz)	EMISSION LEVEL (dBuV/m)	LIMIT (dBuV/m)	MARGIN (dB)	ANTENNA HEIGHT (m)	TABLE ANGLE (Degree)	RAW VALUE (dBuV)	CORRECTION FACTOR (dB/m)
1	#5714.90	57.9 PK	74.0	-16.1	1.99 H	208	50.50	7.40
2	#5714.90	46.7 AV	54.0	-7.3	1.99 H	208	39.30	7.40
3	#5722.00	67.1 PK	78.2	-11.1	2.78 H	357	59.70	7.40
4	#5725.00	53.4 PK	78.2	-24.8	2.78 H	357	46.00	7.40
5	*5745.00	104.1 PK			2.73 H	11	63.60	40.50
6	*5745.00	94.6 AV			2.73 H	11	54.10	40.50
7	11490.00	61.1 PK	74.0	-12.9	1.65 H	35	42.40	18.70
8	11490.00	48.2 AV	54.0	-5.8	1.65 H	35	29.50	18.70

ANTENNA POLARITY & TEST DISTANCE: VERTICAL AT 3 M

NO.	FREQ. (MHz)	EMISSION LEVEL (dBuV/m)	LIMIT (dBuV/m)	MARGIN (dB)	ANTENNA HEIGHT (m)	TABLE ANGLE (Degree)	RAW VALUE (dBuV)	CORRECTION FACTOR (dB/m)
1	#5714.90	66.3 PK	74.0	-7.7	2.26 V	337	58.90	7.40
2	#5714.90	52.0 AV	54.0	-2.0	2.26 V	337	44.60	7.40
3	#5722.00	76.4 PK	78.2	-1.8	2.18 V	121	69.00	7.40
4	#5725.00	63.9 PK	78.2	-14.3	2.13 V	121	56.50	7.40
5	*5745.00	113.8 PK			2.21 V	30	73.30	40.50
6	*5745.00	104.9 AV			2.21 V	30	64.40	40.50
7	11490.00	61.5 PK	74.0	-12.5	1.77 V	279	42.80	18.70
8	11490.00	48.5 AV	54.0	-5.5	1.77 V	279	29.80	18.70

Remarks:

1. Emission Level(dBuV/m) = Raw Value(dBuV) + Correction Factor(dB/m)
2. Correction Factor(dB/m) = Antenna Factor(dB/m) + Cable Factor(dB)
3. The other emission levels were very low against the limit.
4. Margin value = Emission Level – Limit value
5. " * ": Fundamental frequency.
6. " # ": The radiated frequency is out of the restricted band.

CHANNEL	TX Channel 157	DETECTOR FUNCTION	Peak (PK)
FREQUENCY RANGE	1GHz ~ 40GHz		Average (AV)

ANTENNA POLARITY & TEST DISTANCE: HORIZONTAL AT 3 M								
NO.	FREQ. (MHz)	EMISSION LEVEL (dBuV/m)	LIMIT (dBuV/m)	MARGIN (dB)	ANTENNA HEIGHT (m)	TABLE ANGLE (Degree)	RAW VALUE (dBuV)	CORRECTION FACTOR (dB/m)
1	5456.00	58.3 PK	74.0	-15.7	2.32 H	195	51.40	6.90
2	5456.00	45.2 AV	54.0	-8.8	2.32 H	195	38.30	6.90
3	#5520.00	57.7 PK	68.2	-10.5	2.38 H	26	50.70	7.00
4	#5710.00	60.5 PK	74.0	-13.5	2.30 H	43	53.10	7.40
5	#5710.00	47.3 AV	54.0	-6.7	2.30 H	43	39.90	7.40
6	*5785.00	104.6 PK			2.44 H	5	64.00	40.60
7	*5785.00	94.4 AV			2.44 H	5	53.80	40.60
8	11570.00	59.6 PK	74.0	-14.4	1.68 H	90	40.90	18.70
9	11570.00	47.5 AV	54.0	-6.5	1.68 H	90	28.80	18.70

ANTENNA POLARITY & TEST DISTANCE: VERTICAL AT 3 M								
NO.	FREQ. (MHz)	EMISSION LEVEL (dBuV/m)	LIMIT (dBuV/m)	MARGIN (dB)	ANTENNA HEIGHT (m)	TABLE ANGLE (Degree)	RAW VALUE (dBuV)	CORRECTION FACTOR (dB/m)
1	5456.00	65.2 PK	74.0	-8.8	1.66 V	152	58.30	6.90
2	5456.00	52.8 AV	54.0	-1.2	1.66 V	152	45.90	6.90
3	#5520.00	65.4 PK	68.2	-2.8	1.88 V	0	58.40	7.00
4	#5710.00	66.1 PK	74.0	-7.9	2.15 V	174	58.70	7.40
5	#5710.00	51.4 AV	54.0	-2.6	2.15 V	174	44.00	7.40
6	*5785.00	117.0 PK			2.27 V	18	76.40	40.60
7	*5785.00	107.1 AV			2.27 V	18	66.50	40.60
8	11570.00	61.1 PK	74.0	-12.9	2.20 V	212	42.40	18.70
9	11570.00	48.3 AV	54.0	-5.7	2.20 V	212	29.60	18.70

Remarks:

1. Emission Level(dBuV/m) = Raw Value(dBuV) + Correction Factor(dB/m)
2. Correction Factor(dB/m) = Antenna Factor(dB/m) + Cable Factor(dB)
3. The other emission levels were very low against the limit.
4. Margin value = Emission Level – Limit value
5. " * ": Fundamental frequency.

CHANNEL	TX Channel 165	DETECTOR FUNCTION	Peak (PK)
FREQUENCY RANGE	1GHz ~ 40GHz		Average (AV)

ANTENNA POLARITY & TEST DISTANCE: HORIZONTAL AT 3 M

NO.	FREQ. (MHz)	EMISSION LEVEL (dBuV/m)	LIMIT (dBuV/m)	MARGIN (dB)	ANTENNA HEIGHT (m)	TABLE ANGLE (Degree)	RAW VALUE (dBuV)	CORRECTION FACTOR (dB/m)
1	5456.00	57.9 PK	74.0	-16.1	1.54 H	87	51.00	6.90
2	5456.00	45.3 AV	54.0	-8.7	1.54 H	87	38.40	6.90
3	*5825.00	102.4 PK			1.00 H	169	61.80	40.60
4	*5825.00	92.4 AV			1.00 H	169	51.80	40.60
5	#5850.00	46.0 PK	78.2	-32.2	1.15 H	169	38.40	7.60
6	#5852.10	58.7 PK	78.2	-19.5	1.21 H	167	51.00	7.70
7	#5860.10	58.9 PK	74.0	-15.1	1.29 H	150	51.20	7.70
8	#5860.10	45.7 AV	54.0	-8.3	1.29 H	150	38.00	7.70
9	11650.00	60.4 PK	74.0	-13.6	1.38 H	35	41.20	19.20
10	11650.00	47.6 AV	54.0	-6.4	1.38 H	35	28.40	19.20

ANTENNA POLARITY & TEST DISTANCE: VERTICAL AT 3 M

NO.	FREQ. (MHz)	EMISSION LEVEL (dBuV/m)	LIMIT (dBuV/m)	MARGIN (dB)	ANTENNA HEIGHT (m)	TABLE ANGLE (Degree)	RAW VALUE (dBuV)	CORRECTION FACTOR (dB/m)
1	5456.00	63.7 PK	74.0	-10.3	1.85 V	74	56.80	6.90
2	5456.00	52.2 AV	54.0	-1.8	1.85 V	74	45.30	6.90
3	*5825.00	114.8 PK			3.24 V	178	74.20	40.60
4	*5825.00	105.0 AV			3.24 V	178	64.40	40.60
5	#5850.00	62.2 PK	78.2	-16.0	2.93 V	264	54.60	7.60
6	#5852.00	72.6 PK	78.2	-5.6	2.93 V	264	64.90	7.70
7	#5861.00	67.0 PK	74.0	-7.0	2.93 V	4	59.30	7.70
8	#5861.00	50.7 AV	54.0	-3.3	2.93 V	4	43.00	7.70
9	11650.00	60.9 PK	74.0	-13.1	2.23 V	123	41.70	19.20
10	11650.00	48.2 AV	54.0	-5.8	2.23 V	123	29.00	19.20

Remarks:

1. Emission Level(dBuV/m) = Raw Value(dBuV) + Correction Factor(dB/m)
2. Correction Factor(dB/m) = Antenna Factor(dB/m) + Cable Factor(dB)
3. The other emission levels were very low against the limit.
4. Margin value = Emission Level – Limit value
5. " * ": Fundamental frequency.
6. " # ": The radiated frequency is out of the restricted band.

802.11n (HT20)

CHANNEL	TX Channel 36	DETECTOR FUNCTION	Peak (PK)
FREQUENCY RANGE	1GHz ~ 40GHz		Average (AV)

ANTENNA POLARITY & TEST DISTANCE: HORIZONTAL AT 3 M

NO.	FREQ. (MHz)	EMISSION LEVEL (dBuV/m)	LIMIT (dBuV/m)	MARGIN (dB)	ANTENNA HEIGHT (m)	TABLE ANGLE (Degree)	RAW VALUE (dBuV)	CORRECTION FACTOR (dB/m)
1	5150.00	56.4 PK	74.0	-17.6	1.22 H	333	50.40	6.00
2	5150.00	44.0 AV	54.0	-10.0	1.22 H	333	38.00	6.00
3	*5180.00	99.2 PK			1.01 H	4	59.80	39.40
4	*5180.00	89.9 AV			1.01 H	4	50.50	39.40
5	#10360.00	59.5 PK	74.0	-14.5	1.30 H	224	41.70	17.80
6	#10360.00	46.1 AV	54.0	-7.9	1.30 H	224	28.30	17.80

ANTENNA POLARITY & TEST DISTANCE: VERTICAL AT 3 M

NO.	FREQ. (MHz)	EMISSION LEVEL (dBuV/m)	LIMIT (dBuV/m)	MARGIN (dB)	ANTENNA HEIGHT (m)	TABLE ANGLE (Degree)	RAW VALUE (dBuV)	CORRECTION FACTOR (dB/m)
1	5150.00	67.9 PK	74.0	-6.1	1.37 V	210	61.90	6.00
2	5150.00	52.5 AV	54.0	-1.5	1.37 V	210	46.50	6.00
3	*5180.00	117.2 PK			1.54 V	327	77.80	39.40
4	*5180.00	106.6 AV			1.54 V	327	67.20	39.40
5	#10360.00	58.9 PK	74.0	-15.1	1.18 V	84	41.10	17.80
6	#10360.00	46.4 AV	54.0	-7.6	1.18 V	84	28.60	17.80

Remarks:

1. Emission Level(dBuV/m) = Raw Value(dBuV) + Correction Factor(dB/m)
2. Correction Factor(dB/m) = Antenna Factor(dB/m) + Cable Factor(dB)
3. The other emission levels were very low against the limit.
4. Margin value = Emission Level – Limit value
5. " * ": Fundamental frequency.
6. " # ": The radiated frequency is out of the restricted band.

CHANNEL	TX Channel 40	DETECTOR FUNCTION	Peak (PK)
FREQUENCY RANGE	1GHz ~ 40GHz		Average (AV)

ANTENNA POLARITY & TEST DISTANCE: HORIZONTAL AT 3 M

NO.	FREQ. (MHz)	EMISSION LEVEL (dBuV/m)	LIMIT (dBuV/m)	MARGIN (dB)	ANTENNA HEIGHT (m)	TABLE ANGLE (Degree)	RAW VALUE (dBuV)	CORRECTION FACTOR (dB/m)
1	*5200.00	100.9 PK			1.00 H	15	61.40	39.50
2	*5200.00	91.3 AV			1.00 H	15	51.80	39.50
3	5456.00	58.2 PK	74.0	-15.8	1.31 H	346	51.30	6.90
4	5456.00	45.5 AV	54.0	-8.5	1.31 H	346	38.60	6.90
5	#10400.00	58.8 PK	74.0	-15.2	1.42 H	284	41.10	17.70
6	#10400.00	46.3 AV	54.0	-7.7	1.42 H	284	28.60	17.70

ANTENNA POLARITY & TEST DISTANCE: VERTICAL AT 3 M

NO.	FREQ. (MHz)	EMISSION LEVEL (dBuV/m)	LIMIT (dBuV/m)	MARGIN (dB)	ANTENNA HEIGHT (m)	TABLE ANGLE (Degree)	RAW VALUE (dBuV)	CORRECTION FACTOR (dB/m)
1	*5200.00	118.5 PK			1.61 V	174	79.00	39.50
2	*5200.00	108.6 AV			1.61 V	174	69.10	39.50
3	5456.00	63.2 PK	74.0	-10.8	1.56 V	70	56.30	6.90
4	5456.00	52.6 AV	54.0	-1.4	1.56 V	70	45.70	6.90
5	#10400.00	58.5 PK	74.0	-15.5	1.44 V	71	40.80	17.70
6	#10400.00	46.5 AV	54.0	-7.5	1.44 V	71	28.80	17.70

Remarks:

1. Emission Level(dBuV/m) = Raw Value(dBuV) + Correction Factor(dB/m)
2. Correction Factor(dB/m) = Antenna Factor(dB/m) + Cable Factor(dB)
3. The other emission levels were very low against the limit.
4. Margin value = Emission Level – Limit value
5. " * ": Fundamental frequency.
6. " # ": The radiated frequency is out of the restricted band.

CHANNEL	TX Channel 48	DETECTOR FUNCTION	Peak (PK)
FREQUENCY RANGE	1GHz ~ 40GHz		Average (AV)

ANTENNA POLARITY & TEST DISTANCE: HORIZONTAL AT 3 M

NO.	FREQ. (MHz)	EMISSION LEVEL (dBuV/m)	LIMIT (dBuV/m)	MARGIN (dB)	ANTENNA HEIGHT (m)	TABLE ANGLE (Degree)	RAW VALUE (dBuV)	CORRECTION FACTOR (dB/m)
1	*5240.00	103.8 PK			1.02 H	0	64.20	39.60
2	*5240.00	93.9 AV			1.02 H	0	54.30	39.60
3	5456.00	57.8 PK	74.0	-16.2	1.17 H	336	50.90	6.90
4	5456.00	45.6 AV	54.0	-8.4	1.17 H	336	38.70	6.90
5	#10480.00	59.2 PK	74.0	-14.8	1.21 H	218	40.50	18.70
6	#10480.00	46.7 AV	54.0	-7.3	1.21 H	218	28.00	18.70

ANTENNA POLARITY & TEST DISTANCE: VERTICAL AT 3 M

NO.	FREQ. (MHz)	EMISSION LEVEL (dBuV/m)	LIMIT (dBuV/m)	MARGIN (dB)	ANTENNA HEIGHT (m)	TABLE ANGLE (Degree)	RAW VALUE (dBuV)	CORRECTION FACTOR (dB/m)
1	*5240.00	118.7 PK			1.57 V	124	79.10	39.60
2	*5240.00	108.3 AV			1.57 V	124	68.70	39.60
3	5456.00	63.7 PK	74.0	-10.3	1.62 V	74	56.80	6.90
4	5456.00	52.6 AV	54.0	-1.4	1.62 V	74	45.70	6.90
5	#10480.00	60.1 PK	74.0	-13.9	1.18 V	111	41.40	18.70
6	#10480.00	48.0 AV	54.0	-6.0	1.18 V	111	29.30	18.70

Remarks:

1. Emission Level(dBuV/m) = Raw Value(dBuV) + Correction Factor(dB/m)
2. Correction Factor(dB/m) = Antenna Factor(dB/m) + Cable Factor(dB)
3. The other emission levels were very low against the limit.
4. Margin value = Emission Level – Limit value
5. " * ": Fundamental frequency.
6. " # ": The radiated frequency is out of the restricted band.

CHANNEL	TX Channel 149	DETECTOR FUNCTION	Peak (PK)
FREQUENCY RANGE	1GHz ~ 40GHz		Average (AV)

ANTENNA POLARITY & TEST DISTANCE: HORIZONTAL AT 3 M								
NO.	FREQ. (MHz)	EMISSION LEVEL (dBuV/m)	LIMIT (dBuV/m)	MARGIN (dB)	ANTENNA HEIGHT (m)	TABLE ANGLE (Degree)	RAW VALUE (dBuV)	CORRECTION FACTOR (dB/m)
1	#5714.00	60.5 PK	74.0	-13.5	2.51 H	154	53.10	7.40
2	#5714.00	47.6 AV	54.0	-6.4	2.51 H	154	40.20	7.40
3	#5722.00	69.0 PK	78.2	-9.2	2.26 H	303	61.60	7.40
4	#5725.00	54.8 PK	78.2	-23.4	2.26 H	303	47.40	7.40
5	*5745.00	105.0 PK			1.92 H	106	64.50	40.50
6	*5745.00	95.4 AV			1.92 H	106	54.90	40.50
7	11490.00	60.9 PK	74.0	-13.1	2.11 H	343	42.20	18.70
8	11490.00	47.8 AV	54.0	-6.2	2.11 H	343	29.10	18.70

ANTENNA POLARITY & TEST DISTANCE: VERTICAL AT 3 M								
NO.	FREQ. (MHz)	EMISSION LEVEL (dBuV/m)	LIMIT (dBuV/m)	MARGIN (dB)	ANTENNA HEIGHT (m)	TABLE ANGLE (Degree)	RAW VALUE (dBuV)	CORRECTION FACTOR (dB/m)
1	#5714.90	69.1 PK	74.0	-4.9	1.93 V	201	61.70	7.40
2	#5714.90	52.9 AV	54.0	-1.1	1.93 V	201	45.50	7.40
3	#5722.90	77.2 PK	78.2	-1.0	2.04 V	281	69.80	7.40
4	#5725.00	63.8 PK	78.2	-14.4	2.04 V	281	56.40	7.40
5	*5745.00	117.2 PK			2.26 V	343	76.70	40.50
6	*5745.00	106.2 AV			2.26 V	343	65.70	40.50
7	11490.00	61.5 PK	74.0	-12.5	2.12 V	22	42.80	18.70
8	11490.00	48.4 AV	54.0	-5.6	2.12 V	22	29.70	18.70

Remarks:

1. Emission Level(dBuV/m) = Raw Value(dBuV) + Correction Factor(dB/m)
2. Correction Factor(dB/m) = Antenna Factor(dB/m) + Cable Factor(dB)
3. The other emission levels were very low against the limit.
4. Margin value = Emission Level – Limit value
5. " * ": Fundamental frequency.
6. " # ": The radiated frequency is out of the restricted band.

CHANNEL	TX Channel 157	DETECTOR FUNCTION	Peak (PK)
FREQUENCY RANGE	1GHz ~ 40GHz		Average (AV)

ANTENNA POLARITY & TEST DISTANCE: HORIZONTAL AT 3 M

NO.	FREQ. (MHz)	EMISSION LEVEL (dBuV/m)	LIMIT (dBuV/m)	MARGIN (dB)	ANTENNA HEIGHT (m)	TABLE ANGLE (Degree)	RAW VALUE (dBuV)	CORRECTION FACTOR (dB/m)
1	*5785.00	107.0 PK			2.01 H	112	66.40	40.60
2	*5785.00	96.2 AV			2.01 H	112	55.60	40.60
3	11570.00	61.6 PK	74.0	-12.4	2.30 H	321	42.90	18.70
4	11570.00	48.5 AV	54.0	-5.5	2.30 H	321	29.80	18.70

ANTENNA POLARITY & TEST DISTANCE: VERTICAL AT 3 M

NO.	FREQ. (MHz)	EMISSION LEVEL (dBuV/m)	LIMIT (dBuV/m)	MARGIN (dB)	ANTENNA HEIGHT (m)	TABLE ANGLE (Degree)	RAW VALUE (dBuV)	CORRECTION FACTOR (dB/m)
1	5456.00	65.6 PK	74.0	-8.4	1.80 V	321	58.70	6.90
2	5456.00	52.4 AV	54.0	-1.6	1.80 V	321	45.50	6.90
3	*5785.00	117.9 PK			2.27 V	144	77.30	40.60
4	*5785.00	107.3 AV			2.27 V	144	66.70	40.60
5	11570.00	63.1 PK	74.0	-10.9	1.90 V	19	44.40	18.70
6	11570.00	49.2 AV	54.0	-4.8	1.90 V	19	30.50	18.70

Remarks:

1. Emission Level(dBuV/m) = Raw Value(dBuV) + Correction Factor(dB/m)
2. Correction Factor(dB/m) = Antenna Factor(dB/m) + Cable Factor(dB)
3. The other emission levels were very low against the limit.
4. Margin value = Emission Level – Limit value
5. " * ": Fundamental frequency.
6. " # ": The radiated frequency is out of the restricted band.

CHANNEL	TX Channel 165	DETECTOR FUNCTION	Peak (PK)
FREQUENCY RANGE	1GHz ~ 40GHz		Average (AV)

ANTENNA POLARITY & TEST DISTANCE: HORIZONTAL AT 3 M

NO.	FREQ. (MHz)	EMISSION LEVEL (dBuV/m)	LIMIT (dBuV/m)	MARGIN (dB)	ANTENNA HEIGHT (m)	TABLE ANGLE (Degree)	RAW VALUE (dBuV)	CORRECTION FACTOR (dB/m)
1	*5825.00	103.8 PK			2.10 H	102	63.20	40.60
2	*5825.00	93.8 AV			2.10 H	102	53.20	40.60
3	#5850.00	52.2 PK	78.2	-26.0	2.07 H	90	44.60	7.60
4	#5853.00	62.1 PK	78.2	-16.1	2.07 H	90	54.40	7.70
5	#5861.00	57.6 PK	74.0	-16.4	2.09 H	275	49.90	7.70
6	#5861.00	46.0 AV	54.0	-8.0	2.09 H	275	38.30	7.70
7	11650.00	61.9 PK	74.0	-12.1	1.99 H	123	42.70	19.20
8	11650.00	48.9 AV	54.0	-5.1	1.99 H	123	29.70	19.20

ANTENNA POLARITY & TEST DISTANCE: VERTICAL AT 3 M

NO.	FREQ. (MHz)	EMISSION LEVEL (dBuV/m)	LIMIT (dBuV/m)	MARGIN (dB)	ANTENNA HEIGHT (m)	TABLE ANGLE (Degree)	RAW VALUE (dBuV)	CORRECTION FACTOR (dB/m)
1	5456.00	64.2 PK	74.0	-9.8	1.88 V	319	57.30	6.90
2	5456.00	52.8 AV	54.0	-1.2	1.88 V	319	45.90	6.90
3	*5825.00	117.4 PK			2.20 V	169	76.80	40.60
4	*5825.00	106.3 AV			2.20 V	169	65.70	40.60
5	#5850.00	62.2 PK	78.2	-16.0	2.19 V	148	54.60	7.60
6	#5853.00	75.0 PK	78.2	-3.2	2.19 V	148	67.30	7.70
7	#5861.00	69.3 PK	74.0	-4.7	2.20 V	336	61.60	7.70
8	#5861.00	51.1 AV	54.0	-2.9	2.20 V	336	43.40	7.70
9	11650.00	62.2 PK	74.0	-11.8	2.01 V	33	43.00	19.20
10	11650.00	49.3 AV	54.0	-4.7	2.01 V	33	30.10	19.20

Remarks:

1. Emission Level(dBuV/m) = Raw Value(dBuV) + Correction Factor(dB/m)
2. Correction Factor(dB/m) = Antenna Factor(dB/m) + Cable Factor(dB)
3. The other emission levels were very low against the limit.
4. Margin value = Emission Level – Limit value
5. " * ": Fundamental frequency.
6. " # ": The radiated frequency is out of the restricted band.

802.11n (HT40)

CHANNEL	TX Channel 38	DETECTOR FUNCTION	Peak (PK)
FREQUENCY RANGE	1GHz ~ 40GHz		Average (AV)

ANTENNA POLARITY & TEST DISTANCE: HORIZONTAL AT 3 M

NO.	FREQ. (MHz)	EMISSION LEVEL (dBuV/m)	LIMIT (dBuV/m)	MARGIN (dB)	ANTENNA HEIGHT (m)	TABLE ANGLE (Degree)	RAW VALUE (dBuV)	CORRECTION FACTOR (dB/m)
1	5150.00	57.7 PK	74.0	-16.3	2.03 H	256	51.70	6.00
2	5150.00	44.9 AV	54.0	-9.1	2.03 H	256	38.90	6.00
3	*5190.00	90.0 PK			1.00 H	171	50.60	39.40
4	*5190.00	81.1 AV			1.00 H	171	41.70	39.40
5	#10380.00	58.4 PK	74.0	-15.6	1.44 H	184	40.70	17.70
6	#10380.00	46.1 AV	54.0	-7.9	1.44 H	184	28.40	17.70

ANTENNA POLARITY & TEST DISTANCE: VERTICAL AT 3 M

NO.	FREQ. (MHz)	EMISSION LEVEL (dBuV/m)	LIMIT (dBuV/m)	MARGIN (dB)	ANTENNA HEIGHT (m)	TABLE ANGLE (Degree)	RAW VALUE (dBuV)	CORRECTION FACTOR (dB/m)
1	5150.00	65.8 PK	74.0	-8.2	1.51 V	22	59.80	6.00
2	5150.00	52.8 AV	54.0	-1.2	1.51 V	22	46.80	6.00
3	*5190.00	105.9 PK			1.52 V	130	66.50	39.40
4	*5190.00	96.7 AV			1.52 V	130	57.30	39.40
5	#10380.00	58.3 PK	74.0	-15.7	1.39 V	138	40.60	17.70
6	#10380.00	46.8 AV	54.0	-7.2	1.39 V	138	29.10	17.70

Remarks:

1. Emission Level(dBuV/m) = Raw Value(dBuV) + Correction Factor(dB/m)
2. Correction Factor(dB/m) = Antenna Factor(dB/m) + Cable Factor(dB)
3. The other emission levels were very low against the limit.
4. Margin value = Emission Level – Limit value
5. " * ": Fundamental frequency.
6. " # ": The radiated frequency is out of the restricted band.

CHANNEL	TX Channel 46	DETECTOR FUNCTION	Peak (PK)
FREQUENCY RANGE	1GHz ~ 40GHz		Average (AV)

ANTENNA POLARITY & TEST DISTANCE: HORIZONTAL AT 3 M

NO.	FREQ. (MHz)	EMISSION LEVEL (dBuV/m)	LIMIT (dBuV/m)	MARGIN (dB)	ANTENNA HEIGHT (m)	TABLE ANGLE (Degree)	RAW VALUE (dBuV)	CORRECTION FACTOR (dB/m)
1	*5230.00	99.3 PK			1.01 H	0	59.70	39.60
2	*5230.00	90.1 AV			1.01 H	0	50.50	39.60
3	5456.00	57.7 PK	74.0	-16.3	1.31 H	31	50.80	6.90
4	5456.00	46.2 AV	54.0	-7.8	1.31 H	31	39.30	6.90
5	#10460.00	59.1 PK	74.0	-14.9	1.25 H	84	40.60	18.50
6	#10460.00	47.3 AV	54.0	-6.7	1.25 H	84	28.80	18.50

ANTENNA POLARITY & TEST DISTANCE: VERTICAL AT 3 M

NO.	FREQ. (MHz)	EMISSION LEVEL (dBuV/m)	LIMIT (dBuV/m)	MARGIN (dB)	ANTENNA HEIGHT (m)	TABLE ANGLE (Degree)	RAW VALUE (dBuV)	CORRECTION FACTOR (dB/m)
1	*5230.00	115.1 PK			1.46 V	185	75.50	39.60
2	*5230.00	105.6 AV			1.46 V	185	66.00	39.60
3	5456.00	61.7 PK	74.0	-12.3	1.50 V	84	54.80	6.90
4	5456.00	52.5 AV	54.0	-1.5	1.50 V	84	45.60	6.90
5	#10460.00	58.5 PK	74.0	-15.5	1.17 V	106	40.00	18.50
6	#10460.00	47.4 AV	54.0	-6.6	1.17 V	106	28.90	18.50

Remarks:

1. Emission Level(dBuV/m) = Raw Value(dBuV) + Correction Factor(dB/m)
2. Correction Factor(dB/m) = Antenna Factor(dB/m) + Cable Factor(dB)
3. The other emission levels were very low against the limit.
4. Margin value = Emission Level – Limit value
5. " * ": Fundamental frequency.
6. " # ": The radiated frequency is out of the restricted band.

CHANNEL	TX Channel 151	DETECTOR FUNCTION	Peak (PK)
FREQUENCY RANGE	1GHz ~ 40GHz		Average (AV)

ANTENNA POLARITY & TEST DISTANCE: HORIZONTAL AT 3 M								
NO.	FREQ. (MHz)	EMISSION LEVEL (dBuV/m)	LIMIT (dBuV/m)	MARGIN (dB)	ANTENNA HEIGHT (m)	TABLE ANGLE (Degree)	RAW VALUE (dBuV)	CORRECTION FACTOR (dB/m)
1	#5714.90	57.5 PK	74.0	-16.5	2.14 H	190	50.10	7.40
2	#5714.90	45.9 AV	54.0	-8.1	2.14 H	190	38.50	7.40
3	#5722.00	62.2 PK	78.2	-16.0	2.26 H	303	54.80	7.40
4	#5725.00	52.5 PK	78.2	-25.7	2.26 H	303	45.10	7.40
5	*5755.00	98.1 PK			2.17 H	297	57.50	40.60
6	*5755.00	88.4 AV			2.17 H	297	47.80	40.60
7	11510.00	60.1 PK	74.0	-13.9	1.77 H	212	41.40	18.70
8	11510.00	46.9 AV	54.0	-7.1	1.77 H	212	28.20	18.70

ANTENNA POLARITY & TEST DISTANCE: VERTICAL AT 3 M								
NO.	FREQ. (MHz)	EMISSION LEVEL (dBuV/m)	LIMIT (dBuV/m)	MARGIN (dB)	ANTENNA HEIGHT (m)	TABLE ANGLE (Degree)	RAW VALUE (dBuV)	CORRECTION FACTOR (dB/m)
1	#5714.90	69.0 PK	74.0	-5.0	2.29 V	15	61.60	7.40
2	#5714.90	53.0 AV	54.0	-1.0	2.29 V	15	45.60	7.40
3	#5722.90	72.7 PK	78.2	-5.5	2.04 V	152	65.30	7.40
4	#5725.00	59.1 PK	78.2	-19.1	2.04 V	152	51.70	7.40
5	*5755.00	108.2 PK			2.01 V	165	67.60	40.60
6	*5755.00	98.0 AV			2.01 V	165	57.40	40.60
7	11510.00	60.6 PK	74.0	-13.4	2.04 V	280	41.90	18.70
8	11510.00	47.5 AV	54.0	-6.5	2.04 V	280	28.80	18.70

Remarks:

1. Emission Level(dBuV/m) = Raw Value(dBuV) + Correction Factor(dB/m)
2. Correction Factor(dB/m) = Antenna Factor(dB/m) + Cable Factor(dB)
3. The other emission levels were very low against the limit.
4. Margin value = Emission Level – Limit value
5. " * ": Fundamental frequency.
6. " # ": The radiated frequency is out of the restricted band.

CHANNEL	TX Channel 159	DETECTOR FUNCTION	Peak (PK)
FREQUENCY RANGE	1GHz ~ 40GHz		Average (AV)

ANTENNA POLARITY & TEST DISTANCE: HORIZONTAL AT 3 M								
NO.	FREQ. (MHz)	EMISSION LEVEL (dBuV/m)	LIMIT (dBuV/m)	MARGIN (dB)	ANTENNA HEIGHT (m)	TABLE ANGLE (Degree)	RAW VALUE (dBuV)	CORRECTION FACTOR (dB/m)
1	5410.00	59.2 PK	74.0	-14.8	2.12 H	333	52.50	6.70
2	5410.00	46.4 AV	54.0	-7.6	2.12 H	333	39.70	6.70
3	*5795.00	103.9 PK			2.87 H	356	63.30	40.60
4	*5795.00	93.7 AV			2.87 H	356	53.10	40.60
5	#5861.00	58.1 PK	74.0	-15.9	2.38 H	277	50.40	7.70
6	#5861.00	47.2 AV	54.0	-6.8	2.38 H	277	39.50	7.70
7	11590.00	60.3 PK	74.0	-13.7	1.70 H	162	41.50	18.80
8	11590.00	47.3 AV	54.0	-6.7	1.70 H	162	28.50	18.80

ANTENNA POLARITY & TEST DISTANCE: VERTICAL AT 3 M								
NO.	FREQ. (MHz)	EMISSION LEVEL (dBuV/m)	LIMIT (dBuV/m)	MARGIN (dB)	ANTENNA HEIGHT (m)	TABLE ANGLE (Degree)	RAW VALUE (dBuV)	CORRECTION FACTOR (dB/m)
1	5456.00	63.8 PK	74.0	-10.2	1.87 V	315	56.90	6.90
2	5456.00	52.7 AV	54.0	-1.3	1.87 V	315	45.80	6.90
3	#5700.00	66.1 PK	74.0	-7.9	2.10 V	167	58.80	7.30
4	#5700.00	53.0 AV	54.0	-1.0	2.10 V	167	45.70	7.30
5	*5795.00	111.7 PK			2.23 V	139	71.10	40.60
6	*5795.00	102.7 AV			2.23 V	139	62.10	40.60
7	#5861.00	67.8 PK	74.0	-6.2	2.06 V	165	60.10	7.70
8	#5861.00	52.7 AV	54.0	-1.3	2.06 V	165	45.00	7.70
9	11590.00	60.4 PK	74.0	-13.6	2.05 V	11	41.60	18.80
10	11590.00	47.3 AV	54.0	-6.7	2.05 V	11	28.50	18.80

Remarks:

1. Emission Level(dBuV/m) = Raw Value(dBuV) + Correction Factor(dB/m)
2. Correction Factor(dB/m) = Antenna Factor(dB/m) + Cable Factor(dB)
3. The other emission levels were very low against the limit.
4. Margin value = Emission Level – Limit value
5. " * ": Fundamental frequency.
6. " # ": The radiated frequency is out of the restricted band.

Below 1GHz Worst-Case Data: 802.11a

CHANNEL	TX Channel 36	DETECTOR FUNCTION	Quasi-Peak (QP)
FREQUENCY RANGE	30MHz ~ 1GHz		
TEST MODE	A		

ANTENNA POLARITY & TEST DISTANCE: HORIZONTAL AT 3 M

NO.	FREQ. (MHz)	EMISSION LEVEL (dBuV/m)	LIMIT (dBuV/m)	MARGIN (dB)	ANTENNA HEIGHT (m)	TABLE ANGLE (Degree)	RAW VALUE (dBuV)	CORRECTION FACTOR (dB/m)
1	43.51	31.0 QP	40.0	-9.0	2.00 H	142	45.80	-14.80
2	57.12	30.9 QP	40.0	-9.1	2.00 H	207	45.50	-14.60
3	150.45	35.0 QP	43.5	-8.5	1.50 H	249	48.90	-13.90
4	206.83	29.7 QP	43.5	-13.8	2.00 H	253	46.10	-16.40
5	327.38	28.6 QP	46.0	-17.4	1.00 H	191	40.00	-11.40
6	500.42	29.1 QP	46.0	-16.9	1.50 H	226	37.20	-8.10

ANTENNA POLARITY & TEST DISTANCE: VERTICAL AT 3 M

NO.	FREQ. (MHz)	EMISSION LEVEL (dBuV/m)	LIMIT (dBuV/m)	MARGIN (dB)	ANTENNA HEIGHT (m)	TABLE ANGLE (Degree)	RAW VALUE (dBuV)	CORRECTION FACTOR (dB/m)
1	30.90	36.9 QP	40.0	-3.1	1.00 V	154	52.80	-15.90
2	53.23	38.2 QP	40.0	-1.8	1.50 V	16	52.40	-14.20
3	76.56	36.8 QP	40.0	-3.2	1.00 V	111	54.50	-17.70
4	105.73	34.5 QP	43.5	-9.0	1.00 V	78	52.40	-17.90
5	150.45	35.8 QP	43.5	-7.7	1.50 V	16	49.70	-13.90
6	374.04	31.3 QP	46.0	-14.7	1.50 V	122	41.90	-10.60

Remarks:

1. Emission Level(dBuV/m) = Raw Value(dBuV) + Correction Factor(dB/m)
2. Correction Factor(dB/m) = Antenna Factor(dB/m) + Cable Factor(dB)
3. The other emission levels were very low against the limit.
4. Margin value = Emission Level – Limit value

CHANNEL	TX Channel 36	DETECTOR FUNCTION	Quasi-Peak (QP)
FREQUENCY RANGE	30MHz ~ 1GHz		
TEST MODE	B		

ANTENNA POLARITY & TEST DISTANCE: HORIZONTAL AT 3 M

NO.	FREQ. (MHz)	EMISSION LEVEL (dBuV/m)	LIMIT (dBuV/m)	MARGIN (dB)	ANTENNA HEIGHT (m)	TABLE ANGLE (Degree)	RAW VALUE (dBuV)	CORRECTION FACTOR (dB/m)
1	57.12	31.0 QP	40.0	-9.0	1.99 H	18	45.60	-14.60
2	125.17	32.0 QP	43.5	-11.5	1.50 H	104	47.90	-15.90
3	142.67	32.5 QP	43.5	-11.0	1.99 H	102	46.60	-14.10
4	249.60	31.0 QP	46.0	-15.0	1.00 H	55	45.20	-14.20
5	327.38	34.4 QP	46.0	-11.6	1.00 H	173	45.80	-11.40
6	900.94	34.6 QP	46.0	-11.4	1.99 H	4	34.90	-0.30

ANTENNA POLARITY & TEST DISTANCE: VERTICAL AT 3 M

NO.	FREQ. (MHz)	EMISSION LEVEL (dBuV/m)	LIMIT (dBuV/m)	MARGIN (dB)	ANTENNA HEIGHT (m)	TABLE ANGLE (Degree)	RAW VALUE (dBuV)	CORRECTION FACTOR (dB/m)
1	55.18	38.6 QP	40.0	-1.4	1.00 V	51	53.00	-14.40
2	62.95	36.8 QP	40.0	-3.2	1.00 V	44	51.90	-15.10
3	111.56	33.5 QP	43.5	-10.0	1.00 V	55	50.40	-16.90
4	226.27	32.4 QP	46.0	-13.6	1.00 V	136	48.60	-16.20
5	315.71	34.1 QP	46.0	-11.9	1.49 V	256	45.90	-11.80
6	356.54	33.2 QP	46.0	-12.8	1.00 V	185	44.50	-11.30

Remarks:

1. Emission Level(dBuV/m) = Raw Value(dBuV) + Correction Factor(dB/m)
2. Correction Factor(dB/m) = Antenna Factor(dB/m) + Cable Factor(dB)
3. The other emission levels were very low against the limit.
4. Margin value = Emission Level – Limit value

4.2 Conducted Emission Measurement

4.2.1 Limits of Conducted Emission Measurement

Frequency (MHz)	Conducted Limit (dBuV)	
	Quasi-peak	Average
0.15 - 0.5	66 - 56	56 - 46
0.50 - 5.0	56	46
5.0 - 30.0	60	50

- Note:** 1. The lower limit shall apply at the transition frequencies.
 2. The limit decreases in line with the logarithm of the frequency in the range of 0.15 to 0.50MHz.

4.2.2 Test Instruments

Description & Manufacturer	Model No.	Serial No.	Cal. Date	Cal. Due
Test Receiver ROHDE & SCHWARZ	ESCS 30	100288	Apr. 27, 2015	Apr. 26, 2016
RF signal cable (with 10dB PAD) Woken	5D-FB	Cable-cond2-01	Dec. 26, 2015	Dec. 25, 2016
LISN ROHDE & SCHWARZ (EUT)	ESH2-Z5	100100	Jan. 11, 2016	Jan. 10, 2017
LISN ROHDE & SCHWARZ (Peripheral)	ESH3-Z5	100312	Jul. 21, 2015	Jul. 20, 2016
Software ADT	BV ADT_Cond_ V7.3.7.3	NA	NA	NA

- Note:** 1. The calibration interval of the above test instruments is 12 months and the calibrations are traceable to NML/ROC and NIST/USA.
 2. The test was performed in HwaYa Shielded Room 2.
 3. The VCCI Site Registration No. is C-2047.

4.2.3 Test Procedures

- The EUT was placed 0.4 meters from the conducting wall of the shielded room with EUT being connected to the power mains through a line impedance stabilization network (LISN). Other support units were connected to the power mains through another LISN. The two LISNs provide 50 ohm/ 50uH of coupling impedance for the measuring instrument.
- Both lines of the power mains connected to the EUT were checked for maximum conducted interference.
- The frequency range from 150kHz to 30MHz was searched. Emission levels under (Limit - 20dB) was not recorded.

NOTE: The resolution bandwidth and video bandwidth of test receiver is 9kHz for quasi-peak detection (QP) and average detection (AV) at frequency 0.15MHz-30MHz.

4.2.4 Deviation from Test Standard

No deviation.

4.2.5 Test Setup

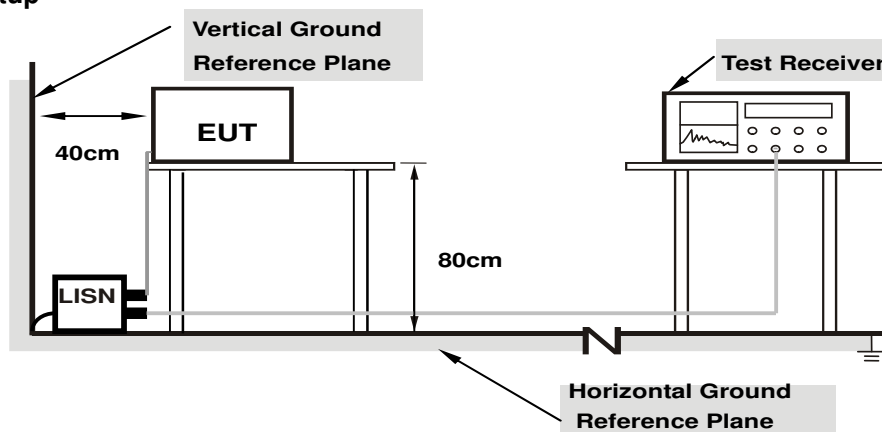

Note: 1.Support units were connected to second LISN.

For the actual test configuration, please refer to the attached file (Test Setup Photo).

4.2.6 EUT Operating Conditions

Same as 4.1.6.

4.2.7 Test Results

Phase	Line (L)	Detector Function	Quasi-Peak (QP) / Average (AV)
Test Mode	A		

No	Freq. [MHz]	Corr. Factor (dB)	Reading Value		Emission Level		Limit		Margin	
			[dB (uV)]		[dB (uV)]		[dB (uV)]		(dB)	
			Q.P.	AV.	Q.P.	AV.	Q.P.	AV.	Q.P.	AV.
1	0.15391	10.18	38.79	26.49	48.97	36.67	65.79	55.79	-16.81	-19.11
2	0.18125	10.20	36.69	25.49	46.89	35.69	64.43	54.43	-17.54	-18.74
3	0.28273	10.22	34.13	26.97	44.35	37.19	60.74	50.74	-16.38	-13.54
4	0.47031	10.25	28.01	19.63	38.26	29.88	56.51	46.51	-18.25	-16.63
5	0.78016	10.28	26.79	19.83	37.07	30.11	56.00	46.00	-18.93	-15.89
6	1.85938	10.37	25.86	20.19	36.23	30.56	56.00	46.00	-19.77	-15.44

Remarks:

1. Q.P. and AV. are abbreviations of quasi-peak and average individually.
2. The emission levels of other frequencies were very low against the limit.
3. Margin value = Emission level - Limit value
4. Correction factor = Insertion loss + Cable loss
5. Emission Level = Correction Factor + Reading Value.

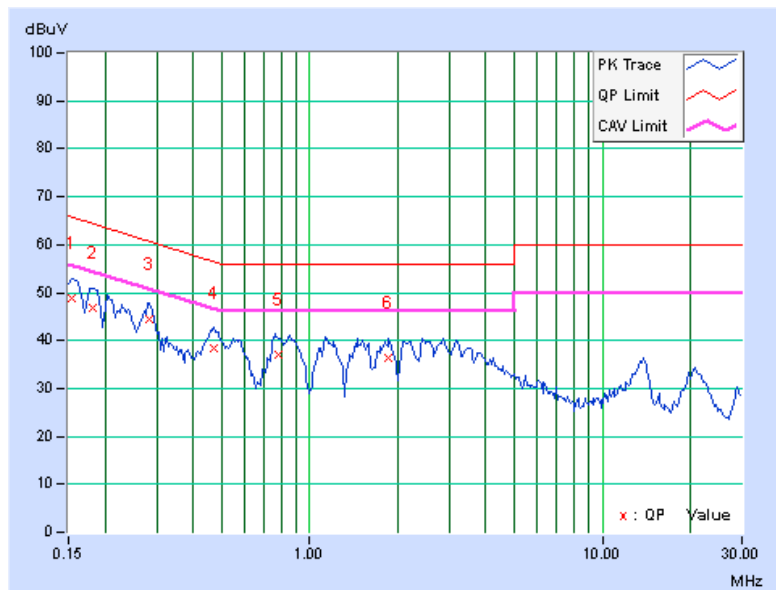

Phase	Neutral (N)	Detector Function	Quasi-Peak (QP) / Average (AV)
Test Mode	A		

No	Freq. [MHz]	Corr. Factor (dB)	Reading Value [dB (uV)]		Emission Level [dB (uV)]		Limit [dB (uV)]		Margin (dB)	
			Q.P.	AV.	Q.P.	AV.	Q.P.	AV.	Q.P.	AV.
			1	0.15391	10.19	38.38	23.29	48.57	33.48	65.79
2	0.18906	10.20	35.32	21.08	45.52	31.28	64.08	54.08	-18.56	-22.80
3	0.28281	10.24	33.48	23.97	43.72	34.21	60.73	50.73	-17.01	-16.52
4	0.45859	10.30	25.22	17.08	35.52	27.38	56.72	46.72	-21.20	-19.34
5	0.84531	10.29	22.88	14.94	33.17	25.23	56.00	46.00	-22.83	-20.77
6	2.50000	10.45	21.65	14.79	32.10	25.24	56.00	46.00	-23.90	-20.76

Remarks:

1. Q.P. and AV. are abbreviations of quasi-peak and average individually.
2. The emission levels of other frequencies were very low against the limit.
3. Margin value = Emission level - Limit value
4. Correction factor = Insertion loss + Cable loss
5. Emission Level = Correction Factor + Reading Value.

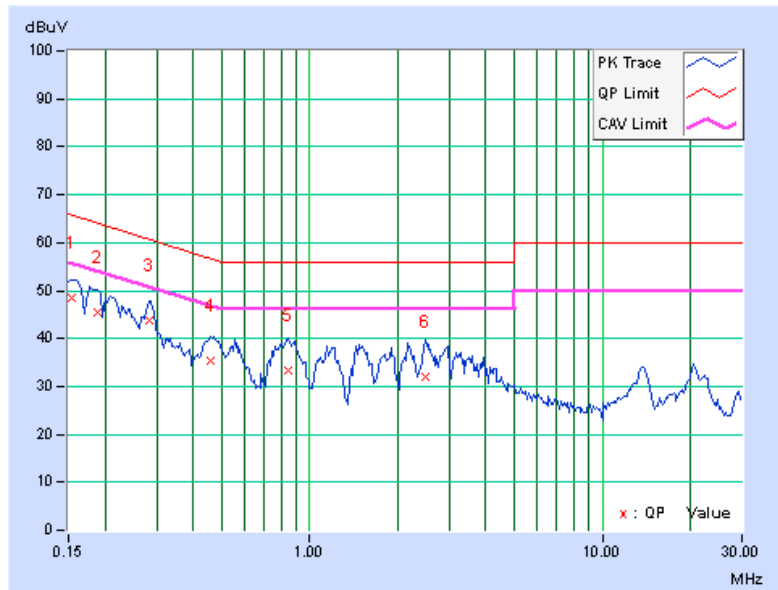

Phase	Line (L)	Detector Function	Quasi-Peak (QP) / Average (AV)
Test Mode	B		

No	Freq. [MHz]	Corr. Factor (dB)	Reading Value [dB (uV)]		Emission Level [dB (uV)]		Limit [dB (uV)]		Margin (dB)	
			Q.P.	AV.	Q.P.	AV.	Q.P.	AV.	Q.P.	AV.
			1	0.15781	10.18	44.13	25.42	54.31	35.60	65.58
2	0.18125	10.20	39.56	22.96	49.76	33.16	64.43	54.43	-14.67	-21.27
3	0.26719	10.22	35.43	28.42	45.65	38.64	61.20	51.20	-15.55	-12.56
4	0.29063	10.22	38.01	33.20	48.23	43.42	60.51	50.51	-12.27	-7.08
5	0.89609	10.30	22.94	21.53	33.24	31.83	56.00	46.00	-22.76	-14.17
6	2.78898	10.39	22.77	16.91	33.16	27.30	56.00	46.00	-22.84	-18.70

Remarks:

1. Q.P. and AV. are abbreviations of quasi-peak and average individually.
2. The emission levels of other frequencies were very low against the limit.
3. Margin value = Emission level - Limit value
4. Correction factor = Insertion loss + Cable loss
5. Emission Level = Correction Factor + Reading Value.

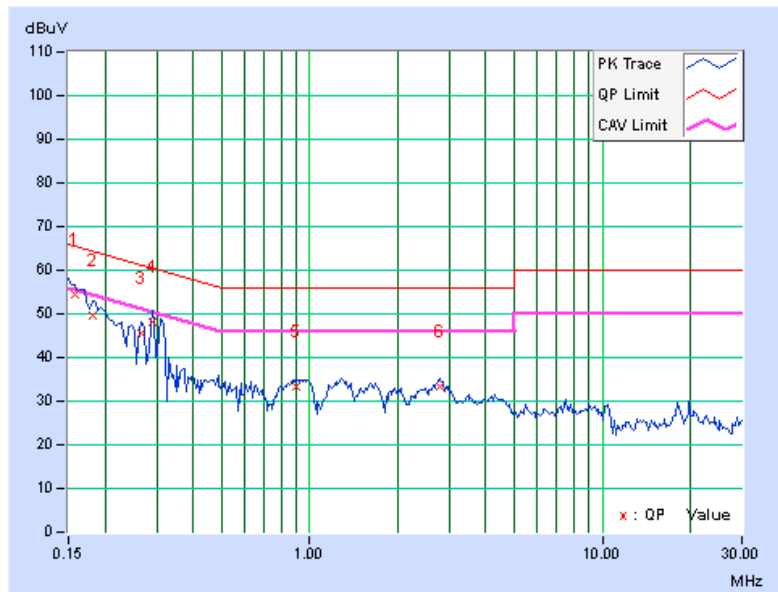

Phase	Neutral (N)	Detector Function	Quasi-Peak (QP) / Average (AV)
Test Mode	B		

No	Freq. [MHz]	Corr. Factor (dB)	Reading Value [dB (uV)]		Emission Level [dB (uV)]		Limit [dB (uV)]		Margin (dB)	
			Q.P.	AV.	Q.P.	AV.	Q.P.	AV.	Q.P.	AV.
			1	0.15781	10.19	44.42	25.81	54.61	36.00	65.58
2	0.19687	10.20	37.18	21.43	47.38	31.63	63.74	53.74	-16.36	-22.11
3	0.26719	10.23	35.79	28.56	46.02	38.79	61.20	51.20	-15.18	-12.41
4	0.29063	10.25	38.37	33.48	48.62	43.73	60.51	50.51	-11.89	-6.78
5	0.90000	10.29	22.36	18.23	32.65	28.52	56.00	46.00	-23.35	-17.48
6	1.28516	10.32	22.70	18.12	33.02	28.44	56.00	46.00	-22.98	-17.56

Remarks:

1. Q.P. and AV. are abbreviations of quasi-peak and average individually.
2. The emission levels of other frequencies were very low against the limit.
3. Margin value = Emission level - Limit value
4. Correction factor = Insertion loss + Cable loss
5. Emission Level = Correction Factor + Reading Value.

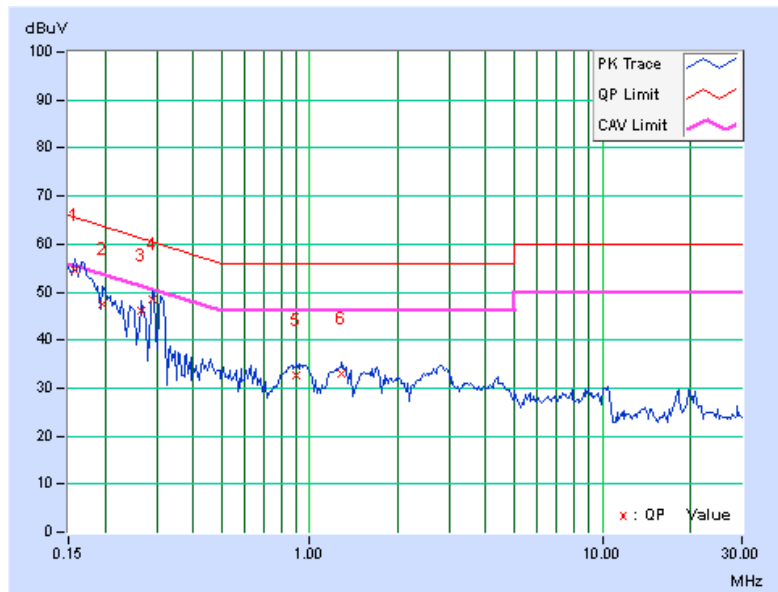

4.3 Transmit Power Measurement

4.3.1 Limits of Transmit Power Measurement

Operation Band	EUT Category		LIMIT
U-NII-1		Outdoor Access Point	1 Watt (30 dBm) (Max. e.i.r.p \leq 125mW(21 dBm) at any elevation angle above 30 degrees as measured from the horizon)
		Fixed point-to-point Access Point	1 Watt (30 dBm)
	√	Indoor Access Point	1 Watt (30 dBm)
		Mobile and Portable client device	250mW (24 dBm)
U-NII-2A	---		250mW (24 dBm) or 11 dBm+10 log B*
U-NII-2C	---		250mW (24 dBm) or 11 dBm+10 log B*
U-NII-3	√		1 Watt (30 dBm)

*B is the 26 dB emission bandwidth in megahertz

Per KDB 662911 Method of conducted output power measurement on IEEE 802.11 devices,

Array Gain = 0 dB (i.e., no array gain) for $N_{ANT} \leq 4$;

Array Gain = 0 dB (i.e., no array gain) for channel widths ≥ 40 MHz for any N_{ANT} ;

Array Gain = $5 \log(N_{ANT}/N_{SS})$ dB or 3 dB, whichever is less for 20-MHz channel widths with $N_{ANT} \geq 5$.

For power measurements on all other devices: Array Gain = $10 \log(N_{ANT}/N_{SS})$ dB.

4.3.2 Test Setup

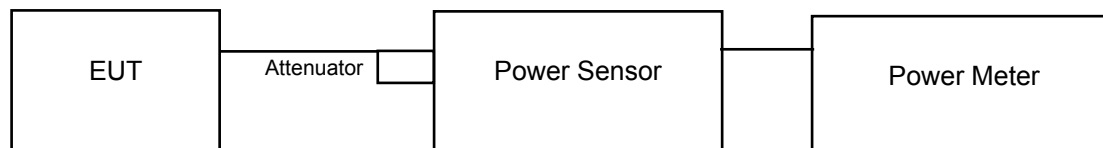

4.3.3 Test Instruments

Refer to section 4.1.2 to get information of above instrument.

4.3.4 Test Procedure

Method PM is used to perform output power measurement, trigger and gating function of wide band power meter is enabled to measure max output power of TX on burst. Duty factor is not added to measured value.

4.3.5 Deviation from Test Standard

No deviation.

4.3.6 EUT Operating Conditions

The software provided by client to enable the EUT under transmission condition continuously at lowest, middle and highest channel frequencies individually.

4.3.7 Test Result

Power Output:

802.11a

Chan.	Freq. (MHz)	Maximum Conducted Power (dBm)		Total Power (mW)	Total Power (dBm)	Power Limit (dBm)	Pass / Fail
		Chain 0	Chain 1				
36	5180	18.34	16.90	117.212	20.69	30.00	Pass
40	5200	19.89	18.92	175.482	22.44	30.00	Pass
48	5240	19.72	19.44	181.658	22.59	30.00	Pass
149	5745	18.93	17.41	133.244	21.25	30.00	Pass
157	5785	20.25	18.59	178.202	22.51	30.00	Pass
165	5825	18.17	16.42	109.468	20.39	30.00	Pass

802.11n (HT20)

Chan.	Freq. (MHz)	Maximum Conducted Power (dBm)		Total Power (mW)	Total Power (dBm)	Power Limit (dBm)	Pass / Fail
		Chain 0	Chain 1				
36	5180	18.56	17.19	124.139	20.94	30.00	Pass
40	5200	19.92	18.65	171.457	22.34	30.00	Pass
48	5240	20.02	19.63	192.295	22.84	30.00	Pass
149	5745	17.57	15.75	94.732	19.76	30.00	Pass
157	5785	19.22	17.32	137.511	21.38	30.00	Pass
165	5825	17.62	15.45	92.885	19.68	30.00	Pass

802.11n (HT40)

Chan.	Freq. (MHz)	Maximum Conducted Power (dBm)		Total Power (mW)	Total Power (dBm)	Power Limit (dBm)	Pass / Fail
		Chain 0	Chain 1				
38	5190	11.77	10.02	25.077	13.99	30.00	Pass
46	5230	18.67	17.80	133.877	21.27	30.00	Pass
151	5755	11.71	10.62	26.360	14.21	30.00	Pass
159	5795	18.21	16.26	108.489	20.35	30.00	Pass

26dB Bandwidth:
802.11a

Chan.	Freq. (MHz)	26dBc Bandwidth (MHz)		Pass / Fail
		Chain 0	Chain 1	
36	5180	24.30	22.78	Pass
40	5200	23.30	22.85	Pass
48	5240	22.68	22.77	Pass

802.11n (HT20)

Chan.	Freq. (MHz)	26dBc Bandwidth (MHz)		Pass / Fail
		Chain 0	Chain 1	
36	5180	23.83	23.89	Pass
40	5200	23.70	24.46	Pass
48	5240	23.98	24.15	Pass

802.11n (HT40)

Chan.	Freq. (MHz)	26dBc Bandwidth (MHz)		Pass / Fail
		Chain 0	Chain 1	
38	5190	49.32	49.10	Pass
46	5230	49.51	48.68	Pass

Spectrum Plot of Worst Value

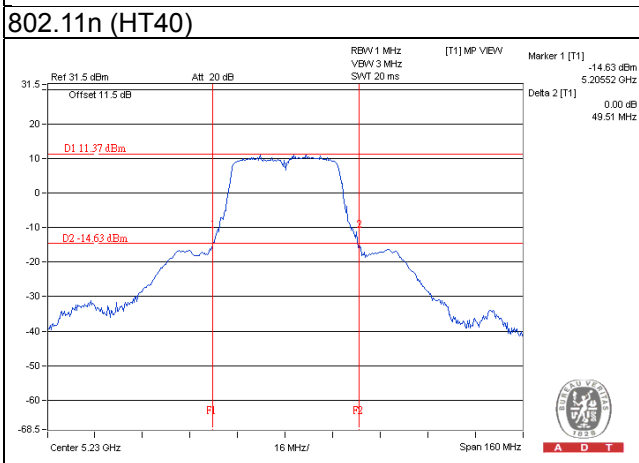
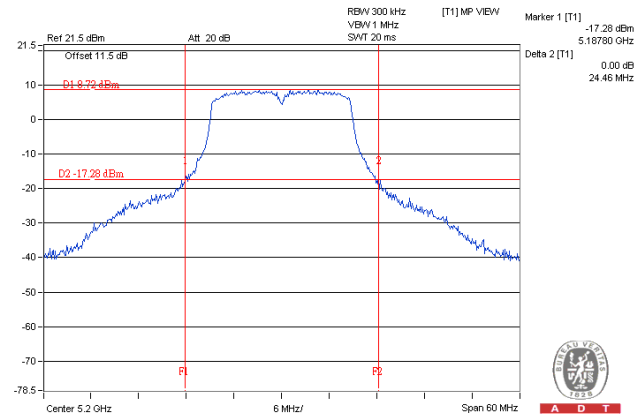
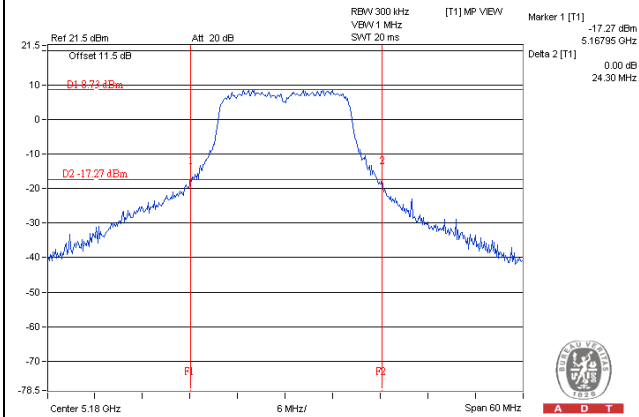

Occupied Bandwidth:
802.11a

Chan.	Freq. (MHz)	Occupied Bandwidth (MHz)	
		Chain 0	Chain 1
36	5180	16.92	16.68
40	5200	16.92	16.68
48	5240	16.92	16.68
149	5745	16.87	16.70
157	5785	16.92	16.80
165	5825	16.80	16.56

802.11n (HT20)

Chan.	Freq. (MHz)	Occupied Bandwidth (MHz)	
		Chain 0	Chain 1
36	5180	17.88	17.88
40	5200	17.88	17.88
48	5240	18.00	17.88
149	5745	18.00	17.76
157	5785	18.00	17.76
165	5825	18.00	18.00

802.11n (HT40)

Chan.	Freq. (MHz)	Occupied Bandwidth (MHz)	
		Chain 0	Chain 1
38	5190	37.44	36.96
46	5230	37.44	37.08
151	5755	37.44	37.08
159	5795	37.44	37.32

Spectrum Plot of Worst Value

802.11a

802.11n (HT20)

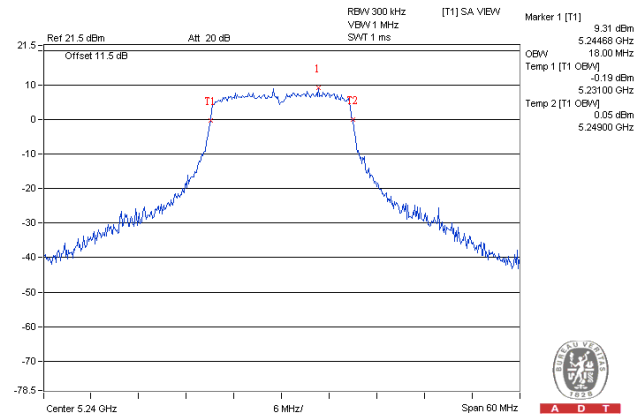
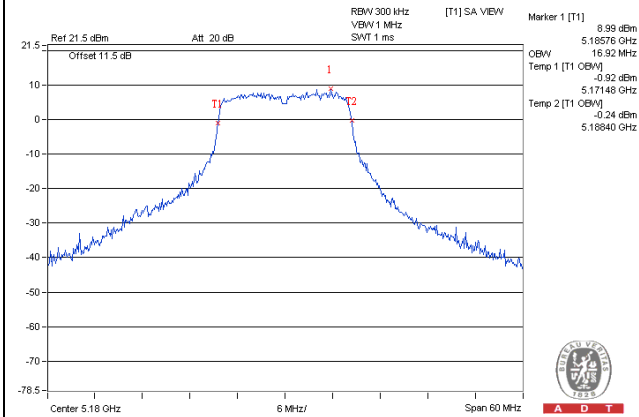

802.11n (HT40)

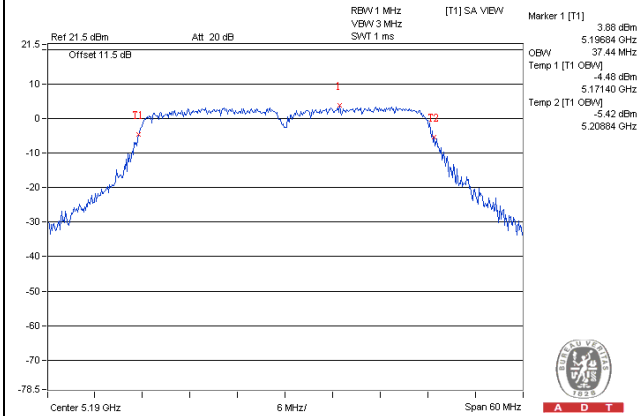

4.4 Peak Power Spectral Density Measurement

4.4.1 Limits of Peak Power Spectral Density Measurement

Operation Band	EUT Category		LIMIT
U-NII-1		Outdoor Access Point	17dBm/ MHz
		Fixed point-to-point Access Point	
	√	Indoor Access Point	11dBm/ MHz
		Mobile and Portable client device	
U-NII-2A	---		11dBm/ MHz
U-NII-2C	---		11dBm/ MHz
U-NII-3	√		30dBm/ 500kHz

4.4.2 Test Setup

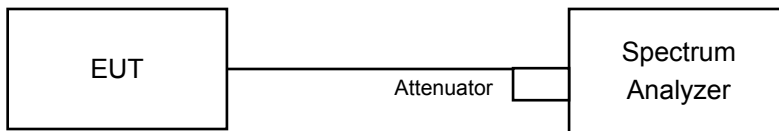

4.4.3 Test Instruments

Refer to section 4.1.2 to get information of above instrument.

4.4.4 Test Procedures

For U-NII-1 band:

Duty cycle >98%, using method SA-1

- a. Set span to encompass the entire emission bandwidth (EBW) of the signal.
- b. Set RBW = 1 MHz, Set VBW \geq 3 MHz, Detector = RMS
- c. Sweep time = auto, trigger set to "free run".
- d. Trace average at least 100 traces in power averaging mode.
- e. Record the max value

Duty cycle <98%, using method SA-2

- a. Set span to encompass the entire emission bandwidth (EBW) of the signal.
- b. Set RBW = 1 MHz, Set VBW \geq 3 MHz, Detector = RMS
- c. Sweep time = auto, trigger set to "free run".
- d. Trace average at least 100 traces in power averaging mode.
- e. Record the max value and add $10 \log (1/\text{duty cycle})$

For U-NII-3 band:

Duty cycle >98%

- a. Set span to encompass the entire emission bandwidth (EBW) of the signal.
- b. Set RBW = 300 kHz, Set VBW \geq 1 MHz, Detector = RMS
- c. Use the peak marker function to determine the maximum power level in any 300 kHz band segment within the fundamental EBW.
- d. Scale the observed power level to an equivalent value in 500 kHz by adjusting (reducing) the measured power by a bandwidth correction factor (BWCF) where $\text{BWCF} = 10 \log(500 \text{ kHz}/300 \text{ kHz})$
- e. Sweep time = auto, trigger set to "free run".
- f. Trace average at least 100 traces in power averaging mode.
- g. Record the max value

Duty cycle <98%

- a. Set span to encompass the entire emission bandwidth (EBW) of the signal.
- b. Set RBW = 300 kHz, Set VBW \geq 1 MHz, Detector = RMS
- c. Use the peak marker function to determine the maximum power level in any 300 kHz band segment within the fundamental EBW.
- d. Scale the observed power level to an equivalent value in 500 kHz by adjusting (reducing) the measured power by a bandwidth correction factor (BWCF) where $\text{BWCF} = 10 \log(500 \text{ kHz}/300 \text{ kHz})$
- e. Sweep time = auto, trigger set to "free run".
- f. Trace average at least 100 traces in power averaging mode.
- g. Record the max value and add $10 \log (1/\text{duty cycle})$

4.4.5 Deviation from Test Standard

No deviation.

4.4.6 EUT Operating Conditions

Same as Item 4.3.6.

4.4.7 Test Results

For U-NII-1 Band

802.11a

Chan.	Freq. (MHz)	PSD (dBm)		Total PSD (dBm)	Max. Limit (dBm)	Pass / Fail
		Chain 0	Chain 1			
36	5180	4.62	2.37	6.65	14.99	Pass
40	5200	4.98	4.22	7.62	14.99	Pass
48	5240	4.01	4.38	7.21	14.99	Pass

Note:

- Method 1 of power density measurement of KDB 662911 is using for calculating total power density. Total power density is summing entire spectra across corresponding frequency bins on the various outputs by computer.
- Directional gain = $5\text{dBi} + 10\log(2) = 8.01\text{dBi} > 6\text{dBi}$, so the power density limit shall be reduced to $17-(8.01-6) = 14.99\text{dBm}$.

802.11n (HT20)

Chan.	Freq. (MHz)	PSD (dBm)		Total PSD w/o duty factor (dBm)	Duty factor	Total PSD with duty factor (dBm)	Max. Limit (dBm)	Pass / Fail
		Chain 0	Chain 1					
36	5180	1.22	2.08	4.68	0.25	4.93	14.99	Pass
40	5200	4.64	4.45	7.55	0.25	7.80	14.99	Pass
48	5240	4.25	4.76	7.52	0.25	7.77	14.99	Pass

Note:

- Method 1 of power density measurement of KDB 662911 is using for calculating total power density. Total power density is summing entire spectra across corresponding frequency bins on the various outputs by computer.
- Directional gain = $5\text{dBi} + 10\log(2) = 8.01\text{dBi} > 6\text{dBi}$, so the power density limit shall be reduced to $17-(8.01-6) = 14.99\text{dBm}$.
- Refer to section 3.3 for duty cycle spectrum plot.

802.11n (HT40)

Chan.	Freq. (MHz)	PSD (dBm)		Total PSD w/o duty factor (dBm)	Duty factor	Total PSD with duty factor (dBm)	Max. Limit (dBm)	Pass / Fail
		Chain 0	Chain 1					
38	5190	-6.22	-8.16	-4.08	0.61	-3.47	14.99	Pass
46	5230	0.36	-0.57	2.93	0.61	3.54	14.99	Pass

Note:

- Method 1 of power density measurement of KDB 662911 is using for calculating total power density. Total power density is summing entire spectra across corresponding frequency bins on the various outputs by computer.
- Directional gain = $5\text{dBi} + 10\log(2) = 8.01\text{dBi} > 6\text{dBi}$, so the power density limit shall be reduced to $17-(8.01-6) = 14.99\text{dBm}$.
- Refer to section 3.3 for duty cycle spectrum plot.

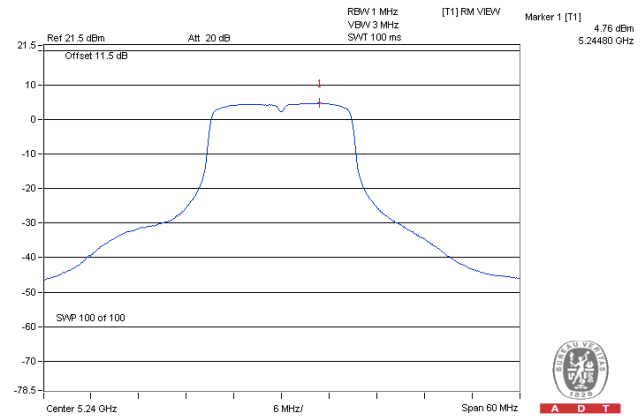
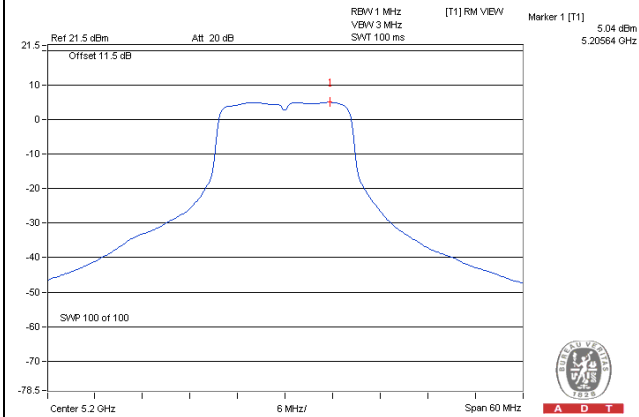
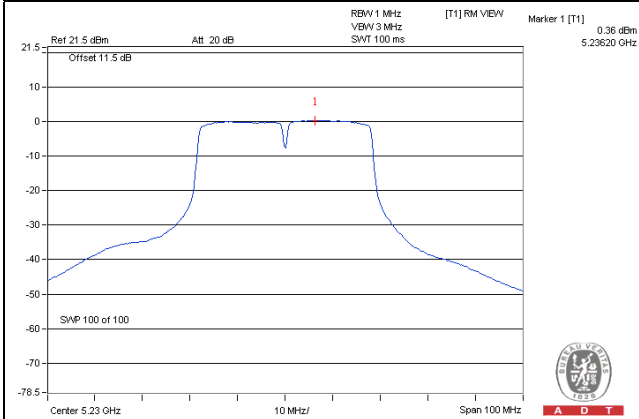
Spectrum Plot of Worst Value**802.11a / Chain 0 / CH 40****802.11n (HT20) / Chain 1 / CH 48****802.11n (HT40) / Chain 0 / CH 46**

For U-NII-3 Band

802.11a

TX chain	Chan.	Freq. (MHz)	PSD (dBm/300 kHz)	PSD (dBm/500 kHz)	10 log (N=2) dB	Total PSD (dBm/500 kHz)	Limit (dBm/500 kHz)	Pass / Fail
0	149	5745	-4.29	-2.07	3.01	0.94	27.99	Pass
	157	5785	-2.66	-0.44	3.01	2.57	27.99	Pass
	165	5825	-4.30	-2.08	3.01	0.93	27.99	Pass
1	149	5745	-6.11	-3.89	3.01	-0.88	27.99	Pass
	157	5785	-5.43	-3.21	3.01	-0.20	27.99	Pass
	165	5825	-7.39	-5.17	3.01	-2.16	27.99	Pass

Note:

- Method 1 of power density measurement of KDB 662911 is using for calculating total power density. Total power density is summing entire spectra across corresponding frequency bins on the various outputs by computer.
- Directional gain = $5\text{dBi} + 10\log(2) = 8.01\text{dBi} > 6\text{dBi}$, so the power density limit shall be reduced to $30 - (8.01 - 6) = 27.99\text{dBm}$.

802.11n (HT20)

TX chain	Chan.	Freq. (MHz)	PSD (dBm/300 kHz)	PSD (dBm/500 kHz)	10 log (N=2) dB	Duty factor	Total PSD (dBm/500 kHz)	Limit (dBm/500 kHz)	Pass / Fail
0	149	5745	-5.89	-3.67	3.01	0.25	-0.41	27.99	Pass
	157	5785	-3.80	-1.58	3.01	0.25	1.68	27.99	Pass
	165	5825	-5.88	-3.66	3.01	0.25	-0.40	27.99	Pass
1	149	5745	-8.09	-5.87	3.01	0.25	-2.61	27.99	Pass
	157	5785	-6.57	-4.35	3.01	0.25	-1.09	27.99	Pass
	165	5825	-8.20	-5.98	3.01	0.25	-2.72	27.99	Pass

Note:

- Method 1 of power density measurement of KDB 662911 is using for calculating total power density. Total power density is summing entire spectra across corresponding frequency bins on the various outputs by computer.
- Directional gain = $5\text{dBi} + 10\log(2) = 8.01\text{dBi} > 6\text{dBi}$, so the power density limit shall be reduced to $30 - (8.01 - 6) = 27.99\text{dBm}$.
- Refer to section 3.3 for duty cycle spectrum plot.

802.11n (HT40)

TX chain	Chan.	Freq. (MHz)	PSD (dBm/300 kHz)	PSD (dBm/500 kHz)	10 log (N=2) dB	Duty factor	Total PSD (dBm/500 kHz)	Limit (dBm/500 kHz)	Pass / Fail
0	151	5755	-15.22	-13.00	3.01	0.61	-9.38	27.99	Pass
	159	5795	-7.70	-5.48	3.01	0.61	-1.86	27.99	Pass
1	151	5755	-16.56	-14.34	3.01	0.61	-10.72	27.99	Pass
	159	5795	-10.63	-8.41	3.01	0.61	-4.79	27.99	Pass

Note:

- Method 1 of power density measurement of KDB 662911 is using for calculating total power density. Total power density is summing entire spectra across corresponding frequency bins on the various outputs by computer.
- Directional gain = $5\text{dBi} + 10\log(2) = 8.01\text{dBi} > 6\text{dBi}$, so the power density limit shall be reduced to $30 - (8.01 - 6) = 27.99\text{dBm}$.
- Refer to section 3.3 for duty cycle spectrum plot.

Spectrum Plot of Worst Value

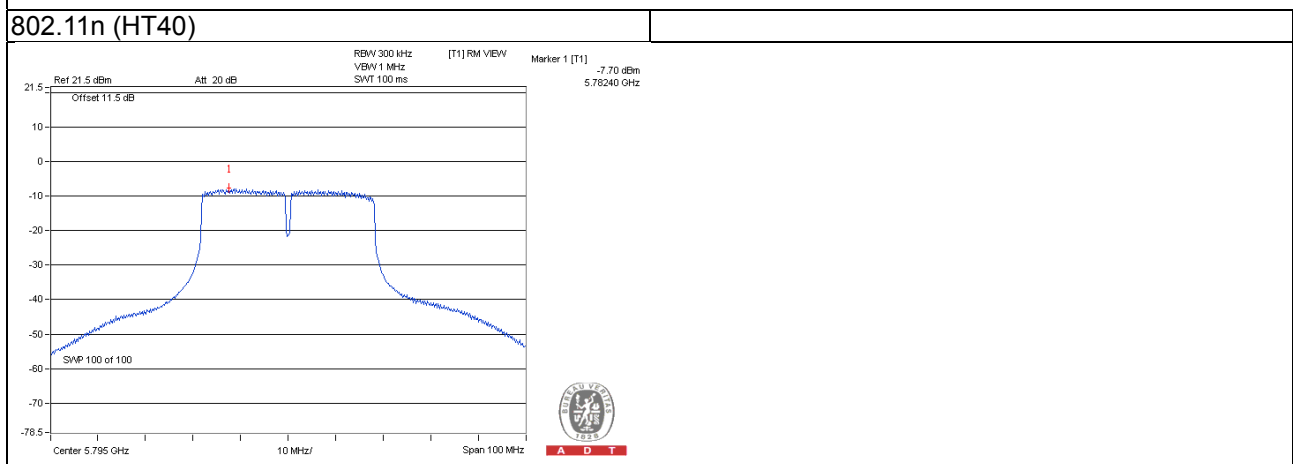
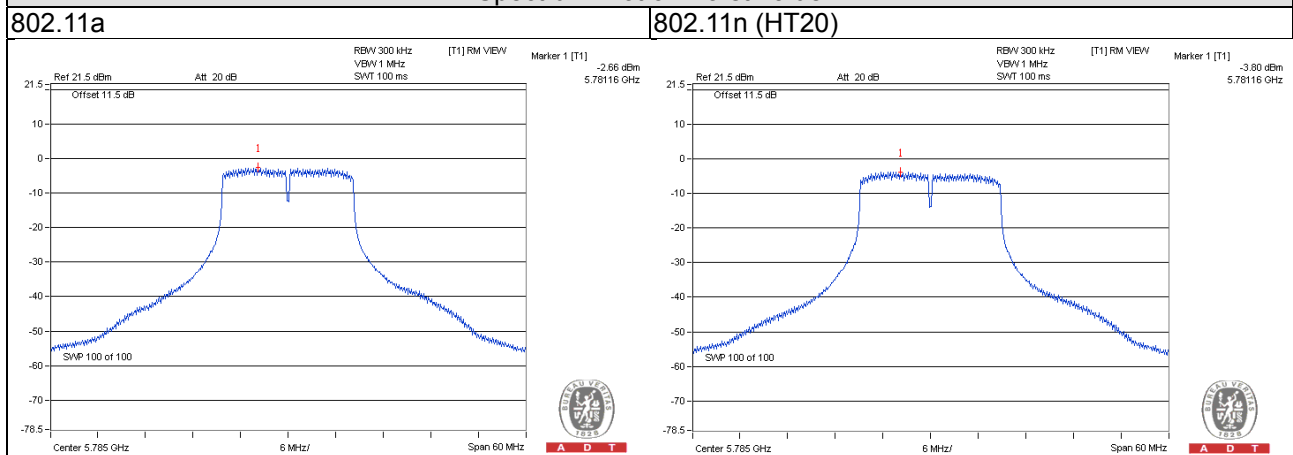

4.5 Frequency Stability

4.5.1 Limits of Frequency Stability Measurement

The frequency of the carrier signal shall be maintained within band of operation

4.5.2 Test Setup

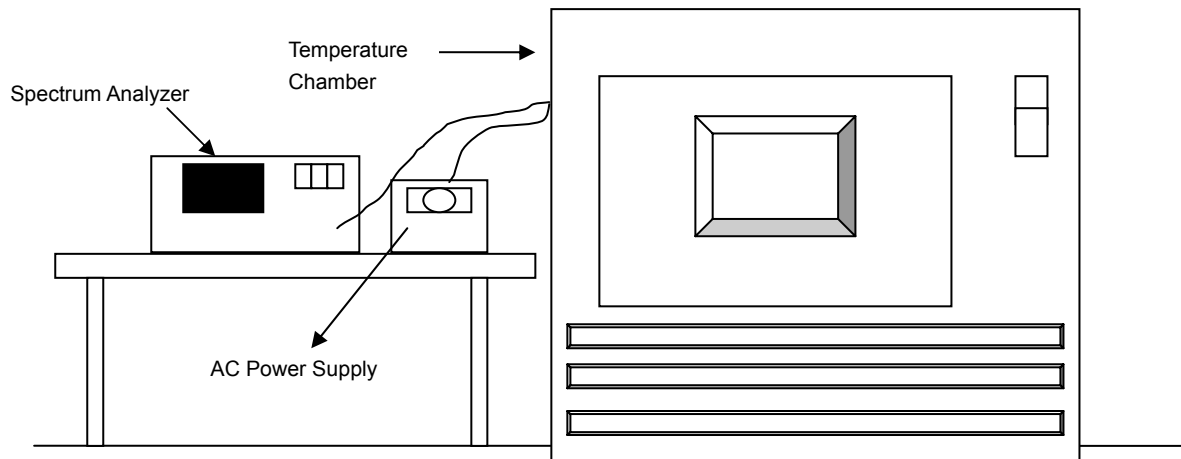

4.5.3 Test Instruments

Refer to section 4.1.2 to get information of above instrument.

4.5.4 Test Procedure

- a. The EUT was placed inside the environmental test chamber and powered by nominal AC voltage.
- b. Turn the EUT on and couple its output to a spectrum analyzer.
- c. Turn the EUT off and set the chamber to the highest temperature specified.
- d. Allow sufficient time (approximately 30 min) for the temperature of the chamber to stabilize, turn the EUT on and measure the operating frequency after 2, 5, and 10 minutes.
- e. Repeat step 2 and 3 with the temperature chamber set to the lowest temperature.
- f. The test chamber was allowed to stabilize at +20 degree C for a minimum of 30 minutes. The supply voltage was then adjusted on the EUT from 85% to 115% and the frequency record.

4.5.5 Deviation from Test Standard

No deviation.

4.5.6 EUT Operating Condition

Set the EUT transmit at un-modulation mode to test frequency stability.

4.5.7 Test Results

Frequency Stability Versus Temp.									
Operating Frequency: 5180MHz									
Temp. (°C)	Power Supply (Vac)	0 Minute		2 Minute		5 Minute		10 Minute	
		Measured Frequency (MHz)	Frequency Drift (%)	Measured Frequency (MHz)	Frequency Drift (%)	Measured Frequency (MHz)	Frequency Drift (%)	Measured Frequency (MHz)	Frequency Drift (%)
50	120	5179.9798	-0.00039	5179.9797	-0.00039	5179.9776	-0.00043	5179.9792	-0.00040
40	120	5179.9806	-0.00037	5179.979	-0.00041	5179.9799	-0.00039	5179.9784	-0.00042
30	120	5180.019	0.00037	5180.0168	0.00032	5180.0154	0.00030	5180.0185	0.00036
20	120	5180.0248	0.00048	5180.0208	0.00040	5180.0218	0.00042	5180.0227	0.00044
10	120	5179.9916	-0.00016	5179.9913	-0.00017	5179.9876	-0.00024	5179.9904	-0.00019
0	120	5180.0076	0.00015	5180.0044	0.00008	5180.0068	0.00013	5180.0051	0.00010
-10	120	5179.9875	-0.00024	5179.986	-0.00027	5179.9846	-0.00030	5179.9865	-0.00026
-20	120	5179.9779	-0.00043	5179.9794	-0.00040	5179.9779	-0.00043	5179.9811	-0.00036
-30	120	5179.9968	-0.00006	5179.9966	-0.00007	5179.9977	-0.00004	5179.997	-0.00006

Frequency Stability Versus Voltage									
Operating Frequency: 5180MHz									
Temp. (°C)	Power Supply (Vac)	0 Minute		2 Minute		5 Minute		10 Minute	
		Measured Frequency (MHz)	Frequency Drift (%)	Measured Frequency (MHz)	Frequency Drift (%)	Measured Frequency (MHz)	Frequency Drift (%)	Measured Frequency (MHz)	Frequency Drift (%)
20	138	5180.0248	0.00048	5180.0211	0.00041	5180.0226	0.00044	5180.0223	0.00043
	120	5180.0248	0.00048	5180.0208	0.00040	5180.0218	0.00042	5180.0227	0.00044
	102	5180.0241	0.00047	5180.0213	0.00041	5180.0216	0.00042	5180.0233	0.00045

4.6 6dB Bandwidth Measurement

4.6.1 Limits of 6dB Bandwidth Measurement

The minimum of 6dB Bandwidth Measurement is 0.5MHz.

4.6.2 Test Setup

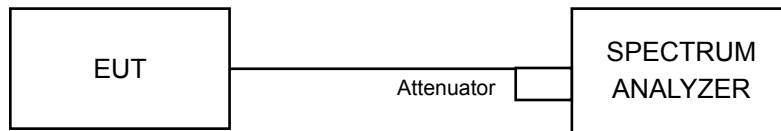

4.6.3 Test Instruments

Refer to section 4.1.2 to get information of above instrument.

4.6.4 Test Procedure

MEASUREMENT PROCEDURE REF

- Set resolution bandwidth (RBW) = 100kHz
- Set the video bandwidth (VBW) $\geq 3 \times$ RBW, Detector = Peak.
- Trace mode = max hold.
- Sweep = auto couple.
- Measure the maximum width of the emission that is constrained by the frequencies associated with the two amplitude points (upper and lower) that are attenuated by 6 dB relative to the maximum level measured in the fundamental emission

4.6.5 Deviation from Test Standard

No deviation.

4.6.6 EUT Operating Condition

The software provided by client to enable the EUT under transmission condition continuously at lowest, middle and highest channel frequencies individually.

4.6.7 Test Results

802.11a

Channel	Frequency (MHz)	6dB Bandwidth (MHz)		Minimum Limit (MHz)	Pass / Fail
		Chain 0	Chain 1		
149	5745	16.39	16.38	0.5	Pass
157	5785	16.40	16.40	0.5	Pass
165	5825	16.41	16.37	0.5	Pass

802.11n (HT20)

Channel	Frequency (MHz)	6dB Bandwidth (MHz)		Minimum Limit (MHz)	Pass / Fail
		Chain 0	Chain 1		
149	5745	17.64	17.34	0.5	Pass
157	5785	17.59	16.72	0.5	Pass
165	5825	17.37	17.61	0.5	Pass

802.11n (HT40)

Channel	Frequency (MHz)	6dB Bandwidth (MHz)		Minimum Limit (MHz)	Pass / Fail
		Chain 0	Chain 1		
151	5755	36.43	35.90	0.5	Pass
159	5795	36.25	35.89	0.5	Pass

Spectrum Plot of Worst Value

802.11a

802.11n (HT20)

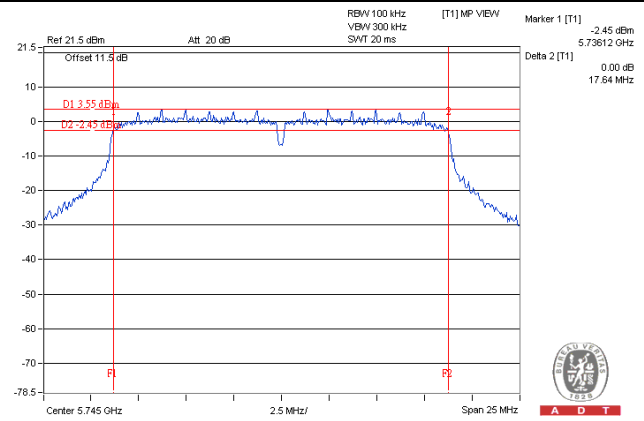
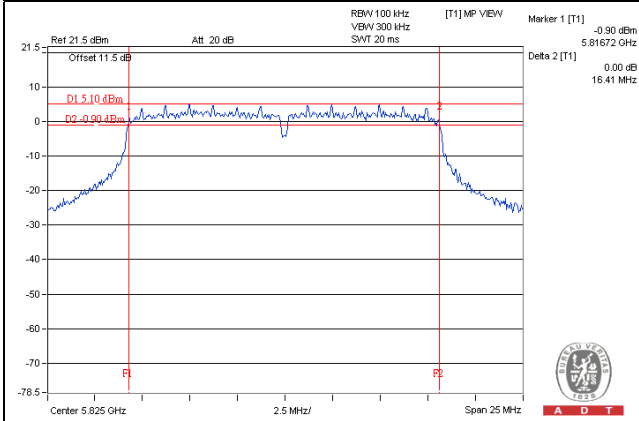

802.11n (HT40)

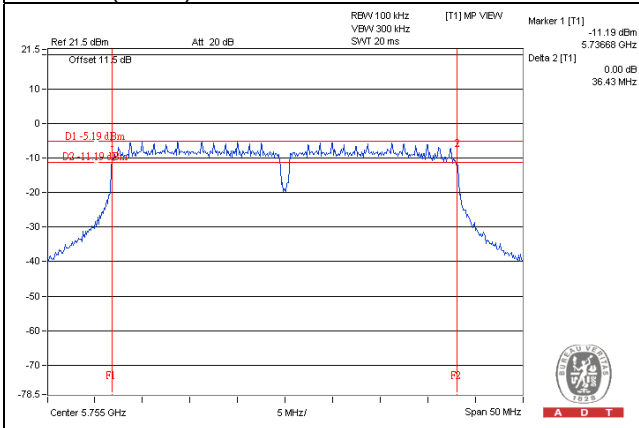

5 Pictures of Test Arrangements

Please refer to the attached file (Test Setup Photo).

Appendix – Information on the Testing Laboratories

We, Bureau Veritas Consumer Products Services (H.K.) Ltd., Taoyuan Branch, were founded in 1988 to provide our best service in EMC, Radio, Telecom and Safety consultation. Our laboratories are accredited and approved according to ISO/IEC 17025.

If you have any comments, please feel free to contact us at the following:

Linko EMC/RF Lab

Tel: 886-2-26052180

Fax: 886-2-26051924

Hsin Chu EMC/RF/Telecom Lab

Tel: 886-3-6668565

Fax: 886-3-6668323

Hwa Ya EMC/RF/Safety Lab

Tel: 886-3-3183232

Fax: 886-3-3270892

Email: service.adt@tw.bureauveritas.com

Web Site: www.bureauveritas-adt.com

The address and road map of all our labs can be found in our web site also.

--- END ---