

FCC Test Report

Report No.: RF170202C15-1

FCC ID: A8J-EMR3000V2

Test Model: EMR3000v2

Received Date: Feb. 02, 2017

Test Date: Feb. 13 ~ Feb. 22, 2017

Issued Date: Mar. 07, 2017

Applicant: EnGenius Technologies

Address: 1580 Scenic Avenue, Costa Mesa, CA92626

Issued By: Bureau Veritas Consumer Products Services (H.K.) Ltd., Taoyuan Branch

Lab Address: No. 47-2, 14th Ling, Chia Pau Vil., Lin Kou Dist., New Taipei City, Taiwan

Test Location: No. 19, Hwa Ya 2nd Rd., Wen Hwa Vil., Kwei Shan Dist., Taoyuan City
33383, TAIWAN (R.O.C.)



This report is for your exclusive use. Any copying or replication of this report to or for any other person or entity, or use of our name or trademark, is permitted only with our prior written permission. This report sets forth our findings solely with respect to the test samples identified herein. The results set forth in this report are not indicative or representative of the quality or characteristics of the lot from which a test sample was taken or any similar or identical product specifically and expressly noted. Our report includes all of the tests requested by you and the results thereof based upon the information that you provided to us. You have 60 days from date of issuance of this report to notify us of any material error or omission caused by our negligence, provided, however, that such notice shall be in writing and shall specifically address the issue you wish to raise. A failure to raise such issue within the prescribed time shall constitute your unqualified acceptance of the completeness of this report, the tests conducted and the correctness of the report contents. Unless specific mention, the uncertainty of measurement has been explicitly taken into account to declare the compliance or non-compliance to the specification. The report must not be used by the client to claim product certification, approval, or endorsement by TAF or any government agencies.

Table of Contents

Release Control Record	4
1 Certificate of Conformity	5
2 Summary of Test Results	6
2.1 Measurement Uncertainty	6
2.2 Modification Record	6
3 General Information	7
3.1 General Description of EUT	7
3.2 Description of Test Modes	9
3.2.1 Test Mode Applicability and Tested Channel Detail	10
3.3 Duty Cycle of Test Signal	12
3.4 Description of Support Units	13
3.4.1 Configuration of System under Test	13
3.5 General Description of Applied Standard	14
4 Test Types and Results	15
4.1 Radiated Emission and Bandedge Measurement.....	15
4.1.1 Limits of Radiated Emission and Bandedge Measurement	15
4.1.2 Test Instruments	16
4.1.3 Test Procedure	17
4.1.4 Deviation from Test Standard	17
4.1.5 Test Setup.....	18
4.1.6 EUT Operating Condition	19
4.1.7 Test Results	20
4.2 Conducted Emission Measurement	39
4.2.1 Limits of Conducted Emission Measurement	39
4.2.2 Test Instruments	39
4.2.3 Test Procedure	40
4.2.4 Deviation from Test Standard	40
4.2.5 Test Setup.....	40
4.2.6 EUT Operating Condition	40
4.2.7 Test Results	41
4.3 Transmit Power Measurement	43
4.3.1 Limits of Transmit Power Measurement	43
4.3.2 Test Setup.....	43
4.3.3 Test Instruments	44
4.3.4 Test Procedure	44
4.3.5 Deviation from Test Standard	44
4.3.6 EUT Operating Condition	44
4.3.7 Test Result.....	45
4.4 Occupied Bandwidth Measurement	48
4.4.1 Test Setup.....	48
4.4.2 Test Instruments	48
4.4.3 Test Procedure	48
4.4.4 Test Results	49
4.5 Peak Power Spectral Density Measurement	51
4.5.1 Limits of Peak Power Spectral Density Measurement	51
4.5.2 Test Setup.....	51
4.5.3 Test Instruments	51
4.5.4 Test Procedure	51
4.5.5 Deviation from Test Standard	52
4.5.6 EUT Operating Condition	52
4.5.7 Test Results	53
4.6 Frequency Stability Measurement	57
4.6.1 Limits of Frequency Stability Measurement	57

4.6.2	Test Setup.....	57
4.6.3	Test Instruments	57
4.6.4	Test Procedure	57
4.6.5	Deviation from Test Standard	57
4.6.6	EUT Operating Condition	57
4.6.7	Test Results	58
4.7	6dB Bandwidth Measurement.....	59
4.7.1	Limits of 6dB Bandwidth Measurement.....	59
4.7.2	Test Setup.....	59
4.7.3	Test Instruments	59
4.7.4	Test Procedure	59
4.7.5	Deviation from Test Standard	59
4.7.6	EUT Operating Condition	59
4.7.7	Test Results	60
5	Pictures of Test Arrangements.....	62
	Annex A- Radiated Out of Band Emission (OOBE) Measurement (For U-NII-3 band).....	63
	Appendix – Information on the Testing Laboratories	66

Release Control Record

Issue No.	Description	Date Issued
RF170202C15-1	Original release.	Mar. 07, 2017

1 Certificate of Conformity

Product: AC1200 Mesh Router

Brand: EnGenius

Test Model: EMR3000v2

Sample Status: Engineering sample

Applicant: EnGenius Technologies

Test Date: Feb. 13 ~ Feb. 22, 2017

Standard: 47 CFR FCC Part 15, Subpart E (Section 15.407)
ANSI C63.10:2013

The above equipment has been tested by **Bureau Veritas Consumer Products Services (H.K.) Ltd., Taoyuan Branch**, and found compliance with the requirement of the above standards. The test record, data evaluation & Equipment Under Test (EUT) configurations represented herein are true and accurate accounts of the measurements of the sample's EMC characteristics under the conditions specified in this report.

Prepared by :

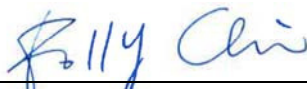

Polly Chien / Specialist

Date:

Mar. 07, 2017

Approved by :



Ken Liu / Senior Manager

Date:

Mar. 07, 2017

2 Summary of Test Results

47 CFR FCC Part 15, Subpart E (Section 15.407)			
FCC Clause	Test Item	Result	Remarks
15.407(b)(6)	AC Power Conducted Emissions	Pass	Meet the requirement of limit. Minimum passing margin is -18.11dB at 0.65388MHz
15.407(b)(1/2/3/4(i/ii)/6)	Radiated Emissions & Band Edge Measurement	Pass	Meet the requirement of limit. Minimum passing margin is -1.1dB at 15600.00MHz
15.407(a)(1/2/3)	Max Average Transmit Power	Pass	Meet the requirement of limit.
---	Occupied Bandwidth Measurement	-	Reference only.
15.407(a)(1/2/3)	Peak Power Spectral Density	Pass	Meet the requirement of limit.
15.407(e)	6dB bandwidth	Pass	Meet the requirement of limit. (U-NII-3 Band only)
15.407(g)	Frequency Stability	Pass	Meet the requirement of limit.
15.203	Antenna Requirement	Pass	Antenna connector is IPEX not a standard connector.

*For U-NII-3 band compliance with rule part 15.407(b)(4)(i), the OOB test plots were recorded in Annex A.

2.1 Measurement Uncertainty

Where relevant, the following measurement uncertainty levels have been estimated for tests performed on the EUT as specified in CISPR 16-4-2:

Measurement	Frequency	Expanded Uncertainty (k=2) (\pm)
Conducted Emissions at mains ports	150kHz ~ 30MHz	2.44 dB
Radiated Emissions up to 1 GHz	30MHz ~ 200MHz	3.86 dB
	200MHz ~ 1000MHz	3.87 dB
Radiated Emissions above 1 GHz	1GHz ~ 18GHz	2.29 dB
	18GHz ~ 40GHz	2.29 dB

2.2 Modification Record

There were no modifications required for compliance.

3 General Information

3.1 General Description of EUT

Product	AC1200 Mesh Router
Brand	EnGenius
Test Model	EMR3000v2
Status of EUT	Engineering sample
Power Supply Rating	12Vdc from adapter
Modulation Type	256QAM, 64QAM, 16QAM, QPSK, BPSK for OFDM
Modulation Technology	OFDM
Transfer Rate	802.11a: 54.0/ 48.0/ 36.0/ 24.0/ 18.0/ 12.0/ 9.0/ 6.0Mbps 802.11n: up to 300Mbps 802.11ac: up to 867Mbps
Operating Frequency	5180 ~ 5240MHz & 5745 ~ 5825MHz
Number of Channel	5180 ~ 5240MHz: 4 for 802.11a, 802.11n (HT20), 802.11n (VHT20) 2 for 802.11n (HT40), 802.11n (VHT40) 1 for 802.11ac (VHT80) 5745 ~ 5825MHz: 5 for 802.11a, 802.11n (HT20), 802.11n (VHT20) 2 for 802.11n (HT40), 802.11n (VHT40) 1 for 802.11ac (VHT80)
Output Power	5180 ~ 5240MHz: 176.829mW 5745 ~ 5825MHz: 257.949mW
Antenna Type	Refer to Note
Antenna Connector	Refer to Note
Accessory Device	Adapter
Data Cable Supplied	0.45m RJ45 non-shielded cable without core

Note:

- The EUT incorporates a MIMO function. Physically, the EUT provides two completed transmitters and two receivers.

Modulation Mode	TX FUNCTION
802.11a	2TX
802.11n (HT20)	2TX
802.11n (HT40)	2TX
802.11ac (VHT20)	2TX
802.11ac (VHT40)	2TX
802.11ac (VHT80)	2TX

* The modulation and bandwidth are similar for 802.11n mode for HT20 / HT40 and 802.11ac mode for VHT20 / VHT40, therefore investigated worst case to representative mode in test report. (Final test mode refer section 3.2.1)

- The EUT uses following adapter.

Brand	Skypowercom
Model	ZZU1588-150120-2A
Input Power	100-240Vac, 1.5A Max, 50-60Hz
Output Power	12Vdc, 1.5A
Power Line	1.5m cable without core attached on adapter

3. The following antennas were provided to the EUT.

Ant. No.	1	2	3	4	5 (BT)
Ant. Type	PIFA				
Frequency (MHz)	2400-2500		5150-5850		2400-2500
Pesk Gain (dBi)	3.1	4.7	5.5	5.5	1.4
Connector	IPEX				NA

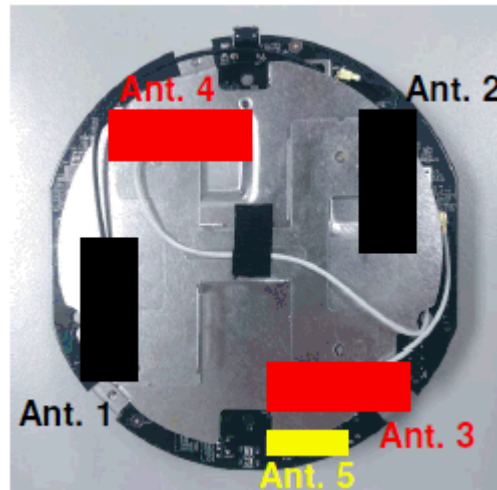
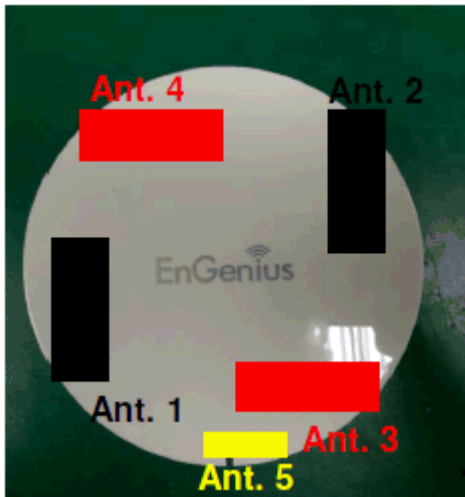

- Spurious emission of the simultaneous operation (2.4GHz, 5GHz and BT) has been evaluated and no non-compliance was found.
- The above EUT information is declared by manufacturer and for more detailed features description, please refer to the manufacturer's specifications or user's manual.

3.2 Description of Test Modes

For 5180 ~ 5240MHz

4 channels are provided for 802.11a, 802.11n (HT20), 802.11ac (VHT20):

Channel	Frequency	Channel	Frequency
36	5180 MHz	44	5220 MHz
40	5200 MHz	48	5240 MHz

2 channels are provided for 802.11n (HT40), 802.11ac (VHT40):

Channel	Frequency	Channel	Frequency
38	5190 MHz	46	5230 MHz

1 channel is provided for 802.11ac (VHT80):

Channel	Frequency
42	5210MHz

For 5745 ~ 5825MHz:

5 channels are provided for 802.11a, 802.11n (HT20), 802.11ac (VHT20):

Channel	Frequency	Channel	Frequency
149	5745MHz	161	5805MHz
153	5765MHz	165	5825MHz
157	5785MHz		

2 channels are provided for 802.11n (HT40), 802.11ac (VHT40):

Channel	Frequency	Channel	Frequency
151	5755MHz	159	5795MHz

1 channel is provided for 802.11ac (VHT80):

Channel	Frequency
155	5775MHz

3.2.1 Test Mode Applicability and Tested Channel Detail

EUT CONFIGURE MODE	APPLICABLE TO				DESCRIPTION
	RE \geq 1G	RE<1G	PLC	APCM	
-	√	√	√	√	-

Where RE \geq 1G: Radiated Emission above 1GHz RE<1G: Radiated Emission below 1GHz
 PLC: Power Line Conducted Emission APCM: Antenna Port Conducted Measurement

Note: The EUT had been pre-tested on the positioned of each 3 axis. The worst case was found when positioned on **Z-plane**.

Radiated Emission Test (Above 1GHz):

- Pre-Scan has been conducted to determine the worst-case mode from all possible combinations between available modulations, data rates and antenna ports (if EUT with antenna diversity architecture).
- Following channel(s) was (were) selected for the final test as listed below.

EUT CONFIGURE MODE	MODE	FREQ. BAND (MHz)	AVAILABLE CHANNEL	TESTED CHANNEL	MODULATION TECHNOLOGY	MODULATION TYPE	DATA RATE (Mbps)
-	802.11a	5180-5240	36 to 48	36, 40, 48	OFDM	BPSK	6.0
-	802.11n (HT20)		36 to 48	36, 40, 48	OFDM	BPSK	7.2
-	802.11n (HT40)		38 to 46	38, 46	OFDM	BPSK	15.0
-	802.11ac (VHT80)		42	42	OFDM	BPSK	58.5
-	802.11a	5745-5825	149 to 165	149, 157, 165	OFDM	BPSK	6.0
-	802.11n (HT20)		149 to 165	149, 157, 165	OFDM	BPSK	7.2
-	802.11n (HT40)		151 to 159	151, 159	OFDM	BPSK	15.0
-	802.11ac (VHT80)		155	155	OFDM	BPSK	58.5

Radiated Emission Test (Below 1GHz):

- Pre-Scan has been conducted to determine the worst-case mode from all possible combinations between available modulations, data rates and antenna ports (if EUT with antenna diversity architecture).
- Following channel(s) was (were) selected for the final test as listed below.

EUT CONFIGURE MODE	MODE	FREQ. BAND (MHz)	AVAILABLE CHANNEL	TESTED CHANNEL	MODULATION TECHNOLOGY	MODULATION TYPE	DATA RATE (Mbps)
-	802.11n (HT20)	5180-5240	36 to 48	149	OFDM	BPSK	7.2
	802.11n (HT20)	5745-5825	149 to 165		OFDM	BPSK	7.2

Power Line Conducted Emission Test:

- Pre-Scan has been conducted to determine the worst-case mode from all possible combinations between available modulations, data rates and antenna ports (if EUT with antenna diversity architecture).
- Following channel(s) was (were) selected for the final test as listed below.

EUT CONFIGURE MODE	MODE	FREQ. BAND (MHz)	AVAILABLE CHANNEL	TESTED CHANNEL	MODULATION TECHNOLOGY	MODULATION TYPE	DATA RATE (Mbps)
-	802.11n (HT20)	5180-5240	36 to 48	149	OFDM	BPSK	7.2
	802.11n (HT20)	5745-5825	149 to 165		OFDM	BPSK	7.2

Antenna Port Conducted Measurement:

- This item includes all test value of each mode, but only includes spectrum plot of worst value of each mode.
- Pre-Scan has been conducted to determine the worst-case mode from all possible combinations between available modulations, data rates and antenna ports (if EUT with antenna diversity architecture).
- Following channel(s) was (were) selected for the final test as listed below.

EUT CONFIGURE MODE	MODE	FREQ. BAND (MHz)	AVAILABLE CHANNEL	TESTED CHANNEL	MODULATION TECHNOLOGY	MODULATION TYPE	DATA RATE (Mbps)
-	802.11a	5180-5240	36 to 48	36, 40, 48	OFDM	BPSK	6.0
-	802.11n (HT20)		36 to 48	36, 40, 48	OFDM	BPSK	7.2
-	802.11n (HT40)		38 to 46	38, 46	OFDM	BPSK	15.0
-	802.11ac (VHT80)		42	42	OFDM	BPSK	58.5
-	802.11a	5745-5825	149 to 165	149, 157, 165	OFDM	BPSK	6.0
-	802.11n (HT20)		149 to 165	149, 157, 165	OFDM	BPSK	7.2
-	802.11n (HT40)		151 to 159	151, 159	OFDM	BPSK	15.0
-	802.11ac (VHT80)		155	155	OFDM	BPSK	58.5

Test Condition:

APPLICABLE TO	ENVIRONMENTAL CONDITIONS	INPUT POWER	TESTED BY
RE≥1G	20deg. C, 66%RH	120Vac, 60Hz	James Yang, Jones Chang, Bayu Chen
RE<1G	19deg. C, 64%RH	120Vac, 60Hz	Jones Chang
PLC	20deg. C, 67%RH	120Vac, 60Hz	Jones Chang
APCM	25deg. C, 60%RH	120Vac, 60Hz	Leo Tsai

3.3 Duty Cycle of Test Signal

Duty cycle of test signal is < 98 %, duty factor is required

802.11a: Duty cycle = $2.027/2.122 = 0.955$, Duty factor = $10 * \log(1/0.955) = 0.20$

802.11n (HT20): Duty cycle = $1.875/2.040 = 0.919$, Duty factor = $10 * \log(1/0.919) = 0.37$

802.11n (HT40): Duty cycle = $0.922/1.002 = 0.920$, Duty factor = $10 * \log(1/0.920) = 0.36$

802.11ac (VHT80): Duty cycle = $4.120/4.220 = 0.976$, Duty factor = $10 * \log(1/0.976) = 0.11$

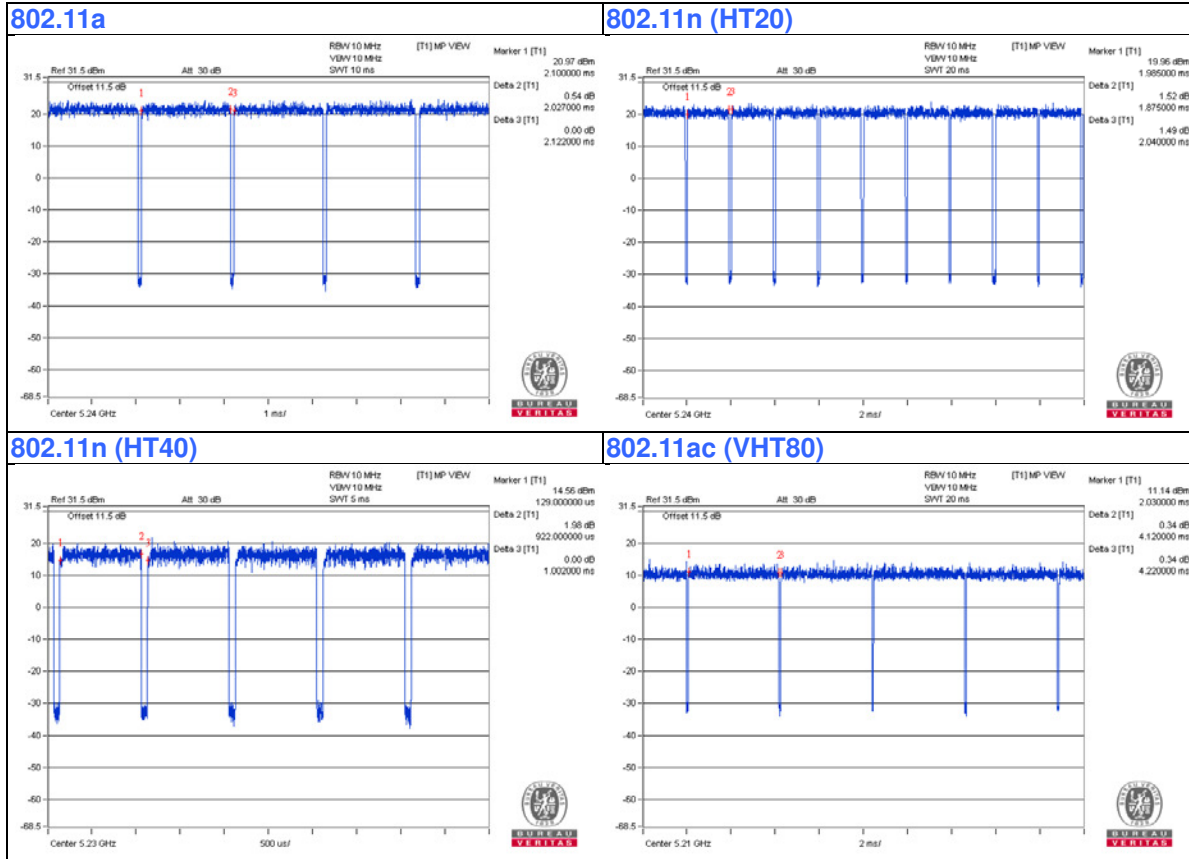

3.4 Description of Support Units

The EUT has been tested as an independent unit together with other necessary accessories or support units. The following support units or accessories were used to form a representative test configuration during the tests.

ID	Product	Brand	Model No.	Serial No.	FCC ID	Remarks
A.	Notebook	DELL	E5410	1HC2XM1	FCC DoC Approved	-
B.	USB Flash	HP	v250W	01	N/A	-
C.	Load	N/A	N/A	N/A	N/A	-

Note:

1. All power cords of the above support units are non-shielded (1.8m).
2. Item A acted as a communication partner to transfer data.

ID	Descriptions	Qty.	Length (m)	Shielding (Yes/No)	Cores (Qty.)	Remarks
1.	LAN cable	1	1.2	N	0	-
2.	LAN cable	1	3	N	0	-

3.4.1 Configuration of System under Test

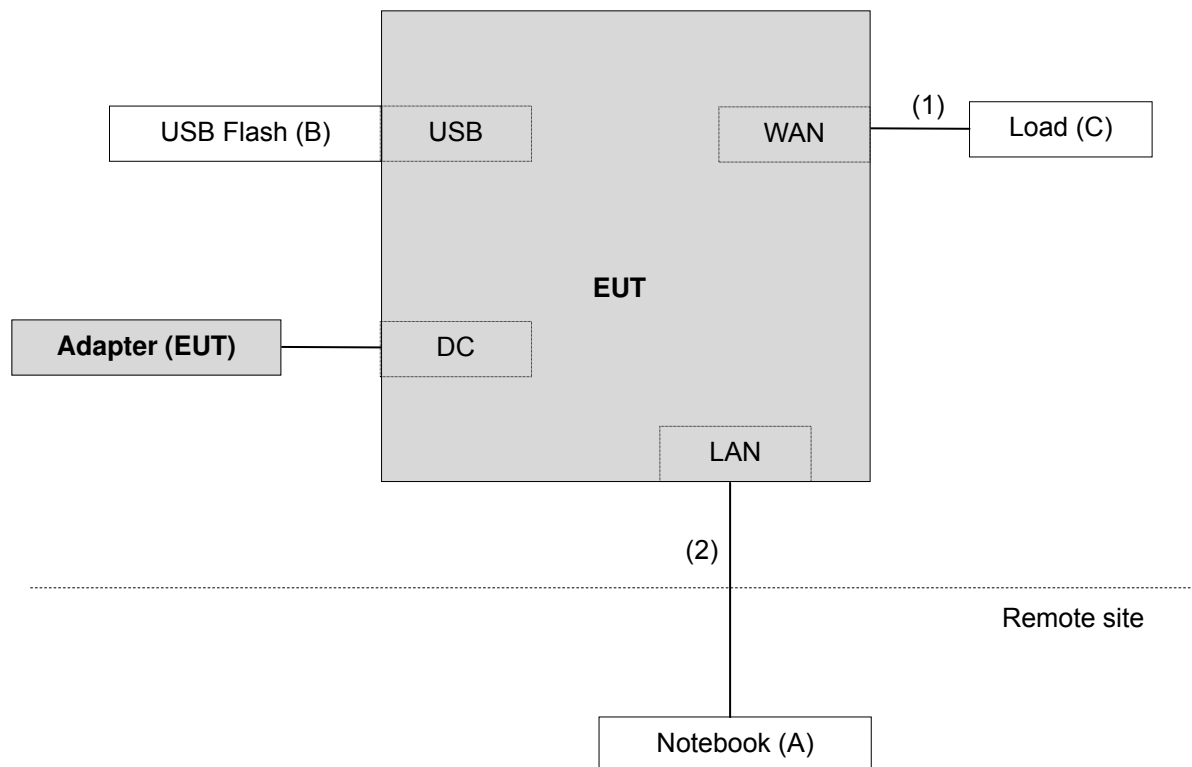

3.5 General Description of Applied Standard

The EUT is a RF Product. According to the specifications of the manufacturer, it must comply with the requirements of the following standards:

FCC Part 15, Subpart E (15.407)

KDB 789033 D02 General UNII Test Procedure New Rules v01r03

KDB 662911 D01 Multiple Transmitter Output v02r01

ANSI C63.10-2013

All test items have been performed and recorded as per the above standards.

Note: The EUT is also considered as a kind of computer peripheral, because the connection to computer is necessary for typical use. It has been verified to comply with the requirements of FCC Part 15, Subpart B, Class B (DoC). The test report has been issued separately.

4 Test Types and Results

4.1 Radiated Emission and Bandedge Measurement

4.1.1 Limits of Radiated Emission and Bandedge Measurement

Radiated emissions which fall in the restricted bands must comply with the radiated emission limits specified as below table.

Frequencies (MHz)	Field Strength (microvolts/meter)	Measurement Distance (meters)
0.009 ~ 0.490	2400/F(kHz)	300
0.490 ~ 1.705	24000/F(kHz)	30
1.705 ~ 30.0	30	30
30 ~ 88	100	3
88 ~ 216	150	3
216 ~ 960	200	3
Above 960	500	3

NOTE:

- The lower limit shall apply at the transition frequencies.
- Emission level (dBuV/m) = 20 log Emission level (uV/m).
- For frequencies above 1000MHz, the field strength limits are based on average detector, however, the peak field strength of any emission shall not exceed the maximum permitted average limits, specified above by more than 20dB under any condition of modulation.

Limits of unwanted emission out of the restricted bands

Applicable To		Limit	
789033 D02 General UNII Test Procedure New Rules v01r03		Field Strength at 3m	
		PK:74 (dBµV/m)	AV:54 (dBµV/m)
Frequency Band	Applicable To	EIRP Limit	Equivalent Field Strength at 3m
5150~5250 MHz	15.407(b)(1)	PK:-27 (dBm/MHz)	PK:68.2(dBµV/m)
5250~5350 MHz	15.407(b)(2)		
5470~5725 MHz	15.407(b)(3)		
5725~5850 MHz	<input checked="" type="checkbox"/> 15.407(b)(4)(i)	PK:-27 (dBm/MHz) ^{*1} PK:10 (dBm/MHz) ^{*2} PK:15.6 (dBm/MHz) ^{*3} PK:27 (dBm/MHz) ^{*4}	PK: 68.2(dBµV/m) ^{*1} PK:105.2 (dBµV/m) ^{*2} PK: 110.8(dBµV/m) ^{*3} PK:122.2 (dBµV/m) ^{*4}
	<input type="checkbox"/> 15.407(b)(4)(ii)	Emission limits in section 15.247(d)	
^{*1} beyond 75 MHz or more above of the band edge.		^{*2} below the band edge increasing linearly to 10 dBm/MHz at 25 MHz above.	
^{*3} below the band edge increasing linearly to a level of 15.6 dBm/MHz at 5 MHz above.		^{*4} from 5 MHz above or below the band edge increasing linearly to a level of 27 dBm/MHz at the band edge.	

Note: The following formula is used to convert the equipment isotropic radiated power (eirp) to field strength:

$$E = \frac{1000000\sqrt{30P}}{3} \mu\text{V/m, where P is the eirp (Watts).}$$

4.1.2 Test Instruments

Description & Manufacturer	Model No.	Serial No.	Cal. Date	Cal. Due
Test Receiver ROHDE & SCHWARZ	ESIB7	100187	Apr. 18, 2016	Apr. 17, 2017
Spectrum Analyzer ROHDE & SCHWARZ	FSP40	100041	Nov. 16, 2016	Nov. 15, 2017
BILOG Antenna SCHWARZBECK	VULB9168	9168-171	Dec. 28, 2016	Dec. 27, 2017
HORN Antenna SCHWARZBECK	9120D	209	Dec. 27, 2016	Dec. 26, 2017
HORN Antenna SCHWARZBECK	BBHA 9170	BBHA9170241	Dec. 14, 2016	Dec. 13, 2017
Loop Antenna	EM-6879	269	Aug. 11, 2016	Aug. 10, 2017
Preamplifier Agilent	8447D	2944A10738	Aug. 22, 2016	Aug. 21, 2017
Preamplifier Agilent	8449B	3008A01964	Aug. 22, 2016	Aug. 21, 2017
RF signal cable HUBER+SUHNER	SUCOFLEX 104	Cable-CH3-03 (214378)	Aug. 22, 2016	Aug. 21, 2017
RF signal cable HUBER+SUHNER	SUCOFLEX 106	Cable-CH3-03 (309224+12738)	Aug. 22, 2016	Aug. 21, 2017
Software BV ADT	ADT_Radiated_ V7.6.15.9.4	NA	NA	NA
Antenna Tower inn-co GmbH	MA 4000	013303	NA	NA
Antenna Tower Controller BV ADT	AT100	AT93021702	NA	NA
Turn Table BV ADT	TT100	TT93021702	NA	NA
Turn Table Controller BV ADT	SC100	SC93021702	NA	NA
26GHz ~ 40GHz Amplifier	EM26400	815221	Oct. 17, 2016	Oct. 16, 2017
High Speed Peak Power Meter	ML2495A	0824011	Jul. 09, 2016	Jul. 08, 2017
Power Sensor	MA2411B	0738171	Jul. 09, 2016	Jul. 08, 2017
WIT Standard Temperature And Humidity Chamber	TH-4S-C	W981030	Jun. 08, 2016	Jun. 07, 2017

- Note: 1. The calibration interval of the above test instruments is 12 months and the calibrations are traceable to NML/ROC and NIST/USA.
 2. The test was performed in HwaYa Chamber 3.
 3. The horn antenna and preamplifier (model: 8449B) are used only for the measurement of emission frequency above 1GHz if tested.
 4. The FCC Site Registration No. is 988962.
 5. The IC Site Registration No. is IC 7450F-3.

4.1.3 Test Procedure

For Radiated emission below 30MHz

- a. The EUT was placed on the top of a rotating table 0.8 meters above the ground at a 3 meter chamber room. The table was rotated 360 degrees to determine the position of the highest radiation.
- b. The EUT was set 3 meters away from the interference-receiving antenna, which was mounted on the top of a variable-height antenna tower.
- c. Both X and Y axes of the antenna are set to make the measurement.
- d. For each suspected emission, the EUT was arranged to its worst case and the rotatable table was turned from 0 degrees to 360 degrees to find the maximum reading.
- e. The test-receiver system was set to Quasi-Peak Detect Function and Specified Bandwidth with Maximum Hold Mode.

NOTE:

1. The resolution bandwidth and video bandwidth of test receiver/spectrum analyzer is 9kHz at frequency below 30MHz.

For Radiated emission above 30MHz

- a. The EUT was placed on the top of a rotating table 0.8 meters (for 30MHz ~ 1GHz) / 1.5 meters (for above 1GHz) above the ground at 3 meter chamber room for test. The table was rotated 360 degrees to determine the position of the highest radiation.
- b. The EUT was set 3 meters away from the interference-receiving antenna, which was mounted on the top of a variable-height antenna tower.
- c. The height of antenna is varied from one meter to four meters above the ground to determine the maximum value of the field strength. Both horizontal and vertical polarizations of the antenna are set to make the measurement.
- d. For each suspected emission, the EUT was arranged to its worst case and then the antenna was tuned to heights from 1 meter to 4 meters and the rotatable table was turned from 0 degrees to 360 degrees to find the maximum reading.
- e. The test-receiver system was set to quasi-peak detect function and specified bandwidth with maximum hold mode when the test frequency is below 1 GHz.
- f. The test-receiver system was set to peak and average detect function and specified bandwidth with maximum hold mode when the test frequency is above 1 GHz. If the peak reading value also meets average limit, measurement with the average detector is unnecessary.

Note:

1. The resolution bandwidth and video bandwidth of test receiver/spectrum analyzer is 120kHz for Quasi-peak detection (QP) at frequency below 1GHz.
2. The resolution bandwidth of test receiver/spectrum analyzer is 1 MHz and the video bandwidth is 3 MHz for Peak detection (PK) at frequency above 1GHz.
3. The resolution bandwidth of test receiver/spectrum analyzer is 1MHz and the video bandwidth is $\geq 1/T$ (Duty cycle < 98%) or 10Hz (Duty cycle $\geq 98\%$) for Average detection (AV) at frequency above 1GHz.
4. All modes of operation were investigated and the worst-case emissions are reported.

4.1.4 Deviation from Test Standard

No deviation.

4.1.5 Test Setup

For Radiated emission below 30MHz

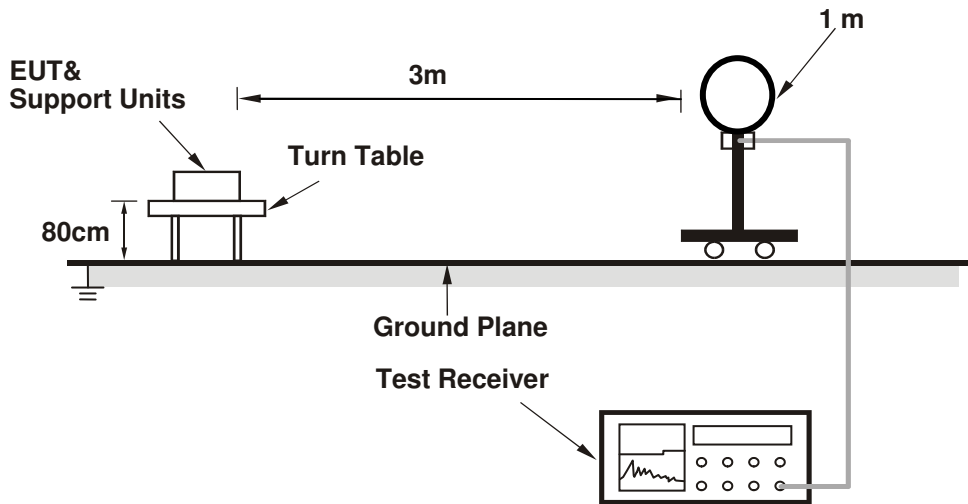

For Radiated emission 30MHz to 1GHz

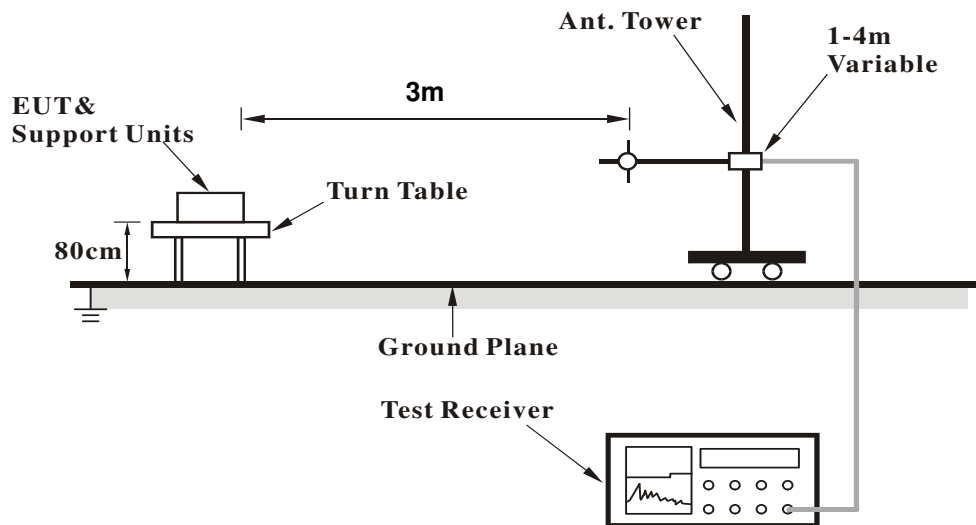

For Radiated emission above 1GHz

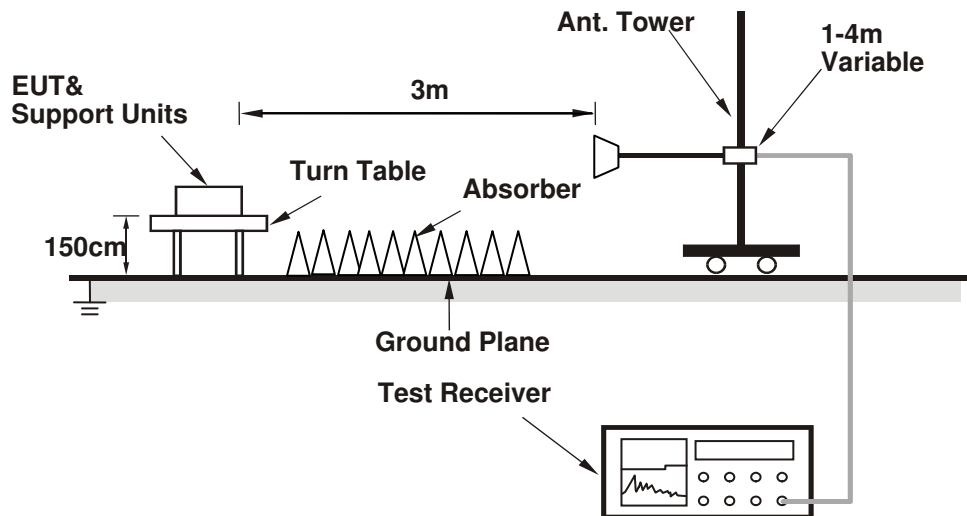

For the actual test configuration, please refer to the attached file (Test Setup Photo).

4.1.6 EUT Operating Condition

- a. Placed the EUT on the testing table.
- b. Prepared notebook to act as a communication partner and placed it outside of testing area.
- c. The communication partner connected with EUT via a RJ45 cable and ran a test program (provided by manufacturer) to enable EUT under transmission condition continuously at specific channel frequency.
- d. The communication partner sent data to EUT by command "PING".
- e. The necessary accessories enable the system in full functions.

4.1.7 Test Results

Above 1GHz Worst-case Data:

802.11a

CHANNEL	TX Channel 36	DETECTOR FUNCTION	Peak (PK) Average (AV)
FREQUENCY RANGE	1GHz ~ 40GHz		

ANTENNA POLARITY & TEST DISTANCE: HORIZONTAL AT 3 M								
NO.	FREQ. (MHz)	EMISSION LEVEL (dBuV/m)	LIMIT (dBuV/m)	MARGIN (dB)	ANTENNA HEIGHT (m)	TABLE ANGLE (Degree)	RAW VALUE (dBuV)	CORRECTION FACTOR (dB/m)
1	5150.00	70.0 PK	74.0	-4.0	2.12 H	286	69.20	0.80
2	5150.00	52.4 AV	54.0	-1.6	2.12 H	286	51.60	0.80
3	*5180.00	113.2 PK			2.41 H	53	74.50	38.70
4	*5180.00	102.8 AV			2.41 H	53	64.10	38.70
5	#10360.00	59.5 PK	74.0	-14.5	2.29 H	285	46.80	12.70
6	#10360.00	46.9 AV	54.0	-7.1	2.29 H	285	34.20	12.70
7	15540.00	64.5 PK	74.0	-9.5	2.42 H	137	50.10	14.40
8	15540.00	50.3 AV	54.0	-3.7	2.42 H	137	35.90	14.40
ANTENNA POLARITY & TEST DISTANCE: VERTICAL AT 3 M								
NO.	FREQ. (MHz)	EMISSION LEVEL (dBuV/m)	LIMIT (dBuV/m)	MARGIN (dB)	ANTENNA HEIGHT (m)	TABLE ANGLE (Degree)	RAW VALUE (dBuV)	CORRECTION FACTOR (dB/m)
1	5150.00	56.0 PK	74.0	-18.0	2.63 V	18	55.20	0.80
2	5150.00	48.3 AV	54.0	-5.7	2.63 V	18	47.50	0.80
3	*5180.00	108.3 PK			2.65 V	26	69.60	38.70
4	*5180.00	98.7 AV			2.65 V	26	60.00	38.70
5	#10360.00	59.8 PK	74.0	-14.2	2.84 V	358	47.10	12.70
6	#10360.00	46.0 AV	54.0	-8.0	2.84 V	358	33.30	12.70
7	15540.00	57.9 PK	74.0	-16.1	2.81 V	20	43.50	14.40
8	15540.00	45.0 AV	54.0	-9.0	2.81 V	20	30.60	14.40

REMARKS:

1. Emission Level(dBuV/m) = Raw Value(dBuV) + Correction Factor(dB/m)
2. Correction Factor(dB/m) = Antenna Factor(dB/m) + Cable Factor(dB)– Pre-Amplifier Factor(dB)
3. The other emission levels were very low against the limit.
4. Margin value = Emission Level – Limit value
5. " * ": Fundamental frequency.
6. " # ": The radiated frequency is out of the restricted band.

CHANNEL	TX Channel 40	DETECTOR FUNCTION	Peak (PK)
FREQUENCY RANGE	1GHz ~ 40GHz		Average (AV)

ANTENNA POLARITY & TEST DISTANCE: HORIZONTAL AT 3 M

NO.	FREQ. (MHz)	EMISSION LEVEL (dBuV/m)	LIMIT (dBuV/m)	MARGIN (dB)	ANTENNA HEIGHT (m)	TABLE ANGLE (Degree)	RAW VALUE (dBuV)	CORRECTION FACTOR (dB/m)
1	*5200.00	114.4 PK			1.87 H	287	75.70	38.70
2	*5200.00	104.1 AV			1.87 H	287	65.40	38.70
3	#10400.00	59.7 PK	74.0	-14.3	1.89 H	310	47.00	12.70
4	#10400.00	47.3 AV	54.0	-6.7	1.89 H	310	34.60	12.70
5	15600.00	66.1 PK	74.0	-7.9	2.14 H	128	51.60	14.50
6	15600.00	52.6 AV	54.0	-1.4	2.14 H	128	38.10	14.50

ANTENNA POLARITY & TEST DISTANCE: VERTICAL AT 3 M

NO.	FREQ. (MHz)	EMISSION LEVEL (dBuV/m)	LIMIT (dBuV/m)	MARGIN (dB)	ANTENNA HEIGHT (m)	TABLE ANGLE (Degree)	RAW VALUE (dBuV)	CORRECTION FACTOR (dB/m)
1	*5200.00	110.4 PK			1.96 V	13	71.70	38.70
2	*5200.00	100.6 AV			1.96 V	13	61.90	38.70
3	#10400.00	59.5 PK	74.0	-14.5	2.58 V	0	46.80	12.70
4	#10400.00	46.2 AV	54.0	-7.8	2.58 V	0	33.50	12.70
5	15720.00	62.1 PK	74.0	-11.9	2.04 V	221	48.20	13.90
6	15720.00	48.9 AV	54.0	-5.1	2.04 V	221	35.00	13.90

REMARKS:

1. Emission Level(dBuV/m) = Raw Value(dBuV) + Correction Factor(dB/m)
2. Correction Factor(dB/m) = Antenna Factor(dB/m) + Cable Factor(dB)– Pre-Amplifier Factor(dB)
3. The other emission levels were very low against the limit.
4. Margin value = Emission Level – Limit value
5. " * ": Fundamental frequency.
6. " # ": The radiated frequency is out of the restricted band.

CHANNEL	TX Channel 48	DETECTOR FUNCTION	Peak (PK)
FREQUENCY RANGE	1GHz ~ 40GHz		Average (AV)

ANTENNA POLARITY & TEST DISTANCE: HORIZONTAL AT 3 M

NO.	FREQ. (MHz)	EMISSION LEVEL (dBuV/m)	LIMIT (dBuV/m)	MARGIN (dB)	ANTENNA HEIGHT (m)	TABLE ANGLE (Degree)	RAW VALUE (dBuV)	CORRECTION FACTOR (dB/m)
1	*5240.00	115.0 PK			1.07 H	289	76.20	38.80
2	*5240.00	104.7 AV			1.07 H	289	65.90	38.80
3	5350.00	58.9 PK	74.0	-15.1	1.05 H	296	57.80	1.10
4	5350.00	45.4 AV	54.0	-8.6	1.05 H	296	44.30	1.10
5	#10480.00	60.3 PK	74.0	-13.7	2.17 H	285	46.80	13.50
6	#10480.00	47.5 AV	54.0	-6.5	2.17 H	285	34.00	13.50
7	15720.00	65.2 PK	74.0	-8.8	2.13 H	126	51.30	13.90
8	15720.00	52.3 AV	54.0	-1.7	2.13 H	126	38.40	13.90

ANTENNA POLARITY & TEST DISTANCE: VERTICAL AT 3 M

NO.	FREQ. (MHz)	EMISSION LEVEL (dBuV/m)	LIMIT (dBuV/m)	MARGIN (dB)	ANTENNA HEIGHT (m)	TABLE ANGLE (Degree)	RAW VALUE (dBuV)	CORRECTION FACTOR (dB/m)
1	*5240.00	110.3 PK			2.23 V	277	71.50	38.80
2	*5240.00	100.8 AV			2.23 V	277	62.00	38.80
3	5350.00	55.4 PK	74.0	-18.6	1.89 V	0	54.30	1.10
4	5350.00	44.6 AV	54.0	-9.4	1.89 V	0	43.50	1.10
5	#10480.00	59.1 PK	74.0	-14.9	2.79 V	359	45.60	13.50
6	#10480.00	46.3 AV	54.0	-7.7	2.79 V	359	32.80	13.50
7	15720.00	63.3 PK	74.0	-10.7	2.81 V	38	49.40	13.90
8	15720.00	50.7 AV	54.0	-3.3	2.81 V	38	36.80	13.90

REMARKS:

1. Emission Level(dBuV/m) = Raw Value(dBuV) + Correction Factor(dB/m)
2. Correction Factor(dB/m) = Antenna Factor(dB/m) + Cable Factor(dB)– Pre-Amplifier Factor(dB)
3. The other emission levels were very low against the limit.
4. Margin value = Emission Level – Limit value
5. " * ": Fundamental frequency.
6. " # ": The radiated frequency is out of the restricted band.

CHANNEL	TX Channel 149	DETECTOR FUNCTION	Peak (PK)
FREQUENCY RANGE	1GHz ~ 40GHz		Average (AV)

ANTENNA POLARITY & TEST DISTANCE: HORIZONTAL AT 3 M

NO.	FREQ. (MHz)	EMISSION LEVEL (dBuV/m)	LIMIT (dBuV/m)	MARGIN (dB)	ANTENNA HEIGHT (m)	TABLE ANGLE (Degree)	RAW VALUE (dBuV)	CORRECTION FACTOR (dB/m)
1	#5614.40	57.3 PK	68.2	-10.9	2.40 H	37	55.60	1.70
2	*5745.00	118.0 PK			2.40 H	37	78.10	39.90
3	*5745.00	107.7 AV			2.40 H	37	67.80	39.90
4	#5957.60	57.0 PK	68.2	-11.2	2.40 H	37	54.40	2.60
5	11490.00	62.3 PK	74.0	-11.7	2.23 H	17	47.80	14.50
6	11490.00	49.8 AV	54.0	-4.2	2.23 H	17	35.30	14.50

ANTENNA POLARITY & TEST DISTANCE: VERTICAL AT 3 M

NO.	FREQ. (MHz)	EMISSION LEVEL (dBuV/m)	LIMIT (dBuV/m)	MARGIN (dB)	ANTENNA HEIGHT (m)	TABLE ANGLE (Degree)	RAW VALUE (dBuV)	CORRECTION FACTOR (dB/m)
1	#5612.80	58.1 PK	68.2	-10.1	3.60 V	11	56.40	1.70
2	*5745.00	113.6 PK			3.60 V	11	73.70	39.90
3	*5745.00	103.4 AV			3.60 V	11	63.50	39.90
4	#5985.60	57.4 PK	68.2	-10.8	3.60 V	11	54.60	2.80
5	11490.00	60.5 PK	74.0	-13.5	2.70 V	23	46.00	14.50
6	11490.00	47.6 AV	54.0	-6.4	2.70 V	23	33.10	14.50

REMARKS:

1. Emission Level(dBuV/m) = Raw Value(dBuV) + Correction Factor(dB/m)
2. Correction Factor(dB/m) = Antenna Factor(dB/m) + Cable Factor(dB)– Pre-Amplifier Factor(dB)
3. The other emission levels were very low against the limit.
4. Margin value = Emission Level – Limit value
5. " * ": Fundamental frequency.
6. " # ": The radiated frequency is out of the restricted band.

CHANNEL	TX Channel 157	DETECTOR FUNCTION	Peak (PK)
FREQUENCY RANGE	1GHz ~ 40GHz		Average (AV)

ANTENNA POLARITY & TEST DISTANCE: HORIZONTAL AT 3 M

NO.	FREQ. (MHz)	EMISSION LEVEL (dBuV/m)	LIMIT (dBuV/m)	MARGIN (dB)	ANTENNA HEIGHT (m)	TABLE ANGLE (Degree)	RAW VALUE (dBuV)	CORRECTION FACTOR (dB/m)
1	#5605.60	58.2 PK	68.2	-10.0	2.36 H	41	56.50	1.70
2	*5785.00	117.9 PK			2.36 H	41	77.80	40.10
3	*5785.00	107.8 AV			2.36 H	41	67.70	40.10
4	#5975.20	57.7 PK	68.2	-10.5	2.36 H	41	54.90	2.80
5	11570.00	60.8 PK	74.0	-13.2	2.30 H	20	46.50	14.30
6	11570.00	48.3 AV	54.0	-5.7	2.30 H	20	34.00	14.30

ANTENNA POLARITY & TEST DISTANCE: VERTICAL AT 3 M

NO.	FREQ. (MHz)	EMISSION LEVEL (dBuV/m)	LIMIT (dBuV/m)	MARGIN (dB)	ANTENNA HEIGHT (m)	TABLE ANGLE (Degree)	RAW VALUE (dBuV)	CORRECTION FACTOR (dB/m)
1	#5616.00	56.4 PK	68.2	-11.8	3.69 V	19	54.70	1.70
2	*5785.00	114.0 PK			3.69 V	19	73.90	40.10
3	*5785.00	104.0 AV			3.69 V	19	63.90	40.10
4	#5984.00	56.6 PK	68.2	-11.6	3.69 V	19	53.80	2.80
5	11570.00	60.1 PK	74.0	-13.9	2.70 V	40	45.80	14.30
6	11570.00	47.3 AV	54.0	-6.7	2.70 V	40	33.00	14.30

REMARKS:

1. Emission Level(dBuV/m) = Raw Value(dBuV) + Correction Factor(dB/m)
2. Correction Factor(dB/m) = Antenna Factor(dB/m) + Cable Factor(dB)– Pre-Amplifier Factor(dB)
3. The other emission levels were very low against the limit.
4. Margin value = Emission Level – Limit value
5. " * ": Fundamental frequency.

CHANNEL	TX Channel 165	DETECTOR FUNCTION	Peak (PK)
FREQUENCY RANGE	1GHz ~ 40GHz		Average (AV)

ANTENNA POLARITY & TEST DISTANCE: HORIZONTAL AT 3 M

NO.	FREQ. (MHz)	EMISSION LEVEL (dBuV/m)	LIMIT (dBuV/m)	MARGIN (dB)	ANTENNA HEIGHT (m)	TABLE ANGLE (Degree)	RAW VALUE (dBuV)	CORRECTION FACTOR (dB/m)
1	#5629.60	57.8 PK	68.2	-10.4	2.37 H	20	56.10	1.70
2	*5825.00	116.9 PK			2.37 H	20	76.70	40.20
3	*5825.00	107.0 AV			2.37 H	20	66.80	40.20
4	#5956.00	57.9 PK	68.2	-10.3	2.37 H	20	55.30	2.60
5	11650.00	61.0 PK	74.0	-13.0	2.30 H	20	46.60	14.40
6	11650.00	48.5 AV	54.0	-5.5	2.30 H	20	34.10	14.40

ANTENNA POLARITY & TEST DISTANCE: VERTICAL AT 3 M

NO.	FREQ. (MHz)	EMISSION LEVEL (dBuV/m)	LIMIT (dBuV/m)	MARGIN (dB)	ANTENNA HEIGHT (m)	TABLE ANGLE (Degree)	RAW VALUE (dBuV)	CORRECTION FACTOR (dB/m)
1	#5639.20	57.8 PK	68.2	-10.4	3.45 V	326	56.10	1.70
2	*5825.00	115.3 PK			3.45 V	326	75.10	40.20
3	*5825.00	104.8 AV			3.45 V	326	64.60	40.20
4	#5979.20	58.5 PK	68.2	-9.7	3.45 V	326	55.70	2.80
5	11650.00	60.0 PK	74.0	-14.0	2.10 V	334	45.60	14.40
6	11650.00	47.0 AV	54.0	-7.0	2.10 V	334	32.60	14.40

REMARKS:

1. Emission Level(dBuV/m) = Raw Value(dBuV) + Correction Factor(dB/m)
2. Correction Factor(dB/m) = Antenna Factor(dB/m) + Cable Factor(dB)– Pre-Amplifier Factor(dB)
3. The other emission levels were very low against the limit.
4. Margin value = Emission Level – Limit value
5. " * ": Fundamental frequency.
6. " # ": The radiated frequency is out of the restricted band.

802.11n (HT20)

CHANNEL	TX Channel 36	DETECTOR FUNCTION	Peak (PK)
FREQUENCY RANGE	1GHz ~ 40GHz		Average (AV)

ANTENNA POLARITY & TEST DISTANCE: HORIZONTAL AT 3 M								
NO.	FREQ. (MHz)	EMISSION LEVEL (dBuV/m)	LIMIT (dBuV/m)	MARGIN (dB)	ANTENNA HEIGHT (m)	TABLE ANGLE (Degree)	RAW VALUE (dBuV)	CORRECTION FACTOR (dB/m)
1	5150.00	68.6 PK	74.0	-5.4	3.67 H	50	67.80	0.80
2	5150.00	52.4 AV	54.0	-1.6	3.67 H	50	51.60	0.80
3	*5180.00	112.1 PK			3.48 H	71	73.40	38.70
4	*5180.00	103.5 AV			3.48 H	71	64.80	38.70
5	#10360.00	58.9 PK	74.0	-15.1	2.49 H	323	46.20	12.70
6	#10360.00	46.2 AV	54.0	-7.8	2.49 H	323	33.50	12.70

ANTENNA POLARITY & TEST DISTANCE: VERTICAL AT 3 M								
NO.	FREQ. (MHz)	EMISSION LEVEL (dBuV/m)	LIMIT (dBuV/m)	MARGIN (dB)	ANTENNA HEIGHT (m)	TABLE ANGLE (Degree)	RAW VALUE (dBuV)	CORRECTION FACTOR (dB/m)
1	5150.00	63.2 PK	74.0	-10.8	3.50 V	20	62.40	0.80
2	5150.00	47.5 AV	54.0	-6.5	3.50 V	20	46.70	0.80
3	*5180.00	110.1 PK			3.47 V	0	71.40	38.70
4	*5180.00	100.1 AV			3.47 V	0	61.40	38.70
5	#10360.00	60.7 PK	74.0	-13.3	2.55 V	356	48.00	12.70
6	#10360.00	47.0 AV	54.0	-7.0	2.55 V	356	34.30	12.70

REMARKS:

1. Emission Level(dBuV/m) = Raw Value(dBuV) + Correction Factor(dB/m)
2. Correction Factor(dB/m) = Antenna Factor(dB/m) + Cable Factor(dB)– Pre-Amplifier Factor(dB)
3. The other emission levels were very low against the limit.
4. Margin value = Emission Level – Limit value
5. " * ": Fundamental frequency.
6. " # ": The radiated frequency is out of the restricted band.

CHANNEL	TX Channel 40	DETECTOR FUNCTION	Peak (PK)
FREQUENCY RANGE	1GHz ~ 40GHz		Average (AV)

ANTENNA POLARITY & TEST DISTANCE: HORIZONTAL AT 3 M

NO.	FREQ. (MHz)	EMISSION LEVEL (dBuV/m)	LIMIT (dBuV/m)	MARGIN (dB)	ANTENNA HEIGHT (m)	TABLE ANGLE (Degree)	RAW VALUE (dBuV)	CORRECTION FACTOR (dB/m)
1	*5200.00	113.2 PK			2.49 H	39	74.50	38.70
2	*5200.00	103.3 AV			2.49 H	39	64.60	38.70
3	#10400.00	60.9 PK	74.0	-13.1	2.48 H	288	48.20	12.70
4	#10400.00	47.5 AV	54.0	-6.5	2.48 H	288	34.80	12.70
5	15600.00	67.1 PK	74.0	-6.9	2.48 H	141	52.60	14.50
6	15600.00	52.9 AV	54.0	-1.1	2.48 H	141	38.40	14.50

ANTENNA POLARITY & TEST DISTANCE: VERTICAL AT 3 M

NO.	FREQ. (MHz)	EMISSION LEVEL (dBuV/m)	LIMIT (dBuV/m)	MARGIN (dB)	ANTENNA HEIGHT (m)	TABLE ANGLE (Degree)	RAW VALUE (dBuV)	CORRECTION FACTOR (dB/m)
1	*5200.00	110.7 PK			3.62 V	354	72.00	38.70
2	*5200.00	100.5 AV			3.62 V	354	61.80	38.70
3	#10400.00	59.4 PK	74.0	-14.6	2.62 V	359	46.70	12.70
4	#10400.00	46.6 AV	54.0	-7.4	2.62 V	359	33.90	12.70
5	15600.00	62.9 PK	74.0	-11.1	2.09 V	143	48.40	14.50
6	15600.00	50.1 AV	54.0	-3.9	2.09 V	143	35.60	14.50

REMARKS:

1. Emission Level(dBuV/m) = Raw Value(dBuV) + Correction Factor(dB/m)
2. Correction Factor(dB/m) = Antenna Factor(dB/m) + Cable Factor(dB)– Pre-Amplifier Factor(dB)
3. The other emission levels were very low against the limit.
4. Margin value = Emission Level – Limit value
5. " * ": Fundamental frequency.
6. " # ": The radiated frequency is out of the restricted band.

CHANNEL	TX Channel 48	DETECTOR FUNCTION	Peak (PK)
FREQUENCY RANGE	1GHz ~ 40GHz		Average (AV)

ANTENNA POLARITY & TEST DISTANCE: HORIZONTAL AT 3 M

NO.	FREQ. (MHz)	EMISSION LEVEL (dBuV/m)	LIMIT (dBuV/m)	MARGIN (dB)	ANTENNA HEIGHT (m)	TABLE ANGLE (Degree)	RAW VALUE (dBuV)	CORRECTION FACTOR (dB/m)
1	*5240.00	114.9 PK			2.38 H	49	76.10	38.80
2	*5240.00	104.5 AV			2.38 H	49	65.70	38.80
3	5350.00	57.6 PK	74.0	-16.4	1.20 H	226	56.50	1.10
4	5350.00	46.4 AV	54.0	-7.6	1.20 H	226	45.30	1.10
5	#10480.00	59.6 PK	74.0	-14.4	1.90 H	308	46.10	13.50
6	#10480.00	47.5 AV	54.0	-6.5	1.90 H	308	34.00	13.50
7	15720.00	66.0 PK	74.0	-8.0	2.46 H	135	52.10	13.90
8	15720.00	52.4 AV	54.0	-1.6	2.46 H	135	38.50	13.90

ANTENNA POLARITY & TEST DISTANCE: VERTICAL AT 3 M

NO.	FREQ. (MHz)	EMISSION LEVEL (dBuV/m)	LIMIT (dBuV/m)	MARGIN (dB)	ANTENNA HEIGHT (m)	TABLE ANGLE (Degree)	RAW VALUE (dBuV)	CORRECTION FACTOR (dB/m)
1	*5240.00	71.2 PK			2.72 V	19	70.30	0.90
2	*5240.00	60.8 AV			2.72 V	19	59.90	0.90
3	5350.00	55.7 PK	74.0	-18.3	2.72 V	22	54.60	1.10
4	5350.00	46.6 AV	54.0	-7.4	2.72 V	22	45.50	1.10
5	#10480.00	60.0 PK	74.0	-14.0	3.43 V	332	46.50	13.50
6	#10480.00	46.8 AV	54.0	-7.2	3.43 V	332	33.30	13.50
7	15720.00	61.7 PK	74.0	-12.3	2.75 V	18	47.80	13.90
8	15720.00	49.4 AV	54.0	-4.6	2.75 V	18	35.50	13.90

REMARKS:

1. Emission Level(dBuV/m) = Raw Value(dBuV) + Correction Factor(dB/m)
2. Correction Factor(dB/m) = Antenna Factor(dB/m) + Cable Factor(dB)– Pre-Amplifier Factor(dB)
3. The other emission levels were very low against the limit.
4. Margin value = Emission Level – Limit value
5. " * ": Fundamental frequency.
6. " # ": The radiated frequency is out of the restricted band.

CHANNEL	TX Channel 149	DETECTOR FUNCTION	Peak (PK)
FREQUENCY RANGE	1GHz ~ 40GHz		Average (AV)

ANTENNA POLARITY & TEST DISTANCE: HORIZONTAL AT 3 M								
NO.	FREQ. (MHz)	EMISSION LEVEL (dBuV/m)	LIMIT (dBuV/m)	MARGIN (dB)	ANTENNA HEIGHT (m)	TABLE ANGLE (Degree)	RAW VALUE (dBuV)	CORRECTION FACTOR (dB/m)
1	#5613.60	57.9 PK	68.2	-10.3	1.14 H	279	56.20	1.70
2	*5745.00	118.6 PK			1.14 H	279	78.70	39.90
3	*5745.00	108.3 AV			1.14 H	279	68.40	39.90
4	#5970.40	57.9 PK	68.2	-10.3	1.14 H	279	55.20	2.70
5	11490.00	61.8 PK	74.0	-12.2	2.50 H	20	47.30	14.50
6	11490.00	48.9 AV	54.0	-5.1	2.50 H	20	34.40	14.50

ANTENNA POLARITY & TEST DISTANCE: VERTICAL AT 3 M								
NO.	FREQ. (MHz)	EMISSION LEVEL (dBuV/m)	LIMIT (dBuV/m)	MARGIN (dB)	ANTENNA HEIGHT (m)	TABLE ANGLE (Degree)	RAW VALUE (dBuV)	CORRECTION FACTOR (dB/m)
1	#5620.00	56.7 PK	68.2	-11.5	3.72 V	338	55.00	1.70
2	*5745.00	113.7 PK			3.72 V	338	73.80	39.90
3	*5745.00	103.7 AV			3.72 V	338	63.80	39.90
4	#5960.00	57.9 PK	68.2	-10.3	3.72 V	338	55.30	2.60
5	11490.00	60.1 PK	74.0	-13.9	2.66 V	43	45.60	14.50
6	11490.00	48.1 AV	54.0	-5.9	2.66 V	43	33.60	14.50

REMARKS:

1. Emission Level(dBuV/m) = Raw Value(dBuV) + Correction Factor(dB/m)
2. Correction Factor(dB/m) = Antenna Factor(dB/m) + Cable Factor(dB)– Pre-Amplifier Factor(dB)
3. The other emission levels were very low against the limit.
4. Margin value = Emission Level – Limit value
5. " * ": Fundamental frequency.
6. " # ": The radiated frequency is out of the restricted band.

CHANNEL	TX Channel 157	DETECTOR FUNCTION	Peak (PK)
FREQUENCY RANGE	1GHz ~ 40GHz		Average (AV)

ANTENNA POLARITY & TEST DISTANCE: HORIZONTAL AT 3 M

NO.	FREQ. (MHz)	EMISSION LEVEL (dBuV/m)	LIMIT (dBuV/m)	MARGIN (dB)	ANTENNA HEIGHT (m)	TABLE ANGLE (Degree)	RAW VALUE (dBuV)	CORRECTION FACTOR (dB/m)
1	#5641.60	58.5 PK	68.2	-9.7	1.65 H	291	56.80	1.70
2	*5785.00	116.5 PK			1.65 H	292	76.40	40.10
3	*5785.00	106.6 AV			1.65 H	292	66.50	40.10
4	#5956.80	57.9 PK	68.2	-10.3	1.65 H	291	55.30	2.60
5	11570.00	61.8 PK	74.0	-12.2	2.20 H	22	47.50	14.30
6	11570.00	49.5 AV	54.0	-4.5	2.20 H	22	35.20	14.30

ANTENNA POLARITY & TEST DISTANCE: VERTICAL AT 3 M

NO.	FREQ. (MHz)	EMISSION LEVEL (dBuV/m)	LIMIT (dBuV/m)	MARGIN (dB)	ANTENNA HEIGHT (m)	TABLE ANGLE (Degree)	RAW VALUE (dBuV)	CORRECTION FACTOR (dB/m)
1	#5638.40	56.6 PK	68.2	-11.6	3.71 V	331	54.90	1.70
2	*5785.00	114.2 PK			3.70 V	19	74.10	40.10
3	*5785.00	103.9 AV			3.70 V	19	63.80	40.10
4	#5960.00	58.0 PK	68.2	-10.2	3.71 V	331	55.40	2.60
5	11570.00	59.7 PK	74.0	-14.3	2.56 V	50	45.40	14.30
6	11570.00	48.0 AV	54.0	-6.0	2.56 V	50	33.70	14.30

REMARKS:

1. Emission Level(dBuV/m) = Raw Value(dBuV) + Correction Factor(dB/m)
2. Correction Factor(dB/m) = Antenna Factor(dB/m) + Cable Factor(dB)– Pre-Amplifier Factor(dB)
3. The other emission levels were very low against the limit.
4. Margin value = Emission Level – Limit value
5. " * ": Fundamental frequency.

CHANNEL	TX Channel 165	DETECTOR FUNCTION	Peak (PK)
FREQUENCY RANGE	1GHz ~ 40GHz		Average (AV)

ANTENNA POLARITY & TEST DISTANCE: HORIZONTAL AT 3 M

NO.	FREQ. (MHz)	EMISSION LEVEL (dBuV/m)	LIMIT (dBuV/m)	MARGIN (dB)	ANTENNA HEIGHT (m)	TABLE ANGLE (Degree)	RAW VALUE (dBuV)	CORRECTION FACTOR (dB/m)
1	#5612.00	56.8 PK	68.2	-11.4	1.62 H	14	55.10	1.70
2	*5825.00	115.9 PK			1.62 H	14	75.70	40.20
3	*5825.00	105.6 AV			1.62 H	14	65.40	40.20
4	#5972.00	57.9 PK	68.2	-10.3	1.62 H	14	55.20	2.70
5	11650.00	62.4 PK	74.0	-11.6	2.30 H	30	48.00	14.40
6	11650.00	50.1 AV	54.0	-3.9	2.30 H	30	35.70	14.40

ANTENNA POLARITY & TEST DISTANCE: VERTICAL AT 3 M

NO.	FREQ. (MHz)	EMISSION LEVEL (dBuV/m)	LIMIT (dBuV/m)	MARGIN (dB)	ANTENNA HEIGHT (m)	TABLE ANGLE (Degree)	RAW VALUE (dBuV)	CORRECTION FACTOR (dB/m)
1	#5646.40	57.5 PK	68.2	-10.7	3.81 V	2	55.80	1.70
2	*5825.00	114.9 PK			3.81 V	2	74.70	40.20
3	*5825.00	104.7 AV			3.81 V	2	64.50	40.20
4	#5965.60	58.3 PK	68.2	-9.9	3.81 V	2	55.60	2.70
5	11650.00	59.7 PK	74.0	-14.3	2.70 V	56	45.30	14.40
6	11650.00	48.2 AV	54.0	-5.8	2.70 V	56	33.80	14.40

REMARKS:

1. Emission Level(dBuV/m) = Raw Value(dBuV) + Correction Factor(dB/m)
2. Correction Factor(dB/m) = Antenna Factor(dB/m) + Cable Factor(dB)– Pre-Amplifier Factor(dB)
3. The other emission levels were very low against the limit.
4. Margin value = Emission Level – Limit value
5. " * ": Fundamental frequency.
6. " # ": The radiated frequency is out of the restricted band.

802.11n (HT40)

CHANNEL	TX Channel 38	DETECTOR FUNCTION	Peak (PK)
FREQUENCY RANGE	1GHz ~ 40GHz		Average (AV)

ANTENNA POLARITY & TEST DISTANCE: HORIZONTAL AT 3 M

NO.	FREQ. (MHz)	EMISSION LEVEL (dBuV/m)	LIMIT (dBuV/m)	MARGIN (dB)	ANTENNA HEIGHT (m)	TABLE ANGLE (Degree)	RAW VALUE (dBuV)	CORRECTION FACTOR (dB/m)
1	5150.00	64.5 PK	74.0	-9.5	2.38 H	49	63.70	0.80
2	5150.00	52.6 AV	54.0	-1.4	2.38 H	49	51.80	0.80
3	*5190.00	109.0 PK			2.30 H	58	70.30	38.70
4	*5190.00	99.2 AV			2.30 H	58	60.50	38.70
5	#10380.00	59.1 PK	74.0	-14.9	1.84 H	306	46.30	12.80
6	#10380.00	46.2 AV	54.0	-7.8	1.84 H	306	33.40	12.80

ANTENNA POLARITY & TEST DISTANCE: VERTICAL AT 3 M

NO.	FREQ. (MHz)	EMISSION LEVEL (dBuV/m)	LIMIT (dBuV/m)	MARGIN (dB)	ANTENNA HEIGHT (m)	TABLE ANGLE (Degree)	RAW VALUE (dBuV)	CORRECTION FACTOR (dB/m)
1	5150.00	62.7 PK	74.0	-11.3	2.11 V	8	61.90	0.80
2	5150.00	49.4 AV	54.0	-4.6	2.11 V	8	48.60	0.80
3	*5190.00	104.9 PK			1.95 V	10	66.20	38.70
4	*5190.00	95.6 AV			1.95 V	10	56.90	38.70
5	#10380.00	59.2 PK	74.0	-14.8	2.77 V	11	46.40	12.80
6	#10380.00	47.1 AV	54.0	-6.9	2.77 V	11	34.30	12.80

REMARKS:

1. Emission Level(dBuV/m) = Raw Value(dBuV) + Correction Factor(dB/m)
2. Correction Factor(dB/m) = Antenna Factor(dB/m) + Cable Factor(dB)– Pre-Amplifier Factor(dB)
3. The other emission levels were very low against the limit.
4. Margin value = Emission Level – Limit value
5. " * ": Fundamental frequency.
6. " # ": The radiated frequency is out of the restricted band.

CHANNEL	TX Channel 46	DETECTOR FUNCTION	Peak (PK)
FREQUENCY RANGE	1GHz ~ 40GHz		Average (AV)

ANTENNA POLARITY & TEST DISTANCE: HORIZONTAL AT 3 M

NO.	FREQ. (MHz)	EMISSION LEVEL (dBuV/m)	LIMIT (dBuV/m)	MARGIN (dB)	ANTENNA HEIGHT (m)	TABLE ANGLE (Degree)	RAW VALUE (dBuV)	CORRECTION FACTOR (dB/m)
1	5150.00	66.7 PK	74.0	-7.3	1.36 H	296	65.90	0.80
2	5150.00	51.1 AV	54.0	-2.9	1.36 H	296	50.30	0.80
3	*5230.00	111.9 PK			1.20 H	290	73.10	38.80
4	*5230.00	101.6 AV			1.20 H	290	62.80	38.80
5	#10460.00	59.9 PK	74.0	-14.1	1.73 H	306	46.60	13.30
6	#10460.00	48.0 AV	54.0	-6.0	1.73 H	306	34.70	13.30
7	15690.00	64.9 PK	74.0	-9.1	2.31 H	133	50.60	14.30
8	15690.00	52.6 AV	54.0	-1.4	2.31 H	133	38.30	14.30

ANTENNA POLARITY & TEST DISTANCE: VERTICAL AT 3 M

NO.	FREQ. (MHz)	EMISSION LEVEL (dBuV/m)	LIMIT (dBuV/m)	MARGIN (dB)	ANTENNA HEIGHT (m)	TABLE ANGLE (Degree)	RAW VALUE (dBuV)	CORRECTION FACTOR (dB/m)
1	5150.00	56.1 PK	74.0	-17.9	2.11 V	6	55.30	0.80
2	5150.00	43.1 AV	54.0	-10.9	2.11 V	6	42.30	0.80
3	*5230.00	108.2 PK			3.60 V	0	69.40	38.80
4	*5230.00	97.9 AV			3.60 V	0	59.10	38.80
5	#10460.00	58.2 PK	74.0	-15.8	3.14 V	66	44.90	13.30
6	#10460.00	46.1 AV	54.0	-7.9	3.14 V	66	32.80	13.30
7	15690.00	61.9 PK	74.0	-12.1	2.76 V	328	47.60	14.30
8	15690.00	49.9 AV	54.0	-4.1	2.76 V	328	35.60	14.30

REMARKS:

1. Emission Level(dBuV/m) = Raw Value(dBuV) + Correction Factor(dB/m)
2. Correction Factor(dB/m) = Antenna Factor(dB/m) + Cable Factor(dB)– Pre-Amplifier Factor(dB)
3. The other emission levels were very low against the limit.
4. Margin value = Emission Level – Limit value
5. " * ": Fundamental frequency.
6. " # ": The radiated frequency is out of the restricted band.

CHANNEL	TX Channel 151	DETECTOR FUNCTION	Peak (PK)
FREQUENCY RANGE	1GHz ~ 40GHz		Average (AV)

ANTENNA POLARITY & TEST DISTANCE: HORIZONTAL AT 3 M								
NO.	FREQ. (MHz)	EMISSION LEVEL (dBuV/m)	LIMIT (dBuV/m)	MARGIN (dB)	ANTENNA HEIGHT (m)	TABLE ANGLE (Degree)	RAW VALUE (dBuV)	CORRECTION FACTOR (dB/m)
1	#5646.40	66.2 PK	68.2	-2.0	1.09 H	300	64.50	1.70
2	#5650.00	69.7 PK	74.0	-4.3	1.07 H	298	68.00	1.70
3	#5650.00	52.7 AV	54.0	-1.3	1.07 H	298	51.00	1.70
4	*5755.00	115.3 PK			1.09 H	300	75.40	39.90
5	*5755.00	104.9 AV			1.09 H	300	65.00	39.90
6	#5967.20	57.3 PK	68.2	-10.9	1.09 H	300	54.60	2.70
7	11510.00	61.3 PK	74.0	-12.7	2.43 H	13	46.80	14.50
8	11510.00	48.3 AV	54.0	-5.7	2.43 H	13	33.80	14.50

ANTENNA POLARITY & TEST DISTANCE: VERTICAL AT 3 M								
NO.	FREQ. (MHz)	EMISSION LEVEL (dBuV/m)	LIMIT (dBuV/m)	MARGIN (dB)	ANTENNA HEIGHT (m)	TABLE ANGLE (Degree)	RAW VALUE (dBuV)	CORRECTION FACTOR (dB/m)
1	#5644.00	60.4 PK	68.2	-7.8	4.00 V	20	58.70	1.70
2	*5755.00	110.1 PK			4.00 V	20	70.20	39.90
3	*5755.00	99.6 AV			4.00 V	20	59.70	39.90
4	#5957.60	56.9 PK	68.2	-11.3	4.00 V	20	54.30	2.60
5	11510.00	60.8 PK	74.0	-13.2	2.71 V	50	46.30	14.50
6	11510.00	47.7 AV	54.0	-6.3	2.71 V	50	33.20	14.50

REMARKS:

1. Emission Level(dBuV/m) = Raw Value(dBuV) + Correction Factor(dB/m)
2. Correction Factor(dB/m) = Antenna Factor(dB/m) + Cable Factor(dB)– Pre-Amplifier Factor(dB)
3. The other emission levels were very low against the limit.
4. Margin value = Emission Level – Limit value
5. " * ": Fundamental frequency.
6. " # ": The radiated frequency is out of the restricted band.

CHANNEL	TX Channel 159	DETECTOR FUNCTION	Peak (PK)
FREQUENCY RANGE	1GHz ~ 40GHz		Average (AV)

ANTENNA POLARITY & TEST DISTANCE: HORIZONTAL AT 3 M

NO.	FREQ. (MHz)	EMISSION LEVEL (dBuV/m)	LIMIT (dBuV/m)	MARGIN (dB)	ANTENNA HEIGHT (m)	TABLE ANGLE (Degree)	RAW VALUE (dBuV)	CORRECTION FACTOR (dB/m)
1	#5638.40	57.8 PK	68.2	-10.4	1.09 H	302	56.10	1.70
2	*5795.00	114.2 PK			1.09 H	302	74.10	40.10
3	*5795.00	104.1 AV			1.09 H	302	64.00	40.10
4	#5925.60	58.7 PK	68.2	-9.5	1.09 H	302	56.10	2.60
5	11590.00	61.4 PK	74.0	-12.6	2.38 H	21	47.10	14.30
6	11590.00	48.5 AV	54.0	-5.5	2.38 H	21	34.20	14.30

ANTENNA POLARITY & TEST DISTANCE: VERTICAL AT 3 M

NO.	FREQ. (MHz)	EMISSION LEVEL (dBuV/m)	LIMIT (dBuV/m)	MARGIN (dB)	ANTENNA HEIGHT (m)	TABLE ANGLE (Degree)	RAW VALUE (dBuV)	CORRECTION FACTOR (dB/m)
1	#5626.40	56.5 PK	68.2	-11.7	3.84 V	336	54.80	1.70
2	*5795.00	112.3 PK			3.84 V	336	72.20	40.10
3	*5795.00	101.6 AV			3.84 V	336	61.50	40.10
4	#5925.60	58.1 PK	68.2	-10.1	3.84 V	336	55.50	2.60
5	11590.00	60.7 PK	74.0	-13.3	2.83 V	46	46.40	14.30
6	11590.00	47.8 AV	54.0	-6.2	2.83 V	46	33.50	14.30

REMARKS:

1. Emission Level(dBuV/m) = Raw Value(dBuV) + Correction Factor(dB/m)
2. Correction Factor(dB/m) = Antenna Factor(dB/m) + Cable Factor(dB)– Pre-Amplifier Factor(dB)
3. The other emission levels were very low against the limit.
4. Margin value = Emission Level – Limit value
5. " * ": Fundamental frequency.
6. " # ": The radiated frequency is out of the restricted band.

802.11ac (VHT80)

CHANNEL	TX Channel 42	DETECTOR FUNCTION	Peak (PK)
FREQUENCY RANGE	1GHz ~ 40GHz		Average (AV)

ANTENNA POLARITY & TEST DISTANCE: HORIZONTAL AT 3 M

NO.	FREQ. (MHz)	EMISSION LEVEL (dBuV/m)	LIMIT (dBuV/m)	MARGIN (dB)	ANTENNA HEIGHT (m)	TABLE ANGLE (Degree)	RAW VALUE (dBuV)	CORRECTION FACTOR (dB/m)
1	5150.00	63.0 PK	74.0	-11.0	1.15 H	298	62.20	0.80
2	5150.00	52.2 AV	54.0	-1.8	1.15 H	298	51.40	0.80
3	*5210.00	105.0 PK			1.22 H	288	66.30	38.70
4	*5210.00	95.0 AV			1.22 H	288	56.30	38.70
5	5350.00	56.6 PK	74.0	-17.4	2.00 H	355	55.50	1.10
6	5350.00	44.7 AV	54.0	-9.3	2.00 H	355	43.60	1.10
7	#10480.00	58.8 PK	74.0	-15.2	1.76 H	215	45.30	13.50
8	#10480.00	47.1 AV	54.0	-6.9	1.76 H	215	33.60	13.50

ANTENNA POLARITY & TEST DISTANCE: VERTICAL AT 3 M

NO.	FREQ. (MHz)	EMISSION LEVEL (dBuV/m)	LIMIT (dBuV/m)	MARGIN (dB)	ANTENNA HEIGHT (m)	TABLE ANGLE (Degree)	RAW VALUE (dBuV)	CORRECTION FACTOR (dB/m)
1	5150.00	64.7 PK	74.0	-9.3	1.96 V	16	63.90	0.80
2	5150.00	49.2 AV	54.0	-4.8	1.96 V	16	48.40	0.80
3	*5210.00	100.4 PK			1.94 V	19	61.70	38.70
4	*5210.00	91.0 AV			1.94 V	19	52.30	38.70
5	5350.00	57.3 PK	74.0	-16.7	2.00 V	163	56.20	1.10
6	5350.00	44.6 AV	54.0	-9.4	2.00 V	163	43.50	1.10
7	#10420.00	56.7 PK	74.0	-17.3	2.47 V	253	43.80	12.90
8	#10420.00	44.4 AV	54.0	-9.6	2.47 V	253	31.50	12.90

REMARKS:

1. Emission Level(dBuV/m) = Raw Value(dBuV) + Correction Factor(dB/m)
2. Correction Factor(dB/m) = Antenna Factor(dB/m) + Cable Factor(dB)– Pre-Amplifier Factor(dB)
3. The other emission levels were very low against the limit.
4. Margin value = Emission Level – Limit value
5. " * ": Fundamental frequency.
6. " # ": The radiated frequency is out of the restricted band.

CHANNEL	TX Channel 155	DETECTOR FUNCTION	Peak (PK)
FREQUENCY RANGE	1GHz ~ 40GHz		Average (AV)

ANTENNA POLARITY & TEST DISTANCE: HORIZONTAL AT 3 M								
NO.	FREQ. (MHz)	EMISSION LEVEL (dBuV/m)	LIMIT (dBuV/m)	MARGIN (dB)	ANTENNA HEIGHT (m)	TABLE ANGLE (Degree)	RAW VALUE (dBuV)	CORRECTION FACTOR (dB/m)
1	#5635.20	66.2 PK	68.2	-2.0	1.02 H	301	64.50	1.70
2	#5650.00	67.0 PK	68.2	-1.2	1.16 H	302	65.30	1.70
3	#5654.40	68.2 PK	71.5	-3.3	1.02 H	301	66.50	1.70
4	*5775.00	111.4 PK			1.02 H	301	71.40	40.00
5	*5775.00	100.1 AV			1.02 H	301	60.10	40.00
6	#5935.20	61.3 PK	68.2	-6.9	1.02 H	301	58.70	2.60
7	11550.00	60.7 PK	74.0	-13.3	2.36 H	27	46.20	14.50
8	11550.00	48.0 AV	54.0	-6.0	2.36 H	27	33.50	14.50

ANTENNA POLARITY & TEST DISTANCE: VERTICAL AT 3 M								
NO.	FREQ. (MHz)	EMISSION LEVEL (dBuV/m)	LIMIT (dBuV/m)	MARGIN (dB)	ANTENNA HEIGHT (m)	TABLE ANGLE (Degree)	RAW VALUE (dBuV)	CORRECTION FACTOR (dB/m)
1	#5642.40	63.1 PK	68.2	-5.1	3.95 V	16	61.40	1.70
2	*5775.00	104.5 PK			3.95 V	16	64.50	40.00
3	*5775.00	95.3 AV			3.95 V	16	55.30	40.00
4	#5931.20	57.7 PK	68.2	-10.5	3.95 V	16	55.10	2.60
5	11550.00	60.5 PK	74.0	-13.5	2.83 V	47	46.00	14.50
6	11550.00	47.5 AV	54.0	-6.5	2.83 V	47	33.00	14.50

REMARKS:

1. Emission Level(dBuV/m) = Raw Value(dBuV) + Correction Factor(dB/m)
2. Correction Factor(dB/m) = Antenna Factor(dB/m) + Cable Factor(dB)– Pre-Amplifier Factor(dB)
3. The other emission levels were very low against the limit.
4. Margin value = Emission Level – Limit value
5. " * ": Fundamental frequency.
6. " # ": The radiated frequency is out of the restricted band.

Below 1GHz Worst-case Data: 802.11n (HT20)

CHANNEL	TX Channel 149	DETECTOR FUNCTION	Quasi-Peak (QP)
FREQUENCY RANGE	9kHz ~ 1GHz		

ANTENNA POLARITY & TEST DISTANCE: HORIZONTAL AT 3 M								
NO.	FREQ. (MHz)	EMISSION LEVEL (dBuV/m)	LIMIT (dBuV/m)	MARGIN (dB)	ANTENNA HEIGHT (m)	TABLE ANGLE (Degree)	RAW VALUE (dBuV)	CORRECTION FACTOR (dB/m)
1	57.12	27.5 QP	40.0	-12.5	1.99 H	230	42.00	-14.50
2	167.94	30.6 QP	43.5	-12.9	1.50 H	96	44.50	-13.90
3	249.60	31.9 QP	46.0	-14.1	1.00 H	123	45.80	-13.90
4	348.76	33.5 QP	46.0	-12.5	1.00 H	208	44.70	-11.20
5	500.42	33.8 QP	46.0	-12.2	1.50 H	174	41.60	-7.80
6	729.84	39.7 QP	46.0	-6.3	1.00 H	331	42.50	-2.80

ANTENNA POLARITY & TEST DISTANCE: VERTICAL AT 3 M								
NO.	FREQ. (MHz)	EMISSION LEVEL (dBuV/m)	LIMIT (dBuV/m)	MARGIN (dB)	ANTENNA HEIGHT (m)	TABLE ANGLE (Degree)	RAW VALUE (dBuV)	CORRECTION FACTOR (dB/m)
1	35.73	36.9 QP	40.0	-3.1	1.01 V	15	52.60	-15.70
2	53.23	37.2 QP	40.0	-2.8	1.01 V	306	51.40	-14.20
3	146.56	30.3 QP	43.5	-13.2	1.01 V	327	44.20	-13.90
4	374.04	32.9 QP	46.0	-13.1	1.01 V	213	43.30	-10.40
5	624.85	35.9 QP	46.0	-10.1	1.51 V	179	40.70	-4.80
6	729.84	43.7 QP	46.0	-2.3	1.51 V	15	46.50	-2.80

REMARKS:

1. Emission Level(dBuV/m) = Raw Value(dBuV) + Correction Factor(dB/m)
2. Correction Factor(dB/m) = Antenna Factor(dB/m) + Cable Factor(dB)– Pre-Amplifier Factor(dB)
3. The other emission levels were very low against the limit.
4. Margin value = Emission Level – Limit value

4.2 Conducted Emission Measurement

4.2.1 Limits of Conducted Emission Measurement

Frequency (MHz)	Conducted Limit (dBuV)	
	Quasi-peak	Average
0.15 - 0.5	66 - 56	56 - 46
0.50 - 5.0	56	46
5.0 - 30.0	60	50

Note: 1. The lower limit shall apply at the transition frequencies.

2. The limit decreases in line with the logarithm of the frequency in the range of 0.15 to 0.50MHz.

4.2.2 Test Instruments

Tested date: Feb. 16, 2017

Description & Manufacturer	Model No.	Serial No.	Date Of Calibration	Due Date Of Calibration
Test Receiver ROHDE & SCHWARZ	ESCI	100613	Nov. 21, 2016	Nov. 20, 2017
RF signal cable Woken	5D-FB	Cable-cond1-01	Dec. 22, 2016	Dec. 21, 2017
LISN ROHDE & SCHWARZ (EUT)	ESH3-Z5	835239/001	Feb. 26, 2016	Feb. 25, 2017
LISN ROHDE & SCHWARZ (Peripheral)	ESH3-Z5	100311	Jul. 28, 2016	Jul. 27, 2017
Software ADT	BV ADT_Cond_ V7.3.7.3	NA	NA	NA

Note: 1. The calibration interval of the above test instruments is 12 months and the calibrations are traceable to NML/ROC and NIST/USA.

2. The test was performed in HwaYa Shielded Room 1.

3. The VCCI Site Registration No. is C-2040.

4.2.3 Test Procedure

- The EUT was placed 0.4 meters from the conducting wall of the shielded room with EUT being connected to the power mains through a line impedance stabilization network (LISN). Other support units were connected to the power mains through another LISN. The two LISNs provide 50 ohm/ 50uH of coupling impedance for the measuring instrument.
- Both lines of the power mains connected to the EUT were checked for maximum conducted interference.
- The frequency range from 150kHz to 30MHz was searched. Emission levels under (Limit - 20dB) was not recorded.

NOTE: All modes of operation were investigated and the worst-case emissions are reported.

4.2.4 Deviation from Test Standard

No deviation.

4.2.5 Test Setup

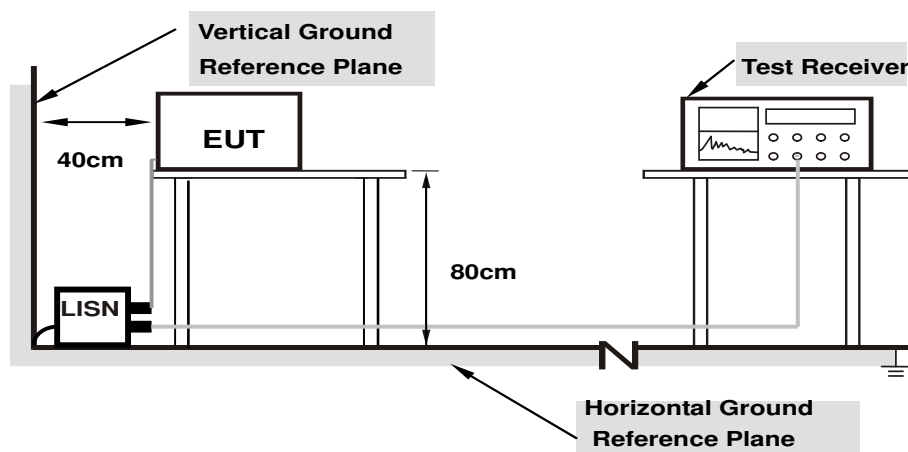

Note: 1.Support units were connected to second LISN.

2.Both of LISNs (AMN) are 80 cm from EUT and at least 80 from other units and other metal planes

For the actual test configuration, please refer to the attached file (Test Setup Photo).

4.2.6 EUT Operating Condition

Same as 4.1.6.

4.2.7 Test Results

Phase	Line (L)	Detector Function	Quasi-Peak (QP) / Average (AV)
-------	----------	-------------------	--------------------------------

No	Freq. [MHz]	Corr. Factor (dB)	Reading Value [dB (uV)]		Emission Level [dB (uV)]		Limit [dB (uV)]		Margin (dB)	
			Q.P.	AV.	Q.P.	AV.	Q.P.	AV.	Q.P.	AV.
	1	0.15391	10.18	31.81	10.02	41.99	20.20	65.79	55.79	-23.80
2	0.17744	10.18	29.65	9.13	39.83	19.31	64.60	54.60	-24.77	-35.29
3	0.24796	10.20	21.97	3.69	32.17	13.89	61.83	51.83	-29.66	-37.94
4	0.66255	10.24	23.26	16.30	33.50	26.54	56.00	46.00	-22.50	-19.46
5	1.75310	10.33	13.48	6.79	23.81	17.12	56.00	46.00	-32.19	-28.88
6	22.10465	11.62	23.38	15.62	35.00	27.24	60.00	50.00	-25.00	-22.76

REMARKS:

1. Q.P. and AV. are abbreviations of quasi-peak and average individually.
2. The emission levels of other frequencies were very low against the limit.
3. Margin value = Emission level - Limit value
4. Correction factor = Insertion loss + Cable loss
5. Emission Level = Correction Factor + Reading Value.

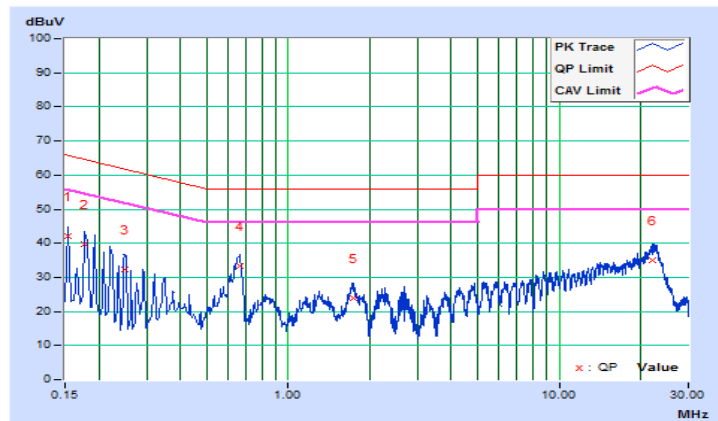

Phase	Neutral (N)	Detector Function	Quasi-Peak (QP) / Average (AV)
-------	-------------	-------------------	--------------------------------

No	Freq. [MHz]	Corr. Factor (dB)	Reading Value [dB (uV)]		Emission Level [dB (uV)]		Limit [dB (uV)]		Margin (dB)	
			Q.P.	AV.	Q.P.	AV.	Q.P.	AV.	Q.P.	AV.
			1	0.16173	10.19	31.57	12.27	41.76	22.46	65.37
2	0.20474	10.19	27.46	10.46	37.65	20.65	63.42	53.42	-25.77	-32.77
3	0.36913	10.27	14.83	4.87	25.10	15.14	58.52	48.52	-33.42	-33.38
4	0.65388	10.28	24.76	17.61	35.04	27.89	56.00	46.00	-20.96	-18.11
5	1.72573	10.34	13.46	6.58	23.80	16.92	56.00	46.00	-32.20	-29.08
6	22.26496	11.80	17.19	9.59	28.99	21.39	60.00	50.00	-31.01	-28.61

REMARKS:

1. Q.P. and AV. are abbreviations of quasi-peak and average individually.
2. The emission levels of other frequencies were very low against the limit.
3. Margin value = Emission level - Limit value
4. Correction factor = Insertion loss + Cable loss
5. Emission Level = Correction Factor + Reading Value.

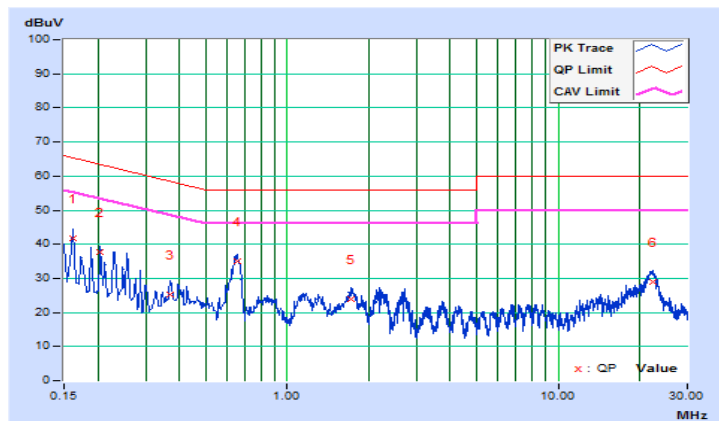

4.3 Transmit Power Measurement

4.3.1 Limits of Transmit Power Measurement

Operation Band	EUT Category		LIMIT
U-NII-1		Outdoor Access Point	1 Watt (30 dBm) (Max. e.i.r.p \leq 125mW(21 dBm) at any elevation angle above 30 degrees as measured from the horizon)
		Fixed point-to-point Access Point	1 Watt (30 dBm)
	√	Indoor Access Point	1 Watt (30 dBm)
		Mobile and Portable client device	250mW (24 dBm)
U-NII-2A	---		250mW (24 dBm) or 11 dBm+10 log B*
U-NII-2C	---		250mW (24 dBm) or 11 dBm+10 log B*
U-NII-3	√		1 Watt (30 dBm)

*B is the 26 dB emission bandwidth in megahertz

Per KDB 662911 Method of conducted output power measurement on IEEE 802.11 devices,

Array Gain = 0 dB (i.e., no array gain) for $N_{ANT} \leq 4$;

Array Gain = 0 dB (i.e., no array gain) for channel widths ≥ 40 MHz for any N_{ANT} ;

Array Gain = $5 \log(N_{ANT}/N_{SS})$ dB or 3 dB, whichever is less for 20-MHz channel widths with $N_{ANT} \geq 5$.

For power measurements on all other devices: Array Gain = $10 \log(N_{ANT}/N_{SS})$ dB.

4.3.2 Test Setup

For Power Output Measurement
802.11a, 802.11n (HT20), 802.11n (HT40)

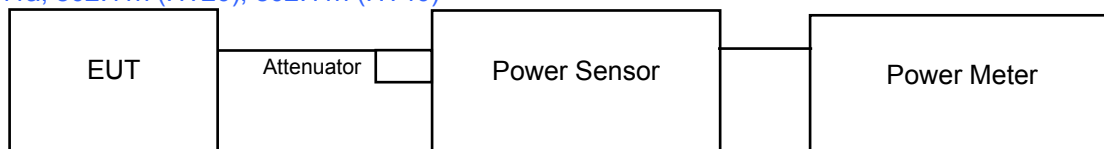

802.11ac (VHT80)

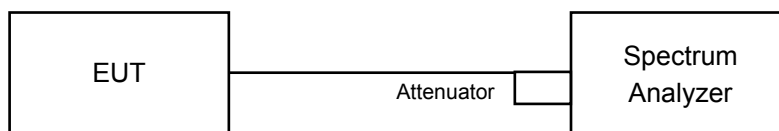

For 26dB Bandwidth

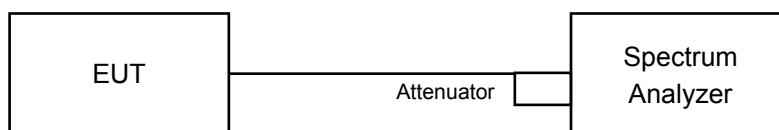

4.3.3 Test Instruments

Refer to section 4.1.2 to get information of above instrument.

4.3.4 Test Procedure

For Average Power Measurement

For 802.11a, 802.11n (HT20), 802.11n (HT40)

Method PM is used to perform output power measurement, trigger and gating function of wide band power meter is enabled to measure max output power of TX on burst. Duty factor is not added to measured value.

For 802.11ac (VHT80)

- a. Set span to encompass the entire 26 dB EBW (or, alternatively, the entire 99% occupied bandwidth) of the signal.
- b. Set sweep trigger to "free run".
- c. Set RBW = 1 MHz.
- d. Set VBW \geq 3 MHz
- e. Number of points in sweep \geq 2 Span / RBW.
- f. Sweep time \leq (number of points in sweep) * T
- g. Using emission bandwidth to determine the frequency span for integration the channel bandwidth.
- h. Detector = RMS.
- i. Trace mode = max hold.
- j. Allow max hold to run for at least 60 seconds, or longer as needed to allow the trace to stabilize.
- k. Compute power by integrating the spectrum across the EBW (or, alternatively, the entire 99% occupied bandwidth) of the signal using the instrument's band power measurement function with band limits set equal to the EBW (or occupied bandwidth) band edges. If the instrument does not have a band power function, sum the spectrum levels (in power units) at 1 MHz intervals extending across the EBW (or, alternatively, the entire 99% occupied bandwidth) of the spectrum.

For 26dB Bandwidth

- a. Set RBW = approximately 1% of the emission bandwidth.
- b. Set the VBW > RBW.
- c. Detector = Peak.
- d. Trace mode = max hold.
- e. Measure the maximum width of the emission that is 26 dB down from the peak of the emission. Compare this with the RBW setting of the analyzer. Readjust RBW and repeat measurement as needed until the RBW/EBW ratio is approximately 1%.

4.3.5 Deviation from Test Standard

No deviation.

4.3.6 EUT Operating Condition

The software provided by client to enable the EUT under transmission condition continuously at lowest, middle and highest channel frequencies individually.

4.3.7 Test Result

POWER OUTPUT:

802.11a

Channel	Frequency (MHz)	Maximum Conducted Power (dBm)		Maximum Conducted Power (mW)	Maximum Conducted Power (dBm)	Power Limit (dBm)	Pass / Fail
		Chain 0	Chain 1				
36	5180	19.07	19.16	163.138	22.13	30	Pass
40	5200	18.91	19.28	162.527	22.11	30	Pass
48	5240	19.01	19.15	161.840	22.09	30	Pass
149	5745	21.02	21.15	256.791	24.10	30	Pass
157	5785	20.94	21.12	253.585	24.04	30	Pass
165	5825	20.99	20.81	246.107	23.91	30	Pass

802.11n (HT20)

Channel	Frequency (MHz)	Maximum Conducted Power (dBm)		Maximum Conducted Power (mW)	Maximum Conducted Power (dBm)	Power Limit (dBm)	Pass / Fail
		Chain 0	Chain 1				
36	5180	18.53	18.61	143.896	21.58	30	Pass
40	5200	19.42	19.51	176.829	22.48	30	Pass
48	5240	18.41	18.24	136.024	21.34	30	Pass
149	5745	21.12	21.09	257.949	24.12	30	Pass
157	5785	20.91	21.08	251.543	24.01	30	Pass
165	5825	20.94	20.84	245.504	23.90	30	Pass

802.11n (HT40)

Channel	Frequency (MHz)	Maximum Conducted Power (dBm)		Maximum Conducted Power (mW)	Maximum Conducted Power (dBm)	Power Limit (dBm)	Pass / Fail
		Chain 0	Chain 1				
38	5190	16.65	16.85	94.655	19.76	30	Pass
46	5230	18.72	18.87	151.563	21.81	30	Pass
151	5755	20.87	21.05	249.530	23.97	30	Pass
159	5795	20.65	21.11	245.267	23.90	30	Pass

802.11ac (VHT80)

Channel	Frequency (MHz)	Maximum Conducted Power (dBm)		Maximum Conducted Power (mW)	Maximum Conducted Power (dBm)	Power Limit (dBm)	Pass / Fail
		Chain 0	Chain 1				
42	5210	14.99	15.07	63.687	18.04	30	Pass
155	5775	17.74	18.24	126.110	21.01	30	Pass

26dB BANDWIDTH:

802.11a

Channel	Frequency (MHz)	26dBc Bandwidth (MHz)		Pass / Fail
		Chain 0	Chain 1	
36	5180	23.11	22.68	Pass
40	5200	22.91	22.66	Pass
48	5240	22.71	22.49	Pass

802.11n (HT20)

Channel	Frequency (MHz)	26dBc Bandwidth (MHz)		Pass / Fail
		Chain 0	Chain 1	
36	5180	23.39	23.41	Pass
40	5200	22.50	23.70	Pass
48	5240	22.85	23.78	Pass

802.11n (HT40)

Channel	Frequency (MHz)	26dBc Bandwidth (MHz)		Pass / Fail
		Chain 0	Chain 1	
38	5190	45.33	45.17	Pass
46	5230	45.74	45.18	Pass

802.11ac (VHT80)

Channel	Frequency (MHz)	26dBc Bandwidth (MHz)		Pass / Fail
		Chain 0	Chain 1	
42	5210	89.64	87.57	Pass

SPECTRUM PLOT OF WORST VALUE

802.11a

802.11n (HT20)

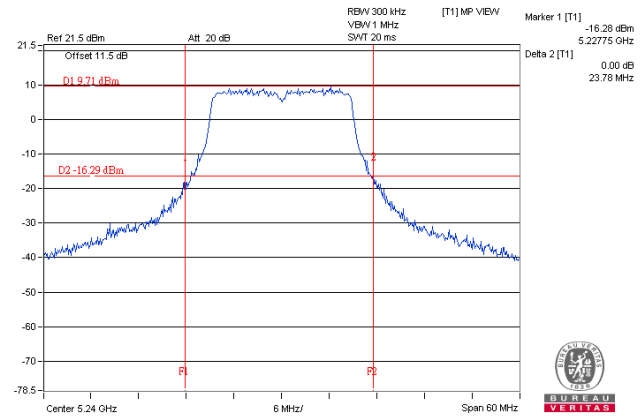
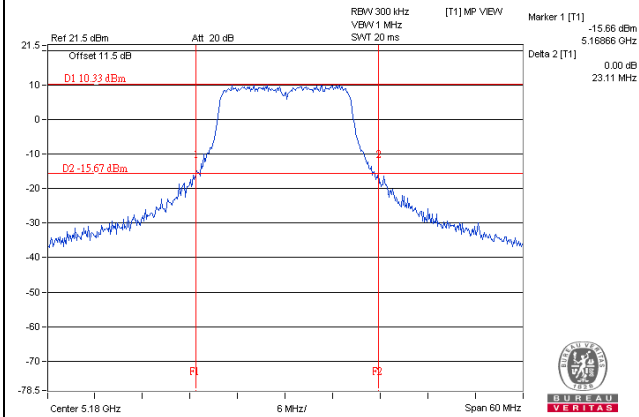

802.11n (HT40)

802.11ac (VHT80)

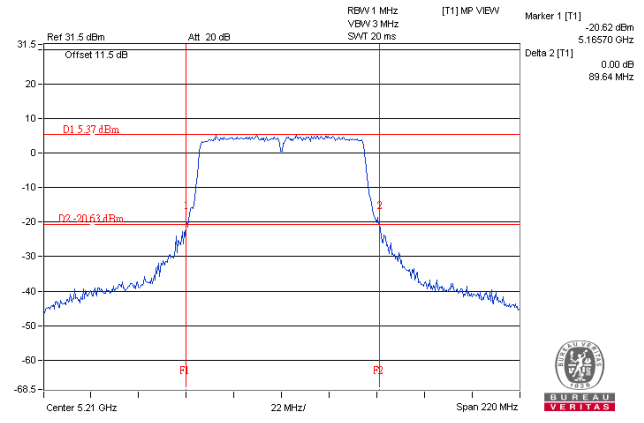
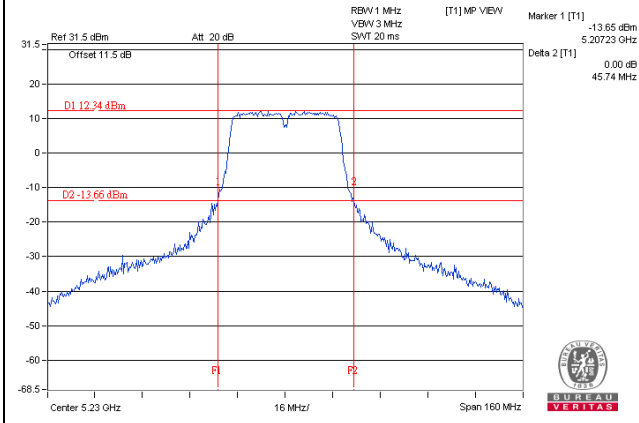

4.4 Occupied Bandwidth Measurement

4.4.1 Test Setup

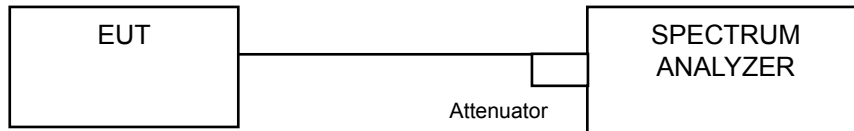

4.4.2 Test Instruments

Refer to section 4.1.2 to get information of above instrument.

4.4.3 Test Procedure

The transmitter output was connected to the spectrum analyzer through an attenuator. The bandwidth of the fundamental frequency was measured by spectrum analyzer with resolution bandwidth in the range of 1% to 5% of the anticipated emission bandwidth, and a video bandwidth at least 3x the resolution bandwidth and set the detector to SAMPLE. The width of a frequency band such that, below the lower and above the upper frequency limits, the mean powers emitted are each equal to a specified percentage 0.5 %of the total mean power of a given emission.

4.4.4 Test Results

802.11a

Channel	Frequency (MHz)	Occupied Bandwidth (MHz)	
		Chain 0	Chain 1
36	5180	16.80	16.68
40	5200	16.68	16.68
48	5240	16.80	16.80
149	5745	21.84	24.96
157	5785	21.48	26.76
165	5825	22.20	25.44

802.11n (HT20)

Channel	Frequency (MHz)	Occupied Bandwidth (MHz)	
		Chain 0	Chain 1
36	5180	17.88	17.88
40	5200	17.88	17.88
48	5240	18.00	17.88
149	5745	22.68	25.80
157	5785	21.84	27.72
165	5825	23.16	25.32

802.11n (HT40)

Channel	Frequency (MHz)	Occupied Bandwidth (MHz)	
		Chain 0	Chain 1
38	5190	36.60	36.84
46	5230	36.72	36.72
151	5755	37.92	39.24
159	5795	38.04	40.20

802.11ac (VHT80)

Channel	Frequency (MHz)	Occupied Bandwidth (MHz)	
		Chain 0	Chain 1
42	5210	76.08	76.08
155	5775	75.84	76.08

SPECTRUM PLOT OF WORST VALUE

802.11a

802.11n (HT20)

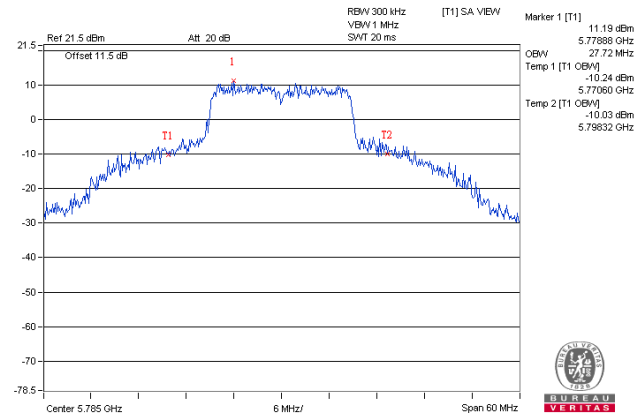
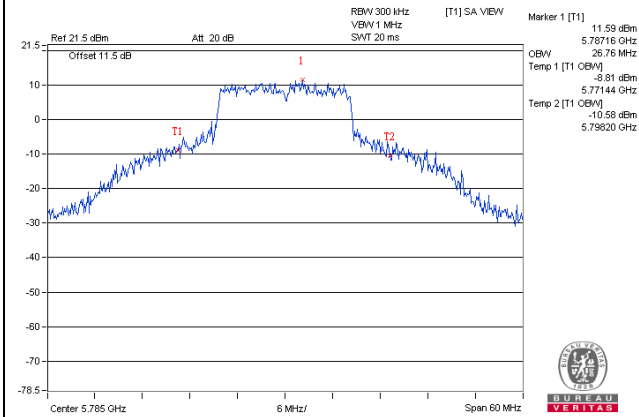

802.11n (HT40)

802.11ac (VHT80)

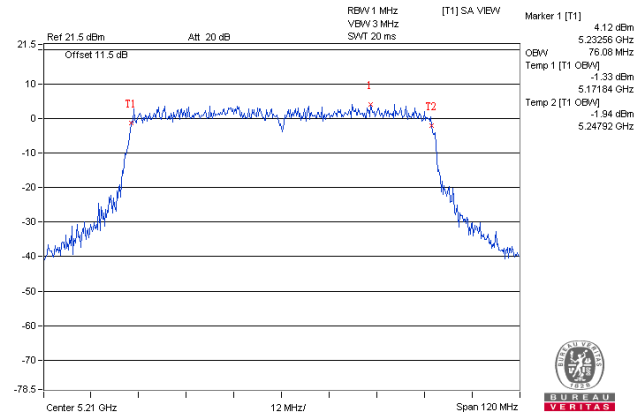
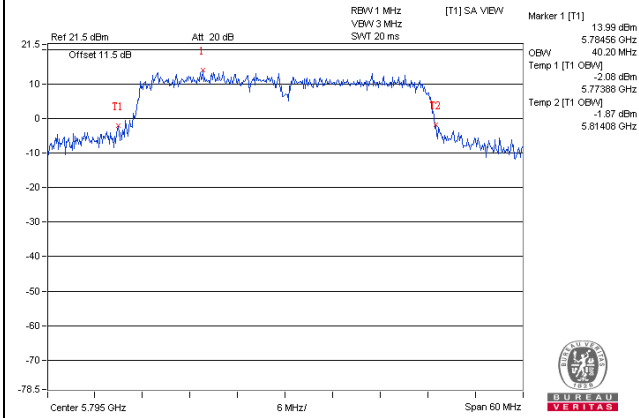

4.5 Peak Power Spectral Density Measurement

4.5.1 Limits of Peak Power Spectral Density Measurement

Operation Band	EUT Category		LIMIT
U-NII-1		Outdoor Access Point	17dBm/ MHz
		Fixed point-to-point Access Point	
	√	Indoor Access Point	
		Mobile and Portable client device	11dBm/ MHz
U-NII-2A	---		11dBm/ MHz
U-NII-2C	---		11dBm/ MHz
U-NII-3	√		30dBm/ 500kHz

4.5.2 Test Setup

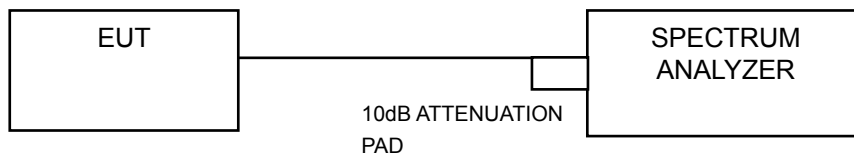

4.5.3 Test Instruments

Refer to section 4.1.2 to get information of above instrument.

4.5.4 Test Procedure

For U-NII-1 band:

Using method SA-2, Duty cycle <98%

- Set span to encompass the entire emission bandwidth (EBW) of the signal.
- Set RBW = 1 MHz, Set VBW ≥ 3 MHz, Detector = RMS
- Sweep time = auto, trigger set to “free run”.
- Trace average at least 100 traces in power averaging mode.
- Record the max value and add 10 log (1/duty cycle)

For U-NII-3 band:

Duty cycle <98%

- Set span to encompass the entire emission bandwidth (EBW) of the signal.
- Set RBW = 300 kHz, Set VBW ≥ 1 MHz, Detector = RMS
- Use the peak marker function to determine the maximum power level in any 300 kHz band segment within the fundamental EBW.
- Scale the observed power level to an equivalent value in 500 kHz by adjusting (reducing) the measured power by a bandwidth correction factor (BWCF) where $BWCF = 10\log(500\text{ kHz}/300\text{kHz})$
- Sweep time = auto, trigger set to “free run”.
- Trace average at least 100 traces in power averaging mode.
- Record the max value and add 10 log (1/duty cycle)

4.5.5 Deviation from Test Standard

No deviation.

4.5.6 EUT Operating Condition

Same as Item 4.3.6.

4.5.7 Test Results

For U-NII-1 Band 802.11a

Chan.	Freq. (MHz)	PSD W/O Duty Factor (dBm/MHz)		Duty Factor (dB)	Total PSD with duty factor (dBm/MHz)	Max. Limit (dBm/MHz)	Pass / Fail
		Chain 0	Chain 1				
36	5180	4.57	4.94	0.20	7.97	14.49	Pass
40	5200	4.75	5.30	0.20	8.24	14.49	Pass
48	5240	5.09	5.07	0.20	8.29	14.49	Pass

Note:

- Method 1 of power density measurement of KDB 662911 is using for calculating total power density. Total power density is summing entire spectra across corresponding frequency bins on the various outputs by computer.
- Directional gain = $5.5\text{dBi} + 10\log(2) = 8.51\text{dBi} > 6\text{dBi}$, so the power density limit shall be reduced to $17 - (8.51 - 6) = 14.49\text{dBm}$.
- Refer to section 3.3 for duty cycle spectrum plot.

802.11n (HT20)

Chan.	Freq. (MHz)	PSD W/O Duty Factor (dBm/MHz)		Duty Factor (dB)	Total PSD with duty factor (dBm/MHz)	Max. Limit (dBm/MHz)	Pass / Fail
		Chain 0	Chain 1				
36	5180	3.62	3.56	0.37	6.97	14.49	Pass
40	5200	4.60	4.90	0.37	8.13	14.49	Pass
48	5240	3.85	3.94	0.37	7.27	14.49	Pass

Note:

- Method 1 of power density measurement of KDB 662911 is using for calculating total power density. Total power density is summing entire spectra across corresponding frequency bins on the various outputs by computer.
- Directional gain = $5.5\text{dBi} + 10\log(2) = 8.51\text{dBi} > 6\text{dBi}$, so the power density limit shall be reduced to $17 - (8.51 - 6) = 14.49\text{dBm}$.

802.11n (HT40)

Chan.	Freq. (MHz)	PSD W/O Duty Factor (dBm/MHz)		Duty Factor (dB)	Total PSD with duty factor (dBm/MHz)	Max. Limit (dBm/MHz)	Pass / Fail
		Chain 0	Chain 1				
38	5190	-1.21	-0.97	0.36	2.28	14.49	Pass
46	5230	0.89	0.93	0.36	4.28	14.49	Pass

Note:

- Method 1 of power density measurement of KDB 662911 is using for calculating total power density. Total power density is summing entire spectra across corresponding frequency bins on the various outputs by computer.
- Directional gain = $5.5\text{dBi} + 10\log(2) = 8.51\text{dBi} > 6\text{dBi}$, so the power density limit shall be reduced to $17 - (8.51 - 6) = 14.49\text{dBm}$.
- Refer to section 3.3 for duty cycle spectrum plot.

802.11ac (VHT80)

Chan.	Freq. (MHz)	PSD W/O Duty Factor (dBm/MHz)		Duty Factor (dB)	Total PSD with duty factor (dBm/MHz)	Max. Limit (dBm/MHz)	Pass / Fail
		Chain 0	Chain 1				
42	5210	-6.15	-5.84	0.11	-2.87	14.49	Pass

Note:

1. Method 1 of power density measurement of KDB 662911 is using for calculating total power density. Total power density is summing entire spectra across corresponding frequency bins on the various outputs by computer.
2. Directional gain = 5.5dBi + 10log(2) = 8.51dBi > 6dBi , so the power density limit shall be reduced to 17-(8.51-6) = 14.49dBm.
3. Refer to section 3.3 for duty cycle spectrum plot.

SPECTRUM PLOT OF WORST VALUE

802.11a / Chain 1 / CH 40

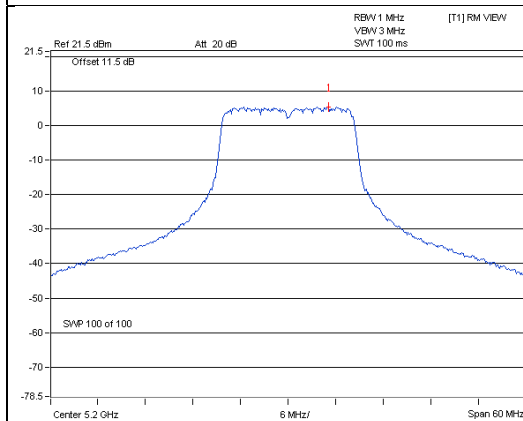

802.11n (HT20) / Chain 1 / CH 40

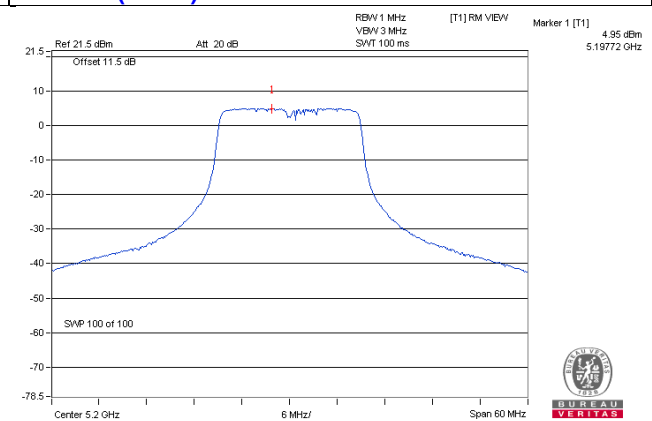

802.11n (HT40) / Chain 1 / CH 46

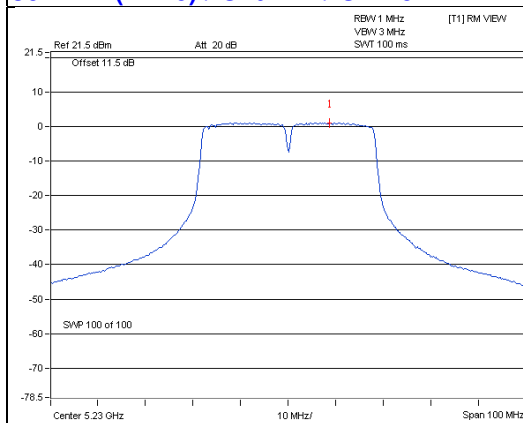

802.11ac (VHT80) / Chain 1 / CH 42

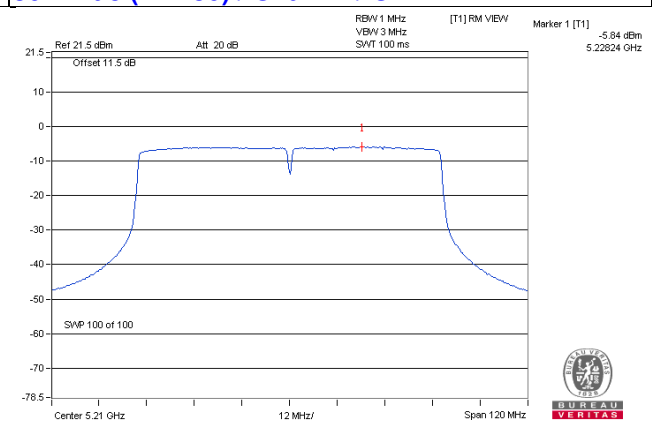

For U-NII-3 Band

TX chain	Chan.	Freq. (MHz)	PSD (dBm/300 kHz)	PSD (dBm/500 kHz)	10 log (N=2) dB	Duty factor (dB)	Total PSD (dBm/500 kHz)	Limit (dBm/500 kHz)	Pass / Fail
0	149	5745	-0.94	1.28	3.01	0.20	4.49	27.49	Pass
	157	5785	-1.14	1.08	3.01	0.20	4.29	27.49	Pass
	165	5825	-1.75	0.47	3.01	0.20	3.68	27.49	Pass
1	149	5745	-1.06	1.16	3.01	0.20	4.37	27.49	Pass
	157	5785	-0.97	1.25	3.01	0.20	4.46	27.49	Pass
	165	5825	-1.57	0.65	3.01	0.20	3.86	27.49	Pass

Note:

1. Directional gain = $5.5\text{dBi} + 10\log(2) = 8.51\text{dBi} > 6\text{dBi}$, so the power density limit shall be reduced to $30-(8.51-6) = 27.49\text{dBm}$.

2. Refer to section 3.3 for duty cycle spectrum plot.

802.11n (HT20)

TX chain	Chan.	Freq. (MHz)	PSD (dBm/300 kHz)	PSD (dBm/500 kHz)	10 log (N=2) dB	Duty factor (dB)	Total PSD (dBm/500 kHz)	Limit (dBm/500 kHz)	Pass / Fail
0	149	5745	-1.07	1.15	3.01	0.37	4.53	27.49	Pass
	157	5785	-1.44	0.78	3.01	0.37	4.16	27.49	Pass
	165	5825	-1.50	0.72	3.01	0.37	4.10	27.49	Pass
1	149	5745	-1.32	0.90	3.01	0.37	4.28	27.49	Pass
	157	5785	-1.18	1.04	3.01	0.37	4.42	27.49	Pass
	165	5825	-1.74	0.48	3.01	0.37	3.86	27.49	Pass

Note:

1. Directional gain = $5.5\text{dBi} + 10\log(2) = 8.51\text{dBi} > 6\text{dBi}$, so the power density limit shall be reduced to $30-(8.51-6) = 27.49\text{dBm}$.

2. Refer to section 3.3 for duty cycle spectrum plot.

802.11n (HT40)

TX chain	Chan.	Freq. (MHz)	PSD (dBm/300 kHz)	PSD (dBm/500 kHz)	10 log (N=2) dB	Duty factor (dB)	Total PSD (dBm/500 kHz)	Limit (dBm/500 kHz)	Pass / Fail
0	151	5755	-4.59	-2.37	3.01	0.36	1.00	27.49	Pass
	159	5795	-5.10	-2.88	3.01	0.36	0.49	27.49	Pass
1	151	5755	-4.41	-2.19	3.01	0.36	1.18	27.49	Pass
	159	5795	-4.58	-2.36	3.01	0.36	1.01	27.49	Pass

Note:

1. Directional gain = $5.5\text{dBi} + 10\log(2) = 8.51\text{dBi} > 6\text{dBi}$, so the power density limit shall be reduced to $30-(8.51-6) = 27.49\text{dBm}$.

2. Refer to section 3.3 for duty cycle spectrum plot.

802.11ac (VHT80)

TX chain	Chan.	Freq. (MHz)	PSD (dBm/300 kHz)	PSD (dBm/500 kHz)	10 log (N=2) dB	Duty factor (dB)	Total PSD (dBm/500 kHz)	Limit (dBm/500 kHz)	Pass / Fail
0	155	5775	-10.77	-8.55	3.01	0.11	-5.43	27.49	Pass
1	155	5775	-10.34	-8.12	3.01	0.11	-5.00	27.49	Pass

Note:

- Directional gain = $5.5\text{dBi} + 10\log(2) = 8.51\text{dBi} > 6\text{dBi}$, so the power density limit shall be reduced to $30-(8.51-6) = 27.49\text{dBm}$.
- Refer to section 3.3 for duty cycle spectrum plot.

SPECTRUM PLOT OF WORST VALUE

802.11a

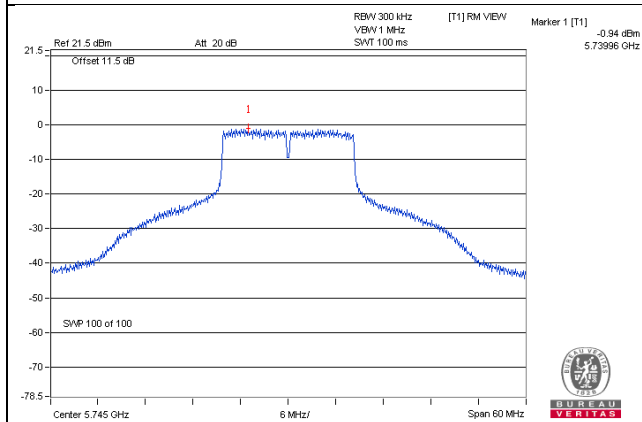

802.11n (HT20)

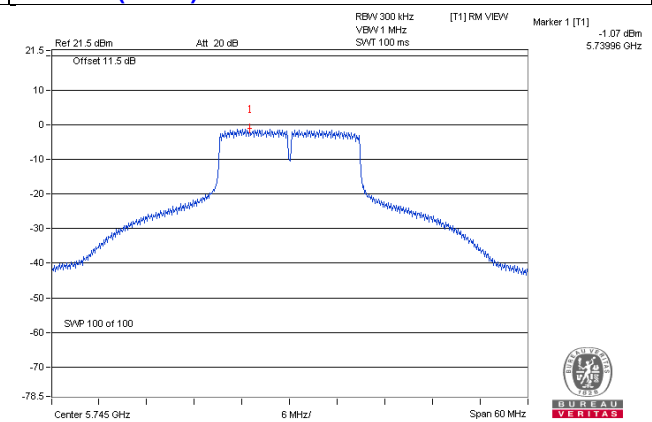

802.11n (HT40)

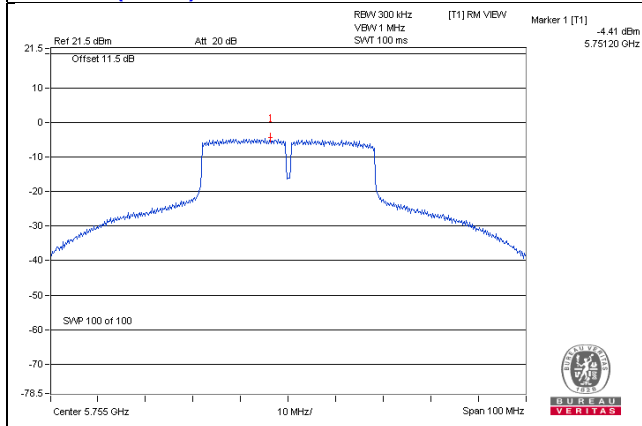

802.11ac (VHT80)

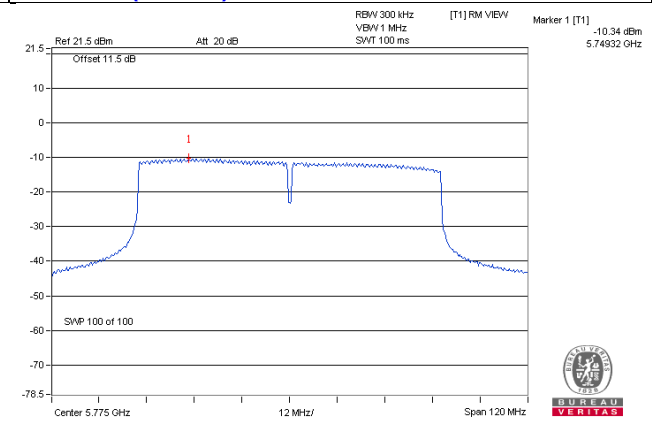

4.6 Frequency Stability Measurement

4.6.1 Limits of Frequency Stability Measurement

The frequency of the carrier signal shall be maintained within band of operation

4.6.2 Test Setup

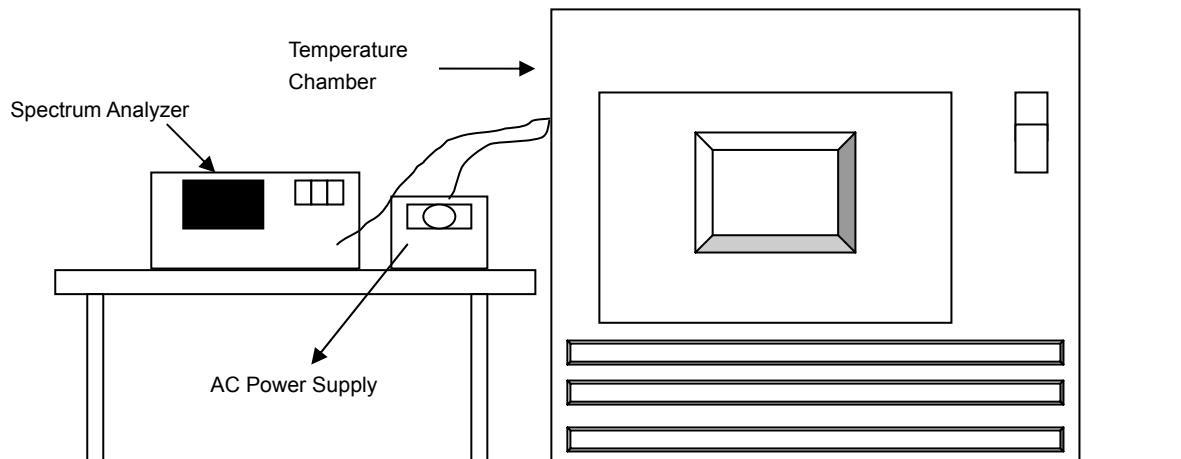

4.6.3 Test Instruments

Refer to section 4.1.2 to get information of above instrument.

4.6.4 Test Procedure

- The EUT was placed inside the environmental test chamber and powered by nominal AC voltage.
- Turn the EUT on and couple its output to a spectrum analyzer.
- Turn the EUT off and set the chamber to the highest temperature specified.
- Allow sufficient time (approximately 30 min) for the temperature of the chamber to stabilize, turn the EUT on and measure the operating frequency after 2, 5, and 10 minutes.
- Repeat step 2 and 3 with the temperature chamber set to the lowest temperature.
- The test chamber was allowed to stabilize at +20 degree C for a minimum of 30 minutes. The supply voltage was then adjusted on the EUT from 85% to 115% and the frequency record.

4.6.5 Deviation from Test Standard

No deviation.

4.6.6 EUT Operating Condition

Set the EUT transmit at un-modulation mode to test frequency stability.

4.6.7 Test Results

Frequency Stability Versus Temp.									
Operating Frequency: 5240MHz									
Temp. (°C)	Power Supply (Vac)	0 Minute		2 Minute		5 Minute		10 Minute	
		Measured Frequency (MHz)	Result	Measured Frequency (MHz)	Result	Measured Frequency (MHz)	Result	Measured Frequency (MHz)	Result
50	120	5239.9807	-0.00037	5239.9786	-0.00041	5239.9768	-0.00044	5239.9800	-0.00038
40	120	5239.9951	-0.00009	5239.9942	-0.00011	5239.9935	-0.00012	5239.9960	-0.00008
30	120	5240.0000	0.00000	5239.9996	-0.00001	5239.9983	-0.00003	5239.9964	-0.00007
20	120	5239.9912	-0.00017	5239.9916	-0.00016	5239.9918	-0.00016	5239.9907	-0.00018
10	120	5240.0230	0.00044	5240.0187	0.00036	5240.0204	0.00039	5240.0216	0.00041
0	120	5239.9988	-0.00002	5240.0005	0.00001	5239.9986	-0.00003	5240.0013	0.00002
-10	120	5239.9964	-0.00007	5239.9958	-0.00008	5239.9962	-0.00007	5239.9959	-0.00008
-20	120	5240.0275	0.00052	5240.0257	0.00049	5240.0235	0.00045	5240.0251	0.00048
-30	120	5239.9887	-0.00022	5239.9903	-0.00019	5239.9898	-0.00019	5239.9880	-0.00023

Frequency Stability Versus Voltage									
Operating Frequency: 5240MHz									
Temp. (°C)	Power Supply (Vac)	0 Minute		2 Minute		5 Minute		10 Minute	
		Measured Frequency (MHz)	Result	Measured Frequency (MHz)	Result	Measured Frequency (MHz)	Result	Measured Frequency (MHz)	Result
20	138	5239.9912	-0.00017	5239.9913	-0.00017	5239.9924	-0.00015	5239.9903	-0.00019
	120	5239.9912	-0.00017	5239.9916	-0.00016	5239.9918	-0.00016	5239.9907	-0.00018
	102	5239.9906	-0.00018	5239.9907	-0.00018	5239.9919	-0.00015	5239.9913	-0.00017

4.7 6dB Bandwidth Measurement

4.7.1 Limits of 6dB Bandwidth Measurement

The minimum of 6dB Bandwidth Measurement is 0.5MHz.

4.7.2 Test Setup

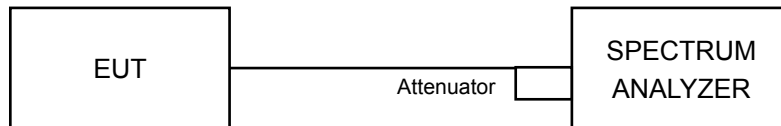

4.7.3 Test Instruments

Refer to section 4.1.2 to get information of above instrument.

4.7.4 Test Procedure

MEASUREMENT PROCEDURE REF

- a. Set resolution bandwidth (RBW) = 100kHz
- b. Set the video bandwidth (VBW) $\geq 3 \times$ RBW, Detector = Peak.
- c. Trace mode = max hold.
- d. Sweep = auto couple.
- e. Measure the maximum width of the emission that is constrained by the frequencies associated with the two amplitude points (upper and lower) that are attenuated by 6 dB relative to the maximum level measured in the fundamental emission

4.7.5 Deviation from Test Standard

No deviation.

4.7.6 EUT Operating Condition

The software provided by client to enable the EUT under transmission condition continuously at lowest, middle and highest channel frequencies individually.

4.7.7 Test Results

802.11a

Channel	Frequency (MHz)	6dB Bandwidth (MHz)		Minimum Limit (MHz)	Pass / Fail
		Chain 0	Chain 1		
149	5745	16.36	16.39	0.5	Pass
157	5785	16.36	16.37	0.5	Pass
165	5825	16.37	16.39	0.5	Pass

802.11n (HT20)

Channel	Frequency (MHz)	6dB Bandwidth (MHz)		Minimum Limit (MHz)	Pass / Fail
		Chain 0	Chain 1		
149	5745	17.01	17.58	0.5	Pass
157	5785	17.16	17.60	0.5	Pass
165	5825	17.59	17.57	0.5	Pass

802.11n (HT40)

Channel	Frequency (MHz)	6dB Bandwidth (MHz)		Minimum Limit (MHz)	Pass / Fail
		Chain 0	Chain 1		
151	5755	35.88	36.43	0.5	Pass
159	5795	36.43	36.12	0.5	Pass

802.11ac (VHT80)

Channel	Frequency (MHz)	6dB Bandwidth (MHz)		Minimum Limit (MHz)	Pass / Fail
		Chain 0	Chain 1		
155	5775	72.29	74.66	0.5	Pass

SPECTRUM PLOT OF WORST VALUE

802.11a

802.11n (HT20)

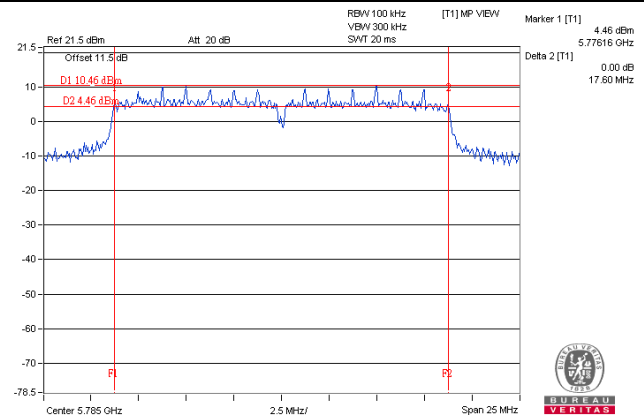
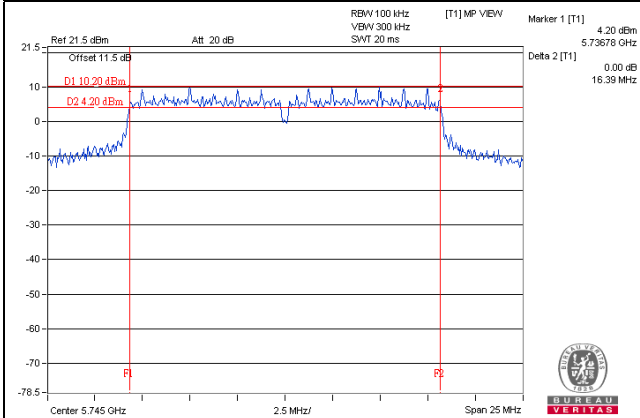

802.11n (HT40)

802.11ac (VHT80)

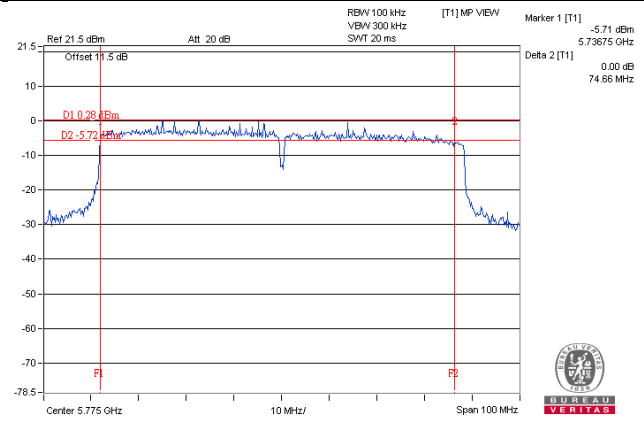
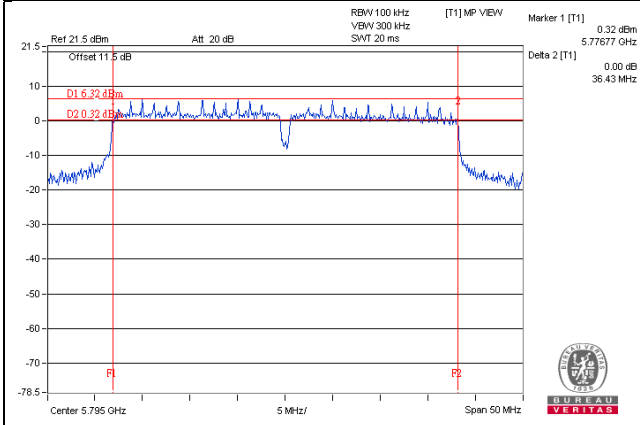

5 Pictures of Test Arrangements

Please refer to the attached file (Test Setup Photo).

Annex A- Radiated Out of Band Emission (OOBE) Measurement (For U-NII-3 band)

802.11a

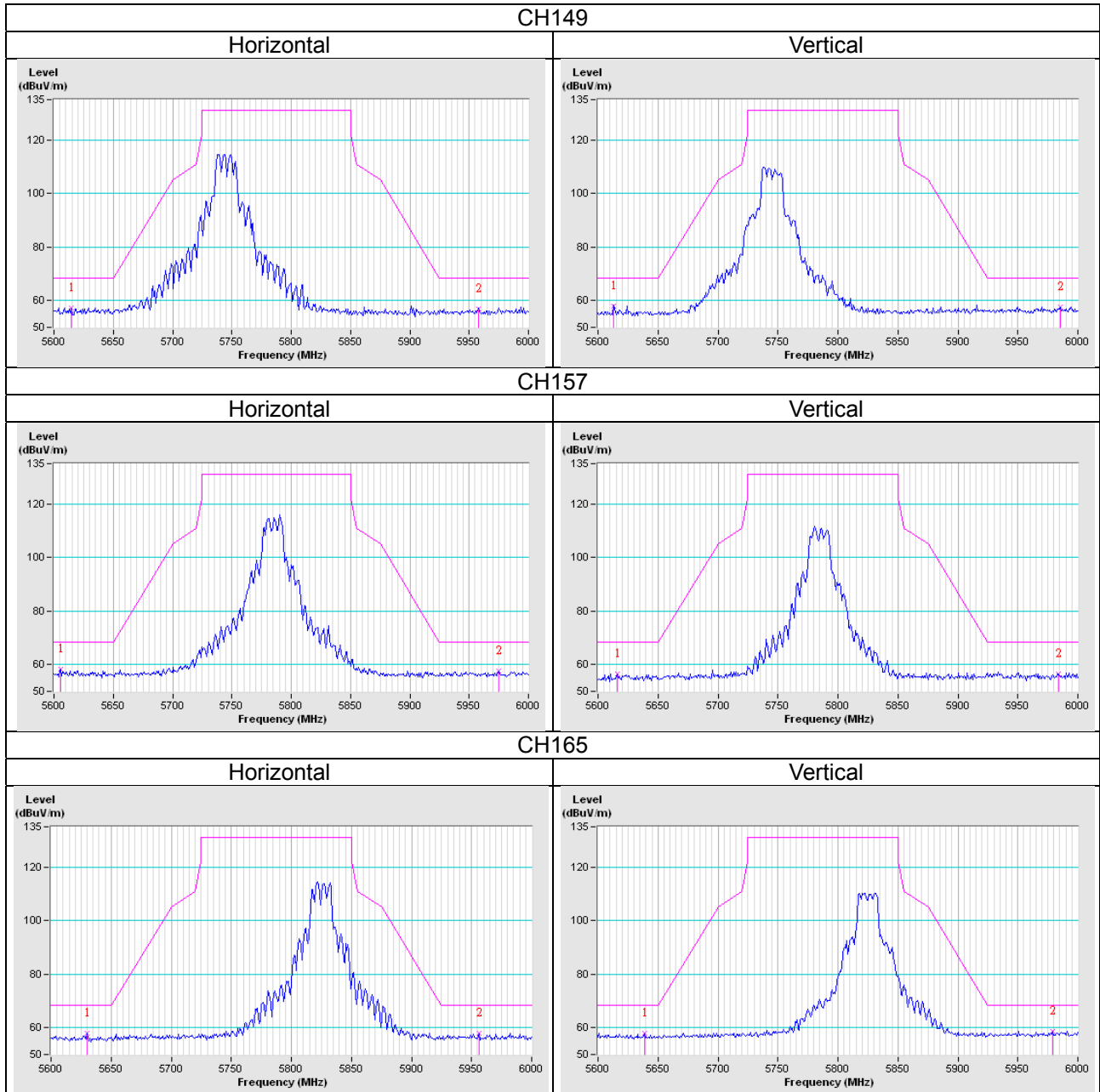

802.11n (HT20)

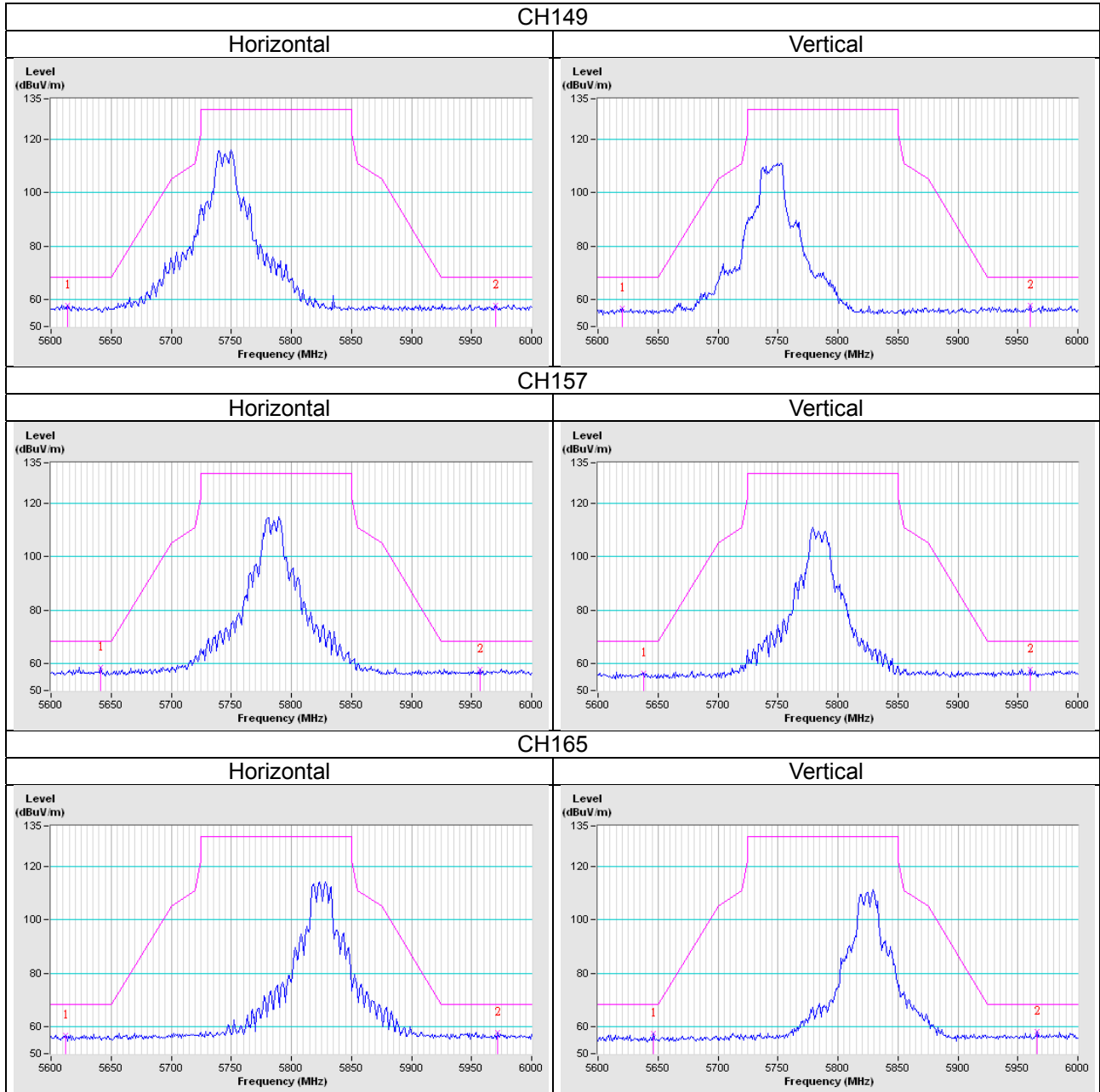

802.11n (HT40)

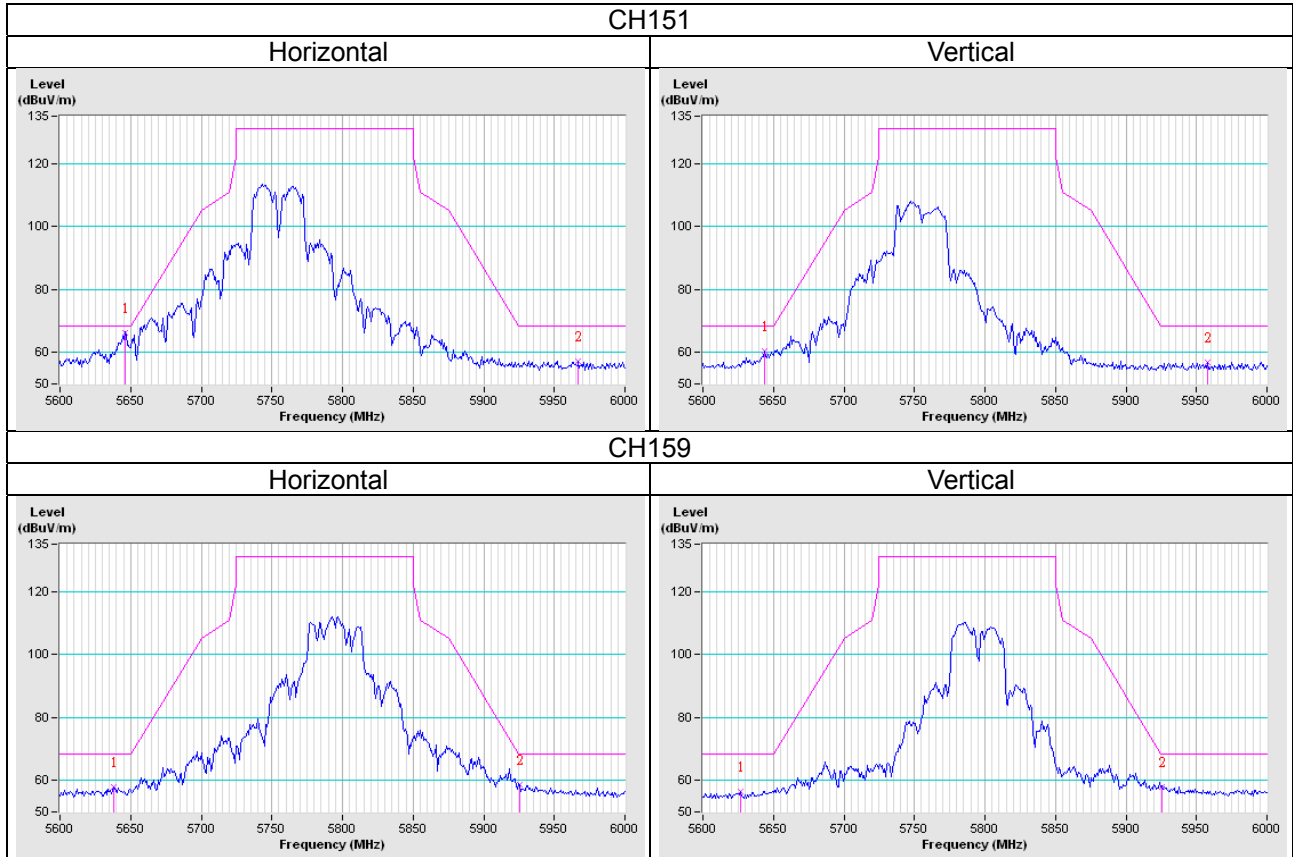

802.11ac (VHT80)

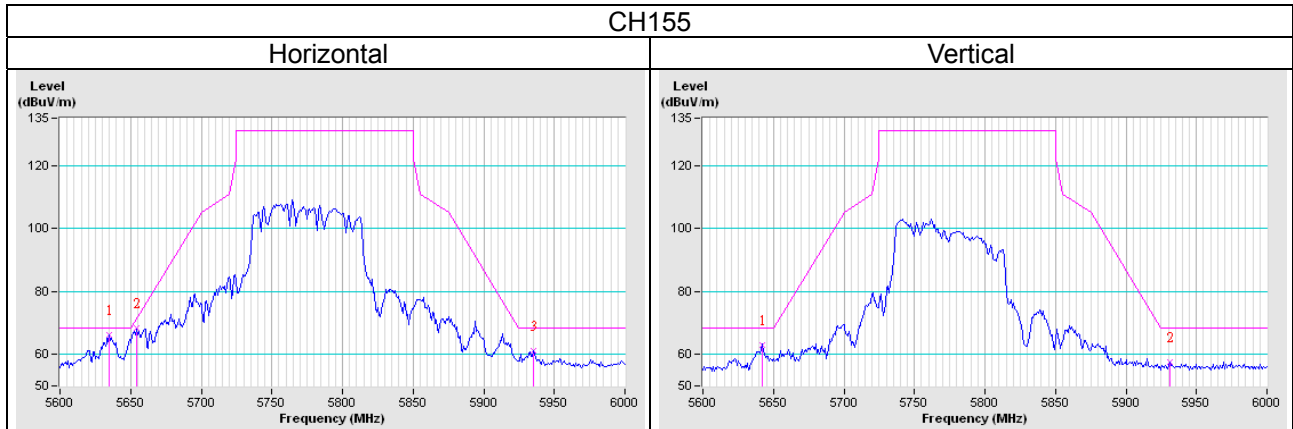

Appendix – Information on the Testing Laboratories

We, Bureau Veritas Consumer Products Services (H.K.) Ltd., Taoyuan Branch, were founded in 1988 to provide our best service in EMC, Radio, Telecom and Safety consultation. Our laboratories are accredited and approved according to ISO/IEC 17025.

If you have any comments, please feel free to contact us at the following:

Linko EMC/RF Lab

Tel: 886-2-26052180

Fax: 886-2-26051924

Hsin Chu EMC/RF/Telecom Lab

Tel: 886-3-6668565

Fax: 886-3-6668323

Hwa Ya EMC/RF/Safety Lab

Tel: 886-3-3183232

Fax: 886-3-3270892

Email: service.adt@tw.bureauveritas.com

Web Site: www.bureauveritas-adt.com

The address and road map of all our labs can be found in our web site also.

--- END ---