

## FCC Test Report

**Report No.:** RF170202C15-2

**FCC ID:** A8J-EMR3000V2

**Model:** EMR3000v2

**Received Date:** Feb. 02, 2017

**Test Date:** Feb. 22 ~ Feb. 24, 2017

**Issued Date:** Mar. 07, 2017

**Applicant:** EnGenius Technologies

**Address:** 1580 Scenic Avenue, Costa Mesa, CA92626

**Issued By:** Bureau Veritas Consumer Products Services (H.K.) Ltd., Taoyuan Branch

**Lab Address:** No. 47-2, 14th Ling, Chia Pau Vil., Lin Kou Dist., New Taipei City, Taiwan, R.O.C.

**Test Location:** No.19, Hwa Ya 2nd Rd., Wen Hwa Vil., Kwei Shan Dist., Taoyuan City 33383, TAIWAN (R.O.C.)



This report is for your exclusive use. Any copying or replication of this report to or for any other person or entity, or use of our name or trademark, is permitted only with our prior written permission. This report sets forth our findings solely with respect to the test samples identified herein. The results set forth in this report are not indicative or representative of the quality or characteristics of the lot from which a test sample was taken or any similar or identical product unless specifically and expressly noted. Our report includes all of the tests requested by you and the results thereof based upon the information that you provided to us. You have 60 days from date of issuance of this report to notify us of any material error or omission caused by our negligence, provided, however, that such notice shall be in writing and shall specifically address the issue you wish to raise. A failure to raise such issue within the prescribed time shall constitute your unqualified acceptance of the completeness of this report, the tests conducted and the correctness of the report contents. Unless specific mention, the uncertainty of measurement has been explicitly taken into account to declare the compliance or non-compliance to the specification. This report should not be used by the client to claim product certification, approval, or endorsement by TAF or any government agencies.

## Table of Contents

<b>Release Control Record</b> .....	<b>4</b>
<b>1 Certificate of Conformity</b> .....	<b>5</b>
<b>2 Summary of Test Results</b> .....	<b>6</b>
2.1 Measurement Uncertainty.....	6
2.2 Modification Record.....	6
<b>3 General Information</b> .....	<b>7</b>
3.1 General Description of EUT.....	7
3.2 Description of Test Modes.....	9
3.2.1 Test Mode Applicability and Tested Channel Detail.....	10
3.3 Description of Support Units.....	12
3.3.1 Configuration of System under Test.....	12
3.4 General Description of Applied Standards.....	13
<b>4 Test Types and Results</b> .....	<b>14</b>
4.1 Radiated Emission and Bandedge Measurement.....	14
4.1.1 Limits of Radiated Emission and Bandedge Measurement.....	14
4.1.2 Test Instruments.....	15
4.1.3 Test Procedures.....	16
4.1.4 Deviation from Test Standard.....	16
4.1.5 Test Set Up.....	17
4.1.6 EUT Operating Conditions.....	18
4.1.7 Test Results.....	19
4.2 Conducted Emission Measurement.....	23
4.2.1 Limits of Conducted Emission Measurement.....	23
4.2.2 Test Instruments.....	23
4.2.3 Test Procedures.....	23
4.2.4 Deviation from Test Standard.....	24
4.2.5 Test Setup.....	24
4.2.6 EUT Operating Conditions.....	24
4.2.7 Test Results.....	25
4.3 6dB Bandwidth Measurement.....	27
4.3.1 Limits of 6dB Bandwidth Measurement.....	27
4.3.2 Test Setup.....	27
4.3.3 Test Instruments.....	27
4.3.4 Test Procedure.....	27
4.3.5 Deviation from Test Standard.....	27
4.3.6 EUT Operating Conditions.....	27
4.3.7 Test Result.....	28
4.4 Conducted Output Power Measurement.....	29
4.4.1 Limits of Conducted Output Power Measurement.....	29
4.4.2 Test Setup.....	29
4.4.3 Test Instruments.....	29
4.4.4 Test Procedures.....	29
4.4.5 Deviation from Test Standard.....	29
4.4.6 EUT Operating Conditions.....	29
4.4.7 Test Results.....	29
4.5 Power Spectral Density Measurement.....	30
4.5.1 Limits of Power Spectral Density Measurement.....	30
4.5.2 Test Setup.....	30
4.5.3 Test Instruments.....	30
4.5.4 Test Procedure.....	30
4.5.5 Deviation from Test Standard.....	30
4.5.6 EUT Operating Condition.....	30
4.5.7 Test Results.....	31

4.6	Conducted Out of Band Emission Measurement.....	32
4.6.1	Limits of Conducted Out of Band Emission Measurement .....	32
4.6.2	Test Setup.....	32
4.6.3	Test Instruments .....	32
4.6.4	Test Procedure .....	32
4.6.5	Deviation from Test Standard .....	33
4.6.6	EUT Operating Condition .....	33
4.6.7	Test Results .....	33
<b>5</b>	<b>Pictures of Test Arrangements.....</b>	<b>35</b>
	<b>Appendix – Information on the Testing Laboratories .....</b>	<b>36</b>

### Release Control Record

Issue No.	Description	Date Issued
RF170202C15-2	Original release	Mar. 07, 2017

## 1 Certificate of Conformity

**Product:** AC1200 Mesh Router

**Brand:** EnGenius

**Model:** EMR3000v2

**Sample Status:** Engineering sample

**Applicant:** EnGenius Technologies

**Test Date:** Feb. 22 ~ Feb. 24, 2017

**Standards:** 47 CFR FCC Part 15, Subpart C (Section 15.247)  
ANSI C63.10:2013

The above equipment has been tested by **Bureau Veritas Consumer Products Services (H.K.) Ltd., Taoyuan Branch**, and found compliance with the requirement of the above standards. The test record, data evaluation & Equipment Under Test (EUT) configurations represented herein are true and accurate accounts of the measurements of the sample's EMC characteristics under the conditions specified in this report.

**Prepared by :**  , **Date:** Mar. 07, 2017  
Polly Chien / Specialist

**Approved by :**  , **Date:** Mar. 07, 2017  
Ken Liu / Senior Manager

## 2 Summary of Test Results

47 CFR FCC Part 15, Subpart C (Section 15.247)			
FCC Clause	Test Item	Result	Remarks
15.207	AC Power Conducted Emission	Pass	Meet the requirement of limit. Minimum passing margin is -18.58dB at 0.65439MHz
15.205 / 15.209 / 15.247(d)	Radiated Emissions and Band Edge Measurement	Pass	Meet the requirement of limit. Minimum passing margin is -2.8dB at 53.23MHz.
15.247(d)	Antenna Port Emission	Pass	Meet the requirement of limit.
15.247(a)(2)	6dB bandwidth	Pass	Meet the requirement of limit.
15.247(b)	Conducted power	Pass	Meet the requirement of limit.
15.247(e)	Power Spectral Density	Pass	Meet the requirement of limit.
15.203	Antenna Requirement	Pass	No antenna connector is used.

### 2.1 Measurement Uncertainty

Where relevant, the following measurement uncertainty levels have been estimated for tests performed on the EUT as specified in CISPR 16-4-2:

Measurement	Frequency	Expanded Uncertainty (k=2) ( $\pm$ )
Conducted Emissions at mains ports	150kHz ~ 30MHz	2.44 dB
Radiated Emissions up to 1 GHz	30MHz ~ 200MHz	3.86 dB
	200MHz ~ 1000MHz	3.87 dB
Radiated Emissions above 1 GHz	1GHz ~ 18GHz	2.29 dB
	18GHz ~ 40GHz	2.29 dB

### 2.2 Modification Record

There were no modifications required for compliance.

### 3 General Information

#### 3.1 General Description of EUT

Product	AC1200 Mesh Router
Brand	EnGenius
Model	EMR3000v2
Sample Status	Engineering sample
Power Supply Rating	12Vdc from adapter
Modulation Type	GFSK
Transfer Rate	1Mbps
Operating Frequency	2402 ~ 2480MHz
Number of Channel	40
Channel Spacing	2MHz
Output Power	11.695mW
Antenna Type	Refer to note
Antenna Connector	Refer to note
Accessory Device	Adapter
Data Cable Supplied	0.45m RJ45 non-shielded cable without core

Note:

1. The EUT uses following adapter.

Brand	Skypowercom
Model	ZZU1588-150120-2A
Input Power	100-240Vac, 1.5A Max, 50-60Hz
Output Power	12Vdc, 1.5A
Power Line	1.5m cable without core attached on adapter

2. The following antennas were provided to the EUT.

Ant. No.	1	2	3	4	5 (BT)
Ant. Type	PIFA				
Frequency (MHz)	2400-2500		5150-5850		2400-2500
Pesk Gain (dBi)	3.1	4.7	5.5	5.5	1.4
Connector	IPEX				NA

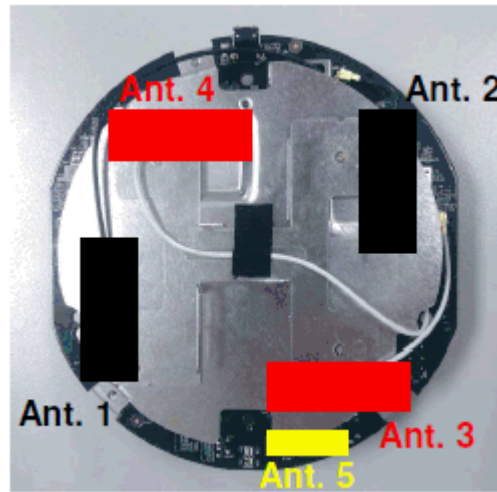
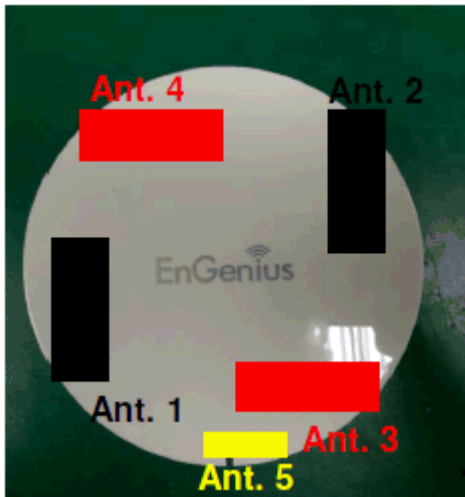

- Spurious emission of the simultaneous operation (2.4GHz, 5GHz and BT) has been evaluated and no non-compliance was found.
- The above EUT information is declared by manufacturer and for more detailed features description, please refer to the manufacturer's specifications or user's manual.



### 3.2 Description of Test Modes

40 channels are provided to this EUT:

Channel	Freq. (MHz)	Channel	Freq. (MHz)	Channel	Freq. (MHz)	Channel	Freq. (MHz)
0	2402	10	2422	20	2442	30	2462
1	2404	11	2424	21	2444	31	2464
2	2406	12	2426	22	2446	32	2466
3	2408	13	2428	23	2448	33	2468
4	2410	14	2430	24	2450	34	2470
5	2412	15	2432	25	2452	35	2472
6	2414	16	2434	26	2454	36	2474
7	2416	17	2436	27	2456	37	2476
8	2418	18	2438	28	2458	38	2478
9	2420	19	2440	29	2460	39	2480

### 3.2.1 Test Mode Applicability and Tested Channel Detail

EUT CONFIGURE MODE	APPLICABLE TO				DESCRIPTION
	RE $\geq$ 1G	RE<1G	PLC	APCM	
-	√	√	√	√	-

Where RE $\geq$ 1G: Radiated Emission above 1GHz & Bandedge Measurement  
 RE<1G: Radiated Emission below 1GHz  
 PLC: Power Line Conducted Emission  
 APCM: Antenna Port Conducted Measurement

Note: The EUT had been pre-tested on the positioned of each 3 axis. The worst case was found when positioned on **X-plane**.

#### Radiated Emission Test (Above 1GHz):

- Pre-Scan has been conducted to determine the worst-case mode from all possible combinations between available modulations, data rates and antenna ports (if EUT with antenna diversity architecture).
- Following channel(s) was (were) selected for the final test as listed below.

EUT CONFIGURE MODE	AVAILABLE CHANNEL	TESTED CHANNEL	MODULATION TYPE	DATA RATE (Mbps)
-	0 to 39	0, 19, 39	GFSK	1

#### Radiated Emission Test (Below 1GHz):

- Pre-Scan has been conducted to determine the worst-case mode from all possible combinations between available modulations, data rates and antenna ports (if EUT with antenna diversity architecture).
- Following channel(s) was (were) selected for the final test as listed below.

EUT CONFIGURE MODE	AVAILABLE CHANNEL	TESTED CHANNEL	MODULATION TYPE	DATA RATE (Mbps)
-	0 to 39	0	GFSK	1

#### Power Line Conducted Emission Test:

- Pre-Scan has been conducted to determine the worst-case mode from all possible combinations between available modulations, data rates and antenna ports (if EUT with antenna diversity architecture).
- Following channel(s) was (were) selected for the final test as listed below.

EUT CONFIGURE MODE	AVAILABLE CHANNEL	TESTED CHANNEL	MODULATION TYPE	DATA RATE (Mbps)
-	0 to 39	0	GFSK	1

Antenna Port Conducted Measurement:

- This item includes all test value of each mode, but only includes spectrum plot of worst value of each mode.
- Pre-Scan has been conducted to determine the worst-case mode from all possible combinations between available modulations, data rates and antenna ports (if EUT with antenna diversity architecture).
- Following channel(s) was (were) selected for the final test as listed below.

EUT CONFIGUURE MODE	AVAILABLE CHANNEL	TESTED CHANNEL	MODULATION TYPE	DATA RATE (Mbps)
-	0 to 39	0, 19, 39	GFSK	1

Test Condition:

APPLICABLE TO	ENVIRONMENTAL CONDITIONS	INPUT POWER	TESTED BY
RE $\geq$ 1G	20deg. C, 66%RH	120Vac, 60Hz	Jones Chang
RE<1G	20deg. C, 66%RH	120Vac, 60Hz	Jones Chang
PLC	21deg. C, 70%RH	120Vac, 60Hz	Jones Chang
APCM	25deg. C, 60%RH	120Vac, 60Hz	Leo Tsai

### 3.3 Description of Support Units

The EUT has been tested as an independent unit together with other necessary accessories or support units. The following support units or accessories were used to form a representative test configuration during the tests.

ID	Product	Brand	Model No.	Serial No.	FCC ID	Remarks
A.	Notebook	DELL	E5410	1HC2XM1	FCC DoC Approved	-
B.	USB Flash	HP	v250W	01	N/A	-
C.	Load	N/A	N/A	N/A	N/A	-

Note:

1. All power cords of the above support units are non-shielded (1.8m).
2. Item A acted as a communication partner to transfer data.

ID	Descriptions	Qty.	Length (m)	Shielding (Yes/No)	Cores (Qty.)	Remarks
1.	LAN cable	1	1.2	N	0	-
2.	LAN cable	1	3	N	0	-

#### 3.3.1 Configuration of System under Test

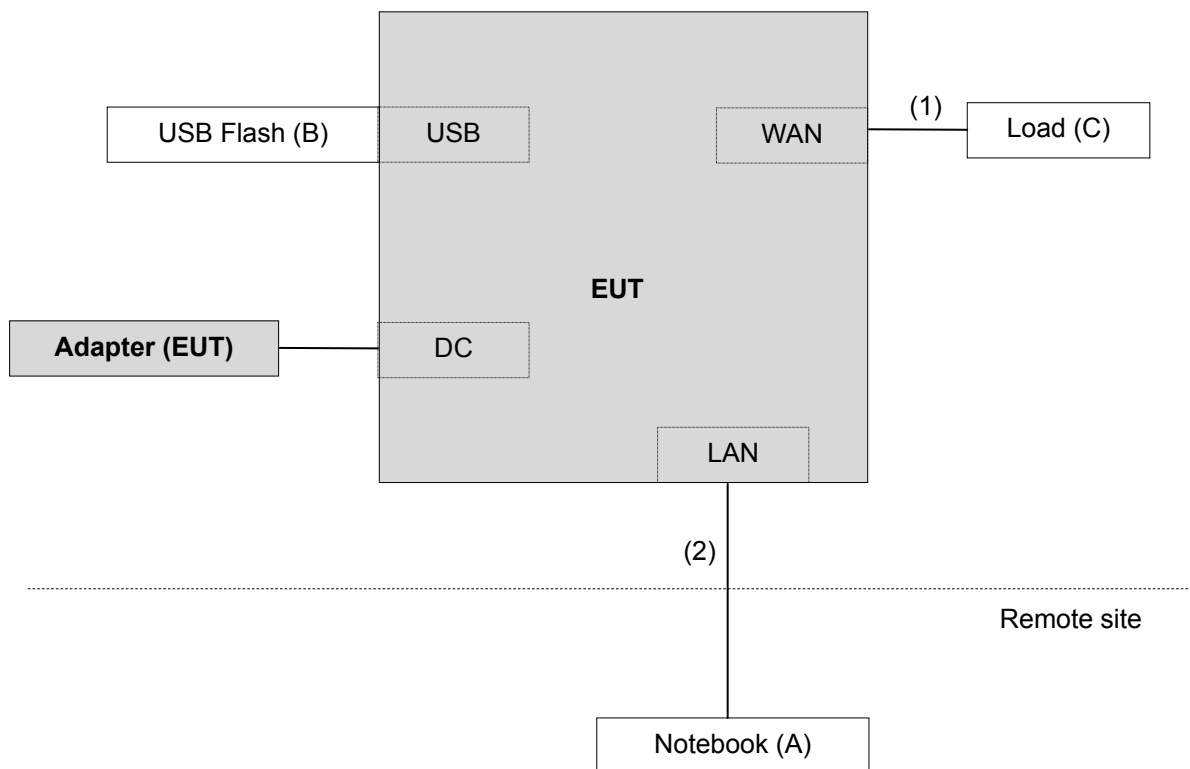

### 3.4 General Description of Applied Standards

The EUT is a RF Product. According to the specifications of the manufacturer, it must comply with the requirements of the following standards:

**FCC Part 15, Subpart C (15.247)**

**KDB 558074 D01 DTS Meas Guidance v04**

ANSI C63.10-2013

All test items have been performed and recorded as per the above standards.

Note: The EUT is also considered as a kind of computer peripheral, because the connection to computer is necessary for typical use. It has been verified to comply with the requirements of FCC Part 15, Subpart B, Class B (DoC). The test report has been issued separately.

## 4 Test Types and Results

### 4.1 Radiated Emission and Bandedge Measurement

#### 4.1.1 Limits of Radiated Emission and Bandedge Measurement

Radiated emissions which fall in the restricted bands must comply with the radiated emission limits specified as below table. Other emissions shall be at least 20dB below the highest level of the desired power:

Frequencies (MHz)	Field Strength (microvolts/meter)	Measurement Distance (meters)
0.009 ~ 0.490	2400/F(kHz)	300
0.490 ~ 1.705	24000/F(kHz)	30
1.705 ~ 30.0	30	30
30 ~ 88	100	3
88 ~ 216	150	3
216 ~ 960	200	3
Above 960	500	3

**Note:**

1. The lower limit shall apply at the transition frequencies.
2. Emission level (dBuV/m) = 20 log Emission level (uV/m).
3. For frequencies above 1000MHz, the field strength limits are based on average detector, however, the peak field strength of any emission shall not exceed the maximum permitted average limits, specified above by more than 20dB under any condition of modulation.

#### 4.1.2 Test Instruments

Description & Manufacturer	Model No.	Serial No.	Cal. Date	Cal. Due
Test Receiver ROHDE & SCHWARZ	ESIB7	100187	Apr. 18, 2016	Apr. 17, 2017
Spectrum Analyzer ROHDE & SCHWARZ	FSP40	100041	Nov. 16, 2016	Nov. 15, 2017
BILOG Antenna SCHWARZBECK	VULB9168	9168-171	Dec. 28, 2016	Dec. 27, 2017
HORN Antenna SCHWARZBECK	9120D	209	Dec. 27, 2016	Dec. 26, 2017
HORN Antenna SCHWARZBECK	BBHA 9170	BBHA9170241	Dec. 14, 2016	Dec. 13, 2017
Loop Antenna	EM-6879	269	Aug. 11, 2016	Aug. 10, 2017
Preamplifier Agilent	8447D	2944A10738	Aug. 22, 2016	Aug. 21, 2017
Preamplifier Agilent	8449B	3008A01964	Aug. 22, 2016	Aug. 21, 2017
RF signal cable HUBER+SUHNER	SUCOFLEX 104	Cable-CH3-03 (214378)	Aug. 22, 2016	Aug. 21, 2017
RF signal cable HUBER+SUHNER	SUCOFLEX 106	Cable-CH3-03 (309224+12738)	Aug. 22, 2016	Aug. 21, 2017
Software BV ADT	ADT_Radiated_ V7.6.15.9.4	NA	NA	NA
Antenna Tower inn-co GmbH	MA 4000	013303	NA	NA
Antenna Tower Controller BV ADT	AT100	AT93021702	NA	NA
Turn Table BV ADT	TT100	TT93021702	NA	NA
Turn Table Controller BV ADT	SC100	SC93021702	NA	NA
High Speed Peak Power Meter	ML2495A	0824011	Jul. 09, 2016	Jul. 08, 2017
Power Sensor	MA2411B	0738171	Jul. 09, 2016	Jul. 08, 2017

- Note:
1. The calibration interval of the above test instruments is 12 months and the calibrations are traceable to NML/ROC and NIST/USA.
  2. The test was performed in HwaYa Chamber 3.
  3. The horn antenna and preamplifier (model: 8449B) are used only for the measurement of emission frequency above 1GHz if tested.
  4. The FCC Site Registration No. is 988962.
  5. The IC Site Registration No. is IC 7450F-3.

### 4.1.3 Test Procedures

#### For Radiated emission below 30MHz

- a. The EUT was placed on the top of a rotating table 0.8 meters above the ground at a 3 meter chamber room. The table was rotated 360 degrees to determine the position of the highest radiation.
- b. The EUT was set 3 meters away from the interference-receiving antenna, which was mounted on the top of a variable-height antenna tower.
- c. Both X and Y axes of the antenna are set to make the measurement.
- d. For each suspected emission, the EUT was arranged to its worst case and the rotatable table was turned from 0 degrees to 360 degrees to find the maximum reading.
- e. The test-receiver system was set to Quasi-Peak Detect Function and Specified Bandwidth with Maximum Hold Mode.

#### NOTE:

1. The resolution bandwidth and video bandwidth of test receiver/spectrum analyzer is 9kHz at frequency below 30MHz.

#### For Radiated emission above 30MHz

- a. The EUT was placed on the top of a rotating table 0.8 meters (for 30MHz ~ 1GHz) / 1.5 meters (for above 1GHz) above the ground at 3 meter chamber room for test. The table was rotated 360 degrees to determine the position of the highest radiation.
- b. The EUT was set 3 meters away from the interference-receiving antenna, which was mounted on the top of a variable-height antenna tower.
- c. The height of antenna is varied from one meter to four meters above the ground to determine the maximum value of the field strength. Both horizontal and vertical polarizations of the antenna are set to make the measurement.
- d. For each suspected emission, the EUT was arranged to its worst case and then the antenna was tuned to heights from 1 meter to 4 meters and the rotatable table was turned from 0 degrees to 360 degrees to find the maximum reading.
- e. The test-receiver system was set to quasi-peak detect function and specified bandwidth with maximum hold mode when the test frequency is below 1 GHz.
- f. The test-receiver system was set to peak and average detect function and specified bandwidth with maximum hold mode when the test frequency is above 1 GHz. If the peak reading value also meets average limit, measurement with the average detector is unnecessary.

#### Note:

1. The resolution bandwidth and video bandwidth of test receiver/spectrum analyzer is 120kHz for Quasi-peak detection (QP) at frequency below 1GHz.
2. The resolution bandwidth of test receiver/spectrum analyzer is 1 MHz and the video bandwidth is 3 MHz for Peak detection (PK) at frequency above 1GHz.
3. The resolution bandwidth of test receiver/spectrum analyzer is 1 MHz and the video bandwidth is  $\geq 1/T$  (Duty cycle < 98%) or 3 x RBW (Duty cycle  $\geq 98\%$ ) for RMS detection (AV) at frequency above 1GHz.
4. All modes of operation were investigated and the worst-case emissions are reported.

### 4.1.4 Deviation from Test Standard

No deviation.



#### 4.1.5 Test Set Up

##### For Radiated emission below 30MHz

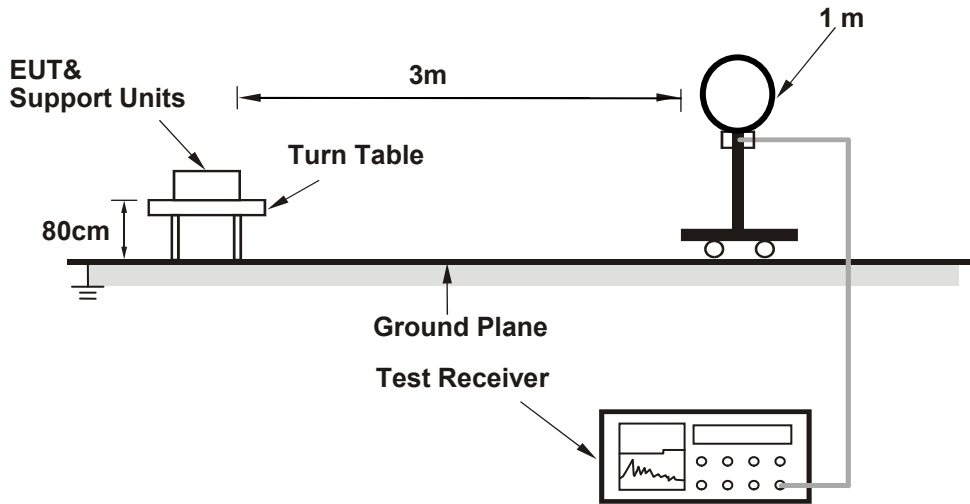

##### For Radiated emission 30MHz to 1GHz

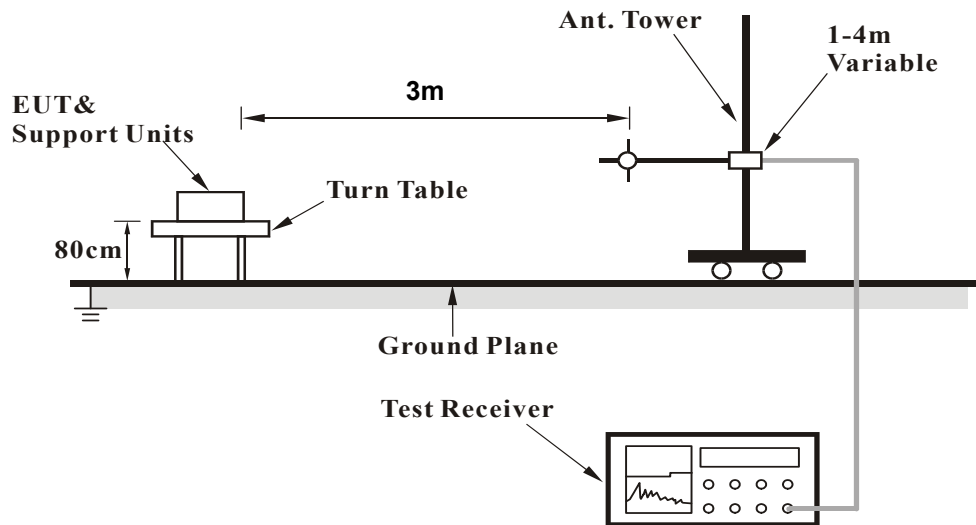

**For Radiated emission above 1GHz**

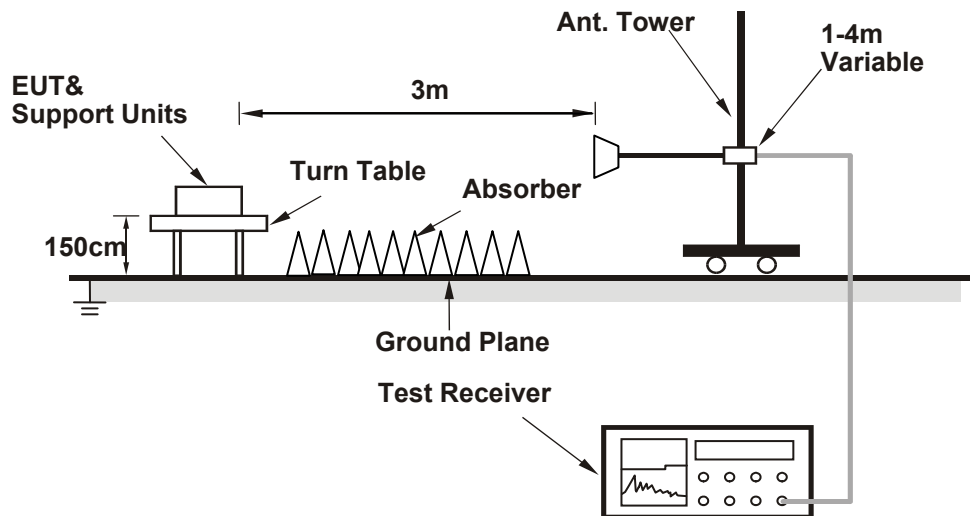

For the actual test configuration, please refer to the attached file (Test Setup Photo).

**4.1.6 EUT Operating Conditions**

- a. Placed the EUT on the testing table.
- b. Prepared notebook to act as a communication partner and placed it outside of testing area.
- c. The communication partner connected with EUT via a RJ45 cable and ran a test program (provided by manufacturer) to enable EUT under transmission condition continuously at specific channel frequency.
- d. The communication partner sent data to EUT by command "PING".
- e. The necessary accessories enable the system in full functions.

#### 4.1.7 Test Results

Above 1GHz worst-case data:

CHANNEL	TX Channel 0	DETECTOR FUNCTION	Peak (PK)
FREQUENCY RANGE	1GHz ~ 25GHz		Average (AV)

ANTENNA POLARITY & TEST DISTANCE: HORIZONTAL AT 3 M								
NO.	FREQ. (MHz)	EMISSION LEVEL (dBuV/m)	LIMIT (dBuV/m)	MARGIN (dB)	ANTENNA HEIGHT (m)	TABLE ANGLE (Degree)	RAW VALUE (dBuV)	CORRECTION FACTOR (dB/m)
1	2390.00	55.1 PK	74.0	-18.9	2.34 H	223	24.10	31.00
2	2390.00	43.1 AV	54.0	-10.9	2.34 H	223	12.10	31.00
3	*2402.00	101.8 PK			2.34 H	223	70.60	31.20
4	*2402.00	96.7 AV			2.34 H	223	65.50	31.20
5	4804.00	51.7 PK	74.0	-22.3	2.70 H	183	51.30	0.40
6	4804.00	46.1 AV	54.0	-7.9	2.70 H	183	45.70	0.40
7	#7206.00	57.2 PK	74.0	-16.8	2.13 H	280	50.10	7.10
8	#7206.00	48.7 AV	54.0	-5.3	2.13 H	280	41.60	7.10
9	12010.00	60.0 PK	74.0	-14.0	2.21 H	105	46.70	13.30
10	12010.00	49.8 AV	54.0	-4.2	2.21 H	105	36.50	13.30

ANTENNA POLARITY & TEST DISTANCE: VERTICAL AT 3 M								
NO.	FREQ. (MHz)	EMISSION LEVEL (dBuV/m)	LIMIT (dBuV/m)	MARGIN (dB)	ANTENNA HEIGHT (m)	TABLE ANGLE (Degree)	RAW VALUE (dBuV)	CORRECTION FACTOR (dB/m)
1	2390.00	53.4 PK	74.0	-20.6	2.14 V	132	22.40	31.00
2	2390.00	42.8 AV	54.0	-11.2	2.14 V	132	11.80	31.00
3	*2402.00	94.8 PK			2.14 V	132	63.60	31.20
4	*2402.00	90.1 AV			2.14 V	132	58.90	31.20
5	4804.00	47.9 PK	74.0	-26.1	2.16 V	38	47.50	0.40
6	4804.00	40.1 AV	54.0	-13.9	2.16 V	38	39.70	0.40
7	#7206.00	55.0 PK	74.0	-19.0	2.34 V	161	47.90	7.10
8	#7206.00	46.9 AV	54.0	-7.1	2.34 V	161	39.80	7.10
9	12010.00	59.6 PK	74.0	-14.4	2.56 V	146	46.30	13.30
10	12010.00	48.8 AV	54.0	-5.2	2.56 V	146	35.50	13.30

Remarks:

1. Emission Level(dBuV/m) = Raw Value(dBuV) + Correction Factor(dB/m)
2. Correction Factor(dB/m) = Antenna Factor(dB/m) + Cable Factor(dB) – Pre-Amplifier Factor(dB)
3. The other emission levels were very low against the limit.
4. Margin value = Emission Level – Limit value
5. " \* ": Fundamental frequency.
6. " # ": The radiated frequency is out of the restricted band.

CHANNEL	TX Channel 19	DETECTOR FUNCTION	Peak (PK)
FREQUENCY RANGE	1GHz ~ 25GHz		Average (AV)

**ANTENNA POLARITY & TEST DISTANCE: HORIZONTAL AT 3 M**

NO.	FREQ. (MHz)	EMISSION LEVEL (dBuV/m)	LIMIT (dBuV/m)	MARGIN (dB)	ANTENNA HEIGHT (m)	TABLE ANGLE (Degree)	RAW VALUE (dBuV)	CORRECTION FACTOR (dB/m)
1	*2440.00	99.7 PK			1.68 H	162	68.40	31.30
2	*2440.00	94.7 AV			1.68 H	162	63.40	31.30
3	4880.00	49.8 PK	74.0	-24.2	2.42 H	0	49.20	0.60
4	4880.00	44.1 AV	54.0	-9.9	2.42 H	0	43.50	0.60
5	7320.00	56.6 PK	74.0	-17.4	2.49 H	188	49.50	7.10
6	7320.00	50.3 AV	54.0	-3.7	2.49 H	188	43.20	7.10
7	12200.00	59.3 PK	74.0	-14.7	2.26 H	141	46.20	13.10
8	12200.00	48.7 AV	54.0	-5.3	2.26 H	141	35.60	13.10

**ANTENNA POLARITY & TEST DISTANCE: VERTICAL AT 3 M**

NO.	FREQ. (MHz)	EMISSION LEVEL (dBuV/m)	LIMIT (dBuV/m)	MARGIN (dB)	ANTENNA HEIGHT (m)	TABLE ANGLE (Degree)	RAW VALUE (dBuV)	CORRECTION FACTOR (dB/m)
1	*2440.00	94.0 PK			2.61 V	34	62.70	31.30
2	*2440.00	89.2 AV			2.61 V	34	57.90	31.30
3	4880.00	47.3 PK	74.0	-26.7	2.31 V	41	46.70	0.60
4	4880.00	37.4 AV	54.0	-16.6	2.31 V	41	36.80	0.60
5	7320.00	53.6 PK	74.0	-20.4	2.32 V	161	46.50	7.10
6	7320.00	44.8 AV	54.0	-9.2	2.32 V	161	37.70	7.10
7	12200.00	58.8 PK	74.0	-15.2	2.37 V	148	45.70	13.10
8	12200.00	48.0 AV	54.0	-6.0	2.37 V	148	34.90	13.10

Remarks:

1. Emission Level(dBuV/m) = Raw Value(dBuV) + Correction Factor(dB/m)
2. Correction Factor(dB/m) = Antenna Factor(dB/m) + Cable Factor(dB) – Pre-Amplifier Factor(dB)
3. The other emission levels were very low against the limit.
4. Margin value = Emission Level – Limit value
5. " \* ": Fundamental frequency.

CHANNEL	TX Channel 39	DETECTOR FUNCTION	Peak (PK)
FREQUENCY RANGE	1GHz ~ 25GHz		Average (AV)

**ANTENNA POLARITY & TEST DISTANCE: HORIZONTAL AT 3 M**

NO.	FREQ. (MHz)	EMISSION LEVEL (dBuV/m)	LIMIT (dBuV/m)	MARGIN (dB)	ANTENNA HEIGHT (m)	TABLE ANGLE (Degree)	RAW VALUE (dBuV)	CORRECTION FACTOR (dB/m)
1	*2480.00	99.5 PK			1.69 H	102	68.00	31.50
2	*2480.00	95.5 AV			1.69 H	102	64.00	31.50
3	2483.50	52.9 PK	74.0	-21.1	1.69 H	102	21.40	31.50
4	2483.50	43.6 AV	54.0	-10.4	1.69 H	102	12.10	31.50
5	4960.00	49.6 PK	74.0	-24.4	2.83 H	182	48.80	0.80
6	4960.00	43.1 AV	54.0	-10.9	2.83 H	182	42.30	0.80
7	7440.00	56.3 PK	74.0	-17.7	1.90 H	318	49.10	7.20
8	7440.00	48.6 AV	54.0	-5.4	1.90 H	318	41.40	7.20
9	12400.00	60.1 PK	74.0	-13.9	2.25 H	39	46.20	13.90
10	12400.00	48.4 AV	54.0	-5.6	2.25 H	39	34.50	13.90

**ANTENNA POLARITY & TEST DISTANCE: VERTICAL AT 3 M**

NO.	FREQ. (MHz)	EMISSION LEVEL (dBuV/m)	LIMIT (dBuV/m)	MARGIN (dB)	ANTENNA HEIGHT (m)	TABLE ANGLE (Degree)	RAW VALUE (dBuV)	CORRECTION FACTOR (dB/m)
1	*2480.00	93.5 PK			2.71 V	28	62.00	31.50
2	*2480.00	88.8 AV			2.71 V	28	57.30	31.50
3	2483.50	54.8 PK	74.0	-19.2	2.71 V	28	23.30	31.50
4	2483.50	44.3 AV	54.0	-9.7	2.71 V	28	12.80	31.50
5	4960.00	45.8 PK	74.0	-28.2	2.41 V	31	45.00	0.80
6	4960.00	35.3 AV	54.0	-18.7	2.41 V	31	34.50	0.80
7	7440.00	55.5 PK	74.0	-18.5	2.68 V	178	48.30	7.20
8	7440.00	46.5 AV	54.0	-7.5	2.68 V	178	39.30	7.20
9	12400.00	59.9 PK	74.0	-14.1	2.38 V	145	46.00	13.90
10	12400.00	46.6 AV	54.0	-7.4	2.38 V	145	32.70	13.90

Remarks:

1. Emission Level(dBuV/m) = Raw Value(dBuV) + Correction Factor(dB/m)
2. Correction Factor(dB/m) = Antenna Factor(dB/m) + Cable Factor(dB) – Pre-Amplifier Factor(dB)
3. The other emission levels were very low against the limit.
4. Margin value = Emission Level – Limit value
5. " \* ": Fundamental frequency.

Below 1GHz worst-case data:

CHANNEL	TX Channel 0	DETECTOR FUNCTION	Quasi-Peak (QP)
FREQUENCY RANGE	9kHz ~ 1GHz		

ANTENNA POLARITY & TEST DISTANCE: HORIZONTAL AT 3 M								
NO.	FREQ. (MHz)	EMISSION LEVEL (dBuV/m)	LIMIT (dBuV/m)	MARGIN (dB)	ANTENNA HEIGHT (m)	TABLE ANGLE (Degree)	RAW VALUE (dBuV)	CORRECTION FACTOR (dB/m)
1	57.12	27.6 QP	40.0	-12.4	1.99 H	133	42.20	-14.60
2	181.55	29.1 QP	43.5	-14.4	1.99 H	259	44.20	-15.10
3	300.16	32.4 QP	46.0	-13.6	1.00 H	253	44.40	-12.00
4	348.76	33.1 QP	46.0	-12.9	1.00 H	45	44.40	-11.30
5	500.42	35.5 QP	46.0	-10.5	1.00 H	106	43.40	-7.90
6	751.23	34.1 QP	46.0	-11.9	1.00 H	196	36.40	-2.30
ANTENNA POLARITY & TEST DISTANCE: VERTICAL AT 3 M								
NO.	FREQ. (MHz)	EMISSION LEVEL (dBuV/m)	LIMIT (dBuV/m)	MARGIN (dB)	ANTENNA HEIGHT (m)	TABLE ANGLE (Degree)	RAW VALUE (dBuV)	CORRECTION FACTOR (dB/m)
1	35.73	36.5 QP	40.0	-3.5	1.00 V	253	52.40	-15.90
<b>2</b>	<b>53.23</b>	<b>37.2 QP</b>	<b>40.0</b>	<b>-2.8</b>	<b>1.00 V</b>	<b>19</b>	<b>51.50</b>	<b>-14.30</b>
3	300.16	30.8 QP	46.0	-15.2	1.49 V	184	42.80	-12.00
4	348.76	31.6 QP	46.0	-14.4	1.49 V	95	42.90	-11.30
5	500.42	37.1 QP	46.0	-8.9	1.00 V	94	45.00	-7.90
6	747.34	33.5 QP	46.0	-12.5	1.00 V	341	35.80	-2.30

Remarks:

1. Emission Level(dBuV/m) = Raw Value(dBuV) + Correction Factor(dB/m)
2. Correction Factor(dB/m) = Antenna Factor(dB/m) + Cable Factor(dB) – Pre-Amplifier Factor(dB)
3. The other emission levels were very low against the limit.
4. Margin value = Emission Level – Limit value

## 4.2 Conducted Emission Measurement

### 4.2.1 Limits of Conducted Emission Measurement

Frequency (MHz)	Conducted Limit (dBuV)	
	Quasi-peak	Average
0.15 - 0.5	66 - 56	56 - 46
0.50 - 5.0	56	46
5.0 - 30.0	60	50

- Note:** 1. The lower limit shall apply at the transition frequencies.  
 2. The limit decreases in line with the logarithm of the frequency in the range of 0.15 to 0.50MHz.

### 4.2.2 Test Instruments

Tested date: Feb. 24, 2017

Description & Manufacturer	Model No.	Serial No.	Date Of Calibration	Due Date Of Calibration
Test Receiver ROHDE & SCHWARZ	ESCI	100613	Nov. 21, 2016	Nov. 20, 2017
RF signal cable Woken	5D-FB	Cable-cond1-01	Dec. 22, 2016	Dec. 21, 2017
LISN ROHDE & SCHWARZ (EUT)	ESH3-Z5	835239/001	Feb. 26, 2016	Feb. 25, 2017
LISN ROHDE & SCHWARZ (Peripheral)	ESH3-Z5	100311	Jul. 28, 2016	Jul. 27, 2017
Software ADT	BV ADT_Cond_ V7.3.7.3	NA	NA	NA

- Note:** 1. The calibration interval of the above test instruments is 12 months and the calibrations are traceable to NML/ROC and NIST/USA.  
 2. The test was performed in HwaYa Shielded Room 1.  
 3. The VCCI Site Registration No. is C-2040.

### 4.2.3 Test Procedures

- The EUT was placed 0.4 meters from the conducting wall of the shielded room with EUT being connected to the power mains through a line impedance stabilization network (LISN). Other support units were connected to the power mains through another LISN. The two LISNs provide 50 ohm/ 50uH of coupling impedance for the measuring instrument.
- Both lines of the power mains connected to the EUT were checked for maximum conducted interference.
- The frequency range from 150kHz to 30MHz was searched. Emission levels under (Limit - 20dB) was not recorded.

**Note:** The resolution bandwidth and video bandwidth of test receiver is 9kHz for quasi-peak detection (QP) and average detection (AV) at frequency 0.15MHz-30MHz.

#### 4.2.4 Deviation from Test Standard

No deviation.

#### 4.2.5 Test Setup

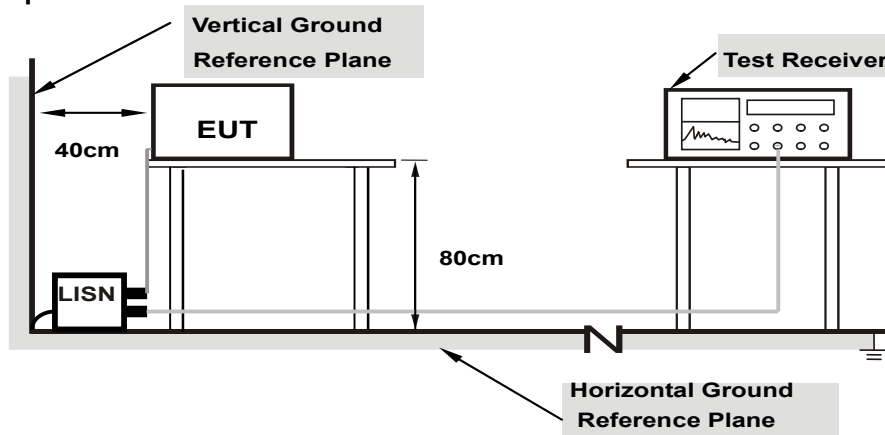

**Note:** 1.Support units were connected to second LISN.

For the actual test configuration, please refer to the attached file (Test Setup Photo).

#### 4.2.6 EUT Operating Conditions

Same as 4.1.6.



#### 4.2.7 Test Results

Phase	Line (L)	Detector Function	Quasi-Peak (QP) / Average (AV)
-------	----------	-------------------	--------------------------------

No	Freq. [MHz]	Corr. Factor (dB)	Reading Value [dB (uV)]		Emission Level [dB (uV)]		Limit [dB (uV)]		Margin (dB)	
			Q.P.	AV.	Q.P.	AV.	Q.P.	AV.	Q.P.	AV.
	1	0.16564	10.18	32.73	14.14	42.91	24.32	65.18	55.18	-22.27
2	0.19305	10.19	29.51	12.08	39.70	22.27	63.90	53.90	-24.20	-31.63
3	0.24775	10.20	23.68	8.04	33.88	18.24	61.83	51.83	-27.95	-33.59
<b>4</b>	<b>0.65439</b>	<b>10.24</b>	<b>24.27</b>	<b>17.18</b>	<b>34.51</b>	<b>27.42</b>	<b>56.00</b>	<b>46.00</b>	<b>-21.49</b>	<b>-18.58</b>
5	2.67977	10.38	12.40	4.29	22.78	14.67	56.00	46.00	-33.22	-31.33
6	21.98735	11.62	16.90	9.35	28.52	20.97	60.00	50.00	-31.48	-29.03

#### REMARKS:

1. Q.P. and AV. are abbreviations of quasi-peak and average individually.
2. The emission levels of other frequencies were very low against the limit.
3. Margin value = Emission level - Limit value
4. Correction factor = Insertion loss + Cable loss
5. Emission Level = Correction Factor + Reading Value.

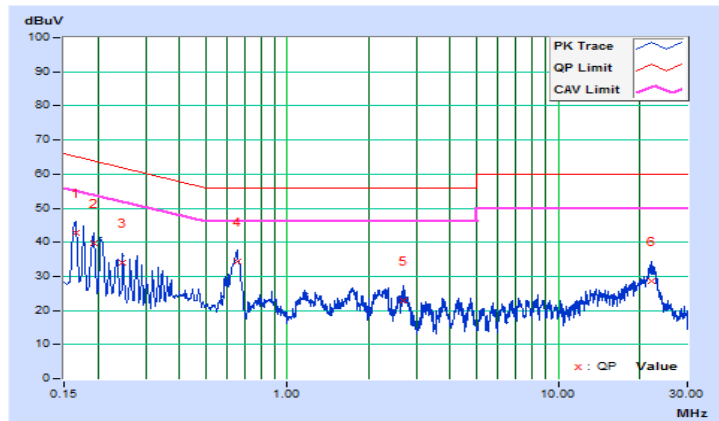

Phase	Neutral (N)	Detector Function	Quasi-Peak (QP) / Average (AV)
-------	-------------	-------------------	--------------------------------

No	Freq. [MHz]	Corr. Factor (dB)	Reading Value [dB (uV)]		Emission Level [dB (uV)]		Limit [dB (uV)]		Margin (dB)	
			Q.P.	AV.	Q.P.	AV.	Q.P.	AV.	Q.P.	AV.
			1	0.15782	10.19	33.12	11.55	43.31	21.74	65.58
2	0.20865	10.19	26.60	7.51	36.79	17.70	63.26	53.26	-26.47	-35.56
3	0.36896	10.27	14.66	3.35	24.93	13.62	58.52	48.52	-33.59	-34.90
4	0.65388	10.28	23.96	16.86	34.24	27.14	56.00	46.00	-21.76	-18.86
5	1.74919	10.34	14.49	7.65	24.83	17.99	56.00	46.00	-31.17	-28.01
6	22.50738	11.82	24.52	16.85	36.34	28.67	60.00	50.00	-23.66	-21.33

**REMARKS:**

1. Q.P. and AV. are abbreviations of quasi-peak and average individually.
2. The emission levels of other frequencies were very low against the limit.
3. Margin value = Emission level - Limit value
4. Correction factor = Insertion loss + Cable loss
5. Emission Level = Correction Factor + Reading Value.

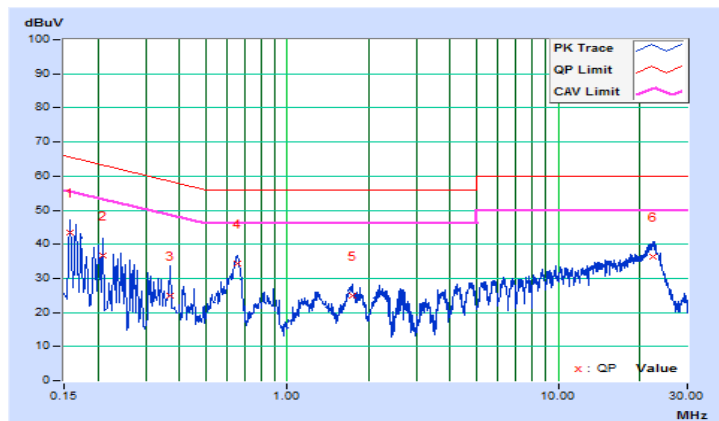

### 4.3 6dB Bandwidth Measurement

#### 4.3.1 Limits of 6dB Bandwidth Measurement

The minimum of 6dB Bandwidth Measurement is 0.5 MHz.

#### 4.3.2 Test Setup

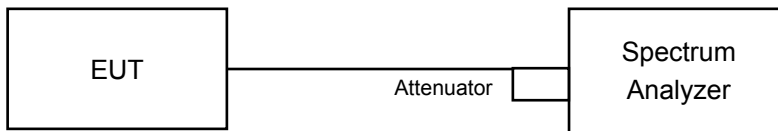

#### 4.3.3 Test Instruments

Refer to section 4.1.2 to get information of above instrument.

#### 4.3.4 Test Procedure

- Set resolution bandwidth (RBW) = 100kHz
- Set the video bandwidth (VBW)  $\geq 3 \times$  RBW, Detector = peak.
- Trace mode = max hold.
- Sweep = auto couple.
- Measure the maximum width of the emission that is constrained by the frequencies associated with the two amplitude points (upper and lower) that are attenuated by 6 dB relative to the maximum level measured in the fundamental emission

#### 4.3.5 Deviation from Test Standard

No deviation.

#### 4.3.6 EUT Operating Conditions

The software provided by client to enable the EUT under transmission condition continuously at lowest, middle and highest channel frequencies individually.

### 4.3.7 Test Result

Channel	Frequency (MHz)	6dB Bandwidth (MHz)	Minimum Limit (MHz)	Pass / Fail
0	2402	0.670	0.5	Pass
19	2440	0.670	0.5	Pass
39	2480	0.670	0.5	Pass

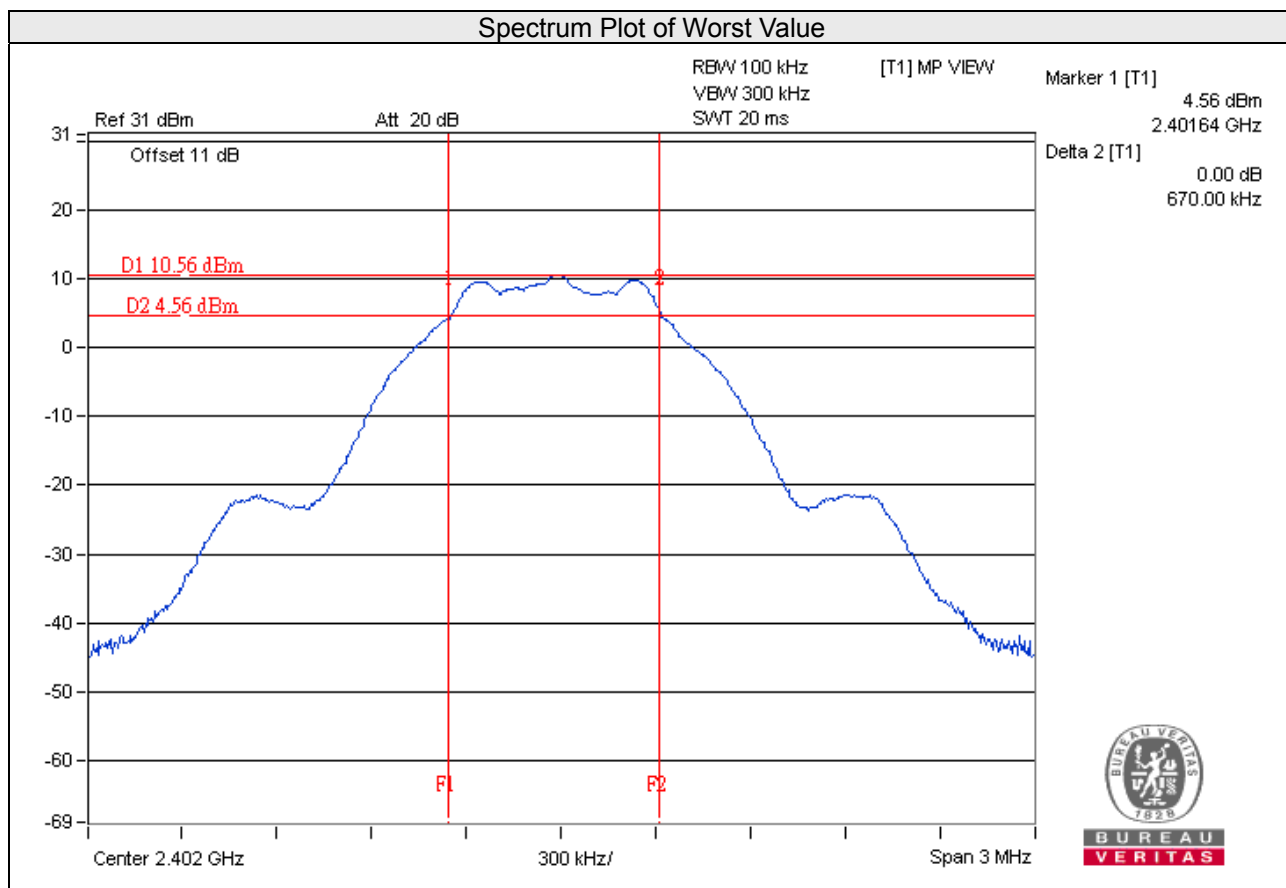

#### 4.4 Conducted Output Power Measurement

##### 4.4.1 Limits of Conducted Output Power Measurement

For systems using digital modulation in the 2400–2483.5 MHz bands: 1 Watt (30dBm)

##### 4.4.2 Test Setup

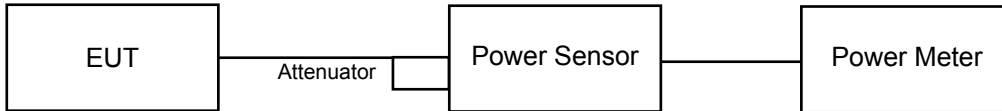

##### 4.4.3 Test Instruments

Refer to section 4.1.2 to get information of above instrument.

##### 4.4.4 Test Procedures

A peak power sensor was used on the output port of the EUT. A power meter was used to read the response of the peak power sensor. Record the power level.

##### 4.4.5 Deviation from Test Standard

No deviation.

##### 4.4.6 EUT Operating Conditions

Same as Item 4.3.6.

##### 4.4.7 Test Results

Channel	Frequency (MHz)	Peak Power (mW)	Peak Power (dBm)	Limit (dBm)	Pass/Fail
0	2402	<b>11.695</b>	10.68	30	Pass
19	2440	11.535	10.62	30	Pass
39	2480	11.092	10.45	30	Pass

## 4.5 Power Spectral Density Measurement

### 4.5.1 Limits of Power Spectral Density Measurement

The Maximum of Power Spectral Density Measurement is 8dBm.

### 4.5.2 Test Setup

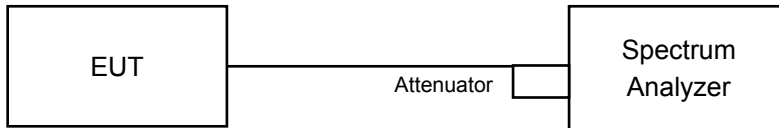

### 4.5.3 Test Instruments

Refer to section 4.1.2 to get information of above instrument.

### 4.5.4 Test Procedure

- a. Set analyzer center frequency to DTS channel center frequency.
- b. Set the span to 1.5 times the DTS bandwidth.
- c. Set the RBW to:  $3 \text{ kHz} \leq \text{RBW} \leq 100 \text{ kHz}$ .
- d. Set the VBW  $\geq 3 \times \text{RBW}$ .
- e. Detector = peak.
- f. Sweep time = auto couple.
- g. Trace mode = max hold.
- h. Allow trace to fully stabilize.
- i. Use the peak marker function to determine the maximum amplitude level within the RBW.

### 4.5.5 Deviation from Test Standard

No deviation.

### 4.5.6 EUT Operating Condition

Same as Item 4.3.6

#### 4.5.7 Test Results

Channel	Frequency (MHz)	PSD (dBm/3kHz)	Limit (dBm/3kHz)	Pass / Fail
0	2402	-3.89	8.00	Pass
19	2440	-3.70	8.00	Pass
39	2480	-3.92	8.00	Pass

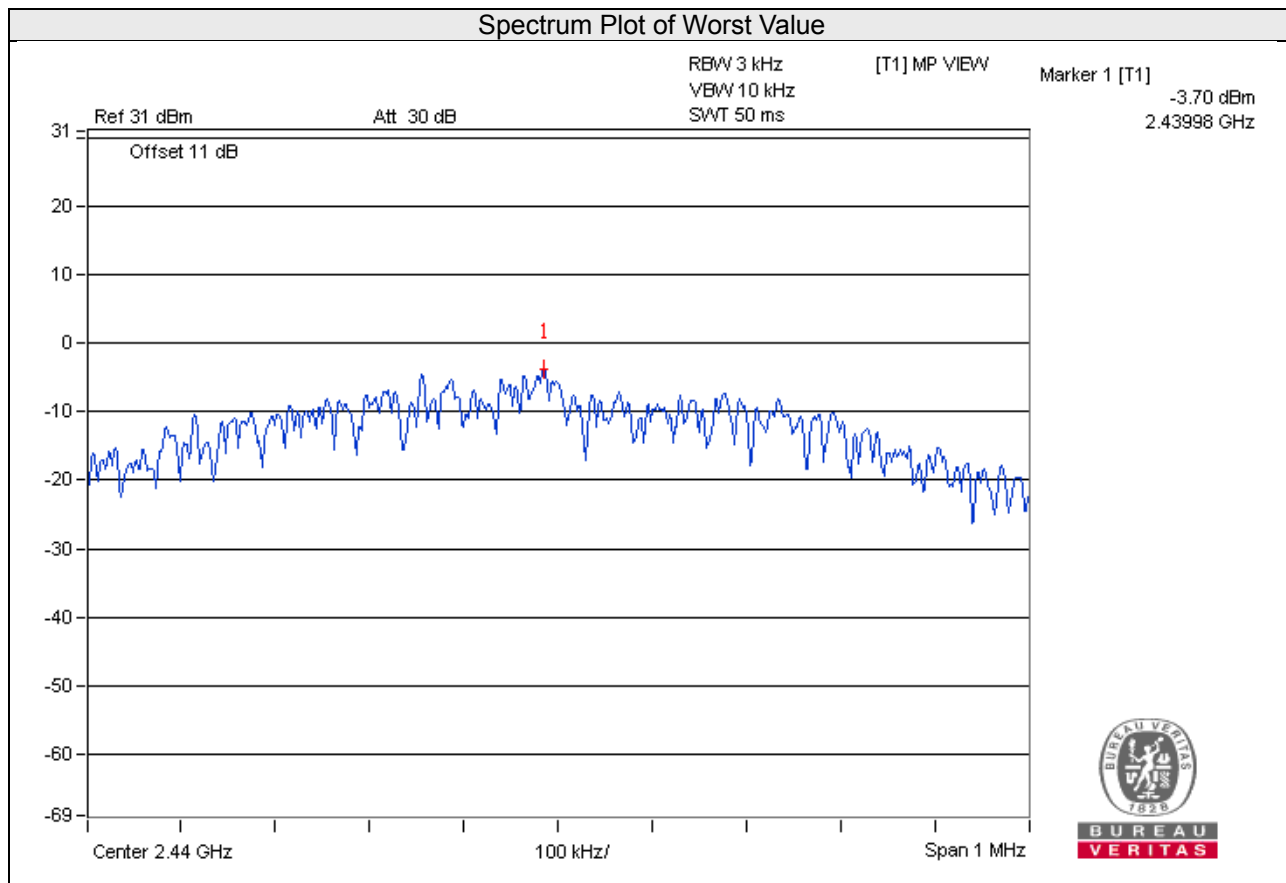

## 4.6 Conducted Out of Band Emission Measurement

### 4.6.1 Limits of Conducted Out of Band Emission Measurement

Below 20dB of the highest emission level of operating band (in 100kHz Resolution Bandwidth).

### 4.6.2 Test Setup

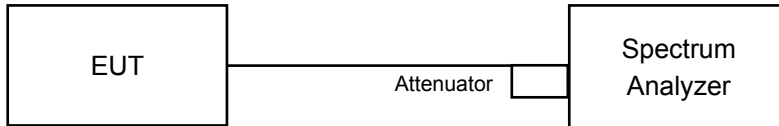

### 4.6.3 Test Instruments

Refer to section 4.1.2 to get information of above instrument.

### 4.6.4 Test Procedure

#### MEASUREMENT PROCEDURE REF

- Set the RBW = 100 kHz.
- Set the VBW  $\geq$  300 kHz.
- Detector = peak.
- Sweep time = auto couple.
- Trace mode = max hold.
- Allow trace to fully stabilize.
- Use the peak marker function to determine the maximum power level in any 100 kHz band segment within the fundamental EBW.

#### MEASUREMENT PROCEDURE OOBE

- Set RBW = 100 kHz.
- Set VBW  $\geq$  300 kHz.
- Detector = peak.
- Sweep = auto couple.
- Trace Mode = max hold.
- Allow trace to fully stabilize.
- Use the peak marker function to determine the maximum amplitude level.



#### **4.6.5 Deviation from Test Standard**

No deviation.

#### **4.6.6 EUT Operating Condition**

Same as Item 4.3.6

#### **4.6.7 Test Results**

The spectrum plots are attached on the following pages. D1 line indicates the highest level, and D2 line indicates the 20dB offset below D1. It shows compliance with the requirement.

### CH 0

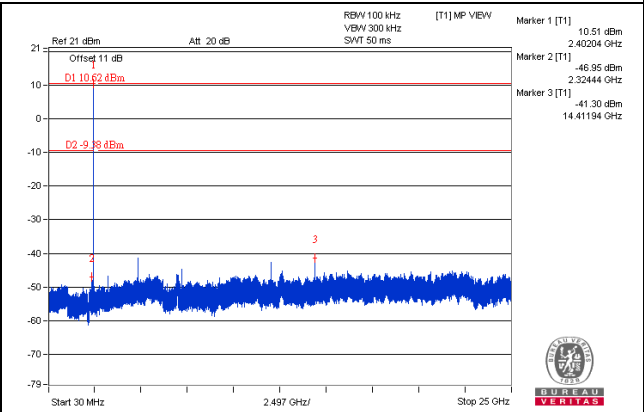
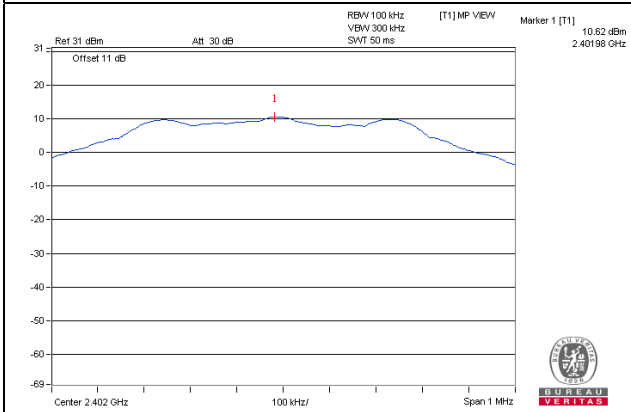

### CH 19

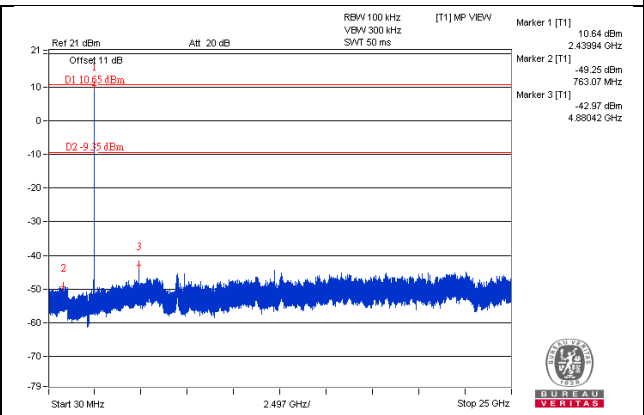
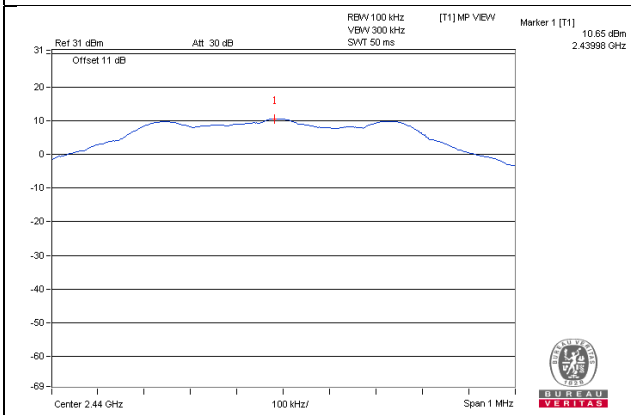

### CH 39

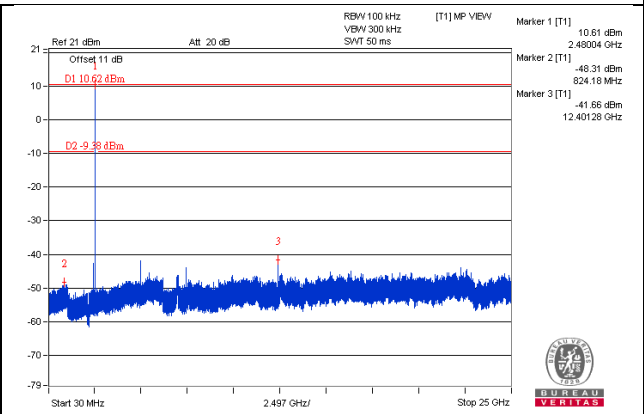
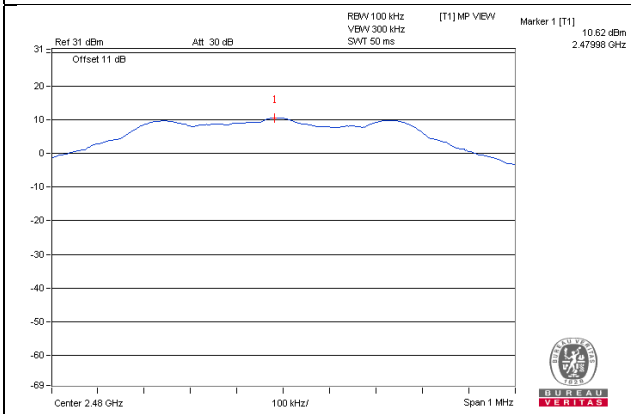

### CH 0 Band edge

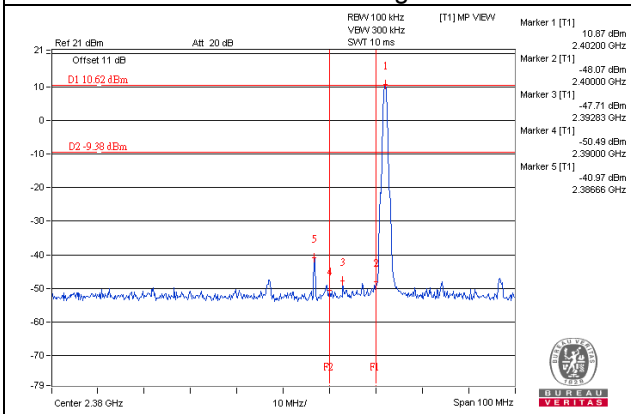

### CH 39 Band edge

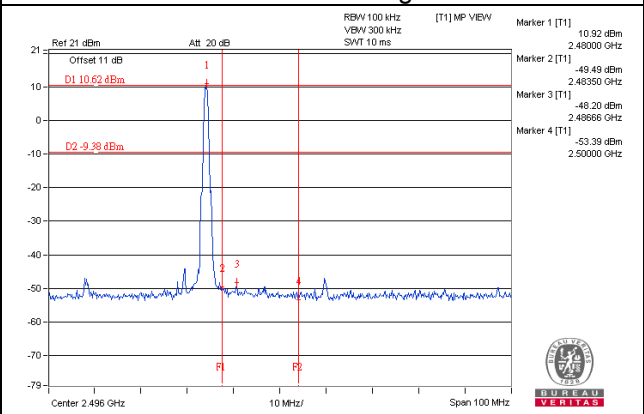

## 5 Pictures of Test Arrangements

Please refer to the attached file (Test Setup Photo).

## Appendix – Information on the Testing Laboratories

We, Bureau Veritas Consumer Products Services (H.K.) Ltd., Taoyuan Branch, were founded in 1988 to provide our best service in EMC, Radio, Telecom and Safety consultation. Our laboratories are accredited and approved according to ISO/IEC 17025.

If you have any comments, please feel free to contact us at the following:

**Linko EMC/RF Lab**

Tel: 886-2-26052180

Fax: 886-2-26051924

**Hsin Chu EMC/RF/Telecom Lab**

Tel: 886-3-6668565

Fax: 886-3-6668323

**Hwa Ya EMC/RF/Safety Lab**

Tel: 886-3-3183232

Fax: 886-3-3270892

**Email:** [service.adt@tw.bureauveritas.com](mailto:service.adt@tw.bureauveritas.com)

**Web Site:** [www.bureauveritas-adt.com](http://www.bureauveritas-adt.com)

The address and road map of all our labs can be found in our web site also.

--- END ---