



# FCC TEST REPORT

**REPORT NO.:** RF111121C05

**MODEL NO.:** ECB350

**FCC ID:** A8J-ECB350

**RECEIVED:** Nov. 16, 2011

**TESTED:** Nov. 23 ~ Nov. 25, 2011

**ISSUED:** Nov. 28, 2011

**APPLICANT:** EnGenius Technologies

**ADDRESS:** 1580 Scenic Avenue, Costa Mesa, CA92626

**ISSUED BY:** Bureau Veritas Consumer Products Services (H.K.)  
Ltd., Taoyuan Branch

**LAB ADDRESS:** No. 47, 14th Ling, Chia Pau Vil., Lin Kou Dist., New  
Taipei City, Taiwan (R.O.C)

**TEST LOCATION:** No. 19, Hwa Ya 2nd Rd, Wen Hwa Tsuen, Kwei  
Shan Hsiang, Taoyuan Hsien 333, Taiwan, R.O.C.

This test report consists of 53 pages in total. It may be duplicated completely for legal use with the approval of the applicant. It should not be reproduced except in full, without the written approval of our laboratory. The client should not use it to claim product certification, approval or endorsement by TAF or any government agency. The test results in the report only apply to the tested sample.





## TABLE OF CONTENTS

RELEASE CONTROL RECORD.....	4
1. CERTIFICATION .....	5
2. SUMMARY OF TEST RESULTS .....	6
2.1 MEASUREMENT UNCERTAINTY.....	6
3. GENERAL INFORMATION.....	7
3.1 GENERAL DESCRIPTION OF EUT .....	7
3.2 DESCRIPTION OF TEST MODES .....	8
3.2.1 CONFIGURATION OF SYSTEM UNDER TEST .....	9
3.2.2 DESCRIPTION OF SUPPORT UNITS .....	10
3.2.3 TEST MODE APPLICABILITY AND TESTED CHANNEL DETAIL .....	11
3.3 GENERAL DESCRIPTION OF APPLIED STANDARDS .....	13
4. TEST TYPES AND RESULTS .....	14
4.1 RADIATED EMISSION AND BANDEDGE MEASUREMENT.....	14
4.1.1 LIMITS OF RADIATED AND BANDEDGE EMISSION MEASUREMENT .....	14
4.1.2 TEST INSTRUMENTS.....	15
4.1.3 TEST PROCEDURES .....	16
4.1.4 DEVIATION FROM TEST STANDARD .....	16
4.1.5 TEST SETUP.....	17
4.1.6 EUT OPERATING CONDITIONS .....	17
4.1.7 TEST RESULTS .....	18
4.2 CONDUCTED EMISSION MEASUREMENT .....	32
4.2.1 LIMITS OF CONDUCTED EMISSION MEASUREMENT.....	32
4.2.2 TEST INSTRUMENTS.....	32
4.2.3 TEST PROCEDURES .....	33
4.2.4 DEVIATION FROM TEST STANDARD .....	33
4.2.5 TEST SETUP.....	34
4.2.6 EUT OPERATING CONDITIONS .....	34
4.2.7 TEST RESULTS .....	35
4.3 6dB BANDWIDTH MEASUREMENT.....	39
4.3.1 LIMITS OF 6dB BANDWIDTH MEASUREMENT .....	39
4.3.2 TEST SETUP.....	39
4.3.3 TEST INSTRUMENTS.....	39
4.3.4 TEST PROCEDURE.....	39
4.3.5 DEVIATION FROM TEST STANDARD .....	39
4.3.6 EUT OPERATING CONDITIONS .....	39
4.3.7 TEST RESULTS .....	40
4.4 CONDUCTED OUTPUT POWER .....	41
4.4.1 LIMITS OF CONDUCTED OUTPUT POWER MEASUREMENT .....	41
4.4.2 TEST SETUP.....	41
4.4.3 TEST INSTRUMENTS.....	41
4.4.4 TEST PROCEDURES .....	41
4.4.5 DEVIATION FROM TEST STANDARD .....	41
4.4.6 EUT OPERATING CONDITIONS .....	41
4.4.7 TEST RESULTS .....	42
4.5 POWER SPECTRAL DENSITY MEASUREMENT.....	43
4.5.1 LIMITS OF POWER SPECTRAL DENSITY MEASUREMENT .....	43
4.5.2 TEST SETUP.....	43
4.5.3 TEST INSTRUMENTS.....	43



4.5.4	TEST PROCEDURE.....	43
4.5.5	DEVIATION FROM TEST STANDARD .....	43
4.5.6	EUT OPERATING CONDITION.....	43
4.5.7	TEST RESULTS .....	44
4.6	CONDUCTED EMISSION MEASUREMENT .....	45
4.6.1	LIMITS OF BAND EDGES MEASUREMENT .....	45
4.6.2	TEST SETUP.....	45
4.6.3	TEST INSTRUMENTS.....	45
4.6.4	TEST PROCEDURE.....	45
4.6.5	DEVIATION FROM TEST STANDARD .....	46
4.6.6	EUT OPERATING CONDITION.....	46
4.6.7	TEST RESULTS .....	46
5.	PHOTOGRAPHS OF THE TEST CONFIGURATION.....	51
6.	INFORMATION ON THE TESTING LABORATORIES .....	52
7.	APPENDIX A - MODIFICATIONS RECORDERS FOR ENGINEERING CHANGES TO THE EUT BY THE LAB.....	53



## RELEASE CONTROL RECORD

ISSUE NO.	REASON FOR CHANGE	DATE ISSUED
Original release	NA	Nov. 28, 2011



## 1. CERTIFICATION

**PRODUCT:** 11n Multi-Function Client Bridge  
**MODEL:** ECB350  
**BRAND:** EnGenius  
**APPLICANT:** EnGenius Technologies  
**TESTED:** Nov. 23 ~ Nov. 25, 2011  
**TEST SAMPLE:** ENGINEERING SAMPLE  
**STANDARDS:** **FCC Part 15, Subpart C (Section 15.247)**  
ANSI C63.4-2003  
ANSI C63.10-2009

The above equipment (model: ECB350) has been tested by **Bureau Veritas Consumer Products Services (H.K.) Ltd., Taoyuan Branch**, and found compliance with the requirement of the above standards. The test record, data evaluation & Equipment Under Test (EUT) configurations represented herein are true and accurate accounts of the measurements of the sample's EMC characteristics under the conditions specified in this report.

PREPARED BY : Andrea Hsia , DATE : Nov. 28, 2011  
Andrea Hsia / Specialist

APPROVED BY : Gary Chang , DATE : Nov. 28, 2011  
Gary Chang / Technical Manager

## 2. SUMMARY OF TEST RESULTS

The EUT has been tested according to the following specifications:

APPLIED STANDARD: FCC PART 15, SUBPART C (SECTION 15.247)			
STANDARD SECTION	TEST TYPE	RESULT	REMARK
15.207	AC Power Conducted Emission	PASS	Meet the requirement of limit. Minimum passing margin is -2.04dB at 0.486MHz.
15.247(d) 15.209	Radiated Emissions	PASS	Meet the requirement of limit. Minimum passing margin is -1.0dB at 4874.00MHz.
15.247(d)	Band Edge Measurement	PASS	Meet the requirement of limit.
15.247(a)(2)	6dB bandwidth	PASS	Meet the requirement of limit.
15.247(b)	Conducted power	PASS	Meet the requirement of limit.
15.247(e)	Power Spectral Density	PASS	Meet the requirement of limit.
15.203	Antenna Requirement	PASS	Antenna connector is IPEX not a standard connector.

### 2.1 MEASUREMENT UNCERTAINTY

Where relevant, the following measurement uncertainty levels have been estimated for tests performed on the EUT as specified in CISPR 16-4-2:

MEASUREMENT	FREQUENCY	UNCERTAINTY
Conducted emissions	150kHz~30MHz	2.44 dB
Radiated emissions	30MHz ~ 200MHz	2.93 dB
	200MHz ~1000MHz	2.95 dB
	1GHz ~ 18GHz	2.26 dB
	18GHz ~ 40GHz	1.94 dB

This uncertainty represents an expanded uncertainty expressed at approximately the 95% confidence level using a coverage factor of  $k = 2$ .

### 3. GENERAL INFORMATION

#### 3.1 GENERAL DESCRIPTION OF EUT

<b>EUT</b>	11n Multi-Function Client Bridge
<b>MODEL NO.</b>	ECB350
<b>FCC ID</b>	A8J-ECB350
<b>POWER SUPPLY</b>	48Vdc (POE) 12Vdc (Adapter)
<b>MODULATION TYPE</b>	CCK, DQPSK, DBPSK for DSSS 64QAM, 16QAM, QPSK, BPSK for OFDM
<b>MODULATION TECHNOLOGY</b>	DSSS, OFDM
<b>TRANSFER RATE</b>	802.11b: 11.0/ 5.5/ 2.0/ 1.0Mbps 802.11g: 54.0/ 48.0/ 36.0/ 24.0/ 18.0/ 12.0/ 9.0/ 6.0Mbps 802.11n: up to 300.0Mbps
<b>OPERATING FREQUENCY</b>	2412 ~ 2462MHz
<b>NUMBER OF CHANNEL</b>	11 for 802.11b, 802.11g, 802.11n (20MHz) 7 for 802.11n (40MHz)
<b>OUTPUT POWER</b>	527.3mW
<b>ANTENNA TYPE</b>	Dipole antenna with 5dBi gain
<b>ANTENNA CONNECTOR</b>	IPEX
<b>DATA CABLE</b>	0.5m non-shielded RJ45 cable w/o core
<b>I/O PORTS</b>	RJ45
<b>ACCESSORY DEVICES</b>	Adapter

**NOTE:**

- The EUT incorporates a MIMO function. Physically, the EUT provides two completed transmitters and two receivers.

MODULATION MODE	TX FUNCTION
802.11b	2TX
802.11g	2TX
802.11n (20MHz)	2TX
802.11n (40MHz)	2TX

- The EUT were powered by the following adapter & POE:

ADAPTER	
<b>BRAND:</b>	DVE
<b>MODEL:</b>	DSA-12G-12 FUS 120120
<b>INPUT:</b>	100-240Vac, 50/60Hz, 0.3A
<b>OUTPUT:</b>	12Vdc, 1A
<b>POWER LINT:</b>	1.5m non-shielded without core

POE	
<b>BRAND:</b>	EnGenius
<b>MODEL:</b>	NPE-7530G

POE'S ADAPTER	
<b>BRAND:</b>	Powertron Electronics
<b>MODEL:</b>	PA1024-4DE
<b>INPUT:</b>	100-240Vac, 50/60Hz, 0.6A
<b>OUTPUT:</b>	48Vdc, 0.38A, 18.24W Max
<b>POWER LINE:</b>	1.8m non-shielded with one core

\*\*POE & POE'S adapter as above are provided as support unit only.

- The above EUT information is declared by manufacturer and for more detailed features description, please refer to the manufacturer's specifications or user's manual.

### 3.2 DESCRIPTION OF TEST MODES

11 channels are provided for 802.11b, 802.11g and 802.11n (20MHz):

CHANNEL	FREQUENCY	CHANNEL	FREQUENCY
1	2412MHz	7	2442MHz
2	2417MHz	8	2447MHz
3	2422MHz	9	2452MHz
4	2427MHz	10	2457MHz
5	2432MHz	11	2462MHz
6	2437MHz		

7 channels are provided for 802.11n (40MHz):

CHANNEL	FREQUENCY	CHANNEL	FREQUENCY
1	2422MHz	5	2442MHz
2	2427MHz	6	2447MHz
3	2432MHz	7	2452MHz
4	2437MHz		



### 3.2.1 CONFIGURATION OF SYSTEM UNDER TEST

#### TEST MODE A

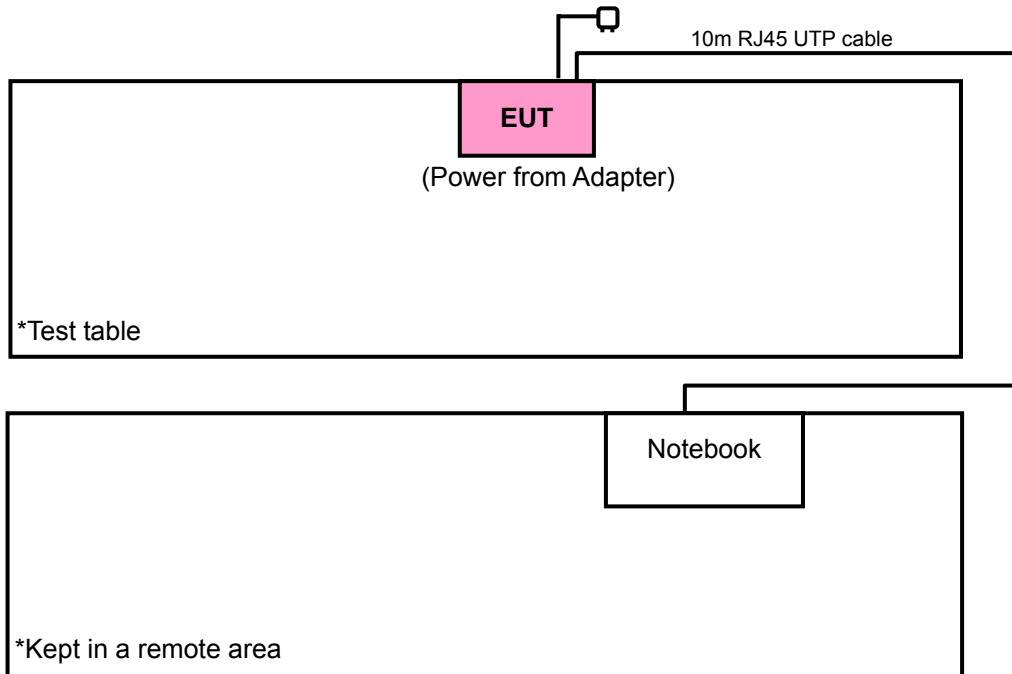

#### TEST MODE B

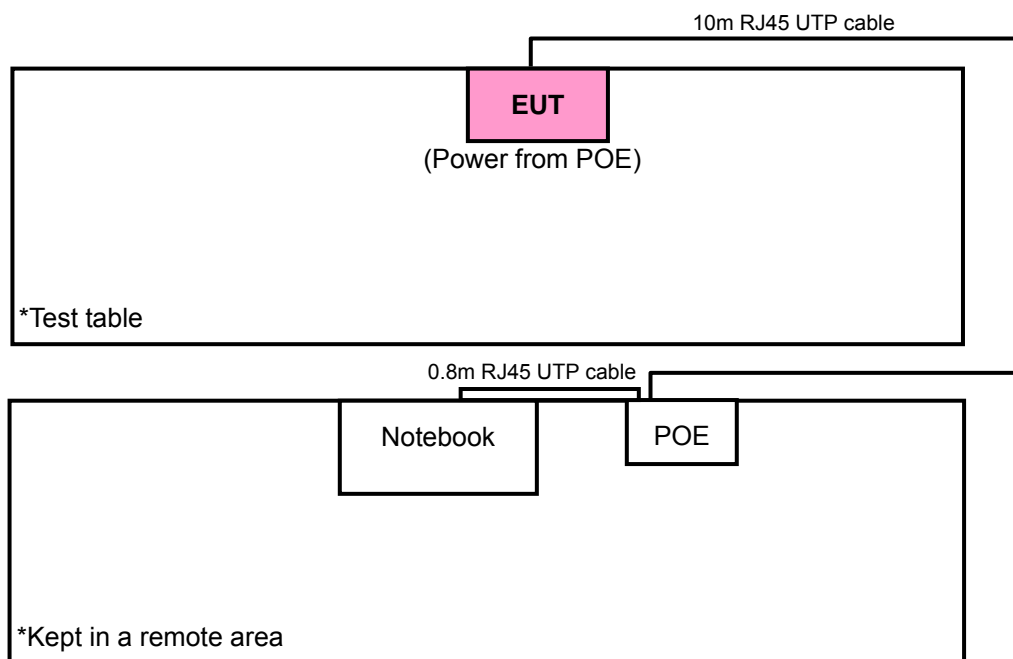



### 3.2.2 DESCRIPTION OF SUPPORT UNITS

The EUT has been tested as an independent unit together with other necessary accessories or support units. The following support units or accessories were used to form a representative test configuration during the tests.

NO.	PRODUCT	BRAND	MODEL NO.	SERIAL NO.	FCC ID
1	NOTEBOOK	DELL	D600	CN-0G5152-48643-487-0068	NA

NO.	SIGNAL CABLE DESCRIPTION OF THE ABOVE SUPPORT UNITS
1	10m RJ45 UTP cable.

**NOTE:**

1. All power cords of the above support units are non shielded (1.8m).
2. Items 1 acted as communication partners to transfer data.

### 3.2.3 TEST MODE APPLICABILITY AND TESTED CHANNEL DETAIL

EUT CONFIGURE MODE	APPLICABLE TO				DESCRIPTION
	RE $\geq$ 1G	RE $<$ 1G	PLC	APCM	
A	√	√	√	√	Power from AC Adapter
B	-	√	√	-	Power from POE

Where **RE $\geq$ 1G**: Radiated Emission above 1GHz      **RE $<$ 1G**: Radiated Emission below 1GHz  
**PLC**: Power Line Conducted Emission      **APCM**: Antenna Port Conducted Measurement

**NOTE**: "-" means no effect.

#### **RADIATED EMISSION TEST (ABOVE 1GHz):**

- Pre-Scan has been conducted to determine the worst-case mode from all possible combinations between available modulations, data rates, XYZ axis and antenna ports (if EUT with antenna diversity architecture).
- Following channel(s) was (were) selected for the final test as listed below.

EUT CONFIGURE MODE	MODE	AVAILABLE CHANNEL	TESTED CHANNEL	MODULATION TECHNOLOGY	MODULATION TYPE	DATA RATE (Mbps)	AXIS
A	802.11b	1 to 11	1, 6, 11	DSSS	DBPSK	1.0	Z
A	802.11g	1 to 11	1, 6, 11	OFDM	BPSK	6.0	Z
A	802.11n (20MHz)	1 to 11	1, 6, 11	OFDM	BPSK	7.2	Z
A	802.11n (40MHz)	1 to 7	1, 4, 7	OFDM	BPSK	15.0	Z

#### **RADIATED EMISSION TEST (BELOW 1GHz):**

- Pre-Scan has been conducted to determine the worst-case mode from all possible combinations between available modulations, data rates, XYZ axis and antenna ports (if EUT with antenna diversity architecture).
- Following channel(s) was (were) selected for the final test as listed below.

EUT CONFIGURE MODE	MODE	AVAILABLE CHANNEL	TESTED CHANNEL	MODULATION TECHNOLOGY	MODULATION TYPE	DATA RATE (Mbps)	AXIS
A & B	802.11g	1 to 11	6	OFDM	BPSK	6.0	Z

#### **POWER LINE CONDUCTED EMISSION TEST:**

- Pre-Scan has been conducted to determine the worst-case mode from all possible combinations between available modulations, data rates and antenna ports (if EUT with antenna diversity architecture).
- Following channel(s) was (were) selected for the final test as listed below.

EUT CONFIGURE MODE	MODE	AVAILABLE CHANNEL	TESTED CHANNEL	MODULATION TECHNOLOGY	MODULATION TYPE	DATA RATE (Mbps)
A & B	802.11g	1 to 11	6	OFDM	BPSK	6.0

**BANDEDGE MEASUREMENT:**

- Pre-Scan has been conducted to determine the worst-case mode from all possible combinations between available modulations, data rates and antenna ports (if EUT with antenna diversity architecture).
- Following channel(s) was (were) selected for the final test as listed below.

EUT CONFIGURE MODE	MODE	AVAILABLE CHANNEL	TESTED CHANNEL	MODULATION TECHNOLOGY	MODULATION TYPE	DATA RATE (Mbps)
A	802.11b	1 to 11	1, 11	DSSS	DBPSK	1.0
A	802.11g	1 to 11	1, 11	OFDM	BPSK	6.0
A	802.11n (20MHz)	1 to 11	1, 11	OFDM	BPSK	7.2
A	802.11n (40MHz)	1 to 7	1, 7	OFDM	BPSK	15.0

**ANTENNA PORT CONDUCTED MEASUREMENT:**

- This item includes all test value of each mode, but only includes spectrum plot of worst value of each mode.
- Pre-Scan has been conducted to determine the worst-case mode from all possible combinations between available modulations, data rates and antenna ports (if EUT with antenna diversity architecture).
- Following channel(s) was (were) selected for the final test as listed below.

EUT CONFIGURE MODE	MODE	AVAILABLE CHANNEL	TESTED CHANNEL	MODULATION TECHNOLOGY	MODULATION TYPE	DATA RATE (Mbps)
A	802.11b	1 to 11	1, 6, 11	DSSS	DBPSK	1.0
A	802.11g	1 to 11	1, 6, 11	OFDM	BPSK	6.0
A	802.11n (20MHz)	1 to 11	1, 6, 11	OFDM	BPSK	7.2
A	802.11n (40MHz)	1 to 7	1, 4, 7	OFDM	BPSK	15.0

**TEST CONDITION:**

APPLICABLE TO	ENVIRONMENTAL CONDITIONS	INPUT POWER	TESTED BY
RE <sub>≥</sub> 1G	25deg. C, 65%RH	120Vac, 60Hz	David Huang
RE <sub>&lt;</sub> 1G	25deg. C, 65%RH	120Vac, 60Hz 48Vdc	Kay Wu
PLC	25deg. C, 65%RH	120Vac, 60Hz 48Vdc	Anderson Hong
APCM	25deg. C, 65%RH	120Vac, 60Hz	Mark Liao



### **3.3 GENERAL DESCRIPTION OF APPLIED STANDARDS**

The EUT is a RF Product. According to the specifications of the manufacturer, it must comply with the requirements of the following standards:

**FCC Part 15, Subpart C (15.247)**

**ANSI C63.4-2003**

**ANSI C63.10-2009**

All test items have been performed and recorded as per the above standards.

**NOTE:** The EUT is also considered as a kind of computer peripheral, because the connection to computer is necessary for typical use. It has been verified to comply with the requirements of FCC Part 15, Subpart B, Class B (DoC). The test report has been issued separately.

## 4. TEST TYPES AND RESULTS

### 4.1 RADIATED EMISSION AND BANDEDGE MEASUREMENT

#### 4.1.1 LIMITS OF RADIATED AND BANDEDGE EMISSION MEASUREMENT

Radiated emissions which fall in the restricted bands, as defined in Section 15.205(a), must also comply with the radiated emission limits specified in Section 15.209(a). Other emissions shall be at least 20dB below the highest level of the desired power:

FREQUENCIES (MHz)	FIELD STRENGTH (microvolts/meter)	MEASUREMENT DISTANCE (meters)
0.009 ~ 0.490	2400/F(kHz)	300
0.490 ~ 1.705	24000/F(kHz)	30
1.705 ~ 30.0	30	30
30 ~ 88	100	3
88 ~ 216	150	3
216 ~ 960	200	3
Above 960	500	3

**NOTE:**

1. The lower limit shall apply at the transition frequencies.
2. Emission level (dBuV/m) = 20 log Emission level (uV/m).
3. As shown in 15.35(b), for frequencies above 1000MHz, the field strength limits are based on average detector, however, the peak field strength of any emission shall not exceed the maximum permitted average limits, specified above by more than 20dB under any condition of modulation.



#### 4.1.2 TEST INSTRUMENTS

DESCRIPTION & MANUFACTURER	MODEL NO.	SERIAL NO.	DATE OF CALIBRATION	DUE DATE OF CALIBRATION
Test Receiver ROHDE & SCHWARZ	ESCI	100744	Apr. 19, 2011	Apr. 18, 2012
Spectrum Analyzer ROHDE & SCHWARZ	FSP40	100269	Jan. 06, 2011	Jan. 05, 2012
BILOG Antenna SCHWARZBECK	VULB9168	9168-156	Apr. 12, 2011	Apr. 11, 2012
HORN Antenna SCHWARZBECK	BBHA 9120 D	9120D-563	Sep. 06, 2011	Sep. 05, 2012
HORN Antenna SCHWARZBECK	BBHA 9170	BBHA9170243	Dec. 27, 2010	Dec. 26, 2011
Preamplifier Agilent	8449B	3008A01911	Oct. 29, 2011	Oct. 28, 2012
Preamplifier Agilent	8447D	2944A10638	Oct. 29, 2011	Oct. 28, 2012
RF signal cable HUBER+SUHNNER	SUCOFLEX 104	295013/4 283403/4	Aug. 19, 2011	Aug. 18, 2012
RF signal cable Worken	8D-FB	Cable-HYCH9-01	Aug. 13, 2011	Aug. 12, 2012
Software	ADT_Radiated_ V7.6.15.9.2	NA	NA	NA
Antenna Tower EMCO	2070/2080	512.835.4684	NA	NA
Turn Table EMCO	2087-2.03	NA	NA	NA
Antenna Tower & Turn Table Controller EMCO	2090	NA	NA	NA
High Speed Peak Power Meter	ML2495A	0842014	Apr. 26, 2011	Apr. 25, 2012
Power Sensor	MA2411B	0738404	Apr. 26, 2011	Apr. 25, 2012

- NOTE:**
1. The calibration interval of the above test instruments is 12 months and the calibrations are traceable to NML/ROC and NIST/USA.
  2. The test was performed in HwaYa Chamber 9.
  3. The horn antenna and HP preamplifier (model: 8449B) are used only for the measurement of emission frequency above 1GHz if tested.
  4. The FCC Site Registration No. is 460141.
  5. The IC Site Registration No. is IC 7450F-4.

#### 4.1.3 TEST PROCEDURES

- a. The EUT was placed on the top of a rotating table 0.8 meters above the ground at a 3 meters semi-anechoic chamber. The table was rotated 360 degrees to determine the position of the highest radiation.
- b. The EUT was set 3 meters away from the interference-receiving antenna, which was mounted on the top of a variable-height antenna tower.
- c. Height of receiving antenna is varied from one meter to four meters above the ground to determine the maximum value of the field strength. Both horizontal and vertical polarizations of the antenna are set to make the measurement.
- d. For each suspected emission, the EUT was arranged to its worst case and then the antenna was tuned to heights from 1 meter to 4 meters and the rotatable table was turned from 0 degrees to 360 degrees to find the maximum reading.
- e. The test-receiver system was set to Peak Detect Function and Specified Bandwidth with Maximum Hold Mode.
- f. If the emission level of the EUT in peak mode was lower than the limit specified, then testing could be stopped and the peak values of the EUT would be reported. Otherwise the emissions would be re-tested one by one using peak, quasi-peak or average method as specified and then reported in a data sheet.

**NOTE:**

1. The resolution bandwidth and video bandwidth of test receiver/spectrum analyzer is 120kHz for Quasi-peak detection at frequency below 1GHz.
2. The resolution bandwidth of test receiver/spectrum analyzer is 1MHz and video bandwidth is 3MHz for Peak detection at frequency above 1GHz.
3. The resolution bandwidth of test receiver/spectrum analyzer is 1MHz and the video bandwidth is 10Hz for Average detection (AV) at frequency above 1GHz.
4. All modes of operation were investigated and the worst-case emissions are reported.

#### 4.1.4 DEVIATION FROM TEST STANDARD

No deviation.



#### 4.1.5 TEST SETUP

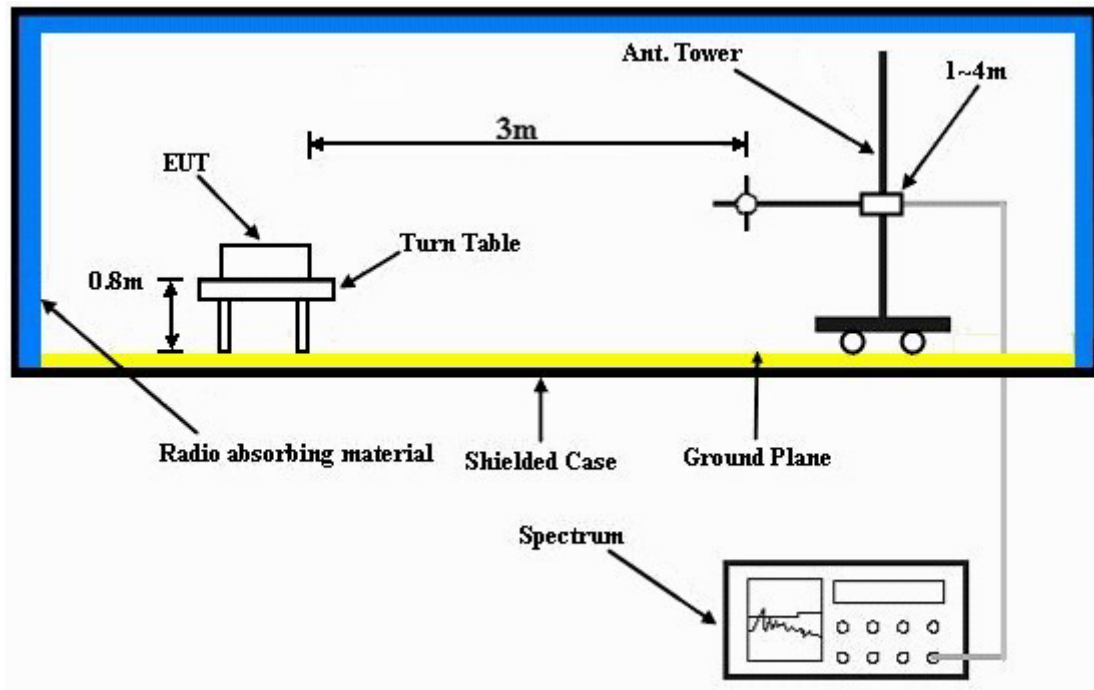

For the actual test configuration, please refer to the attached file (Test Setup Photo).

#### 4.1.6 EUT OPERATING CONDITIONS

- a. Placed the EUT on the testing table.
- b. Prepared notebook outside of testing area to act as communication partners.
- c. The communication partners connected with EUT via a RJ45 cable and run a test program (provided by manufacturer) to enable EUT under transmission condition continuously at specific channel frequency.
- d. The necessary accessories enable the system in full functions

#### 4.1.7 TEST RESULTS

##### ABOVE 1GHz: 802.11b

EUT TEST CONDITION		MEASUREMENT DETAIL	
CHANNEL	Channel 1	FREQUENCY RANGE	1 ~ 25GHz
INPUT POWER (SYSTEM)	120Vac, 60 Hz	DETECTOR FUNCTION	Peak (PK) Average (AV)
ENVIRONMENTAL CONDITIONS	25deg. C, 65%RH	TESTED BY	David Huang

ANTENNA POLARITY & TEST DISTANCE: HORIZONTAL AT 3 M								
NO.	FREQ. (MHz)	EMISSION LEVEL (dBuV/m)	LIMIT (dBuV/m)	MARGIN (dB)	ANTENNA HEIGHT (m)	TABLE ANGLE (Degree)	RAW VALUE (dBuV)	CORRECTION FACTOR (dB/m)
1	2390.00	56.0 PK	74.0	-18.0	1.00 H	188	24.90	31.10
2	2390.00	45.3 AV	54.0	-8.7	1.00 H	188	14.20	31.10
3	*2412.00	104.9 PK			1.00 H	313	73.70	31.20
4	*2412.00	100.3 AV			1.00 H	313	69.10	31.20
5	4824.00	54.7 PK	74.0	-19.3	1.00 H	189	17.80	36.90
6	4824.00	51.5 AV	54.0	-2.5	1.00 H	189	14.60	36.90
ANTENNA POLARITY & TEST DISTANCE: VERTICAL AT 3 M								
NO.	FREQ. (MHz)	EMISSION LEVEL (dBuV/m)	LIMIT (dBuV/m)	MARGIN (dB)	ANTENNA HEIGHT (m)	TABLE ANGLE (Degree)	RAW VALUE (dBuV)	CORRECTION FACTOR (dB/m)
1	2390.00	58.0 PK	74.0	-16.0	1.00 V	350	26.90	31.10
2	2390.00	47.3 AV	54.0	-6.7	1.00 V	350	16.20	31.10
3	*2412.00	113.4 PK			1.00 V	166	82.20	31.20
4	*2412.00	108.3 AV			1.00 V	166	77.10	31.20
5	4824.00	55.8 PK	74.0	-18.2	1.09 V	180	18.90	36.90
6	4824.00	52.8 AV	54.0	-1.2	1.09 V	180	15.90	36.90

- REMARKS:**
1. Emission level (dBuV/m) = Raw Value (dBuV) + Correction Factor (dB/m).
  2. Correction Factor (dB/m) = Antenna Factor (dB/m) + Cable Factor (dB).
  3. The other emission levels were very low against the limit.
  4. Margin value = Emission level – Limit value.
  5. “ \* “: Fundamental frequency.

EUT TEST CONDITION		MEASUREMENT DETAIL	
CHANNEL	Channel 6	FREQUENCY RANGE	1 ~ 25GHz
INPUT POWER (SYSTEM)	120Vac, 60 Hz	DETECTOR FUNCTION	Peak (PK) Average (AV)
ENVIRONMENTAL CONDITIONS	25deg. C, 65%RH	TESTED BY	David Huang

ANTENNA POLARITY & TEST DISTANCE: HORIZONTAL AT 3 M								
NO.	FREQ. (MHz)	EMISSION LEVEL (dBuV/m)	LIMIT (dBuV/m)	MARGIN (dB)	ANTENNA HEIGHT (m)	TABLE ANGLE (Degree)	RAW VALUE (dBuV)	CORRECTION FACTOR (dB/m)
1	2390.00	55.4 PK	74.0	-18.6	1.00 H	312	24.30	31.10
2	2390.00	44.7 AV	54.0	-9.3	1.00 H	312	13.60	31.10
3	*2437.00	102.6 PK			1.00 H	312	71.30	31.30
4	*2437.00	97.1 AV			1.00 H	312	65.80	31.30
5	4874.00	52.8 PK	74.0	-21.2	1.00 H	193	15.80	37.00
6	4874.00	48.9 AV	54.0	-5.1	1.00 H	193	11.90	37.00
ANTENNA POLARITY & TEST DISTANCE: VERTICAL AT 3 M								
NO.	FREQ. (MHz)	EMISSION LEVEL (dBuV/m)	LIMIT (dBuV/m)	MARGIN (dB)	ANTENNA HEIGHT (m)	TABLE ANGLE (Degree)	RAW VALUE (dBuV)	CORRECTION FACTOR (dB/m)
1	2390.00	58.6 PK	74.0	-15.4	1.14 V	354	27.50	31.10
2	2390.00	46.5 AV	54.0	-7.5	1.14 V	354	15.40	31.10
3	*2437.00	112.5 PK			1.14 V	354	81.20	31.30
4	*2437.00	106.8 AV			1.14 V	354	75.50	31.30
5	4874.00	56.2 PK	74.0	-17.8	1.04 V	124	19.20	37.00
6	4874.00	52.8 AV	54.0	-1.2	1.04 V	124	15.80	37.00

- REMARKS:**
1. Emission level (dBuV/m) = Raw Value (dBuV) + Correction Factor (dB/m).
  2. Correction Factor (dB/m) = Antenna Factor (dB/m) + Cable Factor (dB).
  3. The other emission levels were very low against the limit.
  4. Margin value = Emission level – Limit value.
  5. “ \* “: Fundamental frequency.

EUT TEST CONDITION		MEASUREMENT DETAIL	
CHANNEL	Channel 11	FREQUENCY RANGE	1 ~ 25GHz
INPUT POWER (SYSTEM)	120Vac, 60 Hz	DETECTOR FUNCTION	Peak (PK) Average (AV)
ENVIRONMENTAL CONDITIONS	25deg. C, 65%RH	TESTED BY	David Huang

ANTENNA POLARITY & TEST DISTANCE: HORIZONTAL AT 3 M								
NO.	FREQ. (MHz)	EMISSION LEVEL (dBuV/m)	LIMIT (dBuV/m)	MARGIN (dB)	ANTENNA HEIGHT (m)	TABLE ANGLE (Degree)	RAW VALUE (dBuV)	CORRECTION FACTOR (dB/m)
1	*2462.00	102.0 PK			1.00 H	316	70.60	31.40
2	*2462.00	97.4 AV			1.00 H	316	66.00	31.40
3	2483.50	55.1 PK	74.0	-18.9	1.00 H	315	23.70	31.40
4	2483.50	44.3 AV	54.0	-9.7	1.00 H	315	12.90	31.40
5	4874.00	52.9 PK	74.0	-21.1	1.21 H	193	15.90	37.00
6	4874.00	49.1 AV	54.0	-4.9	1.21 H	193	12.10	37.00
ANTENNA POLARITY & TEST DISTANCE: VERTICAL AT 3 M								
NO.	FREQ. (MHz)	EMISSION LEVEL (dBuV/m)	LIMIT (dBuV/m)	MARGIN (dB)	ANTENNA HEIGHT (m)	TABLE ANGLE (Degree)	RAW VALUE (dBuV)	CORRECTION FACTOR (dB/m)
1	*2462.00	111.8 PK			1.00 V	177	80.40	31.40
2	*2462.00	106.3 AV			1.00 V	177	74.90	31.40
3	2483.50	57.3 PK	74.0	-16.7	1.00 V	176	25.90	31.40
4	2483.50	46.9 AV	54.0	-7.1	1.00 V	176	15.50	31.40
5	4874.00	58.2 PK	74.0	-15.8	1.02 V	123	21.20	37.00
6	4874.00	53.0 AV	54.0	-1.0	1.02 V	123	16.00	37.00

- REMARKS:**
1. Emission level (dBuV/m) = Raw Value (dBuV) + Correction Factor (dB/m).
  2. Correction Factor (dB/m) = Antenna Factor (dB/m) + Cable Factor (dB).
  3. The other emission levels were very low against the limit.
  4. Margin value = Emission level – Limit value.
  5. “ \* “: Fundamental frequency.

802.11g

EUT TEST CONDITION		MEASUREMENT DETAIL	
CHANNEL	Channel 1	FREQUENCY RANGE	1 ~ 25GHz
INPUT POWER (SYSTEM)	120Vac, 60 Hz	DETECTOR FUNCTION	Peak (PK) Average (AV)
ENVIRONMENTAL CONDITIONS	25deg. C, 65%RH	TESTED BY	David Huang

**ANTENNA POLARITY & TEST DISTANCE: HORIZONTAL AT 3 M**

NO.	FREQ. (MHz)	EMISSION LEVEL (dBuV/m)	LIMIT (dBuV/m)	MARGIN (dB)	ANTENNA HEIGHT (m)	TABLE ANGLE (Degree)	RAW VALUE (dBuV)	CORRECTION FACTOR (dB/m)
1	2390.00	60.9 PK	74.0	-13.1	1.00 H	307	29.80	31.10
2	2390.00	46.4 AV	54.0	-7.6	1.00 H	307	15.30	31.10
3	*2412.00	106.8 PK			1.00 H	14	75.60	31.20
4	*2412.00	95.7 AV			1.00 H	14	64.50	31.20
5	4824.00	58.5 PK	74.0	-15.5	1.00 H	195	21.60	36.90
6	4824.00	42.1 AV	54.0	-11.9	1.00 H	195	5.20	36.90

**ANTENNA POLARITY & TEST DISTANCE: VERTICAL AT 3 M**

NO.	FREQ. (MHz)	EMISSION LEVEL (dBuV/m)	LIMIT (dBuV/m)	MARGIN (dB)	ANTENNA HEIGHT (m)	TABLE ANGLE (Degree)	RAW VALUE (dBuV)	CORRECTION FACTOR (dB/m)
1	2390.00	68.6 PK	74.0	-5.4	1.00 V	191	37.50	31.10
2	2390.00	52.0 AV	54.0	-2.0	1.00 V	191	20.90	31.10
3	*2412.00	114.0 PK			1.00 V	230	82.80	31.20
4	*2412.00	102.4 AV			1.00 V	230	71.20	31.20
5	4824.00	58.9 PK	74.0	-15.1	1.50 V	108	22.00	36.90
6	4824.00	42.6 AV	54.0	-11.4	1.50 V	108	5.70	36.90

- REMARKS:**
1. Emission level (dBuV/m) = Raw Value (dBuV) + Correction Factor (dB/m).
  2. Correction Factor (dB/m) = Antenna Factor (dB/m) + Cable Factor (dB).
  3. The other emission levels were very low against the limit.
  4. Margin value = Emission level – Limit value.
  5. “ \* “: Fundamental frequency.

EUT TEST CONDITION		MEASUREMENT DETAIL	
CHANNEL	Channel 6	FREQUENCY RANGE	1 ~ 25GHz
INPUT POWER (SYSTEM)	120Vac, 60 Hz	DETECTOR FUNCTION	Peak (PK) Average (AV)
ENVIRONMENTAL CONDITIONS	25deg. C, 65%RH	TESTED BY	David Huang

ANTENNA POLARITY & TEST DISTANCE: HORIZONTAL AT 3 M								
NO.	FREQ. (MHz)	EMISSION LEVEL (dBuV/m)	LIMIT (dBuV/m)	MARGIN (dB)	ANTENNA HEIGHT (m)	TABLE ANGLE (Degree)	RAW VALUE (dBuV)	CORRECTION FACTOR (dB/m)
1	2390.00	57.2 PK	74.0	-16.8	1.00 H	306	26.10	31.10
2	2390.00	45.5 AV	54.0	-8.5	1.00 H	306	14.40	31.10
3	*2437.00	110.4 PK			1.00 H	15	79.10	31.30
4	*2437.00	99.6 AV			1.00 H	15	68.30	31.30
5	4874.00	65.6 PK	74.0	-8.4	1.00 H	189	28.60	37.00
6	4874.00	49.1 AV	54.0	-4.9	1.00 H	189	12.10	37.00
ANTENNA POLARITY & TEST DISTANCE: VERTICAL AT 3 M								
NO.	FREQ. (MHz)	EMISSION LEVEL (dBuV/m)	LIMIT (dBuV/m)	MARGIN (dB)	ANTENNA HEIGHT (m)	TABLE ANGLE (Degree)	RAW VALUE (dBuV)	CORRECTION FACTOR (dB/m)
1	2390.00	62.6 PK	74.0	-11.4	1.00 V	198	31.50	31.10
2	2390.00	51.0 AV	54.0	-3.0	1.00 V	198	19.90	31.10
3	*2437.00	120.6 PK			1.41 V	122	89.30	31.30
4	*2437.00	108.7 AV			1.41 V	122	77.40	31.30
5	4874.00	69.6 PK	74.0	-4.4	1.02 V	122	32.60	37.00
6	4874.00	52.9 AV	54.0	-1.1	1.02 V	122	15.90	37.00

- REMARKS:**
1. Emission level (dBuV/m) = Raw Value (dBuV) + Correction Factor (dB/m).
  2. Correction Factor (dB/m) = Antenna Factor (dB/m) + Cable Factor (dB).
  3. The other emission levels were very low against the limit.
  4. Margin value = Emission level – Limit value.
  5. “ \* “: Fundamental frequency.

EUT TEST CONDITION		MEASUREMENT DETAIL	
CHANNEL	Channel 11	FREQUENCY RANGE	1 ~ 25GHz
INPUT POWER (SYSTEM)	120Vac, 60 Hz	DETECTOR FUNCTION	Peak (PK) Average (AV)
ENVIRONMENTAL CONDITIONS	25deg. C, 65%RH	TESTED BY	David Huang

ANTENNA POLARITY & TEST DISTANCE: HORIZONTAL AT 3 M								
NO.	FREQ. (MHz)	EMISSION LEVEL (dBuV/m)	LIMIT (dBuV/m)	MARGIN (dB)	ANTENNA HEIGHT (m)	TABLE ANGLE (Degree)	RAW VALUE (dBuV)	CORRECTION FACTOR (dB/m)
1	*2462.00	105.8 PK			1.00 H	313	74.40	31.40
2	*2462.00	94.4 AV			1.00 H	313	63.00	31.40
3	2483.50	56.9 PK	74.0	-17.1	1.00 H	127	25.50	31.40
4	2483.50	45.9 AV	54.0	-8.1	1.00 H	127	14.50	31.40
5	4924.00	56.1 PK	74.0	-17.9	1.00 H	173	19.00	37.10
6	4924.00	40.2 AV	54.0	-13.8	1.00 H	173	3.10	37.10
ANTENNA POLARITY & TEST DISTANCE: VERTICAL AT 3 M								
NO.	FREQ. (MHz)	EMISSION LEVEL (dBuV/m)	LIMIT (dBuV/m)	MARGIN (dB)	ANTENNA HEIGHT (m)	TABLE ANGLE (Degree)	RAW VALUE (dBuV)	CORRECTION FACTOR (dB/m)
1	*2462.00	113.0 PK			1.00 V	177	81.60	31.40
2	*2462.00	101.9 AV			1.00 V	177	70.50	31.40
3	2483.50	70.4 PK	74.0	-3.6	1.12 V	217	39.00	31.40
4	2483.50	52.8 AV	54.0	-1.2	1.12 V	217	21.40	31.40
5	4924.00	52.6 PK	74.0	-21.4	1.00 V	121	15.50	37.10
6	4924.00	35.9 AV	54.0	-18.1	1.00 V	121	-1.20	37.10

- REMARKS:**
1. Emission level (dBuV/m) = Raw Value (dBuV) + Correction Factor (dB/m).
  2. Correction Factor (dB/m) = Antenna Factor (dB/m) + Cable Factor (dB).
  3. The other emission levels were very low against the limit.
  4. Margin value = Emission level – Limit value.
  5. “ \* “: Fundamental frequency.

802.11n (20MHz)

EUT TEST CONDITION		MEASUREMENT DETAIL	
CHANNEL	Channel 1	FREQUENCY RANGE	1 ~ 25GHz
INPUT POWER (SYSTEM)	120Vac, 60 Hz	DETECTOR FUNCTION	Peak (PK) Average (AV)
ENVIRONMENTAL CONDITIONS	25deg. C, 65%RH	TESTED BY	David Huang

ANTENNA POLARITY & TEST DISTANCE: HORIZONTAL AT 3 M								
NO.	FREQ. (MHz)	EMISSION LEVEL (dBuV/m)	LIMIT (dBuV/m)	MARGIN (dB)	ANTENNA HEIGHT (m)	TABLE ANGLE (Degree)	RAW VALUE (dBuV)	CORRECTION FACTOR (dB/m)
1	2390.00	59.8 PK	74.0	-14.2	1.00 H	305	28.70	31.10
2	2390.00	46.5 AV	54.0	-7.5	1.00 H	305	15.40	31.10
3	*2412.00	105.3 PK			1.00 H	304	74.10	31.20
4	*2412.00	93.7 AV			1.00 H	304	62.50	31.20
5	4824.00	56.6 PK	74.0	-17.4	1.00 H	189	19.70	36.90
6	4824.00	40.2 AV	54.0	-13.8	1.00 H	189	3.30	36.90
ANTENNA POLARITY & TEST DISTANCE: VERTICAL AT 3 M								
NO.	FREQ. (MHz)	EMISSION LEVEL (dBuV/m)	LIMIT (dBuV/m)	MARGIN (dB)	ANTENNA HEIGHT (m)	TABLE ANGLE (Degree)	RAW VALUE (dBuV)	CORRECTION FACTOR (dB/m)
1	2390.00	66.7 PK	74.0	-7.3	1.00 V	185	35.60	31.10
2	2390.00	52.9 AV	54.0	-1.1	1.00 V	185	21.80	31.10
3	*2412.00	113.7 PK			1.00 V	201	82.50	31.20
4	*2412.00	101.6 AV			1.00 V	201	70.40	31.20
5	4824.00	57.6 PK	74.0	-16.4	1.09 V	174	20.70	36.90
6	4824.00	41.8 AV	54.0	-12.2	1.09 V	174	4.90	36.90

- REMARKS:**
1. Emission level (dBuV/m) = Raw Value (dBuV) + Correction Factor (dB/m).
  2. Correction Factor (dB/m) = Antenna Factor (dB/m) + Cable Factor (dB).
  3. The other emission levels were very low against the limit.
  4. Margin value = Emission level – Limit value.
  5. “ \* “: Fundamental frequency.



EUT TEST CONDITION		MEASUREMENT DETAIL	
CHANNEL	Channel 6	FREQUENCY RANGE	1 ~ 25GHz
INPUT POWER (SYSTEM)	120Vac, 60 Hz	DETECTOR FUNCTION	Peak (PK) Average (AV)
ENVIRONMENTAL CONDITIONS	25deg. C, 65%RH	TESTED BY	David Huang

ANTENNA POLARITY & TEST DISTANCE: HORIZONTAL AT 3 M								
NO.	FREQ. (MHz)	EMISSION LEVEL (dBuV/m)	LIMIT (dBuV/m)	MARGIN (dB)	ANTENNA HEIGHT (m)	TABLE ANGLE (Degree)	RAW VALUE (dBuV)	CORRECTION FACTOR (dB/m)
1	2390.00	57.3 PK	74.0	-16.7	1.00 H	305	26.20	31.10
2	2390.00	45.6 AV	54.0	-8.4	1.00 H	305	14.50	31.10
3	*2437.00	111.7 PK			1.00 H	18	80.40	31.30
4	*2437.00	99.1 AV			1.00 H	18	67.80	31.30
5	4874.00	64.1 PK	74.0	-9.9	1.00 H	185	27.10	37.00
6	4874.00	48.9 AV	54.0	-5.1	1.00 H	185	11.90	37.00
ANTENNA POLARITY & TEST DISTANCE: VERTICAL AT 3 M								
NO.	FREQ. (MHz)	EMISSION LEVEL (dBuV/m)	LIMIT (dBuV/m)	MARGIN (dB)	ANTENNA HEIGHT (m)	TABLE ANGLE (Degree)	RAW VALUE (dBuV)	CORRECTION FACTOR (dB/m)
1	2390.00	64.0 PK	74.0	-10.0	1.19 V	202	32.90	31.10
2	2390.00	51.5 AV	54.0	-2.5	1.19 V	202	20.40	31.10
3	*2437.00	120.1 PK			1.42 V	124	88.80	31.30
4	*2437.00	107.5 AV			1.42 V	124	76.20	31.30
5	4874.00	64.4 PK	74.0	-9.6	1.00 V	114	27.40	37.00
6	4874.00	48.8 AV	54.0	-5.2	1.00 V	114	11.80	37.00

- REMARKS:**
1. Emission level (dBuV/m) = Raw Value (dBuV) + Correction Factor (dB/m).
  2. Correction Factor (dB/m) = Antenna Factor (dB/m) + Cable Factor (dB).
  3. The other emission levels were very low against the limit.
  4. Margin value = Emission level – Limit value.
  5. “ \* “: Fundamental frequency.

EUT TEST CONDITION		MEASUREMENT DETAIL	
CHANNEL	Channel 11	FREQUENCY RANGE	1 ~ 25GHz
INPUT POWER (SYSTEM)	120Vac, 60 Hz	DETECTOR FUNCTION	Peak (PK) Average (AV)
ENVIRONMENTAL CONDITIONS	25deg. C, 65%RH	TESTED BY	David Huang

ANTENNA POLARITY & TEST DISTANCE: HORIZONTAL AT 3 M								
NO.	FREQ. (MHz)	EMISSION LEVEL (dBuV/m)	LIMIT (dBuV/m)	MARGIN (dB)	ANTENNA HEIGHT (m)	TABLE ANGLE (Degree)	RAW VALUE (dBuV)	CORRECTION FACTOR (dB/m)
1	*2462.00	104.6 PK			1.00 H	314	73.20	31.40
2	*2462.00	92.7 AV			1.00 H	314	61.30	31.40
3	2483.50	60.9 PK	74.0	-13.1	1.00 H	29	29.50	31.40
4	2483.50	47.0 AV	54.0	-7.0	1.00 H	29	15.60	31.40
5	4924.00	56.2 PK	74.0	-17.8	1.00 H	178	19.10	37.10
6	4924.00	41.0 AV	54.0	-13.0	1.00 H	178	3.90	37.10
ANTENNA POLARITY & TEST DISTANCE: VERTICAL AT 3 M								
NO.	FREQ. (MHz)	EMISSION LEVEL (dBuV/m)	LIMIT (dBuV/m)	MARGIN (dB)	ANTENNA HEIGHT (m)	TABLE ANGLE (Degree)	RAW VALUE (dBuV)	CORRECTION FACTOR (dB/m)
1	#2183.50	67.8 PK	94.4	-26.6	1.00 V	217	37.50	30.30
2	#2183.50	52.5 AV	81.9	-29.4	1.00 V	217	22.20	30.30
3	*2462.00	114.4 PK			1.09 V	297	83.00	31.40
4	*2462.00	101.9 AV			1.09 V	297	70.50	31.40
5	4924.00	60.3 PK	74.0	-13.7	1.03 V	124	23.20	37.10
6	4924.00	44.4 AV	54.0	-9.6	1.03 V	124	7.30	37.10

- REMARKS:**
1. Emission level (dBuV/m) = Raw Value (dBuV) + Correction Factor (dB/m).
  2. Correction Factor (dB/m) = Antenna Factor (dB/m) + Cable Factor (dB).
  3. The other emission levels were very low against the limit.
  4. Margin value = Emission level – Limit value.
  5. “ \* “: Fundamental frequency.
  6. “#”: The radiated frequency is out the restricted band.

802.11n (40MHz)

EUT TEST CONDITION		MEASUREMENT DETAIL	
CHANNEL	Channel 1	FREQUENCY RANGE	1 ~ 25GHz
INPUT POWER (SYSTEM)	120Vac, 60 Hz	DETECTOR FUNCTION	Peak (PK) Average (AV)
ENVIRONMENTAL CONDITIONS	25deg. C, 65%RH	TESTED BY	David Huang

ANTENNA POLARITY & TEST DISTANCE: HORIZONTAL AT 3 M								
NO.	FREQ. (MHz)	EMISSION LEVEL (dBuV/m)	LIMIT (dBuV/m)	MARGIN (dB)	ANTENNA HEIGHT (m)	TABLE ANGLE (Degree)	RAW VALUE (dBuV)	CORRECTION FACTOR (dB/m)
1	2390.00	62.7 PK	74.0	-11.3	1.00 H	306	31.60	31.10
2	2390.00	48.7 AV	54.0	-5.3	1.00 H	306	17.60	31.10
3	*2422.00	97.9 PK			1.00 H	306	66.70	31.20
4	*2422.00	85.5 AV			1.00 H	306	54.30	31.20
5	4844.00	48.1 PK	74.0	-25.9	1.25 H	188	11.20	36.90
6	4844.00	33.8 AV	54.0	-20.2	1.25 H	188	-3.10	36.90
ANTENNA POLARITY & TEST DISTANCE: VERTICAL AT 3 M								
NO.	FREQ. (MHz)	EMISSION LEVEL (dBuV/m)	LIMIT (dBuV/m)	MARGIN (dB)	ANTENNA HEIGHT (m)	TABLE ANGLE (Degree)	RAW VALUE (dBuV)	CORRECTION FACTOR (dB/m)
1	2390.00	69.7 PK	74.0	-4.3	1.42 V	130	38.60	31.10
2	2390.00	52.4 AV	54.0	-1.6	1.42 V	130	21.30	31.10
3	*2422.00	106.6 PK			1.20 V	171	75.40	31.20
4	*2422.00	93.8 AV			1.20 V	171	62.60	31.20
5	4844.00	52.4 PK	74.0	-21.6	1.07 V	133	15.50	36.90
6	4844.00	35.7 AV	54.0	-18.3	1.07 V	133	-1.20	36.90

- REMARKS:**
1. Emission level (dBuV/m) = Raw Value (dBuV) + Correction Factor (dB/m).
  2. Correction Factor (dB/m) = Antenna Factor (dB/m) + Cable Factor (dB).
  3. The other emission levels were very low against the limit.
  4. Margin value = Emission level – Limit value.
  5. “ \* “: Fundamental frequency.

EUT TEST CONDITION		MEASUREMENT DETAIL	
CHANNEL	Channel 4	FREQUENCY RANGE	1 ~ 25GHz
INPUT POWER (SYSTEM)	120Vac, 60 Hz	DETECTOR FUNCTION	Peak (PK) Average (AV)
ENVIRONMENTAL CONDITIONS	25deg. C, 65%RH	TESTED BY	David Huang

ANTENNA POLARITY & TEST DISTANCE: HORIZONTAL AT 3 M								
NO.	FREQ. (MHz)	EMISSION LEVEL (dBuV/m)	LIMIT (dBuV/m)	MARGIN (dB)	ANTENNA HEIGHT (m)	TABLE ANGLE (Degree)	RAW VALUE (dBuV)	CORRECTION FACTOR (dB/m)
1	2390.00	61.7 PK	74.0	-12.3	1.00 H	15	30.60	31.10
2	2390.00	48.3 AV	54.0	-5.7	1.00 H	15	17.20	31.10
3	*2437.00	104.4 PK			1.00 H	15	73.10	31.30
4	*2437.00	92.3 AV			1.00 H	15	61.00	31.30
5	2483.50	60.1 PK	74.0	-13.9	1.00 H	15	28.70	31.40
6	2483.50	47.1 AV	54.0	-6.9	1.00 H	15	15.70	31.40
7	4874.00	55.4 PK	74.0	-18.6	1.00 H	185	18.40	37.00
8	4874.00	40.3 AV	54.0	-13.7	1.00 H	185	3.30	37.00
ANTENNA POLARITY & TEST DISTANCE: VERTICAL AT 3 M								
NO.	FREQ. (MHz)	EMISSION LEVEL (dBuV/m)	LIMIT (dBuV/m)	MARGIN (dB)	ANTENNA HEIGHT (m)	TABLE ANGLE (Degree)	RAW VALUE (dBuV)	CORRECTION FACTOR (dB/m)
1	2390.00	68.1 PK	74.0	-5.9	1.00 V	189	37.00	31.10
2	2390.00	52.8 AV	54.0	-1.2	1.00 V	189	21.70	31.10
3	*2437.00	113.2 PK			1.44 V	122	81.90	31.30
4	*2437.00	100.1 AV			1.44 V	122	68.80	31.30
5	2483.50	68.5 PK	74.0	-5.5	1.65 V	125	37.10	31.40
6	2483.50	52.9 AV	54.0	-1.1	1.65 V	125	21.50	31.40
7	4874.00	60.8 PK	74.0	-13.2	1.05 V	123	23.80	37.00
8	4874.00	45.3 AV	54.0	-8.7	1.05 V	123	8.30	37.00

- REMARKS:**
1. Emission level (dBuV/m) = Raw Value (dBuV) + Correction Factor (dB/m).
  2. Correction Factor (dB/m) = Antenna Factor (dB/m) + Cable Factor (dB).
  3. The other emission levels were very low against the limit.
  4. Margin value = Emission level – Limit value.
  5. “ \* “: Fundamental frequency.

EUT TEST CONDITION		MEASUREMENT DETAIL	
CHANNEL	Channel 7	FREQUENCY RANGE	1 ~ 25GHz
INPUT POWER (SYSTEM)	120Vac, 60 Hz	DETECTOR FUNCTION	Peak (PK) Average (AV)
ENVIRONMENTAL CONDITIONS	25deg. C, 65%RH	TESTED BY	David Huang

ANTENNA POLARITY & TEST DISTANCE: HORIZONTAL AT 3 M								
NO.	FREQ. (MHz)	EMISSION LEVEL (dBuV/m)	LIMIT (dBuV/m)	MARGIN (dB)	ANTENNA HEIGHT (m)	TABLE ANGLE (Degree)	RAW VALUE (dBuV)	CORRECTION FACTOR (dB/m)
1	*2452.00	96.7 PK			1.00 H	314	65.40	31.30
2	*2452.00	84.2 AV			1.00 H	314	52.90	31.30
3	2483.50	58.0 PK	74.0	-16.0	1.00 H	314	26.60	31.40
4	2483.50	46.0 AV	54.0	-8.0	1.00 H	314	14.60	31.40
5	4904.00	46.1 PK	74.0	-27.9	1.00 H	188	9.10	37.00
6	4904.00	33.9 AV	54.0	-20.1	1.00 H	188	-3.10	37.00
ANTENNA POLARITY & TEST DISTANCE: VERTICAL AT 3 M								
NO.	FREQ. (MHz)	EMISSION LEVEL (dBuV/m)	LIMIT (dBuV/m)	MARGIN (dB)	ANTENNA HEIGHT (m)	TABLE ANGLE (Degree)	RAW VALUE (dBuV)	CORRECTION FACTOR (dB/m)
1	*2452.00	106.9 PK			1.40 V	126	75.60	31.30
2	*2452.00	93.0 AV			1.40 V	126	61.70	31.30
3	2483.50	70.3 PK	74.0	-3.7	1.32 V	274	38.90	31.40
4	2483.50	52.8 AV	54.0	-1.2	1.32 V	274	21.40	31.40
5	4904.00	47.5 PK	74.0	-26.5	1.00 V	132	10.50	37.00
6	4904.00	35.5 AV	54.0	-18.5	1.00 V	132	-1.50	37.00

- REMARKS:**
1. Emission level (dBuV/m) = Raw Value (dBuV) + Correction Factor (dB/m).
  2. Correction Factor (dB/m) = Antenna Factor (dB/m) + Cable Factor (dB).
  3. The other emission levels were very low against the limit.
  4. Margin value = Emission level – Limit value.
  5. “ \* “: Fundamental frequency.

**BELOW 1GHz WORST-CASE DATA : 802.11g**

EUT TEST CONDITION		MEASUREMENT DETAIL	
CHANNEL	Channel 6	FREQUENCY RANGE	Below 1000MHz
INPUT POWER (SYSTEM)	120Vac, 60 Hz	DETECTOR FUNCTION	Quasi-Peak
ENVIRONMENTAL CONDITIONS	25deg. C, 65%RH	TEST MODE	A
TESTED BY	Kay Wu		

ANTENNA POLARITY & TEST DISTANCE: HORIZONTAL AT 3 M								
NO.	FREQ. (MHz)	EMISSION LEVEL (dBuV/m)	LIMIT (dBuV/m)	MARGIN (dB)	ANTENNA HEIGHT (m)	TABLE ANGLE (Degree)	RAW VALUE (dBuV)	CORRECTION FACTOR (dB/m)
1	249.60	25.5 QP	46.0	-20.5	1.00 H	283	12.50	13.00
2	374.04	28.4 QP	46.0	-17.6	1.00 H	169	11.60	16.80
3	500.42	28.0 QP	46.0	-18.0	1.50 H	31	7.80	20.20
4	599.58	27.4 QP	46.0	-18.6	1.50 H	166	5.00	22.40
5	624.85	30.4 QP	46.0	-15.6	1.00 H	22	7.50	22.90
6	799.84	32.1 QP	46.0	-13.9	1.00 H	154	6.90	25.20
ANTENNA POLARITY & TEST DISTANCE: VERTICAL AT 3 M								
NO.	FREQ. (MHz)	EMISSION LEVEL (dBuV/m)	LIMIT (dBuV/m)	MARGIN (dB)	ANTENNA HEIGHT (m)	TABLE ANGLE (Degree)	RAW VALUE (dBuV)	CORRECTION FACTOR (dB/m)
1	53.23	25.2 QP	40.0	-14.8	1.00 V	154	11.20	14.00
2	88.00	18.3 QP	40.0	-21.7	1.00 V	283	9.60	8.70
3	249.60	24.4 QP	46.0	-21.6	2.50 V	346	11.40	13.00
4	374.04	33.9 QP	46.0	-12.1	1.50 V	226	17.10	16.80
5	500.42	27.5 QP	46.0	-18.5	1.00 V	250	7.30	20.20
6	624.85	35.1 QP	46.0	-10.9	1.50 V	79	12.20	22.90

- REMARKS:**
1. Emission level (dBuV/m) = Raw Value (dBuV) + Correction Factor (dB/m).
  2. Correction Factor (dB/m) = Antenna Factor (dB/m) + Cable Factor (dB).
  3. The other emission levels were very low against the limit.
  4. Margin value = Emission level – Limit value.

EUT TEST CONDITION		MEASUREMENT DETAIL	
CHANNEL	Channel 6	FREQUENCY RANGE	Below 1000MHz
INPUT POWER (SYSTEM)	120Vac, 60 Hz	DETECTOR FUNCTION	Quasi-Peak
ENVIRONMENTAL CONDITIONS	25deg. C, 65%RH	TEST MODE	B
TESTED BY	Kay Wu		

ANTENNA POLARITY & TEST DISTANCE: HORIZONTAL AT 3 M								
NO.	FREQ. (MHz)	EMISSION LEVEL (dBuV/m)	LIMIT (dBuV/m)	MARGIN (dB)	ANTENNA HEIGHT (m)	TABLE ANGLE (Degree)	RAW VALUE (dBuV)	CORRECTION FACTOR (dB/m)
1	129.06	23.5 QP	43.5	-20.0	3.00 H	325	10.30	13.20
2	154.33	21.4 QP	43.5	-22.1	2.00 H	64	6.80	14.60
3	249.60	21.9 QP	46.0	-24.1	1.00 H	10	8.90	13.00
4	374.04	26.1 QP	46.0	-19.9	2.50 H	304	9.30	16.80
5	624.85	27.3 QP	46.0	-18.7	3.00 H	40	4.40	22.90
6	799.84	35.2 QP	46.0	-10.8	1.00 H	154	10.00	25.20
ANTENNA POLARITY & TEST DISTANCE: VERTICAL AT 3 M								
NO.	FREQ. (MHz)	EMISSION LEVEL (dBuV/m)	LIMIT (dBuV/m)	MARGIN (dB)	ANTENNA HEIGHT (m)	TABLE ANGLE (Degree)	RAW VALUE (dBuV)	CORRECTION FACTOR (dB/m)
1	53.23	26.9 QP	40.0	-13.1	1.00 V	130	12.90	14.00
2	162.11	22.1 QP	43.5	-21.4	1.00 V	325	7.60	14.50
3	249.60	20.1 QP	46.0	-25.9	1.50 V	217	7.10	13.00
4	374.04	31.1 QP	46.0	-14.9	1.50 V	271	14.30	16.80
5	500.42	26.4 QP	46.0	-19.6	1.00 V	67	6.20	20.20
6	624.85	33.4 QP	46.0	-12.6	1.50 V	121	10.50	22.90

- REMARKS:**
1. Emission level (dBuV/m) = Raw Value (dBuV) + Correction Factor (dB/m).
  2. Correction Factor (dB/m) = Antenna Factor (dB/m) + Cable Factor (dB).
  3. The other emission levels were very low against the limit.
  4. Margin value = Emission level – Limit value.

## 4.2 CONDUCTED EMISSION MEASUREMENT

### 4.2.1 LIMITS OF CONDUCTED EMISSION MEASUREMENT

FREQUENCY OF EMISSION (MHz)	CONDUCTED LIMIT (dB $\mu$ V)	
	Quasi-peak	Average
0.15 ~ 0.5	66 to 56	56 to 46
0.5 ~ 5	56	46
5 ~ 30	60	50

- NOTE:**
1. The lower limit shall apply at the transition frequencies.
  2. The limit decreases in line with the logarithm of the frequency in the range of 0.15 to 0.50MHz.
  3. All emanations from a class A/B digital device or system, including any network of conductors and apparatus connected thereto, shall not exceed the level of field strengths specified above.

### 4.2.2 TEST INSTRUMENTS

DESCRIPTION & MANUFACTURER	MODEL NO.	SERIAL NO.	DATE OF CALIBRATION	DUE DATE OF CALIBRATION
Test Receiver ROHDE & SCHWARZ	ESCS30	100291	Nov. 30, 2010	Nov. 29, 2011
RF signal cable Woken	5D-FB	Cable-HYC01-01	Dec. 30, 2010	Dec. 29, 2011
LISN ROHDE & SCHWARZ	ESH3-Z5	100312	Jul. 07, 2011	Jul. 06, 2012
LISN ROHDE & SCHWARZ	ESH2-Z5	100100	Jan. 06, 2011	Jan. 05, 2012
LISN ROHDE & SCHWARZ	ESH3-Z5	835239/001	Feb. 22, 2011	Feb. 21, 2012
V-LISN SCHWARZBECK	NNBL 8226-2	8226-142	Jun. 30, 2011	Jun. 29, 2012
LISN ROHDE & SCHWARZ	ENV216	100072	Jun. 10, 2011	Jun. 09, 2012
Software ADT	ADT_Cond_ V7.3.7	NA	NA	NA

- NOTE:**
1. The calibration interval of the above test instruments is 12 months and the calibrations are traceable to NML/ROC and NIST/USA.
  2. The test was performed in HwaYa Shielded Room 1.
  3. The VCCI Site Registration No. is C-2040.



#### 4.2.3 TEST PROCEDURES

- a. The EUT was placed 0.4 meters from the conducting wall of the shielded room with EUT being connected to the power mains through a line impedance stabilization network (LISN). Other support units were connected to the power mains through another LISN. The two LISNs provide 50 ohm/ 50uH of coupling impedance for the measuring instrument.
- b. Both lines of the power mains connected to the EUT were checked for maximum conducted interference.
- c. The frequency range from 150kHz to 30MHz was searched. Emission levels under (Limit - 20dB) was not recorded.

**NOTE:** All modes of operation were investigated and the worst-case emissions are reported.

#### 4.2.4 DEVIATION FROM TEST STANDARD

No deviation.

#### 4.2.5 TEST SETUP

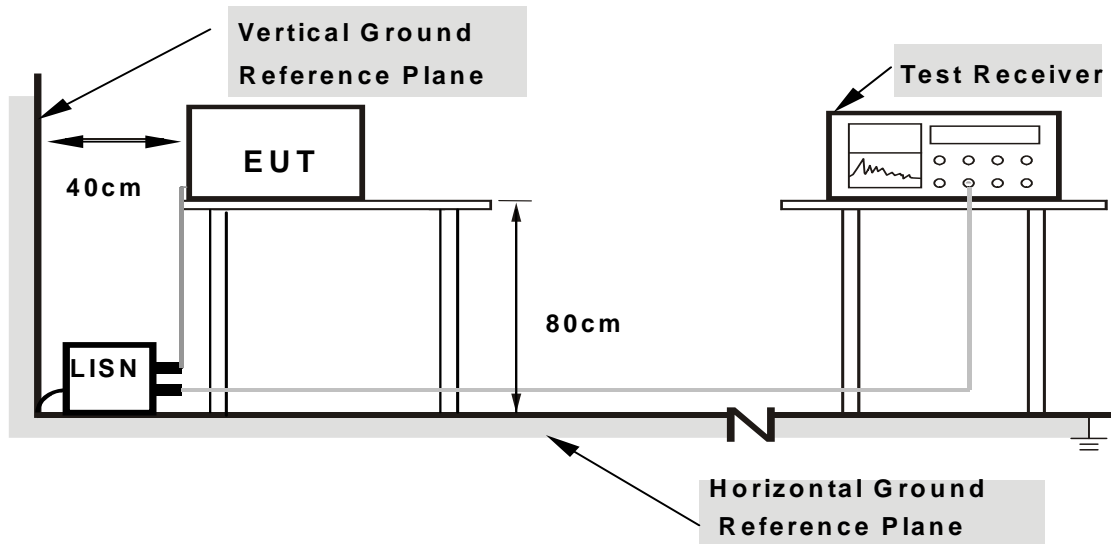

- Note:**
1. Support units were connected to second LISN.
  2. Both of LISNs (AMN) are 80 cm from EUT and at least 80 from other units and other metal planes

For the actual test configuration, please refer to the attached file (Test Setup Photo).

#### 4.2.6 EUT OPERATING CONDITIONS

Same as 4.1.6.

## 4.2.7 TEST RESULTS

### CONDUCTED WORST-CASE DATA : 802.11g

PHASE	Line 1	6dB BANDWIDTH	9kHz
TEST MODE	A		

No	Freq. [MHz]	Corr. Factor (dB)	Reading Value [dB (uV)]		Emission Level [dB (uV)]		Limit [dB (uV)]		Margin (dB)	
			Q.P.	AV.	Q.P.	AV.	Q.P.	AV.	Q.P.	AV.
1	0.154	0.12	41.06	-	41.18	-	65.79	55.79	-24.61	-
2	0.185	0.12	36.13	-	36.25	-	64.25	54.25	-28.00	-
3	4.016	0.31	34.33	-	34.64	-	56.00	46.00	-21.36	-
4	4.965	0.37	34.77	-	35.14	-	56.00	46.00	-20.86	-
5	7.344	0.51	33.35	-	33.86	-	60.00	50.00	-26.14	-
6	10.892	0.70	30.05	-	30.75	-	60.00	50.00	-29.25	-

- REMARKS:**
1. Q.P. and AV. are abbreviations of quasi-peak and average individually.
  2. "-": The Quasi-peak reading value also meets average limit and measurement with the average detector is unnecessary.
  3. The emission levels of other frequencies were very low against the limit.
  4. Margin value = Emission level - Limit value
  5. Correction factor = Insertion loss + Cable loss
  6. Emission Level = Correction Factor + Reading Value.

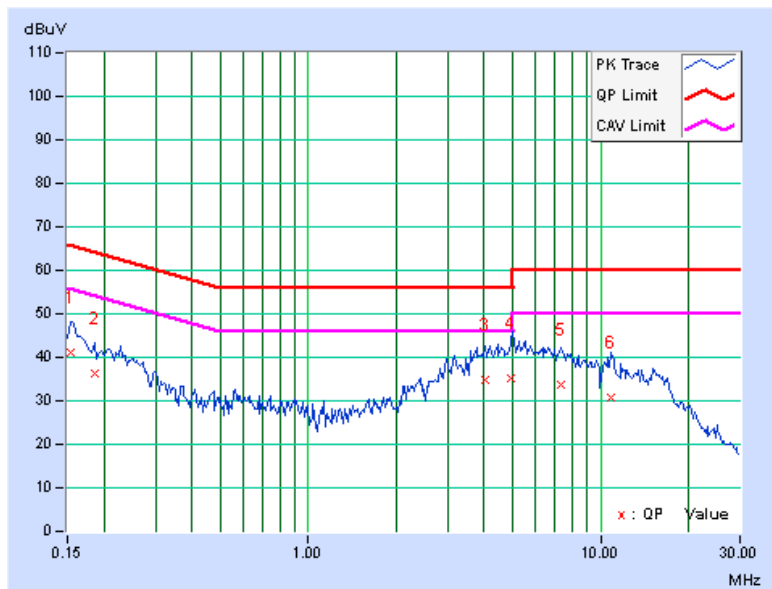

PHASE	Line 2	6dB BANDWIDTH	9kHz
TEST MODE	A		

No	Freq. [MHz]	Corr. Factor (dB)	Reading Value [dB (uV)]		Emission Level [dB (uV)]		Limit [dB (uV)]		Margin (dB)	
			Q.P.	AV.	Q.P.	AV.	Q.P.	AV.	Q.P.	AV.
1	0.162	0.13	39.95	-	40.08	-	65.38	55.38	-25.30	-
2	0.263	0.13	38.51	-	38.64	-	61.33	51.33	-22.68	-
3	3.797	0.31	32.25	-	32.56	-	56.00	46.00	-23.44	-
4	4.445	0.34	32.76	-	33.10	-	56.00	46.00	-22.90	-
5	7.138	0.47	30.85	-	31.32	-	60.00	50.00	-28.68	-
6	7.887	0.51	29.90	-	30.41	-	60.00	50.00	-29.59	-

- REMARKS:**
1. Q.P. and AV. are abbreviations of quasi-peak and average individually.
  2. "-": The Quasi-peak reading value also meets average limit and measurement with the average detector is unnecessary.
  3. The emission levels of other frequencies were very low against the limit.
  4. Margin value = Emission level - Limit value
  5. Correction factor = Insertion loss + Cable loss
  6. Emission Level = Correction Factor + Reading Value.

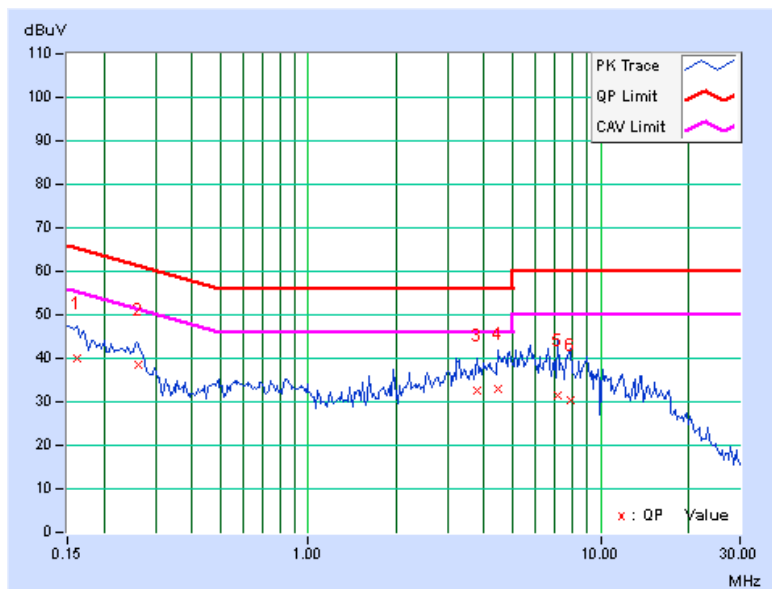

PHASE	Line 1	6dB BANDWIDTH	9kHz
TEST MODE	B		

No	Freq. [MHz]	Corr. Factor (dB)	Reading Value [dB (uV)]		Emission Level [dB (uV)]		Limit [dB (uV)]		Margin (dB)	
			Q.P.	AV.	Q.P.	AV.	Q.P.	AV.	Q.P.	AV.
1	0.150	0.11	51.53	-	51.65	-	66.00	56.00	-14.35	-
2	0.166	0.12	51.54	-	51.66	-	65.18	55.18	-13.52	-
3	0.486	0.13	48.52	42.81	48.65	42.94	56.24	46.24	-7.59	-3.30
4	4.413	0.33	42.67	-	43.00	-	56.00	46.00	-13.00	-
5	9.496	0.63	49.34	-	49.97	-	60.00	50.00	-10.03	-
6	21.727	1.21	39.14	-	40.35	-	60.00	50.00	-19.65	-

- REMARKS:**
1. Q.P. and AV. are abbreviations of quasi-peak and average individually.
  2. "-": The Quasi-peak reading value also meets average limit and measurement with the average detector is unnecessary.
  3. The emission levels of other frequencies were very low against the limit.
  4. Margin value = Emission level - Limit value
  5. Correction factor = Insertion loss + Cable loss
  6. Emission Level = Correction Factor + Reading Value.

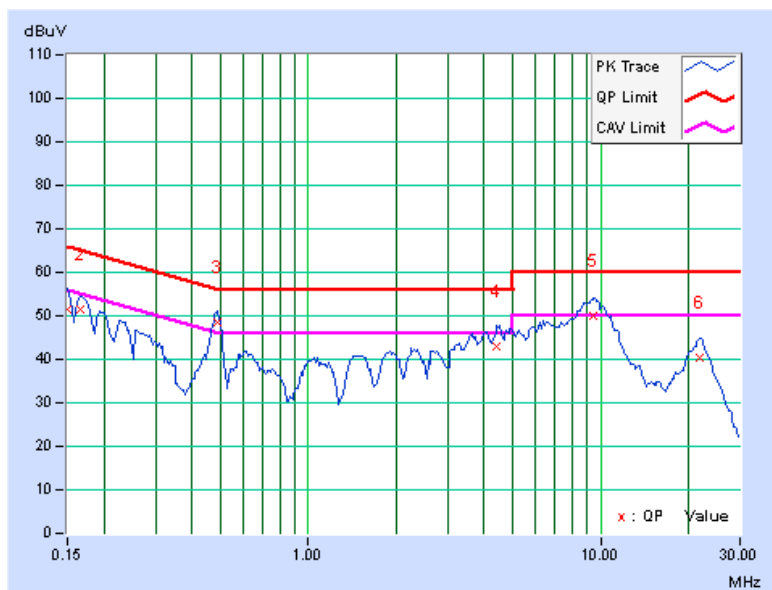

<b>PHASE</b>	Line 2	<b>6dB BANDWIDTH</b>	9kHz
<b>TEST MODE</b>	B		

No	Freq. [MHz]	Corr. Factor (dB)	Reading Value		Emission Level		Limit		Margin	
			[dB (uV)]		[dB (uV)]		[dB (uV)]		(dB)	
			Q.P.	AV.	Q.P.	AV.	Q.P.	AV.	Q.P.	AV.
1	0.150	0.12	50.49	-	50.61	-	66.00	56.00	-15.39	-
2	0.170	0.13	51.38	-	51.51	-	64.98	54.98	-13.48	-
<b>3</b>	<b>0.486</b>	<b>0.15</b>	<b>49.78</b>	<b>44.05</b>	<b>49.93</b>	<b>44.20</b>	<b>56.24</b>	<b>46.24</b>	<b>-6.31</b>	<b>-2.04</b>
4	4.004	0.32	40.47	-	40.79	-	56.00	46.00	-15.21	-
5	10.305	0.62	38.21	-	38.83	-	60.00	50.00	-21.17	-
6	21.723	0.99	30.98	-	31.97	-	60.00	50.00	-28.03	-

- REMARKS:**
1. Q.P. and AV. are abbreviations of quasi-peak and average individually.
  2. "-": The Quasi-peak reading value also meets average limit and measurement with the average detector is unnecessary.
  3. The emission levels of other frequencies were very low against the limit.
  4. Margin value = Emission level - Limit value
  5. Correction factor = Insertion loss + Cable loss
  6. Emission Level = Correction Factor + Reading Value.

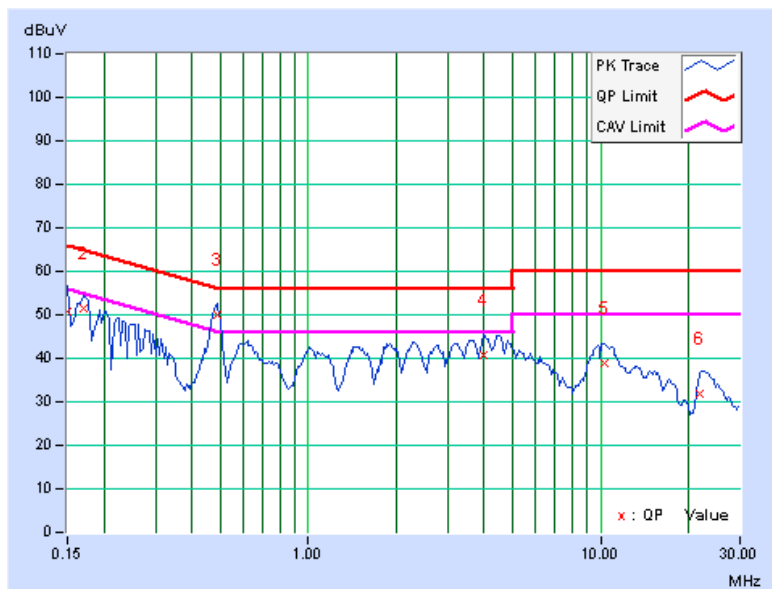

### 4.3 6dB BANDWIDTH MEASUREMENT

#### 4.3.1 LIMITS OF 6dB BANDWIDTH MEASUREMENT

The minimum of 6dB Bandwidth Measurement is 0.5 MHz.

#### 4.3.2 TEST SETUP

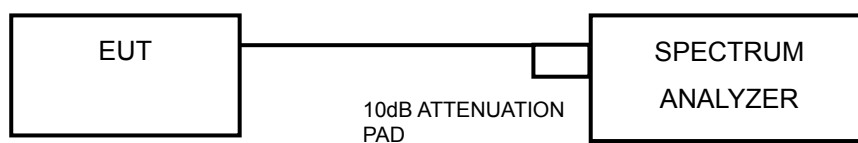

#### 4.3.3 TEST INSTRUMENTS

Refer to section 4.1.2 to get information of above instrument.

#### 4.3.4 TEST PROCEDURE

1. Set resolution bandwidth (RBW) = approximately 1% of the emission bandwidth
2. Set the video bandwidth (VBW)  $\geq 3 \times$  RBW, Detector = Peak.
3. Trace mode = max hold.
4. Sweep = auto couple.
5. Measure the maximum width of the emission that is constrained by the frequencies associated with the two amplitude points (upper and lower) that are attenuated by 6 dB relative to the maximum level measured in the fundamental emission

#### 4.3.5 DEVIATION FROM TEST STANDARD

No deviation.

#### 4.3.6 EUT OPERATING CONDITIONS

The software provided by client to enable the EUT under transmission condition continuously at lowest, middle and highest channel frequencies individually.

#### 4.3.7 TEST RESULTS

##### 802.11b

CHANNEL	FREQUENCY (MHz)	6dB BANDWIDTH (MHz)		MINIMUM LIMIT (MHz)	PASS / FAIL
		CHAIN 0	CHAIN 1		
1	2412	12.24	12.29	0.5	PASS
6	2437	12.27	12.68	0.5	PASS
11	2462	12.31	12.29	0.5	PASS

##### 802.11g

CHANNEL	FREQUENCY (MHz)	6dB BANDWIDTH (MHz)		MINIMUM LIMIT (MHz)	PASS / FAIL
		CHAIN 0	CHAIN 1		
1	2412	16.59	16.54	0.5	PASS
6	2437	16.60	16.61	0.5	PASS
11	2462	16.55	16.64	0.5	PASS

##### 802.11n (20MHz)

CHANNEL	FREQUENCY (MHz)	6dB BANDWIDTH (MHz)		MINIMUM LIMIT (MHz)	PASS / FAIL
		CHAIN 0	CHAIN 1		
1	2412	17.77	17.77	0.5	PASS
6	2437	17.78	17.82	0.5	PASS
11	2462	17.76	17.81	0.5	PASS

##### 802.11n (40MHz)

CHANNEL	FREQUENCY (MHz)	6dB BANDWIDTH (MHz)		MINIMUM LIMIT (MHz)	PASS / FAIL
		CHAIN 0	CHAIN 1		
1	2422	36.52	36.56	0.5	PASS
4	2437	36.51	36.65	0.5	PASS
7	2452	36.37	36.78	0.5	PASS



## 4.4 CONDUCTED OUTPUT POWER

### 4.4.1 LIMITS OF CONDUCTED OUTPUT POWER MEASUREMENT

For systems using digital modulation in the 2400–2483.5 MHz: 1 Watt (30dBm)

### 4.4.2 TEST SETUP

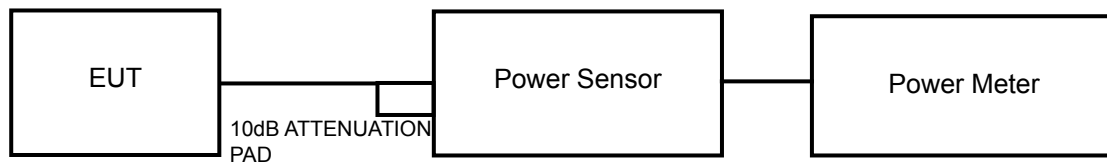

### 4.4.3 TEST INSTRUMENTS

Refer to section 4.1.2 to get information of above instrument.

### 4.4.4 TEST PROCEDURES

A power sensor was used on the output port of the EUT. A power meter was used to read the response of the power sensor. Record the power level.

### 4.4.5 DEVIATION FROM TEST STANDARD

No deviation.

### 4.4.6 EUT OPERATING CONDITIONS

Same as Item 4.3.6.

#### 4.4.7 TEST RESULTS

##### 802.11b

CHAN.	FREQUENCY (MHz)	PEAK POWER (dBm)		TOTAL POWER (mW)	TOTAL POWER (dBm)	LIMIT (dBm)	PASS / FAIL
		CHAIN 0	CHAIN 1				
1	2412	16.6	16.7	92.5	19.7	28	PASS
6	2437	14.7	13.6	52.4	17.2	28	PASS
11	2462	15.8	14.6	66.9	18.3	28	PASS

**NOTE:** Directional gain =  $5\text{dBi} + 10\log(2) = 8\text{dBi} > 6\text{dBi}$ , so the conducted power limit is reduced from 30dBm down to  $30 - (8 - 6) = 28\text{dBm}$

##### 802.11g

CHAN.	FREQUENCY (MHz)	PEAK POWER (dBm)		TOTAL POWER (mW)	TOTAL POWER (dBm)	LIMIT (dBm)	PASS / FAIL
		CHAIN 0	CHAIN 1				
1	2412	24.4	24	526.6	27.2	28	PASS
6	2437	24.5	23.9	527.3	27.2	28	PASS
11	2462	23.7	23	433.9	26.4	28	PASS

**NOTE:** Directional gain =  $5\text{dBi} + 10\log(2) = 8\text{dBi} > 6\text{dBi}$ , so the conducted power limit is reduced from 30dBm down to  $30 - (8 - 6) = 28\text{dBm}$

##### 802.11n (20MHz)

CHAN.	FREQUENCY (MHz)	PEAK POWER (dBm)		TOTAL POWER (mW)	TOTAL POWER (dBm)	LIMIT (dBm)	PASS / FAIL
		CHAIN 0	CHAIN 1				
1	2412	24.5	23.8	521.7	27.2	28	PASS
6	2437	24.6	23.7	522.8	27.2	28	PASS
11	2462	24.3	23.5	493.0	26.9	28	PASS

**NOTE:** Directional gain =  $5\text{dBi} + 10\log(2) = 8\text{dBi} > 6\text{dBi}$ , so the conducted power limit is reduced from 30dBm down to  $30 - (8 - 6) = 28\text{dBm}$

##### 802.11n (40MHz)

CHAN.	FREQUENCY (MHz)	PEAK POWER (dBm)		TOTAL POWER (mW)	TOTAL POWER (dBm)	LIMIT (dBm)	PASS / FAIL
		CHAIN 0	CHAIN 1				
1	2422	23.1	22.9	399.2	26.0	28	PASS
4	2437	24.0	23.3	465.0	26.7	28	PASS
7	2452	22.6	21.7	329.9	25.2	28	PASS

**NOTE:** Directional gain =  $5\text{dBi} + 10\log(2) = 8\text{dBi} > 6\text{dBi}$ , so the conducted power limit is reduced from 30dBm down to  $30 - (8 - 6) = 28\text{dBm}$

## 4.5 POWER SPECTRAL DENSITY MEASUREMENT

### 4.5.1 LIMITS OF POWER SPECTRAL DENSITY MEASUREMENT

The Maximum of Power Spectral Density Measurement is 8dBm.

### 4.5.2 TEST SETUP

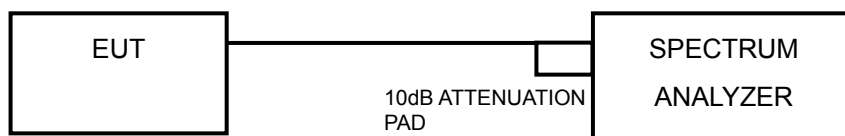

### 4.5.3 TEST INSTRUMENTS

Refer to section 4.1.2 to get information of above instrument.

### 4.5.4 TEST PROCEDURE

1. Set the RBW = 100 kHz, VBW = 300 kHz, Detector = peak.
2. Sweep time = auto couple, Trace mode = max hold, allow trace to fully stabilize.
3. Use the peak marker function to determine the maximum power level in any 100 kHz band segment within the fundamental EBW.
4. Scale the observed power level to an equivalent value in 3 kHz by adjusting (reducing) the measured power by a bandwidth correction factor (BWCF) where  $BWCF = 10\log(3 \text{ kHz}/100\text{kHz})$

### 4.5.5 DEVIATION FROM TEST STANDARD

No deviation.

### 4.5.6 EUT OPERATING CONDITION

Same as Item 4.3.6

## 4.5.7 TEST RESULTS

### 802.11b

TX chain	Channel	FREQ. (MHz)	PSD (dBm/100kHz)	PSD (dBm/3kHz)	10 log (N=2) dB	Total PSD (dBm/3kHz)	Limit (dBm/3kHz)	PASS /FAIL
0	1	2412	4.32	-10.91	3.01	-7.90	6	PASS
	6	2437	2.61	-12.62	3.01	-9.61	6	PASS
	11	2462	3.33	-11.90	3.01	-8.89	6	PASS
1	1	2412	3.73	-11.50	3.01	-8.49	6	PASS
	6	2437	0.68	-14.55	3.01	-11.54	6	PASS
	11	2462	1.65	-13.58	3.01	-10.57	6	PASS

**NOTE:** Directional gain = 5dBi + 10log(2)=8dBi > 6dBi, so the power density limit is reduced from 8dBm down to 8-(8-6)=6dBm

### 802.11g

TX chain	Channel	FREQ. (MHz)	PSD (dBm/100kHz)	PSD (dBm/3kHz)	10 log (N=2) dB	Total PSD (dBm/3kHz)	Limit (dBm/3kHz)	PASS /FAIL
0	1	2412	4.32	-10.91	3.01	-7.90	6	PASS
	6	2437	4.55	-10.68	3.01	-7.67	6	PASS
	11	2462	3.84	-11.39	3.01	-8.38	6	PASS
1	1	2412	4.34	-10.89	3.01	-7.88	6	PASS
	6	2437	4.07	-11.16	3.01	-8.15	6	PASS
	11	2462	3.22	-12.01	3.01	-9.00	6	PASS

**NOTE:** Directional gain = 5dBi + 10log(2)=8dBi > 6dBi, so the power density limit is reduced from 8dBm down to 8-(8-6)=6dBm

### 802.11n (20MHz)

TX chain	Channel	FREQ. (MHz)	PSD (dBm/100kHz)	PSD (dBm/3kHz)	10 log (N=2) dB	Total PSD (dBm/3kHz)	Limit (dBm/3kHz)	PASS /FAIL
0	1	2412	4.23	-11.00	3.01	-7.99	8	PASS
	6	2437	4.50	-10.73	3.01	-7.72	8	PASS
	11	2462	4.16	-11.07	3.01	-8.06	8	PASS
1	1	2412	3.57	-11.66	3.01	-8.65	8	PASS
	6	2437	3.40	-11.83	3.01	-8.82	8	PASS
	11	2462	3.19	-12.04	3.01	-9.03	8	PASS

### 802.11n (40MHz)

TX chain	Channel	FREQ. (MHz)	PSD (dBm/100kHz)	PSD (dBm/3kHz)	10 log (N=2) dB	Total PSD (dBm/3kHz)	Limit (dBm/3kHz)	PASS /FAIL
0	1	2422	-2.80	-18.03	3.01	-15.02	8	PASS
	4	2437	-1.73	-16.96	3.01	-13.95	8	PASS
	7	2452	-3.51	-18.74	3.01	-15.73	8	PASS
1	1	2422	-3.44	-18.67	3.01	-15.66	8	PASS
	4	2437	-2.84	-18.07	3.01	-15.06	8	PASS
	7	2452	-4.71	-19.94	3.01	-16.93	8	PASS

## 4.6 CONDUCTED EMISSION MEASUREMENT

### 4.6.1 LIMITS OF BAND EDGES MEASUREMENT

Below  $-20\text{dB}$  of the highest emission level of operating band (in  $100\text{kHz}$  Resolution Bandwidth).

### 4.6.2 TEST SETUP

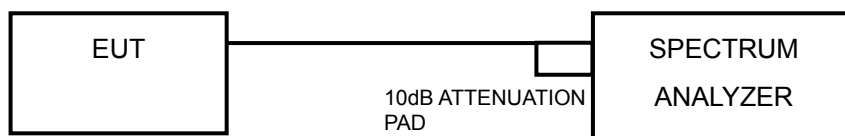

### 4.6.3 TEST INSTRUMENTS

Refer to section 4.1.2 to get information of above instrument.

### 4.6.4 TEST PROCEDURE

#### MEASUREMENT PROCEDURE REF

1. Set the RBW =  $100\text{ kHz}$ .
2. Set the VBW  $\geq 300\text{ kHz}$ .
3. Detector = peak.
4. Sweep time = auto couple.
5. Trace mode = max hold.
6. Allow trace to fully stabilize.
7. Use the peak marker function to determine the maximum power level in any  $100\text{ kHz}$  band segment within the fundamental EBW.



## MEASUREMENT PROCEDURE OOB

1. Set RBW = 100 kHz.
2. Set VBW  $\geq$  300 kHz.
3. Set span to encompass the spectrum to be examined.
4. Detector = peak.
5. Trace Mode = max hold.
6. Sweep = auto couple.

### 4.6.5 DEVIATION FROM TEST STANDARD

No deviation.

### 4.6.6 EUT OPERATING CONDITION

Same as Item 4.3.6

### 4.6.7 TEST RESULTS

The conducted emission test is performed on each TX port of operating mode without summing or adding  $10\log(N)$  since the limit is relative emission limit. Only worst data of each operating mode is presented.

The spectrum plots are attached on the following pages. D1 line indicates the highest level, and D2 line indicates the 20dB offset below D1. It shows compliance with the requirement in part 15.247(d).



A D T

### 802.11b

#### CH 1

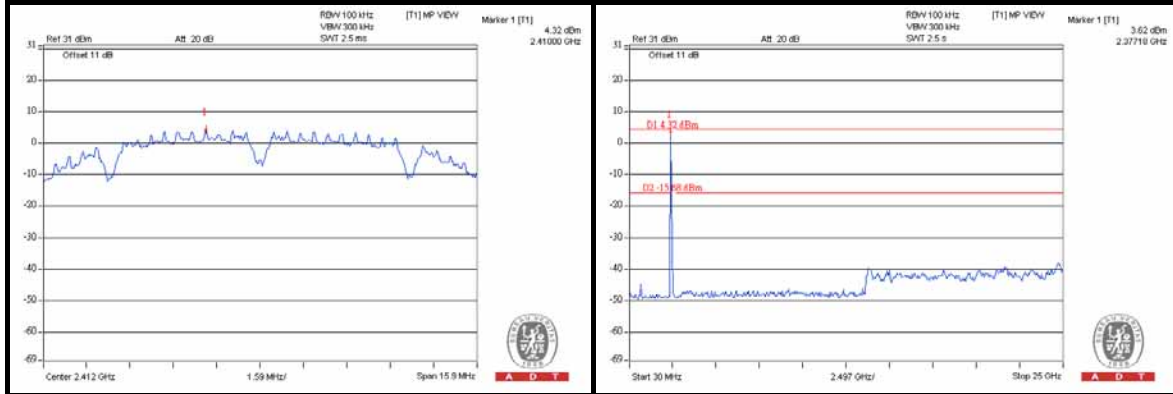

#### CH 6

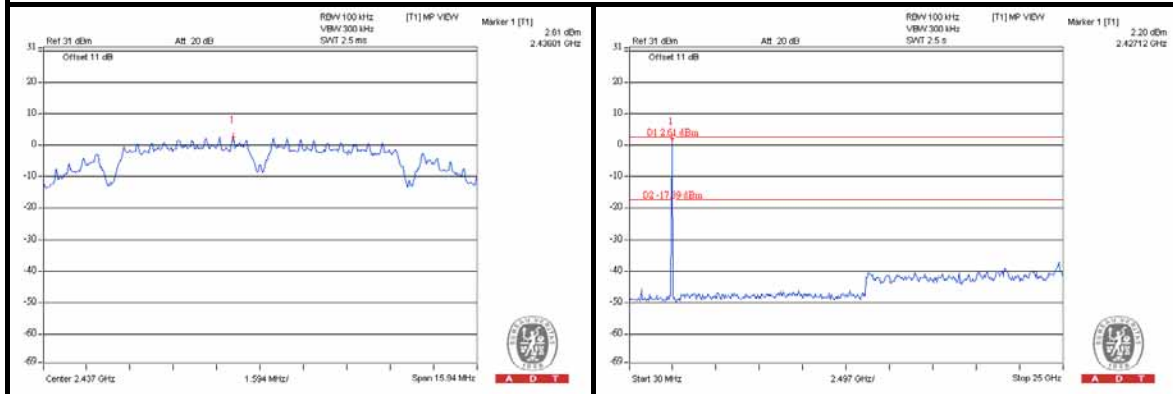

#### CH 11

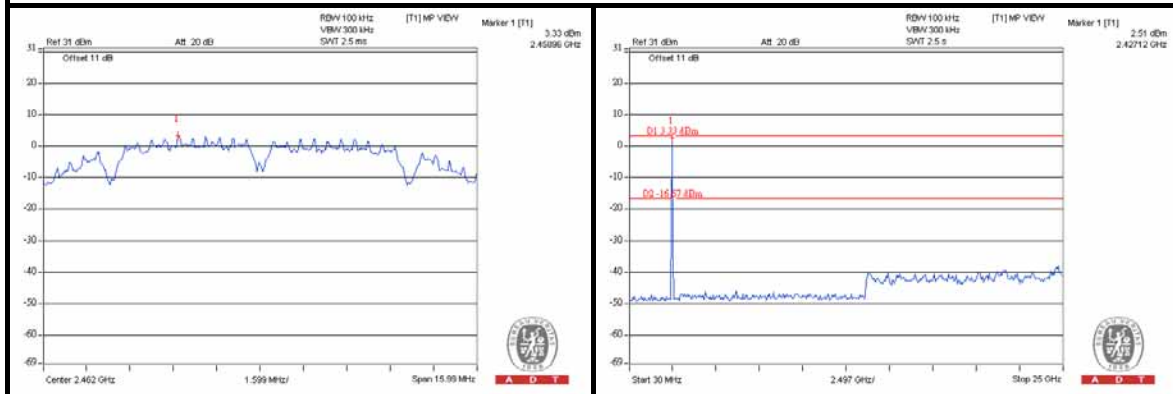



A D T

802.11g

### CH 1

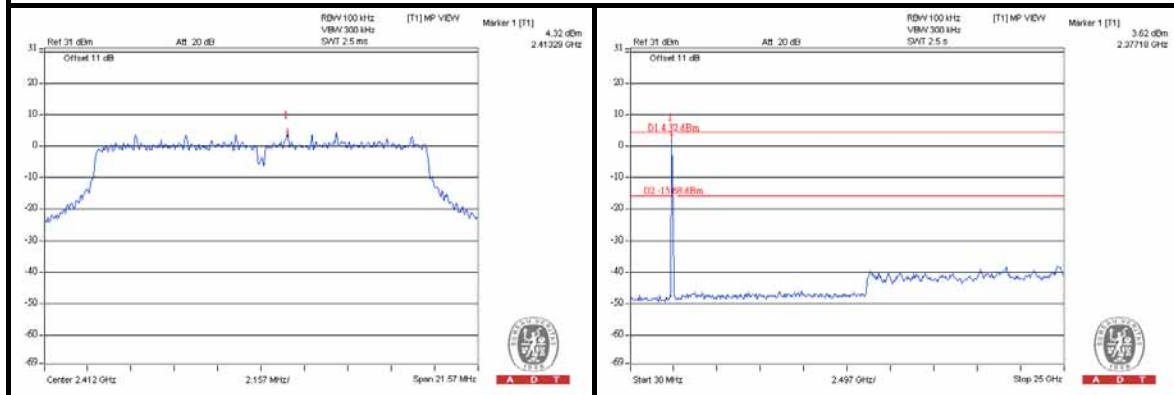

### CH 6

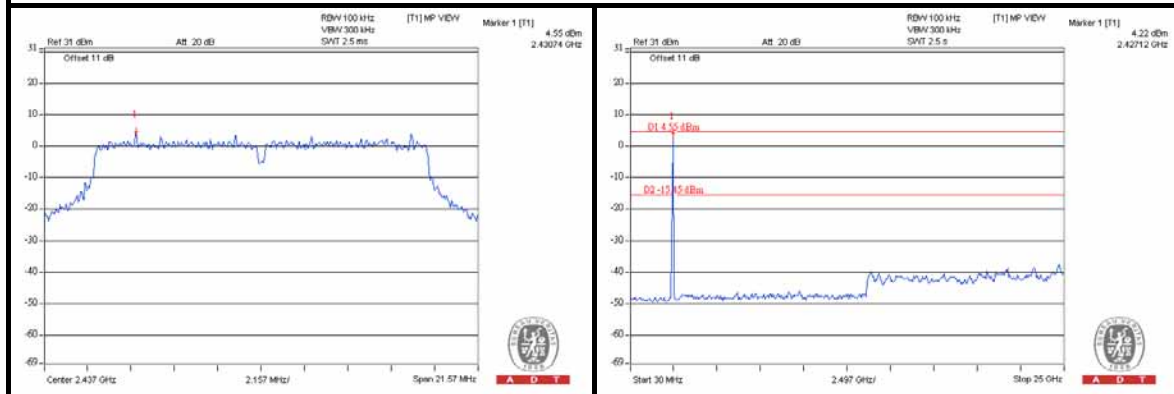

### CH 11

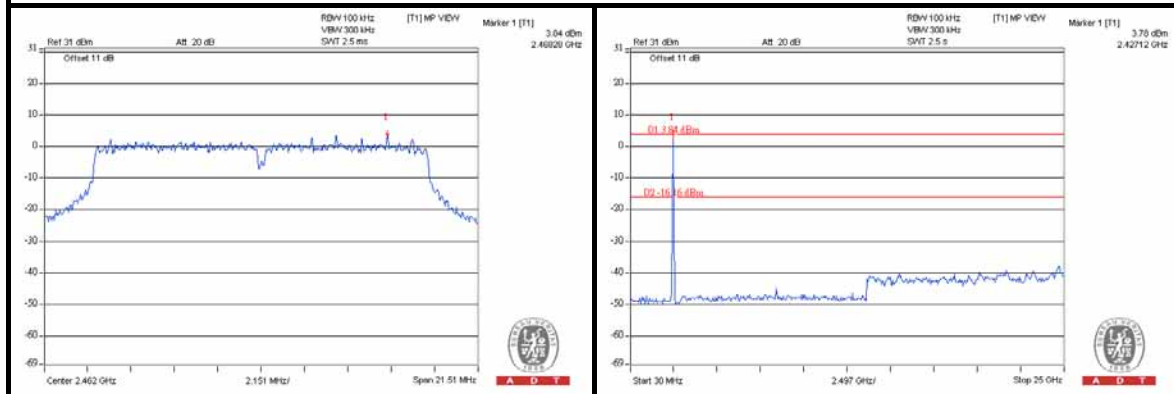





A D T

### 802.11n (20MHz)

#### CH 1

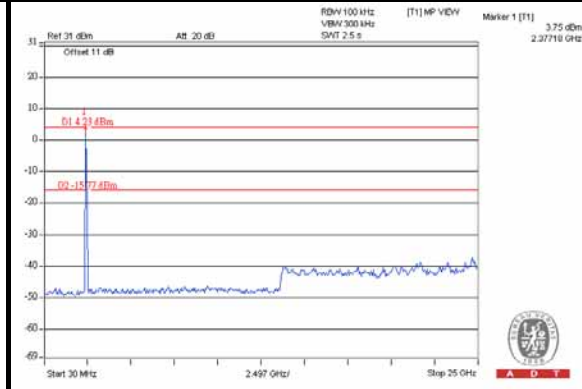
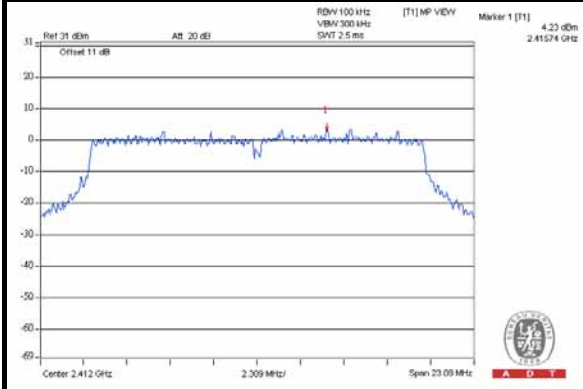

#### CH 6

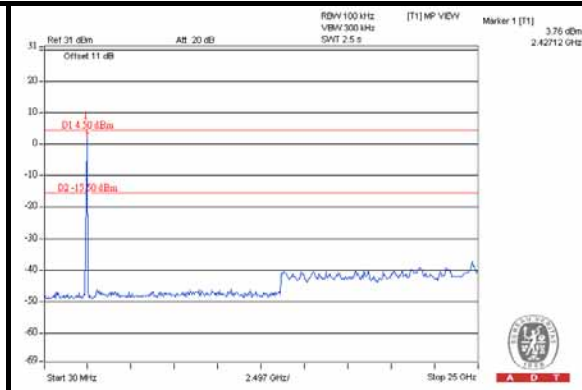
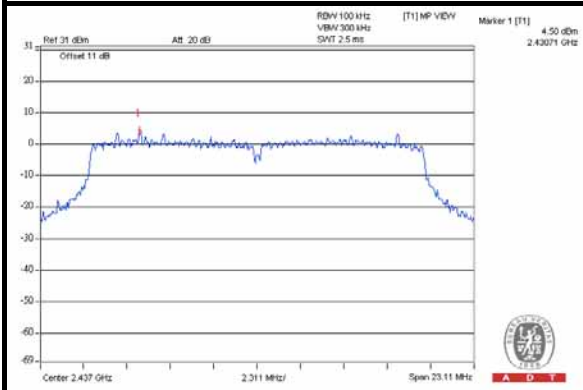

#### CH 11

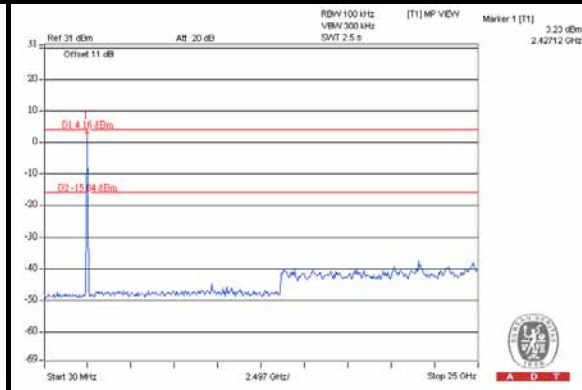
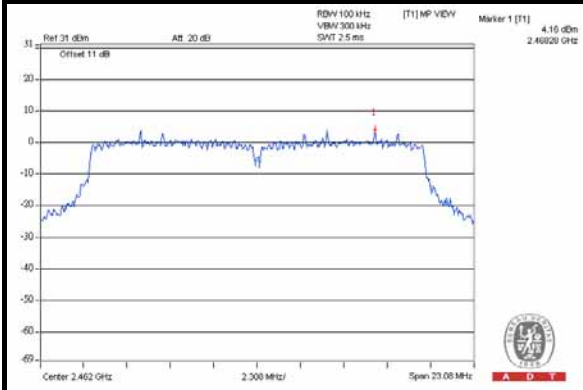



A D T

### 802.11n (40MHz)

#### CH 1

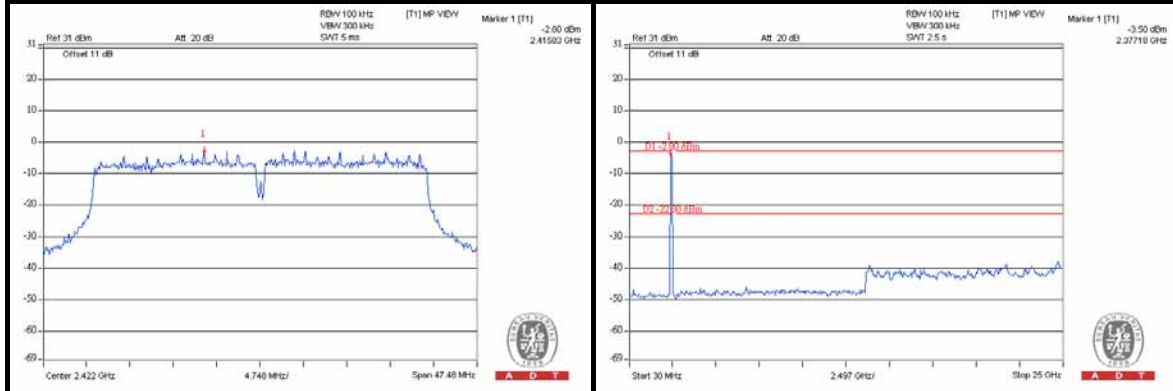

#### CH 4

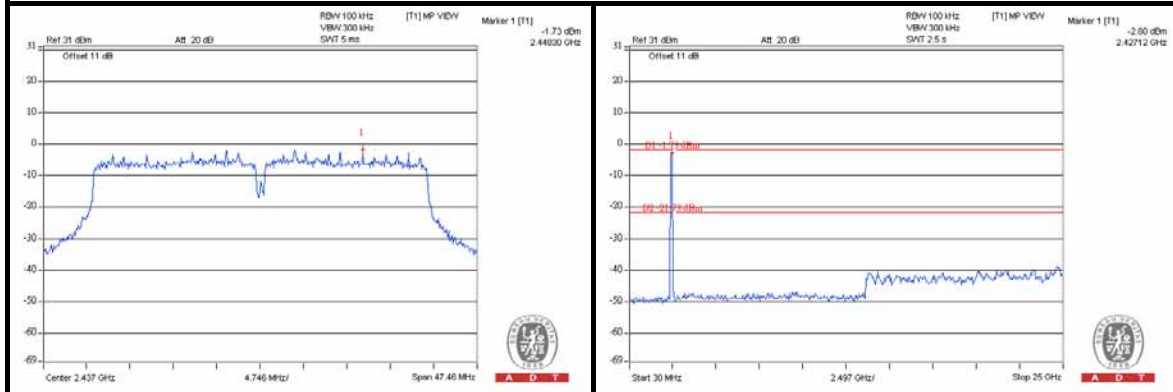

#### CH 7

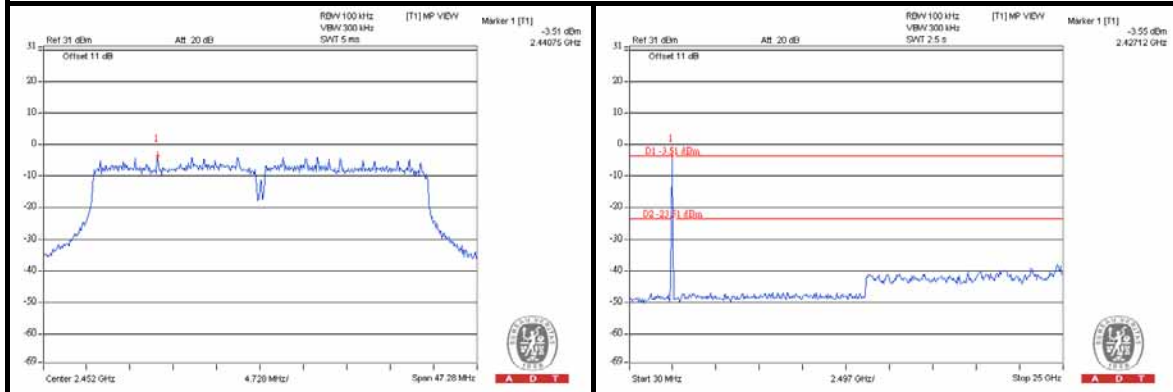



## 5. PHOTOGRAPHS OF THE TEST CONFIGURATION

Please refer to the attached file (Test Setup Photo).



## 6. INFORMATION ON THE TESTING LABORATORIES

We, Bureau Veritas Consumer Products Services (H.K.) Ltd., Taoyuan Branch, were founded in 1988 to provide our best service in EMC, Radio, Telecom and Safety consultation. Our laboratories are accredited and approved according to ISO/IEC 17025.

Copies of accreditation and authorization certificates of our laboratories obtained from approval agencies can be downloaded from our web site: [www.adt.com.tw/index.5.phtml](http://www.adt.com.tw/index.5.phtml). If you have any comments, please feel free to contact us at the following:

**Linko EMC/RF Lab:**

Tel: 886-2-26052180

Fax: 886-2-26051924

**Hsin Chu EMC/RF Lab:**

Tel: 886-3-5935343

Fax: 886-3-5935342

**Hwa Ya EMC/RF/Safety Telecom Lab:**

Tel: 886-3-3183232

Fax: 886-3-3185050

**Email:** [service.adt@tw.bureauveritas.com](mailto:service.adt@tw.bureauveritas.com)

**Web Site:** [www.adt.com.tw](http://www.adt.com.tw)

The address and road map of all our labs can be found in our web site also.



## **7. APPENDIX A - MODIFICATIONS RECORDERS FOR ENGINEERING CHANGES TO THE EUT BY THE LAB**

No modifications were made to the EUT by the lab during the test.

**---END---**