



A D T

# FCC TEST REPORT

**REPORT NO.:** RF140703C08

**MODEL NO.:** EAP350v2

**FCC ID:** A8J-EAP350

**RECEIVED:** Jul. 03, 2014

**TESTED:** Jul. 09 ~ Jul. 29, 2014

**ISSUED:** Jul. 31, 2014

**APPLICANT:** EnGenius Technologies

**ADDRESS:** 1580 Scenic Avenue, Costa Mesa, CA92626

**ISSUED BY:** Bureau Veritas Consumer Products Services  
(H.K.) Ltd., Taoyuan Branch

**LAB ADDRESS:** No. 47, 14th Ling, Chia Pau Vil., Lin Kou Dist.,  
New Taipei City, Taiwan, R.O.C.

**TEST LOCATION:** No. 19, Hwa Ya 2nd Rd, Wen Hwa Tsuen, Kwei  
Shan Hsiang, Taoyuan Hsien 333, Taiwan, R.O.C.

This report should not be used by the client to claim product certification, approval, or endorsement by TAF or any government agencies.



This report is for your exclusive use. Any copying or replication of this report to or for any other person or entity, or use of our name or trademark, is permitted only with our prior written permission. This report sets forth our findings solely with respect to the test samples identified herein. The results set forth in this report are not indicative or representative of the quality or characteristics of the lot from which a test sample was taken or any similar or identical product unless specifically and expressly noted. Our report includes all of the tests requested by you and the results thereof based upon the information that you provided to us. You have 60 days from date of issuance of this report to notify us of any material error or omission caused by our negligence, provided, however, that such notice shall be in writing and shall specifically address the issue you wish to raise. A failure to raise such issue within the prescribed time shall constitute your unqualified acceptance of the completeness of this report, the tests conducted and the correctness of the report contents. Unless specific mention, the uncertainty of measurement has been explicitly taken into account to declare the compliance or non-compliance to the specification.



A D T

## TABLE OF CONTENTS

RELEASE CONTROL RECORD .....	4
1. CERTIFICATION.....	5
2. SUMMARY OF TEST RESULTS .....	6
2.1 MEASUREMENT UNCERTAINTY .....	6
3. GENERAL INFORMATION.....	7
3.1 GENERAL DESCRIPTION OF EUT.....	7
3.2 DESCRIPTION OF TEST MODES.....	9
3.2.1 TEST MODE APPLICABILITY AND TESTED CHANNEL DETAIL.....	10
3.3 DUTY CYCLE OF TEST SIGNAL.....	13
3.4 DESCRIPTION OF SUPPORT UNITS.....	14
3.4.1 CONFIGURATION OF SYSTEM UNDER TEST .....	15
3.5 GENERAL DESCRIPTION OF APPLIED STANDARDS.....	17
4. TEST TYPES AND RESULTS .....	18
4.1 RADIATED EMISSION AND BANDEDGE MEASUREMENT .....	18
4.1.1 LIMITS OF RADIATED EMISSION AND BANDEDGE MEASUREMENT.....	18
4.1.2 TEST INSTRUMENTS.....	19
4.1.3 TEST PROCEDURES .....	20
4.1.4 DEVIATION FROM TEST STANDARD .....	20
4.1.5 TEST SETUP.....	21
4.1.6 EUT OPERATING CONDITIONS .....	22
4.1.7 TEST RESULTS .....	23
4.2 CONDUCTED EMISSION MEASUREMENT .....	37
4.2.1 LIMITS OF CONDUCTED EMISSION MEASUREMENT .....	37
4.2.2 TEST INSTRUMENTS.....	37
4.2.3 TEST PROCEDURES .....	38
4.2.4 DEVIATION FROM TEST STANDARD .....	38
4.2.5 TEST SETUP.....	38
4.2.6 EUT OPERATING CONDITIONS .....	38
4.2.7 TEST RESULTS .....	39
4.3 6dB BANDWIDTH MEASUREMENT .....	43
4.3.1 LIMITS OF 6dB BANDWIDTH MEASUREMENT.....	43
4.3.2 TEST SETUP .....	43
4.3.3 TEST INSTRUMENTS.....	43
4.3.4 TEST PROCEDURE.....	43
4.3.5 DEVIATION FROM TEST STANDARD .....	43
4.3.6 EUT OPERATING CONDITIONS .....	43
4.3.7 TEST RESULTS .....	44
4.4 CONDUCTED OUTPUT POWER .....	46
4.4.1 LIMITS OF CONDUCTED OUTPUT POWER MEASUREMENT .....	46
4.4.2 TEST SETUP .....	46
4.4.3 TEST INSTRUMENTS.....	46
4.4.4 TEST PROCEDURES .....	46



A D T

4.4.5	DEVIATION FROM TEST STANDARD .....	47
4.4.6	EUT OPERATING CONDITIONS .....	47
4.4.7	TEST RESULTS .....	48
4.5	POWER SPECTRAL DENSITY MEASUREMENT.....	49
4.5.1	LIMITS OF POWER SPECTRAL DENSITY MEASUREMENT.....	49
4.5.2	TEST SETUP.....	49
4.5.3	TEST INSTRUMENTS.....	49
4.5.4	TEST PROCEDURE.....	49
4.5.5	DEVIATION FROM TEST STANDARD .....	49
4.5.6	EUT OPERATING CONDITION .....	49
4.5.7	TEST RESULTS .....	50
4.6	CONDUCTED OUT OF BAND EMISSION MEASUREMENT .....	53
4.6.1	LIMITS OF CONDUCTED OUT OF BAND EMISSION MEASUREMENT.....	53
4.6.2	TEST SETUP.....	53
4.6.3	TEST INSTRUMENTS.....	53
4.6.4	TEST PROCEDURE.....	54
4.6.5	DEVIATION FROM TEST STANDARD .....	54
4.6.6	EUT OPERATING CONDITION .....	54
4.6.7	TEST RESULTS .....	54
5.	PHOTOGRAPHS OF THE TEST CONFIGURATION .....	63
6.	INFORMATION ON THE TESTING LABORATORIES.....	64
7.	APPENDIX A - MODIFICATIONS RECORDERS FOR ENGINEERING CHANGES TO THE EUT BY THE LAB.....	65



A D T

## RELEASE CONTROL RECORD

ISSUE NO.	REASON FOR CHANGE	DATE ISSUED
RF140703C08	Original release.	Jul. 31, 2014



# 1. CERTIFICATION

**PRODUCT:** Wireless N300 Indoor Access Point  
**MODEL NO.:** EAP350v2  
**BRAND:** EnGenius  
**APPLICANT:** EnGenius Technologies  
**TESTED:** Jul. 09 ~ Jul. 29, 2014  
**TEST SAMPLE:** ENGINEERING SAMPLE  
**STANDARDS:** **FCC Part 15, Subpart C (Section 15.247)**  
ANSI C63.10-2009

The above equipment (model: EAP350v2) has been tested by **Bureau Veritas Consumer Products Services (H.K.) Ltd., Taoyuan Branch**, and found compliance with the requirement of the above standards. The test record, data evaluation & Equipment Under Test (EUT) configurations represented herein are true and accurate accounts of the measurements of the sample's EMC characteristics under the conditions specified in this report.

**PREPARED BY :** Celine Chou , **DATE :** Jul. 31, 2014  
Celine Chou / Specialist

**APPROVED BY :** Ken Liu , **DATE :** Jul. 31, 2014  
Ken Liu / Senior Manager

## 2. SUMMARY OF TEST RESULTS

The EUT has been tested according to the following specifications:

APPLIED STANDARD: FCC PART 15, SUBPART C (SECTION 15.247)			
STANDARD SECTION	TEST TYPE	RESULT	REMARK
15.207	AC Power Conducted Emission	PASS	Meet the requirement of limit. Minimum passing margin is -5.63dB at 3.61035MHz.
15.205 & 209	Radiated Emissions	PASS	Meet the requirement of limit. Minimum passing margin is -0.7dB at 2390.00 and 2483.50MHz.
15.247(d)	Band Edge Measurement	PASS	Meet the requirement of limit. Minimum passing margin is -0.7dB at 2483.50MHz.
15.247(d)	Antenna Port Emission	PASS	Meet the requirement of limit.
15.247(a)(2)	6dB bandwidth	PASS	Meet the requirement of limit.
15.247(b)	Conducted power	PASS	Meet the requirement of limit.
15.247(e)	Power Spectral Density	PASS	Meet the requirement of limit.
15.203	Antenna Requirement	PASS	Antenna connector is IPEX not a standard connector.

### 2.1 MEASUREMENT UNCERTAINTY

Where relevant, the following measurement uncertainty levels have been estimated for tests performed on the EUT as specified in CISPR 16-4-2:

MEASUREMENT	FREQUENCY	UNCERTAINTY
Conducted emissions	150kHz~30MHz	2.44 dB
Radiated emissions	30MHz ~ 200MHz	3.34 dB
	200MHz ~1000MHz	3.35 dB
	1GHz ~ 18GHz	2.26 dB
	18GHz ~ 40GHz	1.94 dB

This uncertainty represents an expanded uncertainty expressed at approximately the 95% confidence level using a coverage factor of  $k = 2$ .



### 3. GENERAL INFORMATION

#### 3.1 GENERAL DESCRIPTION OF EUT

<b>EUT</b>	Wireless N300 Indoor Access Point
<b>MODEL NO.</b>	EAP350v2
<b>POWER SUPPLY</b>	12Vdc from Adapter 48Vdc from POE
<b>MODULATION TYPE</b>	CCK, DQPSK, DBPSK for DSSS 64QAM, 16QAM, QPSK, BPSK for OFDM
<b>MODULATION TECHNOLOGY</b>	DSSS, OFDM
<b>TRANSFER RATE</b>	802.11b: 11.0/ 5.5/ 2.0/ 1.0Mbps 802.11g: 54.0/ 48.0/ 36.0/ 24.0/ 18.0/ 12.0/ 9.0/ 6.0Mbps 802.11n: up to 300.0Mbps
<b>OPERATING FREQUENCY</b>	2412 ~ 2462MHz
<b>NUMBER OF CHANNEL</b>	11 for 802.11b, 802.11g, 802.11n (20MHz) 7 for 802.11n (40MHz)
<b>OUTPUT POWER</b>	93.902mW
<b>ANTENNA TYPE</b>	Refer to note
<b>ANTENNA CONNECTOR</b>	Refer to note
<b>DATA CABLE</b>	0.5m non-shielded RJ45 cable without core
<b>I/O PORTS</b>	Refer to user's manual
<b>ACCESSORY DEVICES</b>	Adapter

**NOTE:**

1. The EUT incorporates a MIMO function. Physically, the EUT provides 2 completed transmitters and 2 receivers.

<b>MODULATION MODE</b>	<b>TX FUNCTION</b>
<b>802.11b</b>	2TX
<b>802.11g</b>	2TX
<b>802.11n (20MHz)</b>	2TX
<b>802.11n (40MHz)</b>	2TX

2. The EUT with follow antennas gain is listed as table below.

<b>Antenna Item</b>	<b>Antenna Type</b>	<b>Connector</b>	<b>Gain(dBi)</b>
1	PCB	IPEX	4
2			3



A D T

3. The EUT consumes power from the following adapter and POE.

Adapter	
Brand	DVE
Model	DSA-12G-12 FUS 120120
Input Power	100-240Vac, 50/60Hz, 0.3A
Output Power	12Vdc, 1A
Power Line	1.5m cable without core attached on adapter

POE	
Brand	EnGenius
Model	EPE-48GR
Power Rating	48Vdc, 0.8A, 38.4W Max

POE's Adapter	
Brand	Powertron Electronics Corp.
Model	PA1040-480IB080
Input Power	100-240Vac, 50-60Hz, 1.5A
Output Power	48Vdc, 0.8A, 38.4W Max
Power Line	1.55m cable with one core attached on adapter

\* POE for support unit only.

4. The above EUT information is declared by the manufacturer and for more detailed features description, please refer to the manufacturer's specifications or User's Manual.



### 3.2 DESCRIPTION OF TEST MODES

11 channels are provided for 802.11b, 802.11g and 802.11n (20MHz):

CHANNEL	FREQUENCY	CHANNEL	FREQUENCY
1	2412MHz	7	2442MHz
2	2417MHz	8	2447MHz
3	2422MHz	9	2452MHz
4	2427MHz	10	2457MHz
5	2432MHz	11	2462MHz
6	2437MHz		

7 channels are provided for 802.11n (40MHz):

CHANNEL	FREQUENCY	CHANNEL	FREQUENCY
3	2422MHz	7	2442MHz
4	2427MHz	8	2447MHz
5	2432MHz	9	2452MHz
6	2437MHz		



### 3.2.1 TEST MODE APPLICABILITY AND TESTED CHANNEL DETAIL

EUT CONFIGURE MODE	APPLICABLE TO				DESCRIPTION
	RE $\geq$ 1G	RE<1G	PLC	APCM	
A	√	√	√	√	Powered by Adapter
B	-	√	√	-	Powered by POE

Where **RE $\geq$ 1G**: Radiated Emission above 1GHz      **RE<1G**: Radiated Emission below 1GHz  
**PLC**: Power Line Conducted Emission      **APCM**: Antenna Port Conducted Measurement

**NOTE:**

1. The EUT had been pre-tested on the positioned of each 3 axis. The worst case was found when positioned on **Z-plane**.
2. "-" means no effect.

**RADIATED EMISSION TEST (ABOVE 1GHz):**

- Pre-Scan has been conducted to determine the worst-case mode from all possible combinations between available modulations, data rates and antenna ports (if EUT with antenna diversity architecture).
- Following channel(s) was (were) selected for the final test as listed below.

EUT CONFIGURE MODE	MODE	AVAILABLE CHANNEL	TESTED CHANNEL	MODULATION TECHNOLOGY	MODULATION TYPE	DATA RATE (Mbps)
A	802.11b	1 to 11	1, 6, 11	DSSS	DBPSK	1.0
A	802.11g	1 to 11	1, 6, 11	OFDM	BPSK	6.0
A	802.11n (20MHz)	1 to 11	1, 6, 11	OFDM	BPSK	7.2
A	802.11n (40MHz)	3 to 9	3, 6, 9	OFDM	BPSK	15.0

**RADIATED EMISSION TEST (BELOW 1GHz):**

- Pre-Scan has been conducted to determine the worst-case mode from all possible combinations between available modulations, data rates and antenna ports (if EUT with antenna diversity architecture).
- Following channel(s) was (were) selected for the final test as listed below.

EUT CONFIGURE MODE	MODE	AVAILABLE CHANNEL	TESTED CHANNEL	MODULATION TECHNOLOGY	MODULATION TYPE	DATA RATE (Mbps)
A & B	802.11b	1 to 11	1	DSSS	DBPSK	1.0



**POWER LINE CONDUCTED EMISSION TEST:**

- Pre-Scan has been conducted to determine the worst-case mode from all possible combinations between available modulations, data rates and antenna ports (if EUT with antenna diversity architecture).
- Following channel(s) was (were) selected for the final test as listed below.

EUT CONFIGURE MODE	MODE	AVAILABLE CHANNEL	TESTED CHANNEL	MODULATION TECHNOLOGY	MODULATION TYPE	DATA RATE (Mbps)
A & B	802.11b	1 to 11	1	DSSS	DBPSK	1.0

**BANDEDGE MEASUREMENT:**

- Pre-Scan has been conducted to determine the worst-case mode from all possible combinations between available modulations, data rates and antenna ports (if EUT with antenna diversity architecture).
- Following channel(s) was (were) selected for the final test as listed below.

EUT CONFIGURE MODE	MODE	AVAILABLE CHANNEL	TESTED CHANNEL	MODULATION TECHNOLOGY	MODULATION TYPE	DATA RATE (Mbps)
A	802.11b	1 to 11	1, 11	DSSS	DBPSK	1.0
A	802.11g	1 to 11	1, 11	OFDM	BPSK	6.0
A	802.11n (20MHz)	1 to 11	1, 11	OFDM	BPSK	7.2
A	802.11n (40MHz)	3 to 9	3, 9	OFDM	BPSK	15.0

**ANTENNA PORT CONDUCTED MEASUREMENT:**

- This item includes all test value of each mode, but only includes spectrum plot of worst value of each mode.
- Pre-Scan has been conducted to determine the worst-case mode from all possible combinations between available modulations, data rates and antenna ports (if EUT with antenna diversity architecture).
- Following channel(s) was (were) selected for the final test as listed below.

EUT CONFIGURE MODE	MODE	AVAILABLE CHANNEL	TESTED CHANNEL	MODULATION TECHNOLOGY	MODULATION TYPE	DATA RATE (Mbps)
A	802.11b	1 to 11	1, 6, 11	DSSS	DBPSK	1.0
A	802.11g	1 to 11	1, 6, 11	OFDM	BPSK	6.0
A	802.11n (20MHz)	1 to 11	1, 6, 11	OFDM	BPSK	7.2
A	802.11n (40MHz)	3 to 9	3, 6, 9	OFDM	BPSK	15.0



A D T

**TEST CONDITION:**

APPLICABLE TO	ENVIRONMENTAL CONDITIONS	INPUT POWER	TESTED BY
RE $\geq$ 1G	25deg. C, 65%RH	120Vac, 60Hz	Jones Chang
RE<1G	21deg. C, 65%RH	120Vac, 60Hz	Jones Chang
PLC	25deg. C, 65%RH	120Vac, 60Hz	Chris Lin
APCM	25deg. C, 60%RH	120Vac, 60Hz	Ted Chang

### 3.3 DUTY CYCLE OF TEST SIGNAL

**802.11b:** Duty cycle of test signal is 100 %, duty factor is not required.

**802.11g, 802.11n (20MHz), 802.11n (40MHz):** Duty cycle is < 98%, duty factor shall be considered.

**802.11g:** Duty cycle =  $1.357/1.410 = 0.962$ , Duty factor =  $10 * \log(1/0.962) = 0.17$

**802.11n (20MHz):** Duty cycle =  $1.266/1.327 = 0.954$ , Duty factor =  $10 * \log(1/0.954) = 0.20$

**802.11n (40MHz):** Duty cycle =  $0.628/0.677 = 0.928$ , Duty factor =  $10 * \log(1/0.928) = 0.33$

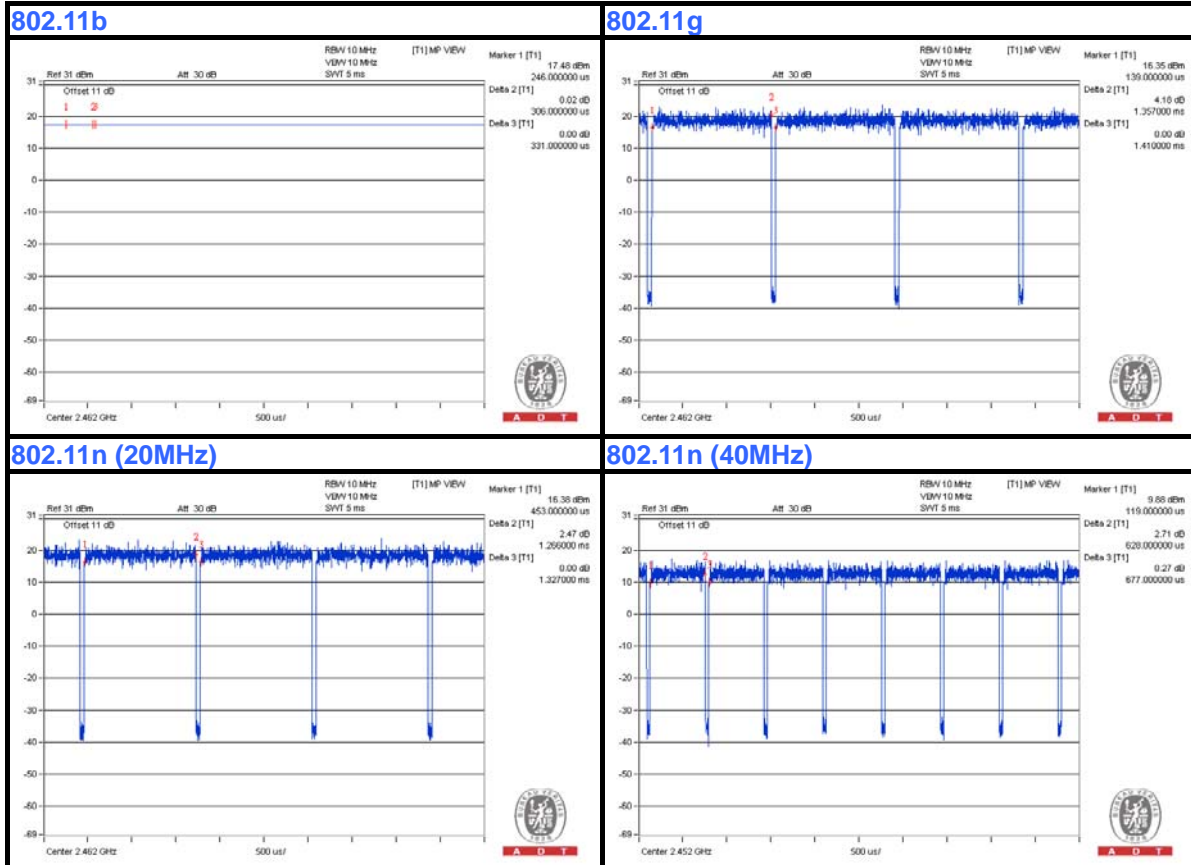

### 3.4 DESCRIPTION OF SUPPORT UNITS

The EUT has been tested as an independent unit together with other necessary accessories or support units. The following support units or accessories were used to form a representative test configuration during the tests.

NO.	PRODUCT	BRAND	MODEL NO.	SERIAL NO.	FCC ID
1	Notebook	DELL	D531	CN-0XM006-486 43-81U-2610	QDS-BRCM1020
2	POE	EnGenius	EPE-48GR	NA	NA
3	POE's Adapter	Powertron Electronics Corp.	PA1040-480IB080	NA	NA

NO.	SIGNAL CABLE DESCRIPTION OF THE ABOVE SUPPORT UNITS
1	10m RJ45 Cable for mode A, 1.8m RJ45 Cable for mode B
2	10m RJ45 Cable
3	NA

**NOTE:**

1. All power cords of the above support units are non-shielded (1.8 m).
2. Item 1 acted as a communication partner to transfer data.
3. Item 2, 3 were provided by manufacturer and for mode B tested only.

### 3.4.1 CONFIGURATION OF SYSTEM UNDER TEST

#### TEST MODE A

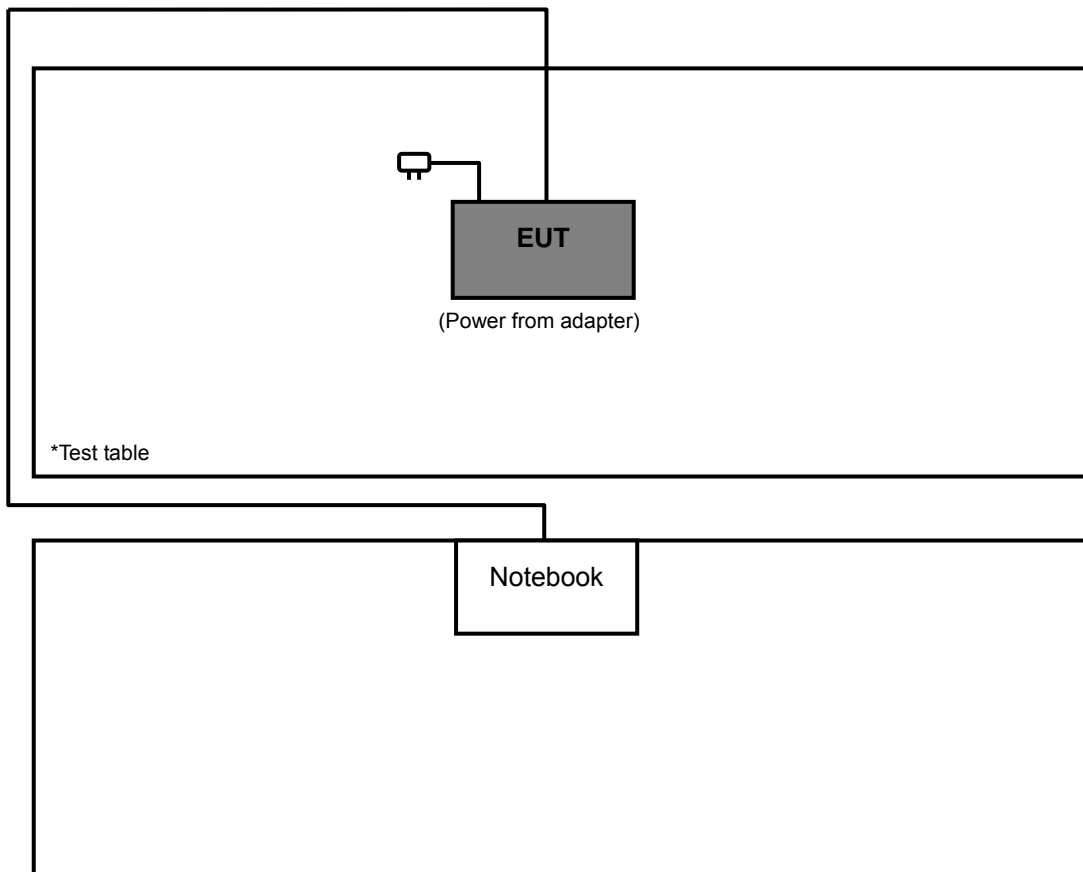



## TEST MODE B

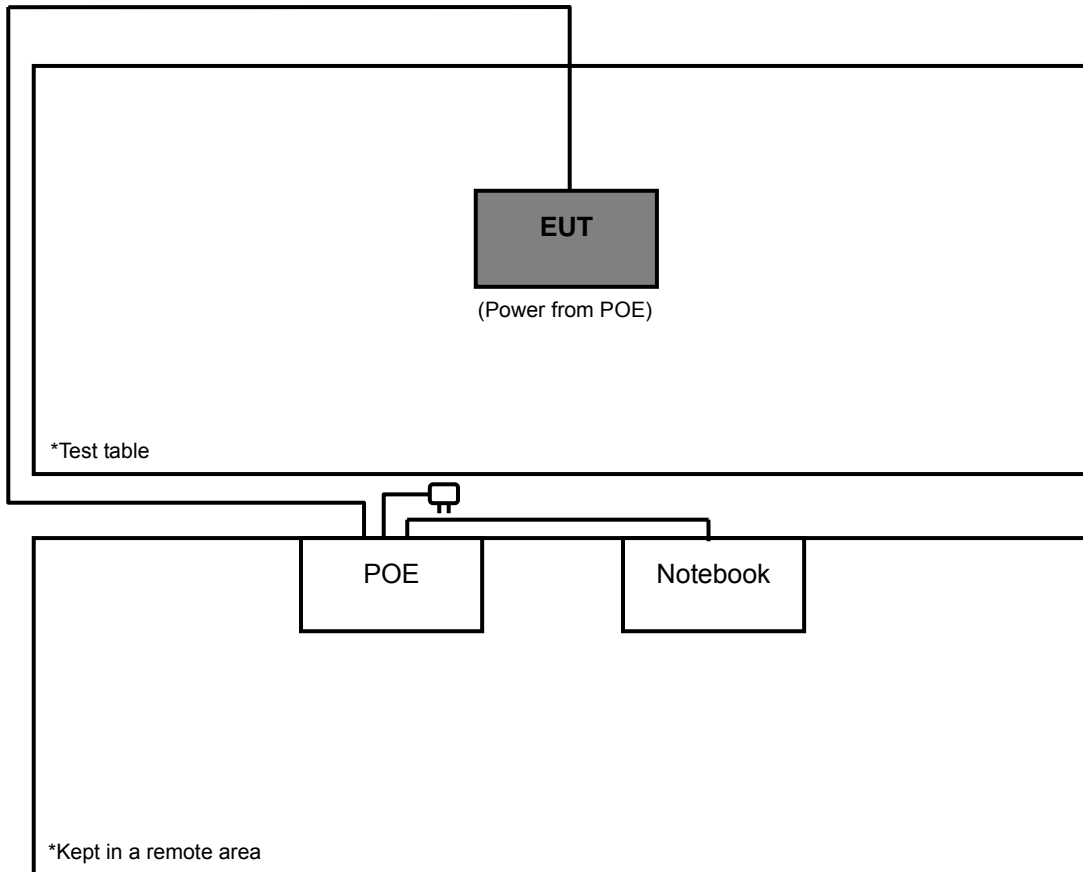



### 3.5 GENERAL DESCRIPTION OF APPLIED STANDARDS

The EUT is a RF Product. According to the specifications of the manufacturer, it must comply with the requirements of the following standards:

**FCC Part 15, Subpart C (15.247)**

**558074 D01 DTS Meas Guidance v03r02**

**662911 D01 Multiple Transmitter Output v02r01**

**ANSI C63.10-2009**

All test items have been performed and recorded as per the above standards.

**NOTE:** The EUT is also considered as a kind of computer peripheral, because the connection to computer is necessary for typical use. It has been verified to comply with the requirements of FCC Part 15, Subpart B, Class B (DoC). The test report has been issued separately.

## 4. TEST TYPES AND RESULTS

### 4.1 RADIATED EMISSION AND BANDEDGE MEASUREMENT

#### 4.1.1 LIMITS OF RADIATED EMISSION AND BANDEDGE MEASUREMENT

Radiated emissions which fall in the restricted bands must comply with the radiated emission limits specified as below table. Other emissions shall be at least 30dB below the highest level of the desired power:

FREQUENCIES (MHz)	FIELD STRENGTH (microvolts/meter)	MEASUREMENT DISTANCE (meters)
0.009 ~ 0.490	2400/F(kHz)	300
0.490 ~ 1.705	24000/F(kHz)	30
1.705 ~ 30.0	30	30
30 ~ 88	100	3
88 ~ 216	150	3
216 ~ 960	200	3
Above 960	500	3

**NOTE:**

1. The lower limit shall apply at the transition frequencies.
2. Emission level (dBuV/m) = 20 log Emission level (uV/m).
3. For frequencies above 1000MHz, the field strength limits are based on average detector, however, the peak field strength of any emission shall not exceed the maximum permitted average limits, specified above by more than 30dB under any condition of modulation.



A D T

#### 4.1.2 TEST INSTRUMENTS

DESCRIPTION & MANUFACTURER	MODEL NO.	SERIAL NO.	DATE OF CALIBRATION	DUE DATE OF CALIBRATION
Test Receiver ROHDE & SCHWARZ	ESIB7	100187	Jan. 02, 2014	Jan. 01, 2015
Spectrum Analyzer ROHDE & SCHWARZ	FSP40	100039	Mar. 03, 2014	Mar. 02, 2015
BILOG Antenna SCHWARZBECK	VULB9168	9168-160	Feb. 26, 2014	Feb. 25, 2015
HORN Antenna SCHWARZBECK	9120D	209	Sep. 12, 2013	Sep. 11, 2014
HORN Antenna SCHWARZBECK	BBHA 9170	BBHA9170241	Feb. 17, 2014	Feb. 16, 2015
Preamplifier Agilent	8447D	2944A10633	Oct. 07, 2013	Oct. 06, 2014
Preamplifier Agilent	8449B	3008A01964	Aug. 26, 2013	Aug. 25, 2014
RF signal cable HUBER+SUHNNER	SUCOFLEX 104	214378/4	Aug. 26, 2013	Aug. 25, 2014
RF signal cable HUBER+SUHNNER	SUCOFLEX 106	12738/6 +309224/4	Aug. 26, 2013	Aug. 25, 2014
Software BV ADT	ADT_Radiated_ V7.6.15.9.4	NA	NA	NA
Antenna Tower inn-co GmbH	MA 4000	013303	NA	NA
Antenna Tower Controller inn-co GmbH	CO2000	017303	NA	NA
Turn Table BV ADT	TT100	TT93021703	NA	NA
Turn Table Controller BV ADT	SC100	SC93021703	NA	NA
High Speed Peak Power Meter	ML2495A	0824011	Jul. 29, 2013	Jul. 28, 2014
			Jul. 29, 2014	Jul. 28, 2015
Power Sensor	MA2411B	0738171	Jul. 29, 2013	Jul. 28, 2014
			Jul. 29, 2014	Jul. 28, 2015

- NOTE:** 1. The calibration interval of the above test instruments is 12 months and the calibrations are traceable to NML/ROC and NIST/USA.
2. The test was performed in HwaYa Chamber 3.
3. The horn antenna and HP preamplifier (model: 8449B) are used only for the measurement of emission frequency above 1GHz if tested.
4. The FCC Site Registration No. is 988962.
5. The IC Site Registration No. is IC 7450F-3.

#### 4.1.3 TEST PROCEDURES

- a. The EUT was placed on the top of a rotating table 0.8 meters above the ground at a 3 meters semi-anechoic chamber. The table was rotated 360 degrees to determine the position of the highest radiation.
- b. The EUT was set 3 meters away from the interference-receiving antenna, which was mounted on the top of a variable-height antenna tower.
- c. Height of receiving antenna is varied from one meter to four meters above the ground to determine the maximum value of the field strength. Both horizontal and vertical polarizations of the antenna are set to make the measurement.
- d. For each suspected emission, the EUT was arranged to its worst case and then the antenna was tuned to heights from 1 meter to 4 meters and the rotatable table was turned from 0 degrees to 360 degrees to find the maximum reading.
- e. The test-receiver system was set to Peak Detect Function and Specified Bandwidth with Maximum Hold Mode.
- f. If the emission level of the EUT in peak mode was lower than the limit specified, then testing could be stopped and the peak values of the EUT would be reported. Otherwise the emissions would be re-tested one by one using peak, quasi-peak or average method as specified and then reported in a data sheet.

**NOTE:**

1. The resolution bandwidth and video bandwidth of test receiver/spectrum analyzer is 120kHz for Quasi-peak detection at frequency below 1GHz.
2. The resolution bandwidth of test receiver/spectrum analyzer is 1MHz and video bandwidth is 3MHz for Peak detection at frequency above 1GHz.
3. The resolution bandwidth of test receiver/spectrum analyzer is 1MHz and the video bandwidth is  $\geq 1/T$  (Duty cycle < 98%) or 10Hz(Duty cycle > 98%) for Average detection (AV) at frequency above 1GHz.
4. All modes of operation were investigated and the worst-case emissions are reported.

#### 4.1.4 DEVIATION FROM TEST STANDARD

No deviation.

### 4.1.5 TEST SETUP

#### Frequency range 30MHz~1GHz

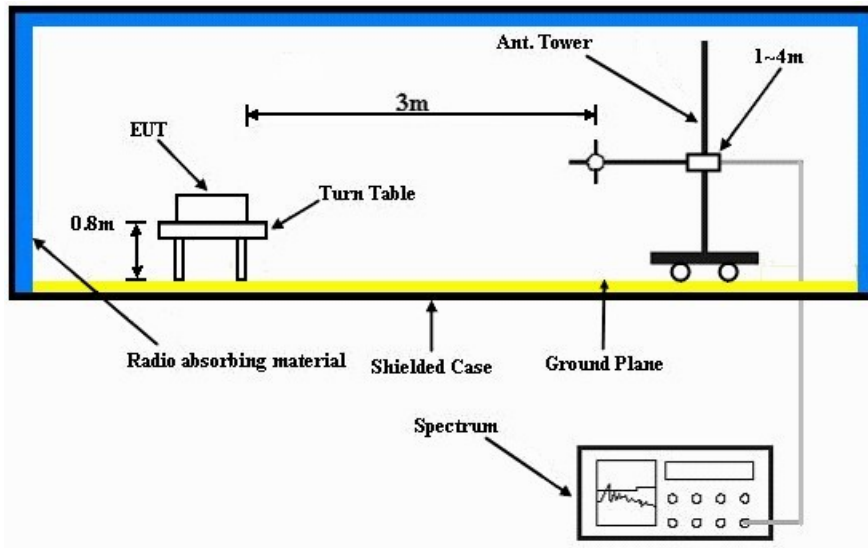

#### Frequency range above 1GHz

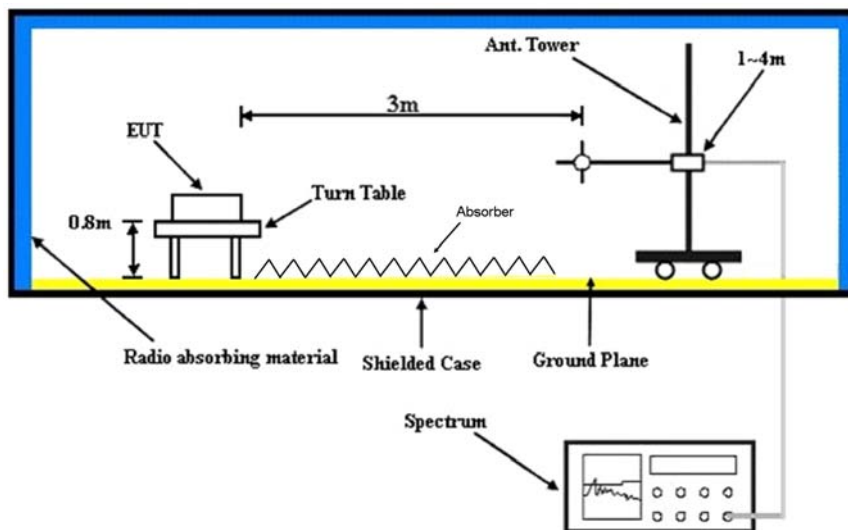

For the actual test configuration, please refer to the attached file (Test Setup Photo).

#### 4.1.6 EUT OPERATING CONDITIONS

- a. Placed the EUT on the testing table.
- b. Prepared notebook to act as communication partner and placed it outside of testing area.
- c. The communication partner connected with EUT via a RJ45 cable and run a test program (provided by manufacturer) to enable EUT under transmission condition continuously at specific channel frequency.
- d. The communication partner sent data to EUT by command "PING".



A D T

## 4.1.7 TEST RESULTS

## ABOVE 1GHz DATA :

## 802.11b

EUT TEST CONDITION		MEASUREMENT DETAIL	
CHANNEL	Channel 1	FREQUENCY RANGE	1 ~ 25GHz
INPUT POWER	120Vac, 60Hz	DETECTOR FUNCTION	Peak (PK) Average (AV)
ENVIRONMENTAL CONDITIONS	25deg. C, 65%RH	TESTED BY	Jones Chang

ANTENNA POLARITY & TEST DISTANCE: HORIZONTAL AT 3 M								
NO.	FREQ. (MHz)	EMISSION LEVEL (dBuV/m)	LIMIT (dBuV/m)	MARGIN (dB)	ANTENNA HEIGHT (m)	TABLE ANGLE (Degree)	RAW VALUE (dBuV)	CORRECTION FACTOR (dB/m)
1	2280.00	51.3 PK	74.0	-22.7	1.12 H	348	51.60	-0.30
2	2280.00	45.6 AV	54.0	-8.4	1.12 H	348	45.90	-0.30
3	2360.00	60.8 PK	74.0	-13.2	1.11 H	340	29.90	30.90
4	2360.00	48.8 AV	54.0	-5.2	1.11 H	340	17.90	30.90
5	*2412.00	108.9 PK			1.09 H	338	77.80	31.10
6	*2412.00	105.3 AV			1.09 H	338	74.20	31.10
7	4824.00	47.5 PK	74.0	-26.5	1.23 H	148	42.60	4.90
8	4824.00	34.9 AV	54.0	-19.1	1.23 H	148	30.00	4.90
ANTENNA POLARITY & TEST DISTANCE: VERTICAL AT 3 M								
NO.	FREQ. (MHz)	EMISSION LEVEL (dBuV/m)	LIMIT (dBuV/m)	MARGIN (dB)	ANTENNA HEIGHT (m)	TABLE ANGLE (Degree)	RAW VALUE (dBuV)	CORRECTION FACTOR (dB/m)
1	2200.00	51.7 PK	74.0	-22.3	1.00 V	3	53.50	-1.80
2	2200.00	48.8 AV	54.0	-5.2	1.00 V	3	50.60	-1.80
3	2360.00	60.9 PK	74.0	-13.1	1.13 V	359	30.00	30.90
4	2360.00	50.0 AV	54.0	-4.0	1.13 V	359	19.10	30.90
5	*2412.00	106.3 PK			1.14 V	321	75.20	31.10
6	*2412.00	102.6 AV			1.14 V	321	71.50	31.10
7	4824.00	48.9 PK	74.0	-25.1	1.16 V	1	44.00	4.90
8	4824.00	35.6 AV	54.0	-18.4	1.16 V	1	30.70	4.90

## REMARKS:

1. Emission Level(dBuV/m) = Raw Value(dBuV) + Correction Factor(dB/m)
2. Correction Factor(dB/m) = Antenna Factor(dB/m) + Cable Factor(dB)  
– Pre-Amplifier Factor(dB)
3. The other emission levels were very low against the limit.
4. Margin value = Emission Level – Limit value
5. “ \* “: Fundamental frequency.



A D T

EUT TEST CONDITION		MEASUREMENT DETAIL	
CHANNEL	Channel 6	FREQUENCY RANGE	1 ~ 25GHz
INPUT POWER	120Vac, 60Hz	DETECTOR FUNCTION	Peak (PK) Average (AV)
ENVIRONMENTAL CONDITIONS	25deg. C, 65%RH	TESTED BY	Jones Chang

**ANTENNA POLARITY & TEST DISTANCE: HORIZONTAL AT 3 M**

NO.	FREQ. (MHz)	EMISSION LEVEL (dBuV/m)	LIMIT (dBuV/m)	MARGIN (dB)	ANTENNA HEIGHT (m)	TABLE ANGLE (Degree)	RAW VALUE (dBuV)	CORRECTION FACTOR (dB/m)
1	2288.00	52.8 PK	74.0	-21.2	1.15 H	338	52.90	-0.10
2	2288.00	47.9 AV	54.0	-6.1	1.15 H	338	48.00	-0.10
3	2360.00	59.7 PK	74.0	-14.3	1.11 H	343	28.80	30.90
4	2360.00	48.1 AV	54.0	-5.9	1.11 H	343	17.20	30.90
5	*2437.00	113.9 PK			1.05 H	354	82.70	31.20
6	*2437.00	110.0 AV			1.05 H	354	78.80	31.20
7	4874.00	47.9 PK	74.0	-26.1	1.17 H	171	42.90	5.00
8	4874.00	34.8 AV	54.0	-19.2	1.17 H	171	29.80	5.00

**ANTENNA POLARITY & TEST DISTANCE: VERTICAL AT 3 M**

NO.	FREQ. (MHz)	EMISSION LEVEL (dBuV/m)	LIMIT (dBuV/m)	MARGIN (dB)	ANTENNA HEIGHT (m)	TABLE ANGLE (Degree)	RAW VALUE (dBuV)	CORRECTION FACTOR (dB/m)
1	2280.00	52.9 PK	74.0	-21.1	1.17 V	328	53.20	-0.30
2	2280.00	49.9 AV	54.0	-4.1	1.17 V	328	50.20	-0.30
3	2360.00	61.3 PK	74.0	-12.7	1.18 V	333	30.40	30.90
4	2360.00	50.8 AV	54.0	-3.2	1.18 V	333	19.90	30.90
5	*2437.00	111.8 PK			1.15 V	338	80.60	31.20
6	*2437.00	107.8 AV			1.15 V	338	76.60	31.20
7	4874.00	48.8 PK	74.0	-25.2	1.27 V	121	43.80	5.00
8	4874.00	35.3 AV	54.0	-18.7	1.27 V	121	30.30	5.00

**REMARKS:**

1. Emission Level(dBuV/m) = Raw Value(dBuV) + Correction Factor(dB/m)
2. Correction Factor(dB/m) = Antenna Factor(dB/m) + Cable Factor(dB) – Pre-Amplifier Factor(dB)
3. The other emission levels were very low against the limit.
4. Margin value = Emission Level – Limit value
5. “ \* “: Fundamental frequency.





A D T

EUT TEST CONDITION		MEASUREMENT DETAIL	
CHANNEL	Channel 11	FREQUENCY RANGE	1 ~ 25GHz
INPUT POWER	120Vac, 60Hz	DETECTOR FUNCTION	Peak (PK) Average (AV)
ENVIRONMENTAL CONDITIONS	25deg. C, 65%RH	TESTED BY	Jones Chang

**ANTENNA POLARITY & TEST DISTANCE: HORIZONTAL AT 3 M**

NO.	FREQ. (MHz)	EMISSION LEVEL (dBuV/m)	LIMIT (dBuV/m)	MARGIN (dB)	ANTENNA HEIGHT (m)	TABLE ANGLE (Degree)	RAW VALUE (dBuV)	CORRECTION FACTOR (dB/m)
1	2280.00	52.1 PK	74.0	-21.9	1.18 H	313	52.40	-0.30
2	2280.00	45.2 AV	54.0	-8.8	1.18 H	313	45.50	-0.30
3	2360.00	59.7 PK	74.0	-14.3	1.06 H	339	28.80	30.90
4	2360.00	48.7 AV	54.0	-5.3	1.06 H	339	17.80	30.90
5	*2462.00	108.6 PK			1.33 H	15	77.30	31.30
6	*2462.00	105.1 AV			1.33 H	15	73.80	31.30
7	2483.50	58.9 PK	74.0	-15.1	1.33 H	15	27.50	31.40
8	2483.50	47.7 AV	54.0	-6.3	1.33 H	15	16.30	31.40
9	4924.00	48.0 PK	74.0	-26.0	1.21 H	66	42.80	5.20
10	4924.00	35.3 AV	54.0	-18.7	1.21 H	66	30.10	5.20

**ANTENNA POLARITY & TEST DISTANCE: VERTICAL AT 3 M**

NO.	FREQ. (MHz)	EMISSION LEVEL (dBuV/m)	LIMIT (dBuV/m)	MARGIN (dB)	ANTENNA HEIGHT (m)	TABLE ANGLE (Degree)	RAW VALUE (dBuV)	CORRECTION FACTOR (dB/m)
1	2288.00	54.0 PK	74.0	-20.0	1.20 V	340	54.10	-0.10
2	2288.00	50.5 AV	54.0	-3.5	1.20 V	340	50.60	-0.10
3	2360.00	61.2 PK	74.0	-12.8	1.18 V	338	30.30	30.90
4	2360.00	50.3 AV	54.0	-3.7	1.18 V	338	19.40	30.90
5	*2462.00	108.8 PK			1.11 V	19	77.50	31.30
6	*2462.00	105.2 AV			1.11 V	19	73.90	31.30
7	2483.50	58.2 PK	74.0	-15.8	1.11 V	19	26.80	31.40
8	2483.50	47.3 AV	54.0	-6.7	1.11 V	19	15.90	31.40
9	4924.00	48.0 PK	74.0	-26.0	1.23 V	245	42.80	5.20
10	4924.00	35.1 AV	54.0	-18.9	1.23 V	245	29.90	5.20

**REMARKS:**

- Emission Level(dBuV/m) = Raw Value(dBuV) + Correction Factor(dB/m)
- Correction Factor(dB/m) = Antenna Factor(dB/m) + Cable Factor(dB)  
– Pre-Amplifier Factor(dB)
- The other emission levels were very low against the limit.
- Margin value = Emission Level – Limit value
- \* \*: Fundamental frequency.



A D T

802.11g

EUT TEST CONDITION		MEASUREMENT DETAIL	
CHANNEL	Channel 1	FREQUENCY RANGE	1 ~ 25GHz
INPUT POWER	120Vac, 60Hz	DETECTOR FUNCTION	Peak (PK) Average (AV)
ENVIRONMENTAL CONDITIONS	25deg. C, 65%RH	TESTED BY	Jones Chang

**ANTENNA POLARITY & TEST DISTANCE: HORIZONTAL AT 3 M**

NO.	FREQ. (MHz)	EMISSION LEVEL (dBuV/m)	LIMIT (dBuV/m)	MARGIN (dB)	ANTENNA HEIGHT (m)	TABLE ANGLE (Degree)	RAW VALUE (dBuV)	CORRECTION FACTOR (dB/m)
1	2288.00	56.5 PK	74.0	-17.5	1.14 H	336	56.60	-0.10
2	2288.00	47.4 AV	54.0	-6.6	1.14 H	336	47.50	-0.10
3	2360.00	64.3 PK	74.0	-9.7	1.11 H	336	33.40	30.90
4	2360.00	51.9 AV	54.0	-2.1	1.11 H	336	21.00	30.90
5	2390.00	67.5 PK	74.0	-6.5	1.10 H	2	36.50	31.00
6	2390.00	51.3 AV	54.0	-2.7	1.10 H	2	20.30	31.00
7	*2412.00	113.4 PK			1.10 H	351	82.30	31.10
8	*2412.00	103.9 AV			1.10 H	351	72.80	31.10
9	4824.00	47.4 PK	74.0	-26.6	1.21 H	247	42.50	4.90
10	4824.00	34.5 AV	54.0	-19.5	1.21 H	247	29.60	4.90

**ANTENNA POLARITY & TEST DISTANCE: VERTICAL AT 3 M**

NO.	FREQ. (MHz)	EMISSION LEVEL (dBuV/m)	LIMIT (dBuV/m)	MARGIN (dB)	ANTENNA HEIGHT (m)	TABLE ANGLE (Degree)	RAW VALUE (dBuV)	CORRECTION FACTOR (dB/m)
1	2280.00	56.0 PK	74.0	-18.0	1.22 V	323	56.30	-0.30
2	2280.00	52.5 AV	54.0	-1.5	1.22 V	323	52.80	-0.30
3	2360.00	60.9 PK	74.0	-13.1	1.19 V	330	30.00	30.90
4	2360.00	51.6 AV	54.0	-2.4	1.19 V	330	20.70	30.90
5	*2412.00	112.0 PK			1.16 V	357	80.90	31.10
6	*2412.00	101.8 AV			1.16 V	357	70.70	31.10
7	4824.00	47.1 PK	74.0	-26.9	1.16 V	144	42.20	4.90
8	4824.00	34.5 AV	54.0	-19.5	1.16 V	144	29.60	4.90

**REMARKS:**

1. Emission Level(dBuV/m) = Raw Value(dBuV) + Correction Factor(dB/m)
2. Correction Factor(dB/m) = Antenna Factor(dB/m) + Cable Factor(dB) – Pre-Amplifier Factor(dB)
3. The other emission levels were very low against the limit.
4. Margin value = Emission Level – Limit value
5. “ \* “: Fundamental frequency.



A D T

EUT TEST CONDITION		MEASUREMENT DETAIL	
CHANNEL	Channel 6	FREQUENCY RANGE	1 ~ 25GHz
INPUT POWER	120Vac, 60Hz	DETECTOR FUNCTION	Peak (PK) Average (AV)
ENVIRONMENTAL CONDITIONS	25deg. C, 65%RH	TESTED BY	Jones Chang

**ANTENNA POLARITY & TEST DISTANCE: HORIZONTAL AT 3 M**

NO.	FREQ. (MHz)	EMISSION LEVEL (dBuV/m)	LIMIT (dBuV/m)	MARGIN (dB)	ANTENNA HEIGHT (m)	TABLE ANGLE (Degree)	RAW VALUE (dBuV)	CORRECTION FACTOR (dB/m)
1	2280.00	56.2 PK	74.0	-17.8	1.11 H	353	56.50	-0.30
2	2280.00	46.4 AV	54.0	-7.6	1.11 H	353	46.70	-0.30
3	2360.00	64.8 PK	74.0	-9.2	1.10 H	337	33.90	30.90
4	2360.00	51.0 AV	54.0	-3.0	1.10 H	337	20.10	30.90
5	*2437.00	113.8 PK			1.07 H	346	82.60	31.20
6	*2437.00	104.0 AV			1.07 H	346	72.80	31.20
7	4874.00	47.7 PK	74.0	-26.3	1.15 H	202	42.70	5.00
8	4874.00	33.9 AV	54.0	-20.1	1.15 H	202	28.90	5.00

**ANTENNA POLARITY & TEST DISTANCE: VERTICAL AT 3 M**

NO.	FREQ. (MHz)	EMISSION LEVEL (dBuV/m)	LIMIT (dBuV/m)	MARGIN (dB)	ANTENNA HEIGHT (m)	TABLE ANGLE (Degree)	RAW VALUE (dBuV)	CORRECTION FACTOR (dB/m)
1	2280.00	57.1 PK	74.0	-16.9	1.22 V	343	57.40	-0.30
2	2280.00	52.8 AV	54.0	-1.2	1.22 V	343	53.10	-0.30
3	2360.00	61.8 PK	74.0	-12.2	1.18 V	327	30.90	30.90
4	2360.00	51.7 AV	54.0	-2.3	1.18 V	327	20.80	30.90
5	*2437.00	112.8 PK			1.14 V	338	81.60	31.20
6	*2437.00	102.5 AV			1.14 V	338	71.30	31.20
7	4874.00	48.1 PK	74.0	-25.9	1.26 V	292	43.10	5.00
8	4874.00	34.9 AV	54.0	-19.1	1.26 V	292	29.90	5.00

**REMARKS:**

- Emission Level(dBuV/m) = Raw Value(dBuV) + Correction Factor(dB/m)
- Correction Factor(dB/m) = Antenna Factor(dB/m) + Cable Factor(dB) – Pre-Amplifier Factor(dB)
- The other emission levels were very low against the limit.
- Margin value = Emission Level – Limit value
- \* \* \*: Fundamental frequency.



A D T

EUT TEST CONDITION		MEASUREMENT DETAIL	
CHANNEL	Channel 11	FREQUENCY RANGE	1 ~ 25GHz
INPUT POWER	120Vac, 60Hz	DETECTOR FUNCTION	Peak (PK) Average (AV)
ENVIRONMENTAL CONDITIONS	25deg. C, 65%RH	TESTED BY	Jones Chang

ANTENNA POLARITY & TEST DISTANCE: HORIZONTAL AT 3 M								
NO.	FREQ. (MHz)	EMISSION LEVEL (dBuV/m)	LIMIT (dBuV/m)	MARGIN (dB)	ANTENNA HEIGHT (m)	TABLE ANGLE (Degree)	RAW VALUE (dBuV)	CORRECTION FACTOR (dB/m)
1	2280.00	53.4 PK	74.0	-20.6	1.21 H	346	53.70	-0.30
2	2280.00	47.3 AV	54.0	-6.7	1.21 H	346	47.60	-0.30
3	2360.00	59.6 PK	74.0	-14.4	1.10 H	350	28.70	30.90
4	2360.00	49.9 AV	54.0	-4.1	1.10 H	350	19.00	30.90
5	*2462.00	113.8 PK			1.09 H	344	82.50	31.30
6	*2462.00	103.4 AV			1.09 H	344	72.10	31.30
7	2483.50	60.7 PK	74.0	-13.3	1.13 H	335	29.30	31.40
8	2483.50	49.4 AV	54.0	-4.6	1.13 H	335	18.00	31.40
9	4924.00	47.4 PK	74.0	-26.6	1.10 H	21	42.20	5.20
10	4924.00	33.7 AV	54.0	-20.3	1.10 H	21	28.50	5.20

ANTENNA POLARITY & TEST DISTANCE: VERTICAL AT 3 M								
NO.	FREQ. (MHz)	EMISSION LEVEL (dBuV/m)	LIMIT (dBuV/m)	MARGIN (dB)	ANTENNA HEIGHT (m)	TABLE ANGLE (Degree)	RAW VALUE (dBuV)	CORRECTION FACTOR (dB/m)
1	2280.00	57.4 PK	74.0	-16.6	1.24 V	241	57.70	-0.30
2	2280.00	52.7 AV	54.0	-1.3	1.24 V	241	53.00	-0.30
3	2360.00	60.6 PK	74.0	-13.4	1.17 V	334	29.70	30.90
4	2360.00	51.7 AV	54.0	-2.3	1.17 V	334	20.80	30.90
5	*2462.00	112.5 PK			1.14 V	337	81.20	31.30
6	*2462.00	101.7 AV			1.14 V	337	70.40	31.30
7	2483.50	62.0 PK	74.0	-12.0	1.12 V	344	30.60	31.40
8	2483.50	48.7 AV	54.0	-5.3	1.12 V	344	17.30	31.40
9	4924.00	48.1 PK	74.0	-25.9	1.30 V	292	42.90	5.20
10	4924.00	34.3 AV	54.0	-19.7	1.30 V	292	29.10	5.20

**REMARKS:**

1. Emission Level(dBuV/m) = Raw Value(dBuV) + Correction Factor(dB/m)
2. Correction Factor(dB/m) = Antenna Factor(dB/m) + Cable Factor(dB)  
– Pre-Amplifier Factor(dB)
3. The other emission levels were very low against the limit.
4. Margin value = Emission Level – Limit value
5. “ \* “: Fundamental frequency.



A D T

802.11n (20MHz)

EUT TEST CONDITION		MEASUREMENT DETAIL	
CHANNEL	Channel 1	FREQUENCY RANGE	1 ~ 25GHz
INPUT POWER	120Vac, 60Hz	DETECTOR FUNCTION	Peak (PK) Average (AV)
ENVIRONMENTAL CONDITIONS	25deg. C, 65%RH	TESTED BY	Jones Chang

**ANTENNA POLARITY & TEST DISTANCE: HORIZONTAL AT 3 M**

NO.	FREQ. (MHz)	EMISSION LEVEL (dBuV/m)	LIMIT (dBuV/m)	MARGIN (dB)	ANTENNA HEIGHT (m)	TABLE ANGLE (Degree)	RAW VALUE (dBuV)	CORRECTION FACTOR (dB/m)
1	2288.00	55.6 PK	74.0	-18.4	1.14 H	345	55.70	-0.10
2	2288.00	47.0 AV	54.0	-7.0	1.14 H	345	47.10	-0.10
3	2360.00	63.4 PK	74.0	-10.6	1.12 H	353	32.50	30.90
4	2360.00	50.4 AV	54.0	-3.6	1.12 H	353	19.50	30.90
5	2390.00	64.5 PK	74.0	-9.5	1.09 H	350	33.50	31.00
6	2390.00	51.3 AV	54.0	-2.7	1.09 H	350	20.30	31.00
7	*2412.00	113.5 PK			1.09 H	343	82.40	31.10
8	*2412.00	103.2 AV			1.09 H	343	72.10	31.10
9	4824.00	47.3 PK	74.0	-26.7	1.18 H	333	42.40	4.90
10	4824.00	33.5 AV	54.0	-20.5	1.18 H	333	28.60	4.90

**ANTENNA POLARITY & TEST DISTANCE: VERTICAL AT 3 M**

NO.	FREQ. (MHz)	EMISSION LEVEL (dBuV/m)	LIMIT (dBuV/m)	MARGIN (dB)	ANTENNA HEIGHT (m)	TABLE ANGLE (Degree)	RAW VALUE (dBuV)	CORRECTION FACTOR (dB/m)
1	2280.00	56.6 PK	74.0	-17.4	1.25 V	323	56.90	-0.30
2	2280.00	52.2 AV	54.0	-1.8	1.25 V	323	52.50	-0.30
3	2360.00	60.4 PK	74.0	-13.6	1.18 V	335	29.50	30.90
4	2360.00	51.9 AV	54.0	-2.1	1.18 V	335	21.00	30.90
5	2390.00	62.8 PK	74.0	-11.2	1.18 V	335	31.80	31.00
6	2390.00	50.0 AV	54.0	-4.0	1.18 V	335	19.00	31.00
7	*2412.00	111.3 PK			1.19 V	334	80.20	31.10
8	*2412.00	100.9 AV			1.19 V	334	69.80	31.10
9	4824.00	47.5 PK	74.0	-26.5	1.22 V	14	42.60	4.90
10	4824.00	33.9 AV	54.0	-20.1	1.22 V	14	29.00	4.90

**REMARKS:**

1. Emission Level(dBuV/m) = Raw Value(dBuV) + Correction Factor(dB/m)
2. Correction Factor(dB/m) = Antenna Factor(dB/m) + Cable Factor(dB)  
– Pre-Amplifier Factor(dB)
3. The other emission levels were very low against the limit.
4. Margin value = Emission Level – Limit value
5. “ \* “: Fundamental frequency.



A D T

EUT TEST CONDITION		MEASUREMENT DETAIL	
CHANNEL	Channel 6	FREQUENCY RANGE	1 ~ 25GHz
INPUT POWER	120Vac, 60Hz	DETECTOR FUNCTION	Peak (PK) Average (AV)
ENVIRONMENTAL CONDITIONS	25deg. C, 65%RH	TESTED BY	Jones Chang

ANTENNA POLARITY & TEST DISTANCE: HORIZONTAL AT 3 M								
NO.	FREQ. (MHz)	EMISSION LEVEL (dBuV/m)	LIMIT (dBuV/m)	MARGIN (dB)	ANTENNA HEIGHT (m)	TABLE ANGLE (Degree)	RAW VALUE (dBuV)	CORRECTION FACTOR (dB/m)
1	2280.00	52.9 PK	74.0	-21.1	1.10 H	9	53.20	-0.30
2	2280.00	46.3 AV	54.0	-7.7	1.10 H	9	46.60	-0.30
3	2360.00	63.3 PK	74.0	-10.7	1.09 H	355	32.40	30.90
4	2360.00	49.6 AV	54.0	-4.4	1.09 H	355	18.70	30.90
5	*2437.00	114.3 PK			1.07 H	349	83.10	31.20
6	*2437.00	103.8 AV			1.07 H	349	72.60	31.20
7	4874.00	47.6 PK	74.0	-26.4	1.15 H	233	42.60	5.00
8	4874.00	34.0 AV	54.0	-20.0	1.15 H	233	29.00	5.00
ANTENNA POLARITY & TEST DISTANCE: VERTICAL AT 3 M								
NO.	FREQ. (MHz)	EMISSION LEVEL (dBuV/m)	LIMIT (dBuV/m)	MARGIN (dB)	ANTENNA HEIGHT (m)	TABLE ANGLE (Degree)	RAW VALUE (dBuV)	CORRECTION FACTOR (dB/m)
1	2280.00	56.7 PK	74.0	-17.3	1.24 V	333	57.00	-0.30
2	2280.00	52.6 AV	54.0	-1.4	1.24 V	333	52.90	-0.30
3	2360.00	59.6 PK	74.0	-14.4	1.16 V	337	28.70	30.90
4	2360.00	51.6 AV	54.0	-2.4	1.16 V	337	20.70	30.90
5	*2437.00	112.0 PK			1.16 V	334	80.80	31.20
6	*2437.00	101.6 AV			1.16 V	334	70.40	31.20
7	4874.00	48.0 PK	74.0	-26.0	1.33 V	121	43.00	5.00
8	4874.00	34.5 AV	54.0	-19.5	1.33 V	121	29.50	5.00

**REMARKS:**

1. Emission Level(dBuV/m) = Raw Value(dBuV) + Correction Factor(dB/m)
2. Correction Factor(dB/m) = Antenna Factor(dB/m) + Cable Factor(dB)  
– Pre-Amplifier Factor(dB)
3. The other emission levels were very low against the limit.
4. Margin value = Emission Level – Limit value
5. “ \* “: Fundamental frequency.



A D T

EUT TEST CONDITION		MEASUREMENT DETAIL	
CHANNEL	Channel 11	FREQUENCY RANGE	1 ~ 25GHz
INPUT POWER	120Vac, 60Hz	DETECTOR FUNCTION	Peak (PK) Average (AV)
ENVIRONMENTAL CONDITIONS	25deg. C, 65%RH	TESTED BY	Jones Chang

ANTENNA POLARITY & TEST DISTANCE: HORIZONTAL AT 3 M								
NO.	FREQ. (MHz)	EMISSION LEVEL (dBuV/m)	LIMIT (dBuV/m)	MARGIN (dB)	ANTENNA HEIGHT (m)	TABLE ANGLE (Degree)	RAW VALUE (dBuV)	CORRECTION FACTOR (dB/m)
1	2280.00	54.7 PK	74.0	-19.3	1.11 H	358	55.00	-0.30
2	2280.00	47.5 AV	54.0	-6.5	1.11 H	358	47.80	-0.30
3	2360.00	60.8 PK	74.0	-13.2	1.15 H	0	29.90	30.90
4	2360.00	48.9 AV	54.0	-5.1	1.15 H	0	18.00	30.90
5	*2462.00	112.7 PK			1.05 H	348	81.40	31.30
6	*2462.00	103.4 AV			1.05 H	348	72.10	31.30
7	2483.50	63.5 PK	74.0	-10.5	1.05 H	348	32.10	31.40
8	2483.50	49.7 AV	54.0	-4.3	1.05 H	348	18.30	31.40
9	4924.00	47.4 PK	74.0	-26.6	1.14 H	328	42.20	5.20
10	4924.00	34.0 AV	54.0	-20.0	1.14 H	328	28.80	5.20
ANTENNA POLARITY & TEST DISTANCE: VERTICAL AT 3 M								
NO.	FREQ. (MHz)	EMISSION LEVEL (dBuV/m)	LIMIT (dBuV/m)	MARGIN (dB)	ANTENNA HEIGHT (m)	TABLE ANGLE (Degree)	RAW VALUE (dBuV)	CORRECTION FACTOR (dB/m)
1	2280.00	56.9 PK	74.0	-17.1	1.23 V	344	57.20	-0.30
2	2280.00	52.9 AV	54.0	-1.1	1.23 V	344	53.20	-0.30
3	2360.00	60.6 PK	74.0	-13.4	1.16 V	328	29.70	31.30
4	2360.00	51.4 AV	54.0	-2.6	1.16 V	328	20.50	31.30
5	*2462.00	111.7 PK			1.14 V	329	80.40	31.30
6	*2462.00	101.5 AV			1.14 V	329	70.20	31.30
7	2483.50	61.6 PK	74.0	-12.4	1.17 V	341	30.20	31.40
8	2483.50	49.6 AV	54.0	-4.4	1.17 V	341	18.20	31.40
9	4924.00	47.7 PK	74.0	-26.3	1.24 V	229	42.50	5.20
10	4924.00	34.2 AV	54.0	-19.8	1.24 V	229	29.00	5.20

**REMARKS:**

- Emission Level(dBuV/m) = Raw Value(dBuV) + Correction Factor(dB/m)
- Correction Factor(dB/m) = Antenna Factor(dB/m) + Cable Factor(dB)  
– Pre-Amplifier Factor(dB)
- The other emission levels were very low against the limit.
- Margin value = Emission Level – Limit value
- \* \*: Fundamental frequency.



A D T

802.11n (40MHz)

EUT TEST CONDITION		MEASUREMENT DETAIL	
CHANNEL	Channel 3	FREQUENCY RANGE	1 ~ 25GHz
INPUT POWER	120Vac, 60Hz	DETECTOR FUNCTION	Peak (PK) Average (AV)
ENVIRONMENTAL CONDITIONS	25deg. C, 65%RH	TESTED BY	Jones Chang

**ANTENNA POLARITY & TEST DISTANCE: HORIZONTAL AT 3 M**

NO.	FREQ. (MHz)	EMISSION LEVEL (dBuV/m)	LIMIT (dBuV/m)	MARGIN (dB)	ANTENNA HEIGHT (m)	TABLE ANGLE (Degree)	RAW VALUE (dBuV)	CORRECTION FACTOR (dB/m)
1	2280.00	48.1 PK	74.0	-25.9	1.05 H	3	48.40	-0.30
2	2280.00	40.2 AV	54.0	-13.8	1.05 H	3	40.50	-0.30
3	2360.00	61.2 PK	74.0	-12.8	1.09 H	337	30.30	30.90
4	2360.00	48.5 AV	54.0	-5.5	1.09 H	337	17.60	30.90
5	2390.00	72.6 PK	74.0	-1.4	1.08 H	10	41.60	31.00
6	<b>2390.00</b>	<b>53.3 AV</b>	<b>54.0</b>	<b>-0.7</b>	<b>1.08 H</b>	<b>10</b>	<b>22.30</b>	<b>31.00</b>
7	*2422.00	109.5 PK			1.08 H	346	78.30	31.20
8	*2422.00	99.3 AV			1.08 H	346	68.10	31.20
9	4844.00	47.2 PK	74.0	-26.8	1.22 H	156	42.20	5.00
10	4844.00	33.3 AV	54.0	-20.7	1.22 H	156	28.30	5.00

**ANTENNA POLARITY & TEST DISTANCE: VERTICAL AT 3 M**

NO.	FREQ. (MHz)	EMISSION LEVEL (dBuV/m)	LIMIT (dBuV/m)	MARGIN (dB)	ANTENNA HEIGHT (m)	TABLE ANGLE (Degree)	RAW VALUE (dBuV)	CORRECTION FACTOR (dB/m)
1	2280.00	52.9 PK	74.0	-21.1	1.00 V	353	53.20	-0.30
2	2280.00	48.7 AV	54.0	-5.3	1.00 V	353	49.00	-0.30
3	2360.00	58.9 PK	74.0	-15.1	1.18 V	329	28.00	30.90
4	2360.00	49.5 AV	54.0	-4.5	1.18 V	329	18.60	30.90
5	2390.00	70.4 PK	74.0	-3.6	1.16 V	357	39.40	31.00
6	2390.00	53.0 AV	54.0	-1.0	1.16 V	357	22.00	31.00
7	*2422.00	106.7 PK			1.15 V	337	75.50	31.20
8	*2422.00	97.1 AV			1.15 V	337	65.90	31.20
9	4844.00	47.5 PK	74.0	-26.5	1.12 V	7	42.50	5.00
10	4844.00	33.6 AV	54.0	-20.4	1.12 V	7	28.60	5.00

**REMARKS:**

1. Emission Level(dBuV/m) = Raw Value(dBuV) + Correction Factor(dB/m)
2. Correction Factor(dB/m) = Antenna Factor(dB/m) + Cable Factor(dB) – Pre-Amplifier Factor(dB)
3. The other emission levels were very low against the limit.
4. Margin value = Emission Level – Limit value
5. “ \* “: Fundamental frequency.





A D T

EUT TEST CONDITION		MEASUREMENT DETAIL	
CHANNEL	Channel 6	FREQUENCY RANGE	1 ~ 25GHz
INPUT POWER	120Vac, 60Hz	DETECTOR FUNCTION	Peak (PK) Average (AV)
ENVIRONMENTAL CONDITIONS	25deg. C, 65%RH	TESTED BY	Jones Chang

**ANTENNA POLARITY & TEST DISTANCE: HORIZONTAL AT 3 M**

NO.	FREQ. (MHz)	EMISSION LEVEL (dBuV/m)	LIMIT (dBuV/m)	MARGIN (dB)	ANTENNA HEIGHT (m)	TABLE ANGLE (Degree)	RAW VALUE (dBuV)	CORRECTION FACTOR (dB/m)
1	2280.00	50.3 PK	74.0	-23.7	1.13 H	336	50.60	-0.30
2	2280.00	48.2 AV	54.0	-5.8	1.13 H	336	48.50	-0.30
3	2360.00	60.7 PK	74.0	-13.3	1.15 H	340	29.80	30.90
4	2360.00	49.4 AV	54.0	-4.6	1.15 H	340	18.50	30.90
5	*2437.00	111.2 PK			1.07 H	2	80.00	31.20
6	*2437.00	100.8 AV			1.07 H	2	69.60	31.20
7	4874.00	47.0 PK	74.0	-27.0	1.24 H	51	42.00	5.00
8	4874.00	33.4 AV	54.0	-20.6	1.24 H	51	28.40	5.00

**ANTENNA POLARITY & TEST DISTANCE: VERTICAL AT 3 M**

NO.	FREQ. (MHz)	EMISSION LEVEL (dBuV/m)	LIMIT (dBuV/m)	MARGIN (dB)	ANTENNA HEIGHT (m)	TABLE ANGLE (Degree)	RAW VALUE (dBuV)	CORRECTION FACTOR (dB/m)
1	2280.00	55.9 PK	74.0	-18.1	1.24 V	326	56.20	-0.30
2	2280.00	51.8 AV	54.0	-2.2	1.24 V	326	52.10	-0.30
3	2360.00	60.7 PK	74.0	-13.3	1.18 V	343	29.80	30.90
4	2360.00	52.9 AV	54.0	-1.1	1.18 V	343	22.00	30.90
5	*2437.00	109.5 PK			1.13 V	332	78.30	31.20
6	*2437.00	98.6 AV			1.13 V	332	67.40	31.20
7	4874.00	47.9 PK	74.0	-26.1	1.13 V	131	42.90	5.00
8	4874.00	33.7 AV	54.0	-20.3	1.13 V	131	28.70	5.00

**REMARKS:**

- Emission Level(dBuV/m) = Raw Value(dBuV) + Correction Factor(dB/m)
- Correction Factor(dB/m) = Antenna Factor(dB/m) + Cable Factor(dB) – Pre-Amplifier Factor(dB)
- The other emission levels were very low against the limit.
- Margin value = Emission Level – Limit value
- \* \* \*: Fundamental frequency.



A D T

EUT TEST CONDITION		MEASUREMENT DETAIL	
CHANNEL	Channel 9	FREQUENCY RANGE	1 ~ 25GHz
INPUT POWER	120Vac, 60Hz	DETECTOR FUNCTION	Peak (PK) Average (AV)
ENVIRONMENTAL CONDITIONS	25deg. C, 65%RH	TESTED BY	Jones Chang

**ANTENNA POLARITY & TEST DISTANCE: HORIZONTAL AT 3 M**

NO.	FREQ. (MHz)	EMISSION LEVEL (dBuV/m)	LIMIT (dBuV/m)	MARGIN (dB)	ANTENNA HEIGHT (m)	TABLE ANGLE (Degree)	RAW VALUE (dBuV)	CORRECTION FACTOR (dB/m)
1	2280.00	48.7 PK	74.0	-25.3	1.06 H	320	49.00	-0.30
2	2280.00	42.9 AV	54.0	-11.1	1.06 H	320	43.20	-0.30
3	2360.00	58.2 PK	74.0	-15.8	1.09 H	355	27.30	30.90
4	2360.00	47.4 AV	54.0	-6.6	1.09 H	355	16.50	30.90
5	*2452.00	107.6 PK			1.05 H	347	76.30	31.30
6	*2452.00	97.6 AV			1.05 H	347	66.30	31.30
7	<b>2483.50</b>	<b>73.3 PK</b>	<b>74.0</b>	<b>-0.7</b>	<b>1.08 H</b>	<b>350</b>	<b>41.90</b>	<b>31.40</b>
8	2483.50	53.0 AV	54.0	-1.0	1.08 H	350	21.60	31.40
9	4904.00	47.1 PK	74.0	-26.9	1.11 H	190	42.00	5.10
10	4904.00	33.1 AV	54.0	-20.9	1.11 H	190	28.00	5.10

**ANTENNA POLARITY & TEST DISTANCE: VERTICAL AT 3 M**

NO.	FREQ. (MHz)	EMISSION LEVEL (dBuV/m)	LIMIT (dBuV/m)	MARGIN (dB)	ANTENNA HEIGHT (m)	TABLE ANGLE (Degree)	RAW VALUE (dBuV)	CORRECTION FACTOR (dB/m)
1	2280.00	54.9 PK	74.0	-19.1	1.24 V	326	55.20	-0.30
2	2280.00	50.8 AV	54.0	-3.2	1.24 V	326	51.10	-0.30
3	2360.00	60.0 PK	74.0	-14.0	1.18 V	331	29.10	30.90
4	2360.00	51.4 AV	54.0	-2.6	1.18 V	331	20.50	30.90
5	*2452.00	104.6 PK			1.14 V	335	73.30	31.30
6	*2452.00	94.6 AV			1.14 V	335	63.30	31.30
7	2483.50	68.6 PK	74.0	-5.4	1.12 V	331	37.20	31.40
8	2483.50	50.1 AV	54.0	-3.9	1.12 V	331	18.70	31.40
9	4904.00	47.5 PK	74.0	-26.5	1.21 V	289	42.40	5.10
10	4904.00	33.5 AV	54.0	-20.5	1.21 V	289	28.40	5.10

**REMARKS:**

- Emission Level(dBuV/m) = Raw Value(dBuV) + Correction Factor(dB/m)
- Correction Factor(dB/m) = Antenna Factor(dB/m) + Cable Factor(dB)  
– Pre-Amplifier Factor(dB)
- The other emission levels were very low against the limit.
- Margin value = Emission Level – Limit value
- \* \*: Fundamental frequency.



A D T

## BELOW 1GHz WORST-CASE DATA : 802.11b

EUT TEST CONDITION		MEASUREMENT DETAIL	
CHANNEL	Channel 1	FREQUENCY RANGE	Below 1000MHz
INPUT POWER	120Vac, 60Hz	DETECTOR FUNCTION	Quasi-Peak
ENVIRONMENTAL CONDITIONS	21deg. C, 65%RH	TESTED BY	Jones Chang
TEST MODE	A		

ANTENNA POLARITY & TEST DISTANCE: HORIZONTAL AT 3 M								
NO.	FREQ. (MHz)	EMISSION LEVEL (dBuV/m)	LIMIT (dBuV/m)	MARGIN (dB)	ANTENNA HEIGHT (m)	TABLE ANGLE (Degree)	RAW VALUE (dBuV)	CORRECTION FACTOR (dB/m)
1	57.12	32.5 QP	40.0	-7.5	1.99 H	16	47.10	-14.60
2	180.55	41.2 QP	43.5	-2.3	1.52 H	94	56.40	-15.20
3	195.16	39.9 QP	43.5	-3.6	1.49 H	95	56.40	-16.50
4	374.04	36.5 QP	46.0	-9.5	1.00 H	218	47.20	-10.70
5	624.85	32.5 QP	46.0	-13.5	1.49 H	141	38.00	-5.50
6	751.23	36.5 QP	46.0	-9.5	1.00 H	155	39.50	-3.00
7	875.67	35.0 QP	46.0	-11.0	1.49 H	205	36.10	-1.10
ANTENNA POLARITY & TEST DISTANCE: VERTICAL AT 3 M								
NO.	FREQ. (MHz)	EMISSION LEVEL (dBuV/m)	LIMIT (dBuV/m)	MARGIN (dB)	ANTENNA HEIGHT (m)	TABLE ANGLE (Degree)	RAW VALUE (dBuV)	CORRECTION FACTOR (dB/m)
1	53.23	33.2 QP	40.0	-6.8	1.00 V	307	47.60	-14.40
2	125.17	33.9 QP	43.5	-9.6	1.00 V	344	49.70	-15.80
3	179.61	39.0 QP	43.5	-4.5	1.00 V	47	54.00	-15.00
4	374.04	36.1 QP	46.0	-9.9	1.49 V	219	46.80	-10.70
5	500.42	29.5 QP	46.0	-16.5	1.00 V	178	37.80	-8.30
6	624.85	31.0 QP	46.0	-15.0	1.49 V	191	36.50	-5.50
7	875.67	34.0 QP	46.0	-12.0	1.00 V	187	35.10	-1.10

## REMARKS:

1. Emission Level(dBuV/m) = Raw Value(dBuV) + Correction Factor(dB/m)
2. Correction Factor(dB/m) = Antenna Factor(dB/m) + Cable Factor(dB)  
– Pre-Amplifier Factor (dB)
3. The other emission levels were very low against the limit.
4. Margin value = Emission Level – Limit value



A D T

EUT TEST CONDITION		MEASUREMENT DETAIL	
CHANNEL	Channel 1	FREQUENCY RANGE	Below 1000MHz
INPUT POWER	120Vac, 60Hz	DETECTOR FUNCTION	Quasi-Peak
ENVIRONMENTAL CONDITIONS	21deg. C, 65%RH	TESTED BY	Jones Chang
TEST MODE	B		

ANTENNA POLARITY & TEST DISTANCE: HORIZONTAL AT 3 M								
NO.	FREQ. (MHz)	EMISSION LEVEL (dBuV/m)	LIMIT (dBuV/m)	MARGIN (dB)	ANTENNA HEIGHT (m)	TABLE ANGLE (Degree)	RAW VALUE (dBuV)	CORRECTION FACTOR (dB/m)
1	57.12	32.1 QP	40.0	-7.9	2.00 H	119	46.70	-14.60
2	125.17	37.6 QP	43.5	-5.9	1.50 H	218	53.40	-15.80
3	249.60	32.2 QP	46.0	-13.8	1.00 H	66	46.40	-14.20
4	374.04	36.2 QP	46.0	-9.8	1.00 H	108	46.90	-10.70
5	624.85	34.1 QP	46.0	-11.9	1.50 H	196	39.60	-5.50
6	751.23	34.0 QP	46.0	-12.0	1.00 H	117	37.00	-3.00
7	875.67	35.7 QP	46.0	-10.3	1.50 H	128	36.80	-1.10
ANTENNA POLARITY & TEST DISTANCE: VERTICAL AT 3 M								
NO.	FREQ. (MHz)	EMISSION LEVEL (dBuV/m)	LIMIT (dBuV/m)	MARGIN (dB)	ANTENNA HEIGHT (m)	TABLE ANGLE (Degree)	RAW VALUE (dBuV)	CORRECTION FACTOR (dB/m)
1	49.34	36.2 QP	40.0	-3.8	1.00 V	27	50.70	-14.50
2	125.17	36.1 QP	43.5	-7.4	1.00 V	343	51.90	-15.80
3	374.04	32.0 QP	46.0	-14.0	1.00 V	212	42.70	-10.70
4	461.53	38.2 QP	46.0	-7.8	1.00 V	159	47.10	-8.90
5	624.85	30.5 QP	46.0	-15.5	1.49 V	175	36.00	-5.50
6	875.67	33.9 QP	46.0	-12.1	1.00 V	145	35.00	-1.10

**REMARKS:**

1. Emission Level(dBuV/m) = Raw Value(dBuV) + Correction Factor(dB/m)
2. Correction Factor(dB/m) = Antenna Factor(dB/m) + Cable Factor(dB)  
– Pre-Amplifier Factor (dB)
3. The other emission levels were very low against the limit.
4. Margin value = Emission Level – Limit value

## 4.2 CONDUCTED EMISSION MEASUREMENT

### 4.2.1 LIMITS OF CONDUCTED EMISSION MEASUREMENT

FREQUENCY OF EMISSION (MHz)	CONDUCTED LIMIT (dB $\mu$ V)	
	Quasi-peak	Average
0.15 ~ 0.5	66 to 56	56 to 46
0.5 ~ 5	56	46
5 ~ 30	60	50

- NOTE:** 1. The lower limit shall apply at the transition frequencies.
2. The limit decreases in line with the logarithm of the frequency in the range of 0.15 to 0.50MHz.
3. All emanations from a class A/B digital device or system, including any network of conductors and apparatus connected thereto, shall not exceed the level of field strengths specified above.

### 4.2.2 TEST INSTRUMENTS

DESCRIPTION & MANUFACTURER	MODEL NO.	SERIAL NO.	DATE OF CALIBRATION	DUE DATE OF CALIBRATION
Test Receiver ROHDE & SCHWARZ	ESCS30	100289	Nov. 29, 2013	Nov. 28, 2014
RF signal cable Woken	5D-FB	Cable-HYC01-01	Dec. 27, 2013	Dec. 26, 2014
LISN ROHDE & SCHWARZ (EUT)	ESH3-Z5	835239/001	Feb. 13, 2014	Feb. 12, 2015
LISN ROHDE & SCHWARZ (Peripheral)	ESH3-Z5	100311	Jul. 21, 2013	Jul. 20, 2014
		100311	Jul. 21, 2014	Jul. 20, 2015
Software ADT	BV ADT_Cond_ V7.3.7.3	NA	NA	NA

- NOTE:** 1. The calibration interval of the above test instruments is 12 months and the calibrations are traceable to NML/ROC and NIST/USA.
2. The test was performed in HwaYa Shielded Room 1.
3. The VCCI Site Registration No. is C-2040.

#### 4.2.3 TEST PROCEDURES

- a. The EUT was placed 0.4 meters from the conducting wall of the shielded room with EUT being connected to the power mains through a line impedance stabilization network (LISN). Other support units were connected to the power mains through another LISN. The two LISNs provide 50 ohm/ 50uH of coupling impedance for the measuring instrument.
- b. Both lines of the power mains connected to the EUT were checked for maximum conducted interference.
- c. The frequency range from 150kHz to 30MHz was searched. Emission levels under (Limit - 20dB) was not recorded.

**NOTE:** All modes of operation were investigated and the worst-case emissions are reported.

#### 4.2.4 DEVIATION FROM TEST STANDARD

No deviation.

#### 4.2.5 TEST SETUP

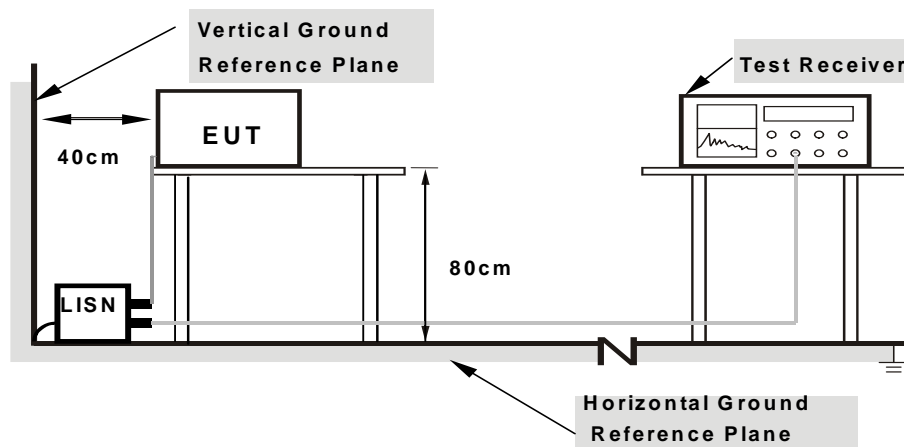

- Note:**
1. Support units were connected to second LISN.
  2. Both of LISNs (AMN) are 80 cm from EUT and at least 80 cm from other units and other metal planes

For the actual test configuration, please refer to the attached file (Test Setup Photo).

#### 4.2.6 EUT OPERATING CONDITIONS

Same as 4.1.6.

### 4.2.7 TEST RESULTS

#### CONDUCTED WORST-CASE DATA : 802.11b

PHASE	Line 1	6dB BANDWIDTH	9kHz
TEST MODE	A		

No	Freq. [MHz]	Corr. Factor (dB)	Reading Value		Emission Level		Limit		Margin	
			[dB (uV)]		[dB (uV)]		[dB (uV)]		(dB)	
			Q.P.	AV.	Q.P.	AV.	Q.P.	AV.	Q.P.	AV.
1	0.16173	0.08	41.26	27.28	41.34	27.36	65.37	55.37	-24.04	-28.02
2	0.58010	0.09	31.93	18.25	32.02	18.34	56.00	46.00	-23.98	-27.66
3	0.69349	0.09	33.46	17.20	33.55	17.29	56.00	46.00	-22.45	-28.71
4	4.59176	0.26	40.50	29.29	40.76	29.55	56.00	46.00	-15.24	-16.45
5	7.43824	0.39	41.88	34.51	42.27	34.90	60.00	50.00	-17.73	-15.10
6	20.66577	1.06	29.43	18.44	30.49	19.50	60.00	50.00	-29.51	-30.50

#### REMARKS:

1. Q.P. and AV. are abbreviations of quasi-peak and average individually.
2. The emission levels of other frequencies were very low against the limit.
3. Margin value = Emission level - Limit value
4. Correction factor = Insertion loss + Cable loss
5. Emission Level = Correction Factor + Reading Value

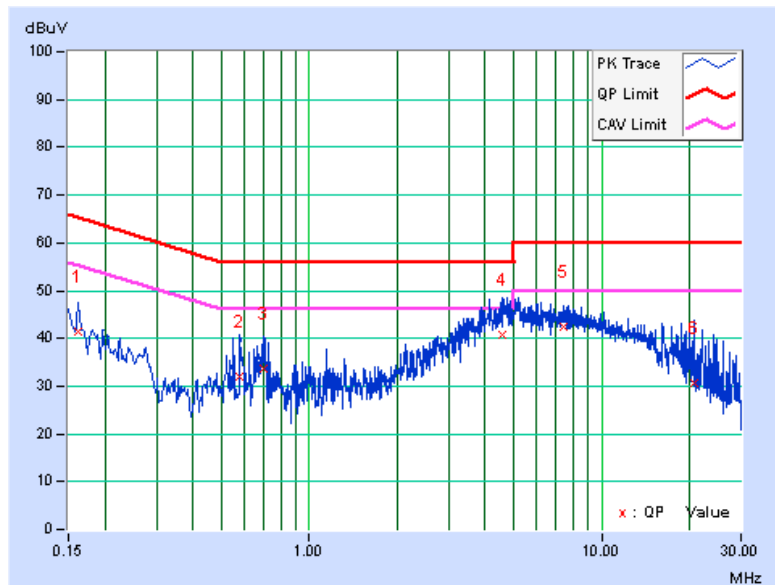

PHASE	Line 2	6dB BANDWIDTH	9kHz
TEST MODE	A		

No	Freq. [MHz]	Corr. Factor (dB)	Reading Value		Emission Level		Limit		Margin	
			[dB (uV)]		[dB (uV)]		[dB (uV)]		(dB)	
			Q.P.	AV.	Q.P.	AV.	Q.P.	AV.	Q.P.	AV.
1	0.15391	0.05	42.24	26.09	42.29	26.14	65.79	55.79	-23.50	-29.65
2	0.18508	0.05	36.78	21.67	36.83	21.72	64.25	54.25	-27.42	-32.53
3	4.39235	0.23	34.92	22.98	35.15	23.21	56.00	46.00	-20.85	-22.79
4	6.27306	0.30	34.50	21.47	34.80	21.77	60.00	50.00	-25.20	-28.23
5	7.46561	0.34	33.88	21.37	34.22	21.71	60.00	50.00	-25.78	-28.29
6	9.49099	0.42	32.46	19.97	32.88	20.39	60.00	50.00	-27.12	-29.61

**REMARKS:**

1. Q.P. and AV. are abbreviations of quasi-peak and average individually.
2. The emission levels of other frequencies were very low against the limit.
3. Margin value = Emission level - Limit value
4. Correction factor = Insertion loss + Cable loss
5. Emission Level = Correction Factor + Reading Value

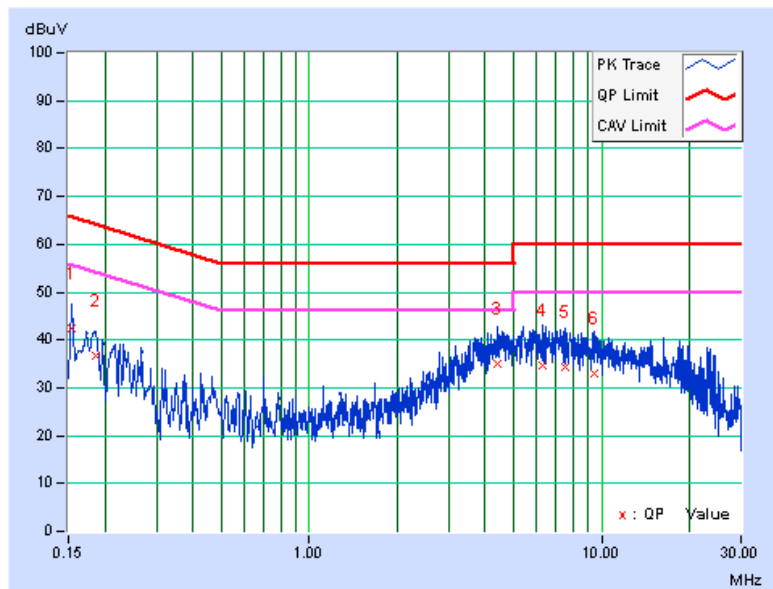





A D T

PHASE	Line 1	6dB BANDWIDTH	9kHz
TEST MODE	B		

No	Freq. [MHz]	Corr. Factor (dB)	Reading Value		Emission Level		Limit		Margin	
			[dB (uV)]		[dB (uV)]		[dB (uV)]		(dB)	
			Q.P.	AV.	Q.P.	AV.	Q.P.	AV.	Q.P.	AV.
1	0.47412	0.08	43.94	37.62	44.02	37.70	56.44	46.44	-12.42	-8.74
2	0.59183	0.09	43.05	34.74	43.14	34.83	56.00	46.00	-12.86	-11.17
3	0.69349	0.09	41.94	25.87	42.03	25.96	56.00	46.00	-13.97	-20.04
4	1.14312	0.12	37.00	25.64	37.12	25.76	56.00	46.00	-18.88	-20.24
5	3.74329	0.22	46.43	39.42	46.65	39.64	56.00	46.00	-9.35	-6.36
6	4.28287	0.24	44.56	36.18	44.80	36.42	56.00	46.00	-11.20	-9.58
7	4.80290	0.27	45.97	38.86	46.24	39.13	56.00	46.00	-9.76	-6.87

**REMARKS:**

1. Q.P. and AV. are abbreviations of quasi-peak and average individually.
2. The emission levels of other frequencies were very low against the limit.
3. Margin value = Emission level - Limit value
4. Correction factor = Insertion loss + Cable loss
5. Emission Level = Correction Factor + Reading Value

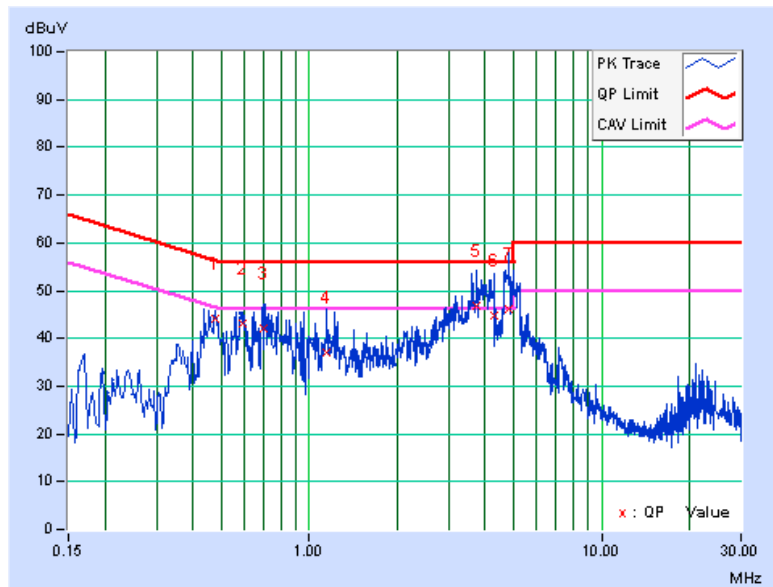



A D T

PHASE	Line 2	6dB BANDWIDTH	9kHz
TEST MODE	B		

No	Freq. [MHz]	Corr. Factor (dB)	Reading Value		Emission Level		Limit		Margin	
			[dB (uV)]		[dB (uV)]		[dB (uV)]		(dB)	
			Q.P.	AV.	Q.P.	AV.	Q.P.	AV.	Q.P.	AV.
1	0.50972	0.07	39.16	25.12	39.23	25.19	56.00	46.00	-16.77	-20.81
2	1.13923	0.10	36.39	24.48	36.49	24.58	56.00	46.00	-19.51	-21.42
3	2.50382	0.16	36.87	28.89	37.03	29.05	56.00	46.00	-18.97	-16.95
4	<b>3.61035</b>	<b>0.20</b>	<b>47.60</b>	<b>40.17</b>	<b>47.80</b>	<b>40.37</b>	<b>56.00</b>	<b>46.00</b>	<b>-8.20</b>	<b>-5.63</b>
5	4.53311	0.23	45.88	37.61	46.11	37.84	56.00	46.00	-9.89	-8.16
6	4.93193	0.25	47.08	39.08	47.33	39.33	56.00	46.00	-8.67	-6.67
7	5.32684	0.26	43.61	35.37	43.87	35.63	60.00	50.00	-16.13	-14.37

**REMARKS:**

1. Q.P. and AV. are abbreviations of quasi-peak and average individually.
2. The emission levels of other frequencies were very low against the limit.
3. Margin value = Emission level - Limit value
4. Correction factor = Insertion loss + Cable loss
5. Emission Level = Correction Factor + Reading Value

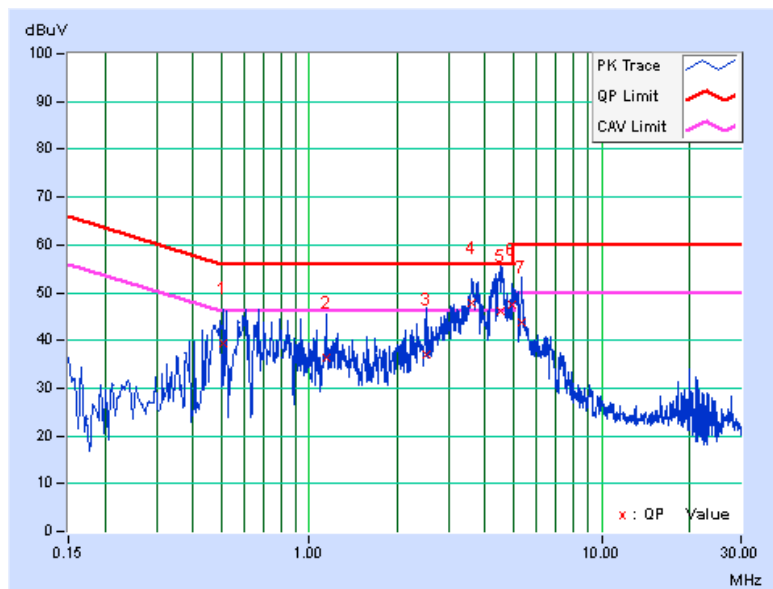

## 4.3 6dB BANDWIDTH MEASUREMENT

### 4.3.1 LIMITS OF 6dB BANDWIDTH MEASUREMENT

The minimum of 6dB Bandwidth Measurement is 0.5 MHz.

### 4.3.2 TEST SETUP

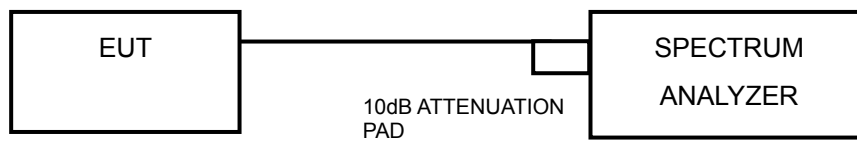

### 4.3.3 TEST INSTRUMENTS

Refer to section 4.1.2 to get information of above instrument.

### 4.3.4 TEST PROCEDURE

- a. Set resolution bandwidth (RBW) = 100kHz
- b. Set the video bandwidth (VBW)  $\geq 3 \times$  RBW, Detector = Peak.
- c. Trace mode = max hold.
- d. Sweep = auto couple.
- e. Measure the maximum width of the emission that is constrained by the frequencies associated with the two amplitude points (upper and lower) that are attenuated by 6 dB relative to the maximum level measured in the fundamental emission

### 4.3.5 DEVIATION FROM TEST STANDARD

No deviation.

### 4.3.6 EUT OPERATING CONDITIONS

The software provided by client to enable the EUT under transmission condition continuously at lowest, middle and highest channel frequencies individually.

### 4.3.7 TEST RESULTS

#### 802.11b

CHANNEL	FREQUENCY (MHz)	6dB BANDWIDTH (MHz)		MINIMUM LIMIT (MHz)	PASS / FAIL
		CHAIN 0	CHAIN 1		
1	2412	10.11	10.11	0.5	PASS
6	2437	10.12	10.12	0.5	PASS
11	2462	10.11	10.11	0.5	PASS

#### 802.11g

CHANNEL	FREQUENCY (MHz)	6dB BANDWIDTH (MHz)		MINIMUM LIMIT (MHz)	PASS / FAIL
		CHAIN 0	CHAIN 1		
1	2412	16.40	16.41	0.5	PASS
6	2437	16.38	16.39	0.5	PASS
11	2462	16.38	16.39	0.5	PASS

#### 802.11n (20MHz)

CHANNEL	FREQUENCY (MHz)	6dB BANDWIDTH (MHz)		MINIMUM LIMIT (MHz)	PASS / FAIL
		CHAIN 0	CHAIN 1		
1	2412	17.62	17.61	0.5	PASS
6	2437	17.60	17.60	0.5	PASS
11	2462	17.61	17.61	0.5	PASS

#### 802.11n (40MHz)

CHANNEL	FREQUENCY (MHz)	6dB BANDWIDTH (MHz)		MINIMUM LIMIT (MHz)	PASS / FAIL
		CHAIN 0	CHAIN 1		
3	2422	36.47	36.47	0.5	PASS
6	2437	36.46	36.47	0.5	PASS
9	2452	36.46	36.49	0.5	PASS



A D T

### SPECTRUM PLOT OF WORST VALUE

**802.11b**

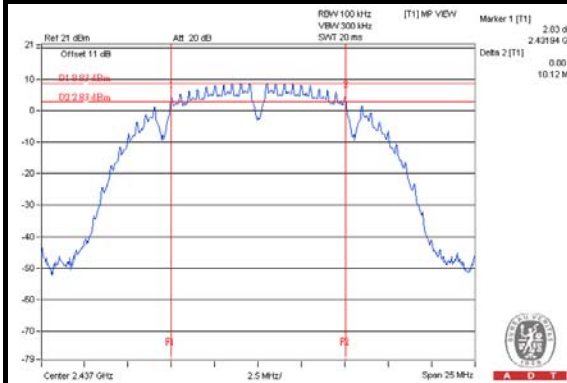

**802.11g**

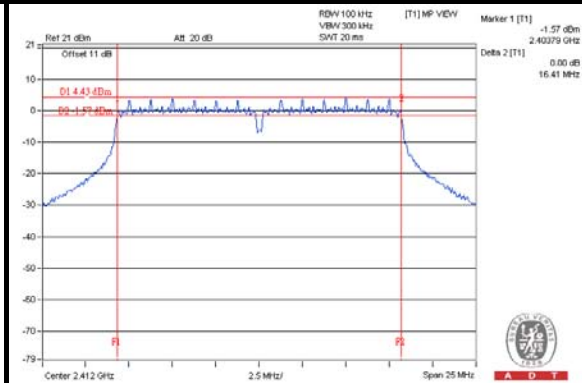

**802.11n (20MHz)**

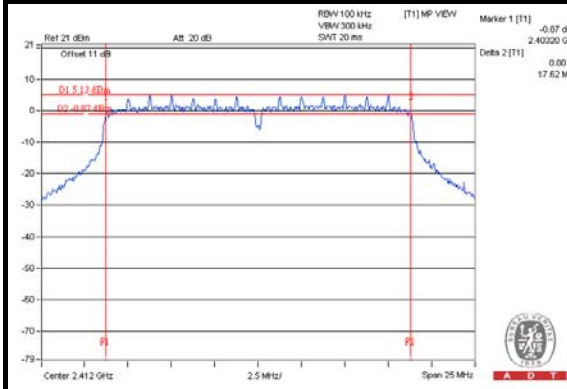

**802.11n (40MHz)**

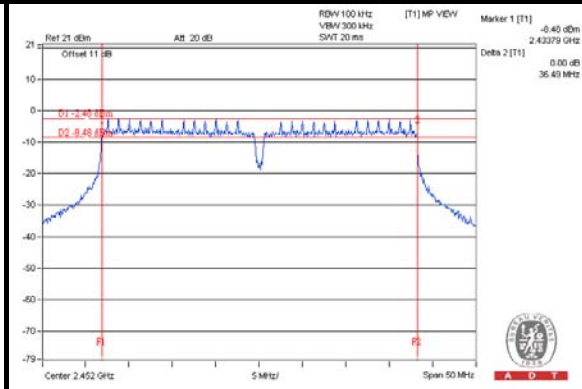

## 4.4 CONDUCTED OUTPUT POWER

### 4.4.1 LIMITS OF CONDUCTED OUTPUT POWER MEASUREMENT

For systems using digital modulation in the 2400–2483.5 MHz bands: 1 Watt (30dBm)

Per KDB 662911 D01 Multiple Transmitter Output v02r01 Method of conducted output power measurement on IEEE 802.11 devices,

Array Gain = 0 dB (i.e., no array gain) for  $NANT \leq 4$ ;

Array Gain = 0 dB (i.e., no array gain) for channel widths  $\geq 40$  MHz for any NANT;

Array Gain =  $5 \log(NANT/NSS)$  dB or 3 dB, whichever is less for 20-MHz channel widths with  $NANT \geq 5$ .

For power measurements on all other devices: Array Gain =  $10 \log(NANT/NSS)$  dB.

### 4.4.2 TEST SETUP

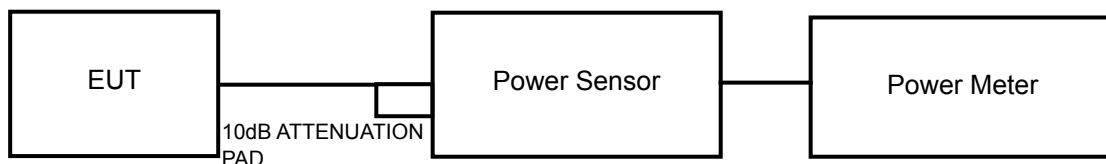

### 4.4.3 TEST INSTRUMENTS

Refer to section 4.1.2 to get information of above instrument.

### 4.4.4 TEST PROCEDURES

An average power sensor was used on the output port of the EUT. A power meter was used to read the response of the average power sensor. Record the power level.

#### 4.4.5 DEVIATION FROM TEST STANDARD

No deviation.

#### 4.4.6 EUT OPERATING CONDITIONS

Same as Item 4.3.6.



## 4.4.7 TEST RESULTS

## 802.11b

CHAN.	FREQ. (MHz)	AVG. POWER (dBm)		TOTAL POWER (mW)	TOTAL POWER (dBm)	LIMIT (dBm)	PASS / FAIL
		CHAIN 0	CHAIN 1				
1	2412	16.50	15.01	76.364	18.83	30	PASS
6	2437	17.17	16.21	<b>93.902</b>	19.73	30	PASS
11	2462	15.58	15.13	68.725	18.37	30	PASS

## 802.11g

CHAN.	FREQ. (MHz)	AVG. POWER (dBm)		TOTAL POWER (mW)	TOTAL POWER (dBm)	LIMIT (dBm)	PASS / FAIL
		CHAIN 0	CHAIN 1				
1	2412	16.22	15.41	76.633	18.84	30	PASS
6	2437	16.58	15.61	81.891	19.13	30	PASS
11	2462	16.00	15.56	75.786	18.80	30	PASS

## 802.11n (20MHz)

CHAN.	FREQ. (MHz)	AVG. POWER (dBm)		TOTAL POWER (mW)	TOTAL POWER (dBm)	LIMIT (dBm)	PASS / FAIL
		CHAIN 0	CHAIN 1				
1	2412	16.49	15.56	80.541	19.06	30	PASS
6	2437	16.73	15.71	84.337	19.26	30	PASS
11	2462	16.05	15.68	77.255	18.88	30	PASS

## 802.11n (40MHz)

CHAN.	FREQ. (MHz)	AVG. POWER (dBm)		TOTAL POWER (mW)	TOTAL POWER (dBm)	LIMIT (dBm)	PASS / FAIL
		CHAIN 0	CHAIN 1				
3	2422	14.83	13.65	53.583	17.29	30	PASS
6	2437	16.88	15.97	88.290	19.46	30	PASS
9	2452	13.33	12.11	37.783	15.77	30	PASS



## 4.5 POWER SPECTRAL DENSITY MEASUREMENT

### 4.5.1 LIMITS OF POWER SPECTRAL DENSITY MEASUREMENT

The Maximum of Power Spectral Density Measurement is 8dBm.

### 4.5.2 TEST SETUP

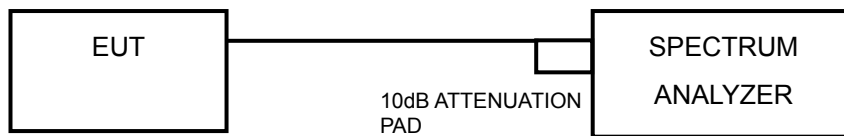

### 4.5.3 TEST INSTRUMENTS

Refer to section 4.1.2 to get information of above instrument.

### 4.5.4 TEST PROCEDURE

- a) Set instrument center frequency to DTS channel center frequency.
- b) Set span to at least 1.5 times the OBW.
- c) Set RBW to:  $3 \text{ kHz} \leq \text{RBW} \leq 100 \text{ kHz}$ .
- d) Set VBW  $\geq 3 \times \text{RBW}$ .
- e) Detector = power averaging (RMS) or sample detector (when RMS not available).
- f) Ensure that the number of measurement points in the sweep  $\geq 2 \times \text{span/RBW}$ .
- g) Sweep time = auto couple.
- h) Employ trace averaging (RMS) mode over a minimum of 100 traces.
- i) Use the peak marker function to determine the maximum amplitude level.

### 4.5.5 DEVIATION FROM TEST STANDARD

No deviation.

### 4.5.6 EUT OPERATING CONDITION

Same as Item 4.3.6

#### 4.5.7 TEST RESULTS

##### 802.11b

TX chain	Channel	Freq. (MHz)	PSD (dBm/3kHz)	10 log (N=2) dB	Total PSD (dBm/3kHz)	Limit (dBm/3kHz)	PASS /FAIL
0	1	2412	-12.70	3.01	-9.69	7.48	PASS
	6	2437	-10.59	3.01	-7.58	7.48	PASS
	11	2462	-13.26	3.01	-10.25	7.48	PASS
1	1	2412	-14.12	3.01	-11.11	7.48	PASS
	6	2437	-12.13	3.01	-9.12	7.48	PASS
	11	2462	-13.24	3.01	-10.23	7.48	PASS

**NOTE:** Directional gain =  $10 \log[(10^{G1/20} + 10^{G2/20} + \dots + 10^{GN/20})^2 / N_{ANT}] = 6.52 > 6\text{dBi}$ , so the power density limit shall be reduced to  $8 - (6.52 - 6) = 7.48\text{dBm}$ .

##### 802.11g

TX chain	Chan.	Freq. (MHz)	PSD (dBm/3kHz)	10 log (N=2) dB	Total PSD without Duty Factor (dBm/3kHz)	Duty Factor	Total PSD with Duty Factor (dBm/3kHz)	Limit (dBm/3kHz)	PASS /FAIL
0	1	2412	-14.48	3.01	-11.47	0.17	-11.30	7.48	PASS
	6	2437	-14.20	3.01	-11.19	0.17	-11.02	7.48	PASS
	11	2462	-14.59	3.01	-11.58	0.17	-11.41	7.48	PASS
1	1	2412	-15.28	3.01	-12.27	0.17	-12.10	7.48	PASS
	6	2437	-15.29	3.01	-12.28	0.17	-12.11	7.48	PASS
	11	2462	-15.27	3.01	-12.26	0.17	-12.09	7.48	PASS

**NOTE:**

- Method 1 of power density measurement of KDB 662911 is using for calculating total power density. Total power density is summing entire spectra across corresponding frequency bins on the various outputs by computer.
- Directional gain =  $10 \log[(10^{G1/20} + 10^{G2/20} + \dots + 10^{GN/20})^2 / N_{ANT}] = 6.52 > 6\text{dBi}$ , so the power density limit shall be reduced to  $8 - (6.52 - 6) = 7.48\text{dBm}$ .
- Refer to section 3.3 for duty cycle spectrum plot.



A D T

**802.11n (20MHz)**

TX chain	Chan.	Freq. (MHz)	PSD (dBm/3kHz)	10 log (N=2) dB	Total PSD without Duty Factor (dBm/3kHz)	Duty Factor	Total PSD with Duty Factor (dBm/3kHz)	Limit (dBm/3kHz)	PASS /FAIL
0	1	2412	-14.37	3.01	-11.36	0.20	-11.16	7.48	PASS
	6	2437	-14.63	3.01	-11.62	0.20	-11.42	7.48	PASS
	11	2462	-15.16	3.01	-12.15	0.20	-11.95	7.48	PASS
1	1	2412	-15.77	3.01	-12.76	0.20	-12.56	7.48	PASS
	6	2437	-15.81	3.01	-12.80	0.20	-12.60	7.48	PASS
	11	2462	-15.26	3.01	-12.25	0.20	-12.05	7.48	PASS

**NOTE:**

1. Method 1 of power density measurement of KDB 662911 is using for calculating total power density. Total power density is summing entire spectra across corresponding frequency bins on the various outputs by computer.
2. Directional gain =  $10 \log[(10^{G1/20} + 10^{G2/20} + \dots + 10^{GN/20})^2 / N_{ANT}] = 6.52 > 6\text{dBi}$ , so the power density limit shall be reduced to  $8 - (6.52 - 6) = 7.48\text{dBm}$ .
3. Refer to section 3.3 for duty cycle spectrum plot.

**802.11n (40MHz)**

TX chain	Chan.	Freq. (MHz)	PSD (dBm/3kHz)	10 log (N=2) dB	Total PSD without Duty Factor (dBm/3kHz)	Duty Factor	Total PSD with Duty Factor (dBm/3kHz)	Limit (dBm/3kHz)	PASS /FAIL
0	3	2422	-17.92	3.01	-14.91	0.33	-14.58	7.48	PASS
	6	2437	-16.28	3.01	-13.27	0.33	-12.94	7.48	PASS
	9	2452	-20.20	3.01	-17.19	0.33	-16.86	7.48	PASS
1	3	2422	-19.95	3.01	-16.94	0.33	-16.61	7.48	PASS
	6	2437	-17.84	3.01	-14.83	0.33	-14.50	7.48	PASS
	9	2452	-21.93	3.01	-18.92	0.33	-18.59	7.48	PASS

**NOTE:**

1. Method 1 of power density measurement of KDB 662911 is using for calculating total power density. Total power density is summing entire spectra across corresponding frequency bins on the various outputs by computer.
2. Directional gain =  $10 \log[(10^{G1/20} + 10^{G2/20} + \dots + 10^{GN/20})^2 / N_{ANT}] = 6.52 > 6\text{dBi}$ , so the power density limit shall be reduced to  $8 - (6.52 - 6) = 7.48\text{dBm}$ .
3. Refer to section 3.3 for duty cycle spectrum plot.



A D T

### SPECTRUM PLOT OF WORST VALUE

**802.11b**

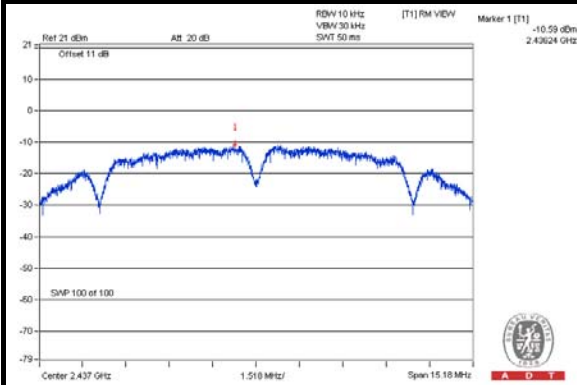

**802.11g**

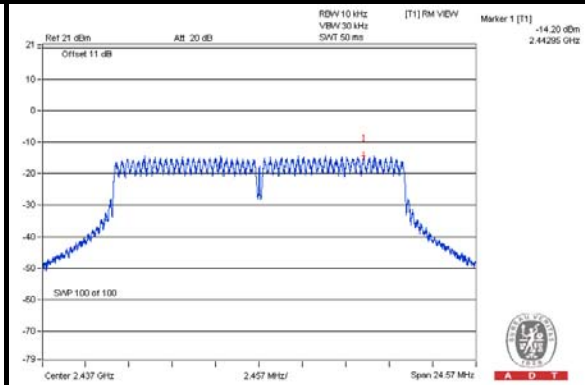

**802.11n (20MHz)**

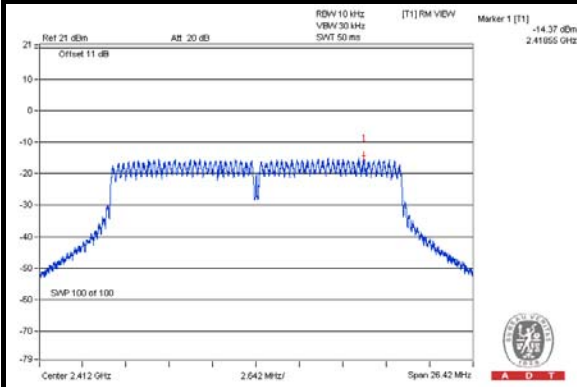

**802.11n (40MHz)**

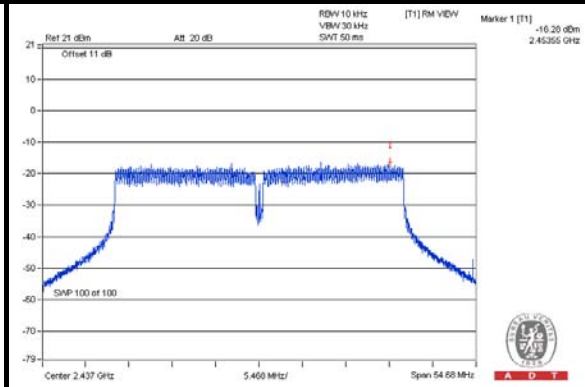

## 4.6 CONDUCTED OUT OF BAND EMISSION MEASUREMENT

### 4.6.1 LIMITS OF CONDUCTED OUT OF BAND EMISSION MEASUREMENT

Below  $-30\text{dB}$  of the highest emission level of operating band (in 100kHz Resolution Bandwidth).

### 4.6.2 TEST SETUP

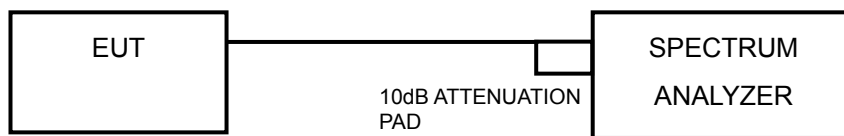

### 4.6.3 TEST INSTRUMENTS

Refer to section 4.1.2 to get information of above instrument.

#### 4.6.4 TEST PROCEDURE

##### **MEASUREMENT PROCEDURE REF**

1. Set the RBW = 100 kHz.
2. Set the VBW  $\geq$  300 kHz.
3. Detector = peak.
4. Sweep time = auto couple.
5. Trace mode = max hold.
6. Allow trace to fully stabilize.
7. Use the peak marker function to determine the maximum power level in any 100 kHz band segment within the fundamental EBW.

##### **MEASUREMENT PROCEDURE OOB**

1. Set RBW = 100 kHz.
2. Set VBW  $\geq$  300 kHz.
3. Detector = peak.
4. Sweep = auto couple.
5. Trace Mode = max hold.
6. Allow trace to fully stabilize.
7. Use the peak marker function to determine the maximum amplitude level.

#### 4.6.5 DEVIATION FROM TEST STANDARD

No deviation.

#### 4.6.6 EUT OPERATING CONDITION

Same as Item 4.3.6

#### 4.6.7 TEST RESULTS

The conducted emission test is performed on each TX port of operating mode without summing or adding  $10\log(N)$  since the limit is relative emission limit.

The spectrum plots are attached on the following pages. D1 line indicates the highest level, and D2 line indicates the 30dB offset below D1. It shows compliance with the requirement.



A D T

# 802.11b CHAIN 0

## Reference Level

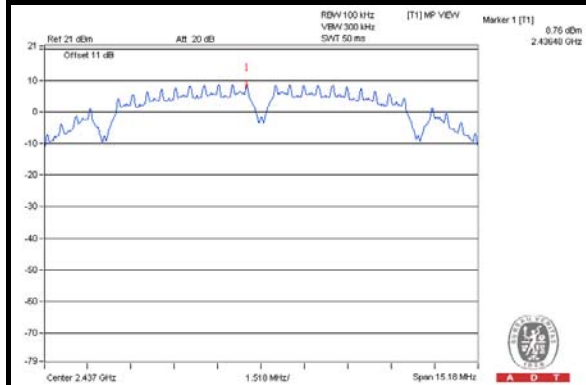

## CH 1

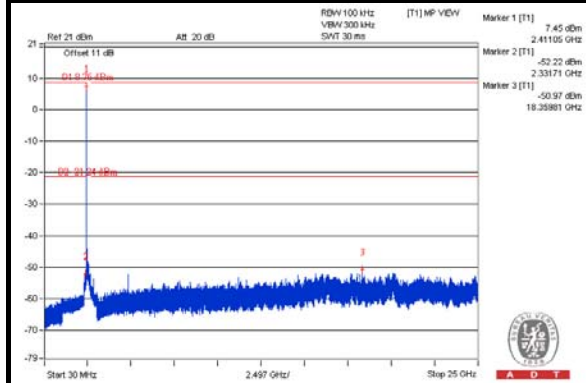

## CH 6

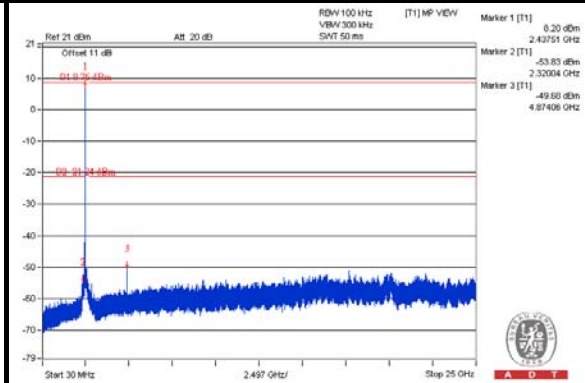

## CH 11

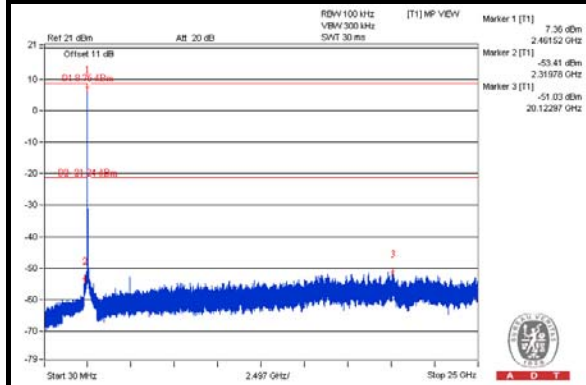

## CH 1 Band edge

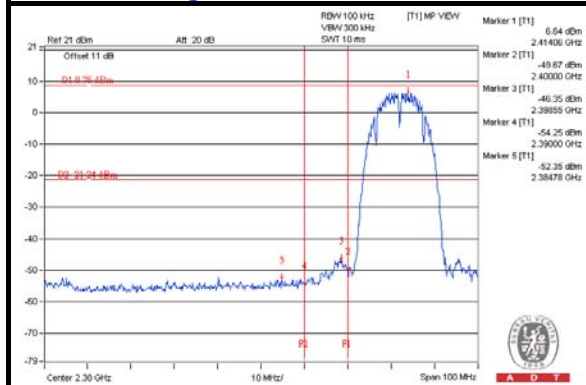

## CH 11 Band edge

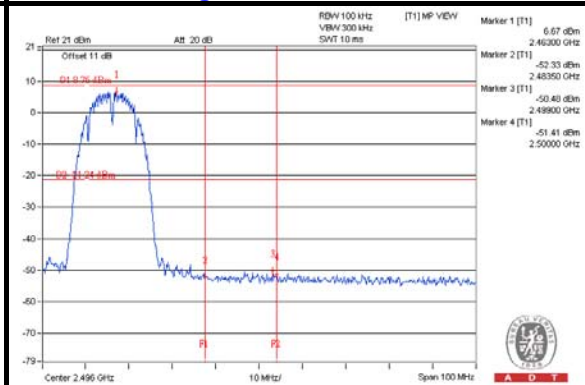



A D T

### CHAIN 1

#### Reference Level

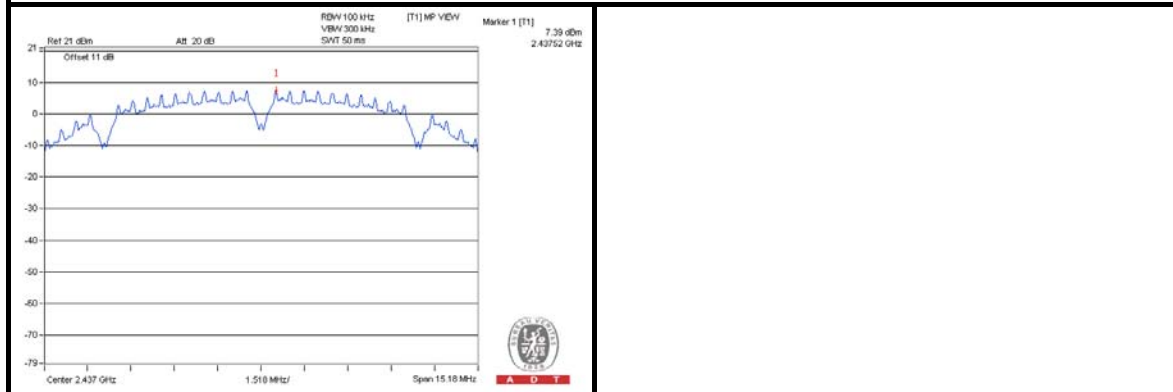

#### CH 1

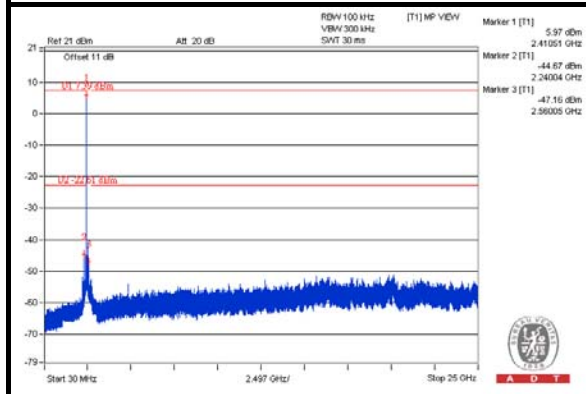

#### CH 6

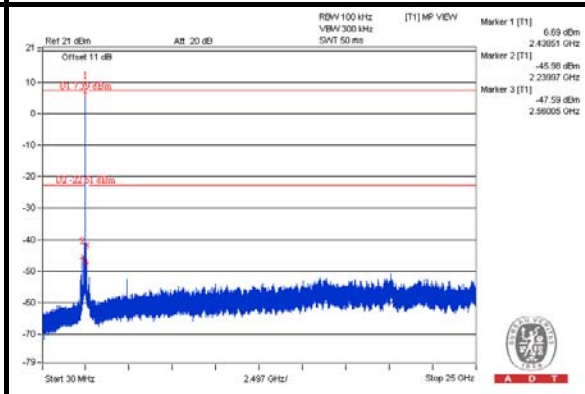

#### CH 11

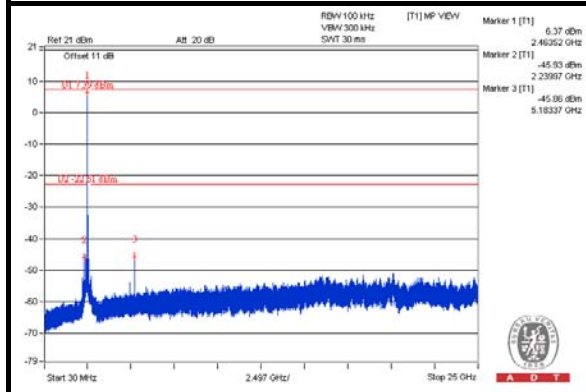

#### CH 1 Band edge

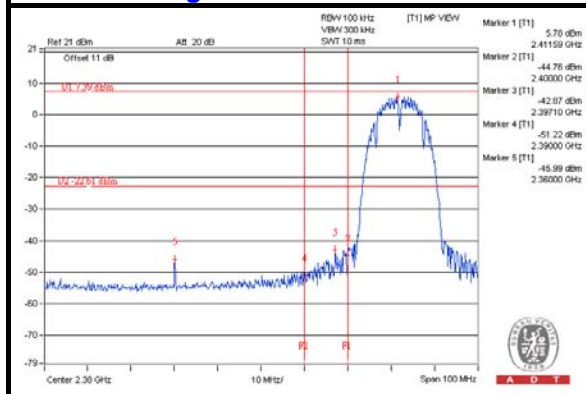

#### CH 11 Band edge

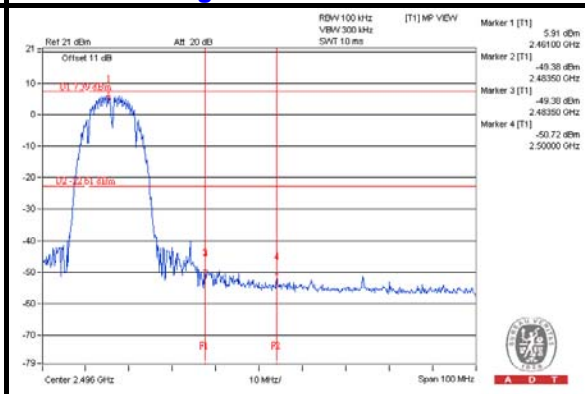





A D T

# 802.11g CHAIN 0

## Reference Level

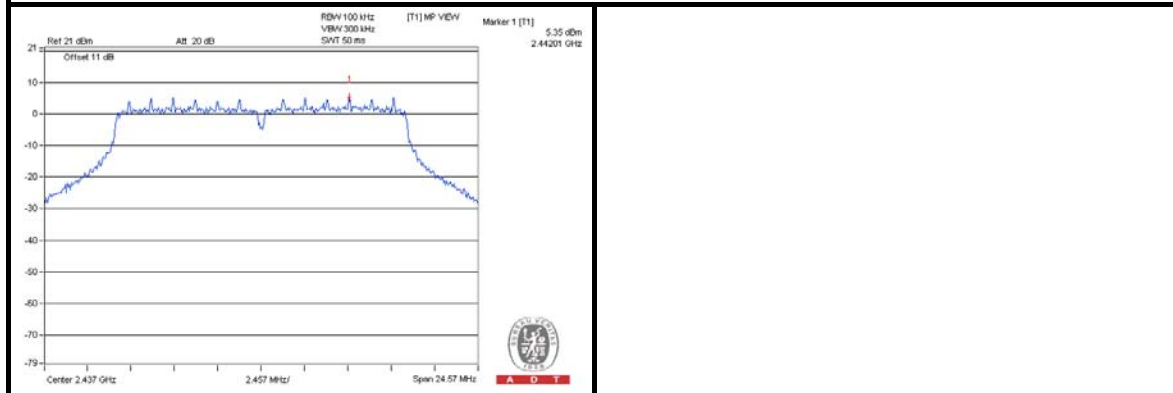

## CH 1

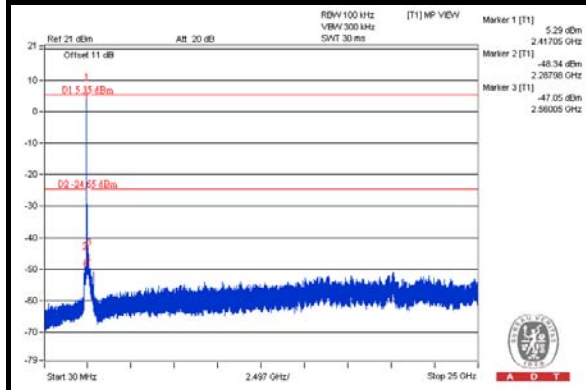

## CH 6

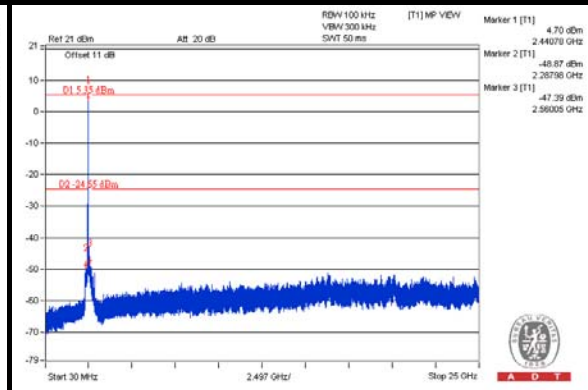

## CH 11

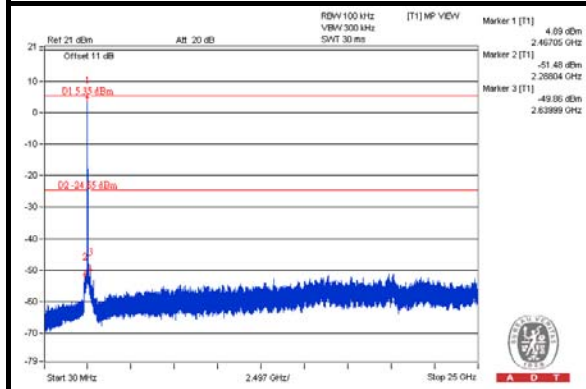

## CH 1 Band edge

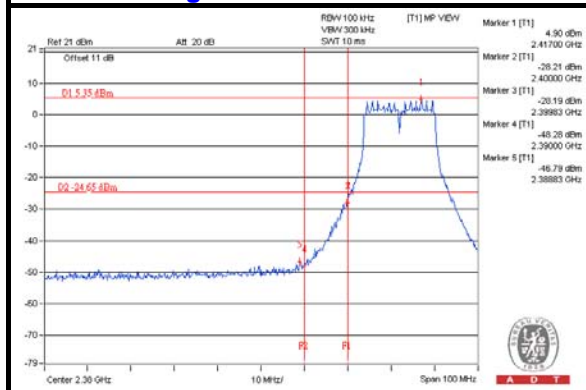

## CH 11 Band edge

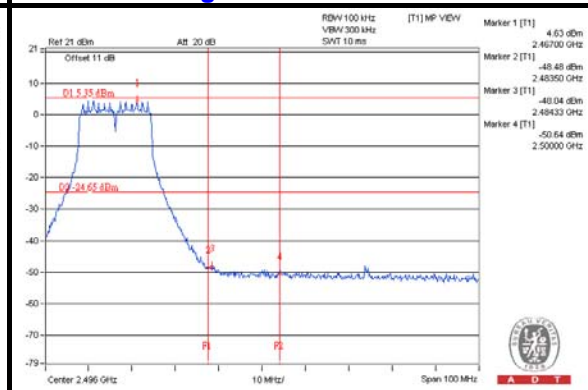

CHAIN 1

Reference Level

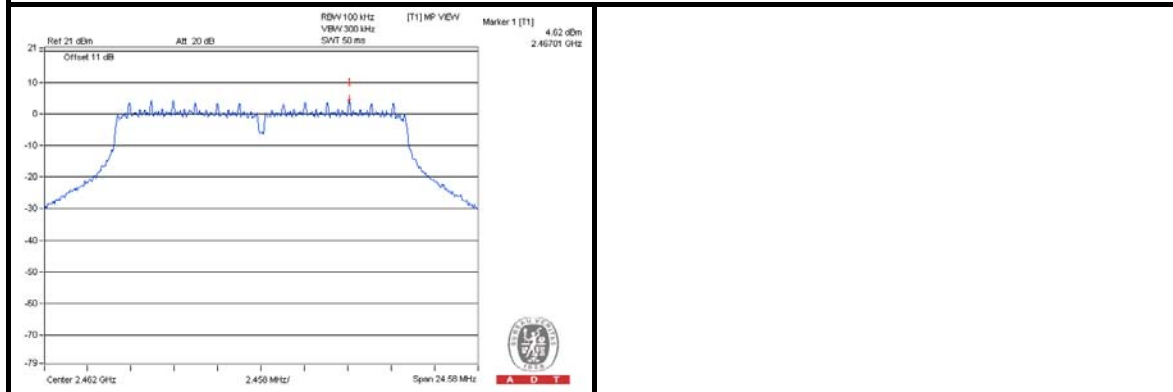

CH 1

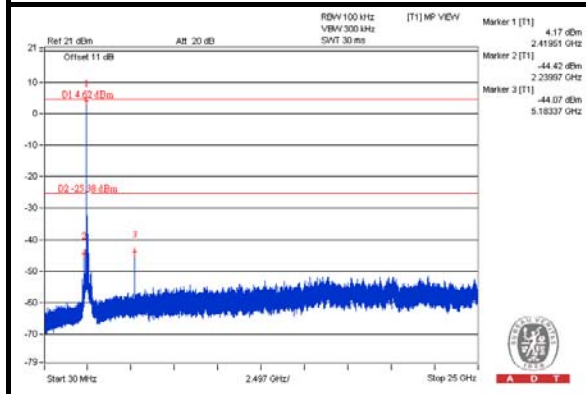

CH 6

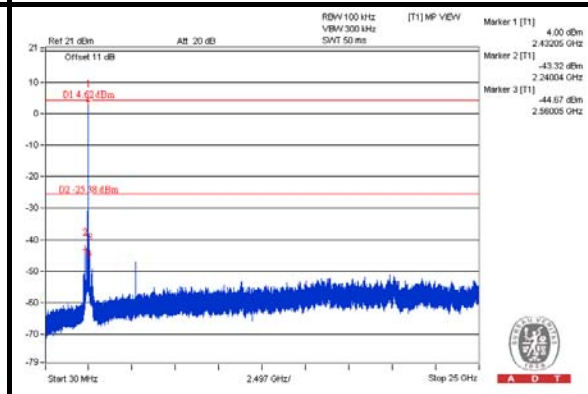

CH 11

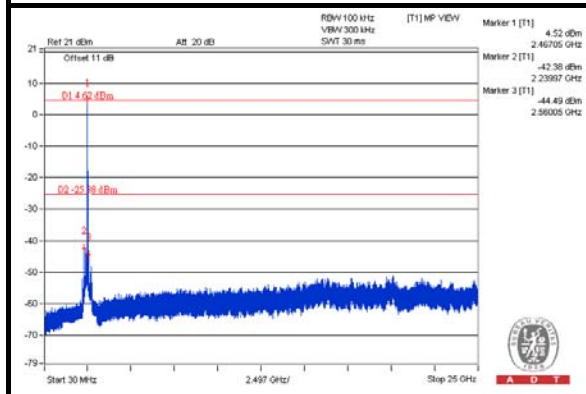

CH 1 Band edge

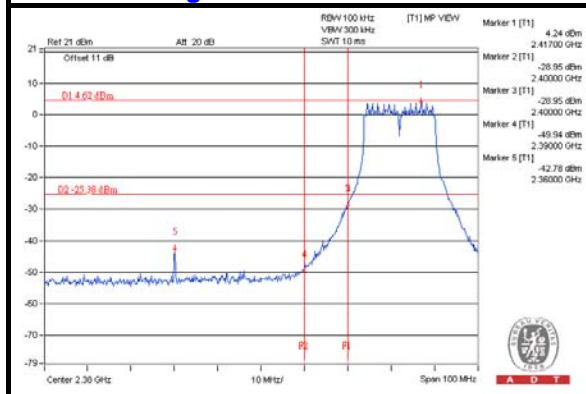

CH 11 Band edge

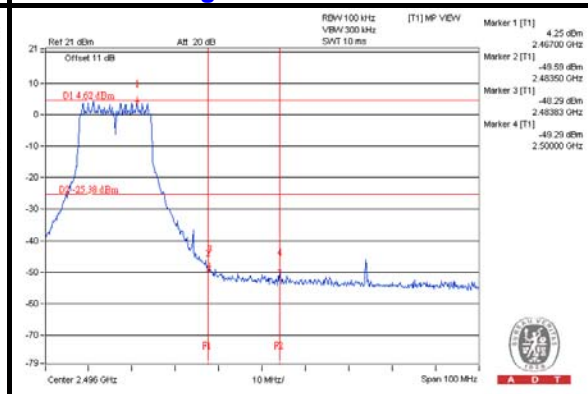

802.11n (20MHz)  
CHAIN 0

Reference Level

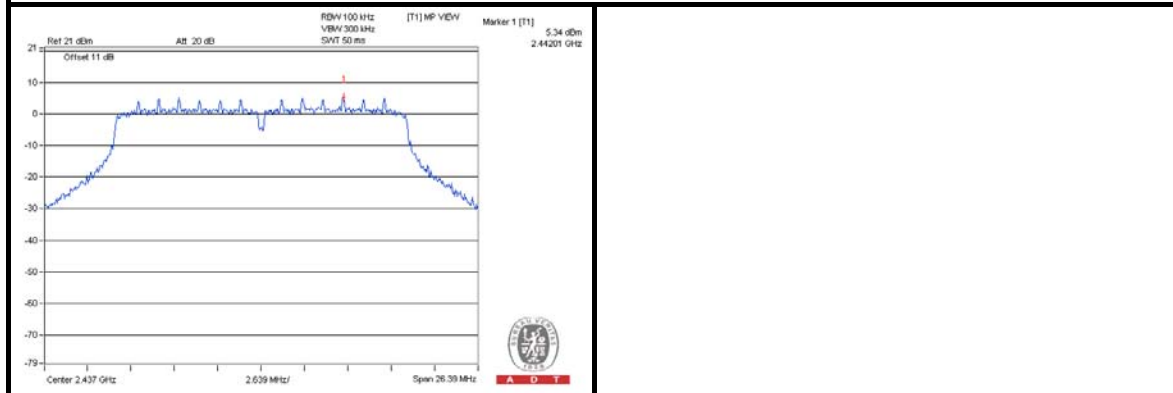

CH 1

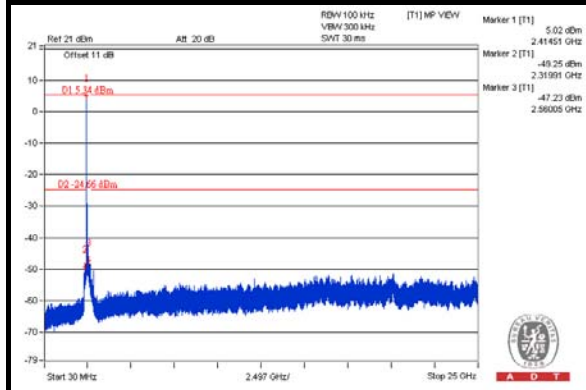

CH 6

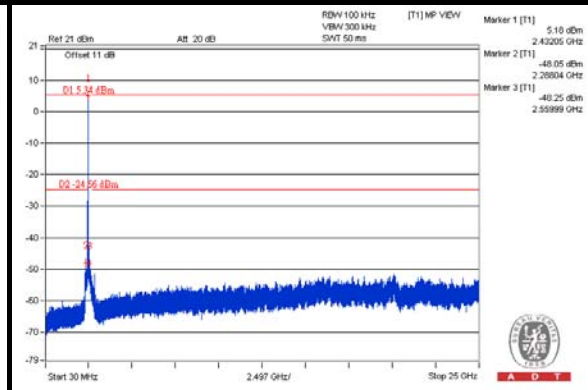

CH 11

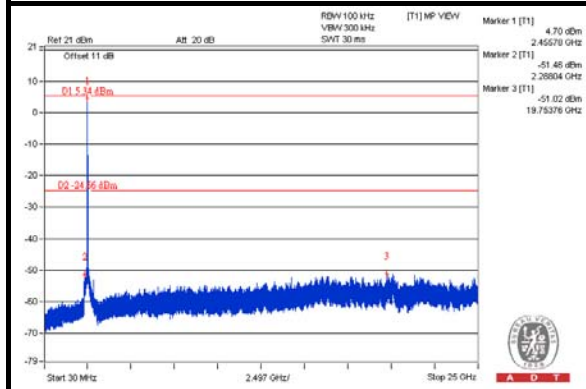

CH 1 Band edge

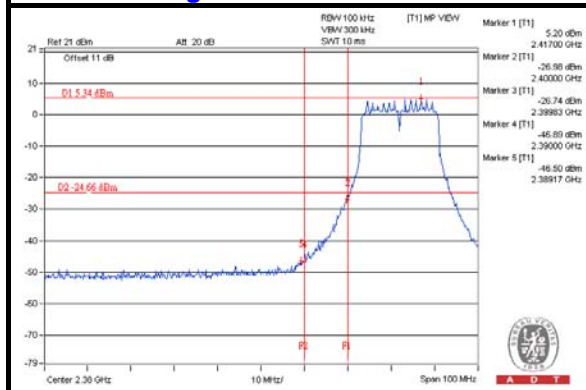

CH 11 Band edge

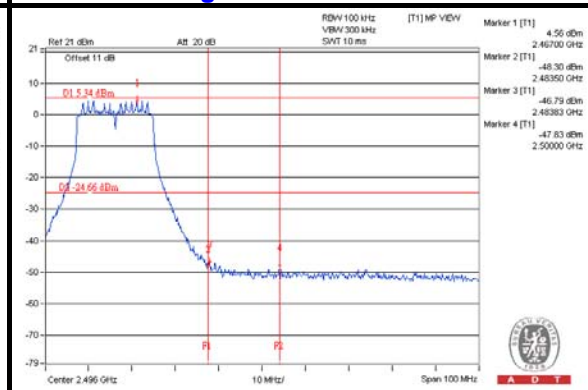

CHAIN 1

Reference Level

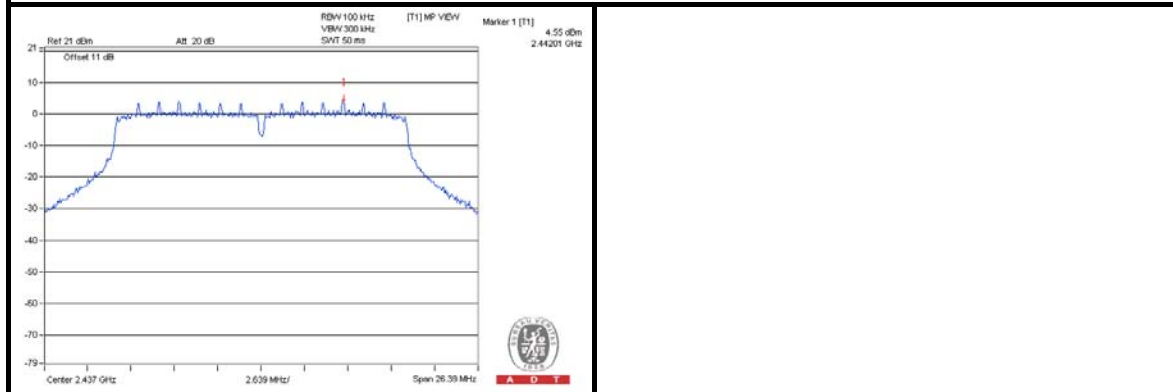

CH 1

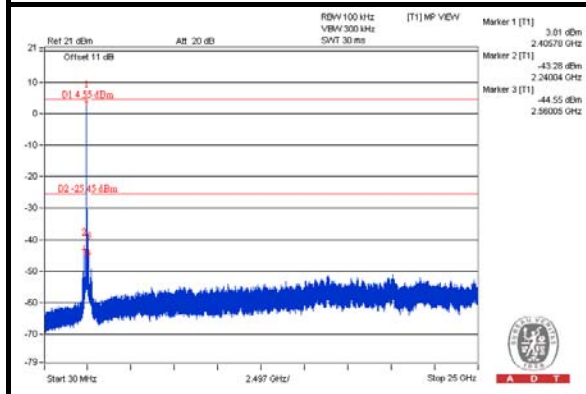

CH 6

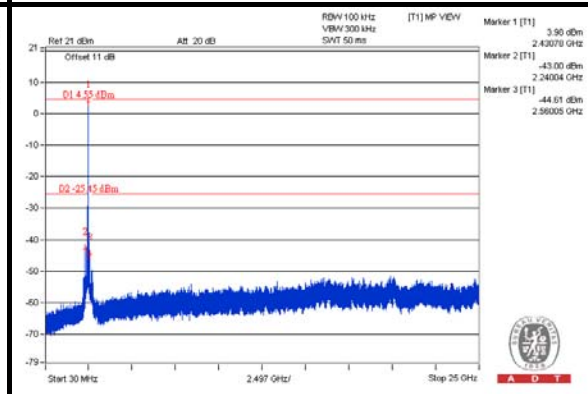

CH 11

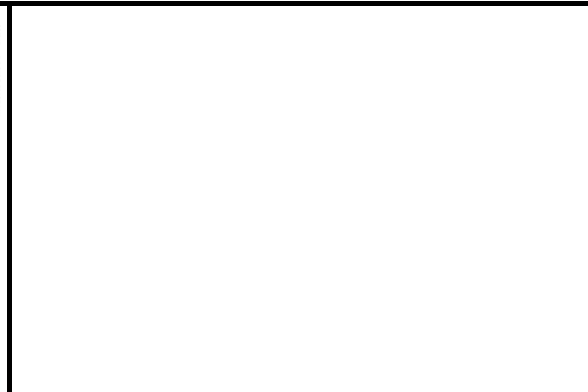
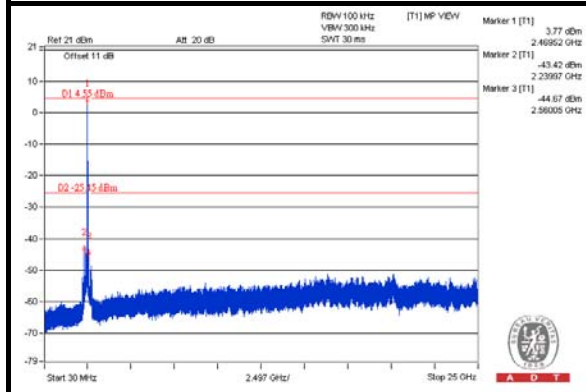

CH 1 Band edge

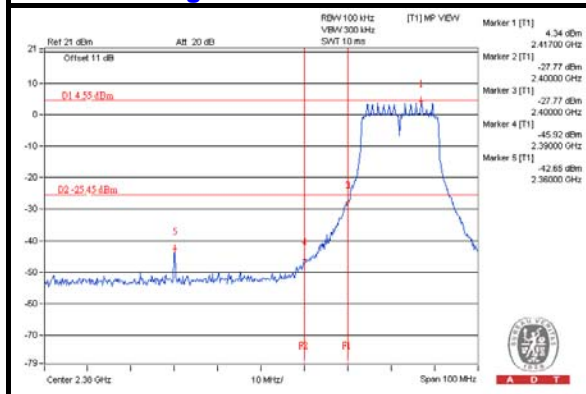

CH 11 Band edge

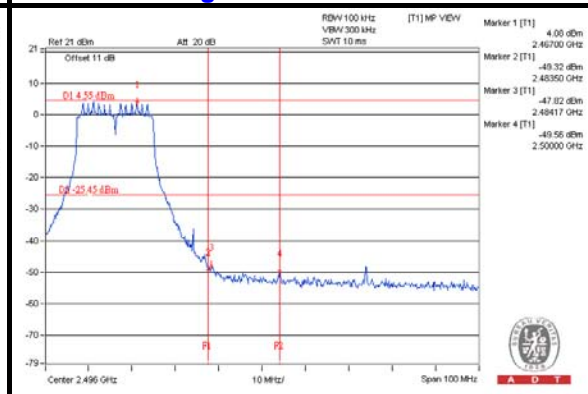

802.11n (40MHz)  
CHAIN 0

Reference Level

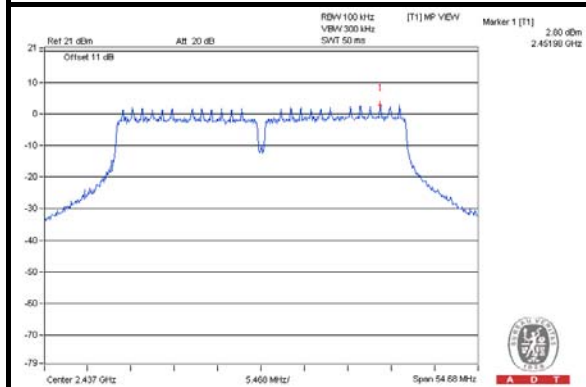

CH 3

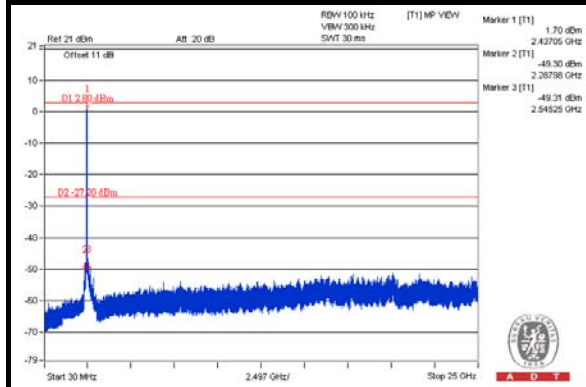

CH 6

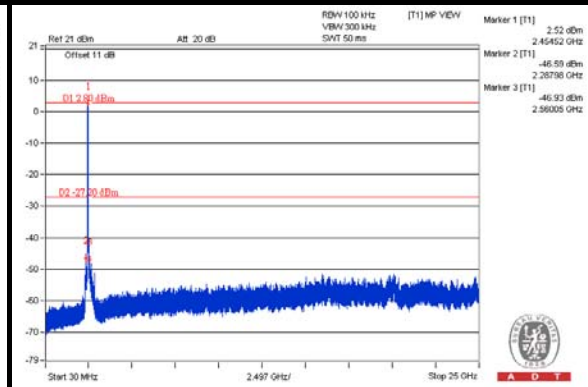

CH 9

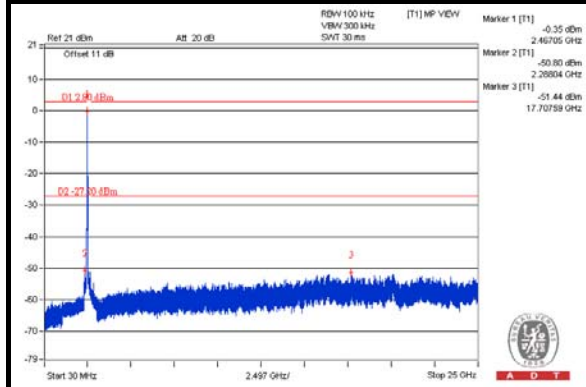

CH 3 Band edge

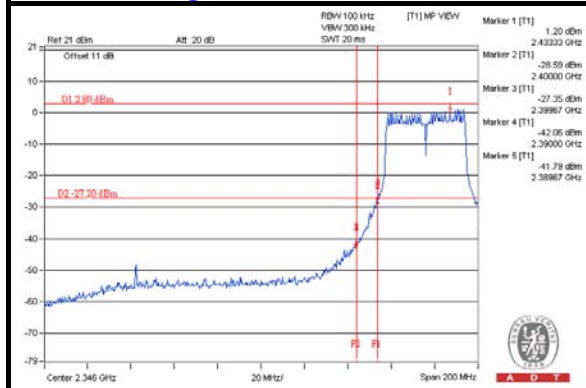

CH 9 Band edge

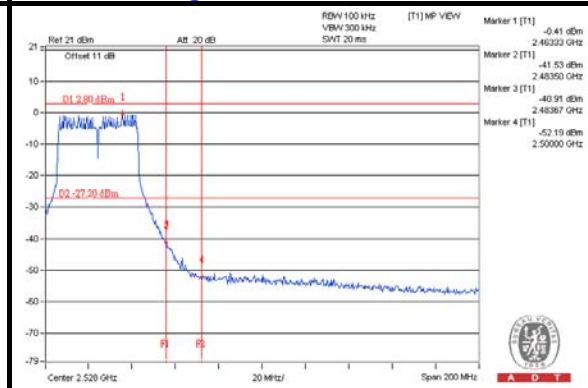

CHAIN 1

Reference Level

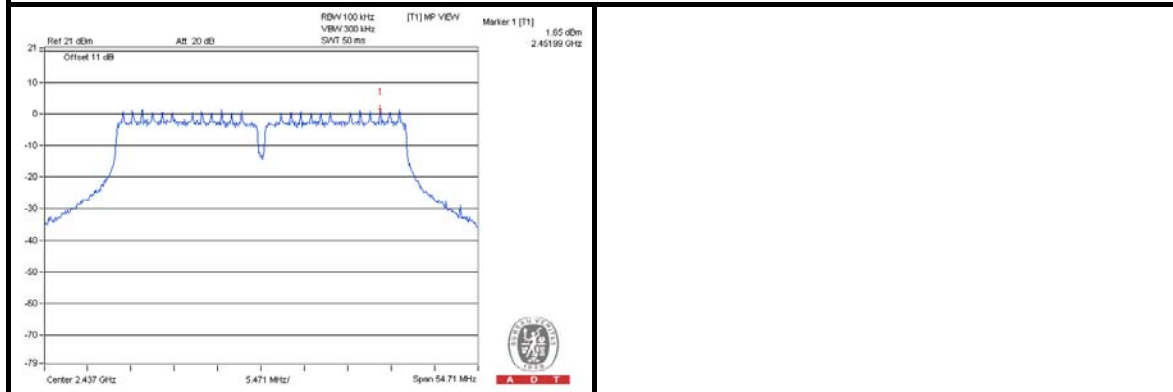

CH 3

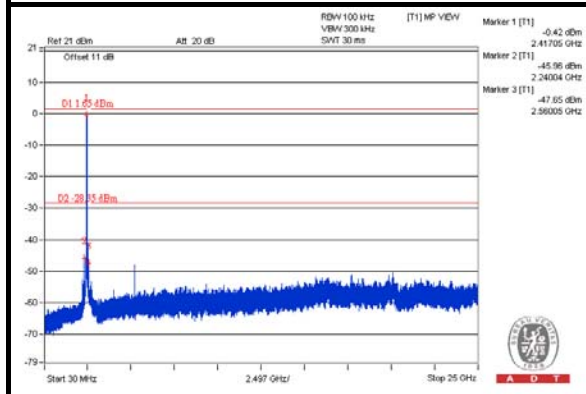

CH 6

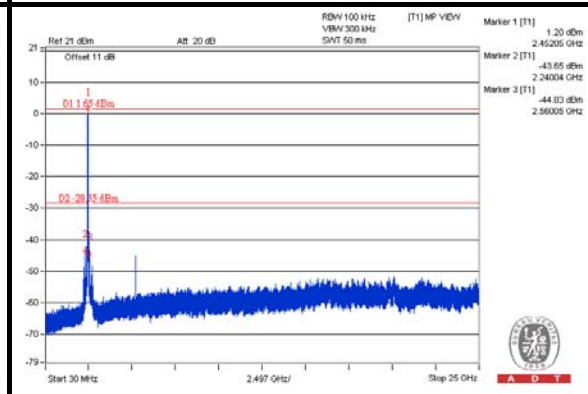

CH 9

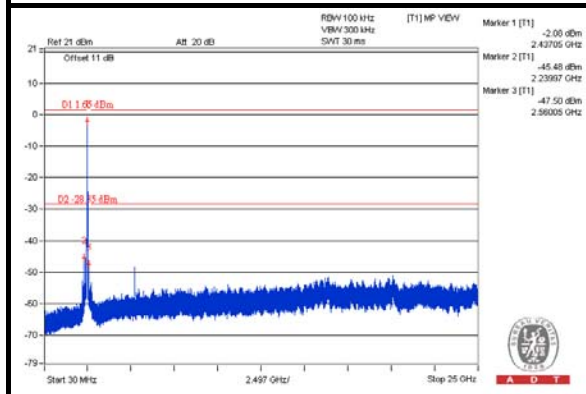

CH 3 Band edge

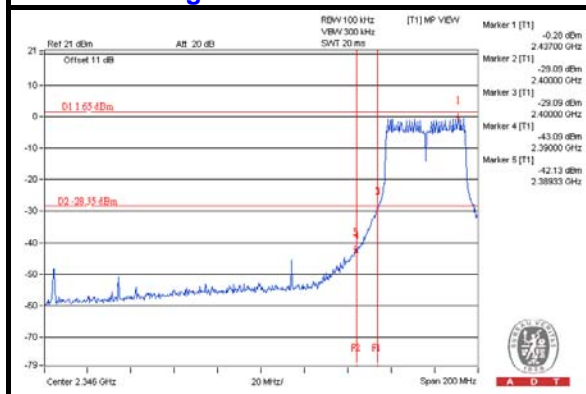

CH 9 Band edge

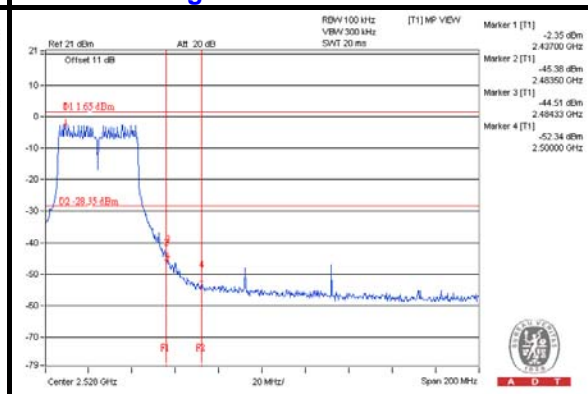



A D T

## 5. PHOTOGRAPHS OF THE TEST CONFIGURATION

Please refer to the attached file (Test Setup Photo).



## 6. INFORMATION ON THE TESTING LABORATORIES

We, Bureau Veritas Consumer Products Services (H.K.) Ltd., Taoyuan Branch, were founded in 1988 to provide our best service in EMC, Radio, Telecom and Safety consultation. Our laboratories are accredited and approved according to ISO/IEC 17025.

If you have any comments, please feel free to contact us at the following:

**Linko EMC/RF Lab:**

Tel: 886-2-26052180

Fax: 886-2-26051924

**Hsin Chu EMC/RF Lab:**

Tel: 886-3-5935343

Fax: 886-3-5935342

**Hwa Ya EMC/RF/Safety Telecom Lab:**

Tel: 886-3-3183232

Fax: 886-3-3270892

**Email:** [service.adt@tw.bureauveritas.com](mailto:service.adt@tw.bureauveritas.com)

**Web Site:** [www.bureauveritas-adt.com](http://www.bureauveritas-adt.com)

The address and road map of all our labs can be found in our web site also.





A D T

## **7. APPENDIX A – MODIFICATIONS RECORDERS FOR ENGINEERING CHANGES TO THE EUT BY THE LAB**

No any modifications are made to the EUT by the lab during the test.

**---END---**