



ISO/IEC17025 Accredited Lab.

# FCC ID TEST REPORT

for

Multimedia Speaker System

MODEL: IFIT-3BT

FCC ID: A8IIFIT-3BT

Test Report Number: 1301001079

Issued Date: January 8, 2013

Issued for

Shenzhen Divoom Technology Co., Ltd.

1506 Block C, Tiley Central Plaze, Nanshan Shenzhen, China

Issued By:

SHENZHEN TIMEWAY TECHNOLOGY CONSULTING CO., LTD.

5/F,Block 4, Anhua Industrial Zone., No.8 Tairan Rd. Chegongmiao,

Futian District Shenzhen, China

TEL: +86-755-83448688

FAX: +86-755-83442996

## TEST CERTIFICATION

<b>Product:</b>	Multimedia Speaker System
<b>Model:</b>	IFIT-3BT
<b>Applicant:</b>	<b>Shenzhen Divoom Technology Co., Ltd.</b> 1506 Block C, Tiley Central Plaze, Nanshan, Shenzhen, China
<b>Factory:</b>	<b>Shenzhen Divoom Technology Co., Ltd.</b> 1506 Block C, Tiley Central Plaze, Nanshan, Shenzhen, China
<b>Trade Mark:</b>	N/A
<b>Tested:</b>	January 3 ~ January 07, 2012
<b>Test Voltage:</b>	DC 5 V(DC From Adapter, Adapter input 120Vac, 60Hz)
<b>Applicable Standards:</b>	FCC Part 15 Subpart C: 2011 ANSI C63.4:2003

Deviation from Applicable Standard
None

The above equipment has been tested by SHENZHEN TIMEWAY TECHNOLOGY CONSULTING CO., LTD. and found compliance with the requirements set forth in the technical standards mentioned above. The results of testing in this report apply only to the product/system, which was tested. Other similar equipment will not necessarily produce the same results due to production tolerance and measurement uncertainties.

**Tested By:**   
(Brown Lu) **Date:** 2013-01-08

**Check By:**   
(Terry Tang) **Date:** 2013-01-08

**Approved By:**   
(Jack Chung) **Date:** 2013-01-08

<b>Table of Contents</b>		<b>Page</b>
<b>1 . SUMMARY OF TEST RESULTS</b>		<b>5</b>
<b>1 FACILITIES AND ACCREDITATIONS</b>		<b>6</b>
<b>1.1. FACILITIES</b>		<b>6</b>
<b>1.1.1 ACCREDITATIONS</b>		<b>6</b>
<b>1.2 MEASUREMENT UNCERTAINTY</b>		<b>6</b>
<b>2 . GENERAL INFORMATION</b>		<b>7</b>
<b>2.1 GENERAL DESCRIPTION OF EUT</b>		<b>7</b>
<b>2.2 DESCRIPTION OF TEST MODES</b>		<b>9</b>
<b>2.3 TABLE OF PARAMETERS OF TEXT SOFTWARE SETTING</b>		<b>9</b>
<b>2.4 CONFIGURATION OF SYSTEM UNDER TEST</b>		<b>10</b>
<b>2.5 DESCRIPTION OF SUPPORT UNITS (CONDUCTED MODE)</b>		<b>11</b>
<b>2.6 EQUIPMENTS LIST FOR ALL TEST ITEMS</b>		<b>12</b>
<b>3 . EMC EMISSION TEST</b>		<b>13</b>
<b>3.1 CONDUCTED EMISSION MEASUREMENT</b>		<b>13</b>
<b>3.1.1 POWER LINE CONDUCTED EMISSION LIMITS</b>		<b>13</b>
<b>3.1.2 TEST PROCEDURE</b>		<b>14</b>
<b>3.1.3 DEVIATION FROM TEST STANDARD</b>		<b>14</b>
<b>3.1.4 TEST SETUP</b>		<b>14</b>
<b>3.1.5 EUT OPERATING CONDITIONS</b>		<b>14</b>
<b>3.1.6 TEST RESULTS</b>		<b>15</b>
<b>3.2 RADIATED EMISSION MEASUREMENT</b>		<b>17</b>
<b>3.2.1 RADIATED EMISSION LIMITS</b>		<b>17</b>
<b>3.2.2 TEST PROCEDURE</b>		<b>18</b>
<b>3.2.3 DEVIATION FROM TEST STANDARD</b>		<b>18</b>
<b>3.2.4 TEST SETUP</b>		<b>19</b>
<b>3.2.5 EUT OPERATING CONDITIONS</b>		<b>20</b>
<b>3.2.6 TEST RESULTS (BELOW 30 MHZ)</b>		<b>21</b>
<b>3.2.7 TEST RESULTS (BETWEEN 30M – 1000 MHZ)</b>		<b>22</b>
<b>3.2.8 TEST RESULTS (ABOVE 1000 MHZ)</b>		<b>24</b>
<b>3.2.9 TEST RESULTS (RESTRICTED BANDS REQUIREMENTS)</b>		<b>30</b>
<b>4 . NUMBER OF HOPPING CHANNEL</b>		<b>36</b>
<b>4.1 APPLIED PROCEDURES / LIMIT</b>		<b>36</b>
<b>4.1.1 TEST PROCEDURE</b>		<b>36</b>
<b>4.1.2 DEVIATION FROM STANDARD</b>		<b>36</b>

<b>Table of Contents</b>	<b>Page</b>
4.1.3 TEST SETUP	36
4.1.4 EUT OPERATION CONDITIONS	36
4.1.5 TEST RESULTS	37
<b>5 . AVERAGE TIME OF OCCUPANCY</b>	<b>38</b>
5.1 APPLIED PROCEDURES / LIMIT	38
5.1.1 TEST PROCEDURE	38
5.1.2 DEVIATION FROM STANDARD	38
5.1.3 TEST SETUP	39
5.1.4 EUT OPERATION CONDITIONS	39
5.1.5 TEST RESULTS	40
<b>6 . HOPPING CHANNEL SEPARATION MEASUREMENT</b>	<b>46</b>
6.1 APPLIED PROCEDURES / LIMIT	46
6.1.1 TEST PROCEDURE	46
6.1.2 DEVIATION FROM STANDARD	46
6.1.3 TEST SETUP	46
6.1.4 EUT OPERATION CONDITIONS	46
6.1.5 TEST RESULTS	47
<b>7 . BANDWIDTH TEST</b>	<b>53</b>
7.1 APPLIED PROCEDURES / LIMIT	53
7.1.1 TEST PROCEDURE	53
7.1.2 DEVIATION FROM STANDARD	53
7.1.3 TEST SETUP	53
7.1.4 EUT OPERATION CONDITIONS	53
7.1.5 TEST RESULTS	54
<b>8 . PEAK OUTPUT POWER TEST</b>	<b>60</b>
8.1 APPLIED PROCEDURES / LIMIT	60
8.1.1 TEST PROCEDURE	60
8.1.2 DEVIATION FROM STANDARD	60
8.1.3 TEST SETUP	60
8.1.4 EUT OPERATION CONDITIONS	60
8.1.5 TEST RESULTS	61
<b>9. Antenna Application</b>	<b>62</b>
9.1 Antenna requirement	66
9.2 Result	66
<b>10. EUT TEST PHOTO</b>	<b>66</b>
<b>11 PHOTOGRAPHS OF EUT</b>	<b>67</b>
<b>APPENDIX-PHOTOGRAPHS OF EUT CONSTRUCTIONAL DETAILS</b>	

## 1. SUMMARY OF TEST RESULTS

Test procedures according to the technical standards:

<b>FCC Part15 (15.247) , Subpart C</b>			
<b>Standard Section</b>	<b>Test Item</b>	<b>Judgment</b>	<b>Remark</b>
15.207	Conducted Emission	PASS	
15.247(a)(1)	Hopping Channel Separation	PASS	
15.247(b)(1)	Peak Output Power	PASS	
15.247(c)	Radiated Spurious Emission	PASS	
15.247(a)(iii)	Number of Hopping Frequency	PASS	
15.247(a)(iii)	Dwell Time	PASS	
15.247(a)(1)	Bandwidth	PASS	
15.205	Band Edge Emission	PASS	
15.203	Antenna Requirement	PASS	

**NOTE:**

(1) "N/A" denotes test is not applicable in this Test Report

## 1 FACILITIES AND ACCREDITATIONS

### 1.1. FACILITIES

All measurement facilities used to collect the measurement data are located at  
**East 5/Block 4 Anhua Industrial Zone, No.8, Tairan Road, Chegongmiao, Futian District, Shenzhen, Guangdong, China**

The sites are constructed in conformance with the requirements of ANSI C63.4 and CISPR Publication 22. All receiving equipment conforms to CISPR Publication 16-1, "Radio Interference Measuring Apparatus and Measurement Methods."

#### 1.1.1 ACCREDITATIONS

The testing quality ability of our laboratory meet with "Quality Law of People's Republic of China" Clause 19.

The testing quality system of our laboratory meet with ISO/IEC-17025 requirements, which is approved by CNAL. This approval result is accepted by MRA of APLAC.

Our test facility is recognized, certified, or accredited by the following organizations:

CNAL-LAB Code: L2292

The EMC Laboratory has been assessed and in compliance with CNAL/AC01:2002 accreditation criteria for testing Laboratories (identical to ISO/IEC 17025:1999 General Requirements) for the Competence of testing Laboratories.

#### FCC-Registration No.: 899988

The EMC Laboratory has been registered and fully described in a report filed with the (FCC) Federal Communications commission. The acceptance letter from the FCC is maintained in our files. Registration No.: 899988.

#### IC- Registration No.: IC5205A-01

The EMC Laboratory has been registered and fully described in a report filed with the (IC) Industry Canada. The acceptance letter from the IC is maintained in our files. Registration IC No.: 5205A-01.

### 1.2 MEASUREMENT UNCERTAINTY

The reported uncertainty of measurement  $y \pm U$ , where expanded uncertainty  $U$  is based on a standard uncertainty multiplied by a coverage factor of  $k=2$ , providing a level of confidence of approximately **95 %**.

No.	Item	Uncertainty
1	Conducted Emission Test	$\pm 3.6\text{dB}$
2	RF power,conducted	$\pm 0.16\text{dB}$
3	Spurious emissions,conducted	$\pm 0.21\text{dB}$
4	All emissions,radiated(<1G)	$\pm 4.7\text{dB}$
5	All emissions,radiated(>1G)	$\pm 4.7\text{dB}$
6	Temperature	$\pm 0.5^\circ\text{C}$
7	Humidity	$\pm 2\%$

## 2. GENERAL INFORMATION

### 2.1 GENERAL DESCRIPTION OF EUT

<b>Product</b>	Multimedia Speaker System
<b>Brand Name</b>	N/A
<b>Models</b>	IFIT-3BT
<b>Applicant</b>	Shenzhen Divoom Technology Co., Ltd.
<b>Housing material</b>	Plastic
<b>EUT Type</b>	<input checked="" type="checkbox"/> Engineering Sample. <input type="checkbox"/> Product Sample, <input type="checkbox"/> Mass Product Sample.
<b>Bluetooth Version</b>	Bluetooth specification V2.1+EDR
<b>Antenna Type</b>	PCB Antenna
<b>EUT Power Rating</b>	Battery: 3.7V Charging Input: 5V
<b>Temperature Range(Operating)</b>	+15 ~+ 35°C
<b>Type of the Equipment</b>	Combined Equipment
<b>Operating Frequency</b>	2402MHz to 2480MHz
<b>Number of Channels</b>	79 Channels
<b>Channel Separation</b>	1MHz
<b>Modulation Technology</b>	GFSK(1Mbps) $\pi$ /4-DQPSK(2Mbps) 8-DPSK(3Mbps)
<b>Antenna Gain</b>	0.5dBi Max.

Note:

1. For a more detailed features description, please refer to the manufacturer's specifications or the User's Manual.

2.

Channel List					
Channel	Frequency (MHz)	Channel	Frequency (MHz)	Channel	Frequency (MHz)
00	2402	27	2429	54	2456
01	2403	28	2430	55	2457
02	2404	29	2331	56	2458
03	2405	30	2432	57	2459
04	2406	31	2433	58	2460
05	2407	32	2434	59	2461
06	2408	33	2435	60	2462
07	2409	34	2436	61	2463
08	2410	35	2437	62	2464
09	2411	36	2438	63	2465
10	2412	37	2439	64	2466
11	2413	38	2440	65	2467
12	2414	39	2441	66	2468
13	2415	40	2442	67	2469
14	2416	41	2443	68	2470
15	2417	42	2444	69	2471
16	2418	43	2445	70	2472
17	2419	44	2446	71	2473
18	2420	45	2447	72	2474
19	2421	46	2448	73	2475
20	2422	47	2449	74	2476
21	2423	48	2450	75	2477
22	2424	49	2451	76	2478
23	2425	50	2452	77	2479
24	2426	51	2453	78	2480
25	2427	52	2454		
26	2428	53	2455		

3.

Table for Filed Antenna

Ant	Brand	Model Name	Antenna Type	Connector	Gain (dBi)	NOTE
1	N/A	N/A	PCB Antenna	NA	0.5	BT Antenna



## 2.2 DESCRIPTION OF TEST MODES

To investigate the maximum EMI emission characteristics generates from EUT, the test system was pre-scanning tested base on the consideration of following EUT operation mode or test configuration mode which possible have effect on EMI emission level. Each of these EUT operation mode(s) or test configuration mode(s) mentioned above was evaluated respectively.

Pretest Mode	Description
Mode 1	CH00
Mode 2	CH39
Mode 3	CH78

For Conducted Emission	
Final Test Mode	Description
Mode 3	CH78

For Radiated Emission	
Final Test Mode	Description
Mode 1	CH00
Mode 2	CH39
Mode 3	CH78

Note:

- (1) The measurements are performed at the highest, middle, lowest available channels.
- (2) The EUT use new battery.
- (3)The data rate were set in 1Mbps,2 Mbps,3 Mbps for radiated emission due to the highest RF output power.

## 2.3 TABLE OF PARAMETERS OF TEXT SOFTWARE SETTING

During testing channel & power controlling software provided by the customer was used to control the operating channel as well as the output power level. The RF output power selection is for the setting of RF output power expected by the customer and is going to be fixed on the firmware of the final end product power parameters of FHSS

Test software Version	Test program:CSR		
Frequency	2402 MHz	2441 MHz	2480 MHz
Parameters(1Mbps)	DEF	DEF	DEF
Parameters(2Mbps)	DEF	DEF	DEF
Parameters(3Mbps)	DEF	DEF	DEF

## 2.4 CONFIGURATION OF SYSTEM UNDER TEST

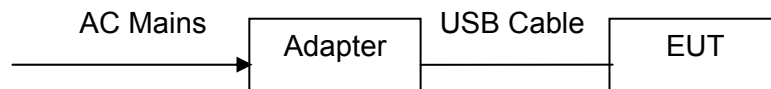

(EUT: Multimedia Speaker System)

## 2.5 DESCRIPTION OF SUPPORT UNITS (CONDUCTED MODE)

The EUT has been tested as an independent unit together with other necessary accessories or support units. The following support units or accessories were used to form a representative test configuration during the tests.

Item	Equipment	Mfr/Brand	Model/Type No.	Series No.	Note
1	Multimedia Speaker System	Shenzhen Divoom Technology Co., Ltd.	IFIT-3BT	N/A	EUT
2	Adapter	Tecno	TMU13	N/A	AE

Note:

- (1) The support equipment was authorized by Declaration of Confirmation.
- (2) For detachable type I/O cable should be specified the length in cm in 『Length』 column.
- (3) “YES” is means “shielded” “with core”; “NO” is means “unshielded” “without core”.

**2.6 EQUIPMENTS LIST FOR ALL TEST ITEMS**

Kind of Equipment	Manufacturer	Type No.	Serial No.	Last Calibrated	Calibrated until
ESPI Test Receiver	R&S	ESPI	100379	2012-04-26	2013-04-25
TWO Line-V-NETW	R&S	EZH3-Z5	100294	2012-04-26	2013-04-25
TWO Line-V-NETW	R&S	EZH3-Z5	100253	2012-04-26	2013-04-25
Ultra Broadband ANT	R&S	HL562	100157	2012-04-26	2013-04-25
Impuls-Begrenzer	R&S	ESH3-Z2	100281	2012-04-26	2013-04-25
System Controller	CT	SC100	-	2012-04-26	2013-04-25
Bilog Antenna	Chase	CBL6111C	2576	2012-04-26	2013-04-25
Loop Antenna	EMCO	6502	00042960	2012-04-26	2013-04-25
ESPI Test Receiver	R&S	ESI26	838786/013	2012-04-26	2013-04-25
Horn Antenna	SCHWARZBECK	BBHA 9170	BBHA9170265	2012-04-26	2013-04-25
Horn Antenna	SCHWARZBECK	BBHA 9120D	9120D-631	2012-04-26	2013-04-25
Power meter	Anritsu	ML2487A	6K00003613	2012-04-26	2013-04-25
Power sensor	Anritsu	MA2491A	32263	2012-04-26	2013-04-25
Bilog Antenna	Schwarebeck	VULB9163	9163/340	2012-04-26	2013-04-25
LISN	AFJ	NSLK8126	8126453	2012-04-26	2013-04-25
LISN	AFJ	LS16C	10010947251	2012-04-26	2013-04-25
EMI Test Receiver	R&S	ESCS30	100139	2012-04-26	2013-04-25

### 3. EMC EMISSION TEST

#### 3.1 CONDUCTED EMISSION MEASUREMENT

##### 3.1.1 POWER LINE CONDUCTED EMISSION Limits (Frequency Range 150KHz-30MHz)

FREQUENCY (MHz)	Class A (dBuV)		Class B (dBuV)		Standard
	Quasi-peak	Average	Quasi-peak	Average	
0.15 -0.5	79.00	66.00	66 - 56 *	56 - 46 *	CISPR
0.50 -5.0	73.00	60.00	56.00	46.00	CISPR
5.0 -30.0	73.00	60.00	60.00	50.00	CISPR

0.15 -0.5	79.00	66.00	66 - 56 *	56 - 46 *	FCC
0.50 -5.0	73.00	60.00	56.00	46.00	FCC
5.0 -30.0	73.00	60.00	60.00	50.00	FCC

Note:

- (1) The tighter limit applies at the band edges.
- (2) The limit of " \* " marked band means the limitation decreases linearly with the logarithm of the frequency in the range.

The following table is the setting of the receiver

Receiver Parameters	Setting
Attenuation	10 dB
Start Frequency	0.15 MHz
Stop Frequency	30 MHz
IF Bandwidth	9 kHz

### 3.1.2 TEST PROCEDURE

- a. The EUT was placed 0.4 meters from the horizontal ground plane with EUT being connected to the power mains through a line impedance stabilization network (LISN). All other support equipments powered from additional LISN(s). The LISN provide 50 Ohm/ 50uH of coupling impedance for the measuring instrument.
- b. Interconnecting cables that hang closer than 40 cm to the ground plane shall be folded back and forth in the center forming a bundle 30 to 40 cm long.
- c. I/O cables that are not connected to a peripheral shall be bundled in the center. The end of the cable may be terminated, if required, using the correct terminating impedance. The overall length shall not exceed 1 m.
- d. LISN at least 80 cm from nearest part of EUT chassis.
- e. For the actual test configuration, please refer to the related Item –EUT Test Photos.

### 3.1.3 DEVIATION FROM TEST STANDARD

No deviation

### 3.1.4 TEST SETUP

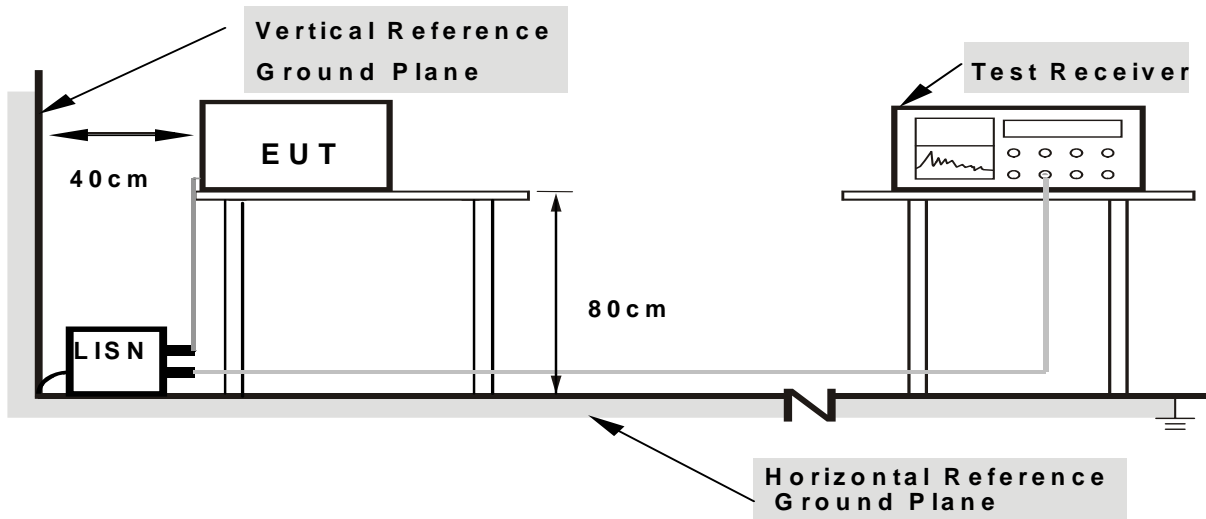

- Note:** 1. Support units were connected to second LISN.  
2. Both of LISNs (AMN) are 80 cm from EUT and at least 80 cm from other units and other metal planes

### 3.1.5 EUT OPERATING CONDITIONS

The EUT was configured for testing in a typical fashion (as a customer would normally use it). The EUT has been programmed to continuously transmit during test. This operating condition was tested and used to collect the included data.

**3.1.6 TEST RESULTS**

EUT :	Multimedia Speaker System	Model Name :	IFIT-3BT
Temperature :	26 °C	Relative Humidity :	54%
Pressure :	1010hPa	Phase :	L
Test Voltage :	DC 5.0 V(Adapter Input AC 120 V, 60 Hz)	Test Mode :	Mode 3
Test Date	January 3, 2013		

Frequency (MHz)	Reading Level (dBµV)	Correct Factor (dB)	Measure-ment (dBµV)	Limits (dBµV)	Margin (dB)	Detector Type
0.7019	20.32	10.89	31.21	56.00	24.79	QP
0.7019	0.93	10.89	11.82	46.00	34.18	AVG
1.0180	16.24	10.75	26.99	56.00	29.01	QP
1.0180	1.31	10.75	9.44	46.00	36.56	AVG
18.5700	17.91	10.49	28.40	60.00	31.60	QP
18.5700	1.64	10.49	8.85	50.00	41.15	AVG

Remark:

1. All readings are Quasi-Peak and Average values.
2. Factor = Insertion Loss + Cable Loss.
3. The mode 1,2,3 have been investigated, and only worst mode is presented in this report.

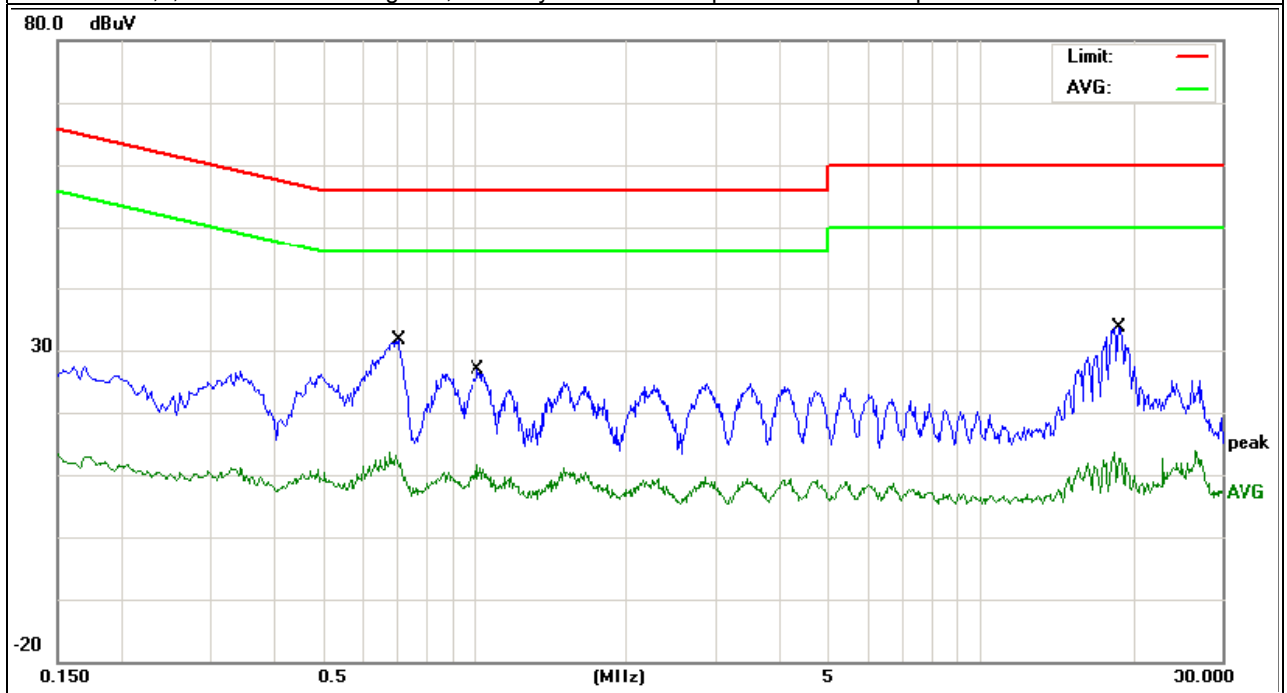

EUT :	Multimedia Speaker System	Model Name :	IFIT-3BT
Temperature :	26 °C	Relative Humidity :	54%
Pressure :	1010hPa	Phase :	N
Test Voltage :	DC 5.0 V(Adapter Input AC 120 V, 60 Hz)	Test Mode :	Mode 3
Test Date	January 3, 2013		

Frequency (MHz)	Reading Level (dBμV)	Correct Factor (dB)	Measure-ment (dBμV)	Limits (dBμV)	Margin (dB)	Detector Type
0.6979	2.84	10.90	13.74	46.00	32.26	QP
0.7059	21.34	10.87	32.21	56.00	23.79	AVG
1.5100	15.67	10.73	26.40	56.00	29.60	QP
1.5100	1.79	10.73	12.52	46.00	33.48	AVG
18.3298	23.61	10.48	34.09	60.00	25.91	QP
18.3298	3.72	10.48	14.20	50.00	35.80	AVG

Remark:

1. All readings are Quasi-Peak and Average values.
2. Factor = Insertion Loss + Cable Loss.
3. The mode 1,2,3 have been investigated, and only worst mode is presented in this report.

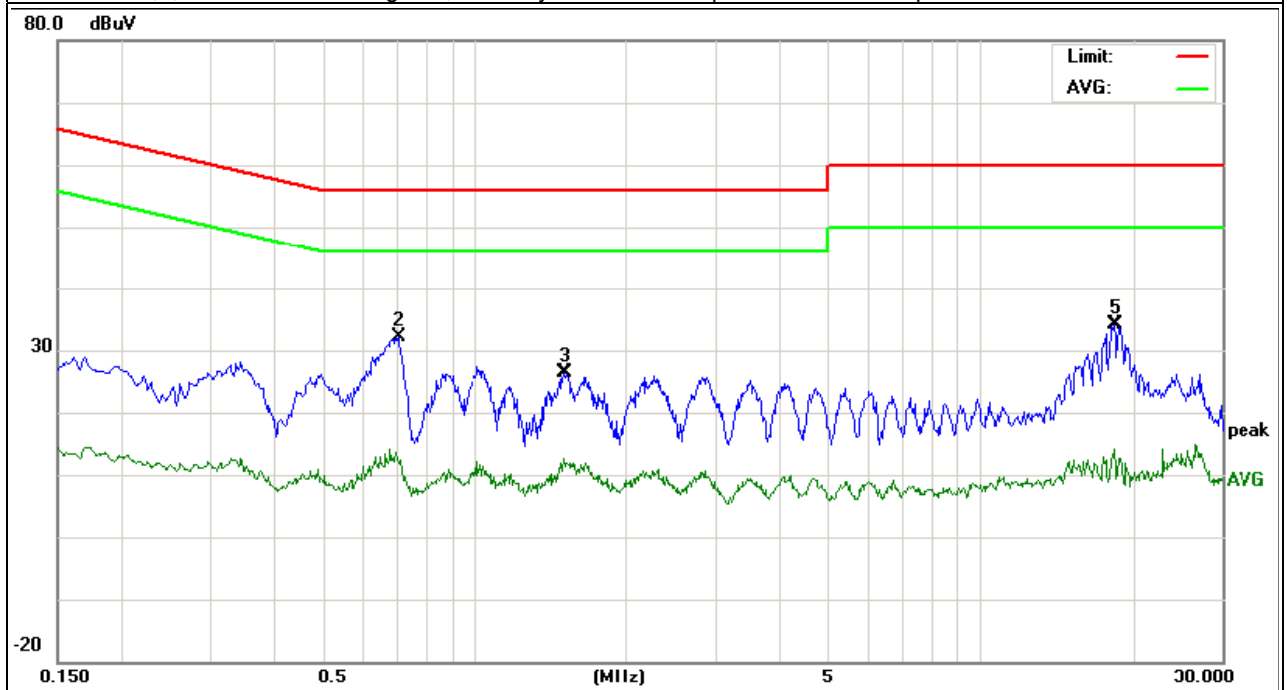



### 3.2 RADIATED EMISSION MEASUREMENT

#### 3.2.1 RADIATED EMISSION LIMITS (Frequency Range 9kHz-1000MHz)

20dBc in any 100 kHz bandwidth outside the operating frequency band. In case the emission fall within the restricted band specified on 15.205(a), then the 15.209(a) limit in the table below has to be followed.

Frequencies (MHz)	Field Strength (micorvolts/meter)	Measurement Distance (meters)
0.009~0.490	2400/F(KHz)	300
0.490~1.705	24000/F(KHz)	30
1.705~30.0	30	30
30~88	100	3
88~216	150	3
216~960	200	3
Above 960	500	3

#### LIMITS OF RADIATED EMISSION MEASUREMENT (Above 1000MHz)

FREQUENCY (MHz)	PEAK	AVERAGE
Above 1000	74	54

Notes:

- (1) The limit for radiated test was performed according to FCC PART 15C.
- (2) The tighter limit applies at the band edges.
- (3) Emission level (dBuV/m)=20log Emission level (uV/m).

#### FREQUENCY RANGE OF RADIATED MEASUREMENT (For unintentional radiators)

Highest frequency generated or Upper frequency of measurement used in the device or on which the device operates or tunes (MHz)	Range (MHz)
Below 1.705	30
1.705 – 108	1000
108 – 500	2000
500 – 1000	5000
Above 1000	5 <sup>th</sup> harmonic of the highest frequency or 40 GHz, whichever is lower

Spectrum Parameter	Setting
Attenuation	Auto
Start Frequency	1000 MHz
Stop Frequency	10th carrier harmonic
RB / VB (emission in restricted band)	1 MHz / 1 MHz for Peak, 1 MHz / 10Hz for Average

Receiver Parameter	Setting
Attenuation	Auto
Start ~ Stop Frequency	9kHz~150kHz / RB 200Hz for QP
Start ~ Stop Frequency	150kHz~30MHz / RB 9kHz for QP
Start ~ Stop Frequency	30MHz~1000MHz / RB 120kHz for QP

### 3.2.2 TEST PROCEDURE

- a. The measuring distance of at 3 m shall be used for measurements at frequency up to 1GHz. For frequencies above 1GHz, any suitable measuring distance may be used.
- b. The EUT was placed on the top of a rotating table 0.8 meters above the ground at a 3 meter open area test site. The table was rotated 360 degrees to determine the position of the highest radiation.
- c. The height of the equipment or of the substitution antenna shall be 0.8 m; the height of the test antenna shall vary between 1 m to 4 m. Both horizontal and vertical polarizations of the antenna are set to make the measurement.
- d. The initial step in collecting conducted emission data is a spectrum analyzer peak detector mode pre-scanning the measurement frequency range. Significant peaks are then marked and then Quasi Peak detector mode re-measured.
- e. If the Peak Mode measured value compliance with and lower than Quasi Peak Mode Limit, the EUT shall be deemed to meet QP Limits and then no additional QP Mode measurement performed.
- f. For the actual test configuration, please refer to the related Item –EUT Test Photos.

Note:

Both horizontal and vertical antenna polarities were tested and performed pretest to three orthogonal axis. The worst case emissions were reported

### 3.2.3 DEVIATION FROM TEST STANDARD

No deviation

### 3.2.4 TEST SETUP

(A) Radiated Emission Test-Up Frequency Below 30MHz

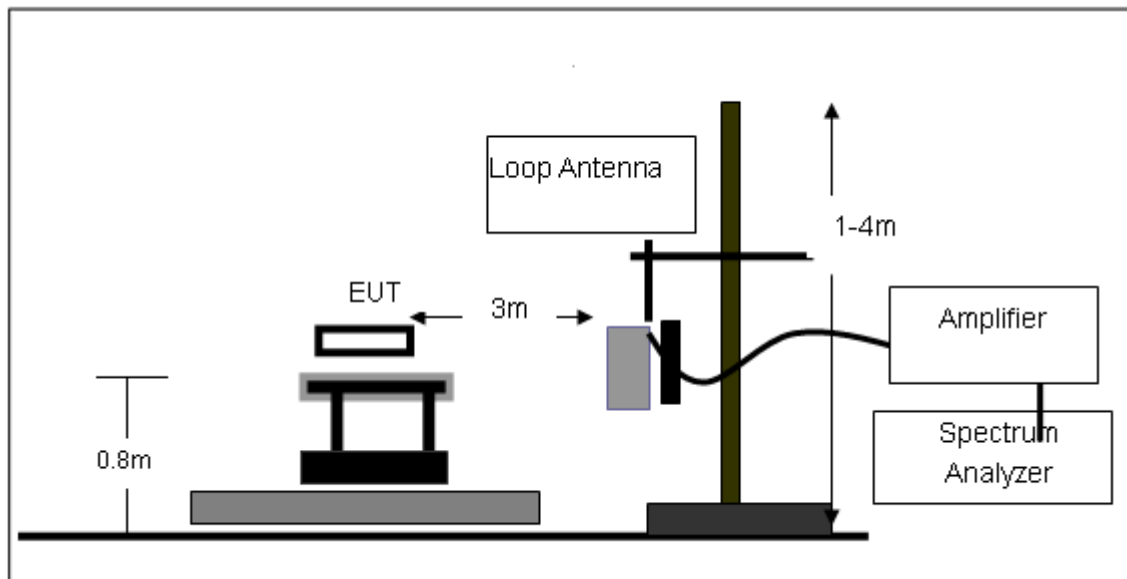

(B) Radiated Emission Test-Up Frequency 30MHz~1GHz

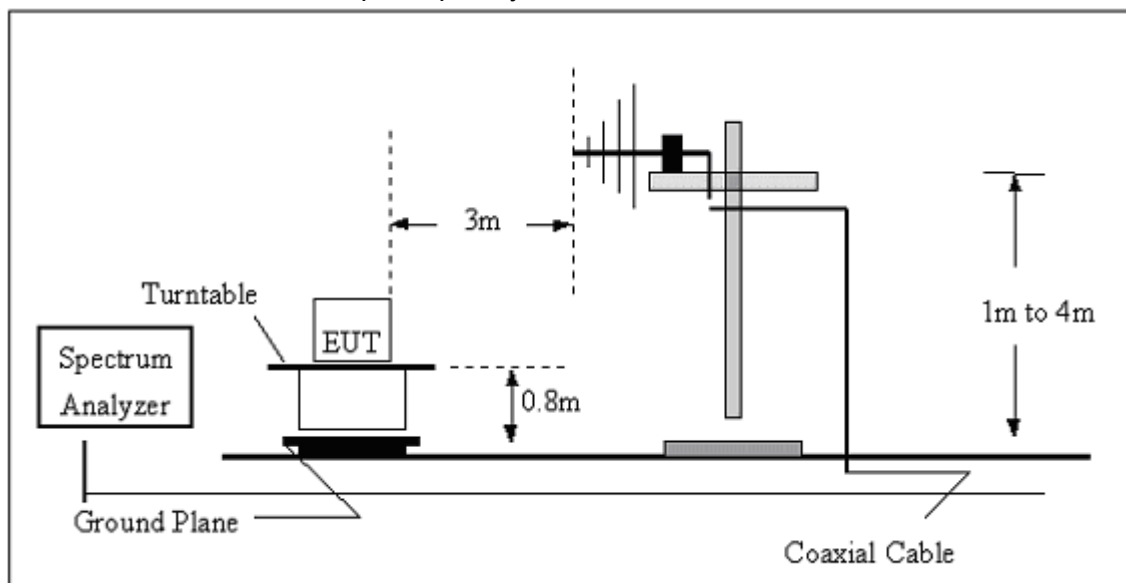

(C) Radiated Emission Test-Up Frequency Above 1GHz

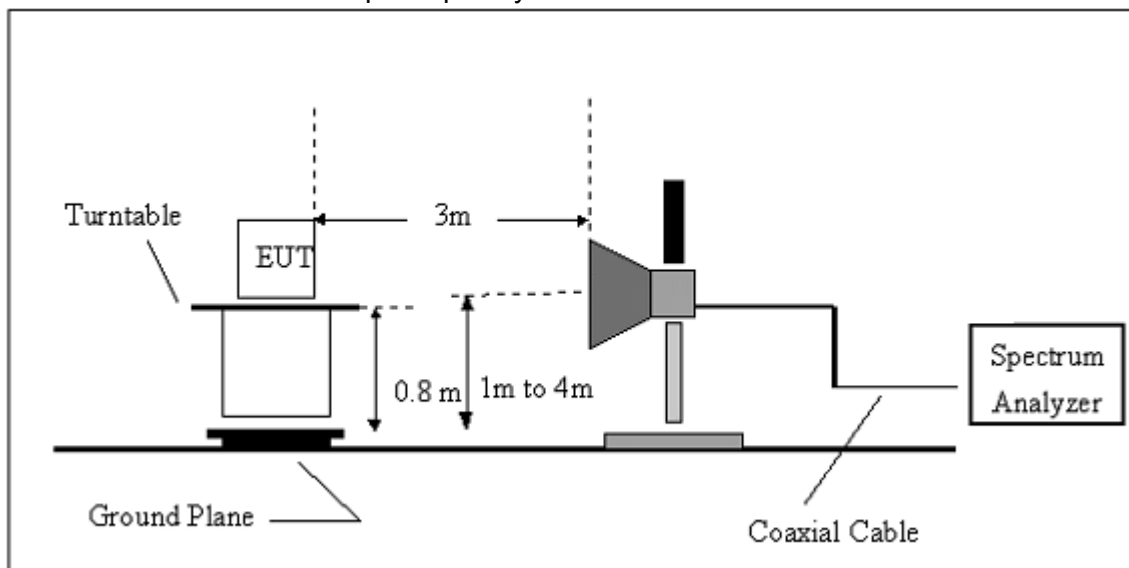

**3.2.5 EUT OPERATING CONDITIONS**

The EUT tested system was configured as the statements of 2.4 Unless otherwise a special operating condition is specified in the follows during the testing.

**3.2.6 TEST RESULTS (BELOW 30 MHZ)**

EUT :	Multimedia Speaker System	Model Name :	IFIT-3BT
Temperature :	20 °C	Relative Humidity :	48%
Pressure :	1010 hPa	Polarization :	---
Test Voltage :	DC 5.0 V(Adapter Input AC 120 V, 60 Hz)	Test Date	January 3, 2013
Test Mode :	TX		

Freq. (MHz)	Reading (dBuV/m)	Limit (dBuV/m)	Margin (dB)	State P/F
--	--	--	--	PASS
--	--	--	--	PASS

**NOTE:**

The amplitude of spurious emissions which are attenuated by more than 20dB below the permissible value has no need to be reported.

Distance extrapolation factor =  $20 \log (\text{specific distance}/\text{test distance})(\text{dB})$ ;

Limit line = specific limits(dBuv) + distance extrapolation factor.

All the x/y/z orientation has been investigated, and only worst case is presented in this report.

**3.2.7 TEST RESULTS (BETWEEN 30M – 1000 MHZ)**

EUT :	Multimedia Speaker System	Model Name :	IFIT-3BT
Temperature :	20 °C	Relative Humidity :	48%
Pressure :	1010 hPa	Polarization :	Horizontal
Test Voltage :	DC 5.0 V(Adapter Input AC 120 V, 60 Hz)	Test Date	January 3, 2013
Test Mode :	Mode 3		

Frequency (MHz)	Meter Reading (dBµV)	Factor (dB)	Emission Level (dBµV/m)	Limits (dBµV/m)	Margin (dB)	Detector Type
30.0000	21.05	0.20	21.25	40.00	18.75	QP
288.0200	23.35	3.84	19.51	46.00	26.49	QP
374.3500	23.16	2.71	20.45	46.00	25.55	QP
559.6200	22.86	2.95	25.81	46.00	20.19	QP
652.7400	22.79	5.09	27.88	46.00	18.12	QP

Remark:  
 Factor = Antenna Factor + Cable Loss – Pre-amplifier.  
 All interfaces was connected, and BT TX mode was link.  
 All the x/y/z orientation has been investigated, and only worst case is presented in this report.  
 All the modes have been investigated, and only worst mode is presented in this report.

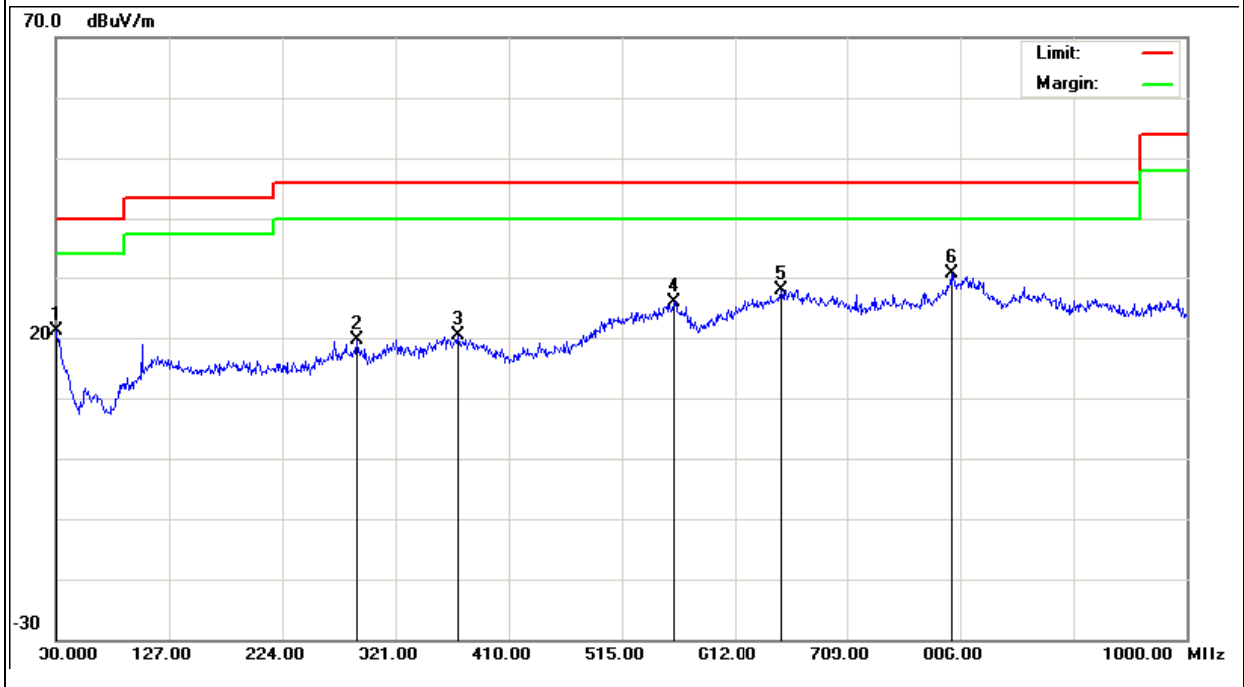

EUT :	Multimedia Speaker System	Model Name :	IFIT-3BT
Temperature :	20 °C	Relative Humidity :	48%
Pressure :	1010 hPa	Polarization :	Vertical
Test Voltage :	DC 5.0 V(Adapter Input AC 120 V, 60 Hz)	Test Date	January 3, 2013
Test Mode :	Mode 3		

Frequency (MHz)	Meter Reading (dBμV)	Factor (dB)	Emission Level (dBμV/m)	Limits (dBμV/m)	Margin (dB)	Detector Type
30.0000	22.06	-2.95	19.11	40.00	20.89	QP
163.8600	22.58	-3.68	18.90	43.50	24.60	QP
323.9100	23.58	-3.30	20.28	46.00	25.72	QP
520.8200	22.52	1.08	23.60	46.00	22.40	QP
661.4700	22.64	5.69	28.33	46.00	17.67	QP
804.0600	24.39	5.66	30.05	46.00	15.95	QP

Remark:

Factor = Antenna Factor + Cable Loss – Pre-amplifier.

All interfaces was connected, and BT TX mode was link.

All the x/y/z orientation has been investigated, and only worst case is presented in this report.

All the modes have been investigated, and only worst mode is presented in this report.

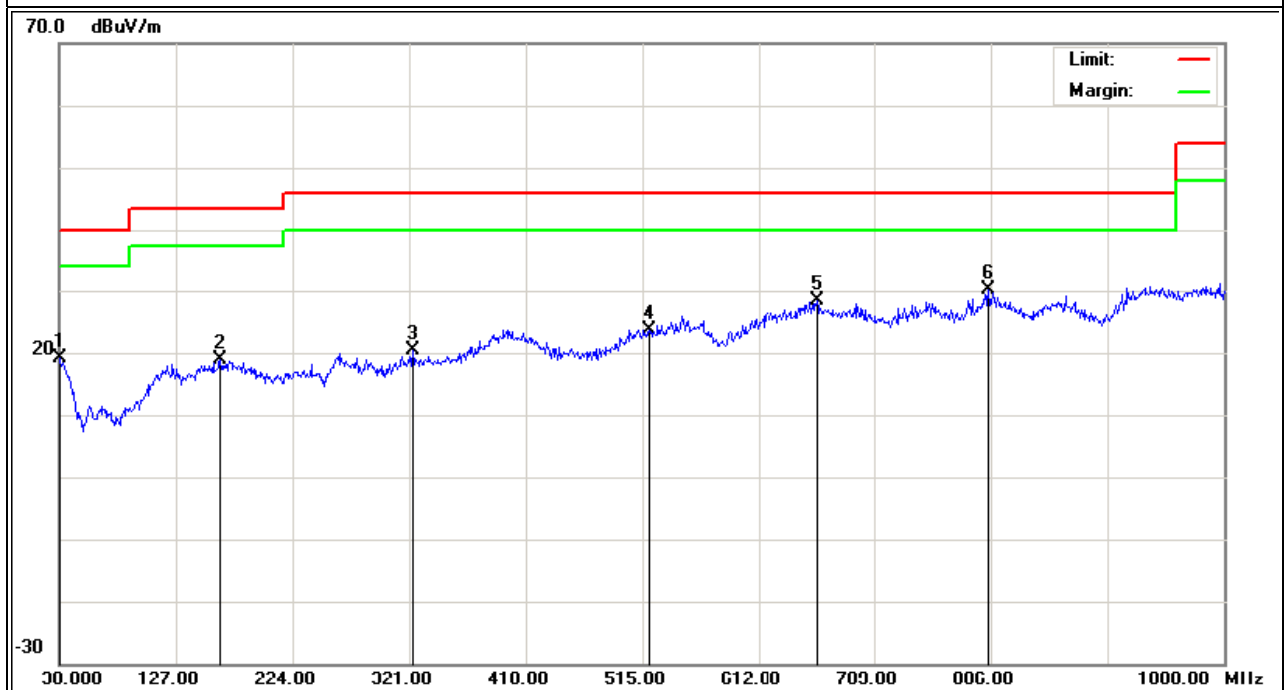

### 3.2.8 TEST RESULTS (ABOVE 1000 MHZ)

EUT :	Multimedia Speaker System	Model Name :	IFIT-3BT
Temperature :	20 °C	Relative Humidity :	48%
Pressure :	1010 hPa	Test Mode :	TX 2402MHz CH 00(1Mbps)
Test Voltage :	DC 5.0 V(Adapter Input AC 120 V, 60 Hz)	Test Date	January 4, 2013

Freq. (MHz)	Ant.Pol H/V	Emission Level(dBuV)		Limit 3m(dBuV/m)		Over(dB)	
		PK	AV	PK	AV	PK	AV
5192.102	V	41.76	30.14	74	54	-24.24	-15.86
9514.284	V	42.86	29.43	74	54	-31.14	-24.57
9834.662	V	45.88	27.15	74	54	-20.12	-18.85
5213.527	H	58.44	48.60	74	54	-15.56	-5.40
9887.977	H	54.45	45.57	74	54	-19.55	-8.43

Remark:  
 All emissions not reported were more than 20dB below the specified limit or in the noise floor.  
 Factor = Antenna Factor + Cable Loss – Pre-amplifier.  
 All the x/y/z orientation has been investigated, and only worst case is presented in this report.

EUT :	Multimedia Speaker System	Model Name :	IFIT-3BT
Temperature :	20 °C	Relative Humidity :	48%
Pressure :	1010 hPa	Test Mode :	TX 2441MHz CH 39(1Mbps)
Test Voltage :	DC 5.0 V(Adapter Input AC 120 V, 60 Hz)	Test Date	January 4, 2013

Freq. (MHz)	Ant.Pol H/V	Emission Level(dBuV)		Limit 3m(dBuV/m)		Over(dB)	
		PK	AV	PK	AV	PK	AV
9863.402	V	56.45	45.17	74	54	-17.55	-8.83
10911.284	V	53.57	43.07	74	54	-20.43	-10.93
5189.132	H	57.19	48.64	74	54	-16.81	-5.36
5558.827	H	57.32	48.54	74	54	-16.68	-5.46
9657.717	H	53.22	45.71	74	54	-20.78	-8.29

Remark:  
 All emissions not reported were more than 20dB below the specified limit or in the noise floor.  
 Factor = Antenna Factor + Cable Loss – Pre-amplifier.  
 All the x/y/z orientation has been investigated, and only worst case is presented in this report.



EUT :	Multimedia Speaker System	Model Name :	IFIT-3BT
Temperature :	20 °C	Relative Humidity :	48%
Pressure :	1010 hPa	Test Mode :	TX 2480MHz CH 78(1Mbps)
Test Voltage :	DC 5.0 V(Adapter Input AC 120 V, 60 Hz)	Test Date	January 4, 2013

Freq. (MHz)	Ant.Pol. H/V	Emission Level(dBuV)		Limit 3m(dBuV/m)		Over(dB)	
		PK	AV	PK	AV	PK	AV
5230.372	V	60.67	49.12	74	54	-13.33	-4.88
7269.514	V	57.59	47.28	74	54	-16.41	-6.72
8692.912	V	56.59	47.64	74	54	-17.41	-6.36
9942.727	V	54.01	44.76	74	54	-19.99	-9.24
7826.417	H	57.37	46.73	74	54	-16.63	-7.27
10019.255	H	57.07	44.97	74	54	-16.94	-9.04

Remark:

All emissions not reported were more than 20dB below the specified limit or in the noise floor.  
 Factor = Antenna Factor + Cable Loss – Pre-amplifier.  
 All the x/y/z orientation has been investigated, and only worst case is presented in this report.

EUT :	Multimedia Speaker System	Model Name :	IFIT-3BT
Temperature :	20 °C	Relative Humidity :	48%
Pressure :	1010 hPa	Test Mode :	TX 2402MHz CH 00(2Mbps)
Test Voltage :	DC 5.0 V(Adapter Input AC 120 V, 60 Hz)	Test Date	January 4, 2013

Freq. (MHz)	Ant.Pol. H/V	Emission Level(dBuV)		Limit 3m(dBuV/m)		Over(dB)	
		PK	AV	PK	AV	PK	AV
5225.142	V	58.29	48.35	74	54	-15.71	-5.65
9855.704	V	55.50	44.43	74	54	-18.50	-9.57
10794.692	V	55.95	43.24	74	54	-18.05	-10.76
5172.377	H	59.19	49.36	74	54	-14.81	-4.64
7167.487	H	54.21	47.60	74	54	-19.79	-6.40
9964.585	H	53.29	44.51	74	54	-20.72	-9.50

**Remark:**

All emissions not reported were more than 20dB below the specified limit or in the noise floor.  
 Factor = Antenna Factor + Cable Loss – Pre-amplifier.  
 All the x/y/z orientation has been investigated, and only worst case is presented in this report.

EUT :	Multimedia Speaker System	Model Name :	IFIT-3BT
Temperature :	20 °C	Relative Humidity :	48%
Pressure :	1010 hPa	Test Mode :	TX 2441MHz CH 39(2Mbps)
Test Voltage :	DC 5.0 V(Adapter Input AC 120 V, 60 Hz)	Test Date	January 4, 2013

Freq. (MHz)	Ant.Pol. H/V	Emission Level(dBuV)		Limit 3m(dBuV/m)		Over(dB)	
		PK	AV	PK	AV	PK	AV
5230.052	V	56.22	48.28	74	54	-17.78	-5.72
9855.604	V	56.70	47.18	74	54	-17.30	-6.82
10797.822	V	52.67	44.25	74	54	-21.33	-9.75
5168.207	H	59.16	48.44	74	54	-14.84	-5.56
7168.387	H	57.29	47.41	74	54	-16.71	-6.59
9966.915	H	54.32	43.30	74	54	-19.69	-10.71

**Remark:**

All emissions not reported were more than 20dB below the specified limit or in the noise floor.  
 Factor = Antenna Factor + Cable Loss – Pre-amplifier.  
 All the x/y/z orientation has been investigated, and only worst case is presented in this report.

EUT :	Multimedia Speaker System	Model Name :	IFIT-3BT
Temperature :	20 °C	Relative Humidity :	48%
Pressure :	1010 hPa	Test Mode :	TX 2480MHz CH 78(2Mbps)
Test Voltage :	DC 5.0 V(Adapter Input AC 120 V, 60 Hz)	Test Date	January 4, 2013

Freq. (MHz)	Ant.Pol. H/V	Emission Level(dBuV)		Limit 3m(dBuV/m)		Over(dB)	
		PK	AV	PK	AV	PK	AV
9801.432	V	52.13	41.25	74	54	-21.87	-12.75
10852.284	V	54.48	41.81	74	54	-19.52	-12.19
11702.242	V	56.47	42.69	74	54	-17.53	-11.31
7703.487	H	49.18	39.38	74	54	-24.82	-14.62
9781.697	H	52.40	41.42	74	54	-21.60	-12.58
11266.315	H	52.02	41.79	74	54	-21.99	-12.22

Remark:

All emissions not reported were more than 20dB below the specified limit or in the noise floor.  
 Factor = Antenna Factor + Cable Loss – Pre-amplifier.  
 All the x/y/z orientation has been investigated, and only worst case is presented in this report.

EUT :	Multimedia Speaker System	Model Name :	IFIT-3BT
Temperature :	20 °C	Relative Humidity :	48%
Pressure :	1010 hPa	Test Mode :	TX 2402MHz CH 00(3Mbps)
Test Voltage :	DC 5.0 V(Adapter Input AC 120 V, 60 Hz)	Test Date	January 4, 2013

Freq. (MHz)	Ant.Pol H/V	Emission Level(dBuV)		Limit 3m(dBuV/m)		Over(dB)	
		PK	AV	PK	AV	PK	AV
5192.111	V	41.77	30.15	74	54	-24.23	-15.85
9514.255	V	42.84	29.41	74	54	-31.17	-24.60
9834.658	V	45.88	27.15	74	54	-20.12	-18.85
5213.511	H	58.42	48.58	74	54	-15.58	-5.42
9887.939	H	54.41	45.53	74	54	-19.59	-8.47

**Remark:**

All emissions not reported were more than 20dB below the specified limit or in the noise floor.  
 Factor = Antenna Factor + Cable Loss – Pre-amplifier.  
 All the x/y/z orientation has been investigated, and only worst case is presented in this report.

EUT :	Multimedia Speaker System	Model Name :	IFIT-3BT
Temperature :	20 °C	Relative Humidity :	48%
Pressure :	1010 hPa	Test Mode :	TX 2441MHz CH 39(3Mbps)
Test Voltage :	DC 5.0 V(Adapter Input AC 120 V, 60 Hz)	Test Date	January 4, 2013

Freq. (MHz)	Ant.Pol. H/V	Emission Level(dBuV)		Limit 3m(dBuV/m)		Over(dB)	
		PK	AV	PK	AV	PK	AV
9863.411	V	56.46	45.18	74	54	-17.54	-8.82
10911.255	V	53.55	43.05	74	54	-20.46	-10.96
5189.128	H	57.19	48.64	74	54	-16.81	-5.36
5558.811	H	57.30	48.52	74	54	-16.70	-5.48
9657.679	H	53.18	45.67	74	54	-20.82	-8.33

**Remark:**

All emissions not reported were more than 20dB below the specified limit or in the noise floor.  
 Factor = Antenna Factor + Cable Loss – Pre-amplifier.  
 All the x/y/z orientation has been investigated, and only worst case is presented in this report.

EUT :	Multimedia Speaker System	Model Name :	IFIT-3BT
Temperature :	20 °C	Relative Humidity :	48%
Pressure :	1010 hPa	Test Mode :	TX 2480MHz CH 78(3Mbps)
Test Voltage :	DC 5.0 V(Adapter Input AC 120 V, 60 Hz)	Test Date	January 4, 2013

Freq. (MHz)	Ant.Pol. H/V	Emission Level(dBuV)		Limit 3m(dBuV/m)		Over(dB)	
		PK	AV	PK	AV	PK	AV
5230.381	V	60.68	49.13	74	54	-13.32	-4.87
7269.485	V	57.57	47.26	74	54	-16.44	-6.75
8692.908	V	56.59	47.64	74	54	-17.41	-6.36
9942.711	V	53.99	44.74	74	54	-20.01	-9.26
7826.379	H	57.33	46.69	74	54	-16.67	-7.31
10019.244	H	57.05	44.95	74	54	-16.95	-9.05

Remark:

All emissions not reported were more than 20dB below the specified limit or in the noise floor.  
 Factor = Antenna Factor + Cable Loss – Pre-amplifier.  
 All the x/y/z orientation has been investigated, and only worst case is presented in this report.

### 3.2.9 TEST RESULTS (RESTRICTED BANDS REQUIREMENTS)

EUT :	Multimedia Speaker System	Model Name :	IFIT-3BT
Temperature :	20 °C	Relative Humidity :	48%
Pressure :	1010 hPa		
Test Voltage :	DC 5.0 V(Adapter Input AC 120 V, 60 Hz)	Test Date	January 5, 2013
Test Mode :	TX /2402MHz-1Mbps	Polarization :	Vertical

Frequency	Meter Reading	Factor	Emission Level	Limits	Margin	Detector Type
(MHz)	(dBµV)	(dB)	(dBµV/m)	(dBµV/m)	(dB)	
2400	67.81	-12.99	54.82	74	19.18	peak
2400	46.84	-12.99	33.85	54	20.15	AVG
2331	62.40	-12.99	49.41	74	25.59	peak
2331	42.45	-12.99	29.46	54	24.54	AVG

Remark:  
 Factor = Antenna Factor + Cable Loss – Pre-amplifier.  
 All the x/y/z orientation has been investigated, and only worst case is presented in this report.

EUT :	Multimedia Speaker System	Model Name :	IFIT-3BT
Temperature :	20 °C	Relative Humidity :	48%
Pressure :	1010 hPa		
Test Voltage :	DC 5.0 V(Adapter Input AC 120 V, 60 Hz)	Test Date	January 5, 2013
Test Mode :	TX /2402MHz-1Mbps	Polarization :	Horizontal

Frequency	Meter Reading	Factor	Emission Level	Limits	Margin	Detector Type
(MHz)	(dBµV)	(dB)	(dBµV/m)	(dBµV/m)	(dB)	
2400	67.68	-12.99	54.69	74	19.31	peak
2400	46.55	-12.99	33.56	54	20.44	AVG
2331	61.86	-12.99	48.87	74	25.13	peak
2331	41.55	-12.99	28.56	54	25.44	AVG

Remark:  
 Factor = Antenna Factor + Cable Loss – Pre-amplifier.  
 All the x/y/z orientation has been investigated, and only worst case is presented in this report.

EUT :	Multimedia Speaker System	Model Name :	IFIT-3BT
Temperature :	20 °C	Relative Humidity :	48%
Pressure :	1010 hPa		
Test Voltage :	DC 5.0 V(Adapter Input AC 120 V, 60 Hz)	Test Date	January 5, 2013
Test Mode :	TX /2480MHz-1Mbps	Polarization :	Vertical

Frequency	Meter Reading	Factor	Emission Level	Limits	Margin	Detector Type
(MHz)	(dBµV)	(dB)	(dBµV/m)	(dBµV/m)	(dB)	
2483.5	44.16	-12.78	31.38	74	42.62	peak

Remark:  
 Factor = Antenna Factor + Cable Loss – Pre-amplifier.  
 All the x/y/z orientation has been investigated, and only worst case is presented in this report.

EUT :	Multimedia Speaker System	Model Name :	IFIT-3BT
Temperature :	20 °C	Relative Humidity :	48%
Pressure :	1010 hPa		
Test Voltage :	DC 5.0 V(Adapter Input AC 120 V, 60 Hz)	Test Date	January 5, 2013
Test Mode :	TX /2480MHz-1Mbps	Polarization :	Horizontal

Frequency	Meter Reading	Factor	Emission Level	Limits	Margin	Detector Type
(MHz)	(dBµV)	(dB)	(dBµV/m)	(dBµV/m)	(dB)	
2483.5	46.45	-12.78	33.67	74	40.33	peak

Remark:  
 Factor = Antenna Factor + Cable Loss – Pre-amplifier.  
 All the x/y/z orientation has been investigated, and only worst case is presented in this report.

EUT :	Multimedia Speaker System	Model Name :	IFIT-3BT
Temperature :	20 °C	Relative Humidity :	48%
Pressure :	1010 hPa		
Test Voltage :	DC 5.0 V(Adapter Input AC 120 V, 60 Hz)	Test Date	January 5, 2013
Test Mode :	TX /2402MHz-2Mbps	Polarization :	Vertical

Frequency	Meter Reading	Factor	Emission Level	Limits	Margin	Detector Type
(MHz)	(dBµV)	(dB)	(dBµV/m)	(dBµV/m)	(dB)	
2400	67.3	-12.99	54.31	74	19.69	peak
2400	48.74	-12.99	35.75	54	18.25	AVG
2331	63.2	-12.99	50.21	74	23.79	peak
2331	44.88	-12.99	31.89	54	22.11	AVG

Remark:  
 Factor = Antenna Factor + Cable Loss – Pre-amplifier.  
 All the x/y/z orientation has been investigated, and only worst case is presented in this report.

EUT :	Multimedia Speaker System	Model Name :	IFIT-3BT
Temperature :	20 °C	Relative Humidity :	48%
Pressure :	1010 hPa		
Test Voltage :	DC 5.0 V(Adapter Input AC 120 V, 60 Hz)	Test Date	January 5, 2013
Test Mode :	TX /2402MHz-2Mbps	Polarization :	Horizontal

Frequency	Meter Reading	Factor	Emission Level	Limits	Margin	Detector Type
(MHz)	(dBµV)	(dB)	(dBµV/m)	(dBµV/m)	(dB)	
2400	68.5	-12.99	55.51	74	18.49	peak
2400	48.88	-12.99	45.89	54	18.11	AVG
2331	62.4	-12.99	49.41	74	24.59	peak
2331	43.11	-12.99	30.12	54	23.88	AVG

Remark:  
 Factor = Antenna Factor + Cable Loss – Pre-amplifier.  
 All the x/y/z orientation has been investigated, and only worst case is presented in this report.



EUT :	Multimedia Speaker System	Model Name :	IFIT-3BT
Temperature :	20 °C	Relative Humidity :	48%
Pressure :	1010 hPa		
Test Voltage :	DC 5.0 V(Adapter Input AC 120 V, 60 Hz)	Test Date	January 5, 2013
Test Mode :	TX /2480MHz-2Mbps	Polarization :	Vertical

Frequency	Meter Reading	Factor	Emission Level	Limits	Margin	Detector Type
(MHz)	(dBµV)	(dB)	(dBµV/m)	(dBµV/m)	(dB)	
2483.5	45.85	-12.78	33.07	74	40.93	peak

Remark:  
 Factor = Antenna Factor + Cable Loss – Pre-amplifier.  
 All the x/y/z orientation has been investigated, and only worst case is presented in this report.

EUT :	Multimedia Speaker System	Model Name :	IFIT-3BT
Temperature :	20 °C	Relative Humidity :	48%
Pressure :	1010 hPa		
Test Voltage :	DC 5.0 V(Adapter Input AC 120 V, 60 Hz)	Test Date	January 5, 2013
Test Mode :	TX /2480MHz-2Mbps	Polarization :	Horizontal

Frequency	Meter Reading	Factor	Emission Level	Limits	Margin	Detector Type
(MHz)	(dBµV)	(dB)	(dBµV/m)	(dBµV/m)	(dB)	
2483.5	47.25	-12.78	34.47	74	39.53	peak

Remark:  
 Factor = Antenna Factor + Cable Loss – Pre-amplifier.  
 All the x/y/z orientation has been investigated, and only worst case is presented in this report.

EUT :	Multimedia Speaker System	Model Name :	IFIT-3BT
Temperature :	20 °C	Relative Humidity :	48%
Pressure :	1010 hPa		
Test Voltage :	DC 5.0 V(Adapter Input AC 120 V, 60 Hz)	Test Date	January 5, 2013
Test Mode :	TX /2402MHz-3Mbps	Polarization :	Vertical

Frequency	Meter Reading	Factor	Emission Level	Limits	Margin	Detector Type
(MHz)	(dBµV)	(dB)	(dBµV/m)	(dBµV/m)	(dB)	
2400	67.65	-12.99	54.66	74	19.34	peak
2400	49.12	-12.99	36.13	54	17.87	AVG
2331	63.1	-12.99	50.11	74	23.89	peak
2331	44.3	-12.99	31.31	54	22.69	AVG

Remark:  
 Factor = Antenna Factor + Cable Loss – Pre-amplifier.  
 All the x/y/z orientation has been investigated, and only worst case is presented in this report.

EUT :	Multimedia Speaker System	Model Name :	IFIT-3BT
Temperature :	20 °C	Relative Humidity :	48%
Pressure :	1010 hPa		
Test Voltage :	DC 5.0 V(Adapter Input AC 120 V, 60 Hz)	Test Date	January 5, 2013
Test Mode :	TX /2402MHz-3Mbps	Polarization :	Horizontal

Frequency	Meter Reading	Factor	Emission Level	Limits	Margin	Detector Type
(MHz)	(dBµV)	(dB)	(dBµV/m)	(dBµV/m)	(dB)	
2400	67.45	-12.99	54.46	74	19.54	peak
2400	49.84	-12.99	36.85	54	17.15	AVG
2331	63.22	-12.99	50.23	74	23.77	peak
2331	45.11	-12.99	32.12	54	21.88	AVG

Remark:  
 Factor = Antenna Factor + Cable Loss – Pre-amplifier.  
 All the x/y/z orientation has been investigated, and only worst case is presented in this report.

EUT :	Multimedia Speaker System	Model Name :	IFIT-3BT
Temperature :	20 °C	Relative Humidity :	48%
Pressure :	1010 hPa		
Test Voltage :	DC 5.0 V(Adapter Input AC 120 V, 60 Hz)	Test Date	January 5, 2013
Test Mode :	TX /2480MHz-3Mbps	Polarization :	Vertical

Frequency	Meter Reading	Factor	Emission Level	Limits	Margin	Detector Type
(MHz)	(dBµV)	(dB)	(dBµV/m)	(dBµV/m)	(dB)	
2483.5	46.33	-12.78	33.55	74	40.45	peak

Remark:  
 Factor = Antenna Factor + Cable Loss – Pre-amplifier.  
 All the x/y/z orientation has been investigated, and only worst case is presented in this report.

EUT :	Multimedia Speaker System	Model Name :	IFIT-3BT
Temperature :	20 °C	Relative Humidity :	48%
Pressure :	1010 hPa		
Test Voltage :	DC 5.0 V(Adapter Input AC 120 V, 60 Hz)	Test Date	January 5, 2013
Test Mode :	TX /2480MHz-3Mbps	Polarization :	Horizontal

Frequency	Meter Reading	Factor	Emission Level	Limits	Margin	Detector Type
(MHz)	(dBµV)	(dB)	(dBµV/m)	(dBµV/m)	(dB)	
2483.5	47.23	-12.78	34.45	74	39.55	peak

Remark:  
 Factor = Antenna Factor + Cable Loss – Pre-amplifier.  
 All the x/y/z orientation has been investigated, and only worst case is presented in this report.

#### 4. NUMBER OF HOPPING CHANNEL

##### 4.1 APPLIED PROCEDURES / LIMIT

FCC Part15 (15.247) , Subpart C				
Section	Test Item	Limit	Frequency Range (MHz)	Result
15.247 (a)(1)(iii)	Number of Hopping Channel	≥15	2400-2483.5	PASS

Spectrum Parameters	Setting
Attenuation	Auto
Span Frequency	> Operating Frequency Range
RB	100 kHz
VB	300 kHz
Detector	Peak
Trace	Max Hold
Sweep Time	Auto

##### 4.1.1 TEST PROCEDURE

- a. The EUT was directly connected to the spectrum analyzer and antenna output port as show in the block diagram below,
- b. Spectrum Setting : RBW= 100KHz, VBW=300KHz, Sweep time = Auto.

##### 4.1.2 DEVIATION FROM STANDARD

No deviation.

##### 4.1.3 TEST SETUP



##### 4.1.4 EUT OPERATION CONDITIONS

The EUT tested system was configured as the statements of 2.4 Unless otherwise a special operating condition is specified in the follows during the testing.

**4.1.5 TEST RESULTS**

EUT :	Multimedia Speaker System	Model Name :	IFIT-3BT
Temperature :	25 °C	Relative Humidity :	60%
Pressure :	1015 hPa		
Test Voltage :	DC 5.0 V(Adapter Input AC 120 V, 60 Hz)	Test Date	January 5, 2013
Test Mode :	Hopping Mode		

Number of Hopping Channel	79
---------------------------	----

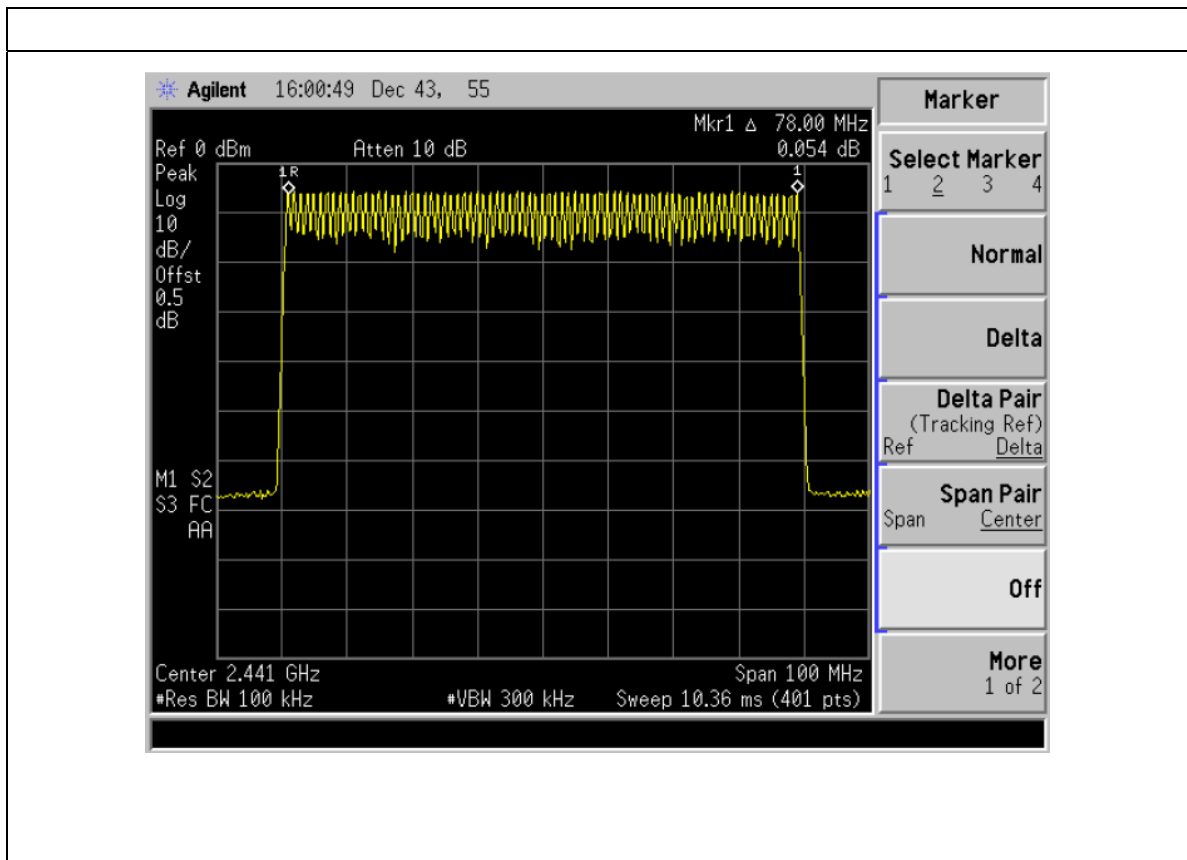

## 5. AVERAGE TIME OF OCCUPANCY

### 5.1 APPLIED PROCEDURES / LIMIT

FCC Part15 (15.247) , Subpart C				
Section	Test Item	Limit	Frequency Range (MHz)	Result
15.247 (a)(1)(iii)	Average Time of Occupancy	0.4sec	2400-2483.5	PASS

#### 5.1.1 TEST PROCEDURE

- a. The transmitter output (antenna port) was connected to the spectrum analyzer
- b. Set RBW of spectrum analyzer to 1MHz and VBW to 1MHz.
- c. Use a video trigger with the trigger level set to enable triggering only on full pulses.
- d. Sweep Time is more than once pulse time.
- e. Set the center frequency on any frequency would be measure and set the frequency span to zero span.
- f. Measure the maximum time duration of one single pulse.
- g. Set the EUT for DH5, DH3 and DH1 packet transmitting.
- h. Measure the maximum time duration of one single pulse.
- i. DH1 Dwell time = Pulse time\*(1600/2/79)\*31.6S  
 DH3 Dwell time = Pulse time\*(1600/4/79)\*31.6S  
 DH5 Dwell time = Pulse time\*(1600/6/79)\*31.6S

#### 5.1.2 DEVIATION FROM STANDARD

No deviation.

### 5.1.3 TEST SETUP

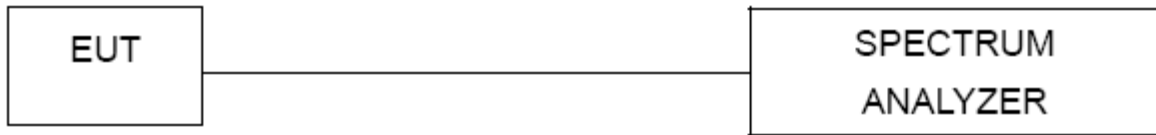

### 5.1.4 EUT OPERATION CONDITIONS

The EUT tested system was configured as the statements of 2.4 Unless otherwise a special operating condition is specified in the follows during the testing.

**5.1.5 TEST RESULTS**

EUT :	Multimedia Speaker System	Model Name :	IFIT-3BT
Temperature :	25 °C	Relative Humidity :	60%
Pressure :	1012 hPa		
Test Voltage :	DC 5.0 V(Adapter Input AC 120 V, 60 Hz)	Test Date	January 5, 2013
Test Mode :	CH00-DH1 ,DH3, DH5		

Data Packet	Frequency	Dwell Time (S)	Limits (S)
DH1	2402MHz	0.12256	0.4
DH3	2402MHz	0.26128	0.4
DH5	2402MHz	0.30752	0.4

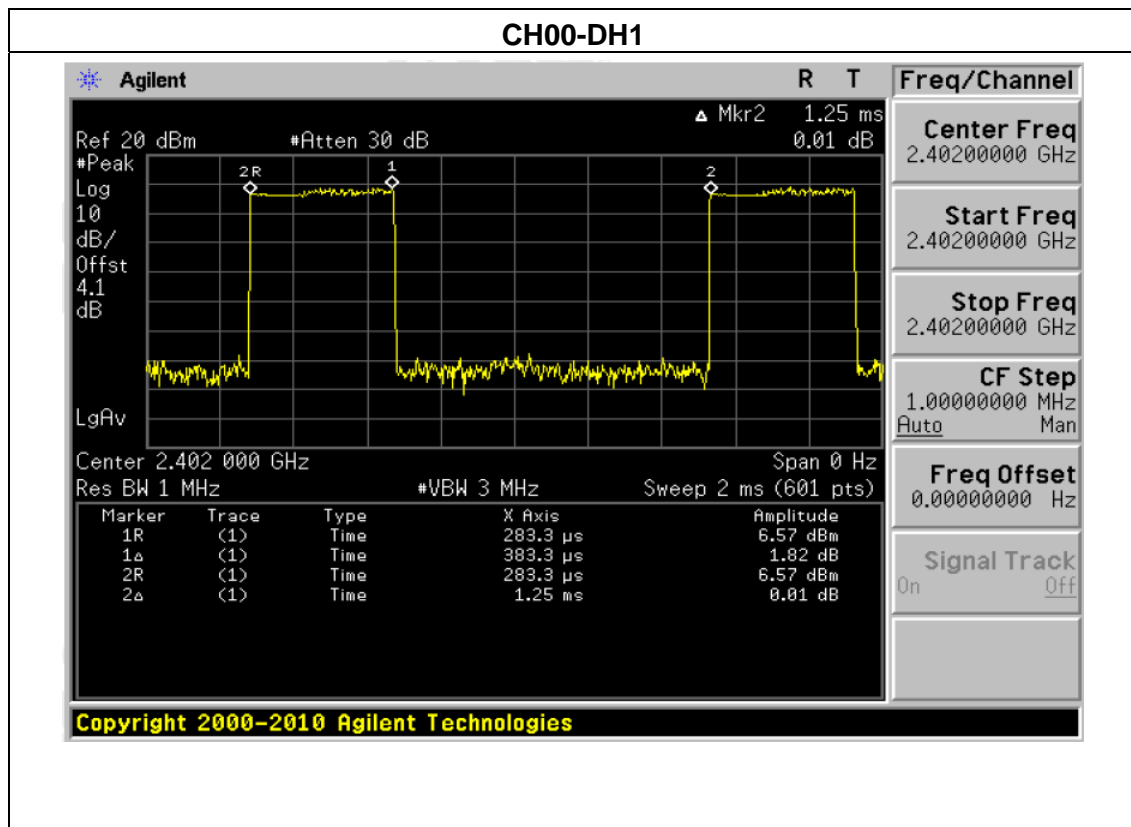



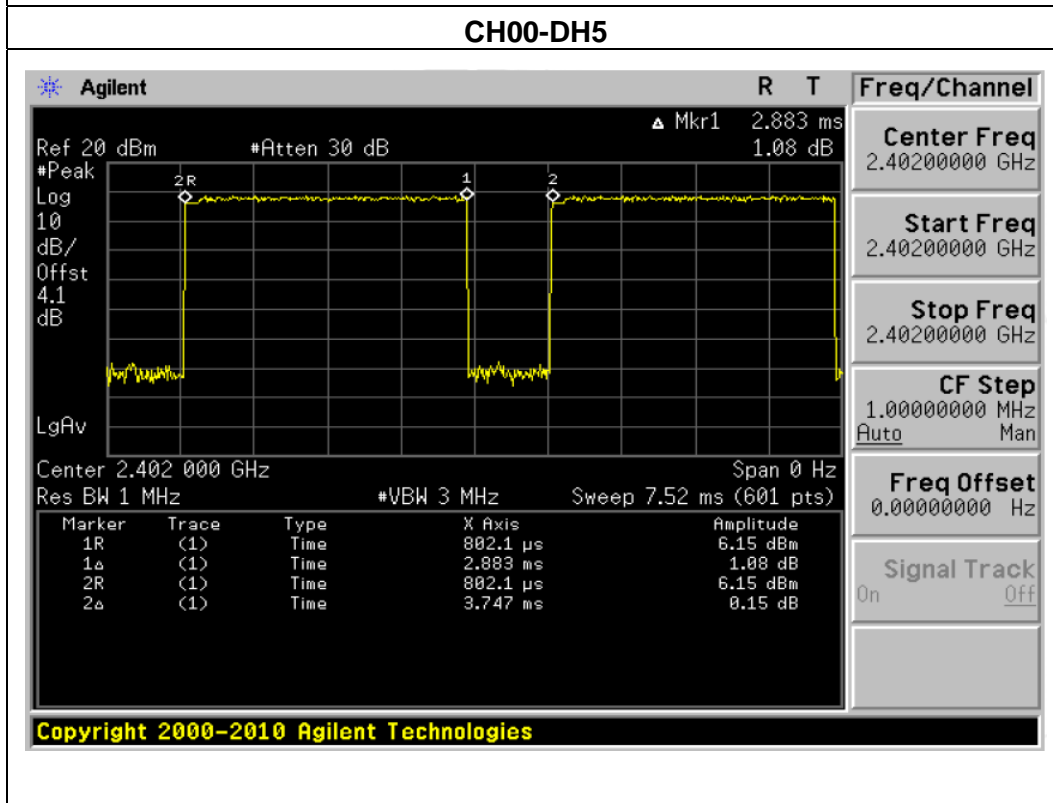
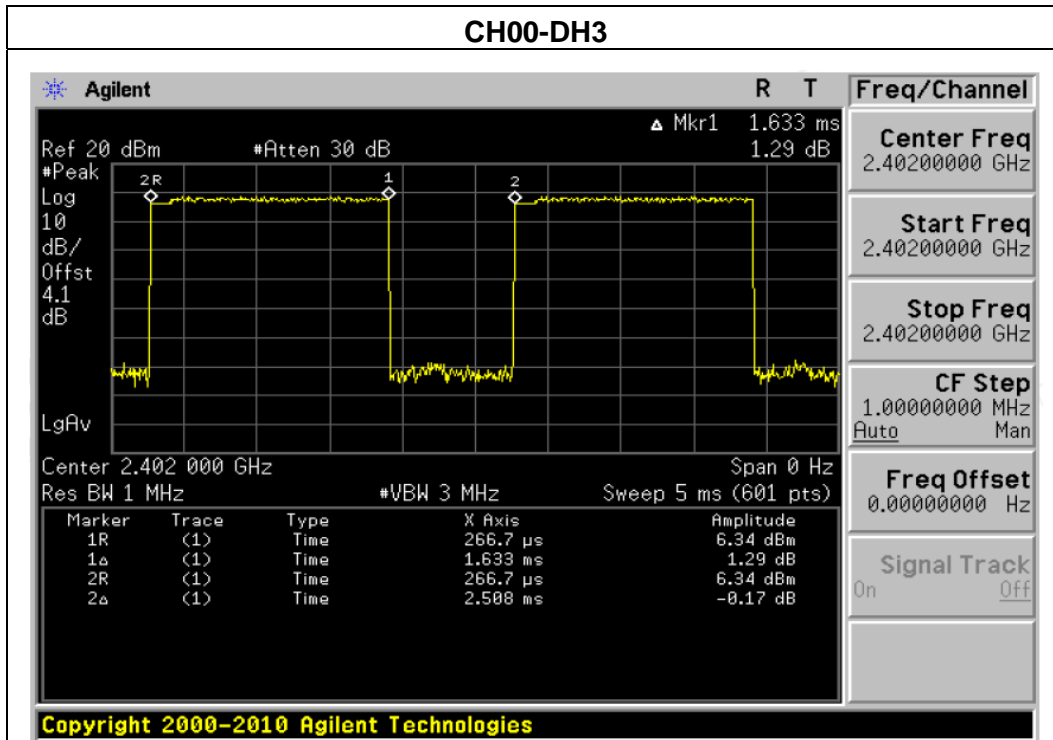

EUT :	Multimedia Speaker System	Model Name :	IFIT-3BT
Temperature :	25 °C	Relative Humidity :	60%
Pressure :	1012 hPa		
Test Voltage :	DC 5.0 V(Adapter Input AC 120 V, 60 Hz)	Test Date	January 5, 2013
Test Mode :	CH39-DH1,DH3,DH5		

Data Packet	Frequency	Dwell Time (S)	Limits (S)
DH1	2441MHz	0.12256	0.4
DH3	2441MHz	0.26128	0.4
DH5	2441MHz	0.30752	0.4

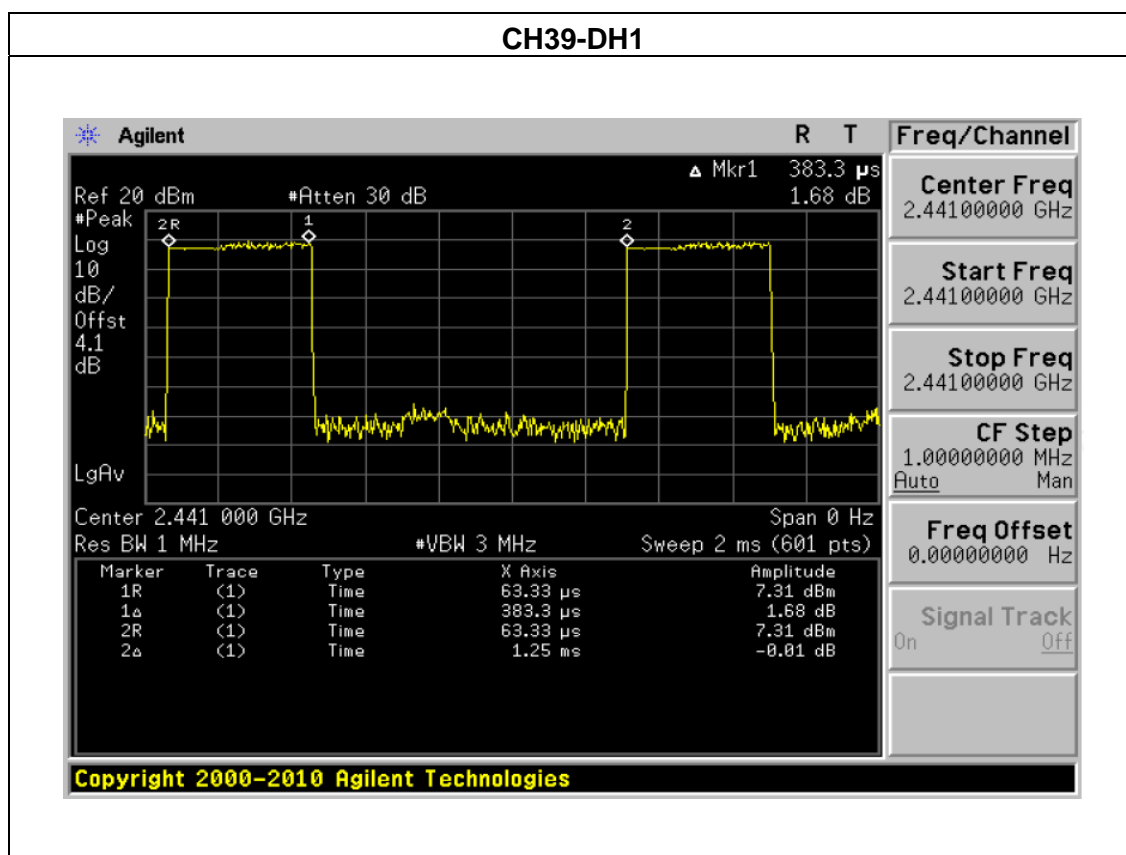

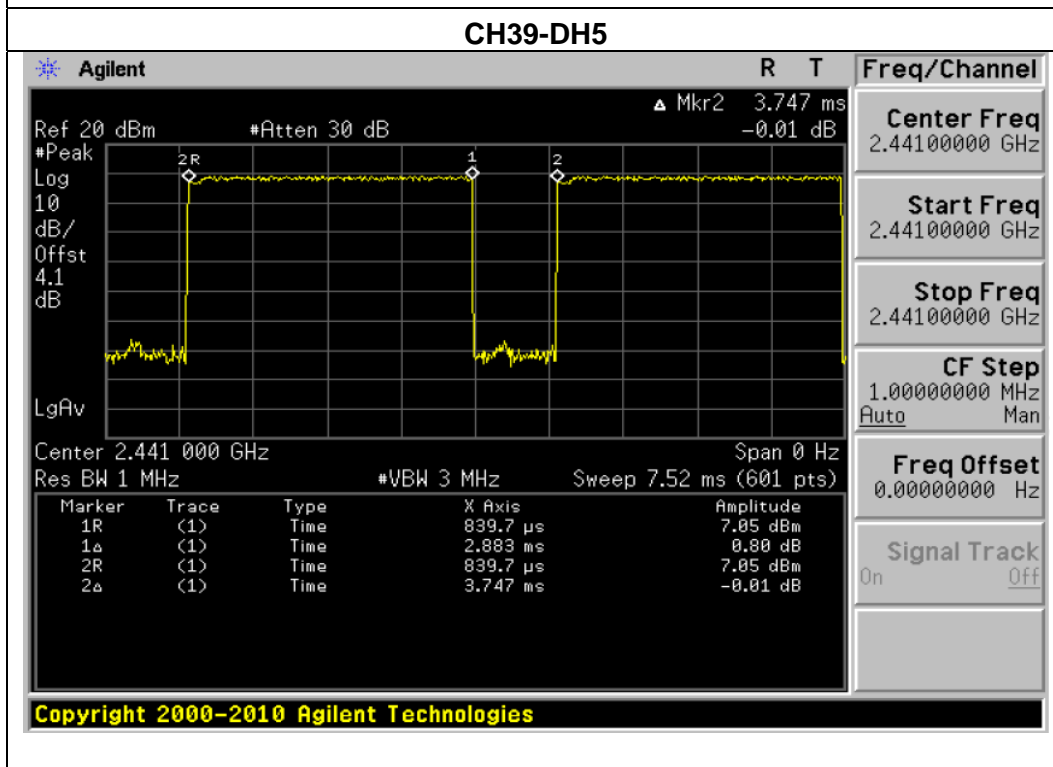
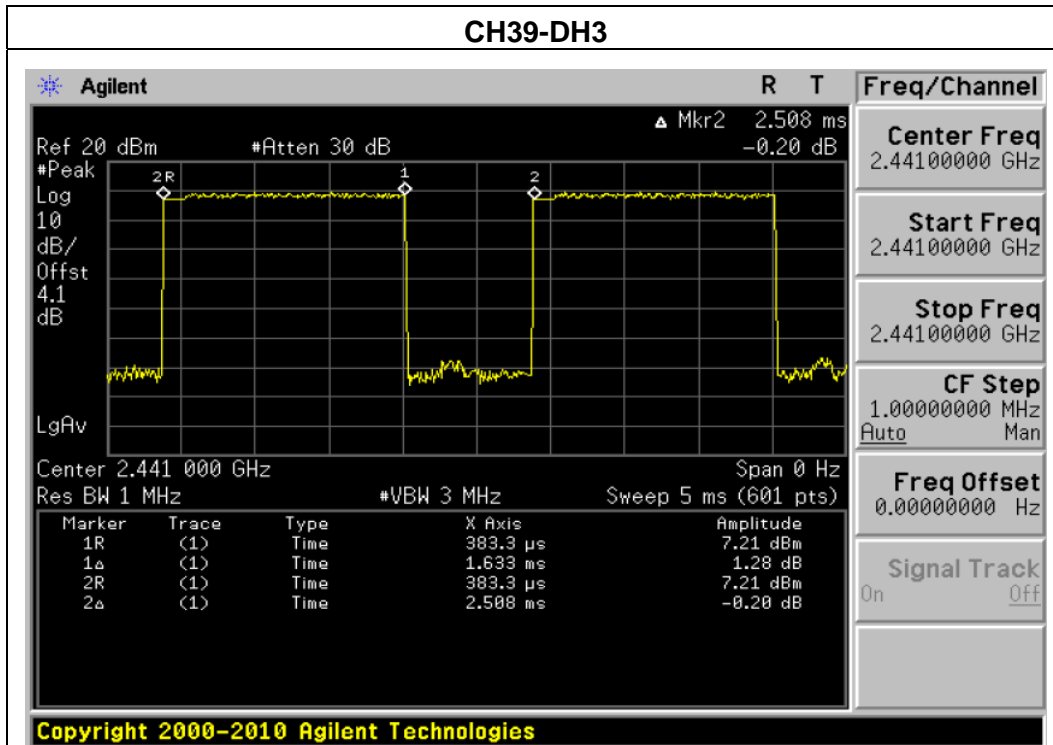

EUT :	Multimedia Speaker System	Model Name :	IFIT-3BT
Temperature :	25 °C	Relative Humidity :	60%
Pressure :	1012 hPa		
Test Voltage :	DC 5.0 V(Adapter Input AC 120 V, 60 Hz)	Test Date	January 5, 2013
Test Mode :	CH78-DH1,2DH1,3DH1		

Data Packet	Frequency	Dwell Time (S)	Limits (S)
DH1	2480MHz	0.12256	0.4
DH3	2480MHz	0.26128	0.4
DH5	2480MHz	0.30752	0.4

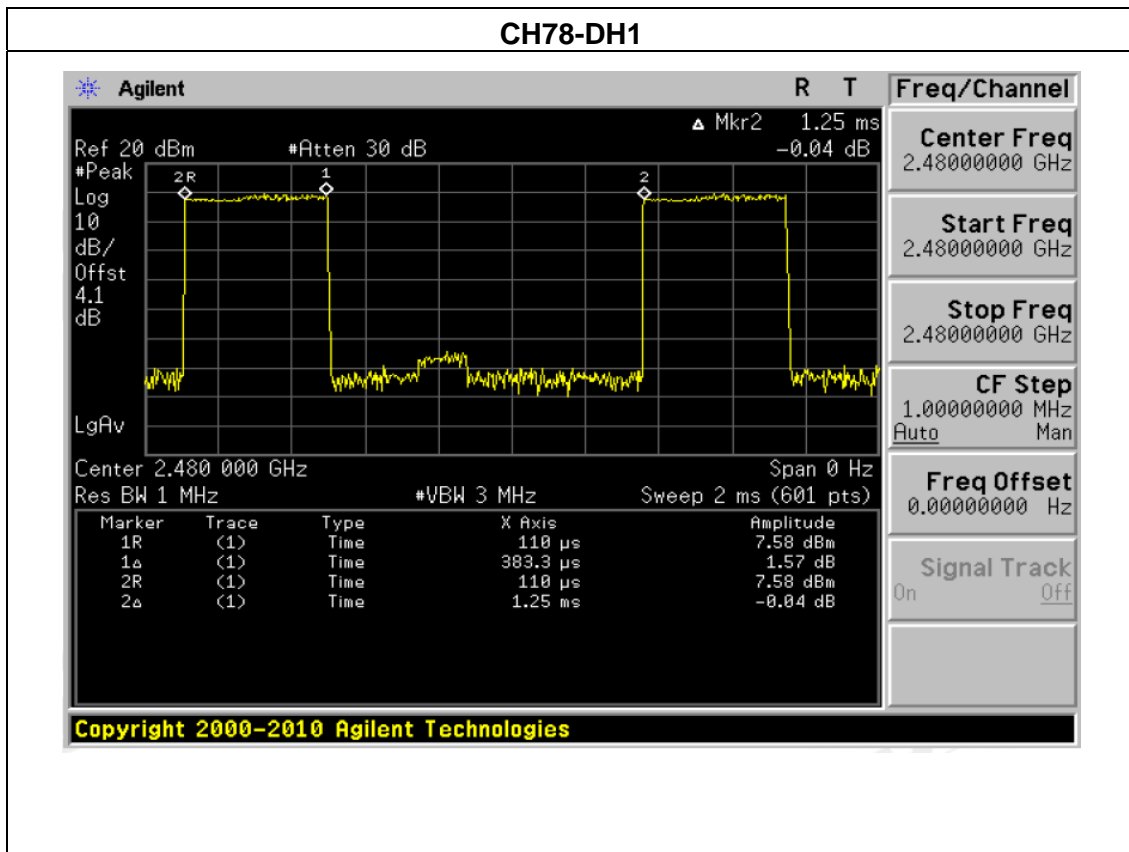

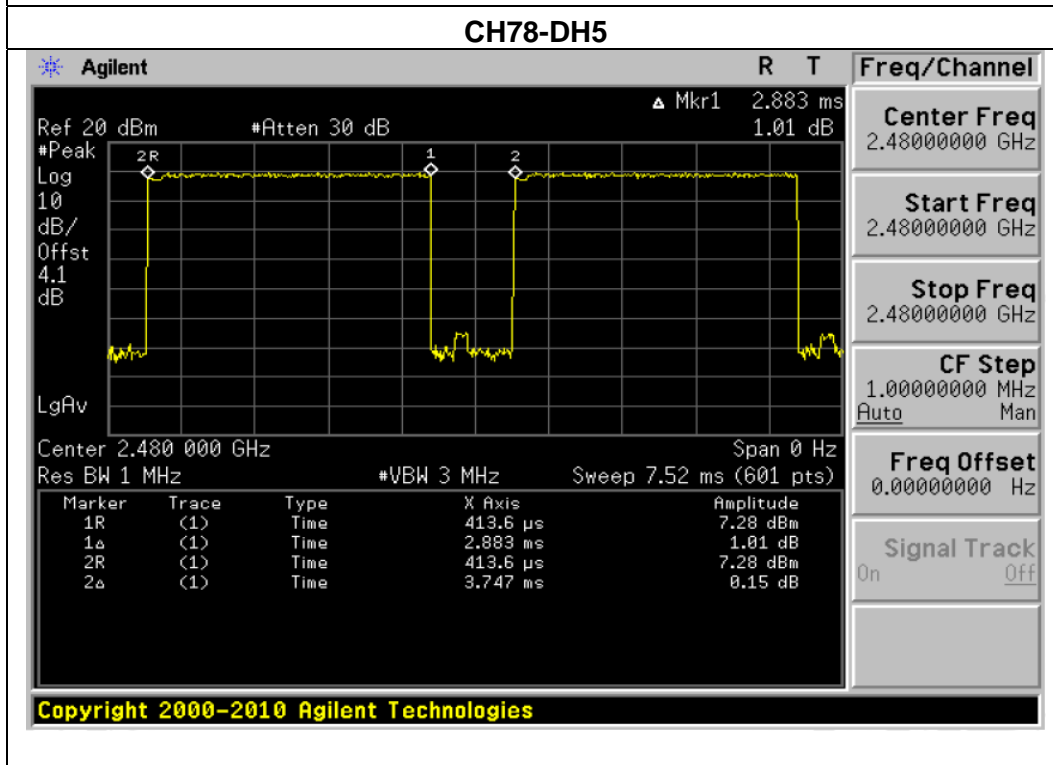
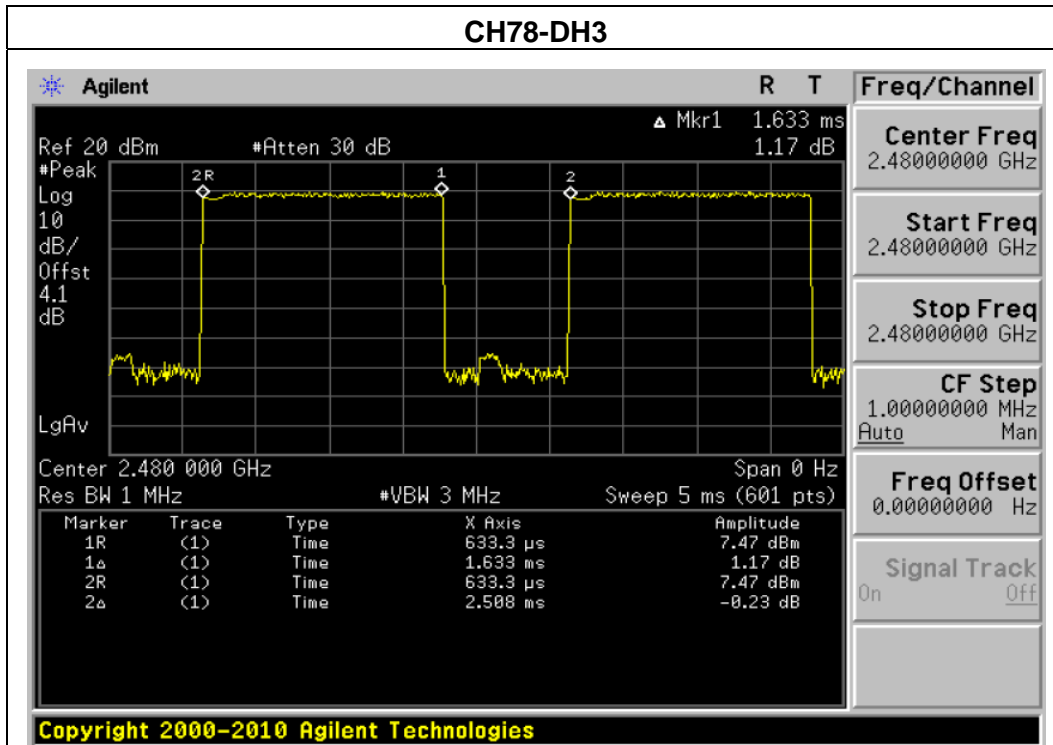

## 6. HOPPING CHANNEL SEPARATION MEASUREMENT

### 6.1 APPLIED PROCEDURES / LIMIT

Frequency hopping systems operating in the 2400-2483.5 MHz band may have hopping channel carrier frequencies that are separated by 25 kHz or two-thirds of the 20 dB bandwidth of the hopping channel, whichever is greater.

Spectrum Parameter	Setting
Attenuation	Auto
Span Frequency	> Measurement Bandwidth or Channel Separation
RB	100 kHz (Channel Separation)
VB	300 kHz (Channel Separation)
Detector	Peak
Trace	Max Hold
Sweep Time	Auto

#### 6.1.1 TEST PROCEDURE

- a. The transmitter output (antenna port) was connected to the spectrum analyser in peak hold mode.
- b. The resolution bandwidth of 100 kHz and the video bandwidth of 300 kHz were utilised for channel separation measurement.

#### 6.1.2 DEVIATION FROM STANDARD

No deviation.

#### 6.1.3 TEST SETUP

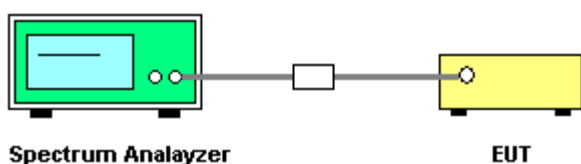

#### 6.1.4 EUT OPERATION CONDITIONS

The EUT was programmed to be in continuously transmitting mode.

**6.1.5 TEST RESULTS**

EUT :	Multimedia Speaker System	Model Name :	IFIT-3BT
Temperature :	25 °C	Relative Humidity :	60%
Pressure :	1012 hPa	Test Result	Pass
Test Voltage :	DC 5.0 V(Adapter Input AC 120 V, 60 Hz)	Test Date	January 5, 2013
Test Mode :	CH00 / CH39 /CH78 (1Mbps Mode)		

Channel number	Channel frequency (MHz)	Separation Read value (KHz)	Separation limit 2/3 20db down BW(KHz)
00	2402	1000.00	>688.00
39	2441	1000.00	>692.67
78	2480	1000.00	>690.00

**Ch. Separation Limits: >20dB bandwidth or >2/3 of 20dB bandwidth**

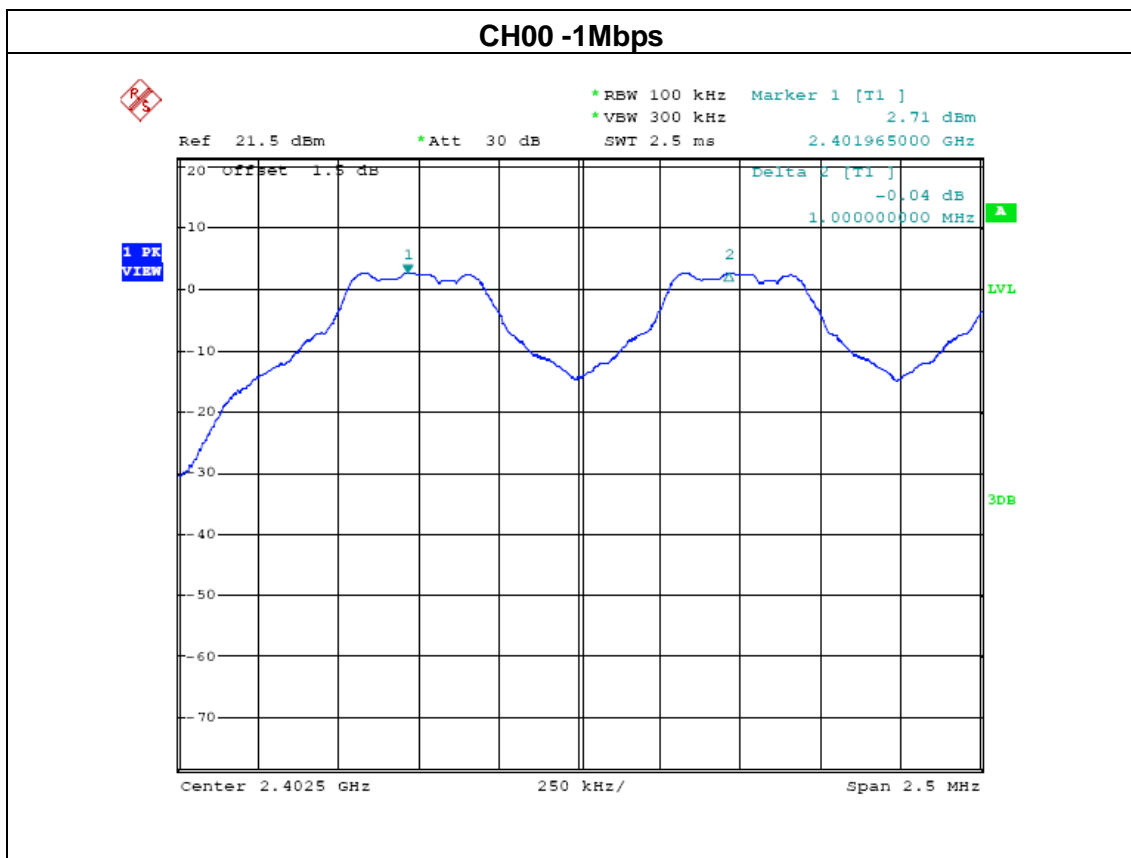

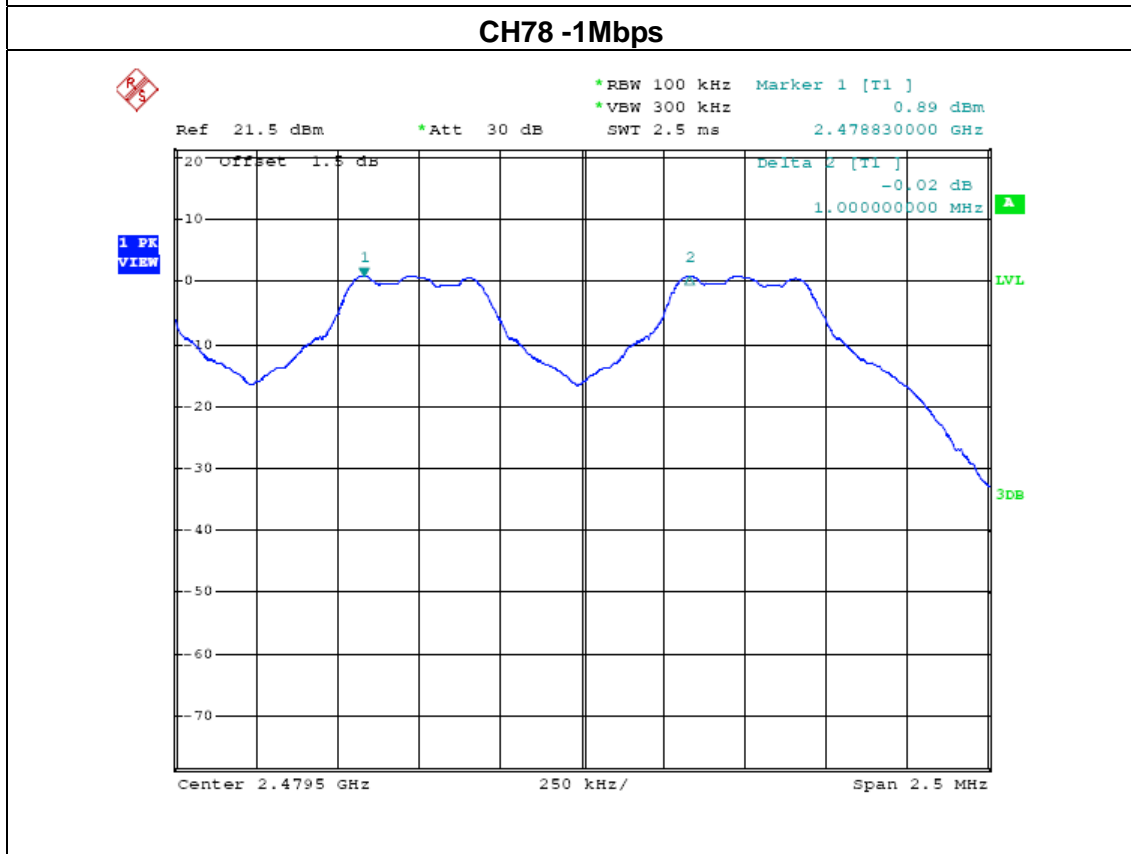
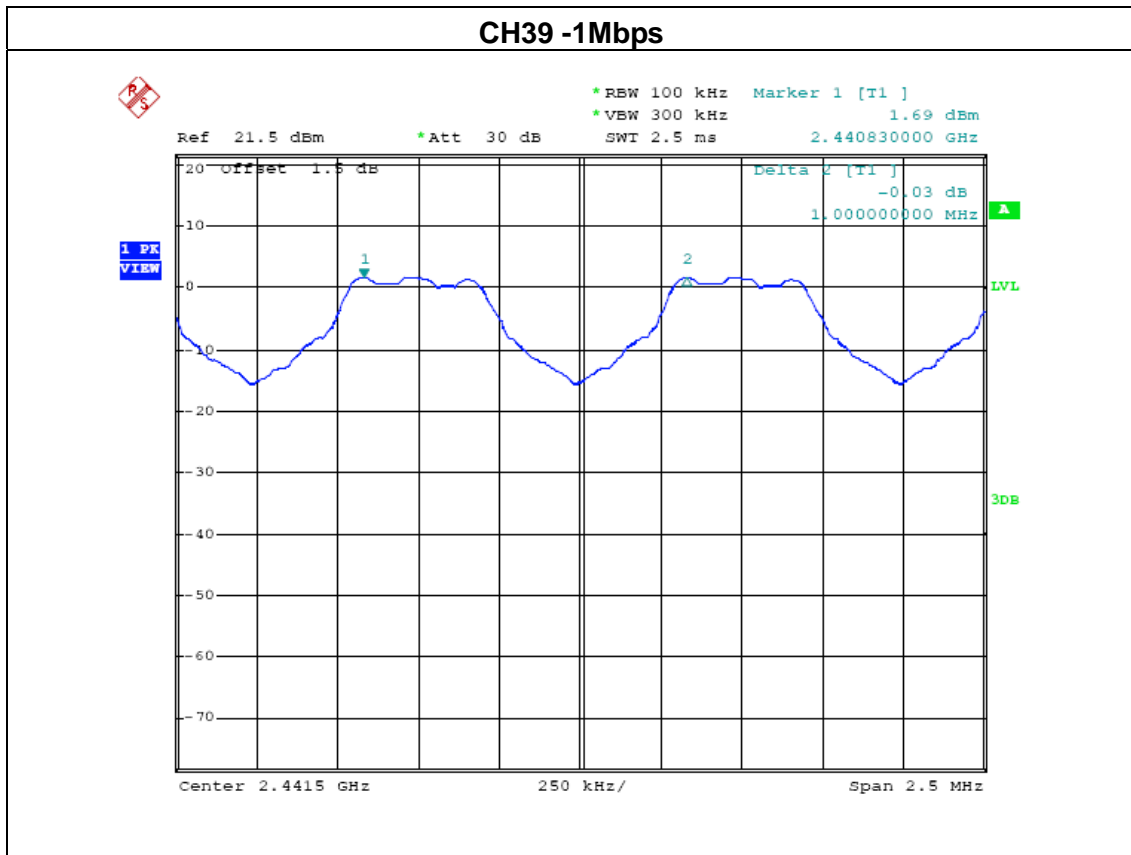



EUT :	Multimedia Speaker System	Model Name :	IFIT-3BT
Temperature :	25 °C	Relative Humidity :	60%
Pressure :	1012 hPa	Test Result	Pass
Test Voltage :	DC 5.0 V(Adapter Input AC 120 V, 60 Hz)	Test Date	January 5, 2013
Test Mode :	CH00 / CH39 /CH78 (2Mbps Mode)		

Channel number	Channel frequency (MHz)	Separation Read value (KHz)	Separation limit 2/3 20db down BW(KHz)
00	2402	1000.00	>902.67
39	2441	1005.00	>895.33
78	2480	1000.00	>898.00

**Ch. Separation Limits: >20dB bandwidth or >2/3 of 20dB bandwidth**

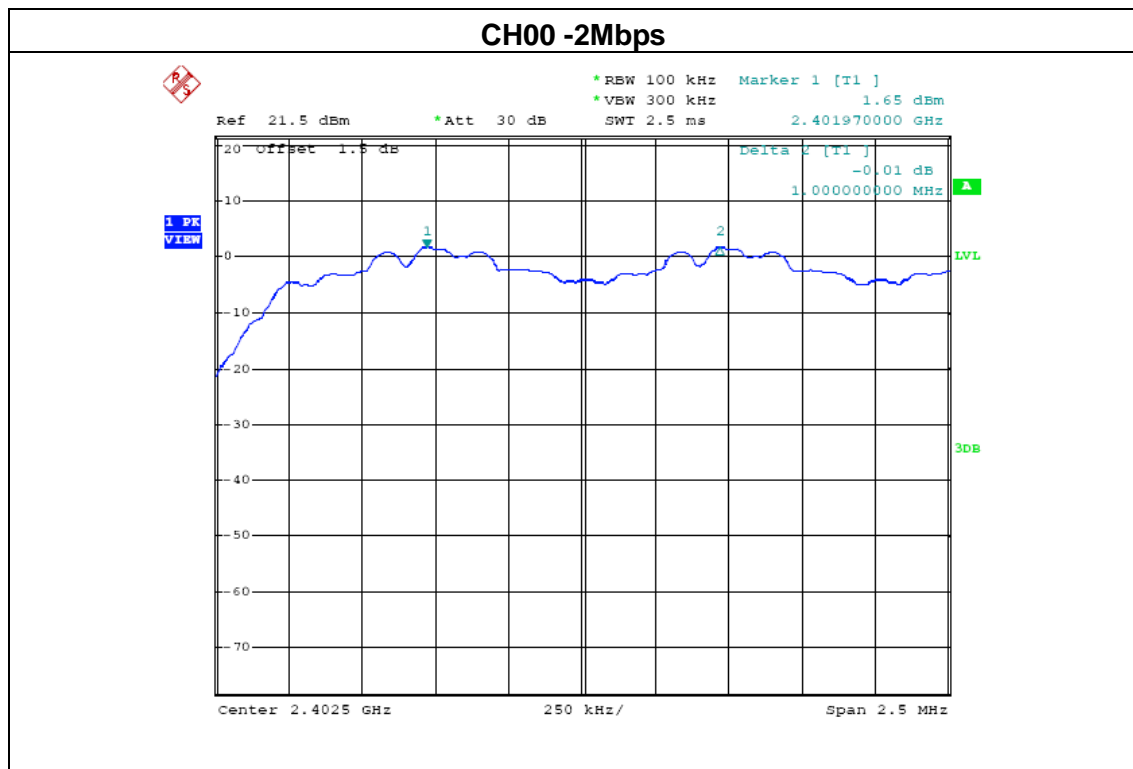

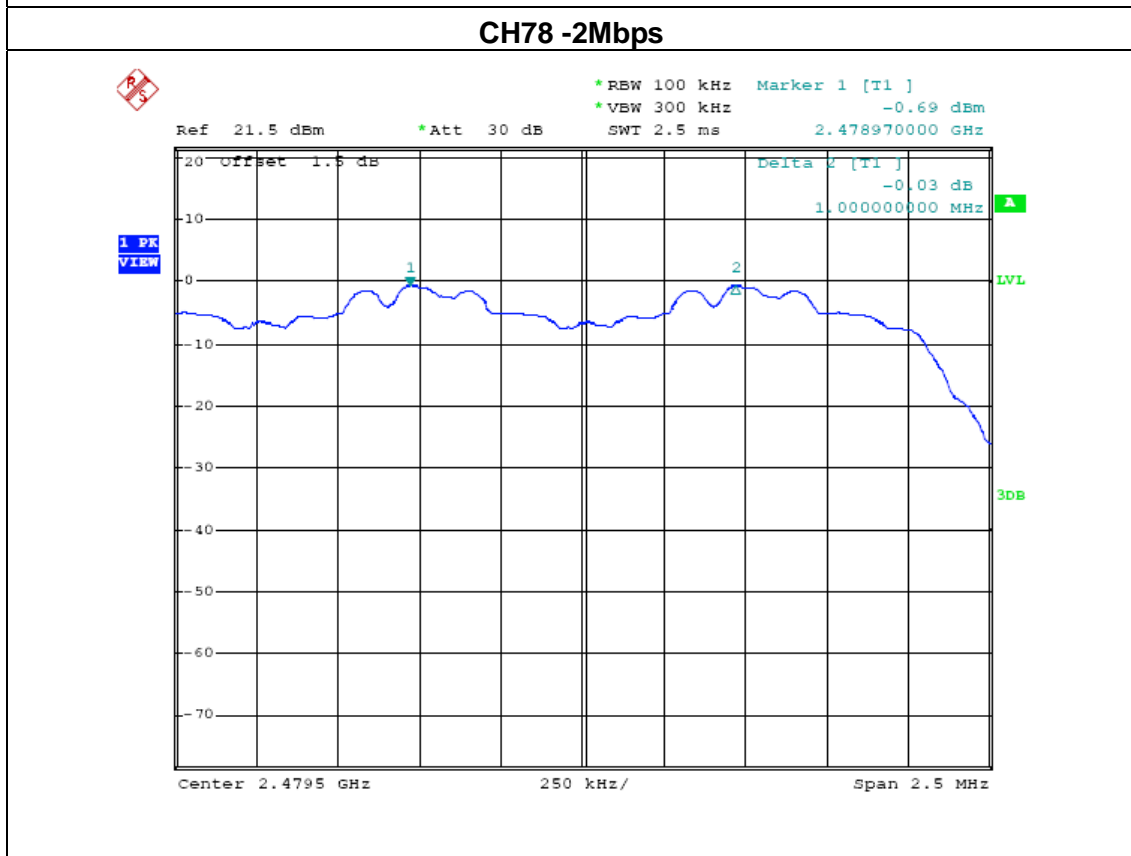
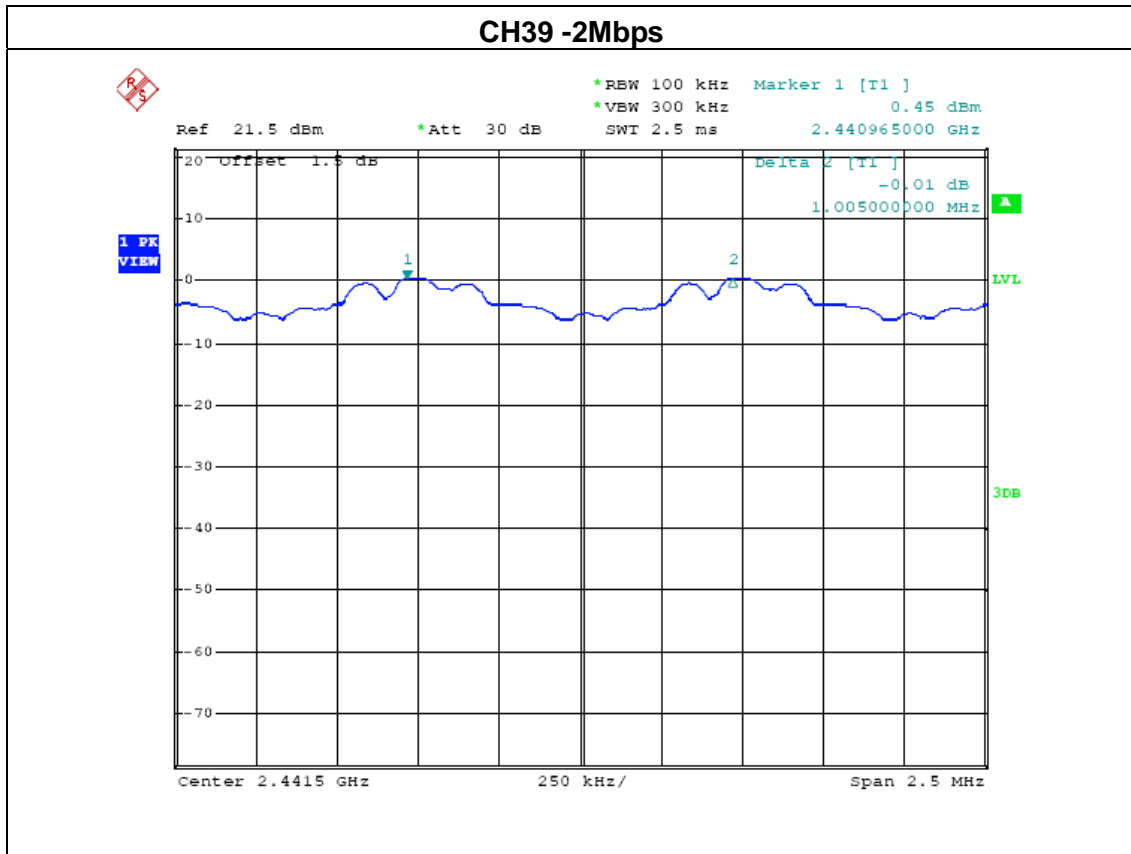

EUT :	Multimedia Speaker System	Model Name :	IFIT-3BT
Temperature :	25 °C	Relative Humidity :	60%
Pressure :	1012 hPa	Test Result	Pass
Test Voltage :	DC 5.0 V(Adapter Input AC 120 V, 60 Hz)	Test Date	January 5, 2013
Test Mode :	CH00 / CH39 /CH78 (3Mbps Mode)		

Channel number	Channel frequency (MHz)	Separation Read value (KHz)	Separation limit 2/3 20db down BW(KHz)
00	2402	1005.00	>904.67
39	2441	1005.00	>900.00
78	2480	1000.00	>896.67

**Ch. Separation Limits: >20dB bandwidth or >2/3 of 20dB bandwidth**

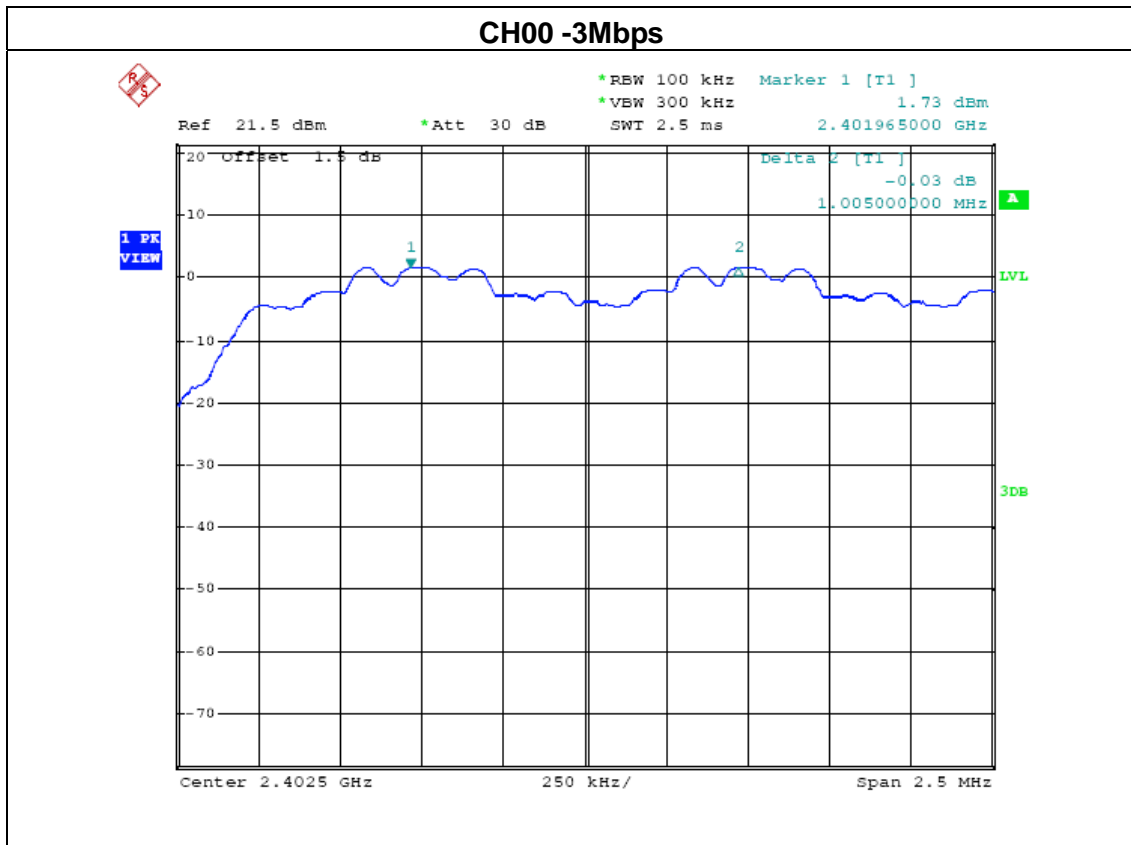

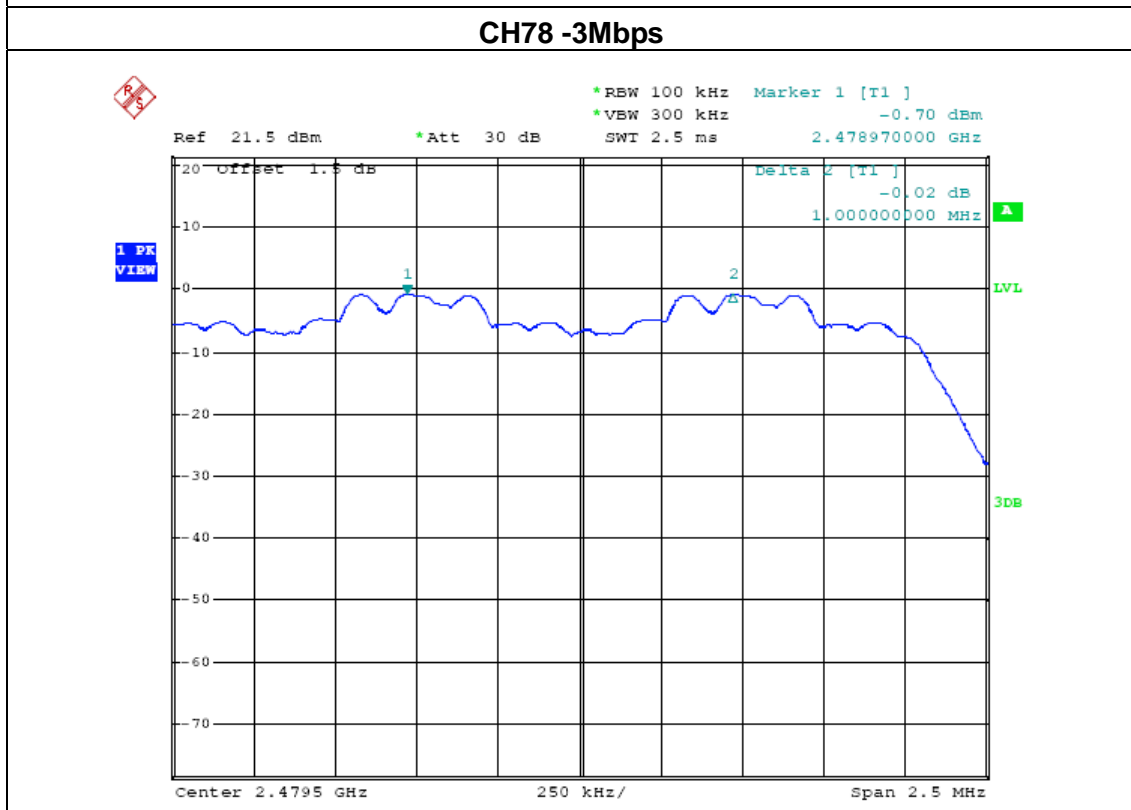
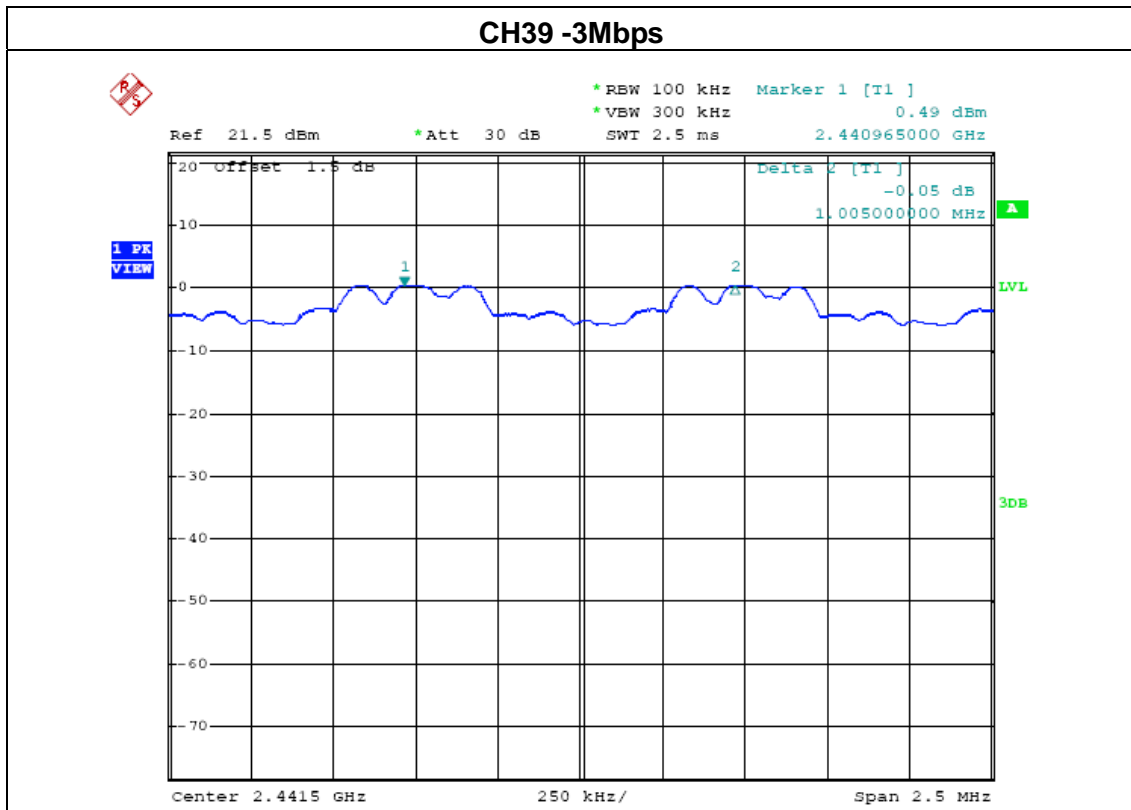

## 7. BANDWIDTH TEST

### 7.1 APPLIED PROCEDURES / LIMIT

FCC Part15 (15.247) , Subpart C				
Section	Test Item	Limit	Frequency Range (MHz)	Result
15.247 (a)(1)	Bandwidth	(20dB bandwidth)	2400-2483.5	PASS

Spectrum Parameter	Setting
Attenuation	Auto
Span Frequency	> Measurement Bandwidth or Channel Separation
RB	30 kHz
VB	100 kHz
Detector	Peak
Trace	Max Hold
Sweep Time	Auto

#### 7.1.1 TEST PROCEDURE

- a. The EUT was directly connected to the spectrum analyzer and antenna output port as show in the block diagram below,
- b. Spectrum Setting : RBW= 30KHz, VBW=100KHz, Sweep time = Auto.

#### 7.1.2 DEVIATION FROM STANDARD

No deviation.

#### 7.1.3 TEST SETUP



#### 7.1.4 EUT OPERATION CONDITIONS

The EUT tested system was configured as the statements of 2.4 Unless otherwise a special operating condition is specified in the follows during the testing.

**7.1.5 TEST RESULTS**

EUT :	Multimedia Speaker System	Model Name :	IFIT-3BT
Temperature :	25 °C	Relative Humidity :	60%
Pressure :	1012 hPa	Test Mode :	CH00/CH39/C78(1Mbps)
Test Voltage :	DC 5.0 V(Adapter Input AC 120 V, 60 Hz)	Test Date	January 5, 2013

Frequency	20dB Bandwidth (kHz)	Result
2402 MHz	1032	<b>PASS</b>
2441 MHz	1039	<b>PASS</b>
2480 MHz	1035	<b>PASS</b>

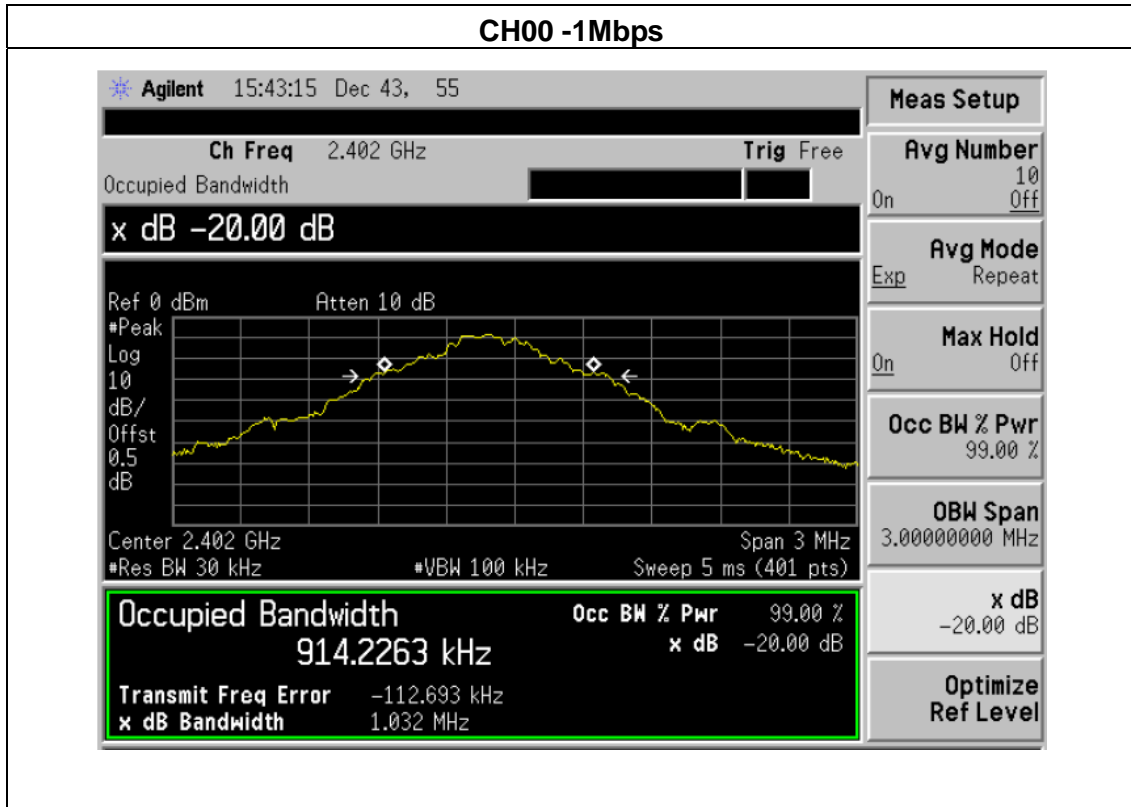

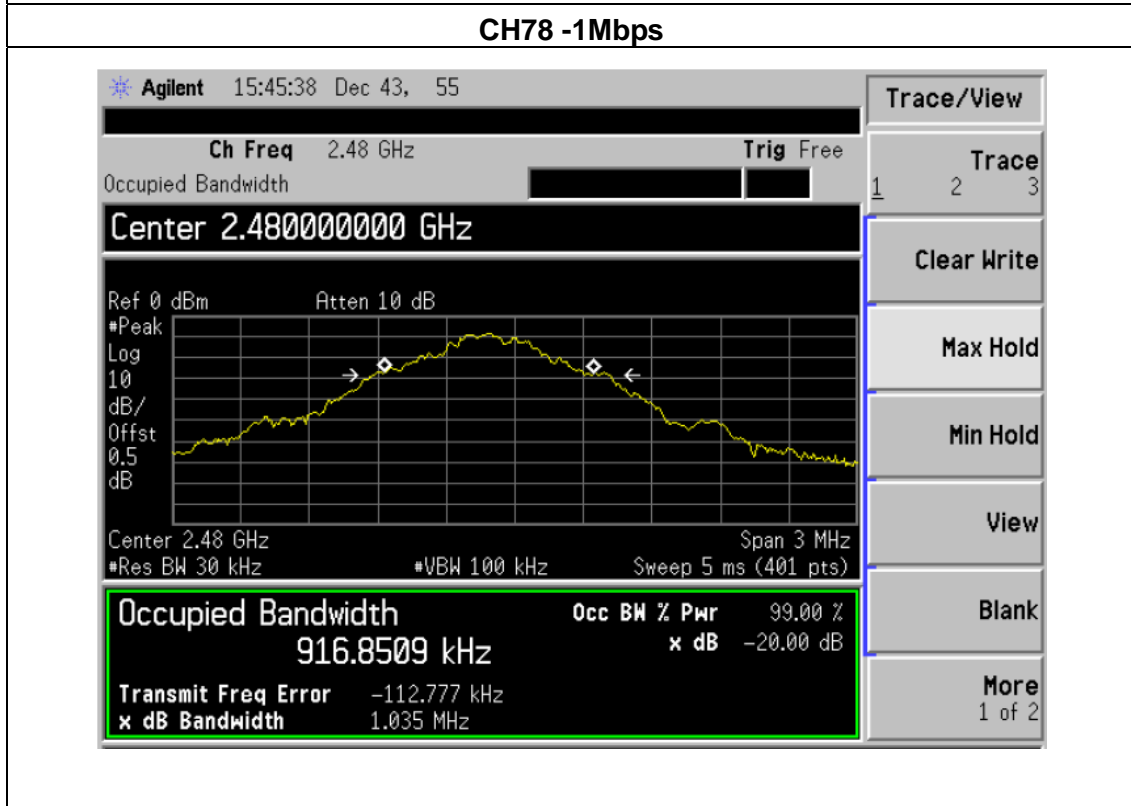
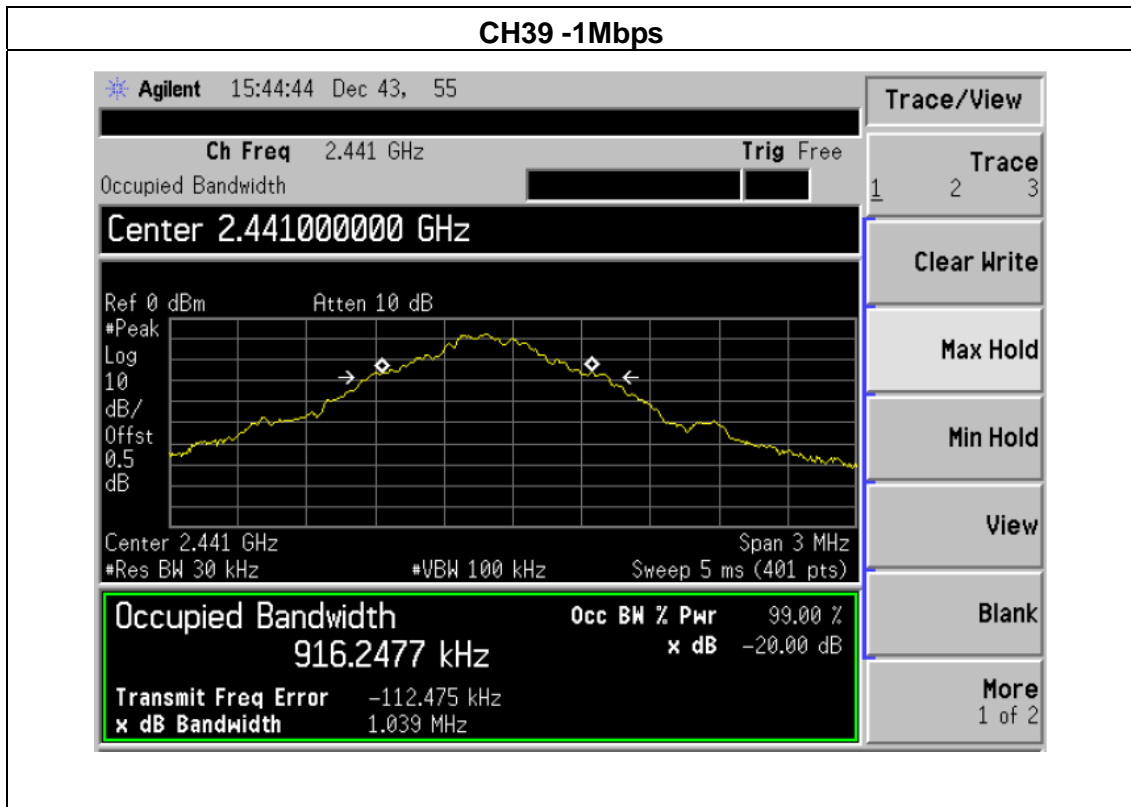

EUT :	Multimedia Speaker System	Model Name :	IFIT-3BT
Temperature :	25 °C	Relative Humidity :	60%
Pressure :	1012 hPa	Test Mode :	CH00/CH39/C78(2Mbps)
Test Voltage :	DC 5.0 V(Adapter Input AC 120 V, 60 Hz)	Test Date	January 5, 2013

Frequency	20dB Bandwidth (kHz)	Result
2402 MHz	1354	PASS
2441 MHz	1343	PASS
2480 MHz	1347	PASS

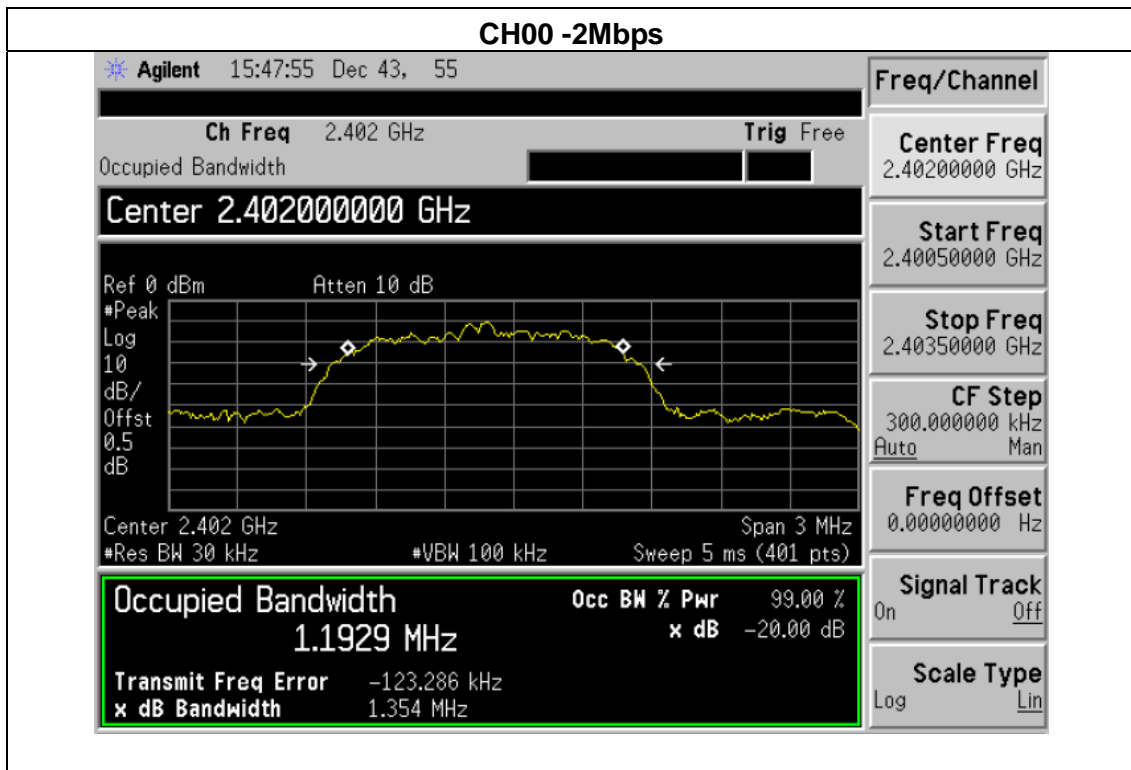



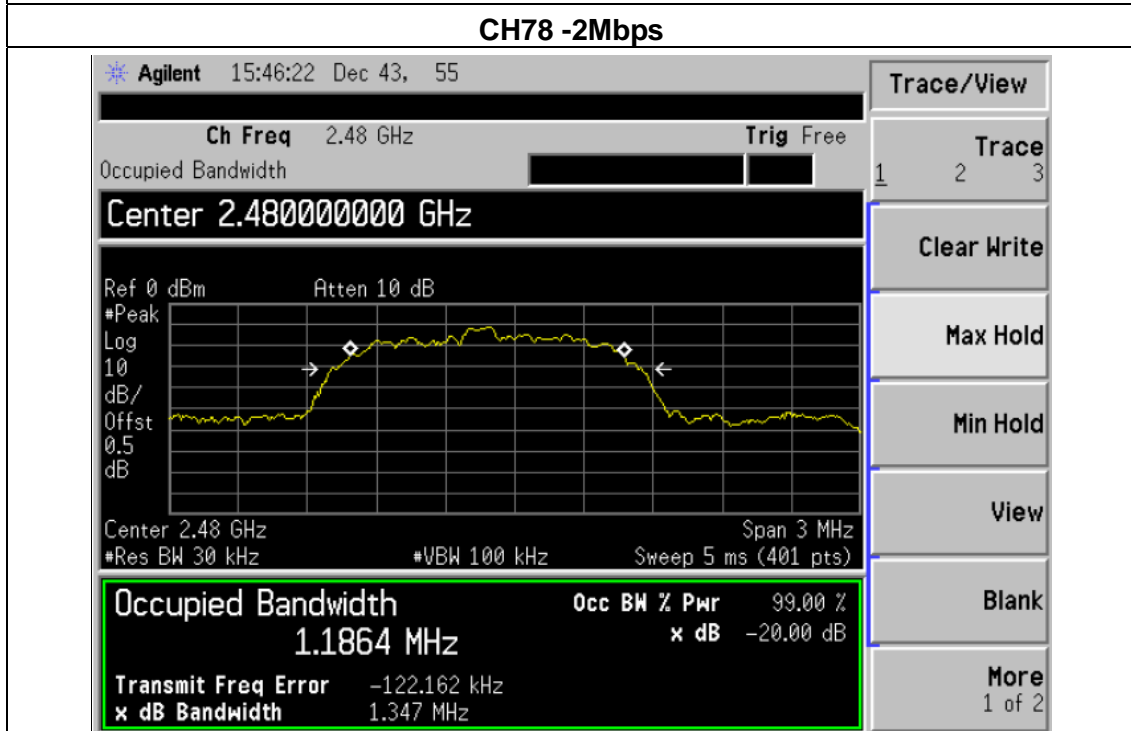
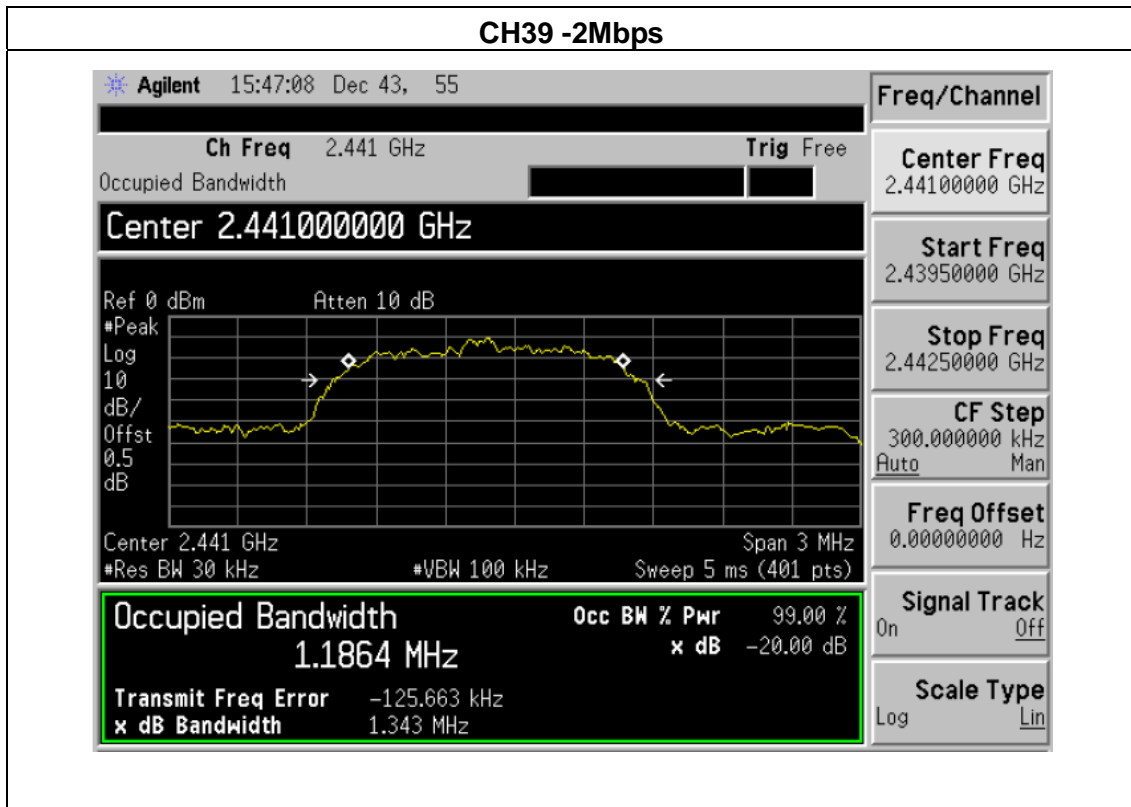

EUT :	Multimedia Speaker System	Model Name :	IFIT-3BT
Temperature :	25 °C	Relative Humidity :	60%
Pressure :	1012 hPa	Test Mode :	CH00/CH39/C78(3Mbps)
Test Voltage :	DC 5.0 V(Adapter Input AC 120 V, 60 Hz)	Test Date	January 5, 2013

Frequency	20dB Bandwidth (kHz)	Result
2402 MHz	1357	PASS
2441 MHz	1349	PASS
2480 MHz	1345	PASS

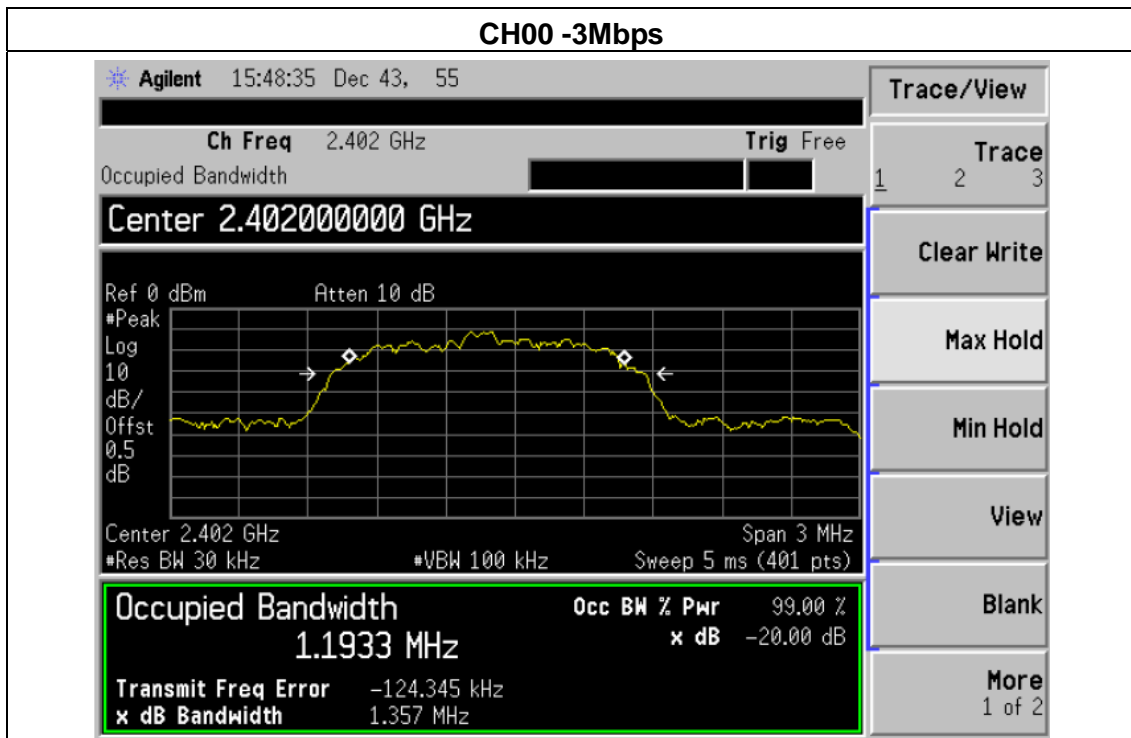

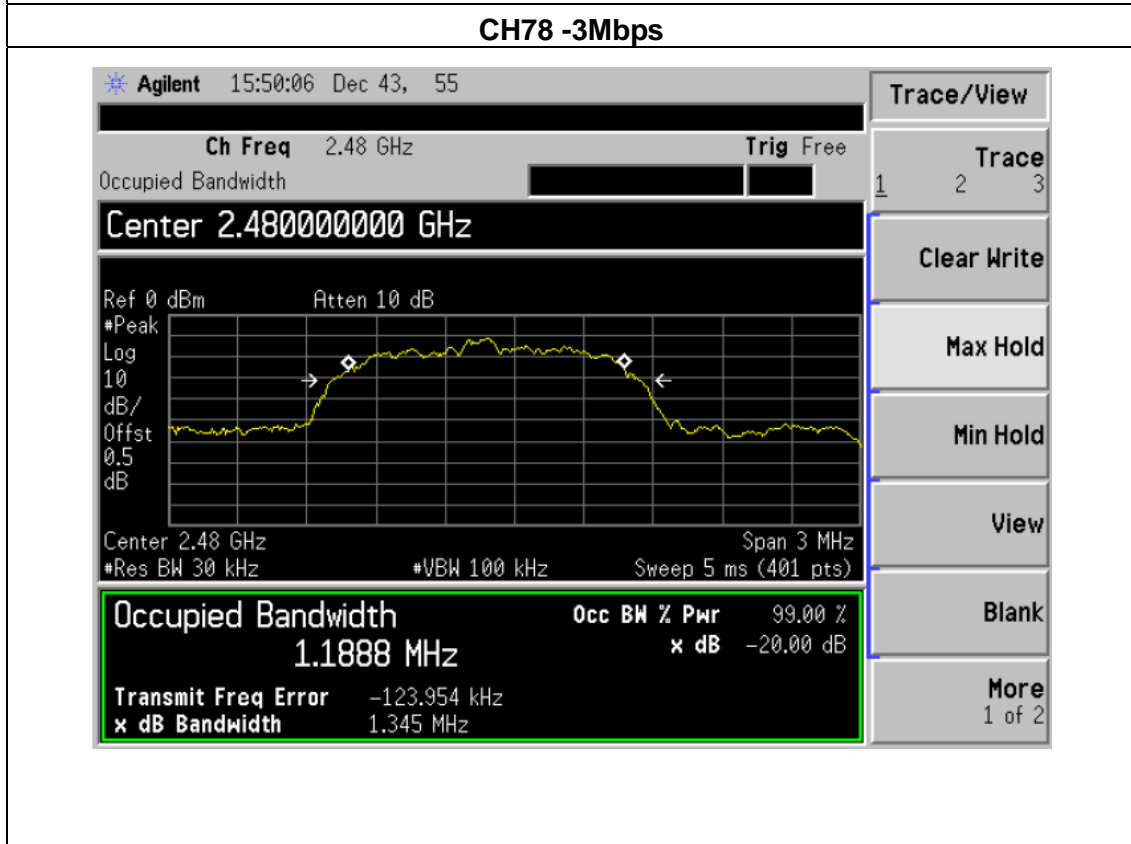
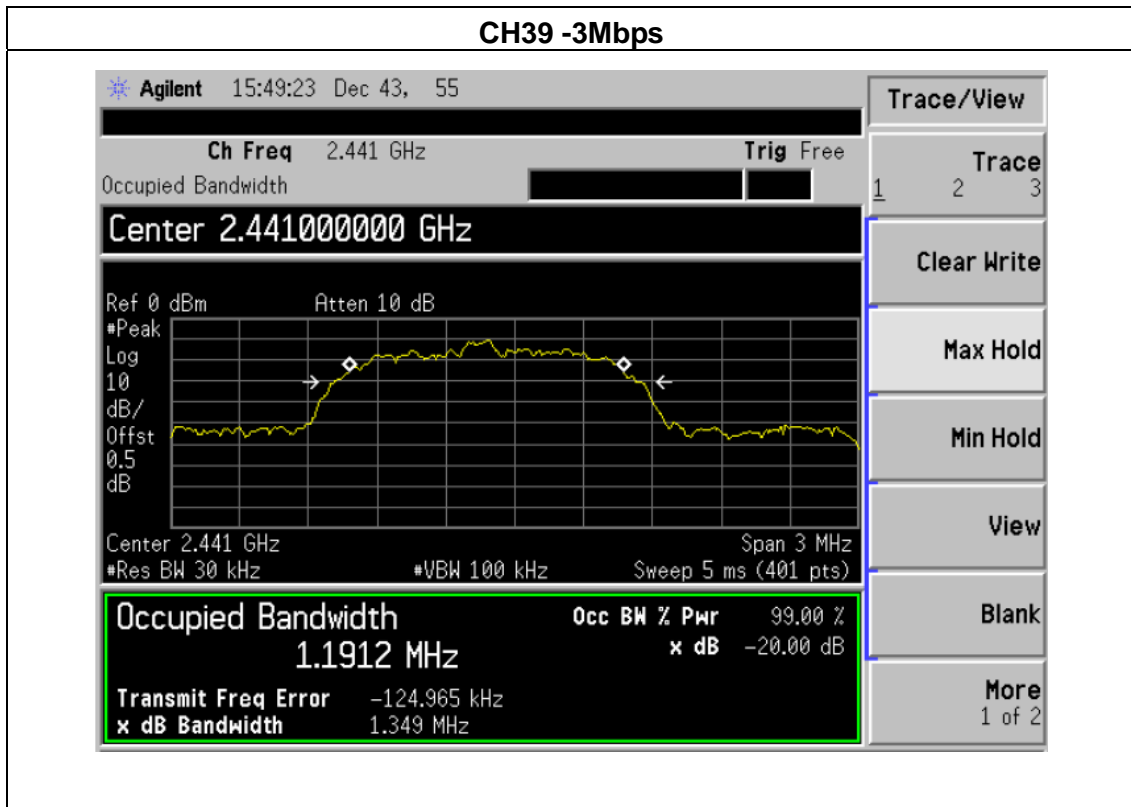

## 8. PEAK OUTPUT POWER TEST

### 8.1 APPLIED PROCEDURES / LIMIT

FCC Part15 (15.247) , Subpart C				
Section	Test Item	Limit	Frequency Range (MHz)	Result
15.247 (b)(i)	Peak Output Power	0.125 w or 20.96dBm	2400-2483.5	PASS

#### 8.1.1 TEST PROCEDURE

- a. The EUT was directly connected to the spectrum analyzer and antenna output port as show in the block diagram below,
- b. Spectrum Setting : RBW > the 20 dB bandwidth of the emission being measured
  - Span = approximately 5 times the 20 dB bandwidth, centered on a hopping channel
  - VBW ≥ RBW
  - Sweep = auto
  - Detector function = peak
  - Trace = max hold

#### 8.1.2 DEVIATION FROM STANDARD

No deviation.

#### 8.1.3 TEST SETUP

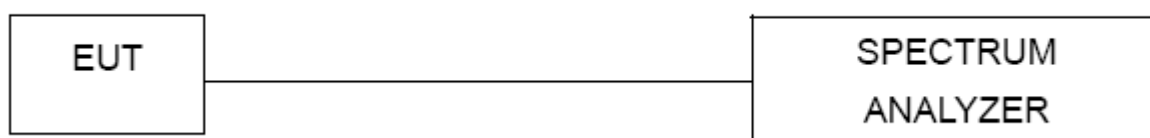

#### 8.1.4 EUT OPERATION CONDITIONS

The EUT tested system was configured as the statements of 2.4 Unless otherwise a special operating condition is specified in the follows during the testing.

### 8.1.5 TEST RESULTS

EUT :	Multimedia Speaker System	Model Name :	IFIT-3BT
Temperature :	25 °C	Relative Humidity :	60%
Pressure :	1012 hPa	Test Mode :	CH00/ CH39 /CH78 (1M/3Mbps Mode)
Test Voltage :	DC 5.0 V(Adapter Input AC 120 V, 60 Hz)	Test Date	January 5, 2013

All the modes GFSK, 1/4Π-DQPSK,8DQPSK have been tested and the worst result recorded in the following pages all modulation methods do not exceed the limits.

1Mbps				
Test Channel	Frequency (MHz)	Peak Output Power (dBm)	LIMIT(dBm)	Result
CH00	2402	8.69	20.96	Pass
CH39	2441	9.08	20.96	Pass
CH78	2480	9.43	20.96	Pass
3Mbps				
CH00	2402	8.84	20.96	Pass
CH39	2441	9.44	20.96	Pass
CH78	2480	9.61	20.96	Pass

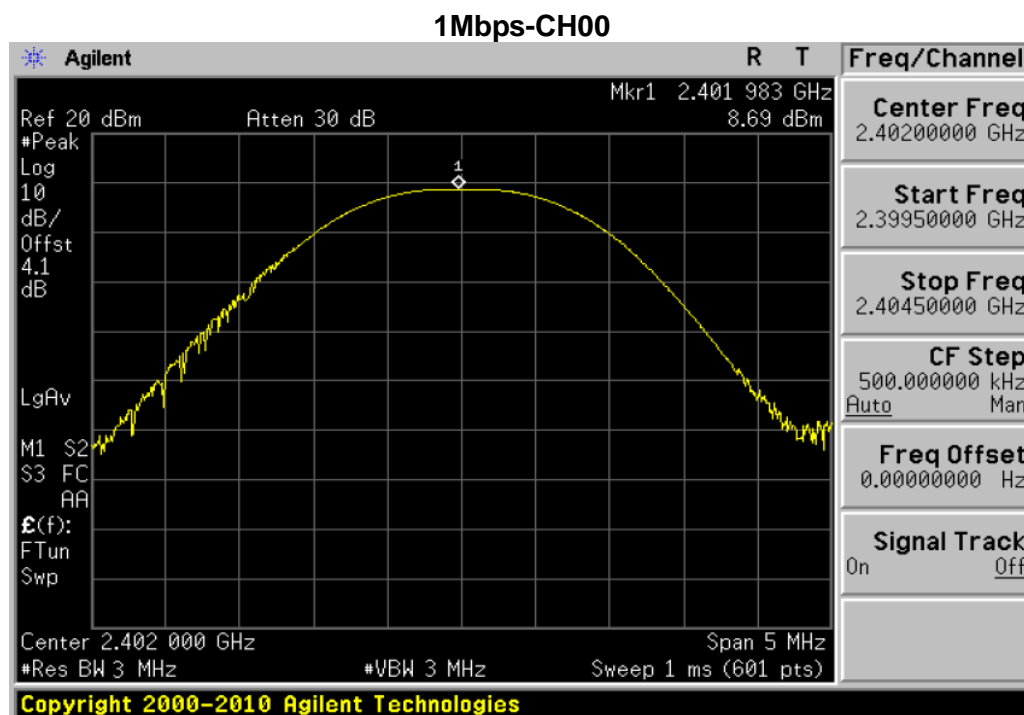

1Mbps-CH39

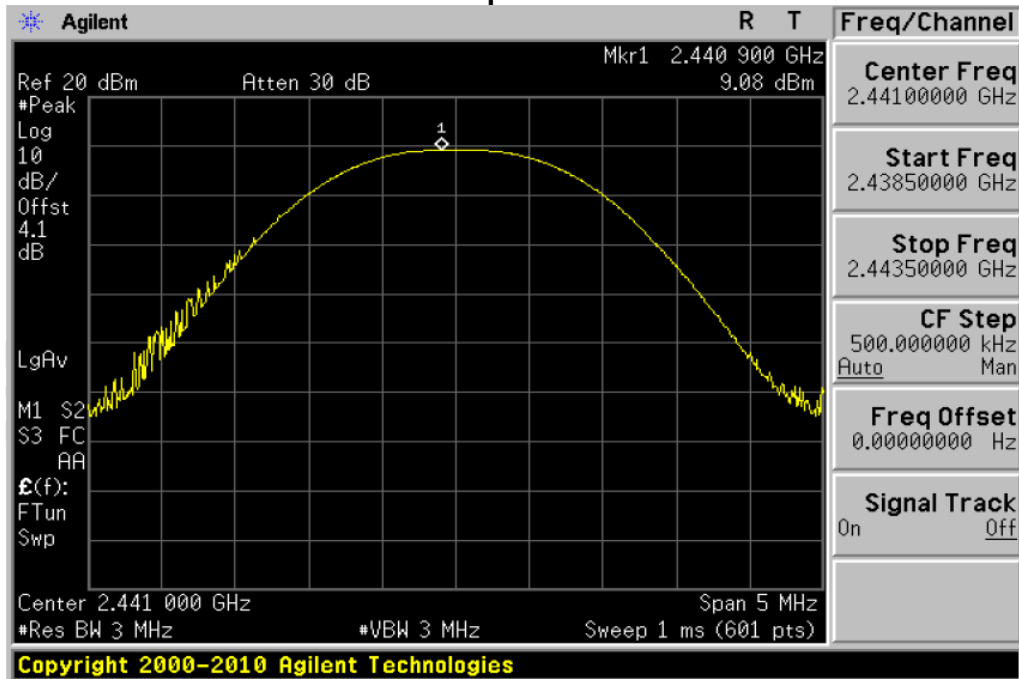

1Mbps-CH78

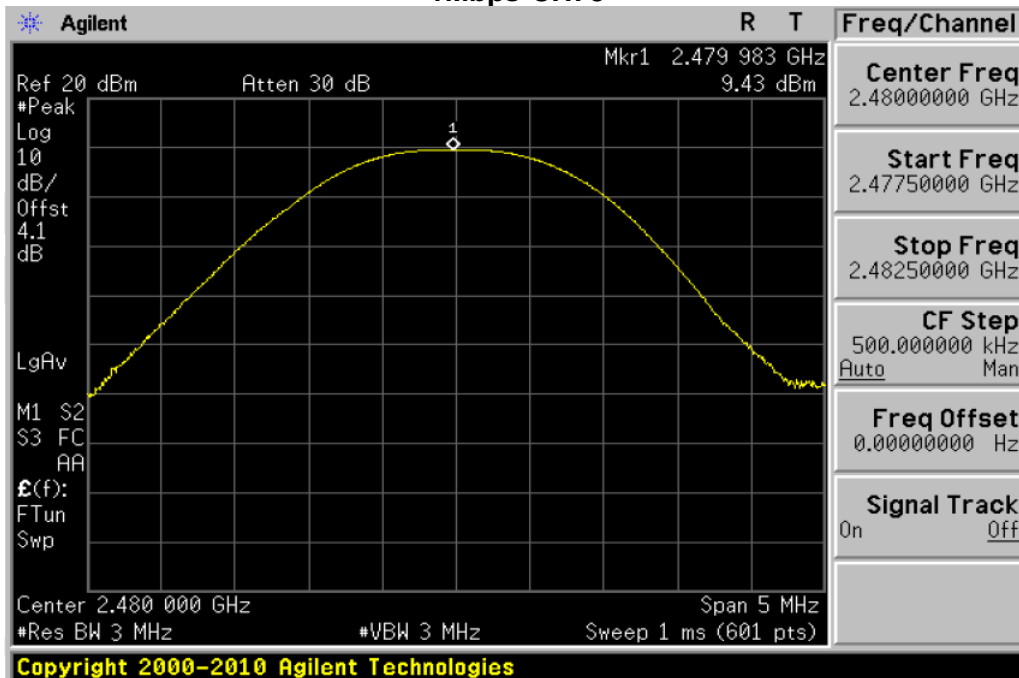

### 3Mbps-CH00

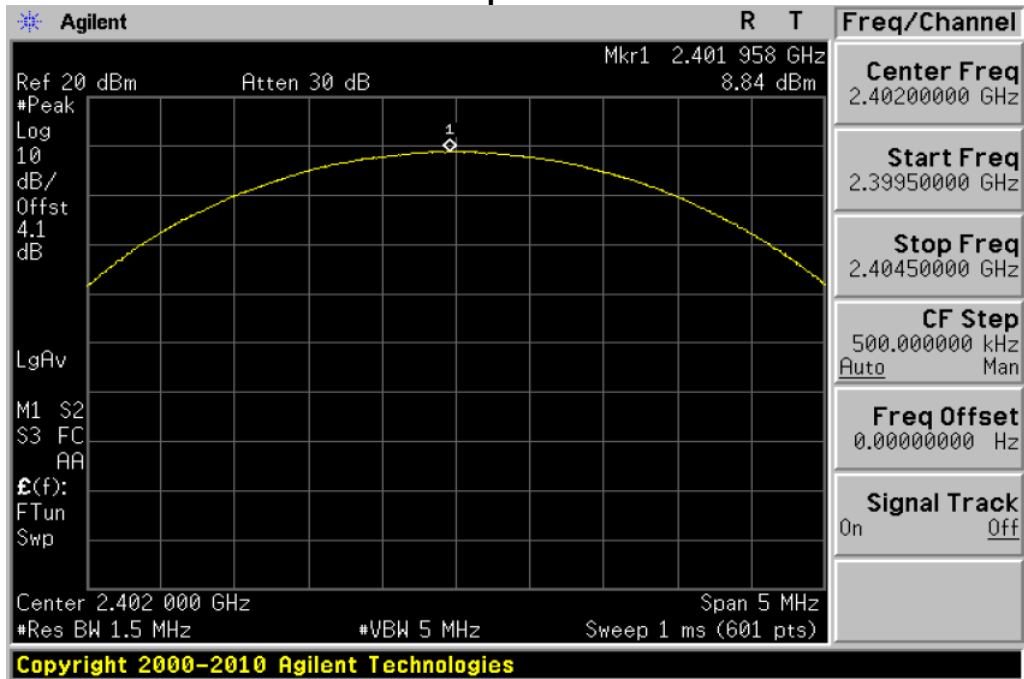

### 3Mbps-CH39

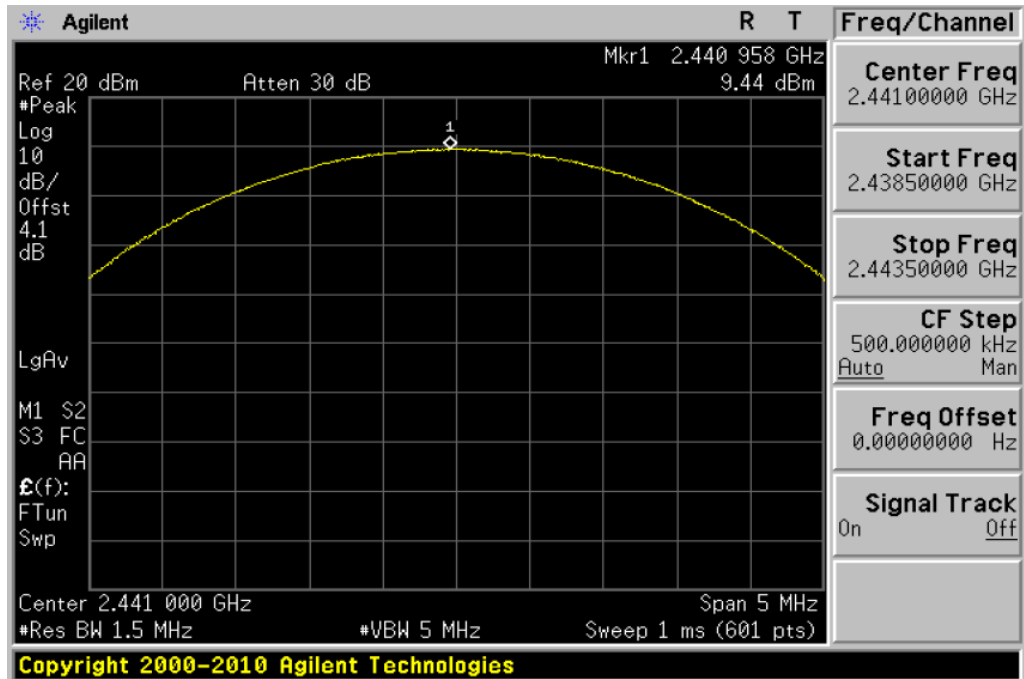

### 3Mbps-CH78

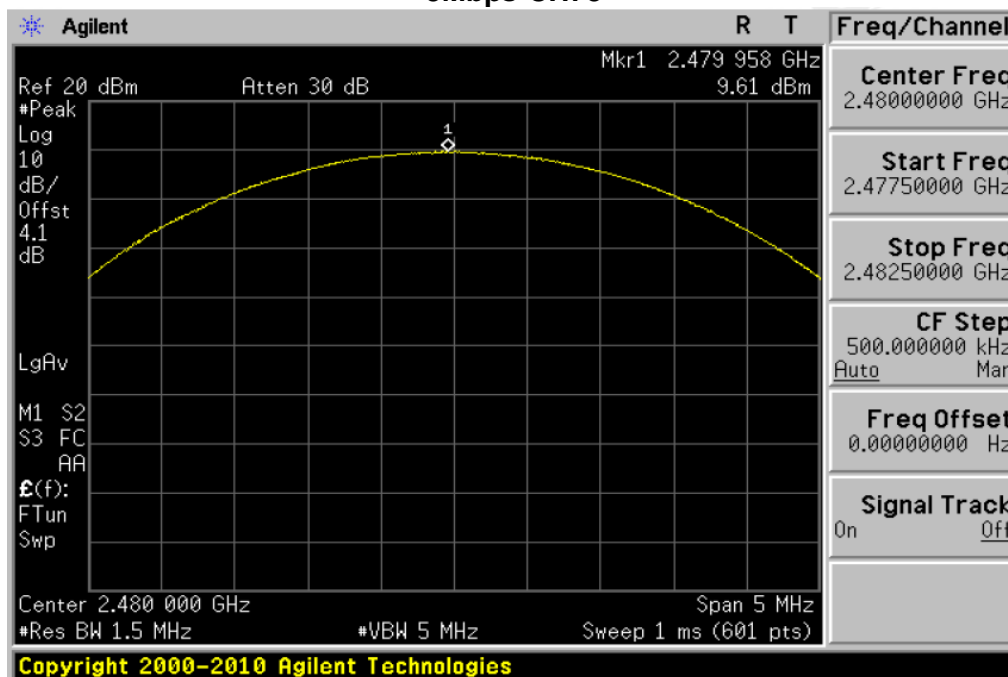



## **9. Antenna Application**

### **9.1 Antenna requirement**

The EUT'S antenna is met the requirement of FCC part 15C section 15.203 and 15.247

FCC part 15C section 15.247 requirements: Systems operating in the 2402-2480MHz band that are used exclusively for fixed, point-to-point operations may employ transmitting antennas with directional gain greater than 6dBi provided the maximum peak output power of the intentional radiator is reduced by 1dB for every 3dB that the directional gain of the antenna exceeds 6dBi.

### **9.2 Result**

The EUT's antenna integrated on PCB, The antenna's gain is 0.5 dBi and meets the requirement.

**10. EUT TEST PHOTO**

**CONDUCTED EMISSION Photos**



**Radiated Measurement Photos**

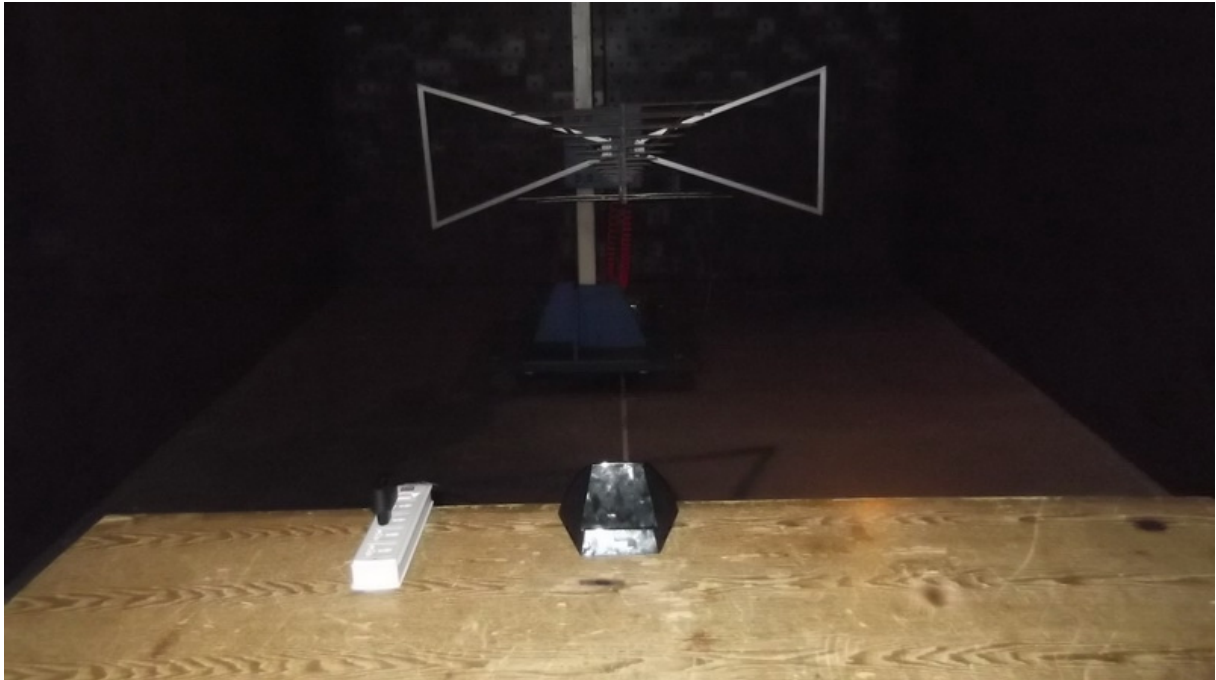

## 11 PHOTOGRAPHS OF EUT

Appearance photograph of EUT



Appearance photograph of EUT



Appearance photograph of EUT



Appearance photograph of EUT

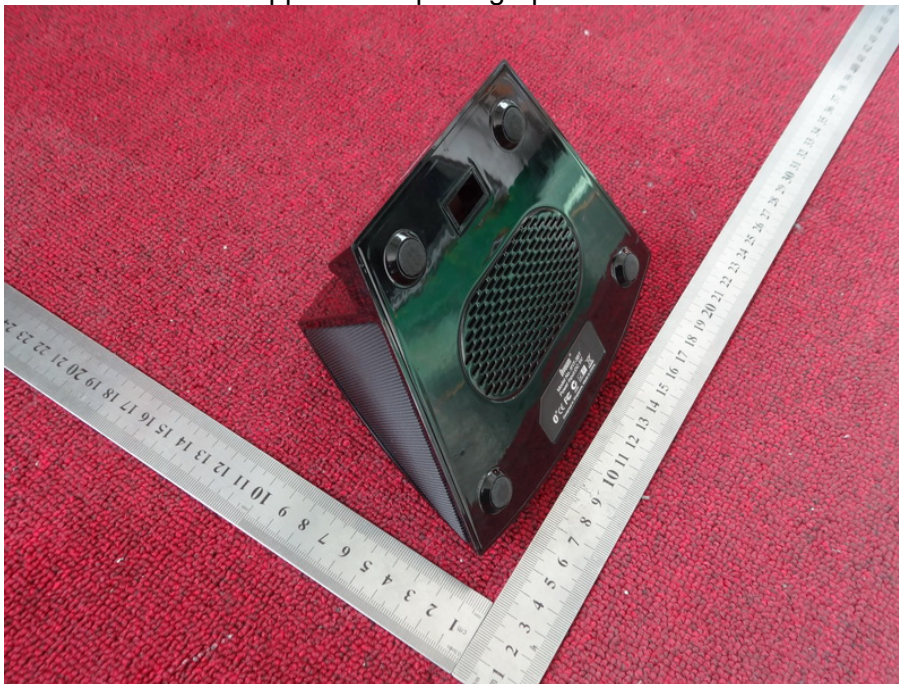

Appearance photograph of EUT

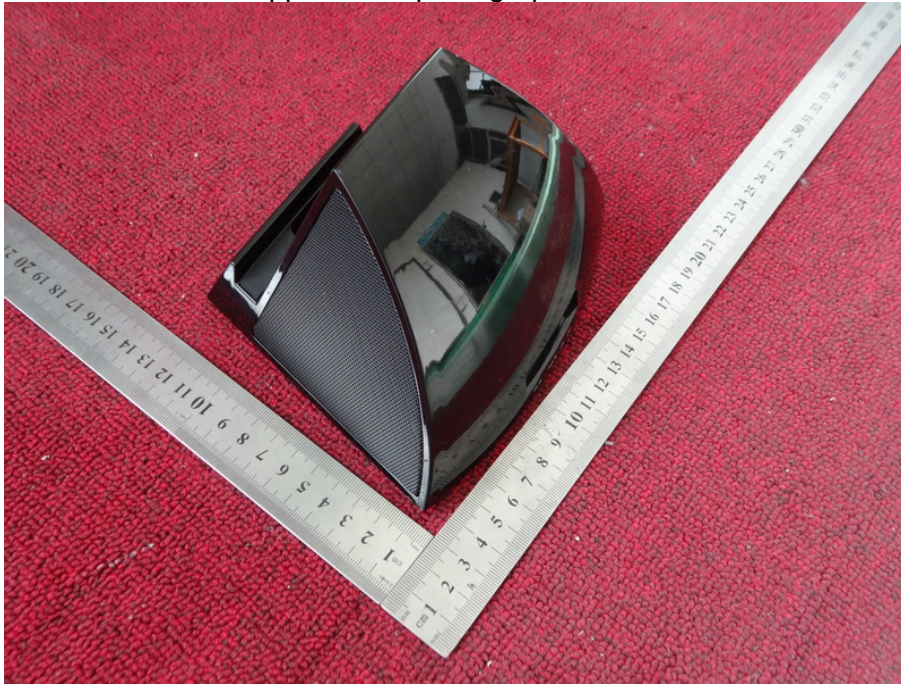

Appearance photograph of EUT



Internal photograph of EUT

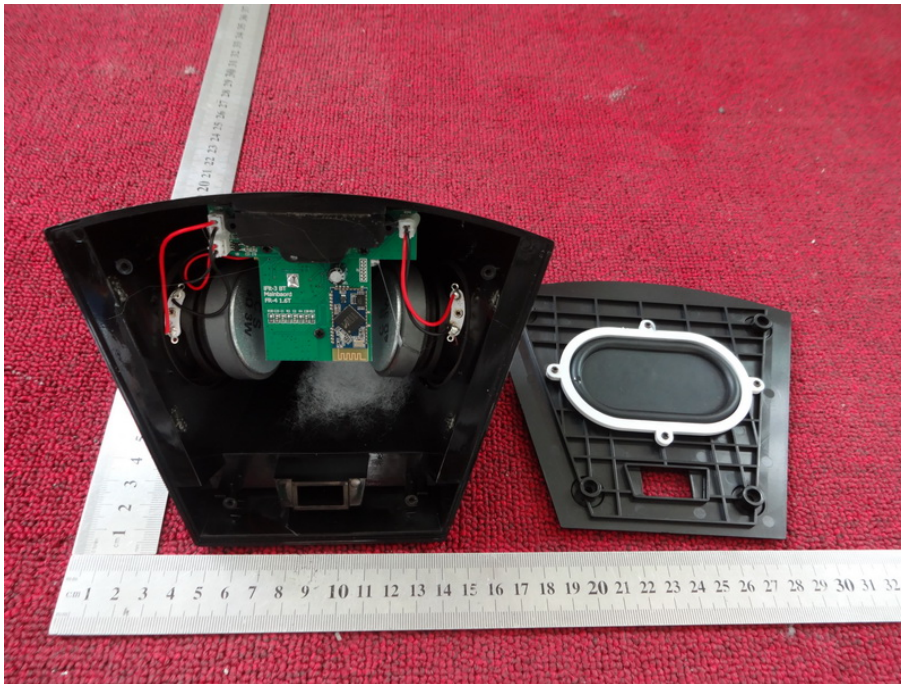

PCB photograph of EUT

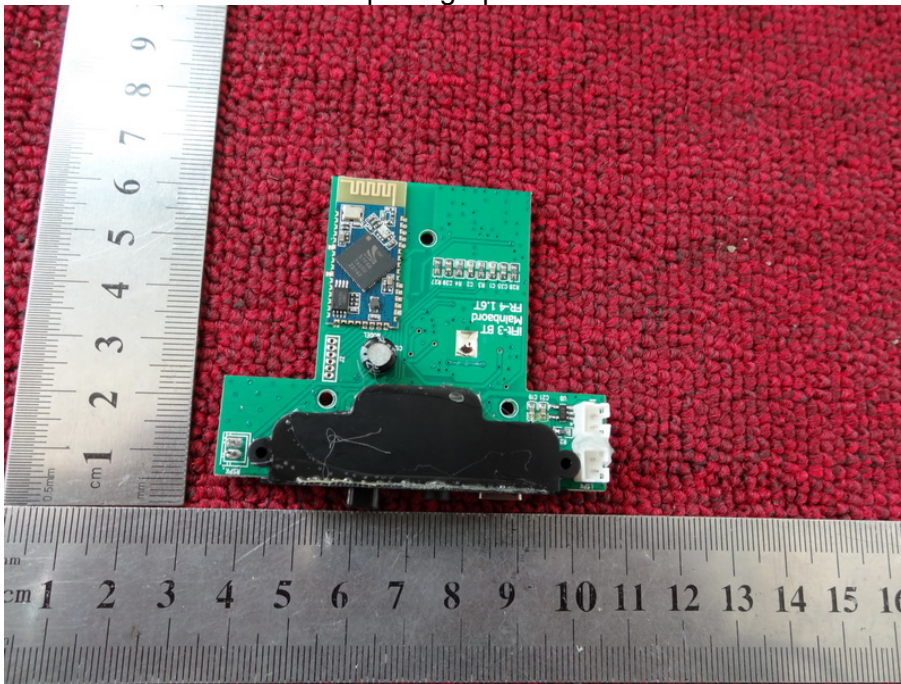

PCB photograph of EUT

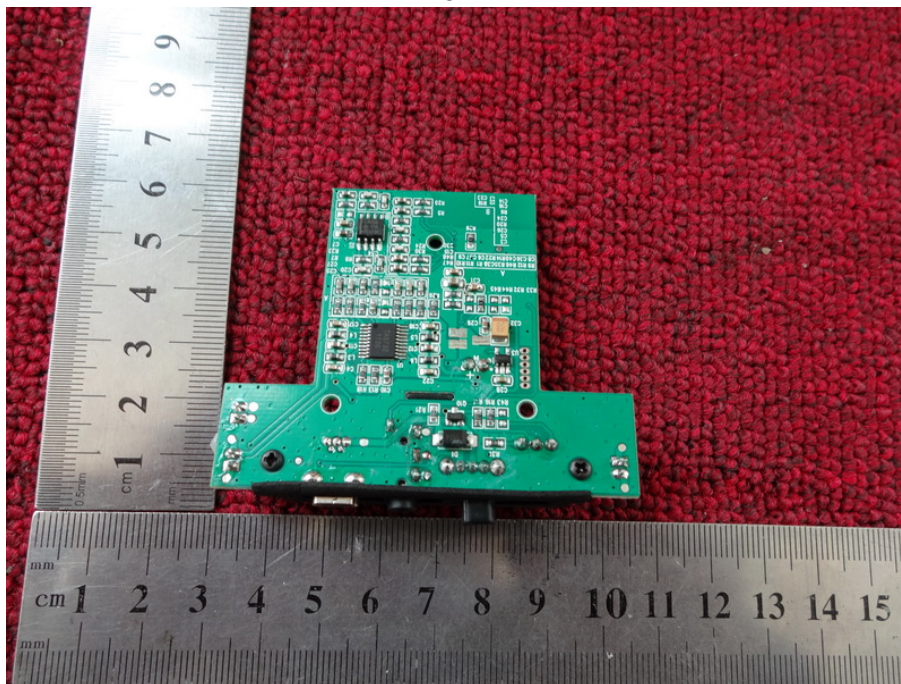

PCB photograph of EUT

