

FCC TEST REPORT

Client Name : Shenzhen Divoom Technology Co.,LTD.
Address : 1st floor, 5th Building, Xinlianhe Industrial Park Jincheng Road, Shajing Town, Bao'an, Shenzhen, China 518000
Product Name : Divoom-Backpack-M
Date : Apr. 06, 2021



Shenzhen Anbotek Compliance Laboratory Limited

Contents

1. General Information.....	5
1.1. Client Information.....	5
1.2. Description of Device (EUT).....	5
1.3. Auxiliary Equipment Used During Test.....	6
1.4. Description of Test Modes.....	6
1.5. List of channels.....	7
1.6. Description Of Test Setup.....	8
1.7. Test Equipment List.....	9
1.8. Measurement Uncertainty.....	10
1.9. Description of Test Facility.....	10
2. Summary of Test Results.....	11
2.1. Pseudorandom Frequency Hopping Sequence.....	11
3. Conducted Emission Test.....	13
3.1. Test Standard and Limit.....	13
3.2. Test Setup.....	13
3.3. Test Procedure.....	13
3.4. Test Data.....	13
4. Radiation Spurious Emission and Band Edge.....	16
4.1. Test Standard and Limit.....	16
4.2. Test Setup.....	16
4.3. Test Procedure.....	17
4.4. Test Data.....	18
5. Maximum Peak Output Power Test.....	36
5.1. Test Standard and Limit.....	36
5.2. Test Setup.....	36
5.3. Test Procedure.....	36
5.4. Test Data.....	36
6. 20DB Occupy Bandwidth Test.....	42
6.1. Test Standard.....	42
6.2. Test Setup.....	42
6.3. Test Procedure.....	42
6.4. Test Data.....	42
7. Carrier Frequency Separation Test.....	48
7.1. Test Standard and Limit.....	48
7.2. Test Setup.....	48
7.3. Test Procedure.....	48
7.4. Test Data.....	48
8. Number of Hopping Channel Test.....	52

8.1. Test Standard and Limit.....	52
8.2. Test Setup.....	52
8.3. Test Procedure.....	52
8.4. Test Data.....	52
9. Dwell Time Test.....	54
9.1. Test Standard and Limit.....	54
9.2. Test Setup.....	54
9.3. Test Procedure.....	54
9.4. Test Data.....	54
10. 100kHz Bandwidth of Frequency Band Edge Requirement.....	58
10.1. Test Standard and Limit.....	58
10.2. Test Setup.....	58
10.3. Test Procedure.....	58
10.4. Test Data.....	58
11. Antenna Requirement.....	65
11.1. Test Standard and Requirement.....	65
11.2. Antenna Connected Construction.....	65
APPENDIX I -- TEST SETUP PHOTOGRAPH.....	66
APPENDIX II -- EXTERNAL PHOTOGRAPH.....	66
APPENDIX III -- INTERNAL PHOTOGRAPH.....	66
Please refer to separated files for Internal Photos of the EUT.....	66



TEST REPORT

Applicant : Shenzhen Divoom Technology Co.,LTD.
Manufacturer : Shenzhen Divoom Technology Co.,LTD.
Product Name : Divoom-Backpack-M
Model No. : Divoom-Backpack-M
Trade Mark : Divoom
Rating(s) : Input: DC 5V, 2A
Test Standard(s) : FCC Part15 Subpart C, Section 15.247
Test Method(s) : ANSI C63.10: 2013

The device described above is tested by Shenzhen Anbotek Compliance Laboratory Limited to determine the maximum emission levels emanating from the device and the severe levels of the device can endure and its performance criterion. The measurement results are contained in this test report and Shenzhen Anbotek Compliance Laboratory Limited is assumed full of responsibility for the accuracy and completeness of these measurements. Also, this report shows that the EUT (Equipment Under Test) is technically compliant with the FCC Part 15 Subpart C requirements.

This report applies to above tested sample only and shall not be reproduced in part without written approval of Shenzhen Anbotek Compliance Laboratory Limited.

Date of receipt

Feb. 03, 2021

Date of Test

Feb. 03~Apr. 13, 2021

Prepared by



(Engineer / Ella Liang)

Reviewer



(Supervisor / Bibo Zhang)

Approved & Authorized Signer

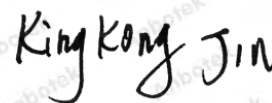

(Manager / Kingkong Jin)

1. General Information

1.1. Client Information

Applicant	:	Shenzhen Divoom Technology Co.,LTD.
Address	:	1st floor, 5th Building, Xinlianhe Industrial Park Jincheng Road, Shajing Town, Bao'an, Shenzhen, China 518000
Manufacturer	:	Shenzhen Divoom Technology Co.,LTD.
Address	:	1st floor, 5th Building, Xinlianhe Industrial Park Jincheng Road, Shajing Town, Bao'an, Shenzhen, China 518000
Factory	:	Shenzhen Divoom Technology Co.,LTD.
Address	:	1st floor, 5th Building, Xinlianhe Industrial Park Jincheng Road, Shajing Town, Bao'an, Shenzhen, China 518000

1.2. Description of Device (EUT)

Product Name	:	Divoom-Backpack-M
Model No.	:	Divoom-Backpack-M
Trade Mark	:	Divoom
Test Power Supply	:	AC 120V, 60Hz for adapter
Test Sample No.	:	1-2-1(Normal Sample), 1-2-2(Engineering Sample)
	Operation Frequency:	2402~2480MHz
	Transfer Rate:	1/2/3 Mbits/s
	Number of Channel:	79 Channels
	Modulation Type:	GFSK, $\pi/4$ -DQPSK, 8-DPSK
	Hardware version:	REV1-2
	Software version:	v59018
	Antenna Type:	PCB Antenna
	Antenna Gain(Peak):	0 dBi
Remark: 1) For a more detailed features description, please refer to the manufacturer's specifications or the User's Manual.		

1.3. Auxiliary Equipment Used During Test

Adapter	:	M/N: ETA-U90CBC S/N: RT6FB17ZS/B-E Input: 100-240V~ 50-60Hz, 0.35A Output: DC 5V, 2A
---------	---	---

1.4. Description of Test Modes

To investigate the maximum EMI emission characteristics generates from EUT, the test system was pre-scanning tested base on the consideration of following EUT operation mode or test configuration mode which possible have effect on EMI emission level. Each of these EUT operation mode(s) or test configuration mode(s) mentioned above was evaluated respectively.

TEST MODE:

Mode 1	GFSK	CH00	TX+ Charging Mode/TX Only
Mode 2		CH39	
Mode 3		CH78	
Mode 4	π/4-DQPSK	CH00	
Mode 5		CH39	
Mode 6		CH78	
Mode 7	8-DPSK	CH00	
Mode 8		CH39	
Mode 9		CH78	

Note:

(1) The measurements are performed at the highest, middle, lowest available channels.

1.5. List of channels

Channel	Freq. (MHz)	Channel	Freq. (MHz)	Channel	Freq. (MHz)	Channel	Freq. (MHz)	Channel	Freq. (MHz)
00	2402	17	2419	34	2436	51	2453	68	2470
01	2403	18	2420	35	2437	52	2454	69	2471
02	2404	19	2421	36	2438	53	2455	70	2472
03	2405	20	2422	37	2439	54	2456	71	2473
04	2406	21	2423	38	2440	55	2457	72	2474
05	2407	22	2424	39	2441	56	2458	73	2475
05	2408	23	2425	40	2442	57	2459	74	2476
07	2409	24	2426	41	2443	58	2460	75	2477
08	2410	25	2427	42	2444	59	2461	76	2478
09	2411	26	2428	43	2445	60	2462	77	2479
10	2412	27	2429	44	2446	61	2463	78	2480
11	2413	28	2430	45	2447	62	2464		
12	2414	29	2431	46	2448	63	2465		
13	2415	30	2432	47	2449	64	2466		
14	2416	31	2433	48	2450	65	2467		
15	2417	32	2434	49	2451	66	2468		
16	2418	33	2435	50	2452	67	2469		

Note:

1. The engineering test program was provided and the EUT was programmed to be in continuously transmitting mode.
2. EUT built-in battery-powered, fully-charged battery use of the test battery.

1.6. Description Of Test Setup

CE

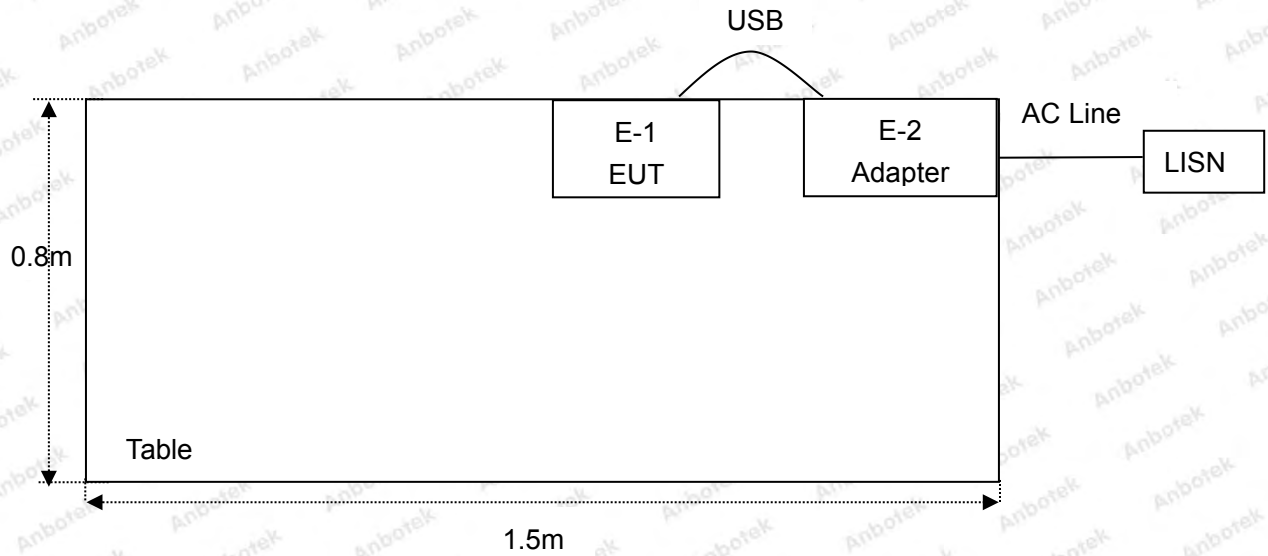

RE

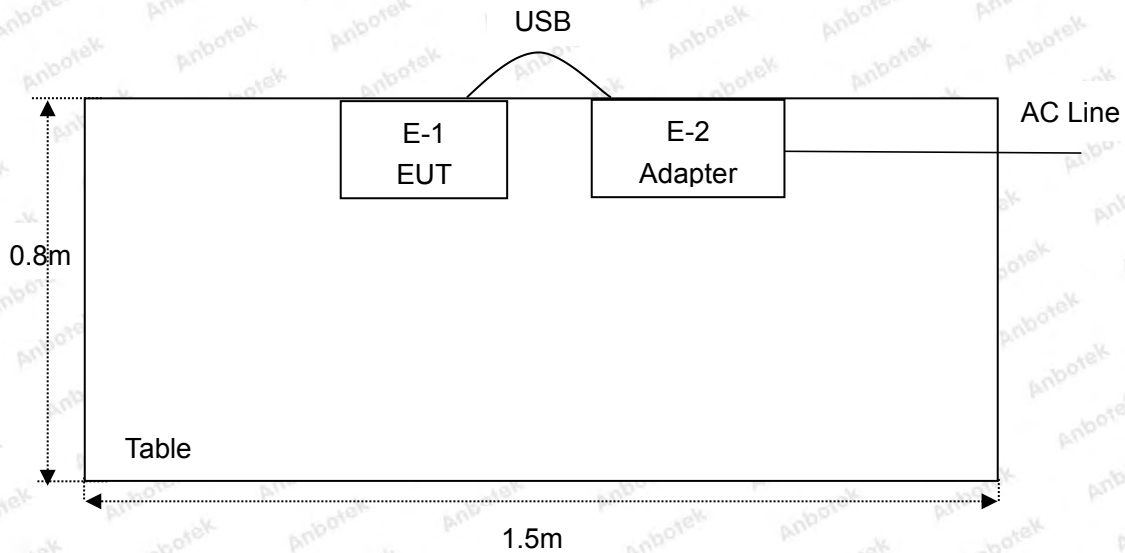

1.7. Test Equipment List

Item	Equipment	Manufacturer	Model No.	Serial No.	Last Cal.	Cal. Interval
1.	L.I.S.N. Artificial Mains Network	Rohde & Schwarz	ENV216	100055	Oct. 26, 2020	1 Year
2.	EMI Test Receiver	Rohde & Schwarz	ESCI	100627	Oct. 26, 2020	1 Year
3.	EMI Test Receiver	Rohde & Schwarz	ESR26	101481	Oct. 26, 2020	1 Year
4.	RF Switching Unit	Compliance Direction	RSU-M2	38303	Oct. 26, 2020	1 Year
5.	MAX Spectrum Analysis	Agilent	N9020A	MY51170037	Oct. 26, 2020	1 Year
6.	Preamplifier	SKET Electronic	BK1G18G30 D	KD17503	Oct. 26, 2020	1 Year
7.	Double Ridged Horn Antenna	Instruments corporation	GTH-0118	351600	Nov. 02, 2020	2 Year
8.	Bilog Broadband Antenna	Schwarzbeck	VULB9163	VULB 9163-289	Nov. 02, 2020	2 Year
9.	Loop Antenna	Schwarzbeck	FMZB1519B	00053	Nov. 02, 2020	2 Year
10.	Horn Antenna	A-INFO	LB-180400- KF	J211060628	Nov. 02, 2020	2 Year
11.	Pre-amplifier	SONOMA	310N	186860	Oct. 26, 2020	1 Year
12.	EMI Test Software EZ-EMC	SHURPLE	N/A	N/A	N/A	N/A
13.	RF Test Control System	YIHENG	YH3000	2017430	Oct. 26, 2020	1 Year
14.	Power Sensor	DAER	RPR3006W	15100041SN045	Oct. 26, 2020	1 Year
15.	Power Sensor	DAER	RPR3006W	15100041SN046	Oct. 26, 2020	1 Year
16.	MXA Spectrum Analysis	Agilent	N9020A	MY51170037	Oct. 26, 2020	1 Year
17.	MXG RF Vector Signal Generator	Agilent	N5182A	MY48180656	Oct. 26, 2020	1 Year
18.	Signal Generator	Agilent	E4421B	MY41000743	Oct. 26, 2020	1 Year
19.	DC Power Supply	IVYTECH	IV3605	1804D360510	Oct. 26, 2020	1 Year

1.8. Measurement Uncertainty

Radiation Uncertainty	:	Ur = 3.9 dB (Horizontal)
		Ur = 3.8 dB (Vertical)
Conduction Uncertainty	:	Uc = 3.4 dB

1.9. Description of Test Facility

The test facility is recognized, certified, or accredited by the following organizations:

FCC-Registration No.: 184111

Shenzhen Anbotek Compliance Laboratory Limited, EMC Laboratory has been registered and fully described in a report filed with the (FCC) Federal Communications Commission. The acceptance letter from the FCC is maintained in our files. Registration No. 184111, September 30, 2020.

ISED-Registration No.: 8058A

Shenzhen Anbotek Compliance Laboratory Limited, EMC Laboratory has been registered and fully described in a report filed with the (ISED) Innovation, Science and Economic Development Canada. The acceptance letter from the ISED is maintained in our files. Registration 8058A, September 30, 2020.

Test Location

Shenzhen Anbotek Compliance Laboratory Limited.

1/F, Building D, Sogood Science and Technology Park, Sanwei community, Hangcheng Street, Bao'an District, Shenzhen, Guangdong, China.518102

2. Summary of Test Results

Standard Section	Test Item	Result
15.203/15.247(c)	Antenna Requirement	PASS
15.207	Conducted Emission	PASS
15.205/15.209	Spurious Emission	PASS
15.247(b)(1)	Conducted Peak Output Power	PASS
15.247(a)(1)	20dB Occupied Bandwidth	PASS
15.247(a)(1)	Carrier Frequencies Separation	PASS
15.247(a)(1)	Hopping Channel Number	PASS
15.247(a)(1)	Dwell Time	PASS
15.247(d)	Band Edge	PASS
Remark: "N/A" is an abbreviation for Not Applicable.		

2.1. Pseudorandom Frequency Hopping Sequence

2.1.1. Standard Applicable

For 47 CFR Part 15C sections 15.247 (a) (1) requirement:

Frequency hopping systems shall have hopping channel carrier frequencies separated by a minimum of 25 kHz or the 20 dB bandwidth of the hop-ping channel, whichever is greater. Alternatively, frequency hopping systems operating in the 2400 – 2483.5 MHz band may have hopping channel carrier frequencies that are separated by 25 kHz or two-thirds of the 20 dB bandwidth of the hopping channel, whichever is greater, provided the systems operate with an output power no greater than 125 mW. The system shall hop to channel frequencies that are selected at the system hopping rate from a pseudo randomly ordered list of hopping frequencies. Each frequency must be used equally on the average by each transmitter. The system receivers shall have input bandwidths that match the hop-ping channel bandwidths of their corresponding transmitters and shall shift frequencies in synchronization with the transmitted signals.

2.1.2 EUT Pseudorandom Frequency Hopping Sequence Requirement

The pseudorandom frequency hopping sequence may be generated in a nice-stage shift register whose 5th first stage. The sequence begins with the first one of 9 consecutive ones, for example: the shift register is initialized with nine ones.

- Number of shift register stages:9
- Length of pseudo-random sequence:29-1=511 bits
- Longest sequence of zeros:8(non-inverted signal)

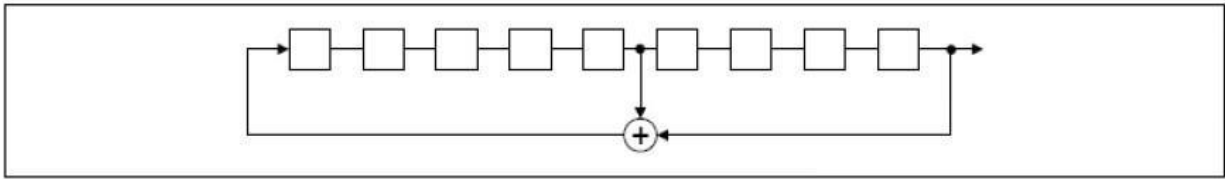

Linear Feedback Shift Register for Generation of the PRBS sequence

An example of pseudorandom frequency hopping sequence as follows:

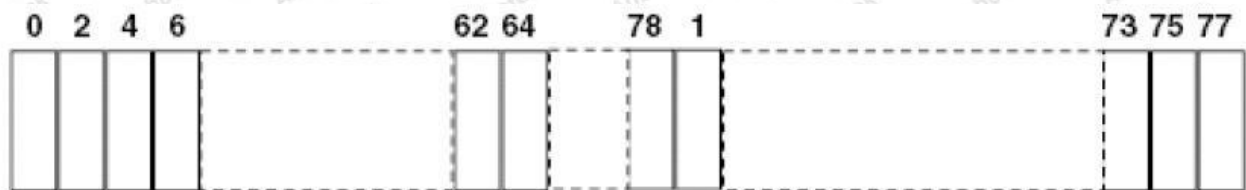

Each frequency used equally one the average by each transmitter.

The system receiver have input bandwidths that match the hopping channel bandwidths of their corresponding transmitter and shift frequencies in synchronization with the transmitted signals.

3. Conducted Emission Test

3.1. Test Standard and Limit

Test Standard	FCC Part15 Section 15.207		
Test Limit	Frequency	Maximum RF Line Voltage (dBuV)	
		Quasi-peak Level	Average Level
	150kHz~500kHz	66 ~ 56 *	56 ~ 46 *
	500kHz~5MHz	56	46
5MHz~30MHz	60	50	

Remark: (1) *Decreasing linearly with logarithm of the frequency.
(2) The lower limit shall apply at the transition frequency.

3.2. Test Setup

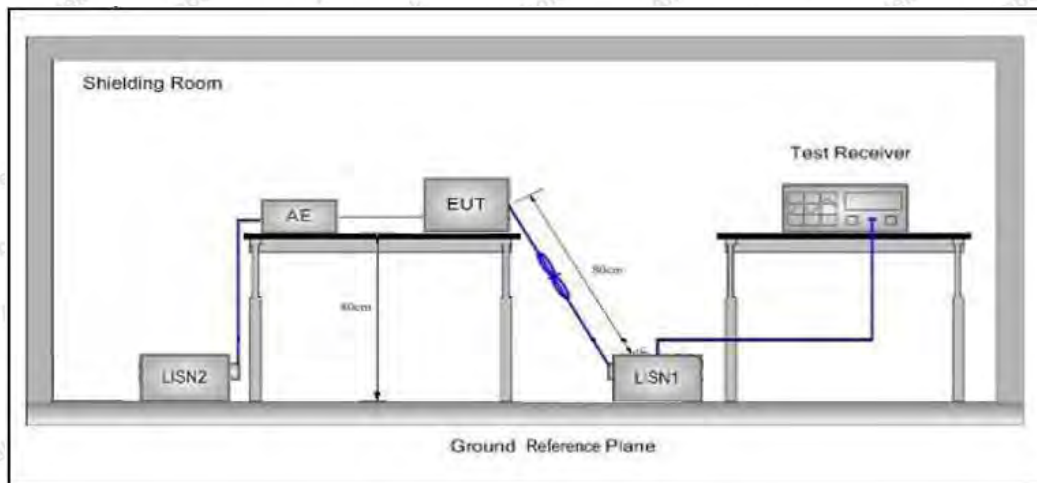

3.3. Test Procedure

The EUT system is connected to the power mains through a line impedance stabilization network (L.I.S.N.). This provides a 50ohm coupling impedance for the EUT system. Please refer the block diagram of the test setup and photographs. Both sides of AC line are checked to find out the maximum conducted emission. In order to find the maximum emission levels, the relative positions of equipment and all of the interface cables shall be changed according to FCC ANSI C63.10-2013 on Conducted Emission Measurement.

The bandwidth of test receiver (ESCI) set at 9kHz.

The frequency range from 150kHz to 30MHz is checked.

3.4. Test Data

During the test, pre-scan the GFSK, $\pi/4$ QPSK, 8DPSK modulation, and found the GFSK modulation Low channel(TX+Charging Mode) which is the worst case, only the worst case is recorded in the report. Please to see the following pages.

Conducted Emission Test Data

Test Site: 1# Shielded Room
 Operating Condition: Mode 1
 Test Specification: AC 120V, 60Hz for adapter
 Comment: Live Line
 Tem.: 22.4°C Hum.: 49%

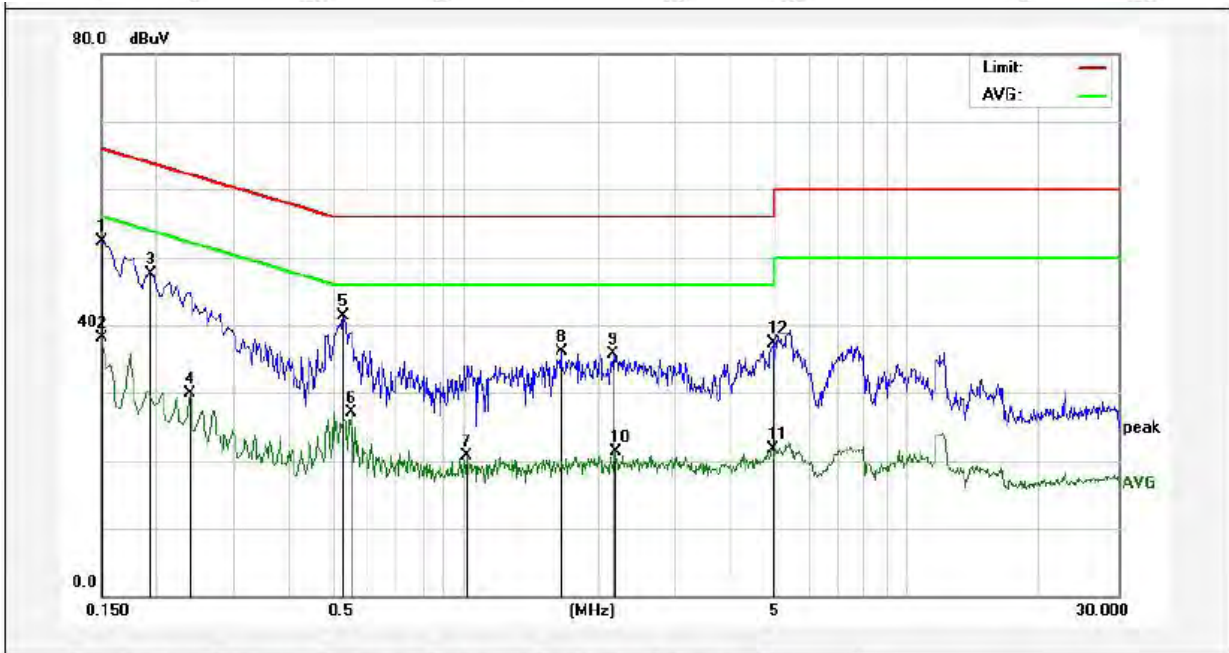

No.	Freq. (MHz)	Reading (dBuV)	Factor (dB)	Result (dBuV)	Limit (dBuV)	Over Limit (dB)	Detector	Remark
1	0.1500	32.41	19.90	52.31	65.99	-13.68	QP	
2	0.1500	18.11	19.90	38.01	55.99	-17.98	AVG	
3	0.1940	27.66	19.90	47.56	63.86	-16.30	QP	
4	0.2380	10.07	19.89	29.96	52.16	-22.20	AVG	
5	0.5299	21.30	19.99	41.29	56.00	-14.71	QP	
6	0.5540	7.18	20.00	27.18	46.00	-18.82	AVG	
7	1.0100	0.63	20.12	20.75	46.00	-25.25	AVG	
8	1.6500	15.99	20.13	36.12	56.00	-19.88	QP	
9	2.1660	15.65	20.14	35.79	56.00	-20.21	QP	
10	2.1940	1.07	20.14	21.21	46.00	-24.79	AVG	
11	4.9260	1.50	20.20	21.70	46.00	-24.30	AVG	
12	4.9540	17.09	20.21	37.30	56.00	-18.70	QP	

Conducted Emission Test Data

Test Site: 1# Shielded Room
 Operating Condition: Mode 1
 Test Specification: AC 120V, 60Hz for adapter
 Comment: Neutral Line
 Tem.: 22.4°C Hum.: 49%

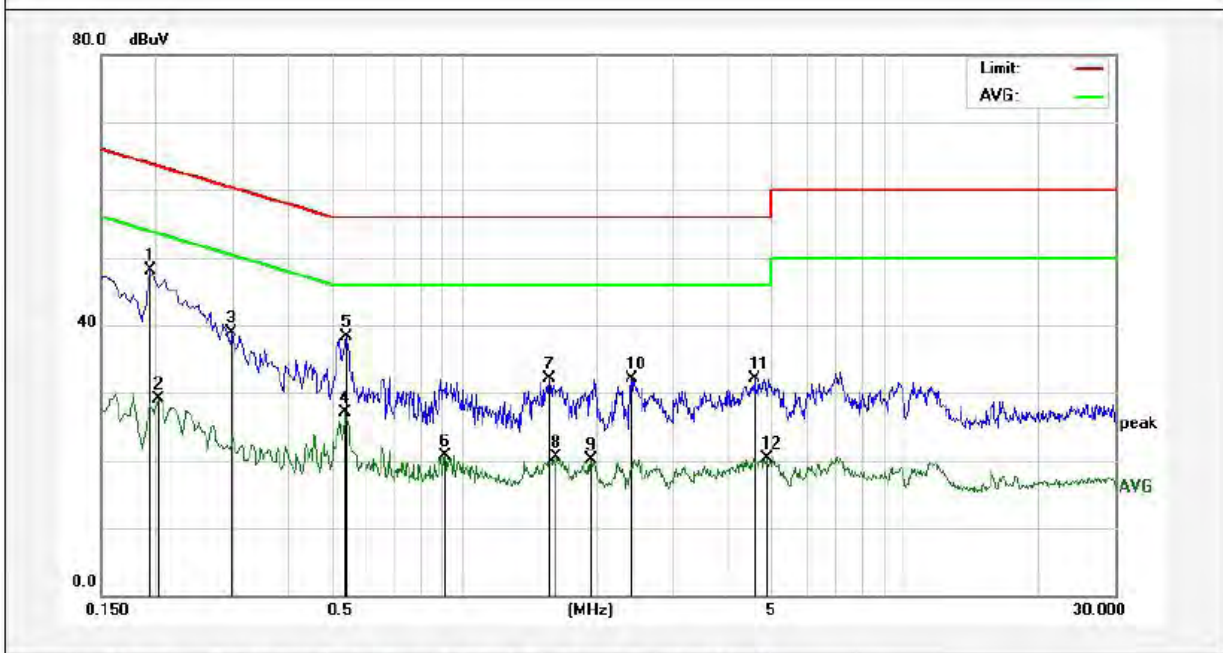

No.	Freq. (MHz)	Reading (dBuV)	Factor (dB)	Result (dBuV)	Limit (dBuV)	Over Limit (dB)	Detector	Remark
1	0.1940	28.11	19.90	48.01	63.86	-15.85	QP	
2	0.2020	9.22	19.90	29.12	53.52	-24.40	AVG	
3	0.2980	19.03	19.89	38.92	60.30	-21.38	QP	
4	0.5380	7.14	19.99	27.13	46.00	-18.87	AVG	
5	0.5420	18.39	19.99	38.38	56.00	-17.62	QP	
6	0.9060	0.64	20.09	20.73	46.00	-25.27	AVG	
7	1.5620	12.02	20.13	32.15	56.00	-23.85	QP	
8	1.6260	0.28	20.13	20.41	46.00	-25.59	AVG	
9	1.9420	0.04	20.14	20.18	46.00	-25.82	AVG	
10	2.4020	11.94	20.15	32.09	56.00	-23.91	QP	
11	4.5620	11.84	20.19	32.03	56.00	-23.97	QP	
12	4.8540	0.02	20.20	20.22	46.00	-25.78	AVG	

4. Radiation Spurious Emission and Band Edge

4.1. Test Standard and Limit

Test Standard	FCC Part15 C Section 15.209 and 15.205				
Test Limit	Frequency (MHz)	Field strength (microvolt/meter)	Limit (dBuV/m)	Remark	Measurement distance (m)
	0.009MHz~0.490MHz	2400/F(kHz)	-	-	300
	0.490MHz-1.705MHz	24000/F(kHz)	-	-	30
	1.705MHz-30MHz	30	-	-	30
	30MHz~88MHz	100	40.0	Quasi-peak	3
	88MHz~216MHz	150	43.5	Quasi-peak	3
	216MHz~960MHz	200	46.0	Quasi-peak	3
	960MHz~1000MHz	500	54.0	Quasi-peak	3
	Above 1000MHz	500	54.0	Average	3
-		-	74.0	Peak	3

Remark:

(1)The lower limit shall apply at the transition frequency.

(2) 15.35(b), Unless otherwise specified, the limit on peak radio frequency emissions is 20dB above the maximum permitted average emission limit applicable to the equipment under test. This peak limit applies to the total peak emission level radiated by the device.

4.2. Test Setup

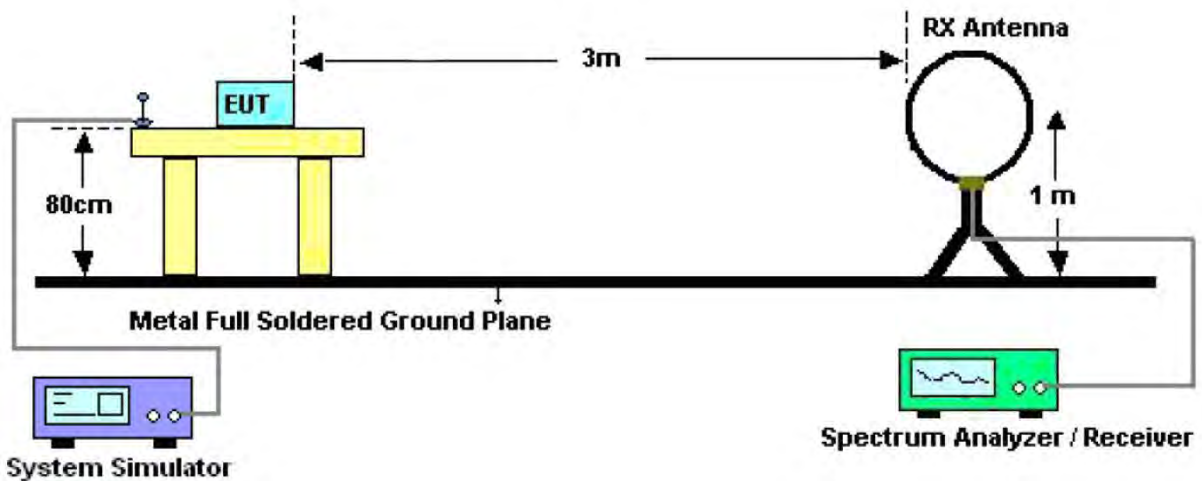

Figure 1. Below 30MHz

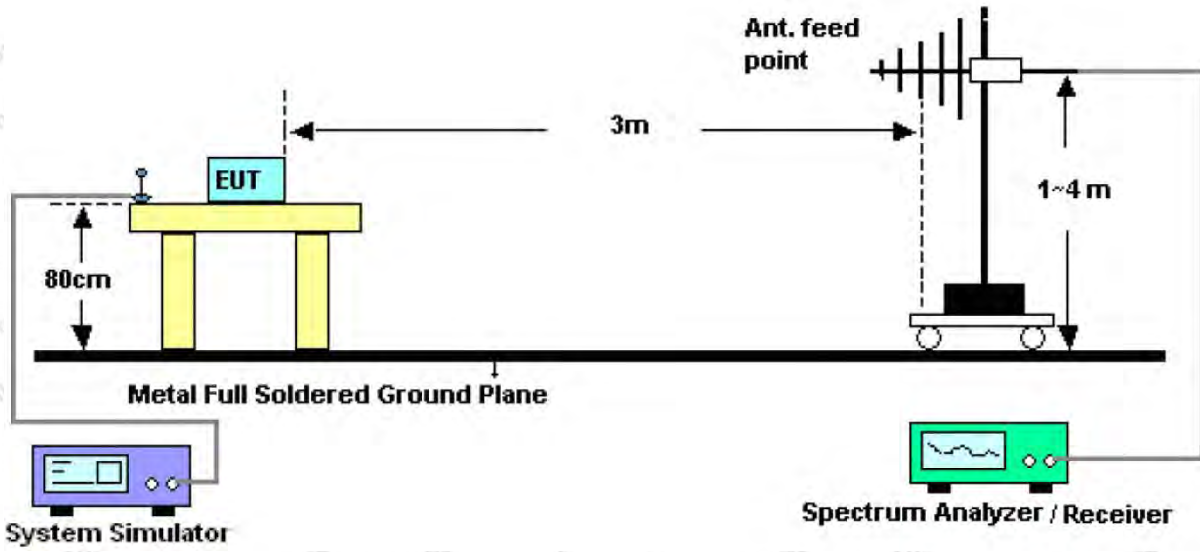

Figure 2. 30MHz to 1GHz

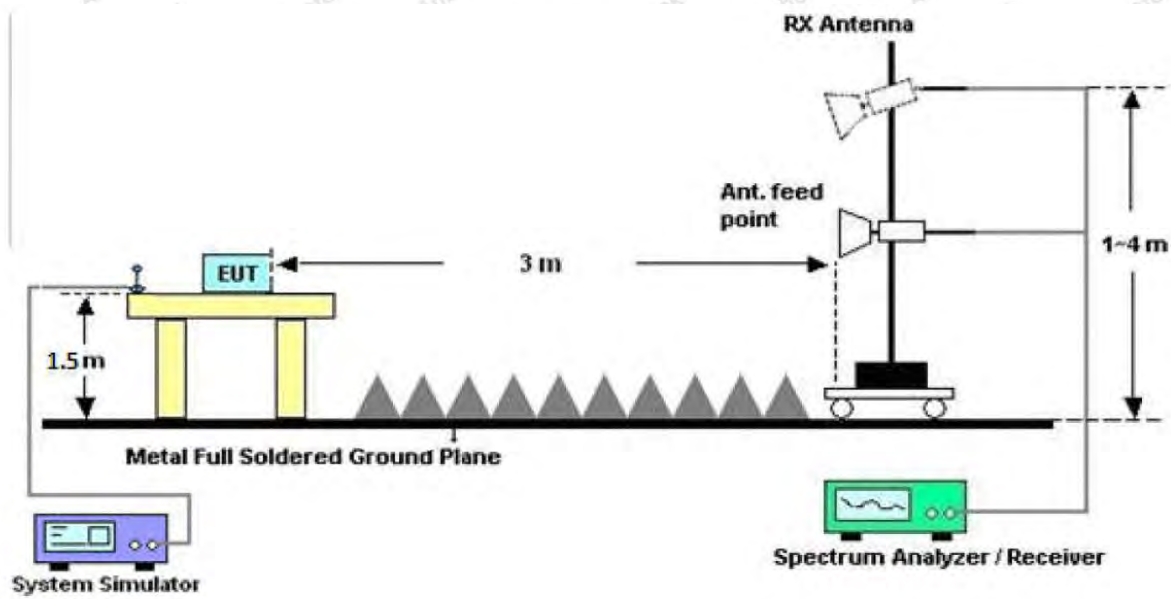

Figure 3. Above 1 GHz

4.3. Test Procedure

For below 1GHz: The EUT is placed on a turntable, which is 0.8m above the ground plane.

For above 1GHz: The EUT is placed on a turntable, which is 1.5m above the ground plane.

The turn table can rotate 360 degrees to determine the position of the maximum emission level. The EUT is set 3 meters away from the receiving antenna which is mounted on a antenna tower. The antenna can be moved up and down from 1 to 4 meters to find out the maximum emission level. Rotated the EUT through three orthogonal axes to determine the maximum emissions, both horizontal and vertical polarization of the antenna are set on test. The EUT is tested in 9*6*6 Chamber. The device is evaluated in xyz orientation.

For the radiated emission test above 1GHz:

Shenzhen Anbotek Compliance Laboratory Limited

Code:AB-RF-05-a

Address: 1/F., Building D, Sogood Science and Technology Park, Sanwei Community, Hangcheng Street, Bao'an District, Shenzhen, Guangdong, China.

Hotline
400-003-0500
www.anbotek.com

Tel:(86) 755-26066440 Fax: (86) 755-26014772 Email: service@anbotek.com

Place the measurement antenna away from each area of the EUT determined to be a source of emissions at the specified measurement distance, while keeping the measurement antenna aimed at the source of emissions at each frequency of significant emissions, with polarization oriented for maximum response. The measurement antenna may have to be higher or lower than the EUT, depending on the radiation pattern of the emission and staying aimed at the emission source for receiving the maximum signal. The final measurement antenna elevation shall be that which maximizes the emissions. The measurement antenna elevation for maximum emissions shall be restricted to a range of heights of from 1 m to 4 m above the ground or reference ground plane.

For 9kHz to 150kHz, Set the spectrum analyzer as:

RBW = 200Hz, VBW = 1kHz, Detector= Quasi-Peak, Trace mode= Max hold, Sweep- auto couple.

For 150kHz to 30MHz, Set the spectrum analyzer as:

RBW = 9kHz, VBW = 30kHz, Detector= Quasi-Peak, Trace mode= Max hold, Sweep- auto couple.

For 30MHz to 1000MHz, Set the spectrum analyzer as:

RBW = 100kHz, VBW = 300kHz, Detector= Quasi-Peak, Trace mode= Max hold, Sweep- auto couple.

For above 1GHz, Set the spectrum analyzer as:

RBW = 1MHz, VBW = 1MHz, Detector= Peak, Trace mode= Max hold, Sweep- auto couple.

RBW = 1MHz, VBW = 10Hz, Detector= Average, Trace mode= Max hold, Sweep- auto couple.

4.4. Test Data

PASS

During the test, pre-scan the GFSK, $\pi/4$ QPSK, 8DPSK modulation, and found the GFSK modulation Middle channel(Only TX Mode) which is the worst case, only the worst case is recorded in the report

The test results of 9kHz-30MHz was attenuated more than 20dB below the permissible limits, so the results don't record in the report.



Test Results (30~1000MHz)

Test Mode: Mode 2

Temp.(°C)/Hum.(%RH): 22.1°C/51%RH

Polarization: Horizontal

Power Source: AC 120V, 60Hz for adapter



No.	Freq. (MHz)	Reading (dBuV)	Factor (dB/m)	Result (dBuV/m)	Limit (dBuV/m)	Over Limit (dB)	Detector	Height (cm)	degree (deg)	Remark
1	31.6202	46.06	-18.87	27.19	40.00	-12.81	QP	100	360	
2	40.2757	41.62	-15.01	26.61	40.00	-13.39	QP	100	0	
3	125.4457	47.86	-21.12	26.74	43.50	-16.76	QP	100	360	
4	155.3644	52.03	-21.27	30.76	43.50	-12.74	QP	100	0	
5	268.4853	58.07	-17.16	40.91	46.00	-5.09	QP	100	360	
6	470.5232	51.20	-11.24	39.96	46.00	-6.04	QP	100	0	

Test Results (30~1000MHz)

Test Mode: Mode 2

Temp.(°C)/Hum.(%RH): 22.1°C/51%RH

Polarization: Vertical

Power Source: AC 120V, 60Hz for adapter



No.	Freq. (MHz)	Reading (dBuV)	Factor (dB/m)	Result (dBuV/m)	Limit (dBuV/m)	Over Limit (dB)	Detector	Height (cm)	degree (deg)	Remark
1	31.9546	50.06	-16.83	33.23	40.00	-6.77	QP	100	360	
2	36.5092	48.59	-15.47	33.12	40.00	-6.88	QP	100	0	
3	40.4172	45.87	-13.62	32.25	40.00	-7.75	QP	100	360	
4	86.2001	48.07	-16.57	31.50	40.00	-8.50	QP	100	0	
5	491.4595	51.04	-8.82	42.22	46.00	-3.78	QP	100	360	
6	900.1474	41.97	-1.70	40.27	46.00	-5.73	QP	100	0	

Test Results (1GHz-25GHz)

Test Mode: CH00					Test channel: Lowest			
Peak Value								
Frequency (MHz)	Read Level (dBuV)	Antenna Factor (dB/m)	Cable Loss (dB)	Preamp Factor (dB)	Level (dBuV/m)	Limit (dBuV/m)	Over Limit (dB)	Pol.
4804.00	39.94	34.04	6.58	34.09	46.47	74.00	-27.53	V
7206.00	33.58	37.11	7.73	34.50	43.92	74.00	-30.08	V
9608.00	33.02	39.31	9.23	34.79	46.77	74.00	-27.23	V
12010.00	*					74.00		V
14412.00	*					74.00		V
4804.00	44.76	34.04	6.58	34.09	51.29	74.00	-22.71	H
7206.00	35.57	37.11	7.73	34.50	45.91	74.00	-28.09	H
9608.00	32.70	39.31	9.23	34.79	46.45	74.00	-27.55	H
12010.00	*					74.00		H
14412.00	*					74.00		H
Average Value								
Frequency (MHz)	Read Level (dBuV)	Antenna Factor (dB/m)	Cable Loss (dB)	Preamp Factor (dB)	Level (dBuV/m)	Limit (dBuV/m)	Over Limit (dB)	Pol.
4804.00	28.26	34.04	6.58	34.09	34.79	54.00	-19.21	V
7206.00	21.97	37.11	7.73	34.50	32.31	54.00	-21.69	V
9608.00	20.88	39.31	9.23	34.79	34.63	54.00	-19.37	V
12010.00	*					54.00		V
14412.00	*					54.00		V
4804.00	32.77	34.04	6.58	34.09	39.30	54.00	-14.70	H
7206.00	24.31	37.11	7.73	34.50	34.65	54.00	-19.35	H
9608.00	20.83	39.31	9.23	34.79	34.58	54.00	-19.42	H
12010.00	*					54.00		H
14412.00	*					54.00		H

Test Results (1GHz-25GHz)

Test Mode: CH39					Test channel: Middle			
Peak Value								
Frequency (MHz)	Read Level (dBuV)	Antenna Factor (dB/m)	Cable Loss (dB)	Preamp Factor (dB)	Level (dBuV/m)	Limit (dBuV/m)	Over Limit (dB)	Pol.
4882.00	39.70	34.38	6.69	34.09	46.68	74.00	-27.32	V
7323.00	33.42	37.22	7.78	34.53	43.89	74.00	-30.11	V
9764.00	32.88	39.46	9.35	34.80	46.89	74.00	-27.11	V
12205.00	*					74.00		V
14646.00	*					74.00		V
4882.00	44.47	34.38	6.69	34.09	51.45	74.00	-22.55	H
7323.00	35.38	37.22	7.78	34.53	45.85	74.00	-28.15	H
9764.00	32.53	39.46	9.35	34.80	46.54	74.00	-27.46	H
12205.00	*					74.00		H
14646.00	*					74.00		H
Average Value								
Frequency (MHz)	Read Level (dBuV)	Antenna Factor (dB/m)	Cable Loss (dB)	Preamp Factor (dB)	Level (dBuV/m)	Limit (dBuV/m)	Over Limit (dB)	Pol.
4882.00	28.08	34.38	6.69	34.09	35.06	54.00	-18.94	V
7323.00	21.85	37.22	7.78	34.53	32.32	54.00	-21.68	V
9764.00	20.78	39.46	9.35	34.80	34.79	54.00	-19.21	V
12205.00	*					54.00		V
14646.00	*					54.00		V
4882.00	32.58	34.38	6.69	34.09	39.56	54.00	-14.44	H
7323.00	24.18	37.22	7.78	34.53	34.65	54.00	-19.35	H
9764.00	20.70	39.46	9.35	34.80	34.71	54.00	-19.29	H
12205.00	*					54.00		H
14646.00	*					54.00		H

Test Results (1GHz-25GHz)

Test Mode: CH78					Test channel: Highest			
Peak Value								
Frequency (MHz)	Read Level (dBuV)	Antenna Factor (dB/m)	Cable Loss (dB)	Preamp Factor (dB)	Level (dBuV/m)	Limit (dBuV/m)	Over Limit (dB)	Pol.
4960.00	38.49	34.72	6.79	34.09	45.91	74.00	-28.09	V
7440.00	32.62	37.34	7.82	34.57	43.21	74.00	-30.79	V
9920.00	32.17	39.62	9.46	34.81	46.44	74.00	-27.56	V
12400.00	*					74.00		V
14880.00	*					74.00		V
4960.00	43.02	34.72	6.79	34.09	50.44	74.00	-23.56	H
7440.00	34.48	37.34	7.82	34.57	45.07	74.00	-28.93	H
9920.00	31.70	39.62	9.46	34.81	45.97	74.00	-28.03	H
12400.00	*					74.00		H
14880.00	*					74.00		H
Average Value								
Frequency (MHz)	Read Level (dBuV)	Antenna Factor (dB/m)	Cable Loss (dB)	Preamp Factor (dB)	Level (dBuV/m)	Limit (dBuV/m)	Over Limit (dB)	Pol.
4960.00	27.21	34.72	6.79	34.09	34.63	54.00	-19.37	V
7440.00	21.25	37.34	7.82	34.57	31.84	54.00	-22.16	V
9920.00	20.25	39.62	9.46	34.81	34.52	54.00	-19.48	V
12400.00	*					54.00		V
14880.00	*					54.00		V
4960.00	31.58	34.72	6.79	34.09	39.00	54.00	-15.00	H
7440.00	23.52	37.34	7.82	34.57	34.11	54.00	-19.89	H
9920.00	20.09	39.62	9.46	34.81	34.36	54.00	-19.64	H
12400.00	*					54.00		H
14880.00	*					54.00		H





Remark:

1. During the test, pre-scan the GFSK, $\pi/4$ QPSK, 8DPSK modulation, and found the GFSK modulation is worse case, the report only record this mode.
2. Level =Receiver Read level + Antenna Factor + Cable Loss – Pre-amplifier Factor
3. "*" means the test results were attenuated more than 20dB below the permissible limits, so the results don't record in the report.





Radiated Band Edge:

Test Mode: GFSK(CH00)	Test channel: Lowest
Average Value(Vertical)	Average Value(Horizontal)
Peak Value(Vertical)	Peak Value(Horizontal)

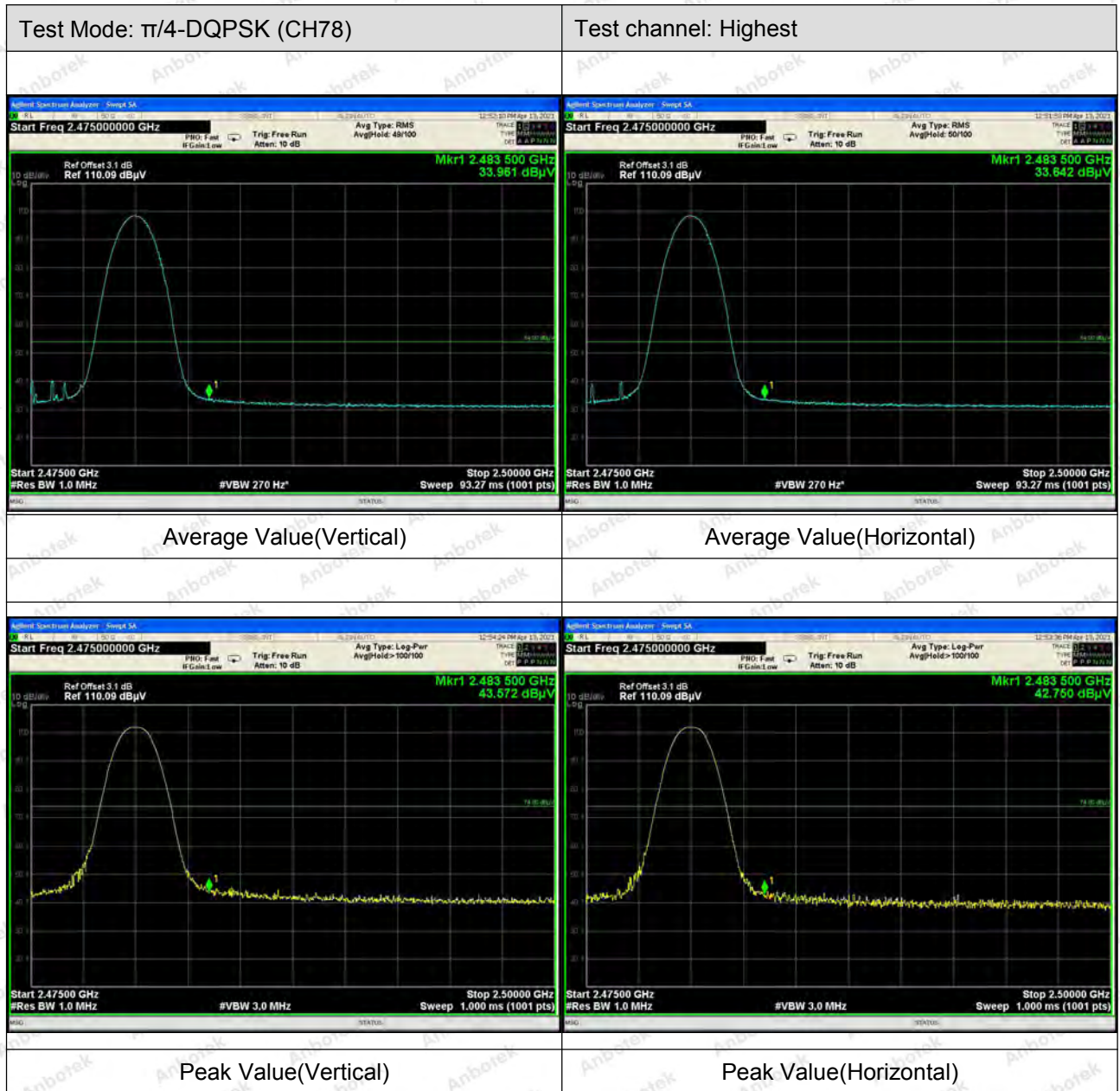

Test Mode: $\pi/4$ -DQPSK (CH00)		Test channel: Lowest	
			
Average Value(Vertical)		Average Value(Horizontal)	
			
Peak Value(Vertical)		Peak Value(Horizontal)	



Test Mode: 8-DPSK (CH00)	Test channel: Lowest
	
Average Value(Vertical)	Average Value(Horizontal)
	
Peak Value(Vertical)	Peak Value(Horizontal)

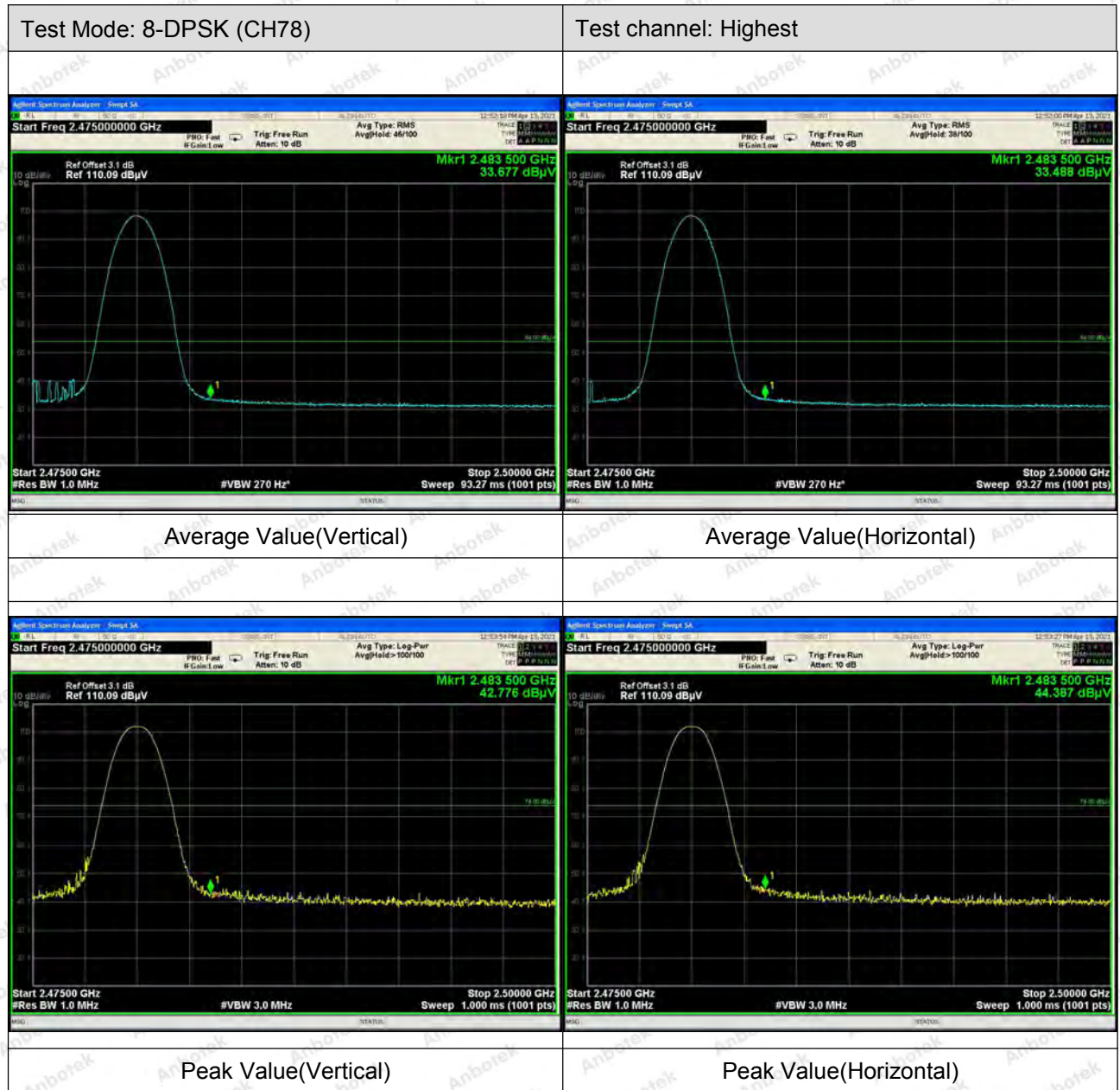

Frequency hopping:







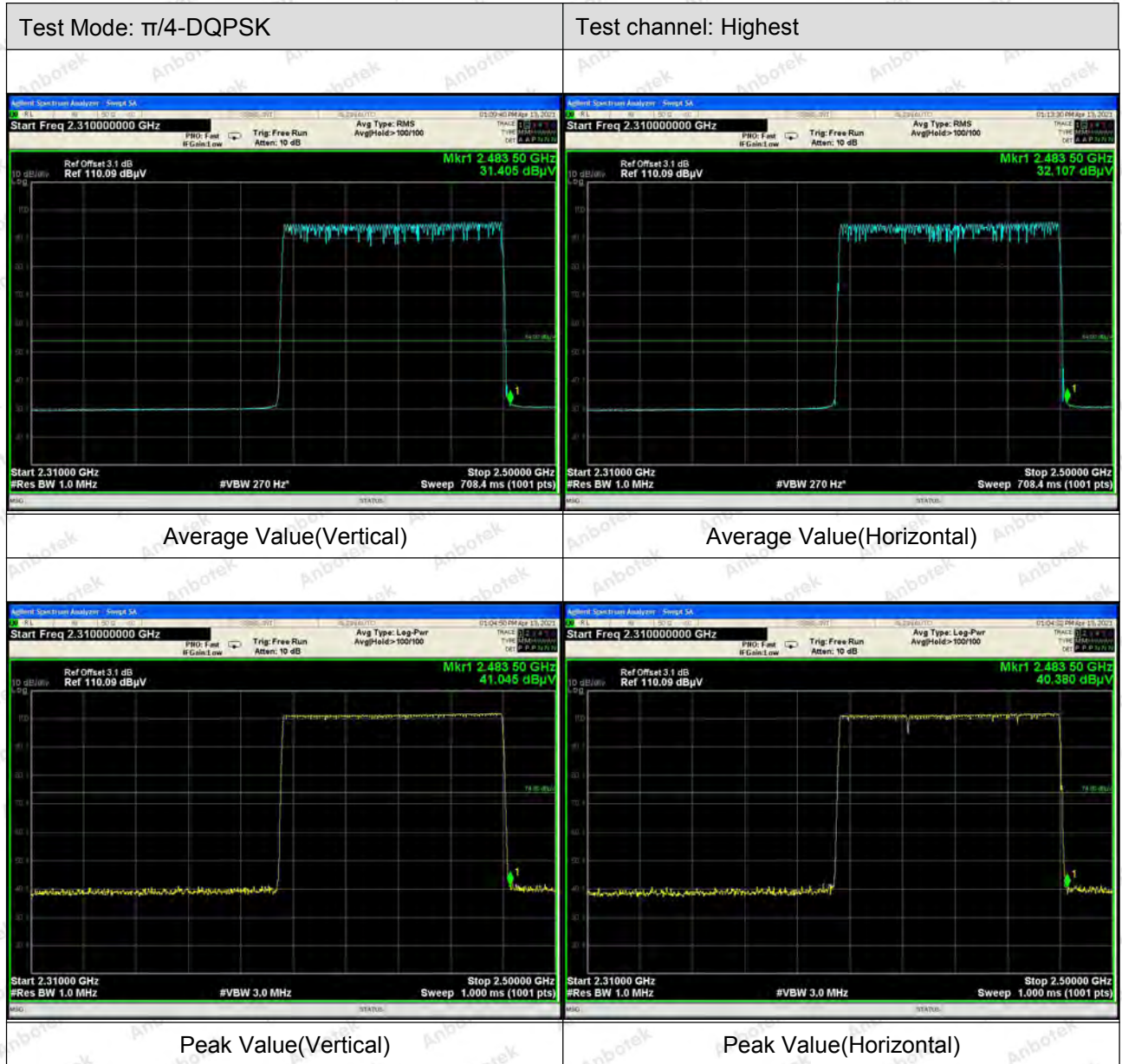

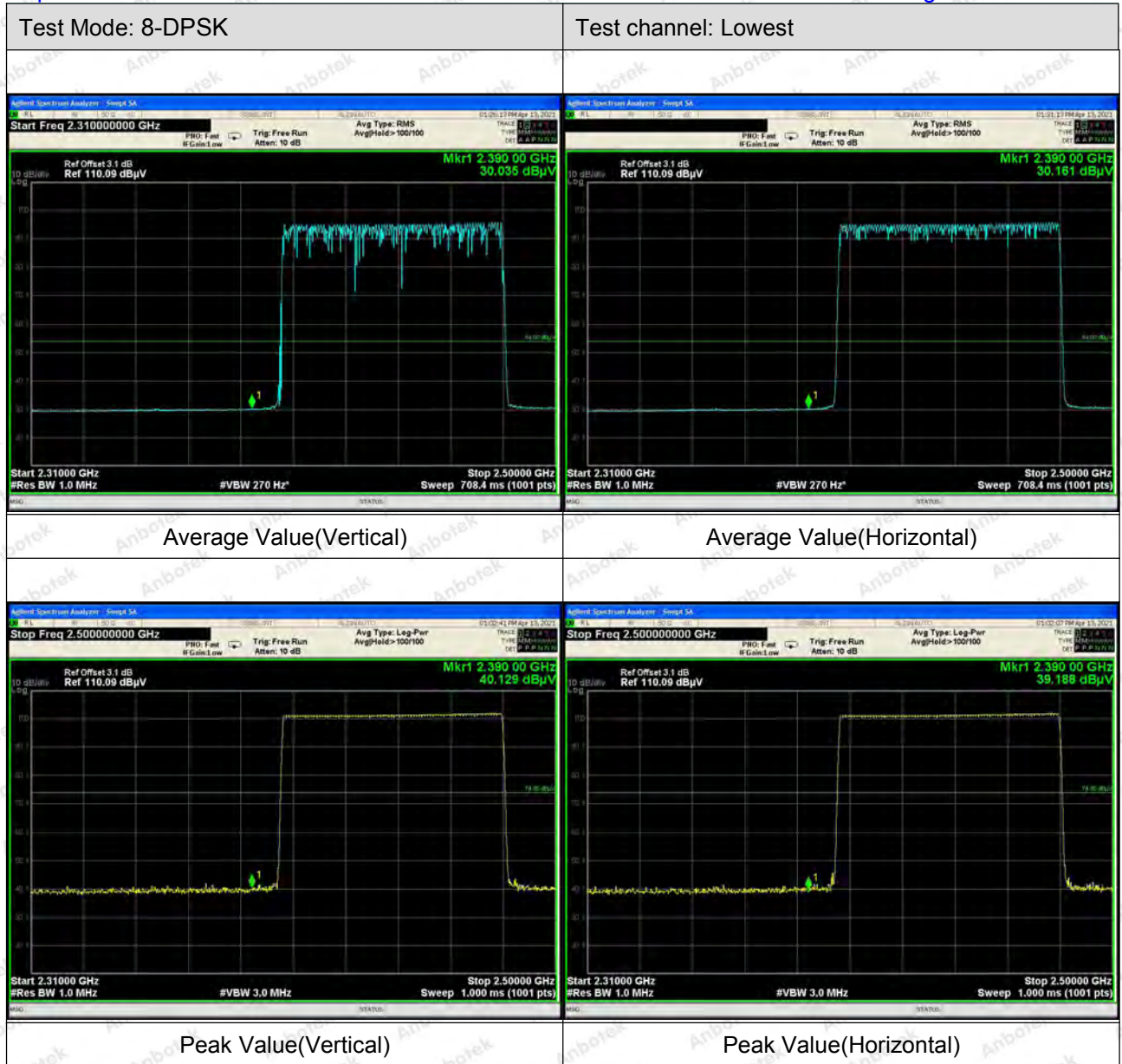



5. Maximum Peak Output Power Test

5.1. Test Standard and Limit

Test Standard	FCC Part15 C Section 15.247 (b)(3)
Test Limit	125mW

5.2. Test Setup

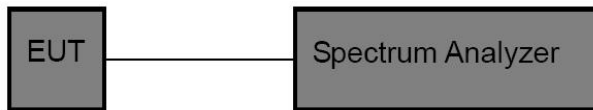

5.3. Test Procedure

- The EUT was directly connected to the spectrum analyzer and antenna output port as show in the block diagram above,
- Spectrum Setting:
 - RBW > the 20 dB bandwidth of the emission being measured
 - Span = approximately 5 times the 20 dB bandwidth, centered on a hopping channel
 - VBW ≥ RBW
 - Sweep = auto
 - Detector function = peak
 - Trace = max hold

5.4. Test Data

Test Item	: Max. peak output power	Test Mode	: CH Low ~ CH High
Test Voltage	: AC 120V, 60Hz for adapter	Temperature	: 22.7°C
Test Result	: PASS	Humidity	: 52%RH

For power test the duty cycle is 100% in continous transmitting mode.

Channel Frequency (MHz)	Peak Power output (dBm)	Limit (dBm)	Results	Modulation
2402	1.704	20.96	PASS	GFSK
2441	1.928	20.96	PASS	GFSK
2480	1.865	20.96	PASS	GFSK
2402	1.181	20.96	PASS	$\pi/4$ DQPSK
2441	1.455	20.96	PASS	$\pi/4$ DQPSK
2480	1.857	20.96	PASS	$\pi/4$ DQPSK
2402	1.173	20.96	PASS	8DPSK
2441	1.547	20.96	PASS	8DPSK
2480	1.661	20.96	PASS	8DPSK



Test Mode: BDR---Low



Test Mode: BDR---Middle



Test Mode: BDR---High



Test Mode: $\pi/4$ DQPSK ---Low



Test Mode: $\pi/4$ DQPSK ---Middle



Test Mode: $\pi/4$ DQPSK ---High



Test Mode: 8DPSK --- Low



Test Mode: 8DPSK --- Middle



Test Mode: 8DPSK --- High

6. 20DB Occupy Bandwidth Test

6.1. Test Standard

Test Standard	FCC Part15 C Section 15.247 (a)(1)
---------------	------------------------------------

6.2. Test Setup

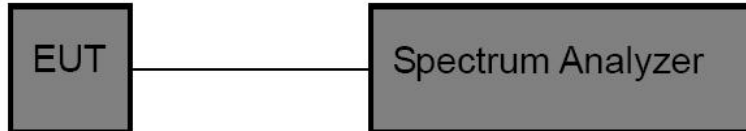

6.3. Test Procedure

Using the following spectrum analyzer settings:

1. Span= approximately 2 to 3 times the 20dB bandwidth, centered on a hopping channel.
2. Set the RBW = 30 kHz.
3. Set the VBW = 100 kHz.
4. Sweep time = auto couple.
5. Detector function = peak.
6. Trace mode = max hold.
7. Allow trace to fully stabilize.

6.4. Test Data

Test Item	: 20dB BW	Test Mode	: CH Low ~ CH High
Test Voltage	: AC 120V, 60Hz for adapter	Temperature	: 22.7°C
Test Result	: PASS	Humidity	: 52%RH

Channel	Frequency(MHz)	20dB Down BW(kHz)	Modulation Mode
Low	2402	868.0	BDR
Middle	2441	885.0	BDR
High	2480	890.6	BDR
Low	2402	1.104	$\pi/4$ DQPSK
Middle	2441	1.110	$\pi/4$ DQPSK
High	2480	1.109	$\pi/4$ DQPSK
Low	2402	1.061	8DPSK
Middle	2441	1.069	8DPSK
High	2480	1.066	8DPSK

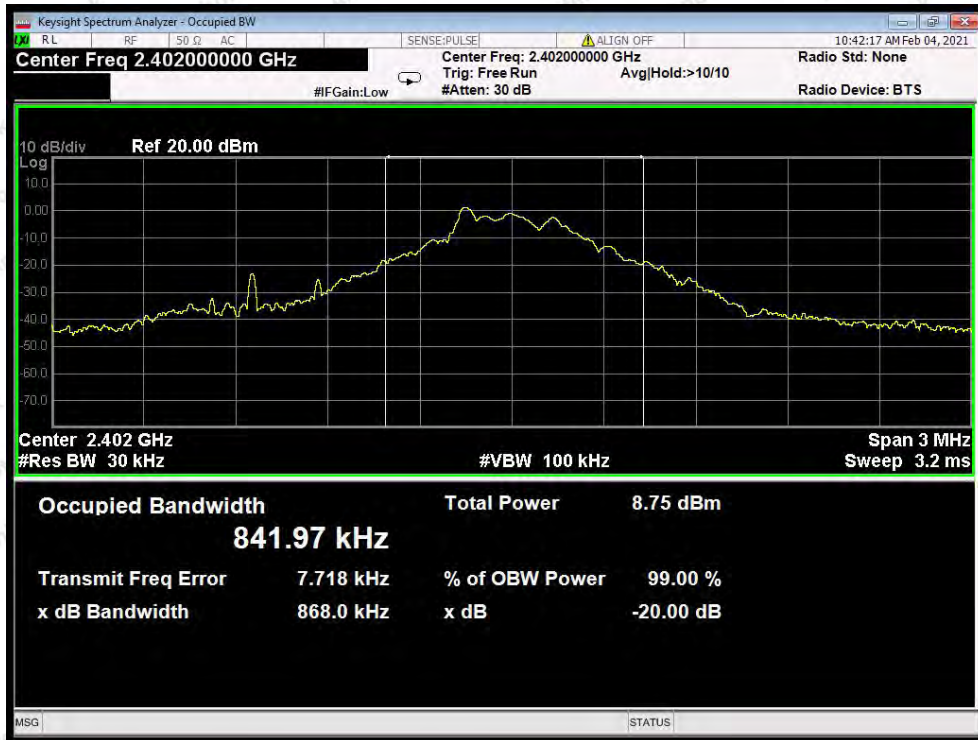

Test Mode: BDR---Low

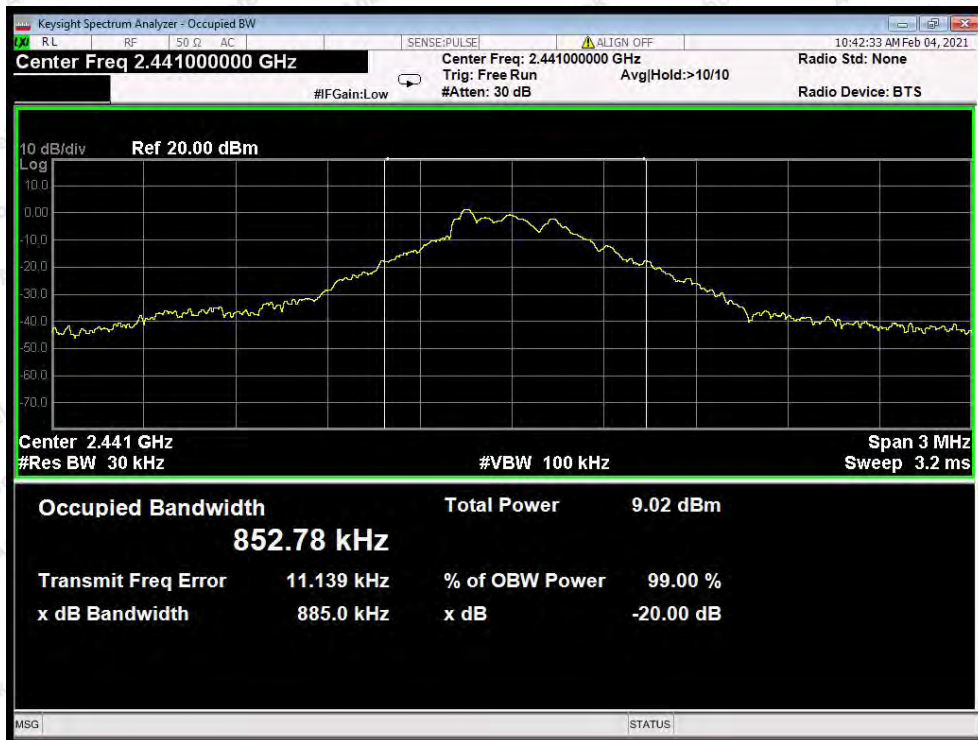

Test Mode: BDR---Middle

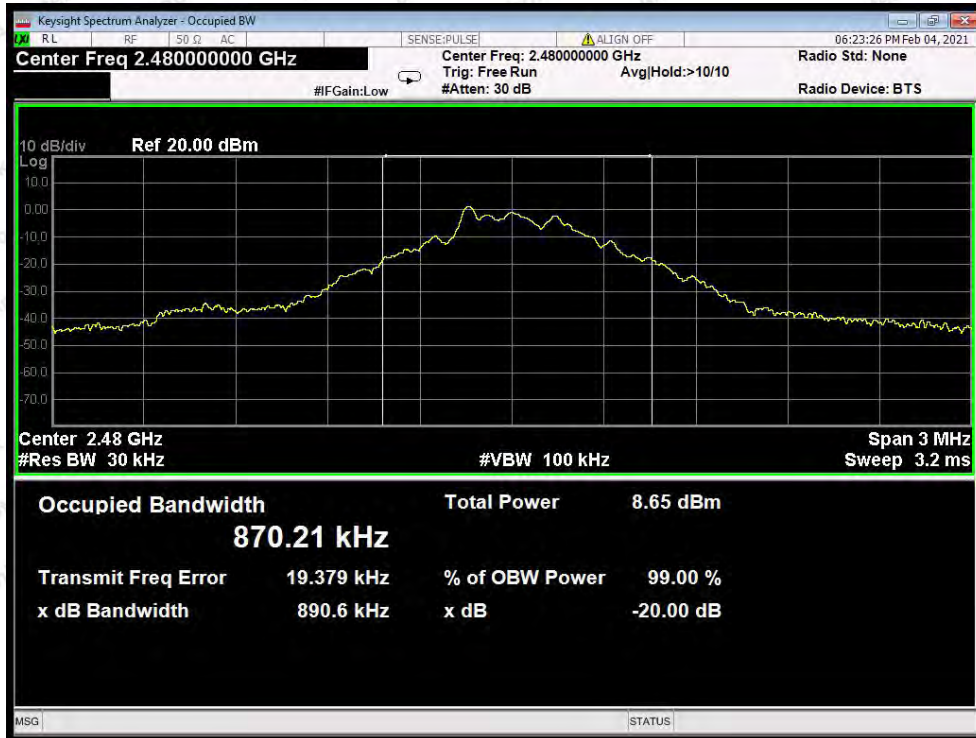

Test Mode: BDR---High



Test Mode: $\pi/4$ DQPSK ---Low

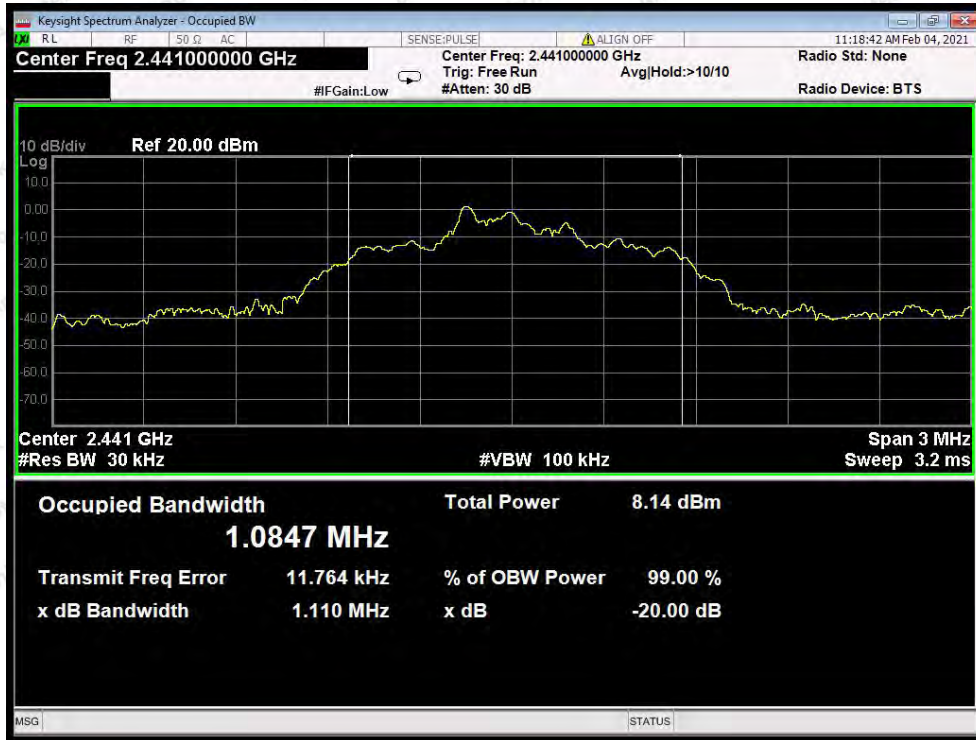

Test Mode: $\pi/4$ DQPSK ---Middle

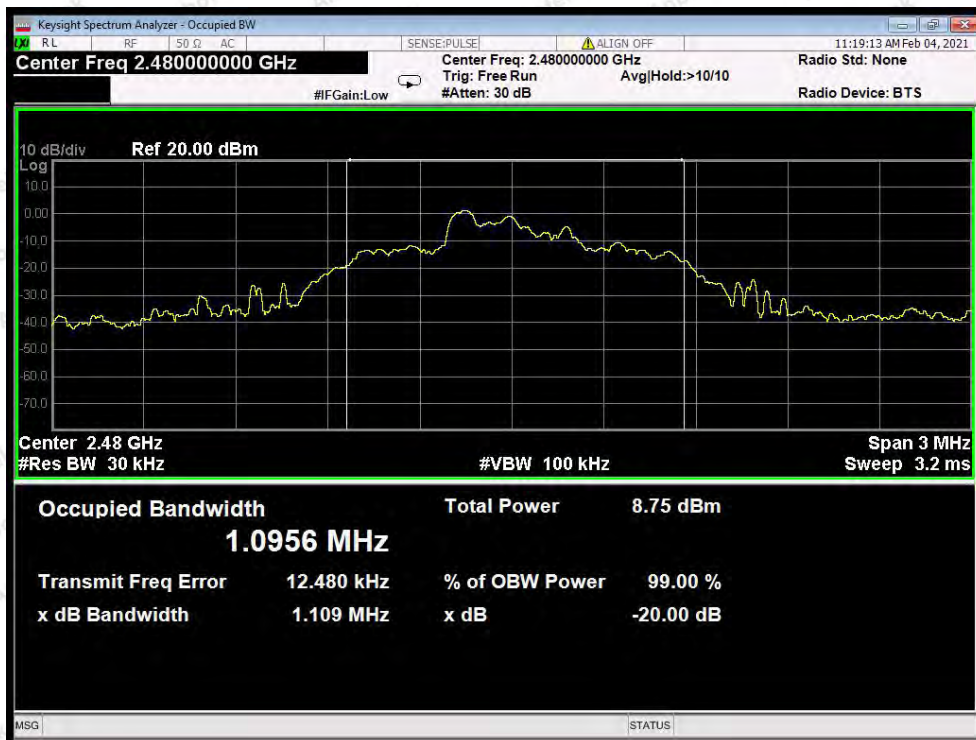

Test Mode: $\pi/4$ DQPSK ---High

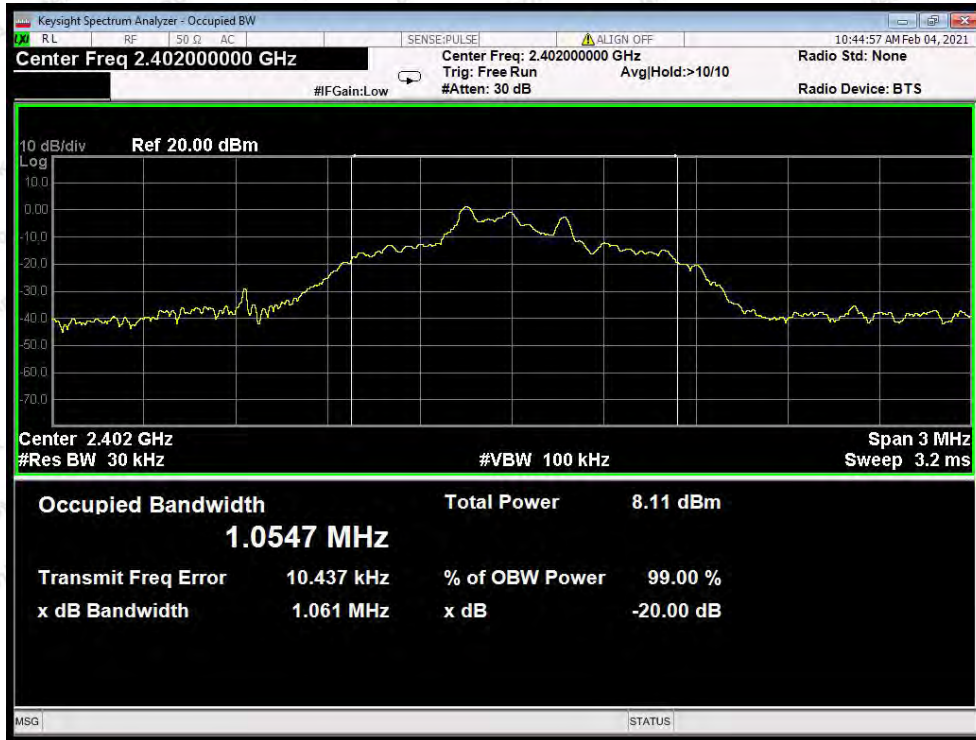

Test Mode: 8DPSK ---Low

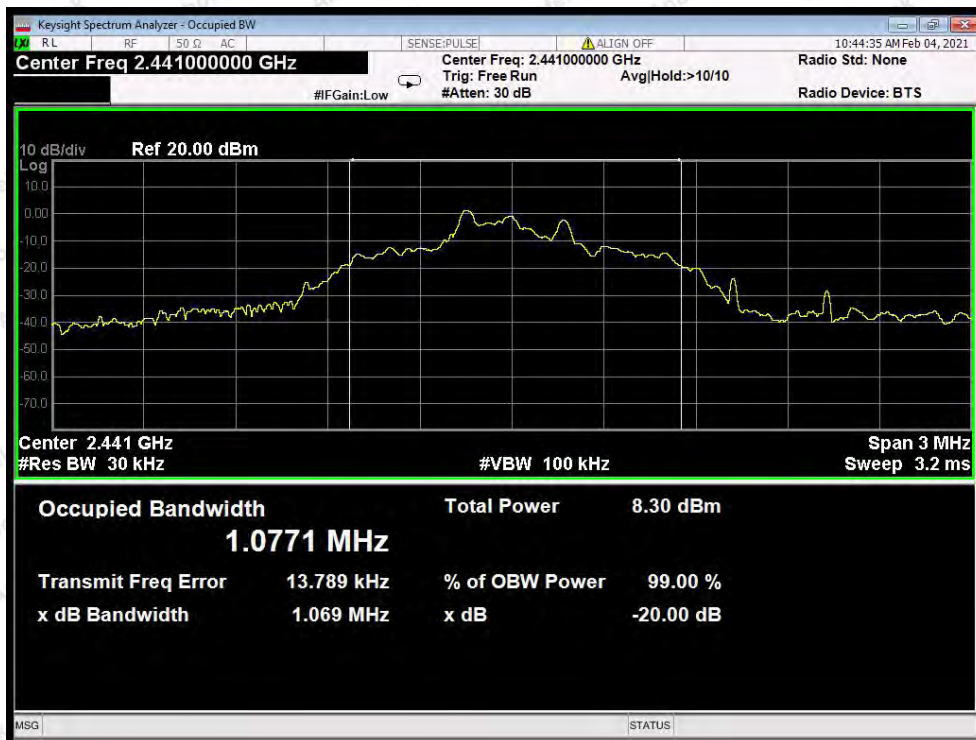

Test Mode: 8DPSK --- Middle

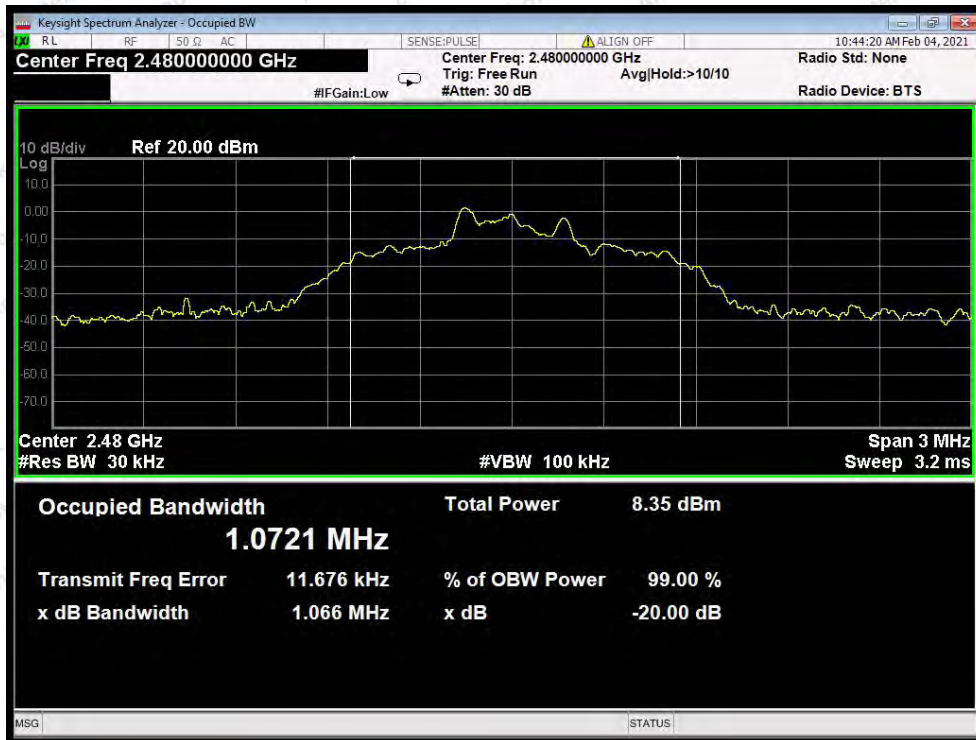

Test Mode: 8DPSK --- High

7. Carrier Frequency Separation Test

7.1. Test Standard and Limit

Test Standard	FCC Part15 C Section 15.247 (a)(1)
Test Limit	>25KHz or >two-thirds of the 20 dB bandwidth

7.2. Test Setup

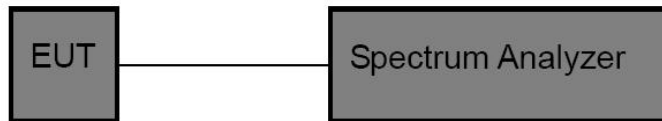

7.3. Test Procedure

The EUT must have its hopping function enabled. Using the following spectrum analyzer settings:

1. Span= Wide enough to capture the peaks of two adjacent channels
2. Set the RBW = 30 kHz.
3. Set the VBW = 100 kHz.
4. Sweep time = auto couple.
5. Detector function = peak.
6. Trace mode = max hold.
7. Allow trace to fully stabilize.

7.4. Test Data

Test Item	: Frequency Separation	Test Mode	: CH Low ~ CH High
Test Voltage	: AC 120V, 60Hz for adapter	Temperature	: 22.7°C
Test Result	: PASS	Humidity	: 52%RH

Channel	Frequency (MHz)	Separation Read Value (kHz)	Limit (kHz)	Modulation Mode
Low	2402	1002	868.0	BDR
Middle	2441	1002	885.0	BDR
High	2480	1002	890.6	BDR
Low	2402	1002	707.33	EDR
Middle	2441	1008	712.67	EDR
High	2480	1000	710.67	EDR

Remark: 1. The EDR was tested on ($\pi/4$ QPSK, 8DPSK) modes, only the worst data of (8DPSK) is attached in the following pages.

2. The limit of EDR is 2/3 of 20dB BW.



Test Mode: BDR---Low



Test Mode: BDR---Middle



Test Mode: BDR---High



Test Mode: EDR---Low



Test Mode: EDR---Middle



Test Mode: EDR---High

8. Number of Hopping Channel Test

8.1. Test Standard and Limit

Test Standard	FCC Part15 C Section 15.247 (a)(1)
Test Limit	>15 channels

8.2. Test Setup

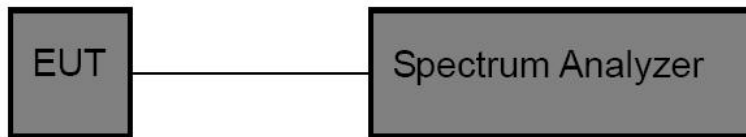

8.3. Test Procedure

The EUT must have its hopping function enabled. Using the following spectrum analyzer setting:

1. Span= the frequency band of operation
2. Set the RBW = 100kHz.
3. Set the VBW = 300kHz.
4. Sweep time = auto couple.
5. Detector function = peak.
6. Trace mode = max hold.
7. Allow trace to fully stabilize.

8.4. Test Data

Test Item	: Number of Hopping Frequency	Test Mode	: CH Low ~ CH High
Test Voltage	: AC 120V, 60Hz for adapter	Temperature	: 22.7°C
Test Result	: PASS	Humidity	: 52%RH

Hopping Channel Frequency Range	Quantity of Hopping Channel	Quantity of Hopping Channel
2402-2480MHz	79	> 15

Remark: The EDR was tested on ($\pi/4$ QPSK, 8DPSK) modes, only the worst data of (8DPSK) is attached in the following pages.

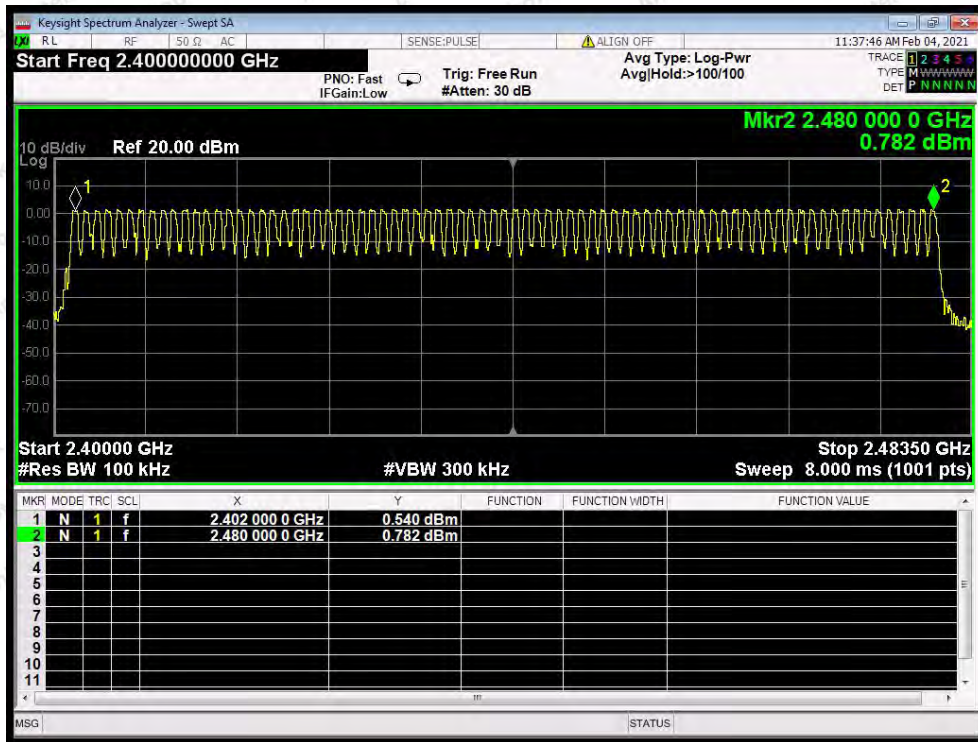

BDR Mode

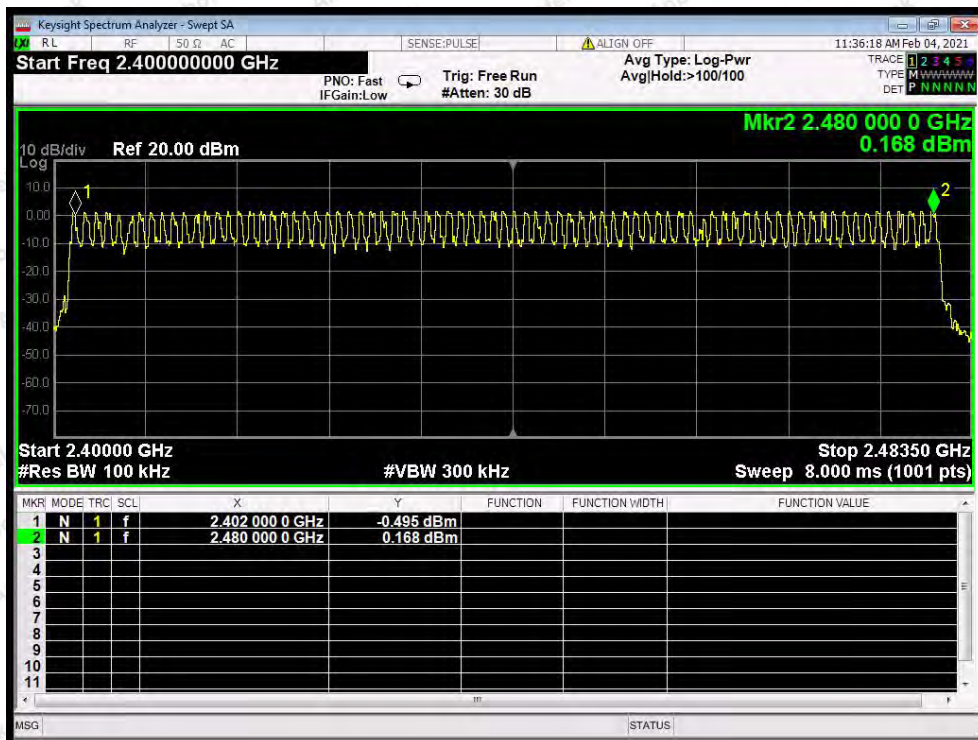

EDR Mode

9. Dwell Time Test

9.1. Test Standard and Limit

Test Standard	FCC Part15 C Section 15.247 (a)(1)
Test Limit	0.4 sec

9.2. Test Setup

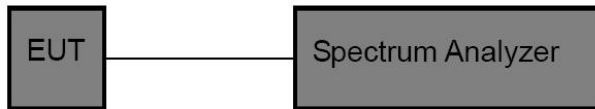

9.3. Test Procedure

The EUT must have its hopping function enabled. Use the following spectrum analyzer settings:

1. Span= zero span, centered on a hopping channel
2. Set the RBW = 1 MHz.
3. Set the VBW = 1 MHz.
4. Sweep time = as necessary to capture the entire dwell time per hopping channel.
5. Detector function = peak.
6. Trace mode = max hold.
7. Allow trace to fully stabilize.

9.4. Test Data

Test Item	: Time of Occupancy	Test Mode	: CH Low ~ CH High
Test Voltage	: AC 120V, 60Hz for adapter	Temperature	: 22.7°C
Test Result	: PASS	Humidity	: 52%RH

Package Type	Pulse width (ms)	Time slot length(ms)	Dwell time (ms)	Limit (s)	Modulation
DH1	0.458	time slot length *1600/2 /79 * 31.6	146.56	0.4	BDR
DH3	1.720	time slot length *1600/4 /79 * 31.6	275.20	0.4	BDR
DH5	2.976	time slot length *1600/6 /79 * 31.6	317.44	0.4	BDR
3DH1	0.462	time slot length *1600/2 /79 * 31.6	147.84	0.4	EDR
3DH3	1.745	time slot length *1600/4 /79 * 31.6	279.20	0.4	EDR
3DH5	2.968	time slot length *1600/6 /79 * 31.6	316.59	0.4	EDR

Remark: The EDR was tested on (π /4QPSK, 8DPSK) modes, only the worst data of (8DPSK) is attached in the following pages.

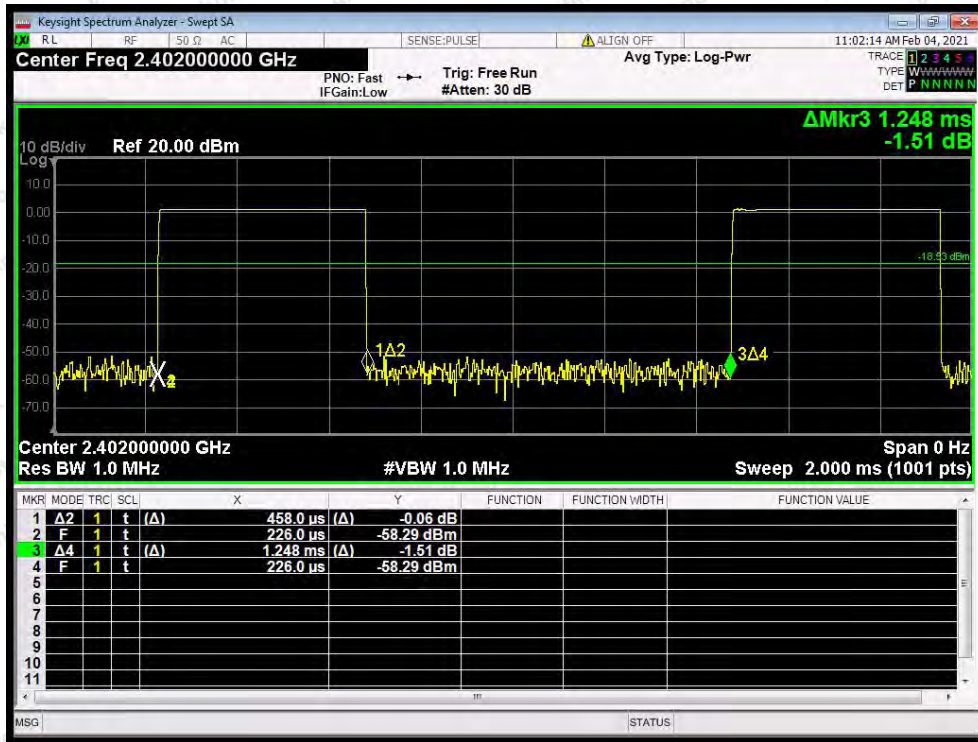

Test Mode: BDR---DH1

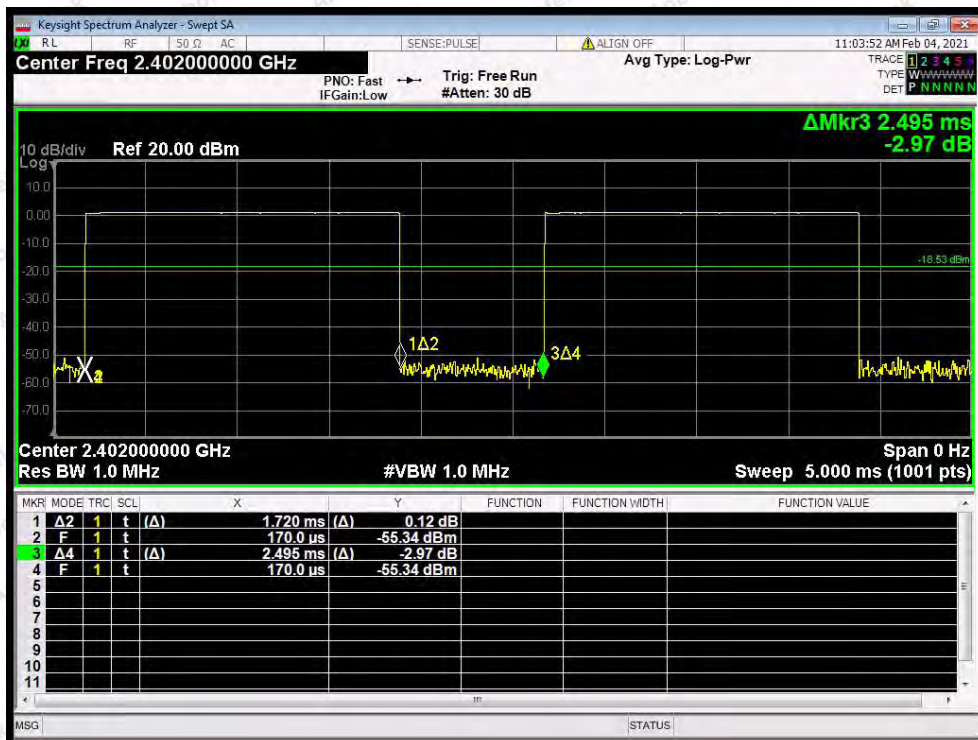

Test Mode: BDR---DH3

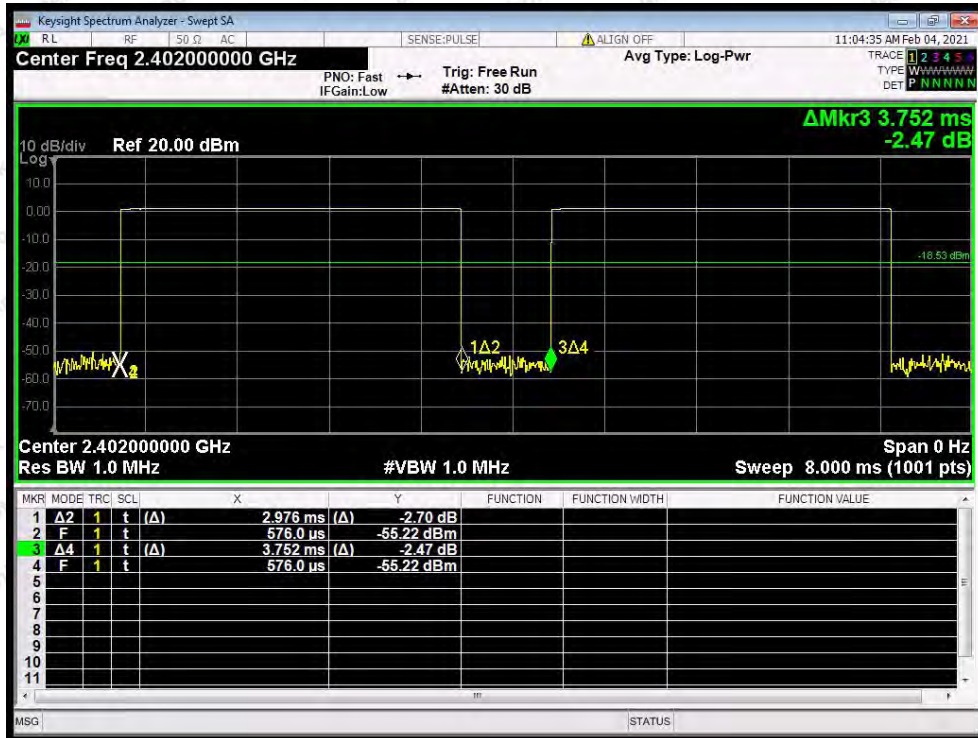

Test Mode: BDR---DH5

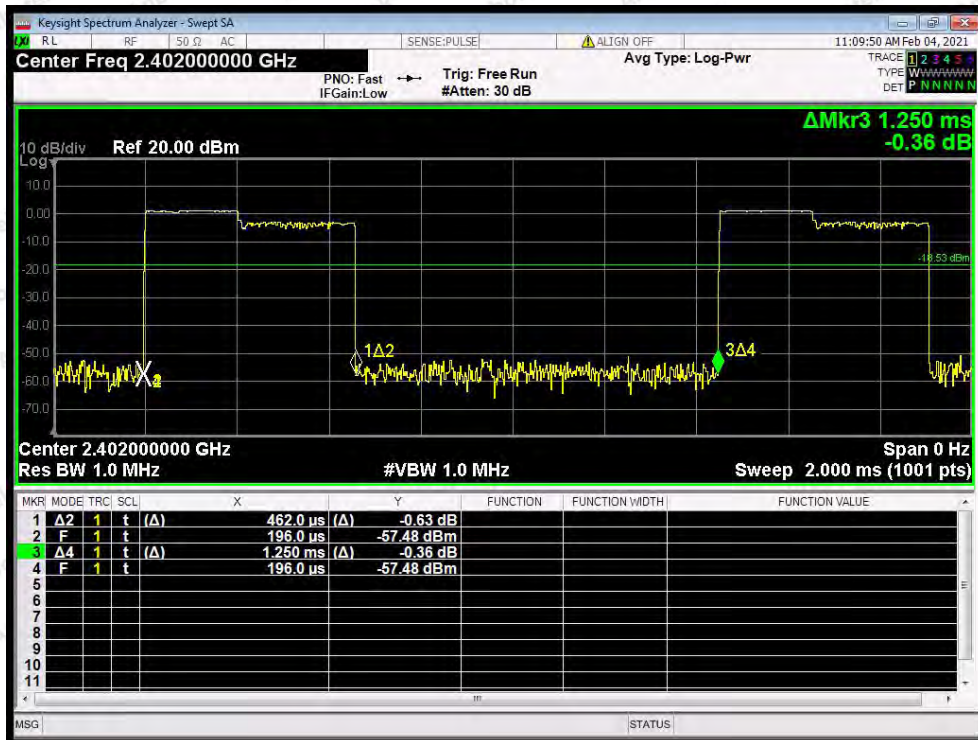

Test Mode: EDR---3DH1

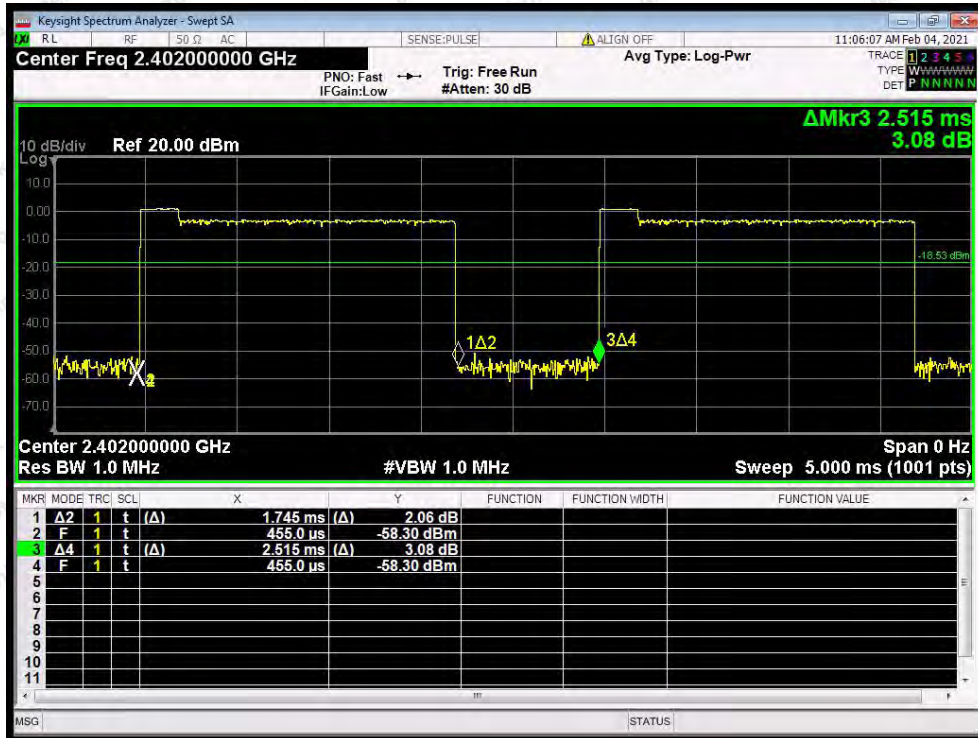

Test Mode: EDR---3DH3



Test Mode: EDR---3DH5

10. 100kHz Bandwidth of Frequency Band Edge Requirement

10.1. Test Standard and Limit

Test Standard	FCC Part15 C Section 15.247 (d)
Test Limit	in any 100 kHz bandwidth outside the frequency bands in which the spread spectrum intentional radiator in operating, the radio frequency power that is produced by the intentional radiator shall be at least 20dB below that in the 100kHz bandwidth within the band that contains the highest level of the desired power, In addition, radiated emissions which fall in the restricted bands, as defined in §15.205(a), must also comply with the radiated emission limits specified in 15.209(a).

10.2. Test Setup

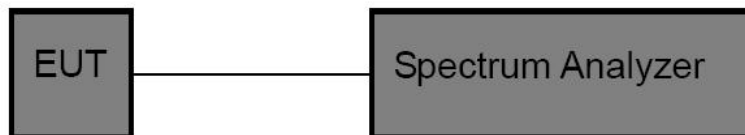

10.3. Test Procedure

The EUT must have its hopping/Non-hopping function enabled. Using the following spectrum analyzer setting:

1. Set the RBW = 100kHz.
2. Set the VBW = 300kHz.
3. Sweep time = auto couple.
4. Detector function = peak.
5. Trace mode = max hold.
6. Allow trace to fully stabilize.

10.4. Test Data

Test Item	: Band edge	Test Mode	: CH Low ~ CH High
Test Voltage	: AC 120V, 60Hz for adapter	Temperature	: 22.7℃
Test Result	: PASS	Humidity	: 52%RH

Remark: The EDR was tested on ($\pi/4$ QPSK, 8DPSK) modes.

For Hopping Mode

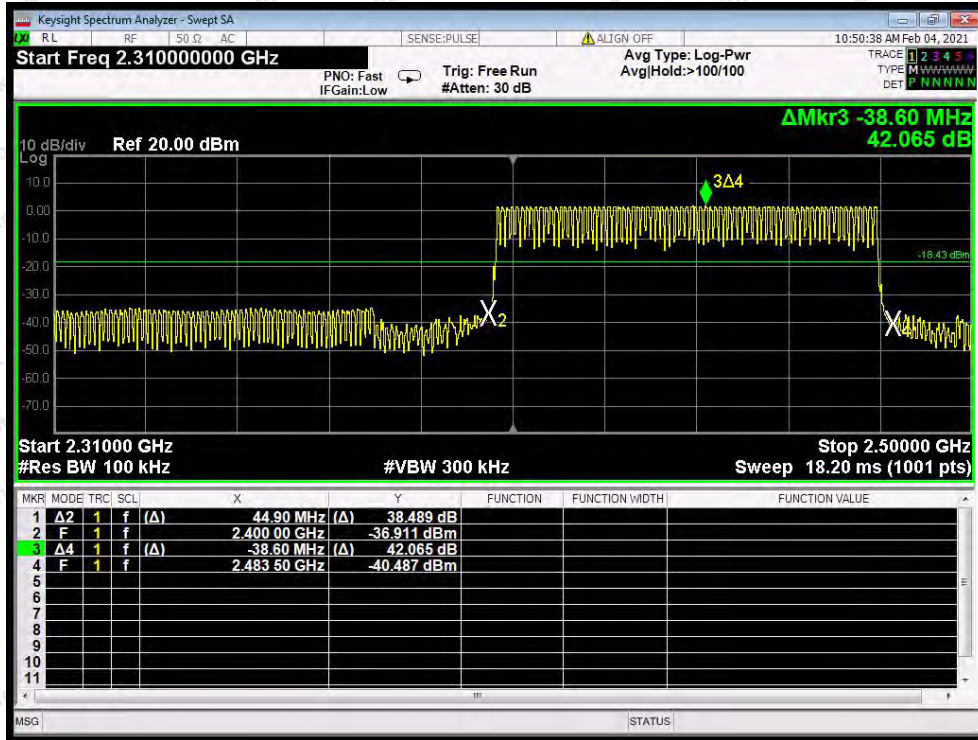

BDR mode

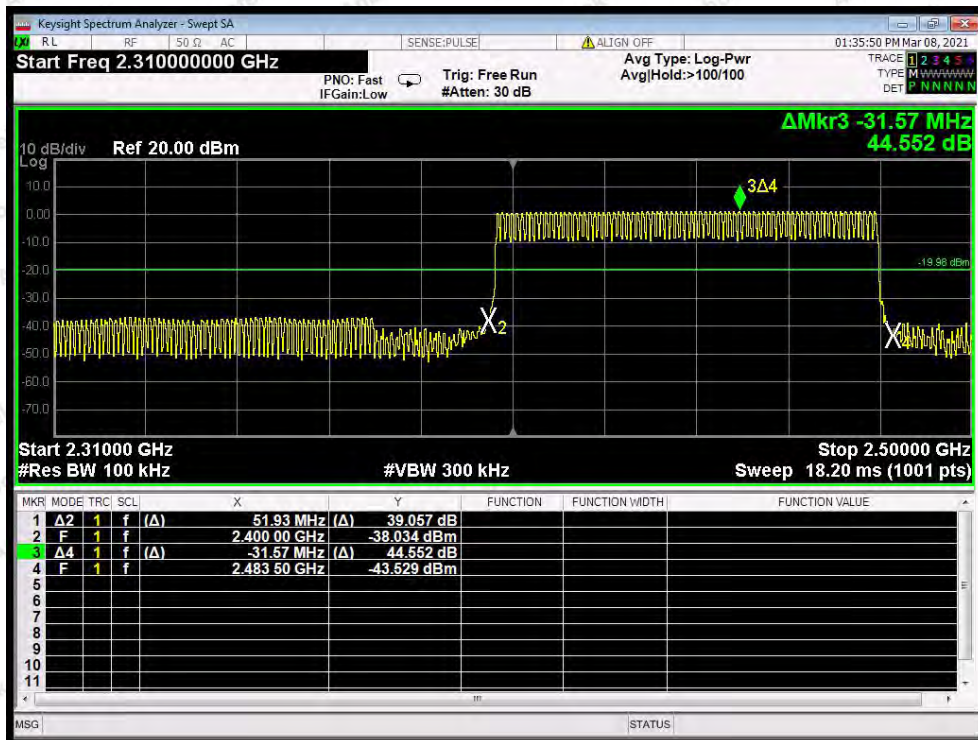

EDR mode- $\pi/4$ QPSK

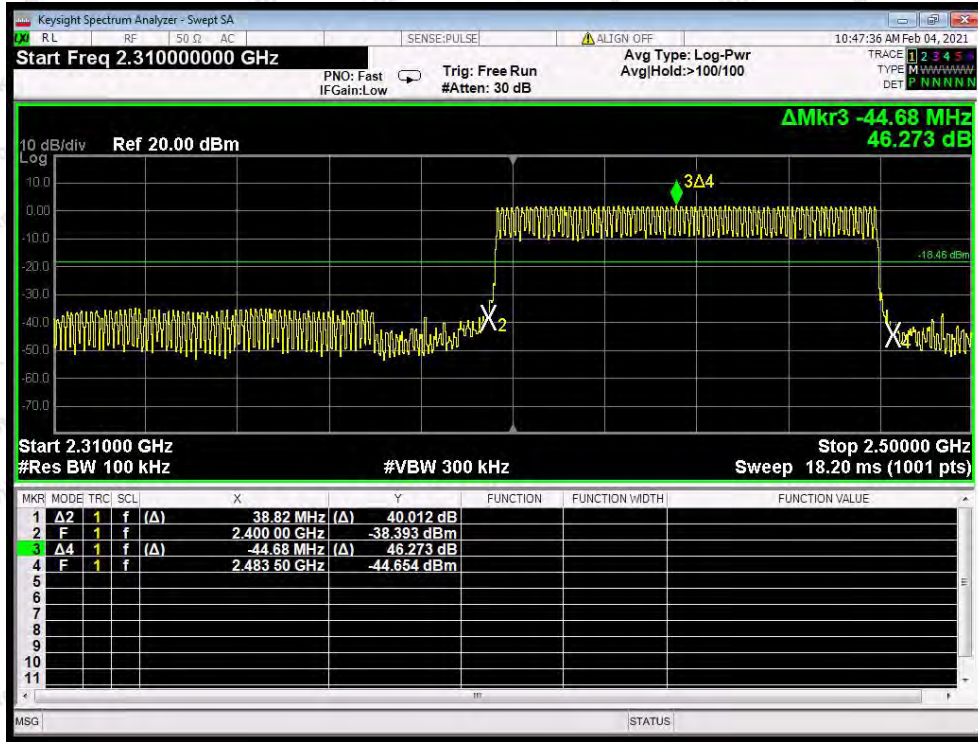

EDR mode-8DPSK



BDR mode -- Lowest

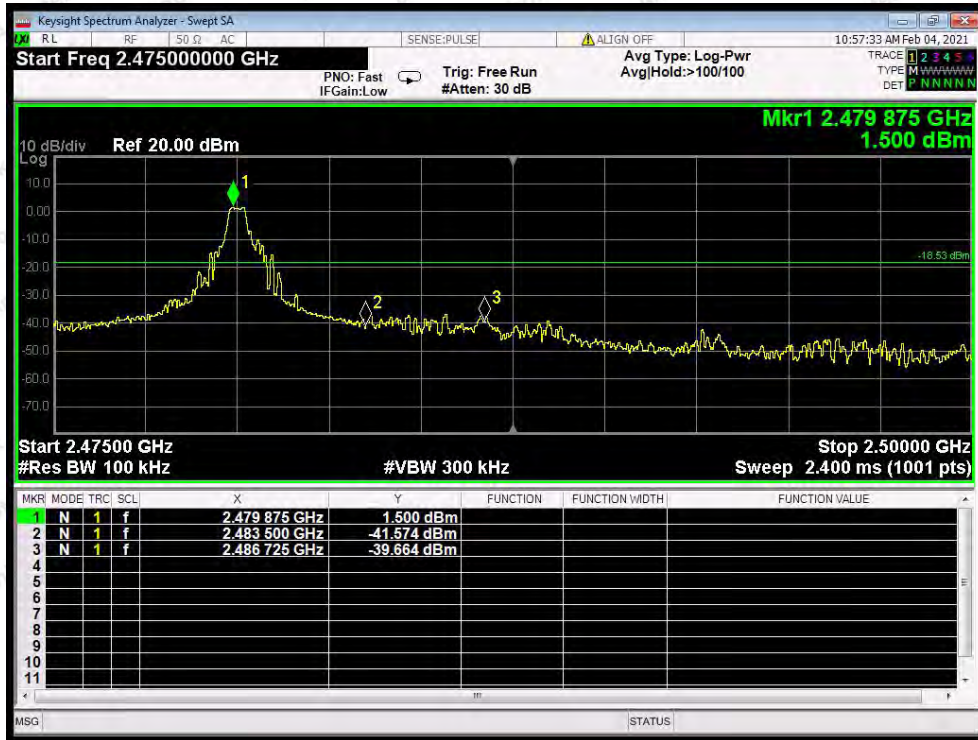

BDR mode -- Highest

For Non-Hopping Mode

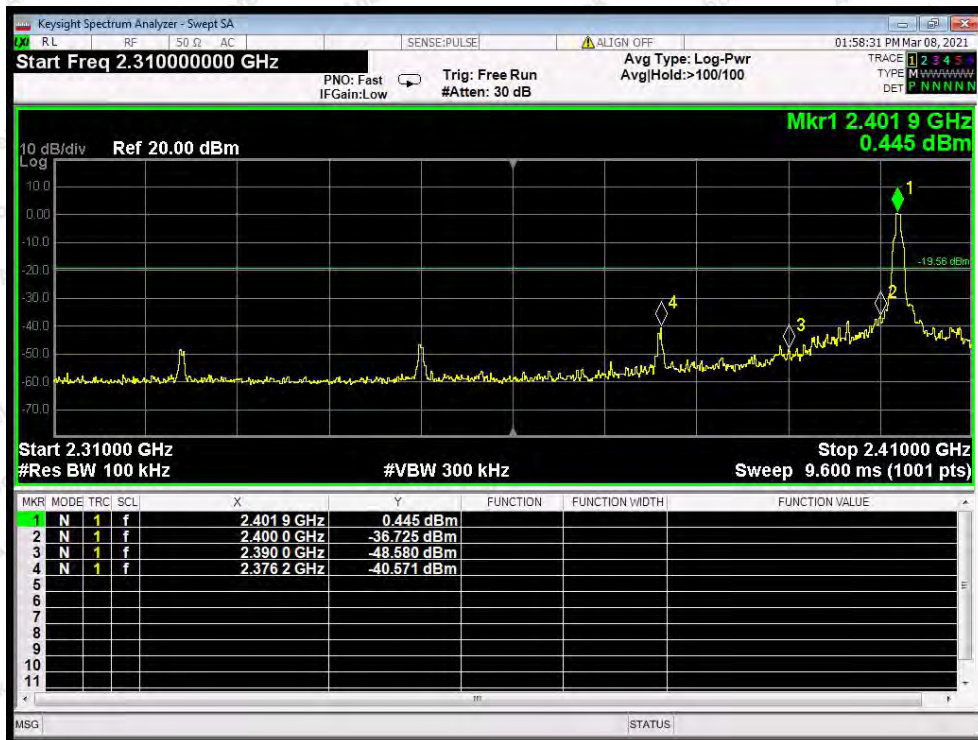

EDR mode -- Lowest- π /4QPSK

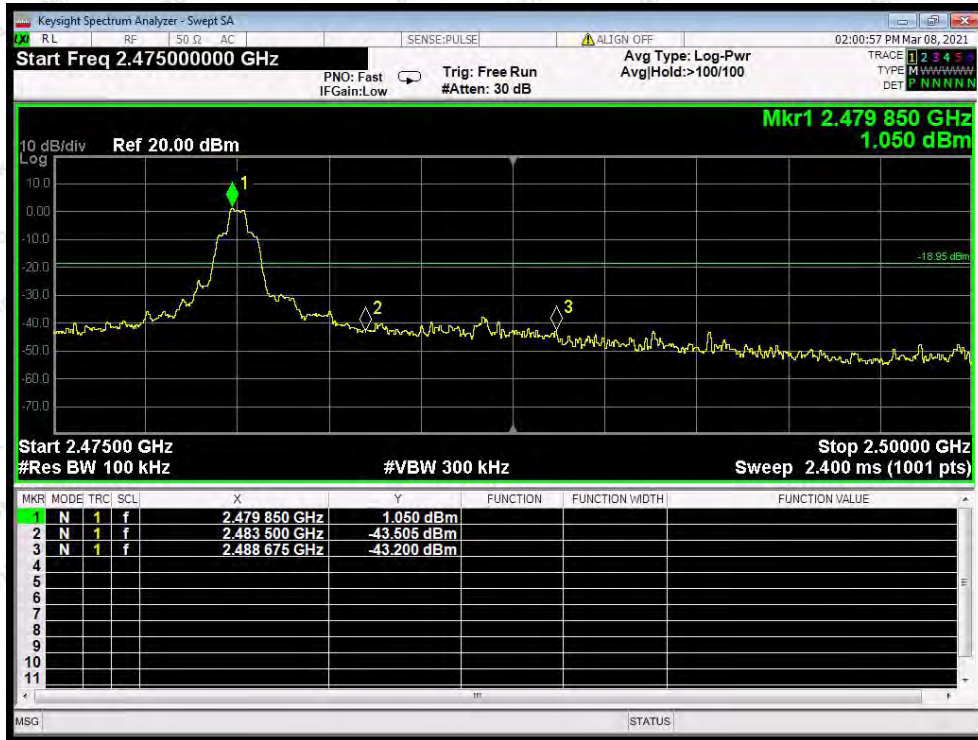

EDR mode -- Highest- $\pi/4$ QPSK

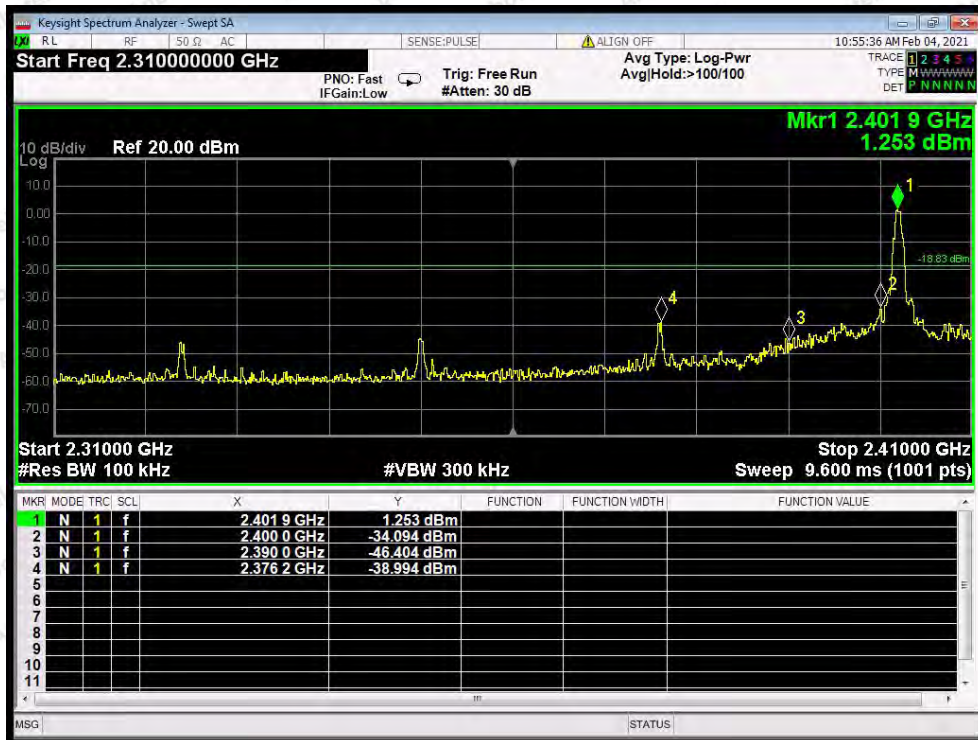

EDR mode -- Lowest-8DPSK



EDR mode -- Highest-8DPSK

Conducted Emission Method

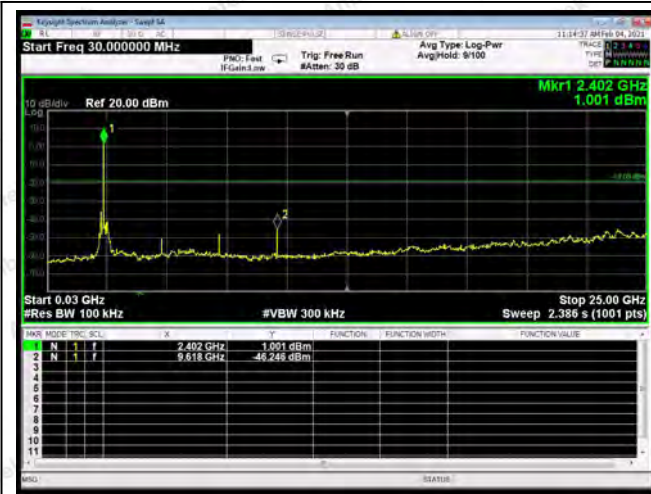

Test Mode: BDR---Low

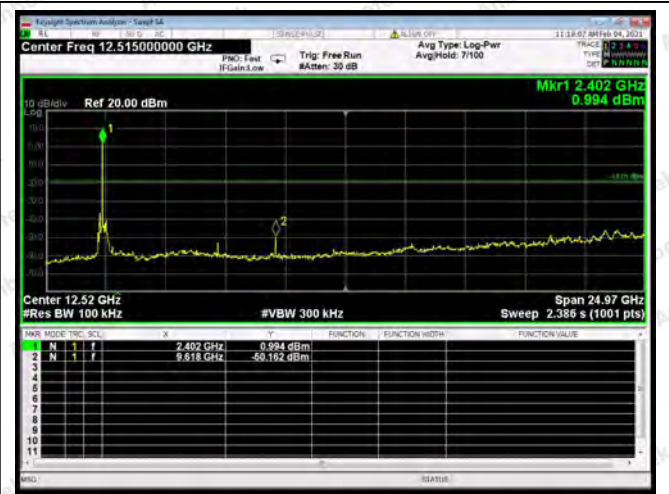

Test Mode: BDR---Mid

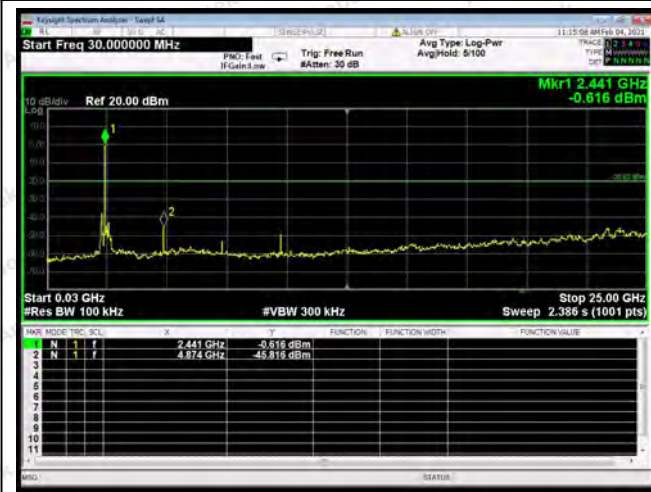

Test Mode: BDR---High

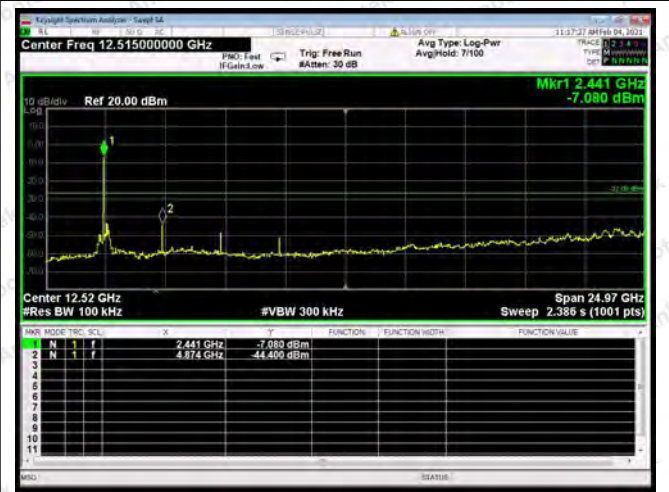

Test Mode: EDR---Low

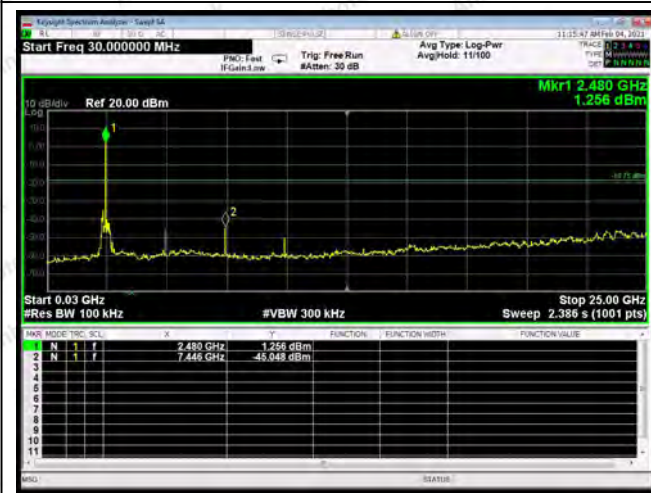

Test Mode: EDR---Mid

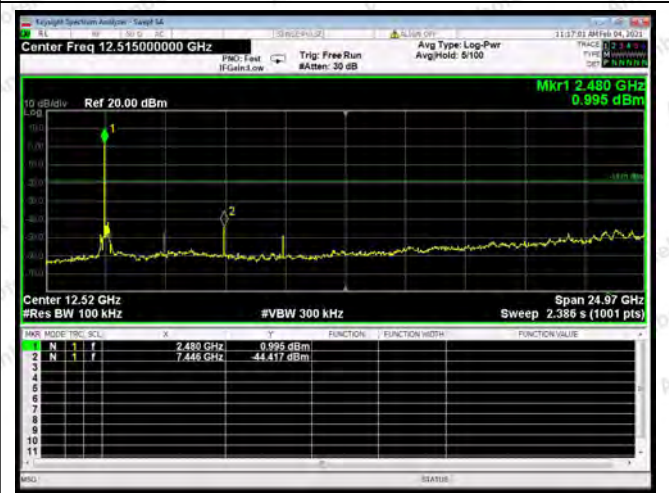

Test Mode: EDR---High

11. Antenna Requirement

11.1. Test Standard and Requirement

Test Standard	FCC Part15 Section 15.203 /247(c)
Requirement	<p>1) 15.203 requirement: An intentional radiator shall be designed to ensure that no antenna other than that furnished by the responsible party shall be used with the device. The use of a permanently attached antenna or of an antenna that uses a unique coupling to the intentional radiator, the manufacturer may design the unit so that a broken antenna can be replaced by the user, but the use of a standard antenna jack or electrical connector is prohibited.</p> <p>2) 15.247(c) (1)(i) requirement: Systems operating in the 2400-2483.5 MHz band that is used exclusively for fixed. Point-to-point operations may employ transmitting antennas with directional gain greater than 6dBi provided the maximum conducted output power of the intentional radiator is reduced by 1 dB for every 3 dB that the directional gain of the antenna</p>

11.2. Antenna Connected Construction

The antenna is PCB Antenna which permanently attached, and the best case gain of the antenna is 0 dBi. It complies with the standard requirement.

APPENDIX I -- TEST SETUP PHOTOGRAPH

Please refer to separated files for Test Setup Photos of the EUT.

APPENDIX II -- EXTERNAL PHOTOGRAPH

Please refer to separated files for External Photos of the EUT.

APPENDIX III -- INTERNAL PHOTOGRAPH

Please refer to separated files for Internal Photos of the EUT.

----- End of Report -----