



FCC PART 20.21

TEST REPORT

For

ShenZhen SolidRF Communications Co., Ltd

No. 8, Shop D, Block C, Shan Shui Ju, Long Wei Rd Shenzhen China

FCC ID: A7V-SR75702002

Report Type: Original Report	Product Type: Cell Phone Signal Booster
Report Number: <u>DG8210630-26329E-00A</u>	
Report Date: <u>2021-08-10</u>	
Reviewed By:	Gavin Xu RF Engineer 
Prepared By:	Bay Area Compliance Laboratories Corp. (Dongguan) No.12, Pulong East 1 st Road, Tangxia Town, Dongguan, Guangdong, China Tel: +86-769-86858888 Fax: +86-769-86858891 www.baclcorp.com.cn

TABLE OF CONTENTS

GENERAL INFORMATION	4
PRODUCT DESCRIPTION FOR EQUIPMENT UNDER TEST (EUT)	4
TECHNICAL SPECIFICATION	4
OBJECTIVE	4
RELATED SUBMITTAL(S)/GRANT(S)	4
TEST METHODOLOGY	5
MEASUREMENT UNCERTAINTY	5
TEST FACILITY	5
DECLARATIONS	5
SYSTEM TEST CONFIGURATION	6
DESCRIPTION OF TEST CONFIGURATION.....	6
EUT EXERCISE SOFTWARE	6
SPECIAL ACCESSORIES	6
EQUIPMENT MODIFICATIONS.....	6
SUPPORT EQUIPMENT LIST AND DETAILS.....	6
EXTERNAL I/O CABLE	6
BLOCK DIAGRAM OF TEST SETUP	6
TEST EQUIPMENT LIST	7
ENVIRONMENTAL CONDITIONS	7
SUMMARY OF TEST RESULTS	8
1 – AUTHORIZED FREQUENCY BAND VERIFICATION	9
APPLICABLE STANDARD.....	9
TEST PROCEDURE.....	9
TEST DATA.....	10
2 – MAXIMUM POWER MEASUREMENT	12
APPLICABLE STANDARD.....	12
TEST PROCEDURE.....	12
TEST DATA.....	13
3 – MAXIMUM BOOSTER GIAN COMPUTATION.....	15
APPLICABLE STANDARDS	15
TEST PROCEDURE.....	15
TEST DATA.....	15
4 - INTERMODULATION PRODUCT.....	17
APPLICABLE STANDARDS	17
TEST PROCEDURE.....	17
TEST DATA.....	18
5 - OUT OF BAND EMISSIONS.....	22
APPLICABLE STANDARDS	22
TEST PROCEDURE.....	22
TEST DATA.....	23
6 - SPURIOUS EMISSIONS AT ANTENNA TERMINALS.....	44
APPLICABLE STANDARDS	44
TEST PROCEDURE.....	44
TEST DATA.....	45
7 - NOISE LIMITS	52
APPLICABLE STANDARDS	52
TEST PROCEDURE.....	52
TEST DATA.....	54
8 - UPLINK INACTIVITY	58

APPLICABLE STANDARDS 58
TEST PROCEDURE..... 58
TEST DATA..... 58

9 - VARIABLE BOOSTER GAIN 60
APPLICABLE STANDARDS 60
TEST PROCEDURE..... 60
TEST DATA..... 61

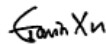
10 - OCCUPIED BANDWIDTH 64
APPLICABLE STANDARDS 64
TEST PROCEDURE..... 64
TEST DATA..... 65

11 - OSCILLATION DETECTION 76
APPLICABLE STANDARDS 76
TEST PROCEDURE..... 76
TEST DATA..... 78

12 - RADIATED SPURIOUS EMISSIONS..... 85
APPLICABLE STANDARDS 85
TEST PROCEDURE..... 85
TEST DATA..... 86

GENERAL INFORMATION

Product Description for Equipment under Test (EUT)

EUT Name:		Cell Phone Signal Booster
Test Model:		SR75702002D
Multiple Models:		SR75702002A, SR75702002B, SR75702002C, SR75702002E
Model Difference:		Refer to the DOS
Rated Input Voltage:		DC 12V
Adapter Information	Model:	ET24-121500-U
	Input:	100-240V 50/60Hz 1.6A
	Output:	12V 1.5A
Serial Number:		DG8210630-26329E-RF-S1
EUT Received Date:		2021.07.01
EUT Received Status:		Good

Technical Specification

Operation Frequency Range(MHz)	Uplink:	Lower 700: 698-716 Upper 700: 776-787 Cellular: 824-849 AWS: 1710-1755 PCS: 1850-1915
	Downlink:	Lower 700: 728-746 Upper 700: 746-757 Cellular: 869-894 AWS: 2110-2155 PCS: 1930-1995
Max. RF Output Power (EIRP) (dBm):	Uplink:	25.91
	Downlink:	9.85

Note: For the allowable antenna gains and cable loss, please refer to the Antenna Kitting Information in the User Manual which was provided from manufacturer.

Objective

This test report is prepared on behalf of *ShenZhen SolidRF Communications Co., Ltd* in accordance with Part 2, part 20.21, part 22, part 24 and Part 27 of the Federal Communication Commissions rules.

Related Submittal(s)/Grant(s)

No related Submittal(s)/Grant(s)

Test Methodology

All tests and measurements indicated in this document were performed in accordance with the Code of federal Regulations Title 47 Part 2, Sub-part J as well as the following individual parts:

Applicable Standards: ANSI C63.26-2015, KDB 935210 D03 Signal Booster Measurements v04r04.

All emissions measurement was performed at Bay Area Compliance Laboratories Corp. (Dongguan). The radiated testing was performed at an antenna-to-EUT distance of 3 meters.

Measurement Uncertainty

Item		Uncertainty
RF conducted test with spectrum		±0.9dB
Radiated emission	30MHz~1GHz	±5.91dB
	Above 1G	±4.92dB
Occupied Bandwidth		±0.5kHz
Temperature		±1.0°C
Humidity		±6%

Note: Otherwise required by the applicant or Product Regulations, Decision Rule in this report did not consider the uncertainty. The extended uncertainty given in this report is obtained by combining the standard uncertainty times the coverage factor K with the 95% confidence interval.

Test Facility

The Test site used by Bay Area Compliance Laboratories Corp. (Dongguan) to collect test data is located on the No.12, Pulong East 1st Road, Tangxia Town, Dongguan, Guangdong, China.

The lab has been recognized as the FCC accredited lab under the KDB 974614 D01 and is listed in the FCC Public Access Link (PAL) database, FCC Registration No. : 897218, the FCC Designation No. : CN1220.

The lab has been recognized by Innovation, Science and Economic Development Canada to test to Canadian radio equipment requirements, the CAB identifier : CN0022.

Declarations

BACL is not responsible for the authenticity of any test data provided by the applicant. Data included from the applicant that may affect test results are marked with a triangle symbol “▲”. Customer model name, addresses, names, trademarks etc. are not considered data.

Unless otherwise stated the results shown in this test report refer only to the sample(s) tested.

This report cannot be reproduced except in full, without prior written approval of the Company.

This report is valid only with a valid digital signature. The digital signature may be available only under the Adobe software above version 7.0.

This report must not be used by the customer to claim product certification, approval, or endorsement by A2LA, or any agency of the U.S. Government.

This report may contain data that are not covered by the accreditation scope and shall be marked with an asterisk “★”.

SYSTEM TEST CONFIGURATION

Description of Test Configuration

The system was configured for testing in a test mode which has been done in the factory.

Antenna kitting requirement: EUT has multiple sets antenna kitting for marketing, the antenna gain for varied band were listed in user manual, fulfill the requirement of FCC Part 20.21(e)(8)(i)(G), more detail information please refer to the user manuals.

EUT Exercise Software

No exercise software was used.

Special Accessories

No special accessory was used.

Equipment Modifications

No modification was made to the EUT tested.

Support Equipment List and Details

Manufacturer	Description	Model	Serial Number
Wenschel	Termination	1440	MD477
Agilent	MXG Vector Signal Generator	N5182B	MY51350142

External I/O Cable

Cable Description	Shielding Type	Ferrite Core	Length (m)	From Port	To
Coaxial Cable	Yes	No	2	MXG Vector Signal Generator	EUT
Coaxial Cable	Yes	No	0.4	EUT	Termination
Adapter Line	No	No	1	Adapter	EUT

Block Diagram of Test Setup

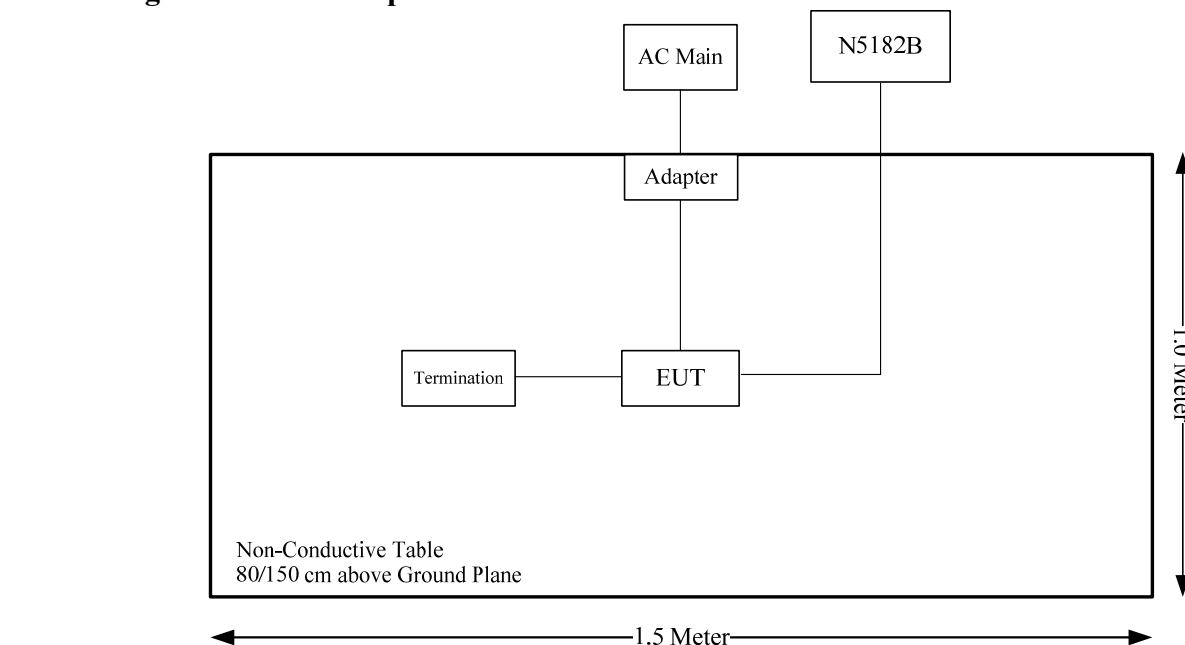

Test Equipment List

Manufacturer	Description	Model	Serial Number	Calibration Date	Calibration Due Date
Radiated Emission Below 1G					
Sunol Sciences	Antenna	JB3	A060611-2	2020-08-25	2023-08-25
R&S	EMI Test Receiver	ESCI	100224	2020-09-12	2021-09-12
Unknown	Coaxial Cable	C-NJNJ-50	C-1000-01	2020-09-05	2021-09-05
Unknown	Coaxial Cable	C-NJNJ-50	C-0400-02	2020-09-05	2021-09-05
Unknown	Coaxial Cable	C-NJNJ-50	C-0530-01	2020-09-24	2021-09-24
Sonoma	Amplifier	310N	185914	2020-10-13	2021-10-13
EMCO	Adjustable Dipole Antenna	3121C	9109-753	N/A	N/A
Unknown	Coaxial Cable	C-NJNJ-50	C-0200-02	2020-09-05	2021-09-05
Agilent	Signal Generator	E8247C	MY43321350	2021-04-25	2022-04-24
Radiated Emission Above 1G					
ETS-Lindgren	Horn Antenna	3115	000 527 35	2018-10-12	2021-10-12
Agilent	Spectrum Analyzer	E4440A	SG43360054	2021-07-07	2022-07-07
Unknown	Coaxial Cable	C-SJSJ-50	C-0800-01	2020-09-05	2021-09-05
Mini-Circuit	Amplifier	ZVA-213-S+	54201245	2020-09-05	2021-09-05
TDK RF	Horn Antenna	HRN-0118	130 084	2018-10-12	2021-10-12
Unknown	Coaxial Cable	C-NJNJ-50	C-0200-02	2020-09-05	2021-09-05
Agilent	Signal Generator	E8247C	MY43321350	2021-04-25	2022-04-24
Mini Circuits	High Pass Filter	VHF-6010+	31118	2021-06-16	2022-06-15
RF Conducted					
R&S	EMI Test Receiver	ESR3	102453	2020-09-12	2021-09-12
R&S	Spectrum Analyzer	FSV40	101591	2020-06-29	2021-09-28
yzjingcheng	Coaxial Cable	KTRFBU-141-50	41010013	2020-09-05	2021-09-05
yzjingcheng	Coaxial Cable	KTRFBU-141-50	41005011	2020-09-05	2021-09-05
yzjingcheng	Coaxial Cable	KTRFBU-141-50	41005012	2020-09-05	2021-09-05
E-Microwave	Blocking Control	EMDCB-00036	0E01201047	2021-05-06	2022-05-05
E-Microwave	Coaxial Attenuators	EMCA10-5RN-6	OE01203239	2020-09-06	2021-09-06
HP	Step Attenuator	8494B	1510A05007	2020-09-06	2021-09-06
Agilent	Step Attenuator	8496B	2815A10904	2020-09-06	2021-09-06
R&S	Wideband Radio Communication Tester	CMW500	147473	2020-09-23	2021-09-22
Agilent	MXG Vector Signal Generator	N5182B	MY51350142	2021-04-25	2022-04-24

* **Statement of Traceability:** Bay Area Compliance Laboratories Corp. (Dongguan) attests that all calibrations have been performed, traceable to National Primary Standards and International System of Units (SI).

Environmental Conditions

Test Item:	Radiated Emission Below 1G	Radiated Emission Above 1G	RF Conducted
Temperature:	25.6 °C	30 °C	25.4~29.6 °C
Relative Humidity:	55 %	34 %	43~56 %
ATM Pressure:	100.5 kPa	100.5 kPa	99.7~101.1 kPa
Tester:	Walker Yuan	Lee Li	Jake Zhou
Test Date:	2021.07.12	2021.07.12	2021.07.05~2021.08.03

SUMMARY OF TEST RESULTS

S/N	FCC Rules	Description of Test	Results
1	§20.21(e)(3)	7.1 Authorized Frequency Band Verification	Compliance
2	§ 20.21(e)(8)(i)(D) § 20.21(e)(8)(i)(B) §20.21(e)(4)	7.2 Maximum Power Measurement	Compliance
3	§ 20.21(e)(8)(i)(C)(2) § 20.21(e)(8)(i)(B) §20.21(e)(4)	7.3 Maximum Booster Gain Computation	Compliance
4	§ 20.21(e)(8)(i)(F)	7.4 Intermodulation Product	Compliance
5	§ 20.21(e)(8)(i)(E)	7.5 Out Of Band Emissions	Compliance
6	§2.1051	7.6 Spurious Emissions At Antenna Terminals	Compliance
7	§ 20.21(e)(8)(i)(A) § 20.21(e)(8)(i)(H) §20.21(e)(4)	7.7 Noise Limits	Compliance
8	§ 20.21(e)(8)(i)(I) §20.21(e)(4)	7.8 Uplink Inactivity	Compliance
9	§ 20.21(e)(8)(i)(C)(1) § 20.21(e)(8)(i)(H)	7.9 Variable Booster Gain	Compliance
10	§ 2.1049	7.10 Occupied Bandwidth	Compliance
11	§ 20.21(e)(8)(ii)(A) §20.21(e)(5)	7.11 Oscillation Detection	Compliance
12	§2.1053	7.12 Radiated Spurious Emissions	Compliance
13	§ 20.21(e)(8)(i)(B) § 20.21(e)(3)	7.13 Spectrum block filtering test procedure	Not applicable

Note:

Not applicable: This item only for wideband consumer boosters using spectrum block filtering.

1 – AUTHORIZED FREQUENCY BAND VERIFICATION

Applicable Standard

According to § 20.21(e)(3) *Frequency Bands*.

This test is intended to confirm that the signal booster only operates on the CMRS frequency bands authorized for use by the NPS. In other words, the signal booster shall reject amplification of other signals outside of its passband. In addition, this test will identify the frequency at which the maximum gain is realized within each CMRS operational band, which then serves as a basis for subsequent tests.

Test Procedure

- a) Connect the EUT to the test equipment as shown in **Figure 1**. Begin with the uplink output (donor) port connected to the spectrum analyzer.
- b) Set the spectrum analyzer resolution bandwidth (RBW) for 100 kHz with the video bandwidth (VBW) ≥ 3 the RBW, using a PEAK detector with the MAX HOLD function.
- c) Set the center frequency of the spectrum analyzer to the center of the operational band under test with a span of 1 MHz.
- d) Set the signal generator for CW mode and tune to the center frequency of the operational band under test.
- e) Set the initial signal generator power to a level that is at least 6 dB below the AGC level specified by the manufacturer.
- f) Slowly increase the signal generator power level until the output signal reaches the AGC operational level.
- g) Reduce the signal generator power to a level that is 3 dB below the level noted above, then manually reset the EUT (e.g., cycle ac/dc power).
- h) Reset the spectrum analyzer span to 2 the width of the CMRS band under test. Adjust the tuned frequency of the signal generator to sweep 2 the width of the CMRS band using the sweep function. The AGC must be deactivated throughout the entire sweep.
- i) Using three markers, identify the CMRS band edges and the frequency with the highest power. Affirm that the values of all markers are visible on the display of the spectrum analyzer (e.g., marker table set to on).
- j) Capture the spectrum analyzer trace for inclusion in the test report.
- k) Repeat 7.1c) to 7.1j) for all operational uplink and downlink bands.

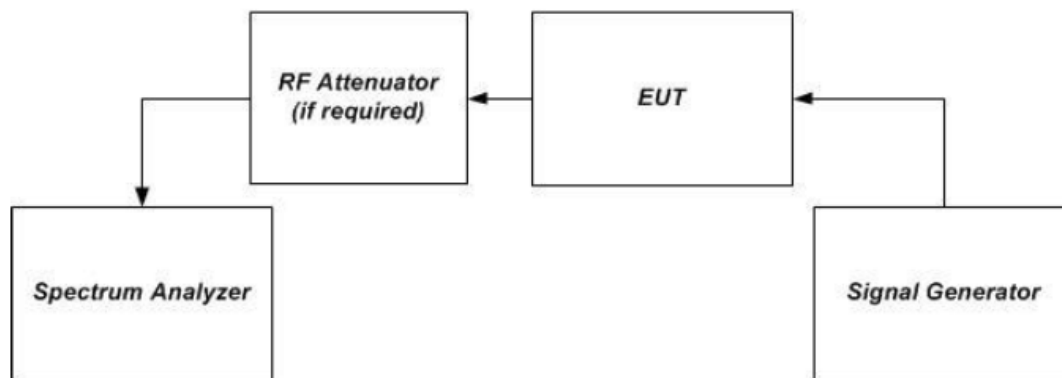
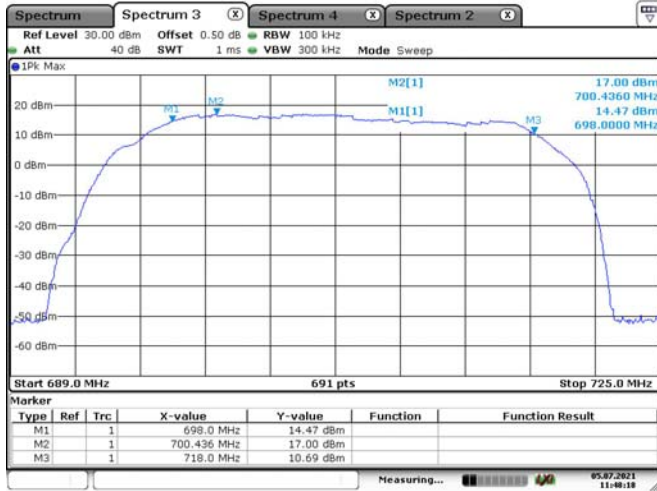

Figure 1 – Band verification test instrumentation setup

Test Data

Test Result: Compliance. Please refer to following plots.

Lower 700MHz Band Uplink



Date: 5.JUL.2021 11:48:18

Lower 700MHz Band Downlink

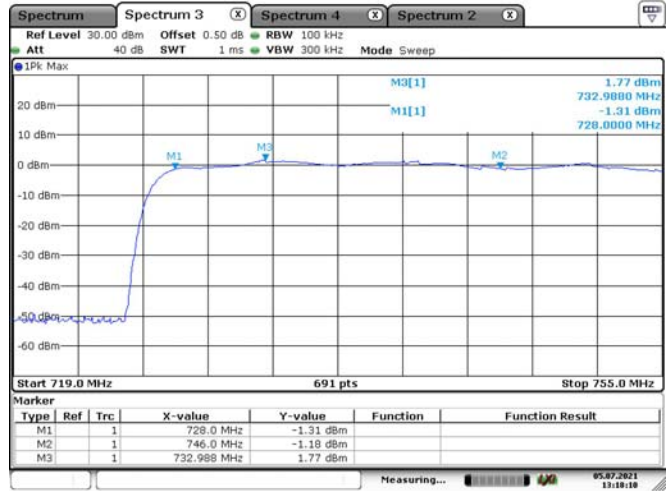

Date: 5.JUL.2021 13:18:11

Upper 700MHz Band Uplink

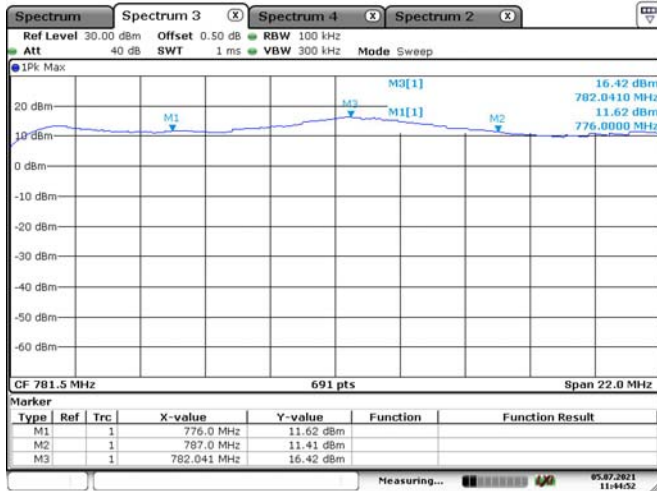

Date: 5.JUL.2021 11:44:52

Upper 700MHz Band Downlink

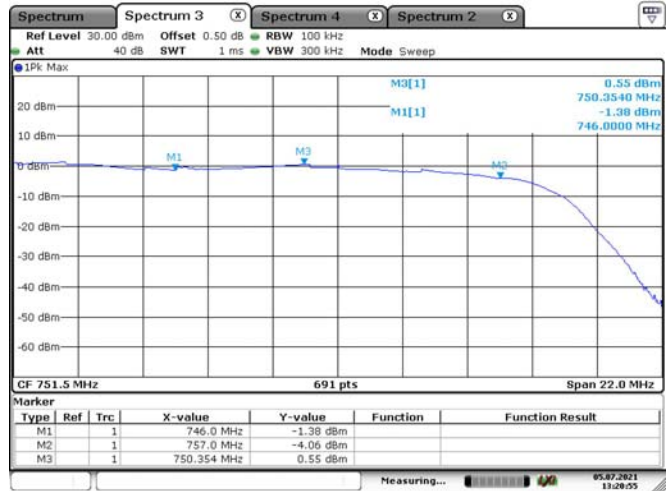

Date: 5.JUL.2021 13:20:56

Cellular Band Uplink

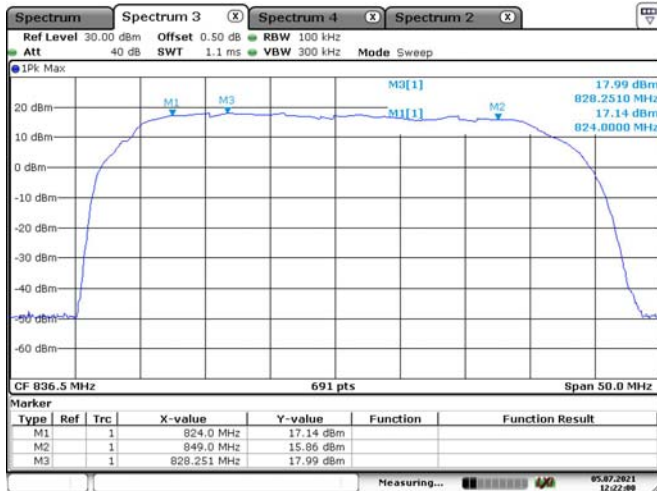

Date: 5.JUL.2021 12:22:00

Cellular Band Downlink

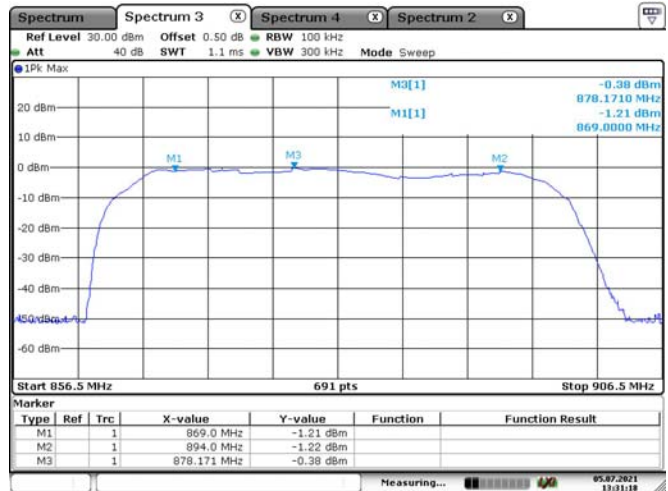

Date: 5.JUL.2021 13:31:18

AWS Band Uplink

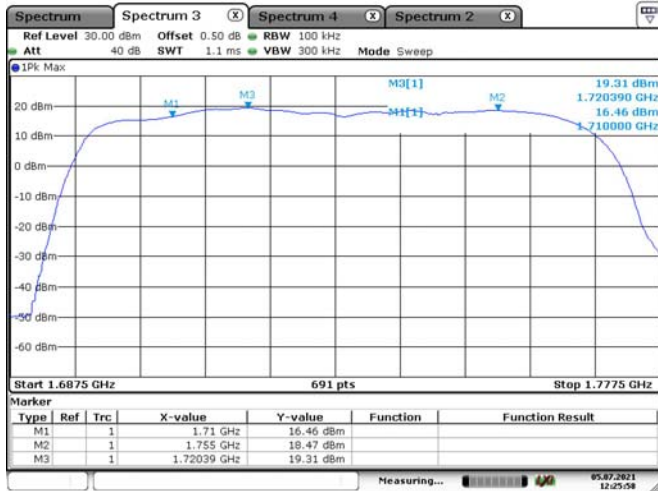

Date: 5.JUL.2021 12:25:58

AWS Band Downlink

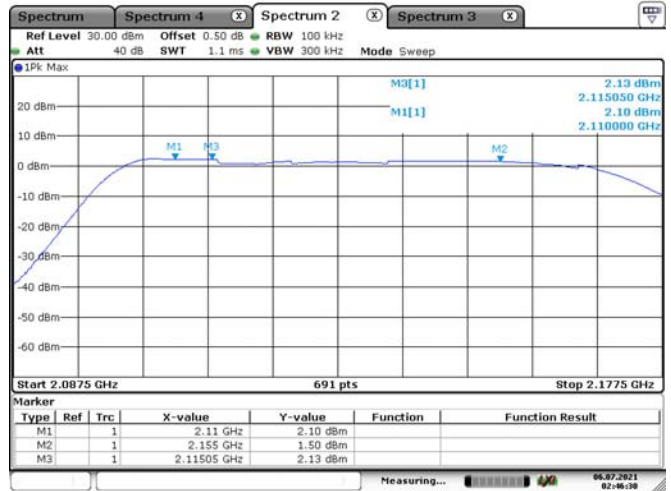

Date: 6.JUL.2021 02:46:30

PCS Band Uplink

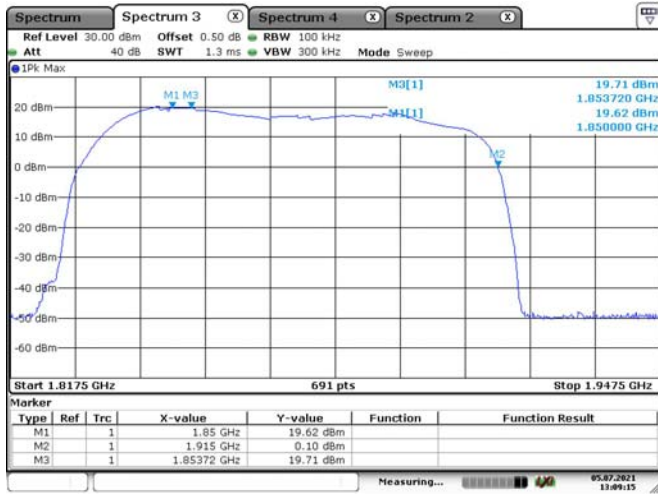

Date: 5.JUL.2021 13:09:15

PCS Band Downlink

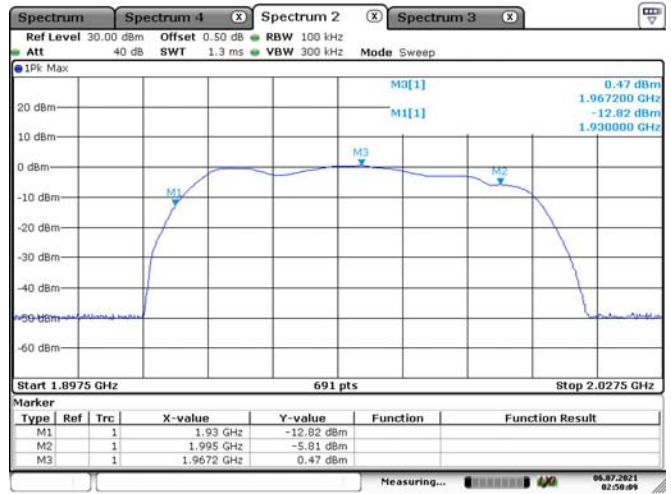

Date: 6.JUL.2021 02:50:09

2 – MAXIMUM POWER MEASUREMENT

Applicable Standard

According to § 20.21(e)(8)(i)(D) *Power Limits*; § 20.21(e)(8)(i)(B) *Bidirectional Capability* (uplink minimum conducted power output); §20.21(e)(4) *Self-monitoring*.

This procedure shall be used to demonstrate compliance to the signal booster power limits and requirements as specified in Sections 20.21(e)(8)(i)(D) and 20.21(e)(8)(i)(B) for wideband consumer signal boosters.

- a) Compliance to applicable EIRP limits must be shown using the highest gains from the list of antennas, cabling, and coupling devices declared by the manufacturer for use with the consumer booster.
- b) In addition, the maximum power levels measured in this procedure will be used in calculating the maximum gain as described in the next subclause.
- c) The frequency with the highest power level in each operational band as determined in 7.1 is to be measured discretely by applying the following procedure using the stated emission and power detector types independently.
- d) Use a signal generator to create a pulsed CW or GSM signal with a pulse width of 570 μ s and a duty cycle of 12.5% (i.e., one GSM timeslot), then measure using the burst power function of the measuring instrument.
- e) Use a signal generator to create an AWGN signal with a 99% occupied bandwidth (OBW) of 4.1 MHz, then measure using the channel power or band power function of the measuring instrumentation.
- f) All modes of operation must be verified to maintain operation within applicable limits at the maximum uplink and downlink test levels per device type as defined in 5.5, by increasing the power level in 2 dB steps from the AGC level to the maximum input level specified in 5.5.

Test Procedure

- a) Connect the EUT to the test equipment as shown in **Figure 1**. Begin with the uplink output (donor) port connected to the spectrum analyzer.
- b) Configure the signal generator and spectrum analyzer for operation on the frequency determined in 7.1 with the highest power level, but with the center frequency of the signal no closer than 2.5 MHz from the band edge. The spectrum analyzer span shall be set to at least 10 MHz.
- c) Set the initial signal generator power to a level well below that which causes AGC activation.
- d) Slowly increase the signal generator power level until the output signal reaches the AGC operational limit (from observation of signal behavior on the spectrum analyzer; i.e., no further increase in output power as input power is increased).
- e) Reduce power sufficiently on the signal generator to ensure that the AGC is not controlling the power output.
- f) Slowly increase the signal generator power to a level just below (and within 0.5 dB of) the AGC limit without triggering the AGC. Note the signal generator power level as P_{in} .
- g) Measure the output power, P_{out} , with the spectrum analyzer as follows.
 - 1) Set RBW = 100 kHz for AWGN signal type, or 300 kHz for CW or GSM signal type.
 - 2) Set VBW $\geq 3 \cdot$ RBW.
 - 3) Select either the BURST POWER or CHANNEL POWER measurement mode, as required for each signal type. For AWGN, the channel power integration bandwidth shall be the 99% OBW of the 4.1 MHz signal.
 - 4) Select the power averaging (rms) detector.
 - 5) Affirm that the number of measurement points per sweep $\geq (2 \cdot \text{span}) / \text{RBW}$.
NOTE—This requirement does not apply for BURST power measurement mode.
 - 6) Set sweep time = auto couple, or as necessary (but no less than auto couple value).
 - 7) Trace average at least 100 traces in power averaging (i.e., rms) mode.
 - 8) Record the measured power level P_{out} , with one set of results for the GSM or CW input stimulus, and another set of results for the AWGN input stimulus.
- h) Repeat step g) while increasing the signal generator amplitude in 2 dB steps until the maximum input level indicated in 5.5 is reached. If the booster has shut down at any point during the input power steps, it should be noted and step g) shall be repeated at an input level 1 dB less than that found to cause the shutdown. The test report shall include either a statement describing that the device complies at 10 dB above AGC or at the 5.5 power levels, or a table showing compliance at the additional input power(s) required.
- i) Repeat the entire procedure for each operational uplink and downlink frequency band supported by the booster.
- j) Provide tabulated results in the test report.

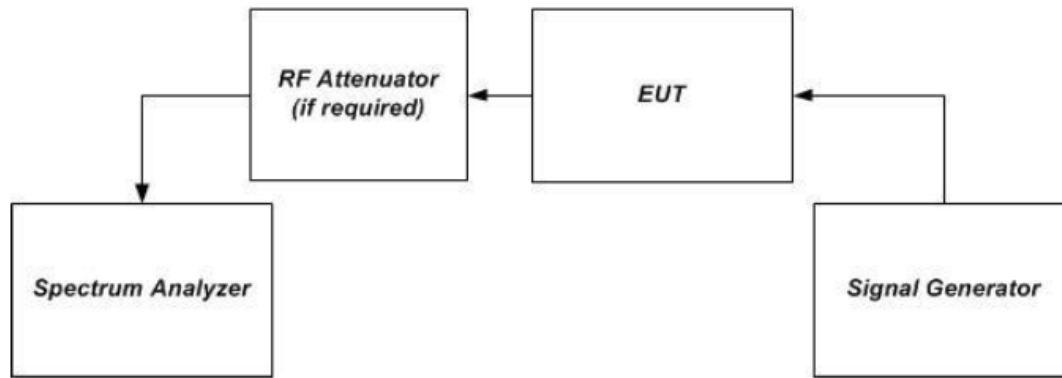

Figure 1 – Band verification test instrumentation setup

Test Data

Test Result: Compliance. Please refer to following tables.

AGC Input Level:

Mode	Operation Band	Signal Type	Pre AGC Input Level
			dBm
Uplink	Lower 700MHz	AWGN	-39
		GSM	-41
	Upper 700MHz	AWGN	-35
		GSM	-36
	Cellular	AWGN	-37
		GSM	-39
	AWS	AWGN	-36
		GSM	-39
	PCS	AWGN	-36
		GSM	-38
Downlink	Lower 700MHz	AWGN	-54
		GSM	-56
	Upper 700MHz	AWGN	-55
		GSM	-57
	Cellular	AWGN	-56
		GSM	-58
	AWS	AWGN	-57
		GSM	-59
	PCS	AWGN	-58
		GSM	-60

Maximum Output Power:

Mode	Operation Band	Signal Type	Pre AGC Input Level	Conducted Output Level	Antenna Gain	Cable Loss	EIRP	Limit
			dBm	dBm	dBi	dB	dBm	dBm
Uplink	Lower 700MHz	AWGN	-39	16.48	9	1.90	23.58	17-30
		GSM	-41	16.25	9	1.90	23.35	
	Upper 700MHz	AWGN	-35	15.09	9	1.90	22.19	
		GSM	-36	15.61	9	1.90	22.71	
	Cellular	AWGN	-37	16.97	9	1.95	24.02	
		GSM	-39	16.82	9	1.95	23.87	
	AWS	AWGN	-36	17.53	10	2.55	24.98	
		GSM	-39	18.27	10	2.55	25.72	
	PCS	AWGN	-36	17.79	10	2.90	24.89	
		GSM	-38	18.81	10	2.90	25.91	
Downlink	Lower 700MHz	AWGN	-54	0.65	9	1.30	8.35	≤17
		GSM	-56	0.78	9	1.30	8.48	
	Upper 700MHz	AWGN	-55	-0.29	9	1.30	7.41	
		GSM	-57	-0.29	9	1.30	7.41	
	Cellular	AWGN	-56	-0.34	9	1.35	7.31	
		GSM	-58	-0.45	9	1.35	7.20	
	AWS	AWGN	-57	1.65	10	1.80	9.85	
		GSM	-59	1.55	10	1.80	9.75	
	PCS	AWGN	-58	1.10	10	1.80	9.30	
		GSM	-60	0.88	10	1.80	9.08	

Note:

Compliance to applicable EIRP limits used highest gains from the list of antennas, cabling, and coupling devices declared by the manufacturer for use with the consumer booster.

Maximum Input Level:

Mode	Operation Band	Signal Type	Maximum Input Level	Maximum Input Level Limits	Conducted Output Level
			dBm	dBm	dBm
Uplink	Lower 700MHz	AWGN	-22	27	16.37
		GSM	-25		16.58
	Upper 700MHz	AWGN	-20		14.98
		GSM	-20		15.43
	Cellular	AWGN	-21		17.09
		GSM	-23		17.08
	AWS	AWGN	-21		18.23
		GSM	-23		18.43
	PCS	AWGN	-20		19.12
		GSM	-23		18.07
Downlink	Lower 700MHz	AWGN	-38	-20	0.78
		GSM	-38		1.56
	Upper 700MHz	AWGN	-39		-0.43
		GSM	-40		0.44
	Cellular	AWGN	-40		-0.31
		GSM	-41		0.21
	AWS	AWGN	-42		1.38
		GSM	-43		0.32
	PCS	AWGN	-42		0.92
		GSM	-43		0.12

3 – MAXIMUM BOOSTER GAIN COMPUTATION

Applicable Standards

According to § 20.21(e)(8)(i)(C)(2) *Booster Gain Limits* (maximum gain); § 20.21(e)(8)(i)(B) *Bidirectional Capability* (equivalent uplink and downlink gain); §20.21(e)(4) *Self-monitoring*.

This subclause provides guidance for the calculation of the maximum gain, based on the results obtained from the 7.1 and 7.2 measurements. The NPS limits on maximum gain for fixed and mobile wideband consumer signal boosters are provided in Section 20.21(e)(8)(i)(C)(2). Additionally, Section 20.21(e)(8)(i)(B) requires that wideband consumer signal boosters be able to provide equivalent uplink and downlink gain, i.e., within 9 dB.

Test Procedure

- a) Calculate the maximum gain of the booster as follows to demonstrate compliance to the applicable gain limits as specified.
- b) For both the uplink and downlink in each supported frequency band, use each of the P_{OUT} and P_{IN} result pairs for all signal types used in 7.2 in the following equation to obtain the maximum gain, G:

$$G \text{ (dB)} = P_{\text{OUT}}(\text{dBm}) - P_{\text{IN}}(\text{dBm}).$$
- c) Record the maximum gain of the uplink and downlink paths for each supported frequency band, and verify that the each gain value complies with the applicable limit.
- d) Provide tabulated results in the test report.

Test Data

Test Result: Compliance. Please refer to the following tables.

Maximum Gain:

Mode	Operation Band	Signal Type	Pre AGC Input level	Conducted Output level	Gain	Limit
			dBm	dBm	dB	dB
Uplink	Lower 700MHz	AWGN	-39	16.48	55.48	63.49
		GSM	-41	16.25	57.25	
	Upper 700MHz	AWGN	-35	15.09	50.09	64.36
		GSM	-36	15.61	51.61	
	Cellular	AWGN	-37	16.97	53.97	64.95
		GSM	-39	16.82	55.82	
	AWS	AWGN	-36	17.53	53.53	71.27
		GSM	-39	18.27	57.27	
	PCS	AWGN	-36	17.79	53.79	71.99
		GSM	-38	18.81	56.81	
Downlink	Lower 700MHz	AWGN	-54	0.65	54.65	63.49
		GSM	-56	0.78	56.78	
	Upper 700MHz	AWGN	-55	-0.29	54.71	64.36
		GSM	-57	-0.29	56.71	
	Cellular	AWGN	-56	-0.34	55.66	64.95
		GSM	-58	-0.45	57.55	
	AWS	AWGN	-57	1.65	58.65	71.27
		GSM	-59	1.55	60.55	
	PCS	AWGN	-58	1.10	59.10	71.99
		GSM	-60	0.88	60.88	

Note:

- 1. Mobile Booster maximum gain shall not exceed 50 dB when using an inside antenna.
- 2. Fixed Booster maximum gain shall not exceed 6.5 dB + 20* Log₁₀ (Frequency), where, Frequency is the uplink mid-band frequency of the supported spectrum bands in MHz.

Equivalent Uplink and Downlink Gain:

Operating Band	Signal type	Uplink Gain	Downlink Gain	Calculated Value	Limit
MHz		dB	dB	dB	dB
Lower 700MHz	AWGN	55.48	54.65	0.83	±9
	GSM	57.25	56.78	0.47	
Upper 700MHz	AWGN	50.09	54.71	-4.62	
	GSM	51.61	56.81	-5.20	
Cellular	AWGN	53.97	55.66	-1.69	
	GSM	55.82	57.55	-1.73	
AWS	AWGN	53.53	58.65	-5.12	
	GSM	57.27	60.55	-3.28	
PCS	AWGN	53.79	59.1	-5.31	
	GSM	56.81	60.88	-4.07	

4 - INTERMODULATION PRODUCT

Applicable Standards

According to § 20.21(e)(8)(i)(F) *Intermodulation Limits*.

Test Procedure

The following procedures shall be used to demonstrate compliance to the intermodulation limit specified in Section 20.21(e)(8)(i)(F) for wideband consumer signal boosters.

- a) Connect the signal booster to the test equipment as shown in **Figure 2**. Begin with the uplink output (donor) port connected to the spectrum analyzer.
 - b) Set the spectrum analyzer RBW = 3 kHz.
 - c) Set the VBW $\geq 3 \times$ RBW.
 - d) Select the rms detector.
 - e) Set the spectrum analyzer center frequency to the center of the supported operational band under test.
 - f) Set the span to 5 MHz. Affirm that the number of measurement points per sweep $\geq (2 \times \text{span})/\text{RBW}$.
 - g) Configure the two signal generators for CW operation with generator #1 tuned 300 kHz below the operational band center frequency and generator #2 tuned 300 kHz above the operational band center frequency. If the maximum output power is not at the operational-band (booster pass band) center frequency, configure the test signal pair around the frequency with maximum output power as determined per 7.2.
 - h) Set the signal generator amplitudes so that the power from each into the EUT is equivalent, then turn on the RF output.
 - i) Simultaneously increase each signal generators' amplitude equally until just before the EUT begins AGC, then affirm that all intermodulation-product emissions (if any occur) are below the specified limit of -19 dBm.
 - j) Use the trace averaging function of the spectrum analyzer, and wait for the trace to stabilize. Place a marker at the highest amplitude intermodulation-product emission.
 - k) Record the maximum intermodulation product amplitude level that is observed.
 - l) Capture the spectrum analyzer trace for inclusion in the test report.
 - m) Repeat 7.4e) to 7.4l) for all uplink and downlink operational bands.
- NOTE—If using a single signal generator with dual outputs, affirm that intermodulation products are not the result of the generator.*
- n) Increase the signal generator amplitude in 2 dB steps to 10 dB above the AGC threshold determined in 7.4i), but not exceeding the maximum input level of 5.5, to affirm that the EUT maintains compliance with the intermodulation limit. The test report shall include either a statement describing that the device complies at 10 dB above AGC or at the 5.5 power levels, or a table showing compliance at the additional input power(s) required.

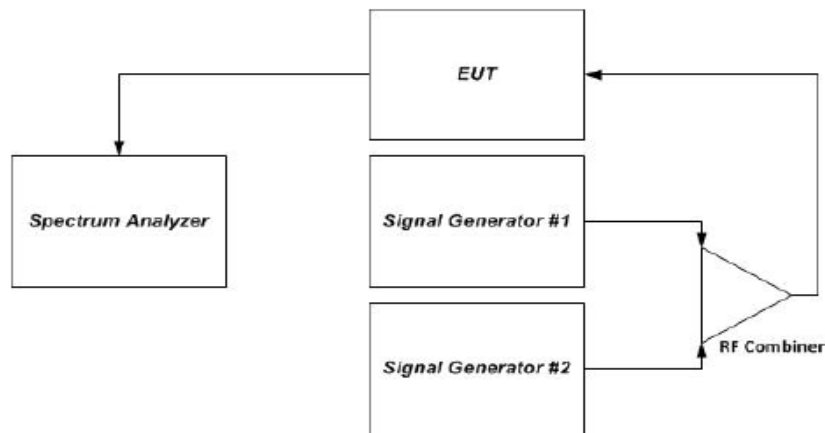
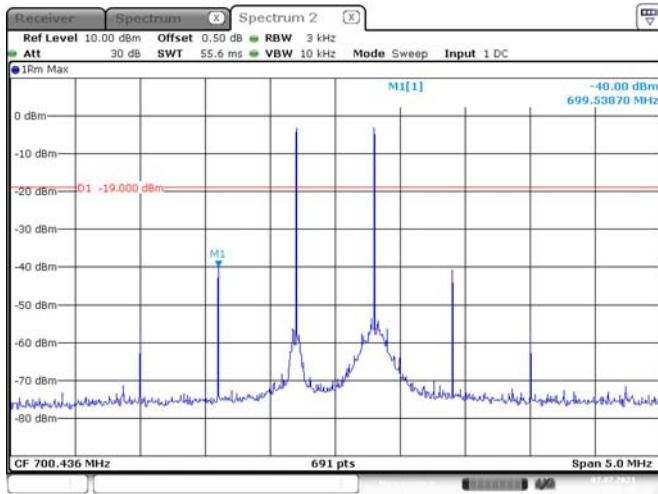

Figure 2 – Intermodulation product instrumentation test setup

Test Data

Test Result: Compliance. Please refer to following plots.

Lower 700MHz Band Uplink-Pre AGC



Date: 7.JUL.2021 09:26:46

Lower 700MHz Band Uplink-Above AGC

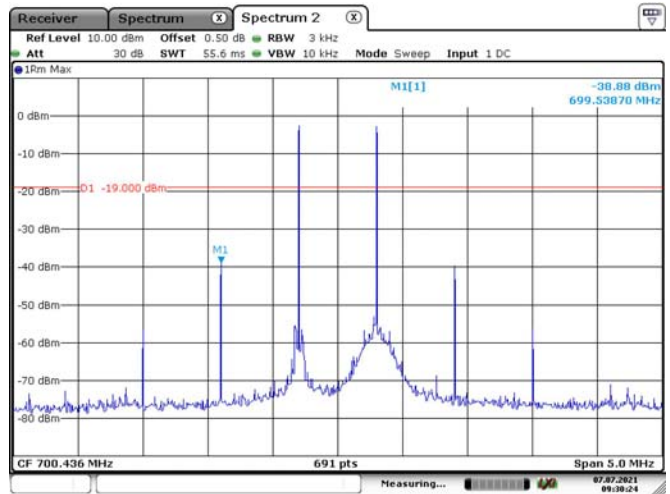

Date: 7.JUL.2021 09:30:25

Upper 700MHz Band Uplink-Pre AGC

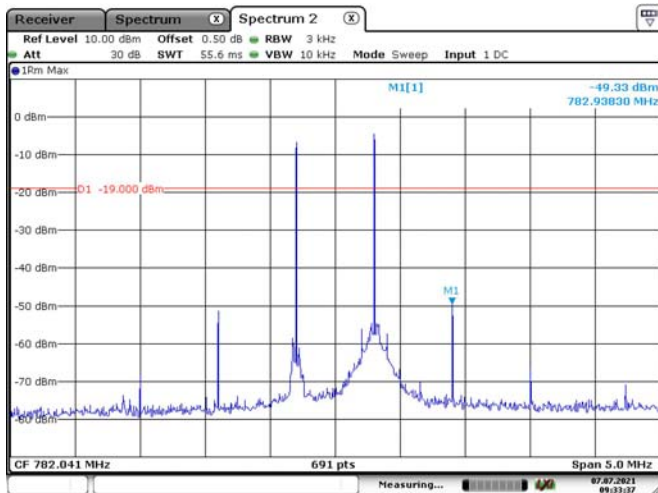

Date: 7.JUL.2021 09:33:37

Upper 700MHz Band Uplink-Above AGC

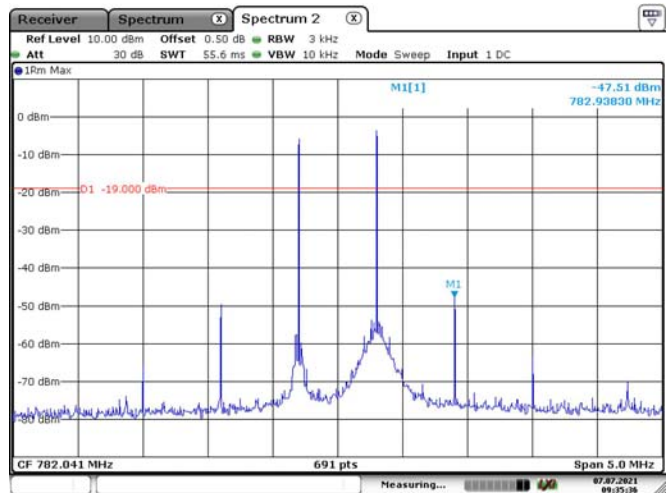

Date: 7.JUL.2021 09:35:36

Cellular Band Uplink-Pre AGC

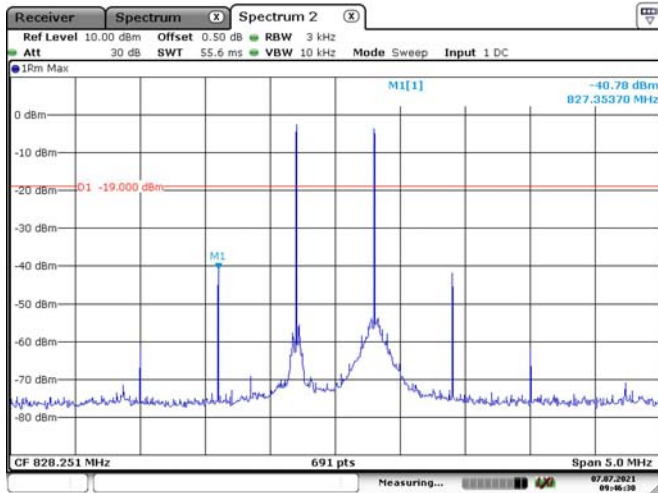

Date: 7.JUL.2021 09:46:30

Cellular Band Uplink-Above AGC

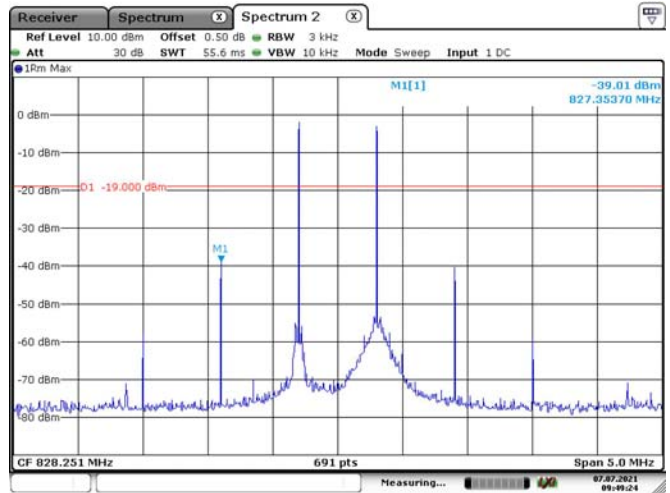

Date: 7.JUL.2021 09:49:24

AWS Band Uplink-Pre AGC

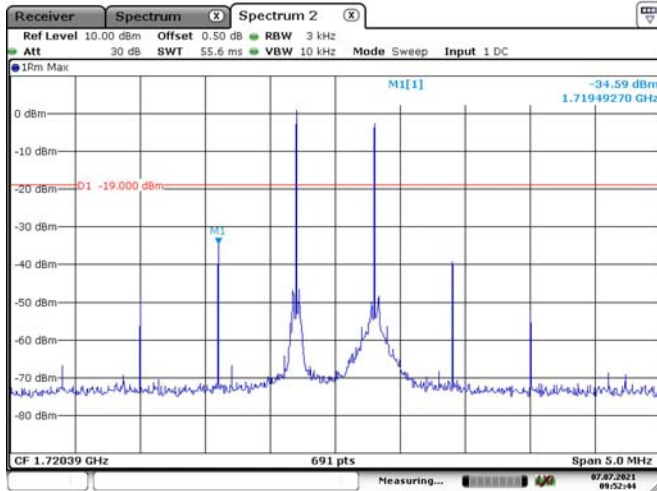

Date: 7.JUL.2021 09:52:45

AWS Band Uplink-Above AGC

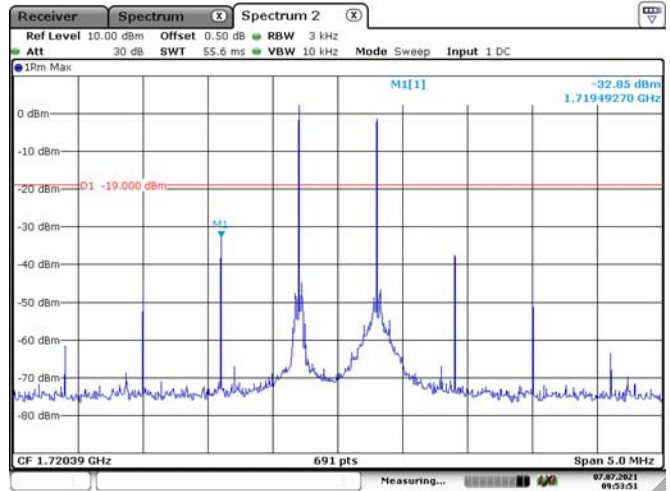

Date: 7.JUL.2021 09:53:52

PCS Band Uplink-Pre AGC

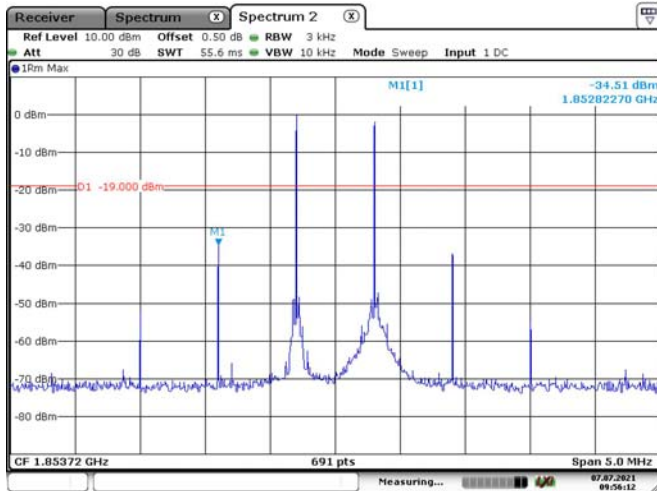

Date: 7.JUL.2021 09:56:13

PCS Band Uplink-Above AGC

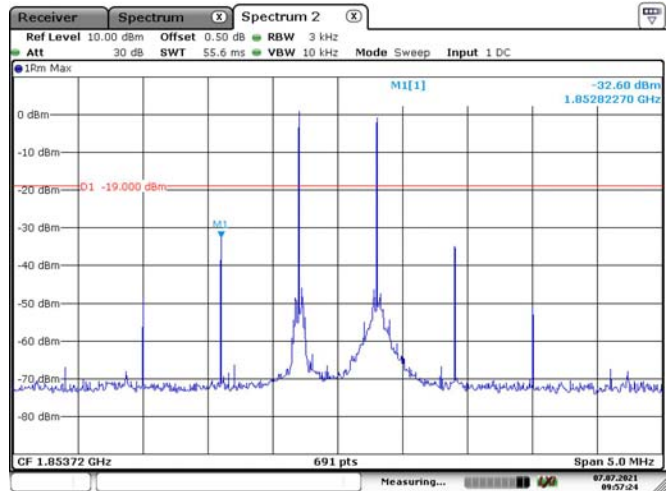

Date: 7.JUL.2021 09:57:25

Lower 700MHz Band Downlink-Pre AGC

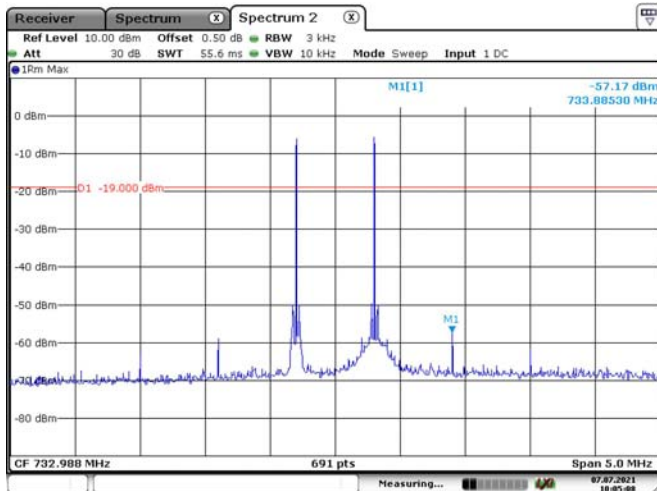

Date: 7.JUL.2021 10:05:09

Lower 700MHz Band Downlink -Above AGC

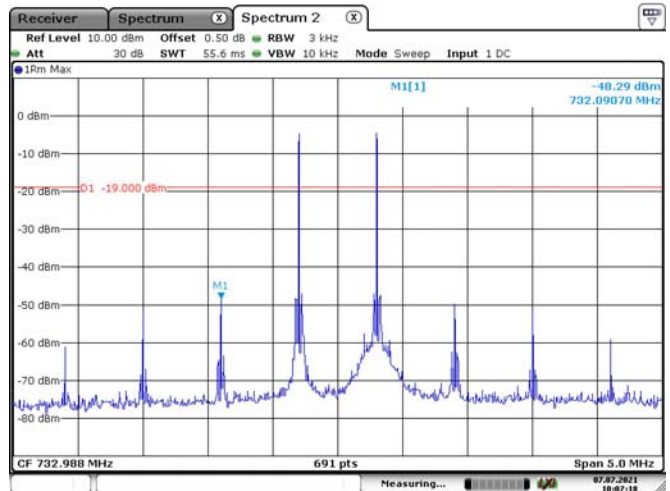

Date: 7.JUL.2021 10:07:19

Upper 700MHz Band Downlink -Pre AGC

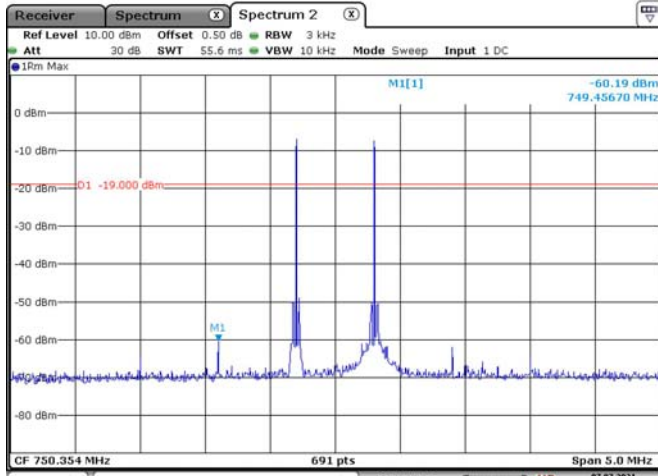

Date: 7.JUL.2021 10:10:17

Upper 700MHz Band Downlink -Above AGC

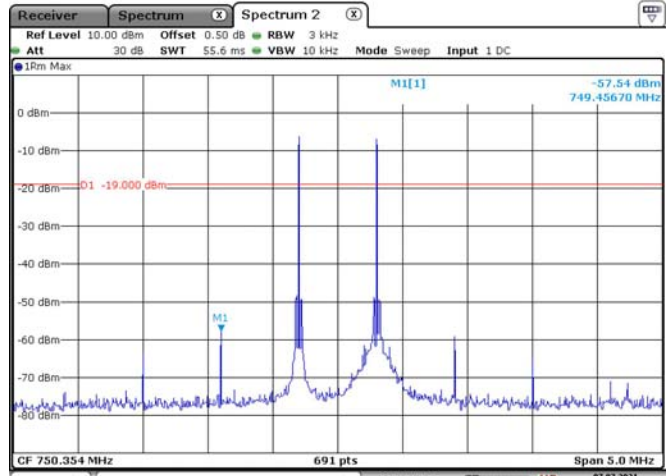

Date: 7.JUL.2021 10:10:59

Cellular Band Downlink -Pre AGC

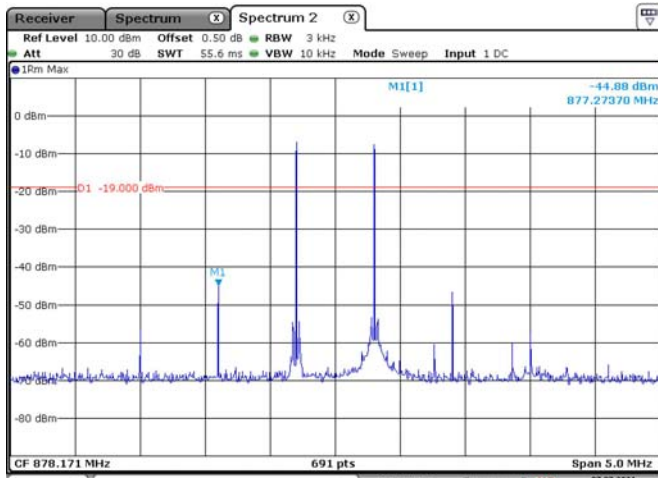

Date: 7.JUL.2021 10:14:36

Cellular Band Downlink -Above AGC

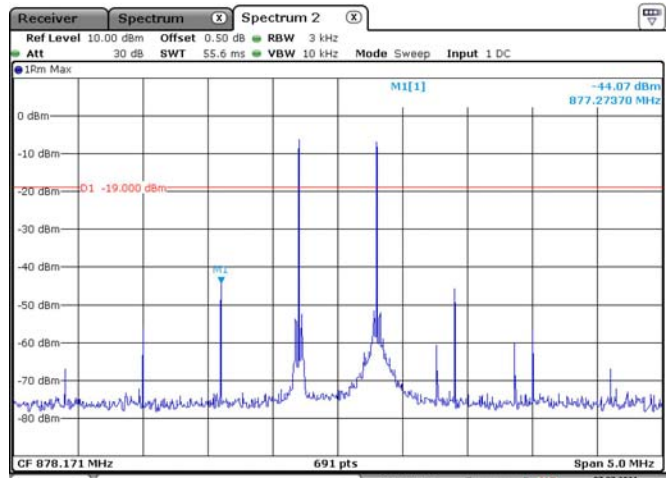

Date: 7.JUL.2021 10:15:27

AWS Band Downlink -Pre AGC

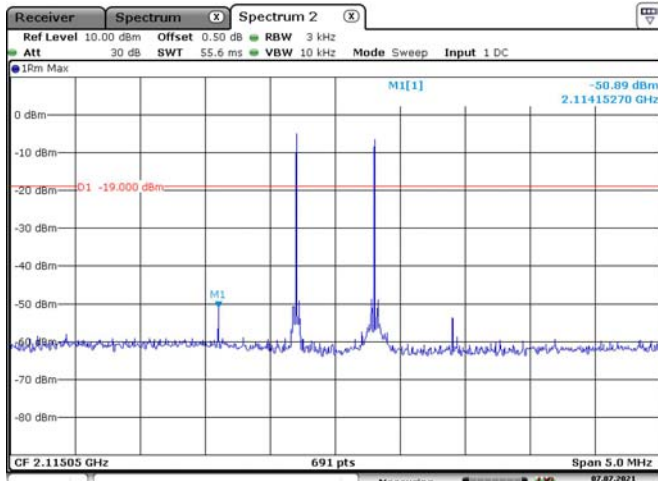

Date: 7.JUL.2021 10:17:37

AWS Band Downlink -Above AGC

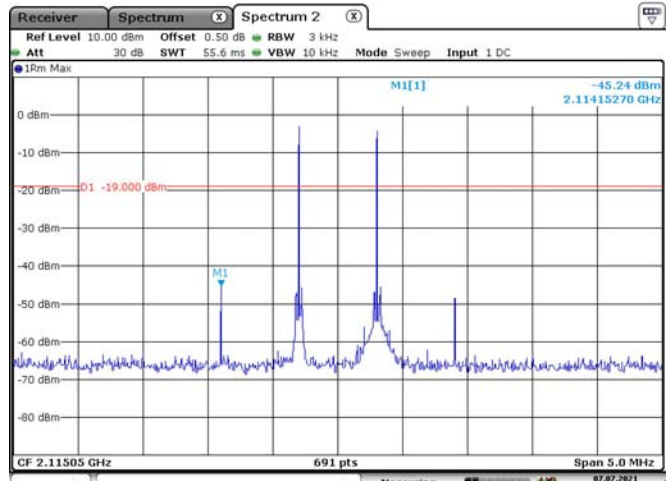

Date: 7.JUL.2021 10:18:26

PCS Band Downlink -Pre AGC

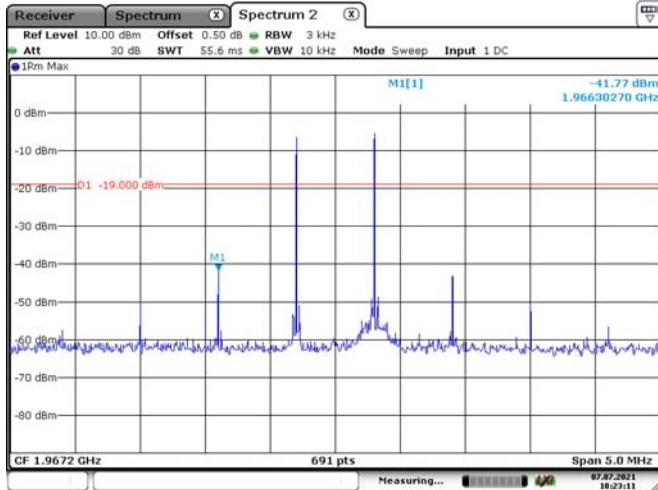

Date: 7.JUL.2021 10:23:12

PCS Band Downlink -Above AGC

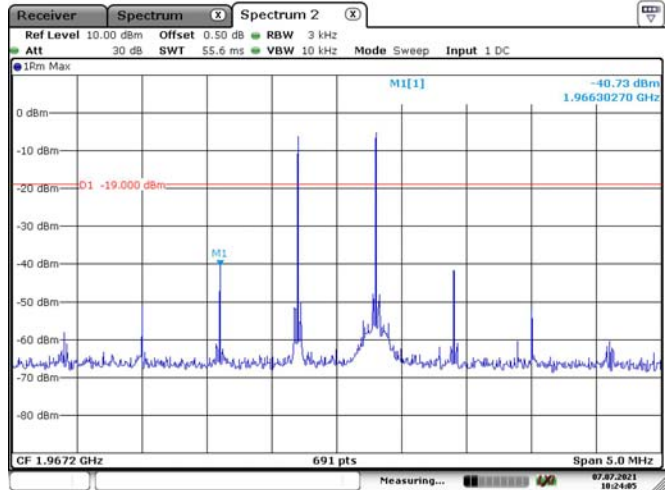

Date: 7.JUL.2021 10:24:05

5 - OUT OF BAND EMISSIONS

Applicable Standards

According to § 20.21(e)(8)(i)(E) *Out of Band Emission Limits*.

Test Procedure

This measurement is intended to demonstrate compliance to the limit specified in Section 20.21(e)(8)(i)(E). The mobile-station emission limit is listed in Appendix A for each applicable operating band and rule part.

a) Connect the EUT to the test equipment as shown in **Figure 1**. Begin with the uplink output (donor) port connected to the spectrum analyzer.

b) Configure the signal generator for the appropriate operation for all uplink and downlink bands:

1) GSM: 0.2 MHz from upper and lower band edges.

2) LTE (5 MHz): 2.5 MHz from upper and lower band edges.

3) CDMA: 1.25 MHz from upper and lower band edges, except for cellular band as follows (only the upper and lower frequencies need to be tested):

824.88 MHz, 845.73 MHz, 836.52 MHz, 848.10 MHz,

869.88 MHz, 890.73 MHz, 881.52 MHz, 893.10 MHz.

NOTE 1—Alternative test modulation types:

- CDMA (alternative 1.25 MHz AWGN)

- LTE 5 MHz (alternative W-CDMA or 4.1 MHz AWGN)

NOTE 2—For LTE, the signal generator should use the uplink and downlink signal types for these modulations in uplink and downlink tests, respectively. LTE shall use 5 MHz signal, 25 resource blocks transmitting.

NOTE 3—When using an AWGN test signal, the bandwidth shall be the measured 99% OBW.

c) Set the signal generator amplitude to the maximum power level prior to AGC similar to 7.2.2e) to 7.2.2f) of the power measurement procedures for the appropriate modulations.

d) Set RBW = measurement bandwidth specified in the applicable rule section for the supported frequency band (see Appendix A for cross-reference to applicable rule section).

NOTE 3—Within 300 kHz and 3 MHz away from band edge, if smaller RBW is used (i.e., RBW < 100 kHz or 1 MHz, for above and below 1 GHz, respectively), per Parts 24 and 27 the smaller RBW is applicable only for frequencies within 100 kHz or 1 MHz (for above and below 1 GHz, respectively) away from the band edge.

e) Set VBW = 3* RBW.

f) Select the power averaging (rms) detector.

g) Sweep time = auto-couple.

h) Set the analyzer start frequency to the upper band/block edge frequency and the stop frequency to the upper band/block edge frequency plus: 300 kHz (when operational frequency is < 1 GHz), or 3 MHz (when operational frequency is ≥ 1 GHz).

i) Trace average at least 100 traces in power averaging (i.e., rms) mode.

j) Use peak marker function to find the maximum power level.

k) Capture the spectrum analyzer trace of the power level for inclusion in the test report.

l) Increase the signal generator amplitude in 2 dB steps until the maximum input level per 5.5 is reached. Affirm that the EUT maintains compliance with the OOB limits. The test report shall include either a statement describing that the device complies at 10 dB above AGC or at the 5.5 power levels, or a table showing compliance at the additional input power(s) required.

m) Reset the analyzer start frequency to the lower band/block edge frequency minus: 300 kHz (when operational frequency is < 1 GHz), or 3 MHz (when operational frequency is ≥ 1 GHz), and the stop frequency to the lower band/block edge frequency, then repeat 7.5i) to 7.5l).

n) Repeat 7.5b) through 7.5m) for each uplink and downlink operational band.

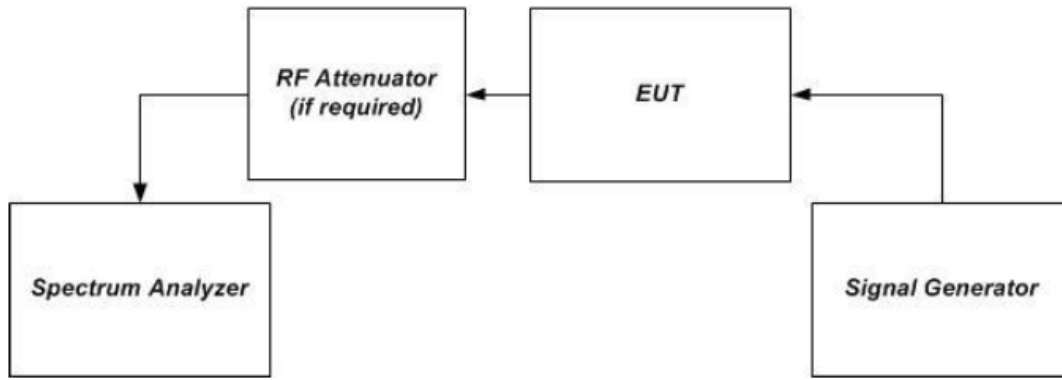

Figure 1 – Band verification test instrumentation setup

Test Data

Test Result: Compliance. Please refer to following plots.

Lower 700M Band Uplink

Left Side-GSM-Pre AGC

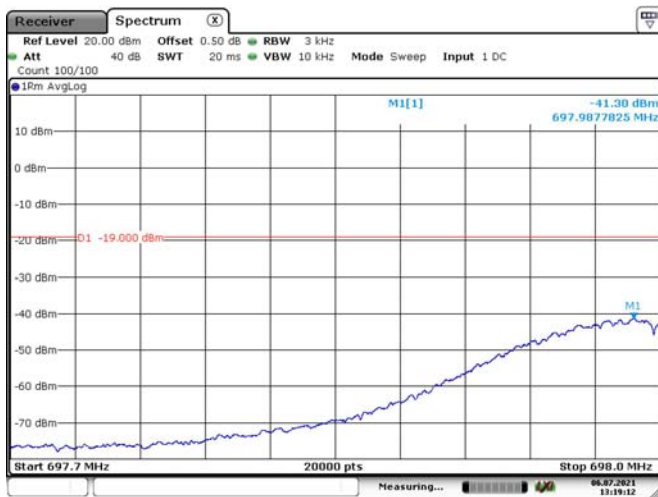

Date: 6.JUL.2021 13:19:13

Left Side-GSM-Above AGC

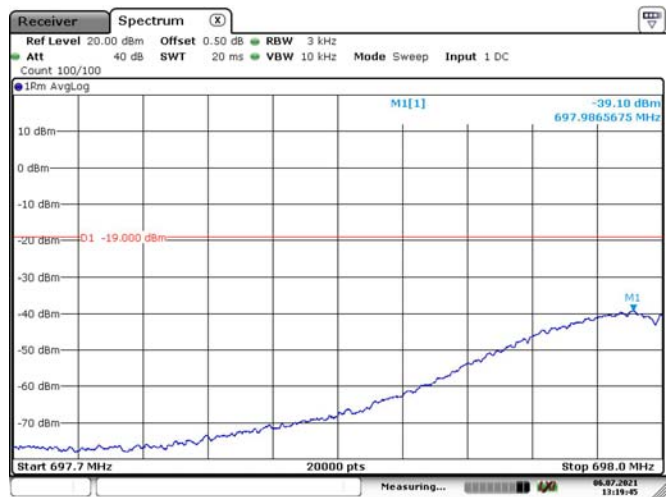

Date: 6.JUL.2021 13:19:46

Left Side-CDMA-Pre AGC

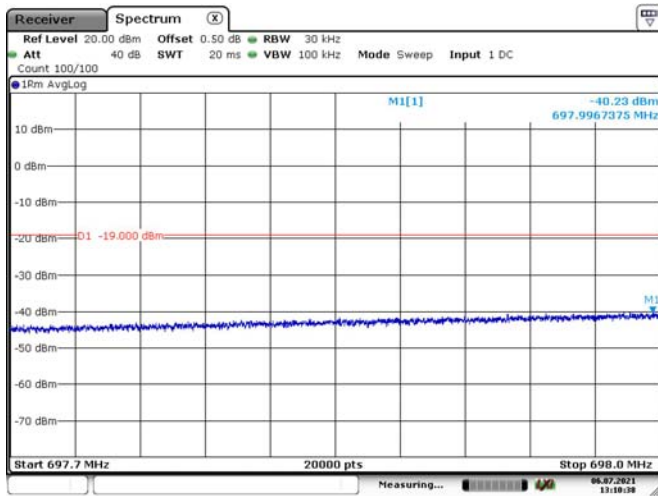

Date: 6.JUL.2021 13:10:39

Left Side-CDMA-Above AGC

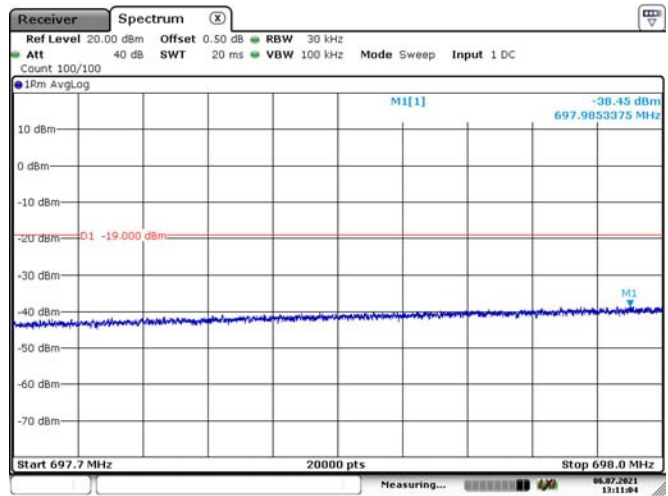

Date: 6.JUL.2021 13:11:05

Left Side-WCDMA-Pre AGC

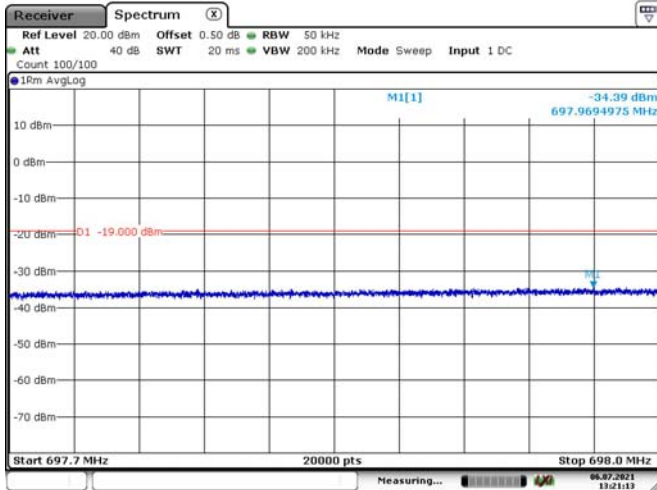

Date: 6.JUL.2021 13:21:14

Left Side-WCDMA-Above AGC

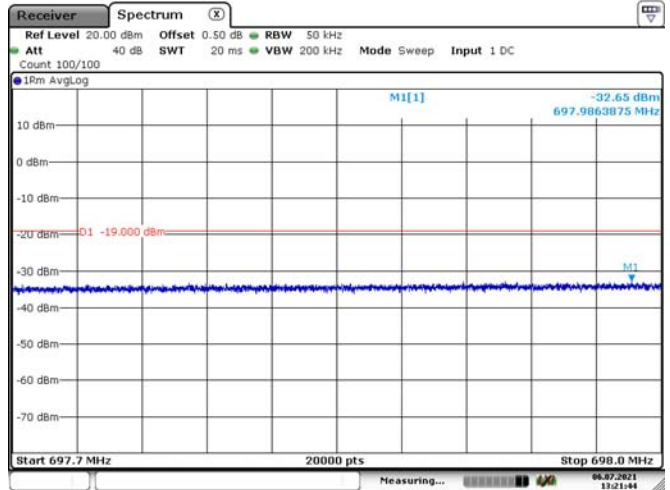

Date: 6.JUL.2021 13:21:45

Right Side-GSM-Pre AGC

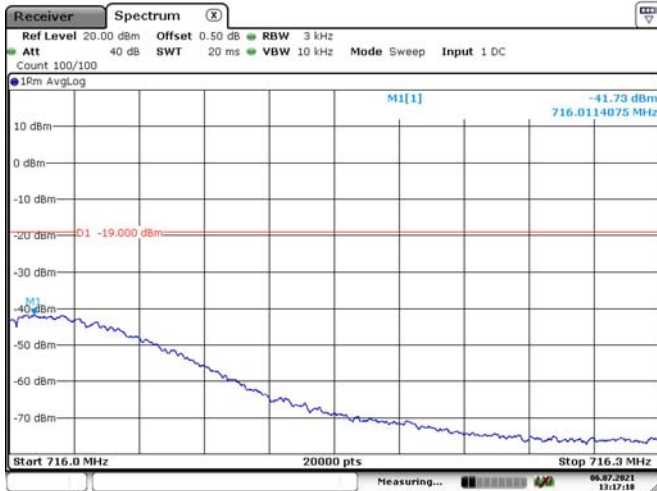

Date: 6.JUL.2021 13:17:19

Right Side-GSM-Above AGC

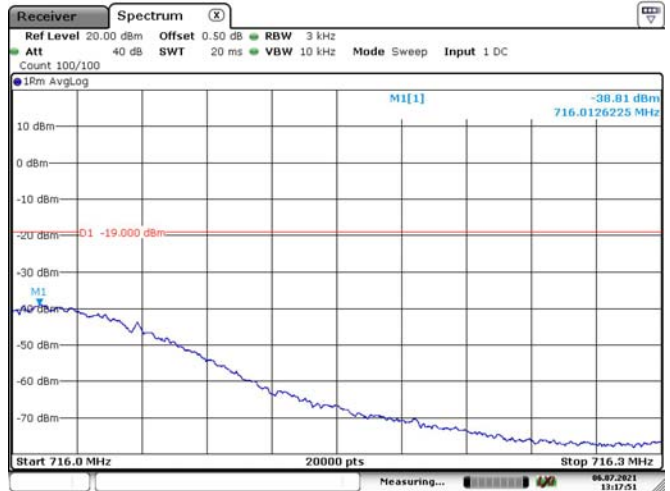

Date: 6.JUL.2021 13:17:52

Right Side-CDMA-Pre AGC

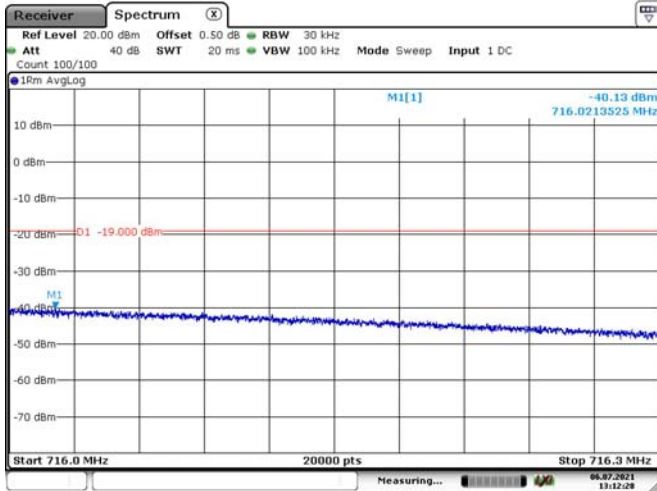

Date: 6.JUL.2021 13:12:28

Right Side-CDMA-Above AGC

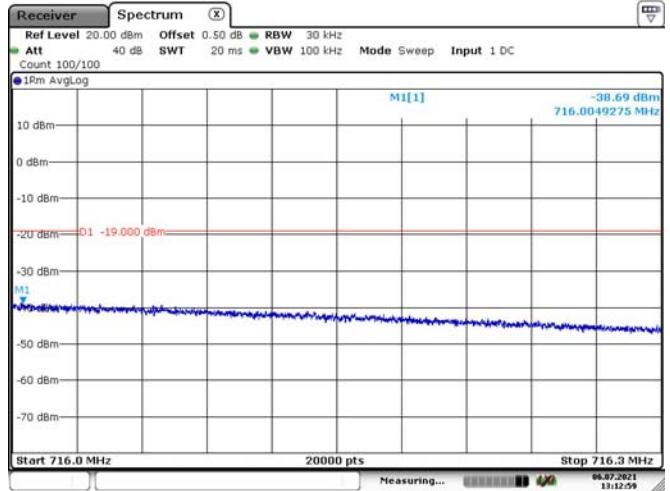

Date: 6.JUL.2021 13:12:59

Right Side-WCDMA-Pre AGC

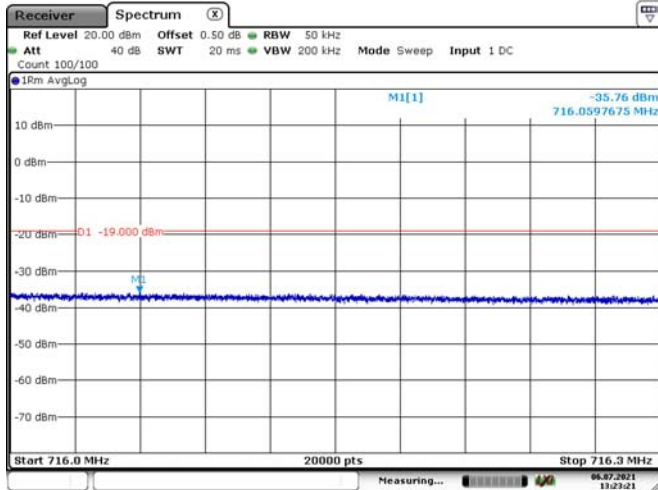

Date: 6.JUL.2021 13:23:21

Right Side-WCDMA-Above AGC

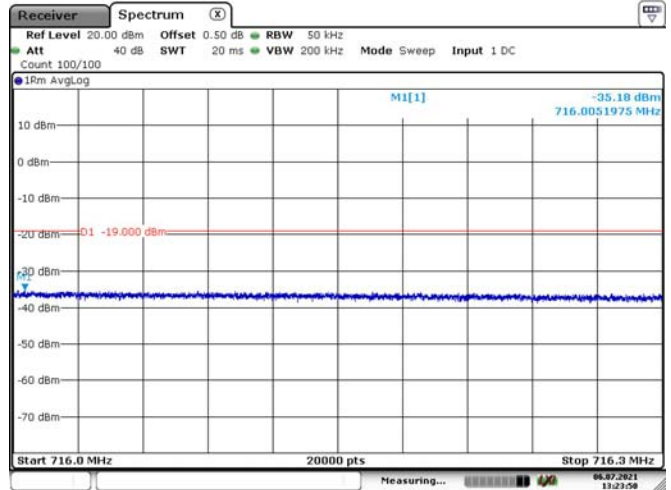

Date: 6.JUL.2021 13:23:50

Upper 700M Band Uplink

Left Side-GSM-Pre AGC

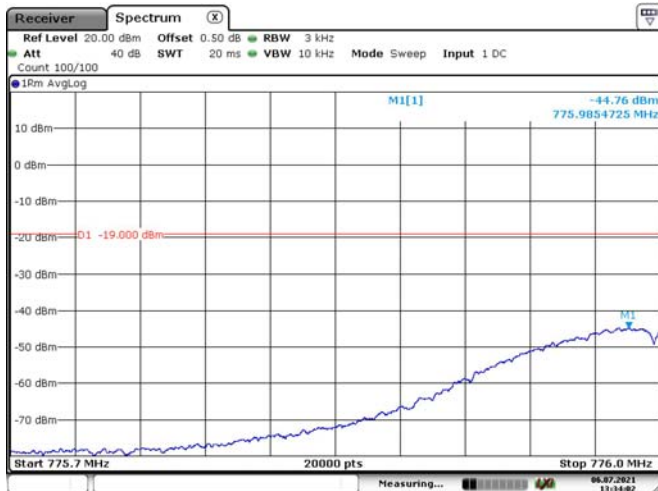

Date: 6.JUL.2021 13:34:03

Left Side-GSM-Above AGC



Date: 6.JUL.2021 13:34:28

Left Side-CDMA-Pre AGC

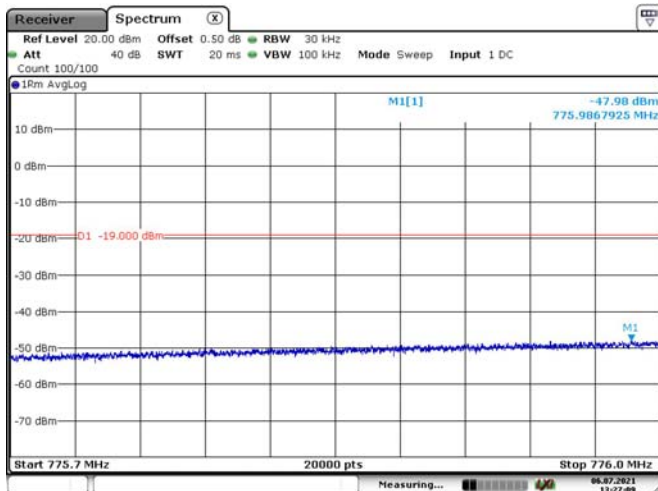

Date: 6.JUL.2021 13:27:10

Left Side-CDMA-Above AGC

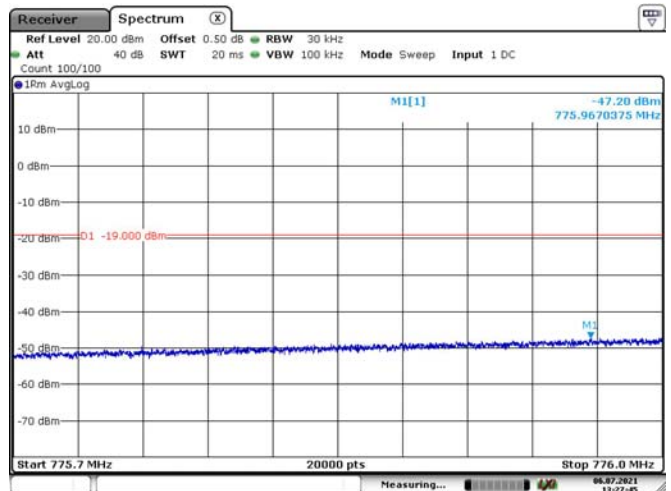

Date: 6.JUL.2021 13:27:45

Left Side-WCDMA-Pre AGC

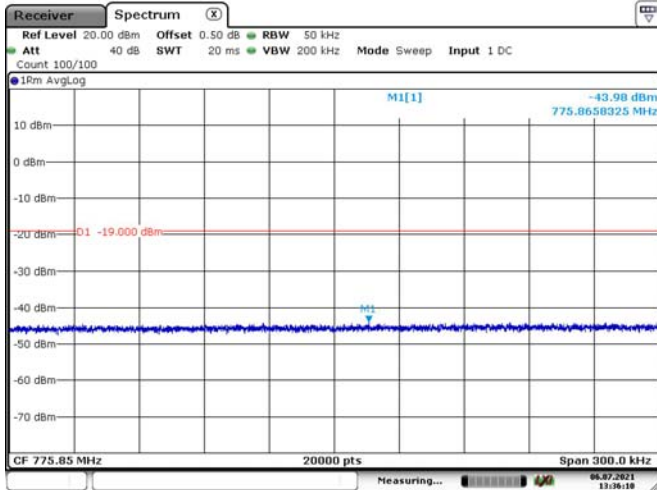

Date: 6.JUL.2021 13:36:10

Left Side-WCDMA-Above AGC

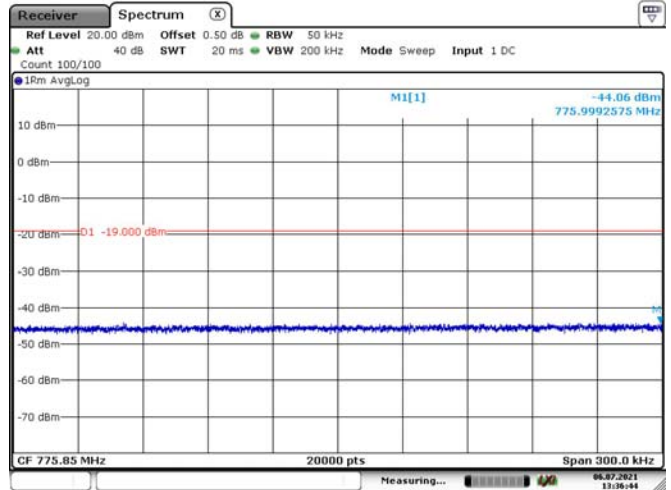

Date: 6.JUL.2021 13:36:44

Right Side-GSM-Pre AGC

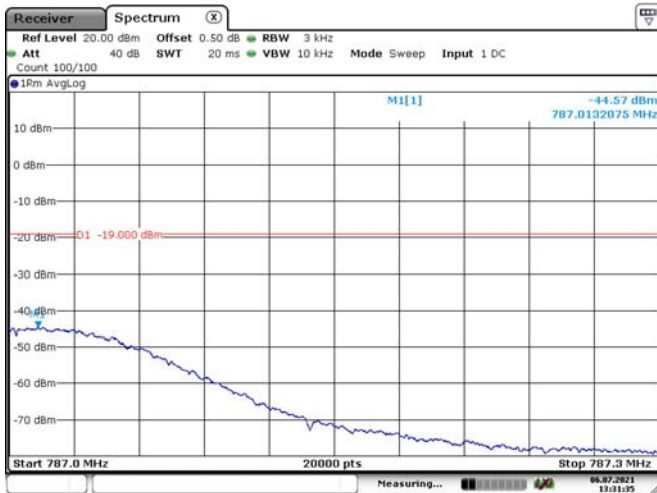

Date: 6.JUL.2021 13:31:36

Right Side-GSM-Above AGC

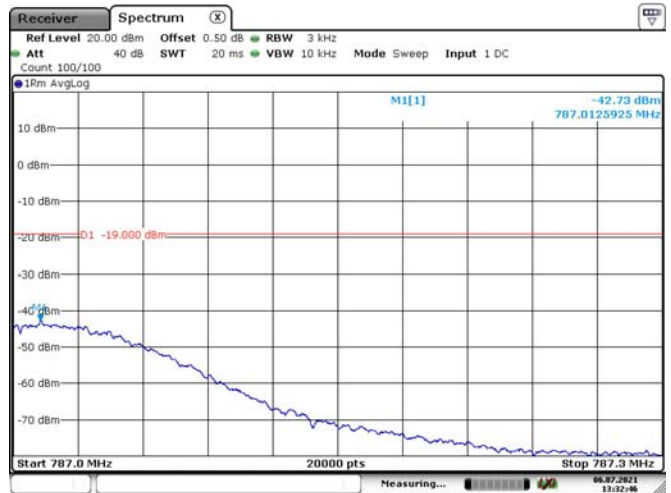

Date: 6.JUL.2021 13:32:47

Right Side-CDMA-Pre AGC

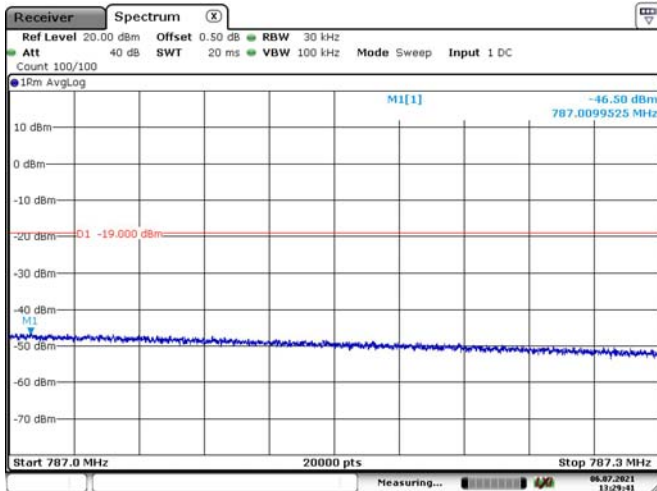

Date: 6.JUL.2021 13:29:42

Right Side-CDMA-Above AGC

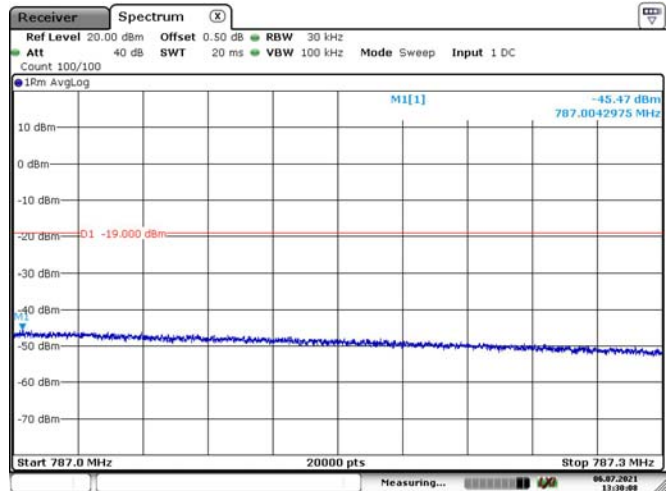

Date: 6.JUL.2021 13:30:08

Right Side-WCDMA-Pre AGC

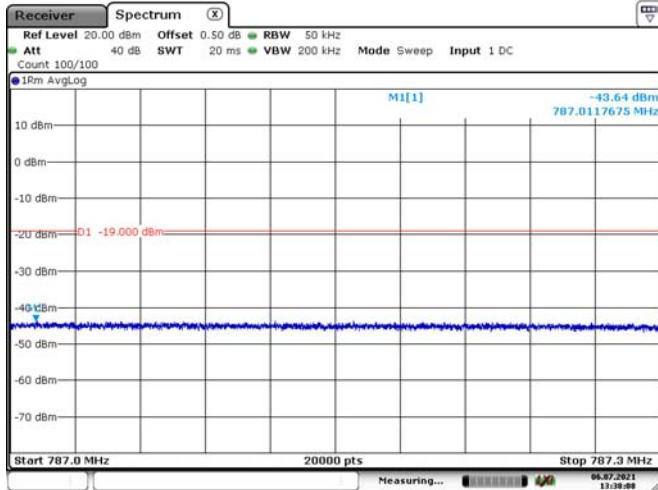

Date: 6.JUL.2021 13:38:08

Right Side-WCDMA-Above AGC

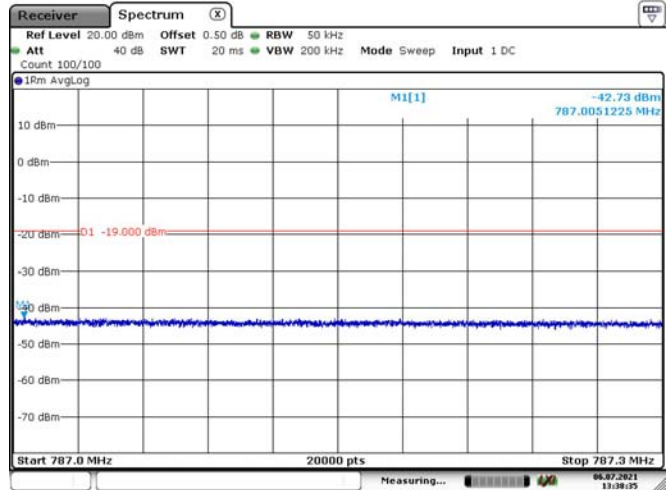

Date: 6.JUL.2021 13:38:36

Cellular Band Uplink

Left Side-GSM-Pre AGC

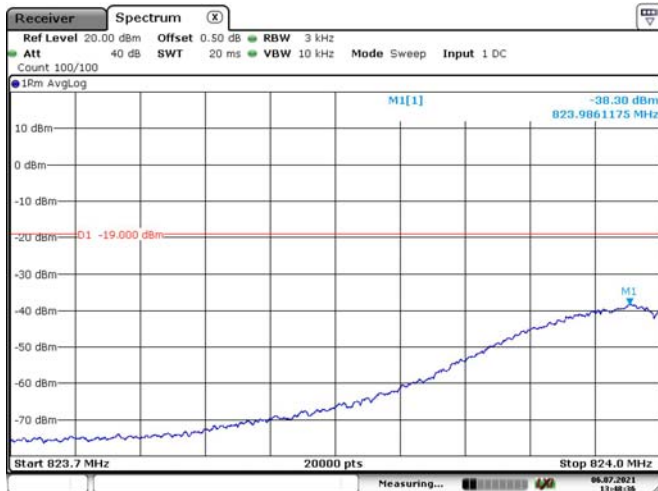

Date: 6.JUL.2021 13:48:37

Left Side-GSM-Above AGC

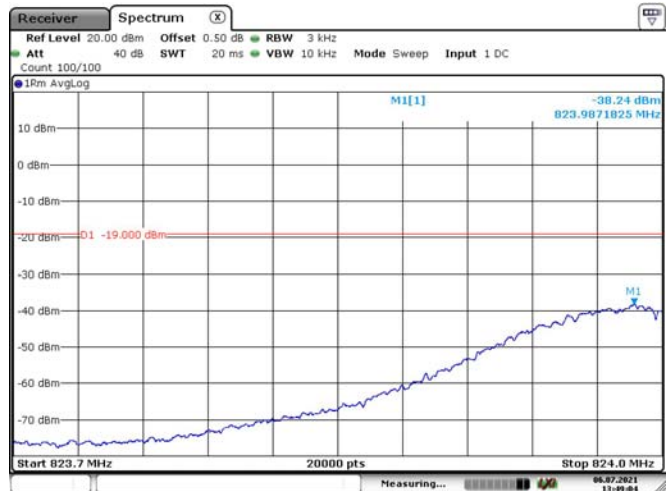

Date: 6.JUL.2021 13:49:05

Left Side-CDMA-Pre AGC

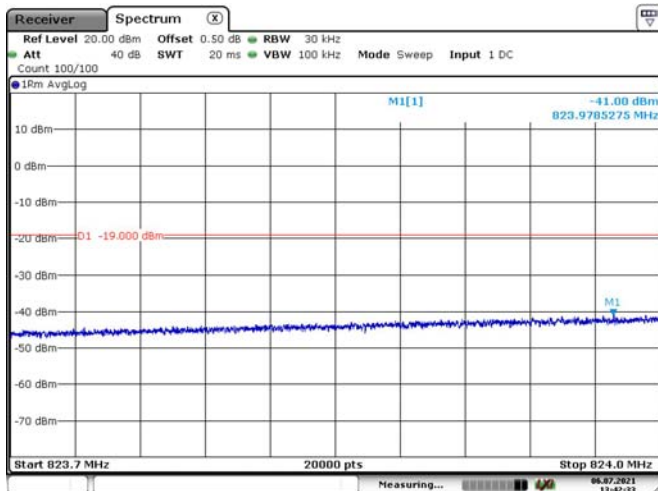

Date: 6.JUL.2021 13:42:34

Left Side-CDMA-Above AGC

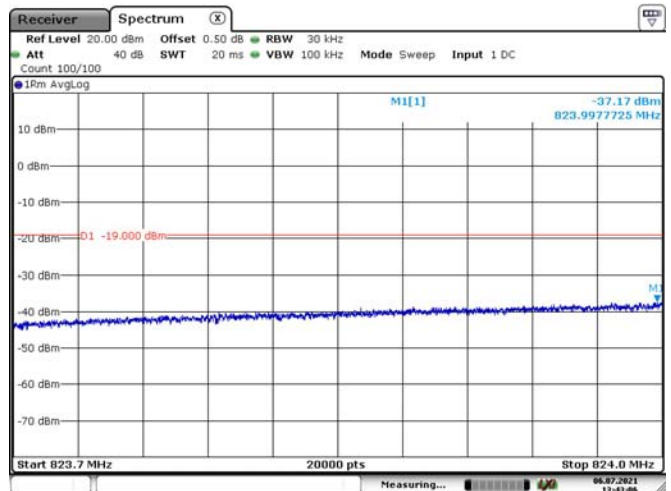

Date: 6.JUL.2021 13:43:07

Left Side-WCDMA-Pre AGC

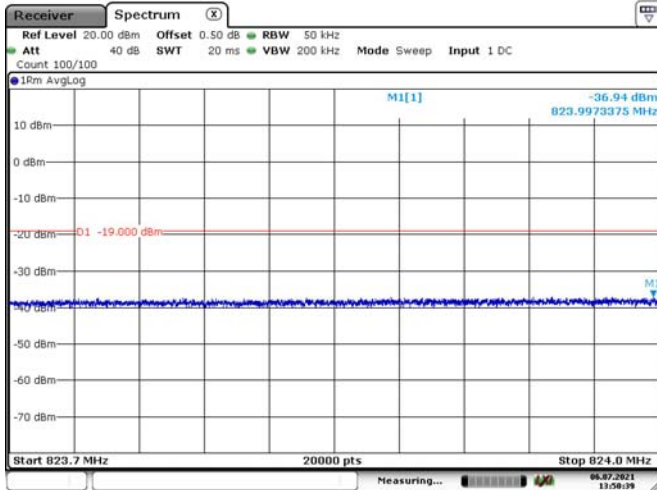

Date: 6.JUL.2021 13:50:39

Left Side-WCDMA-Above AGC

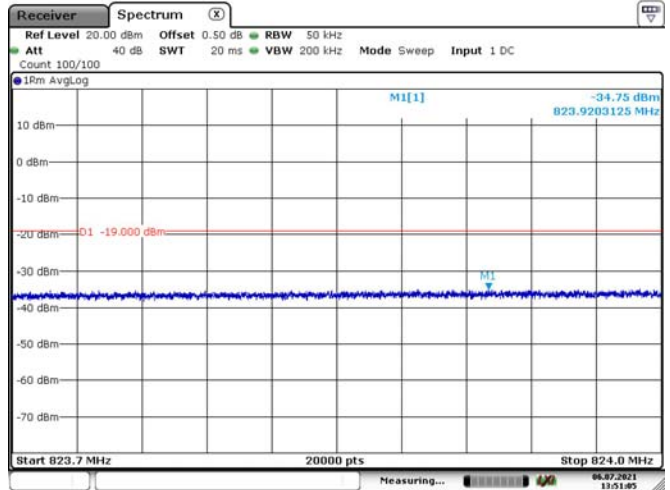

Date: 6.JUL.2021 13:51:06

Right Side-GSM-Pre AGC

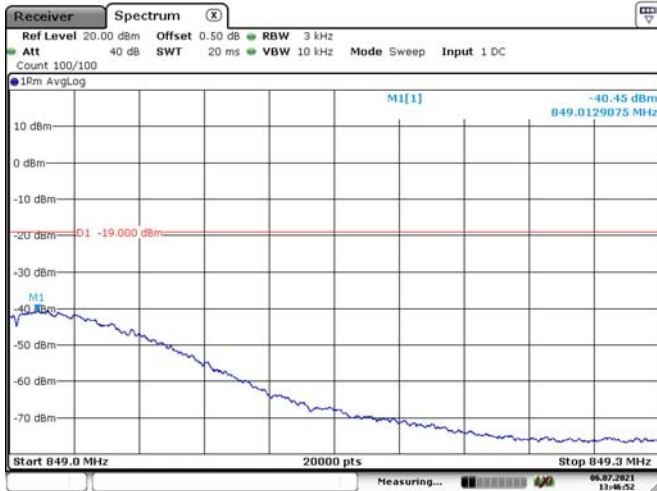

Date: 6.JUL.2021 13:46:53

Right Side-GSM-Above AGC

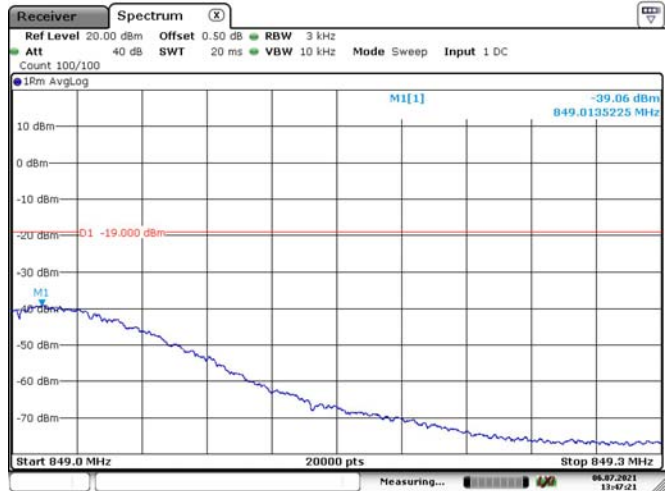

Date: 6.JUL.2021 13:47:22

Right Side-CDMA-Pre AGC

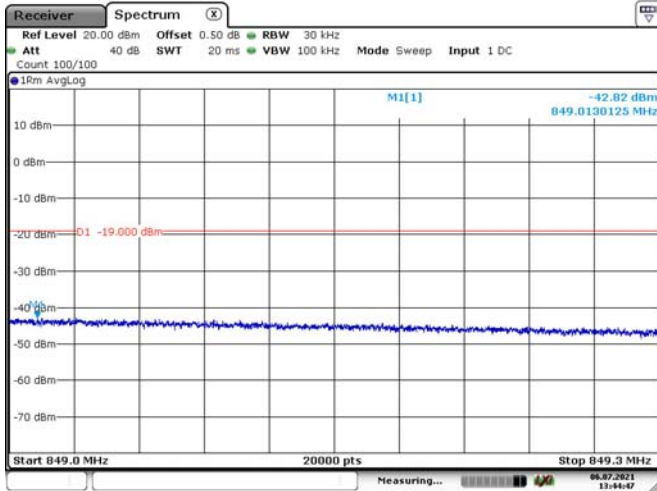

Date: 6.JUL.2021 13:44:48

Right Side-CDMA-Above AGC

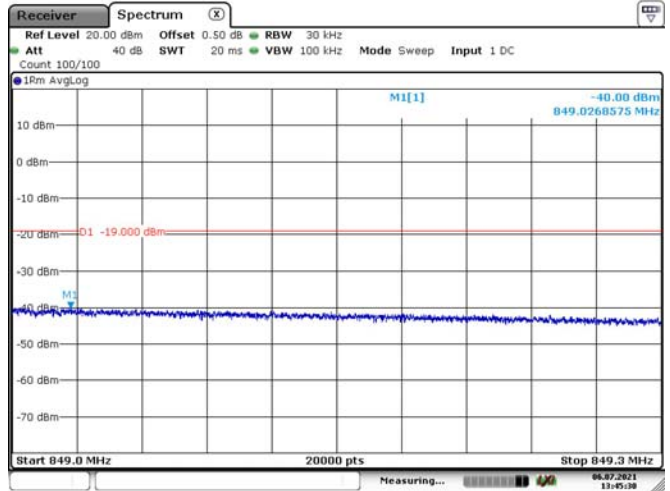

Date: 6.JUL.2021 13:45:31

Right Side-WCDMA-Pre AGC

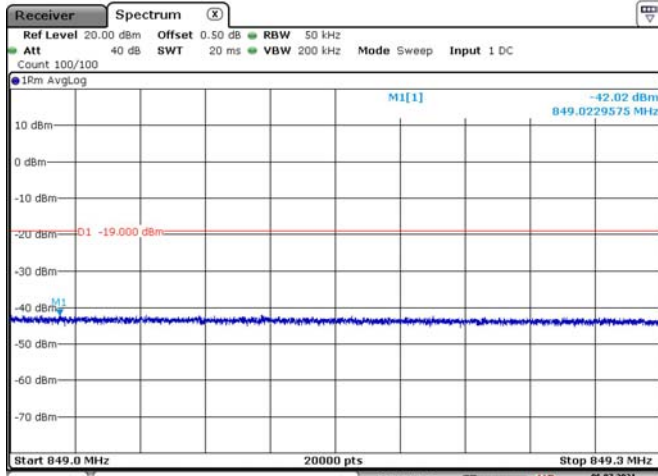

Date: 6.JUL.2021 13:52:17

Right Side-WCDMA-Above AGC

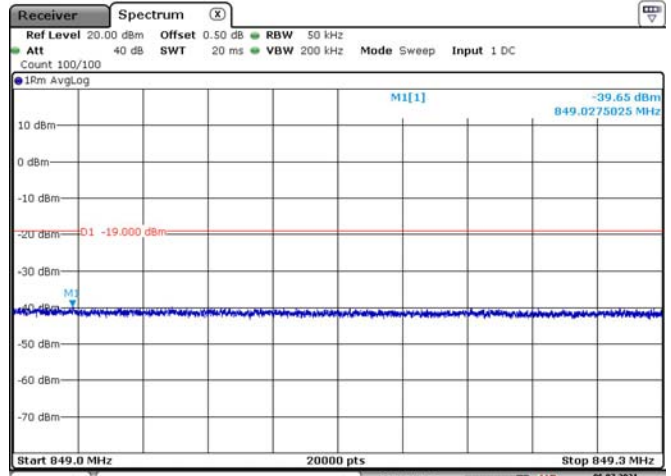

Date: 6.JUL.2021 13:52:46

AWS Band Uplink

Left Side-GSM-Pre AGC

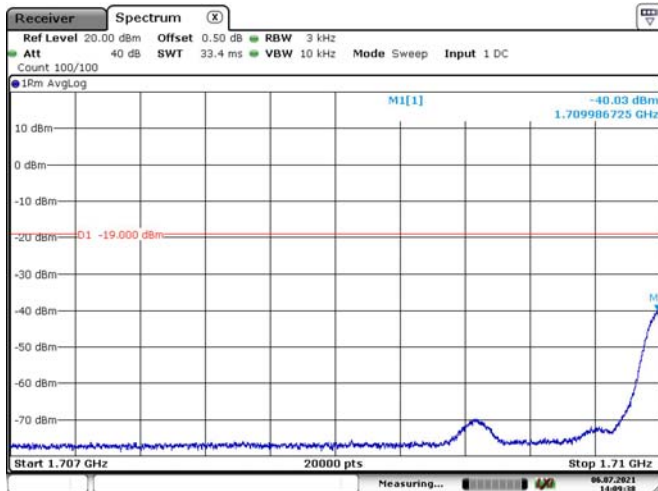

Date: 6.JUL.2021 14:09:39

Left Side-GSM-Above AGC

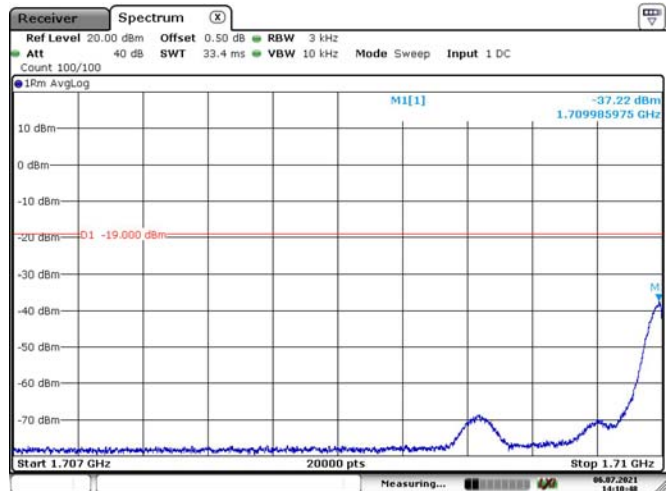

Date: 6.JUL.2021 14:10:49

Left Side-CDMA-Pre AGC

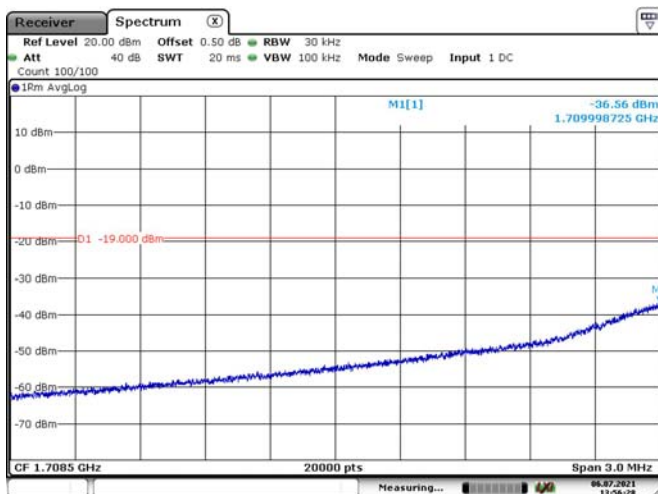

Date: 6.JUL.2021 13:56:29

Left Side-CDMA-Above AGC

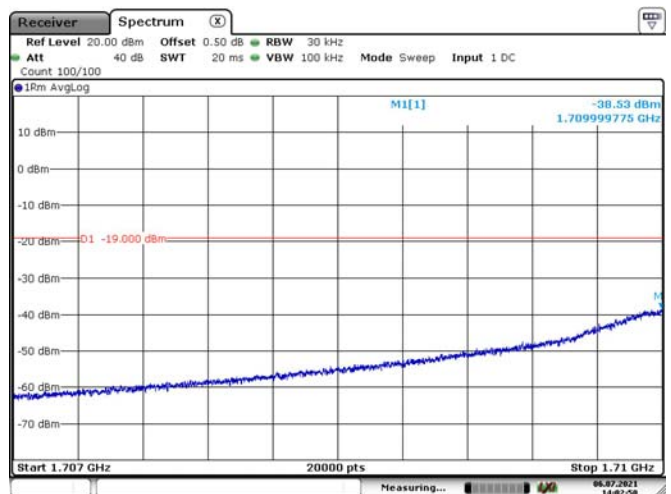

Date: 6.JUL.2021 14:02:51

Left Side-WCDMA-Pre AGC

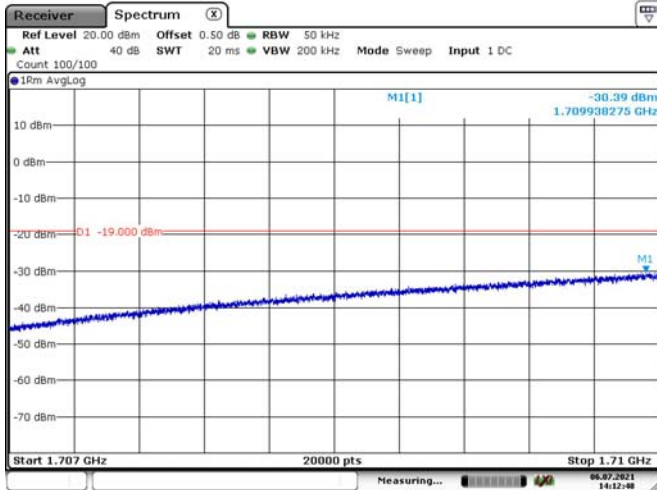

Date: 6.JUL.2021 14:12:49

Left Side-WCDMA-Above AGC

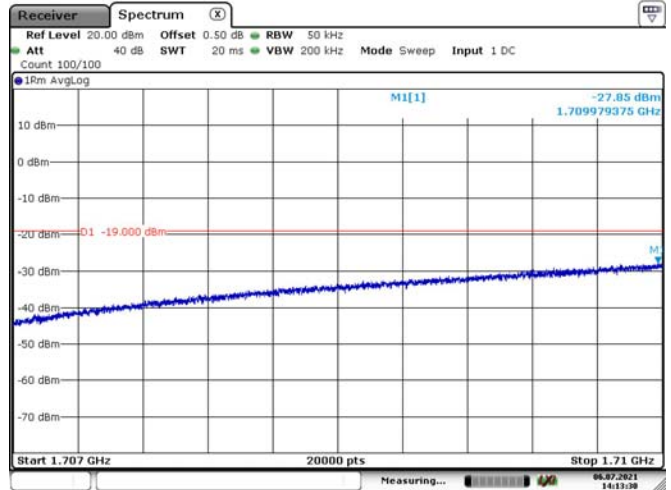

Date: 6.JUL.2021 14:13:30

Right Side-GSM-Pre AGC

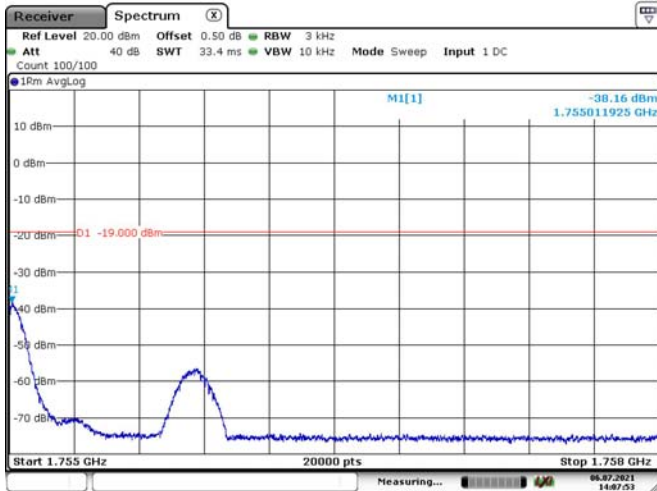

Date: 6.JUL.2021 14:07:54

Right Side-GSM-Above AGC

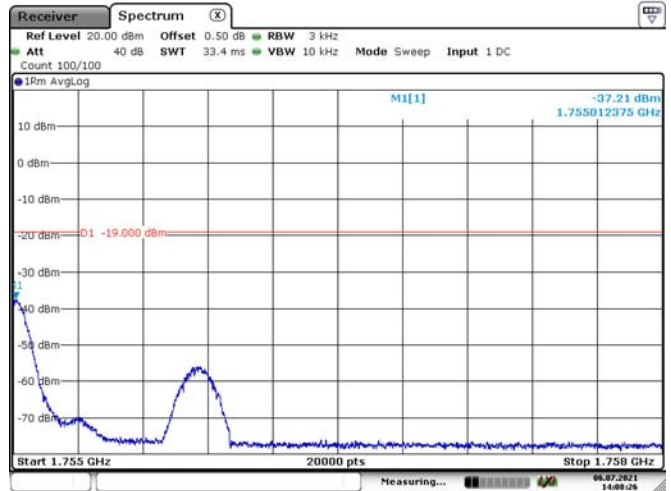

Date: 6.JUL.2021 14:08:26

Right Side-CDMA-Pre AGC

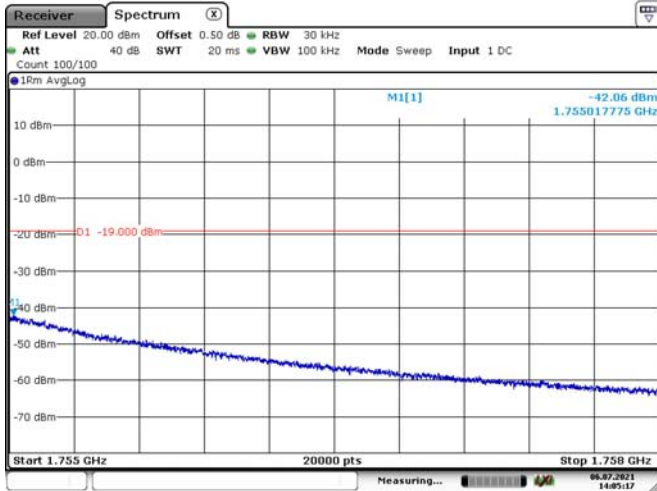

Date: 6.JUL.2021 14:05:18

Right Side-CDMA-Above AGC

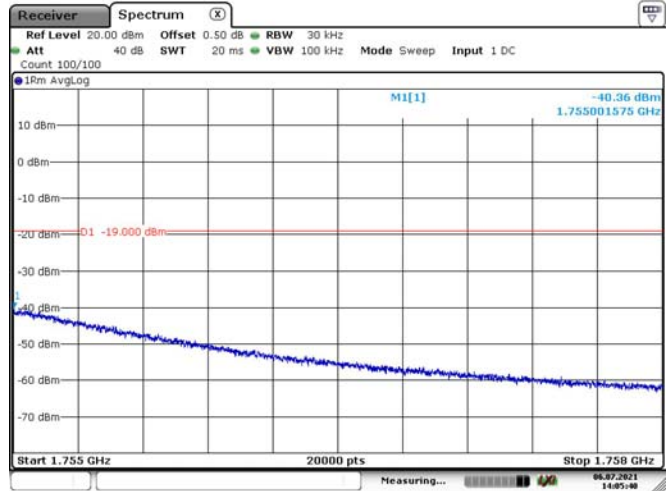

Date: 6.JUL.2021 14:05:41

Right Side-WCDMA-Pre AGC

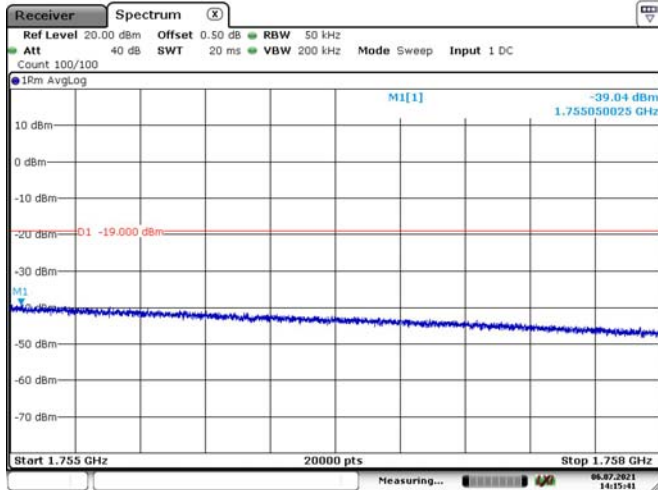

Right Side-WCDMA-Above AGC

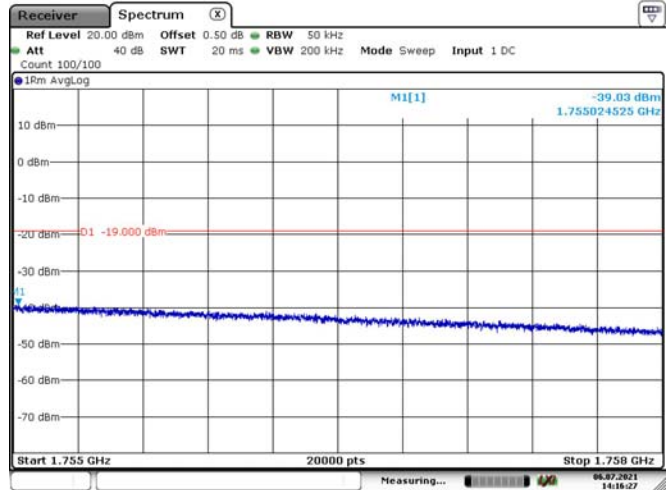

PCS Band Uplink

Left Side-GSM-Pre AGC

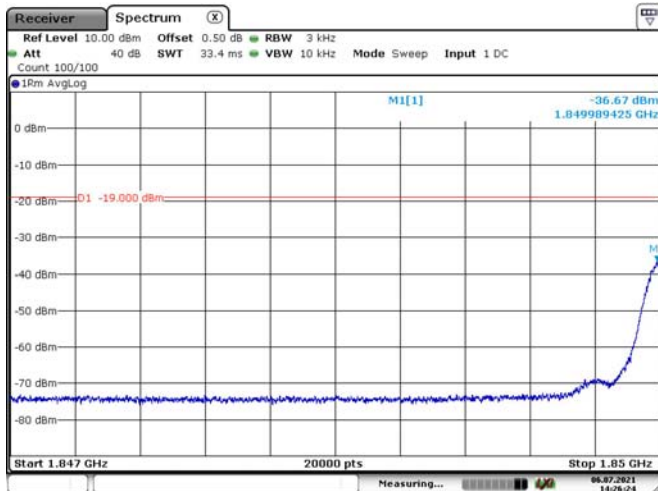

Left Side-GSM-Above AGC

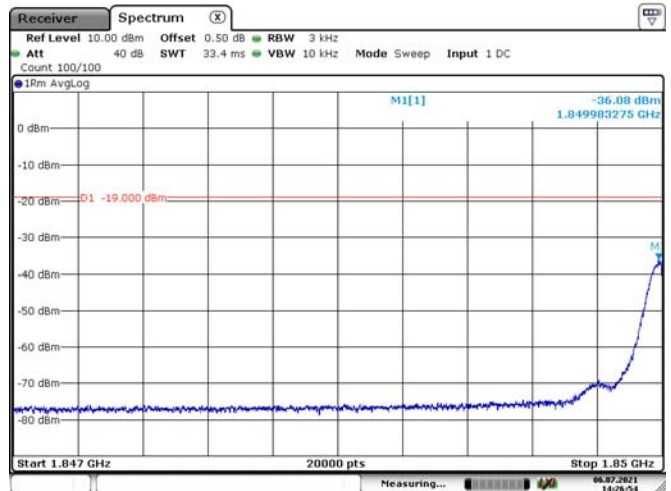

Left Side-CDMA-Pre AGC

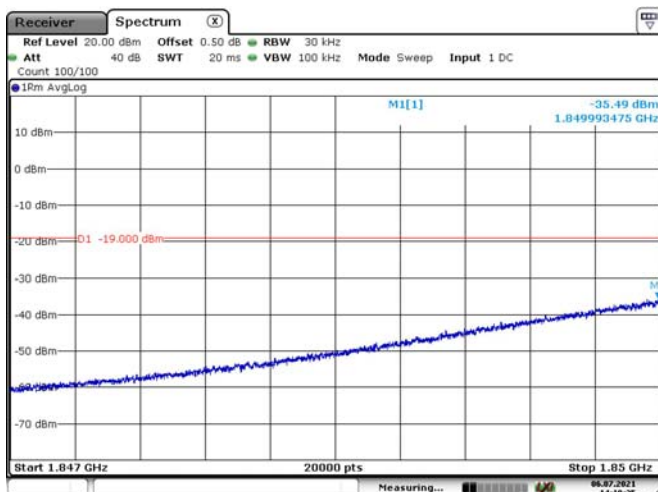

Left Side-CDMA-Above AGC

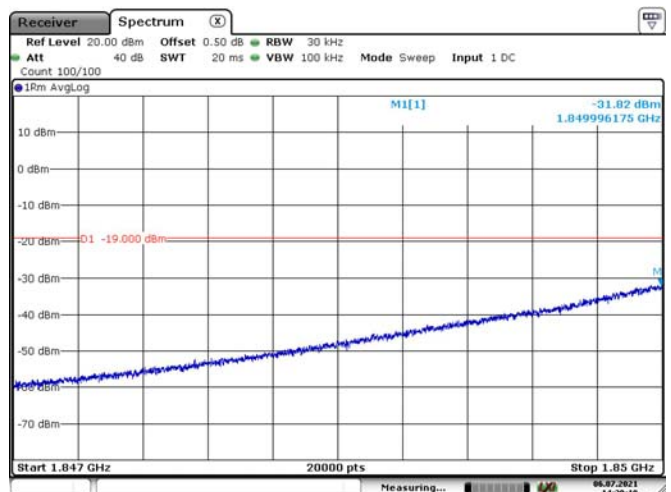

Left Side-WCDMA-Pre AGC

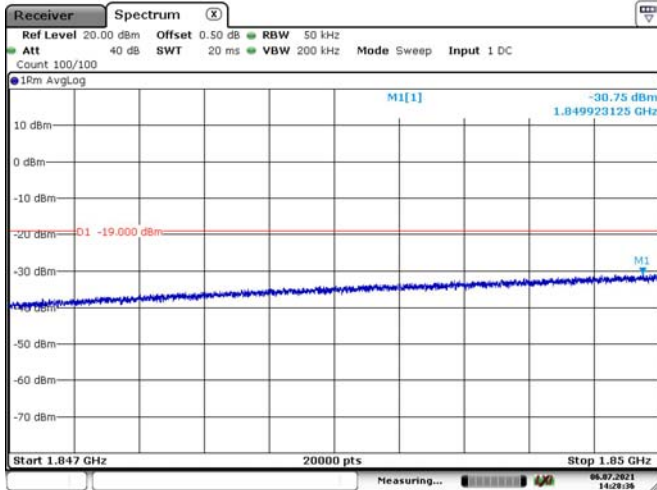

Date: 6.JUL.2021 14:28:37

Left Side-WCDMA-Above AGC

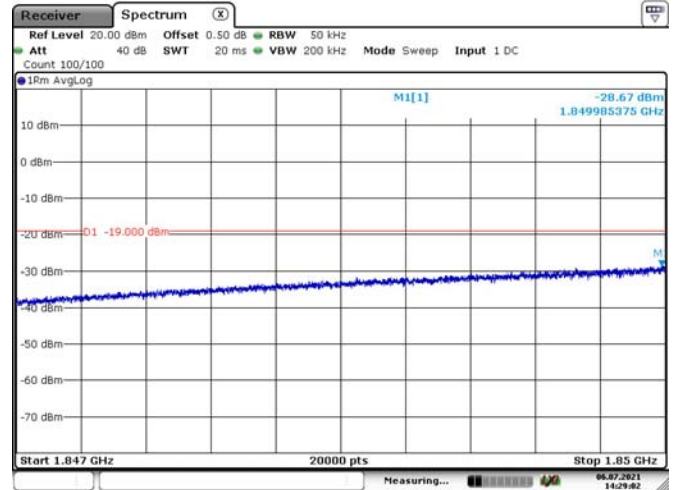

Date: 6.JUL.2021 14:29:03

Right Side-GSM-Pre AGC

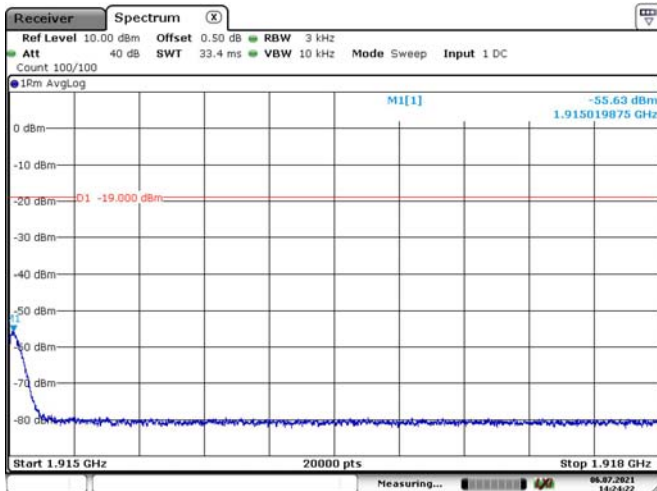

Date: 6.JUL.2021 14:24:23

Right Side-GSM-Above AGC

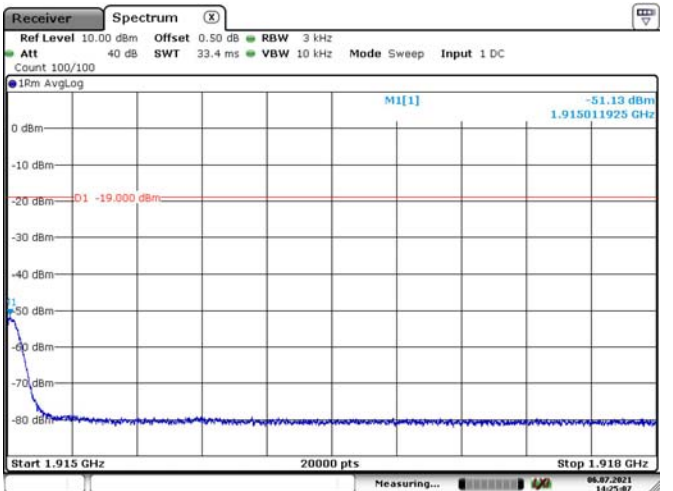

Date: 6.JUL.2021 14:25:08

Right Side-CDMA-Pre AGC

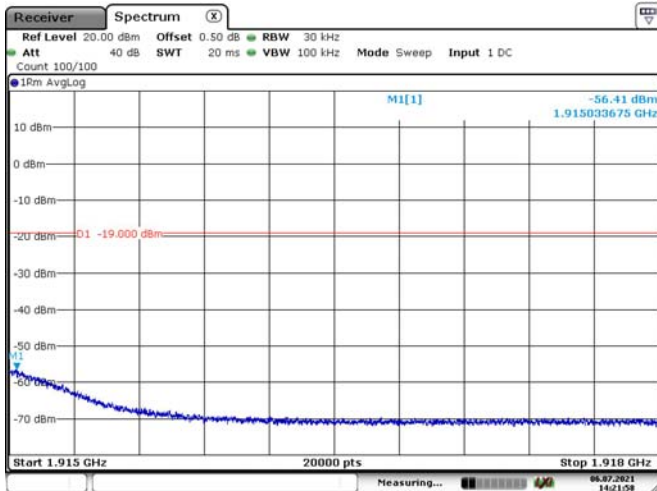

Date: 6.JUL.2021 14:21:59

Right Side-CDMA-Above AGC

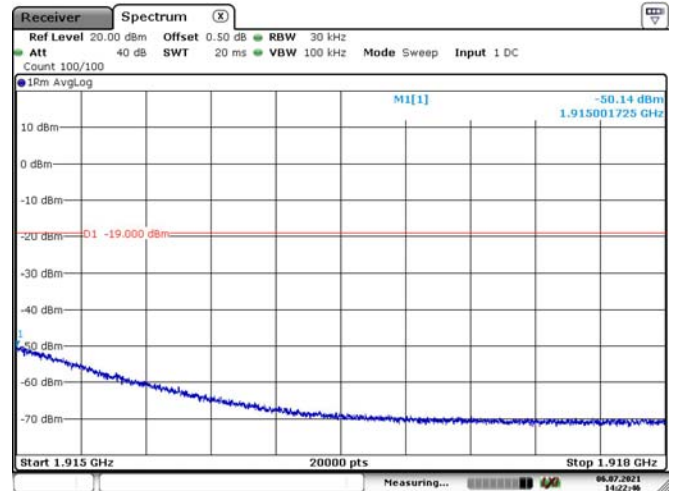

Date: 6.JUL.2021 14:22:47

Right Side-WCDMA-Pre AGC

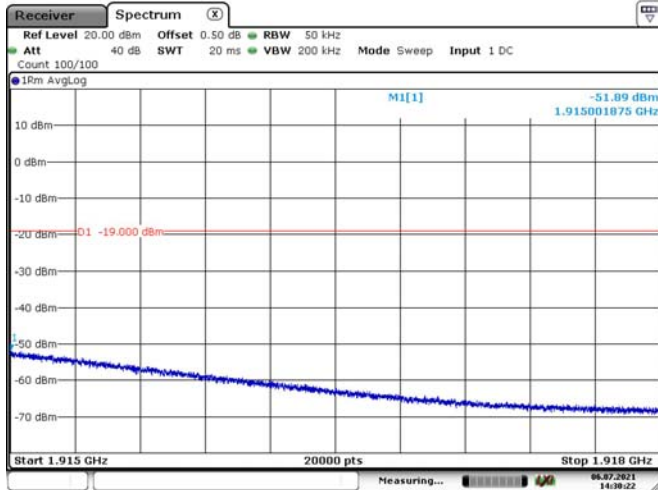

Date: 6.JUL.2021 14:30:22

Right Side-WCDMA-Above AGC

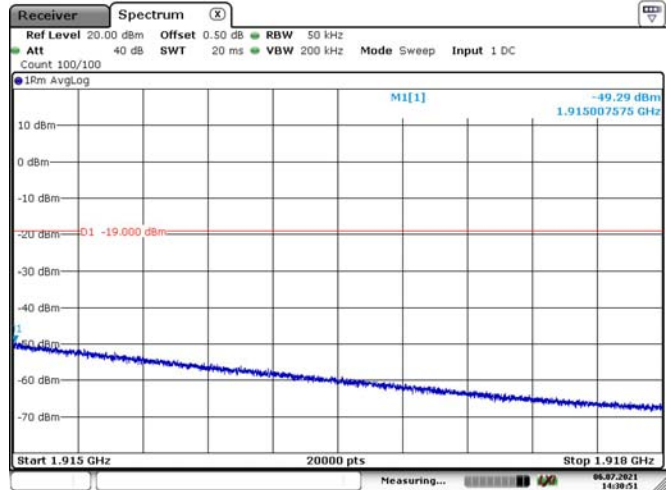

Date: 6.JUL.2021 14:30:52

Lower 700M Band Downlink

Left Side-GSM-Pre AGC

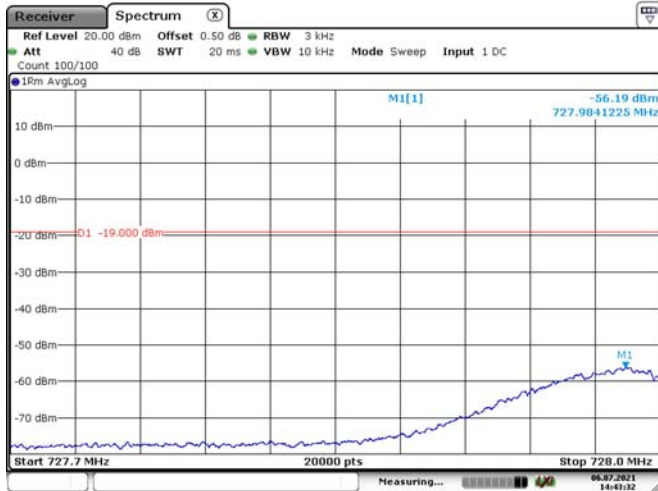

Date: 6.JUL.2021 14:43:33

Left Side-GSM-Above AGC



Date: 6.JUL.2021 14:44:08

Left Side-CDMA-Pre AGC

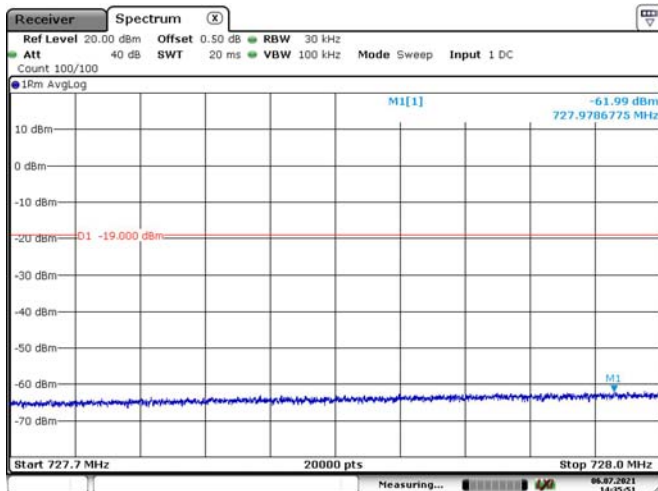

Date: 6.JUL.2021 14:35:52

Left Side-CDMA-Above AGC

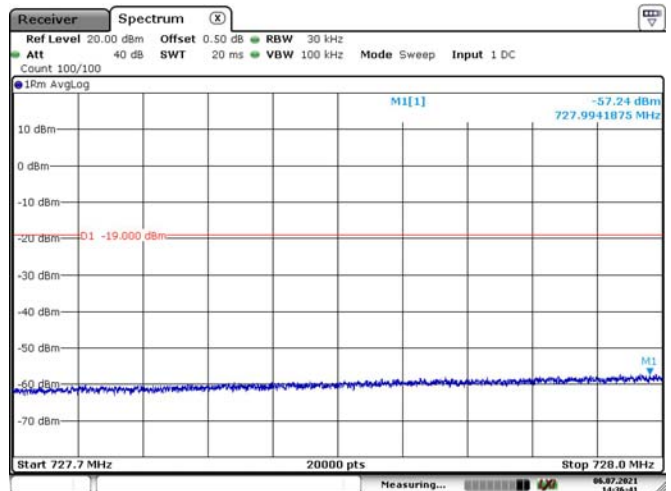

Date: 6.JUL.2021 14:36:42

Left Side-WCDMA-Pre AGC

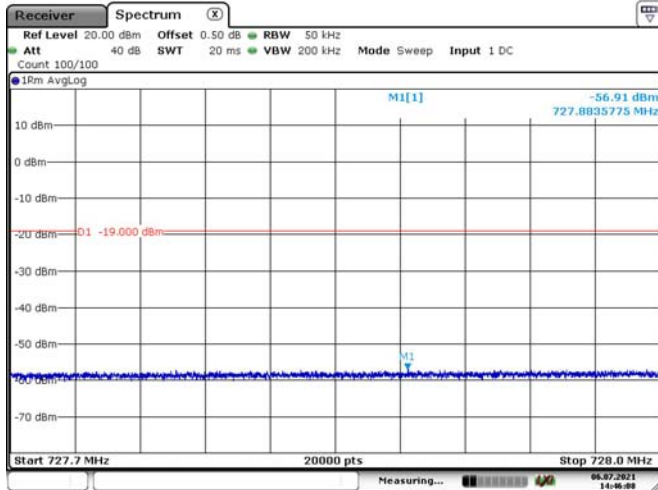

Date: 6.JUL.2021 14:46:09

Left Side-WCDMA-Above AGC

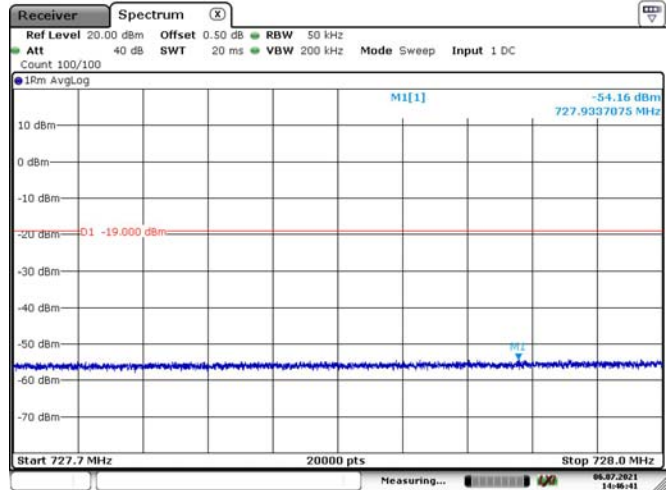

Date: 6.JUL.2021 14:46:41

Right Side-GSM-Pre AGC

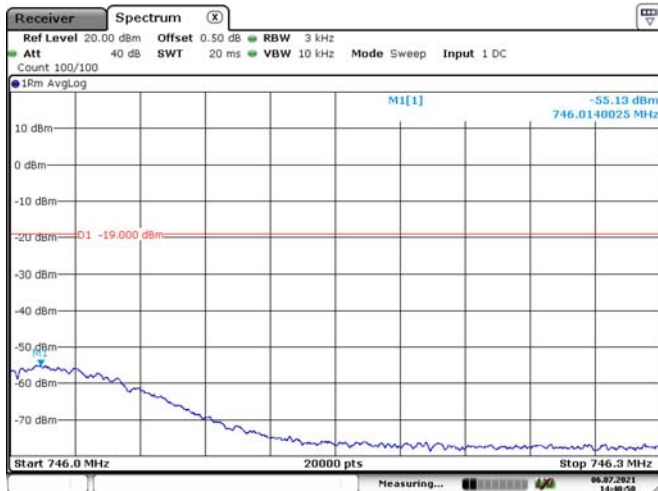

Date: 6.JUL.2021 14:40:50

Right Side-GSM-Above AGC

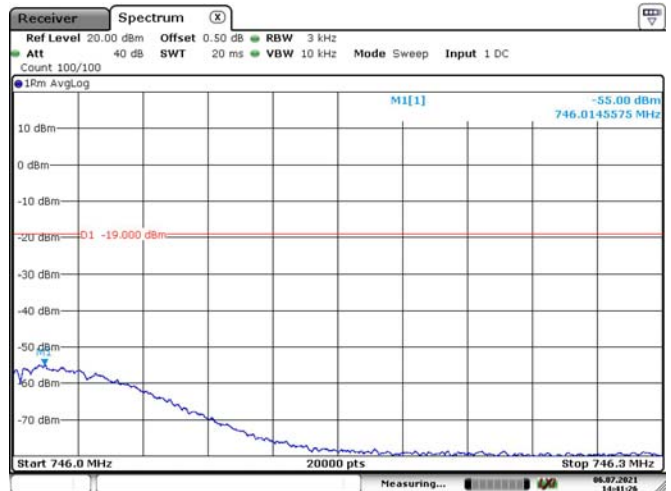

Date: 6.JUL.2021 14:41:26

Right Side-CDMA-Pre AGC

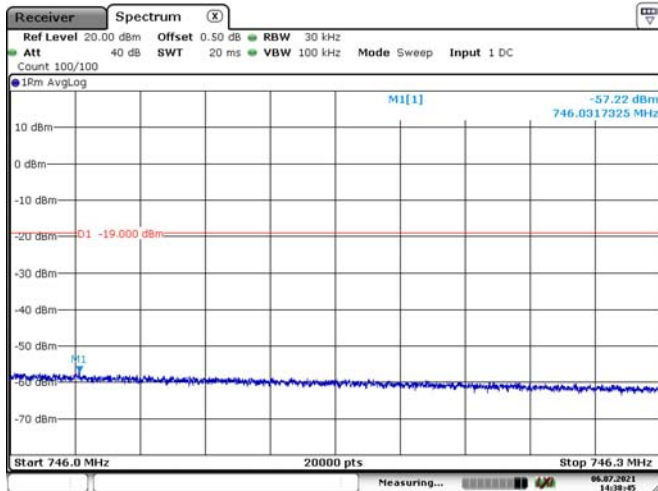

Date: 6.JUL.2021 14:38:45

Right Side-CDMA-Above AGC

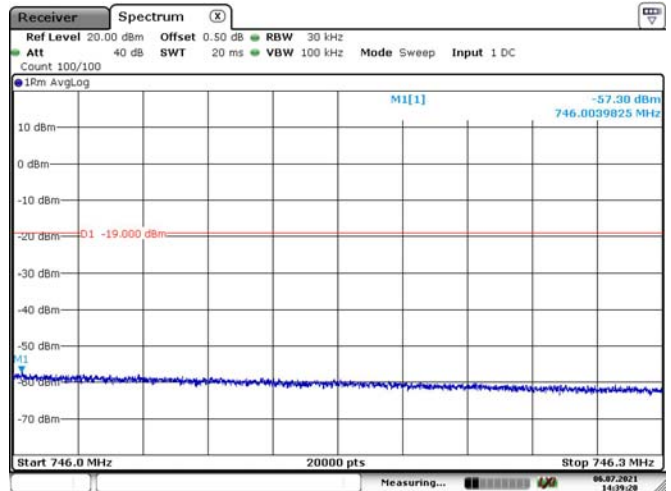

Date: 6.JUL.2021 14:39:21

Right Side-WCDMA-Pre AGC

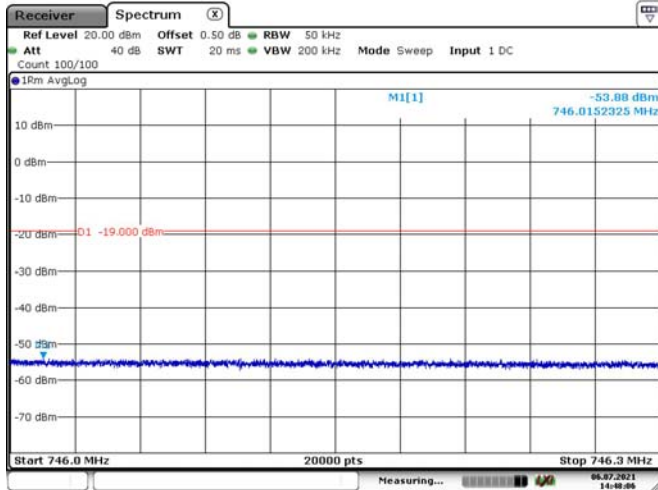

Date: 6.JUL.2021 14:48:06

Right Side-WCDMA-Above AGC

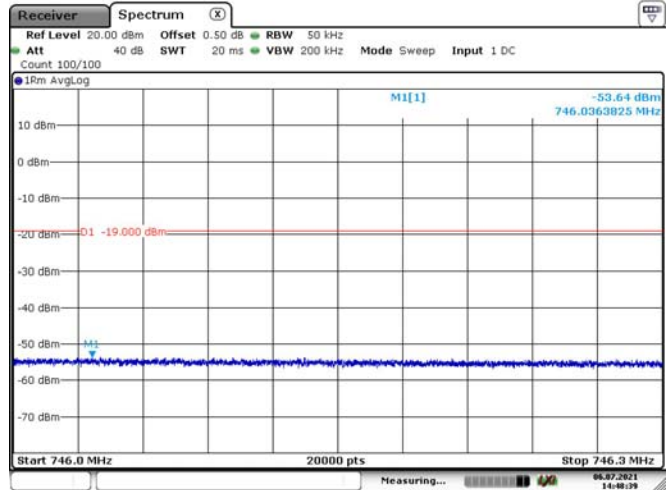

Date: 6.JUL.2021 14:48:39

Upper 700M Band Downlink

Left Side-GSM-Pre AGC



Date: 6.JUL.2021 16:16:07

Left Side-GSM-Above AGC

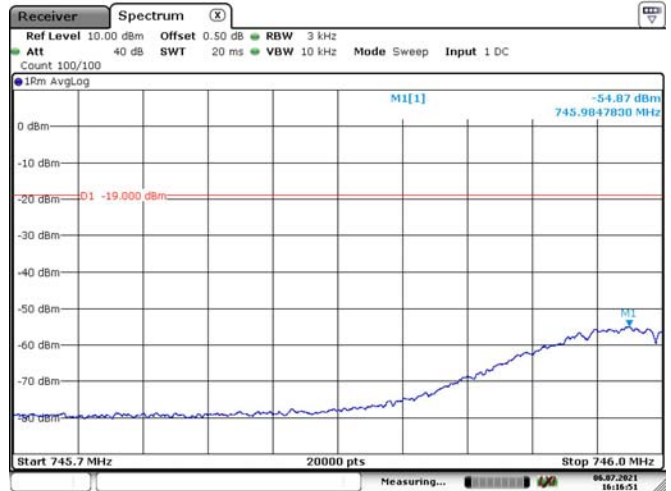

Date: 6.JUL.2021 16:16:51

Left Side-CDMA-Pre AGC

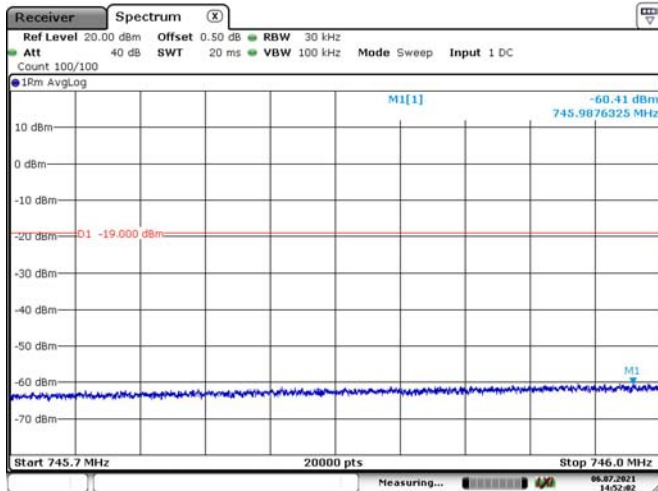

Date: 6.JUL.2021 14:52:03

Left Side-CDMA-Above AGC

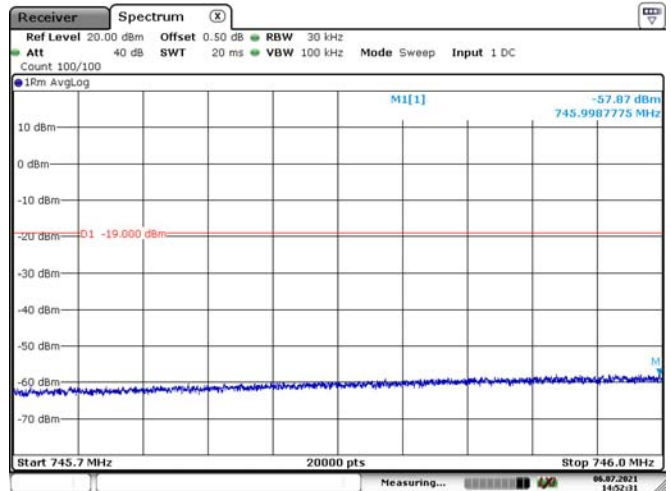

Date: 6.JUL.2021 14:52:32

Left Side-WCDMA-Pre AGC

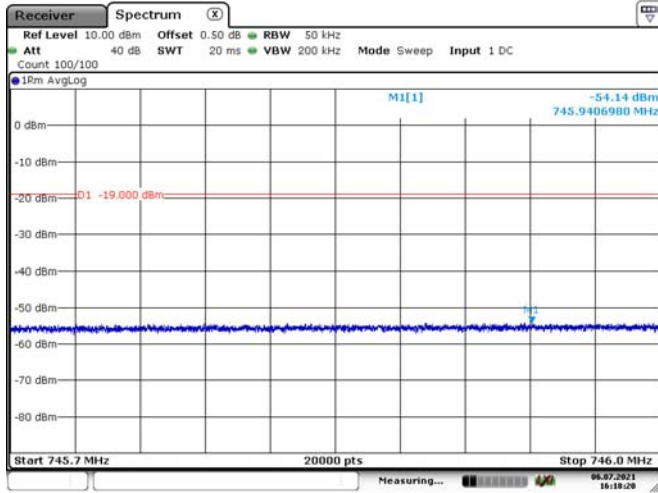

Left Side-WCDMA-Above AGC

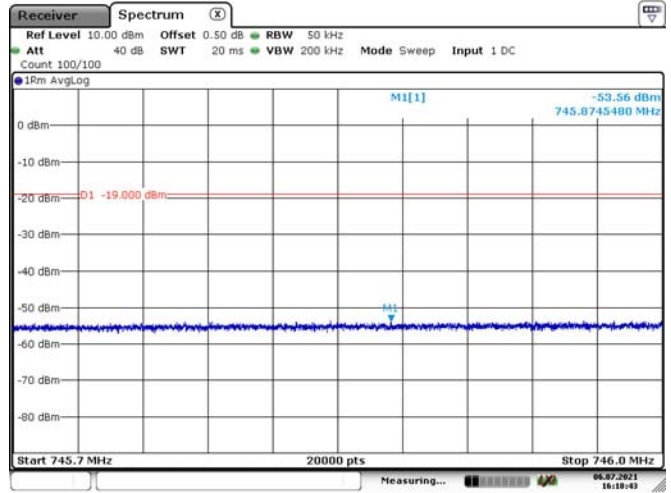

Right Side-GSM-Pre AGC



Right Side-GSM-Above AGC

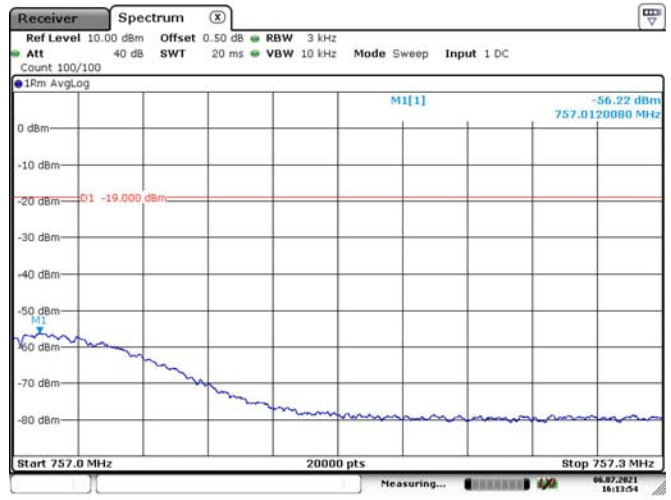

Right Side-CDMA-Pre AGC

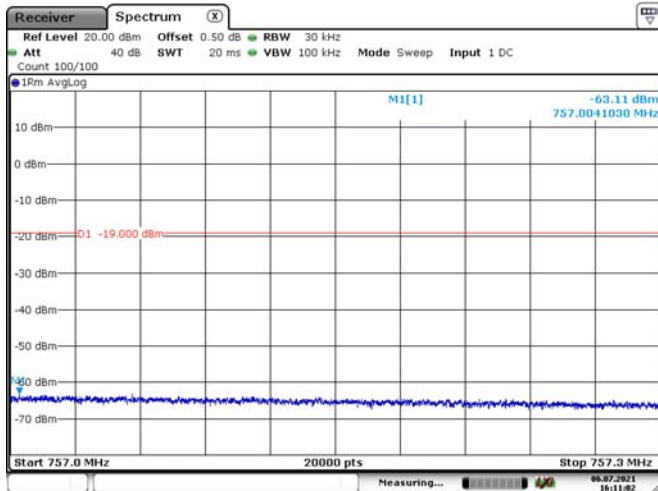

Right Side-CDMA-Above AGC

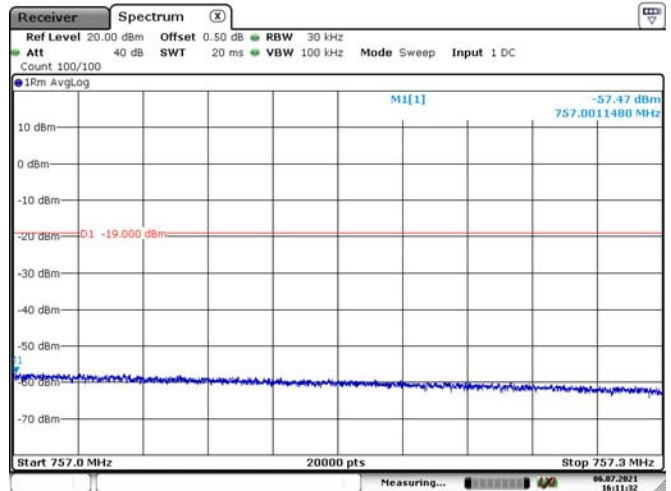

Right Side-WCDMA-Pre AGC

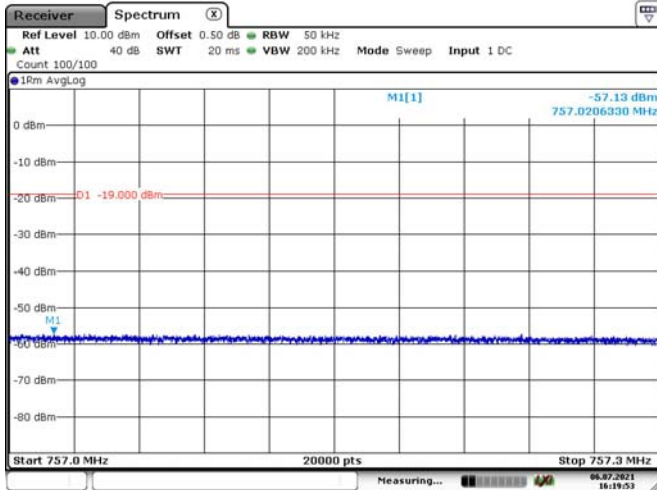

Date: 6.JUL.2021 16:19:53

Right Side-WCDMA-Above AGC

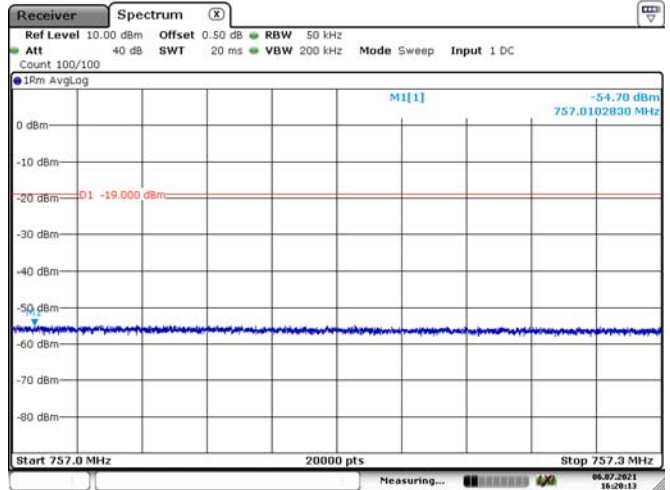

Date: 6.JUL.2021 16:20:13

Cellular Band Downlink

Left Side-GSM-Pre AGC



Date: 6.JUL.2021 16:40:37

Left Side-GSM-Above AGC



Date: 6.JUL.2021 16:41:17

Left Side-CDMA-Pre AGC

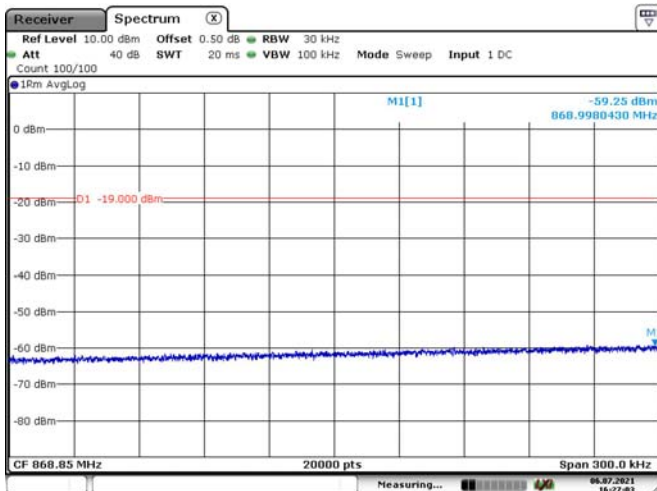

Date: 6.JUL.2021 16:27:04

Left Side-CDMA-Above AGC

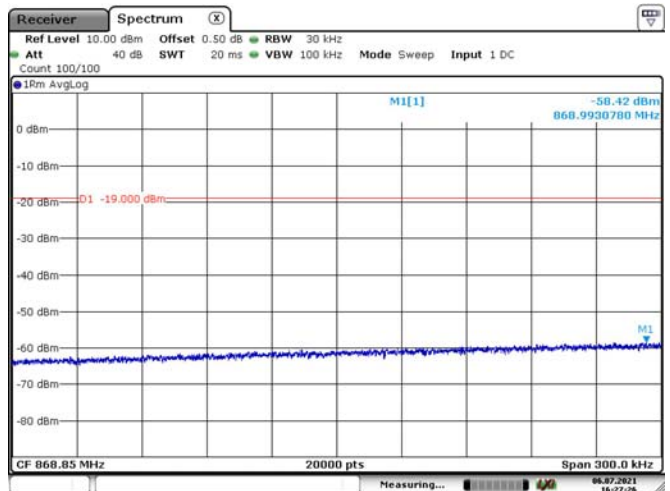

Date: 6.JUL.2021 16:27:27

Left Side-WCDMA-Pre AGC

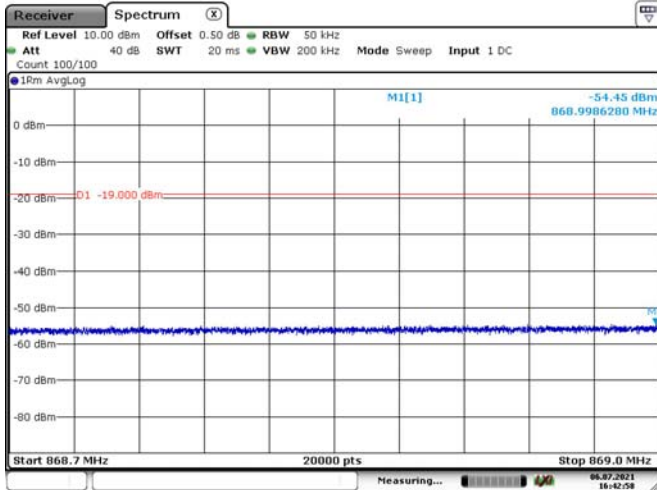

Date: 6.JUL.2021 16:42:59

Left Side-WCDMA-Above AGC

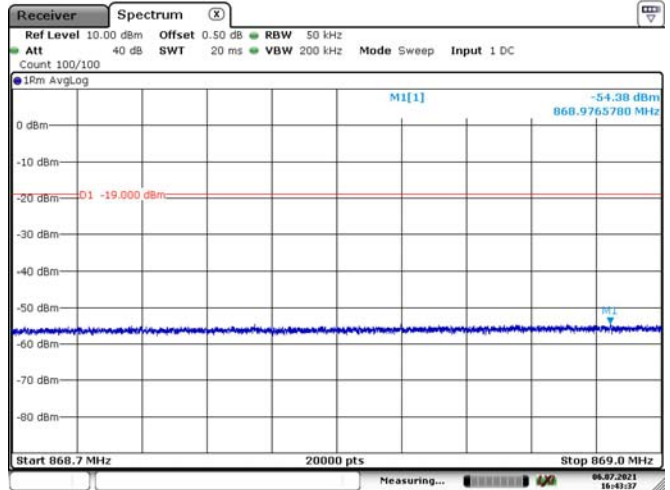

Date: 6.JUL.2021 16:43:37

Right Side-GSM-Pre AGC

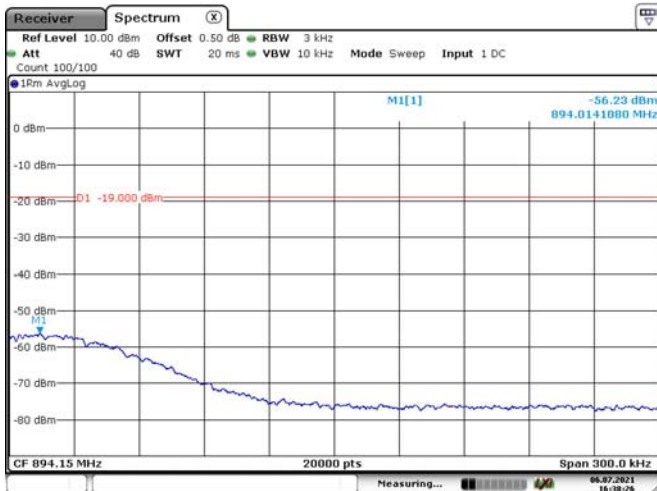

Date: 6.JUL.2021 16:38:27

Right Side-GSM-Above AGC

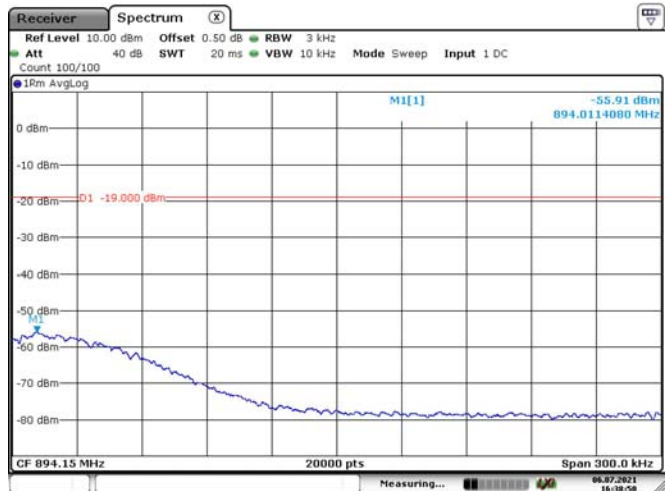

Date: 6.JUL.2021 16:38:51

Right Side-CDMA-Pre AGC

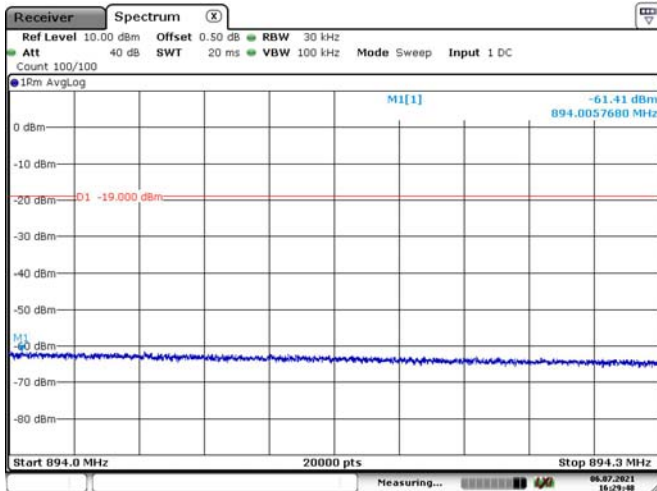

Date: 6.JUL.2021 16:29:49

Right Side-CDMA-Above AGC

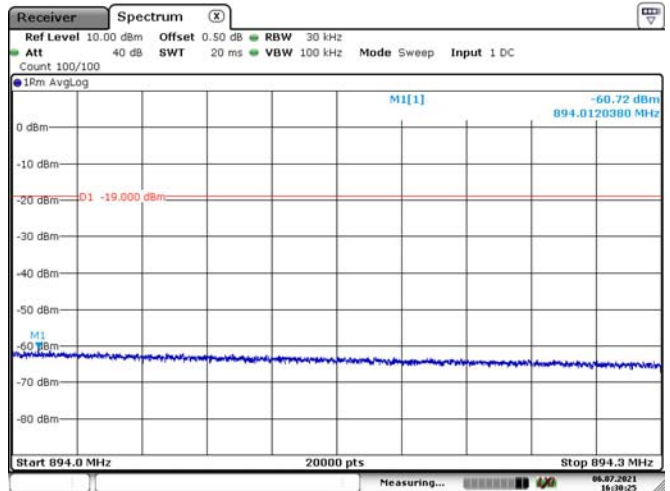

Date: 6.JUL.2021 16:30:25

Right Side-WCDMA-Pre AGC

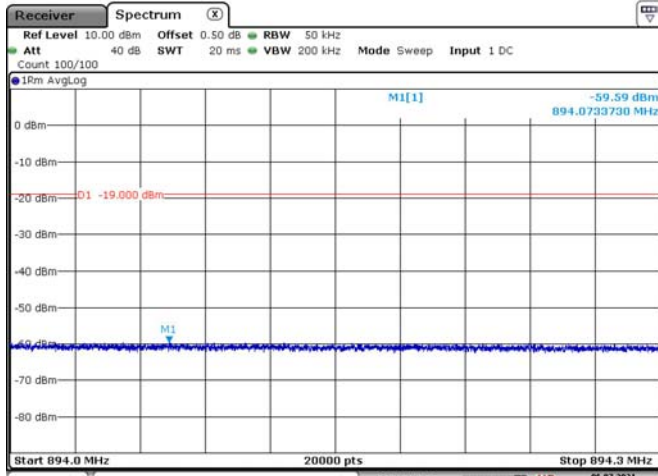

Date: 6.JUL.2021 16:44:57

Right Side-WCDMA-Above AGC

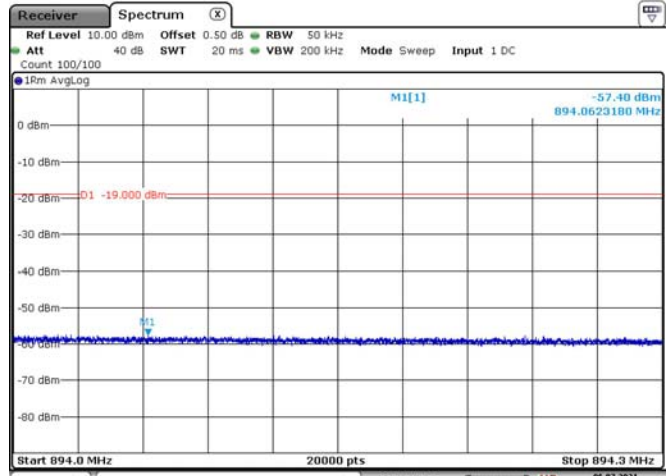

Date: 6.JUL.2021 16:45:44

AWS Band Downlink

Left Side-GSM-Pre AGC

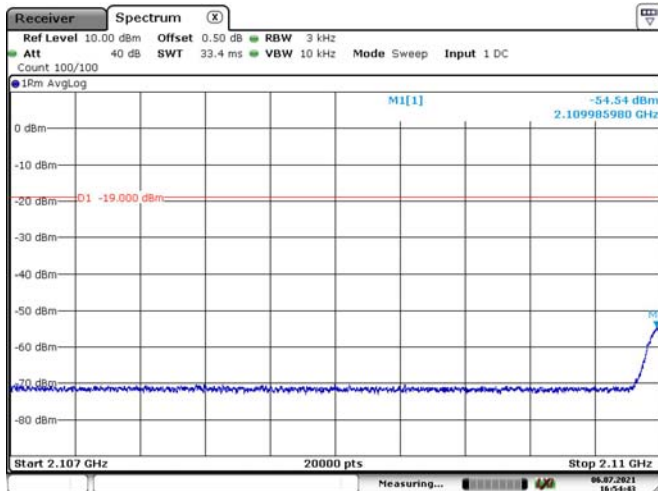

Date: 6.JUL.2021 16:54:44

Left Side-GSM-Above AGC

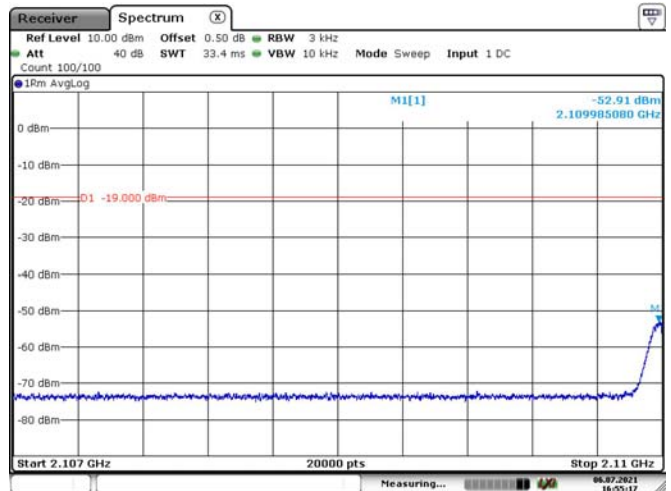

Date: 6.JUL.2021 16:55:18

Left Side-CDMA-Pre AGC

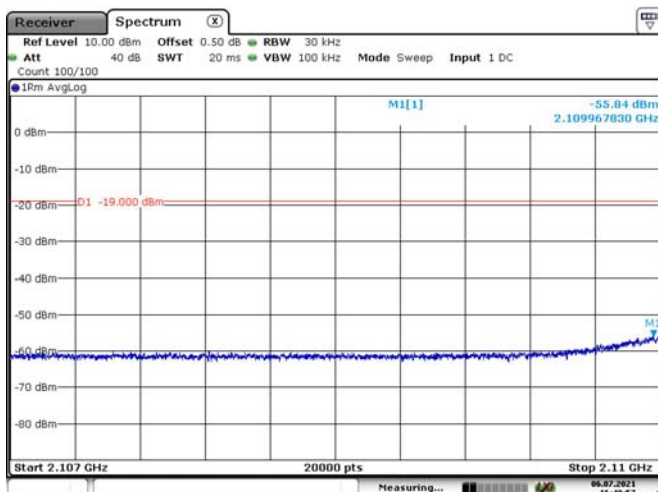

Date: 6.JUL.2021 16:48:58

Left Side-CDMA-Above AGC

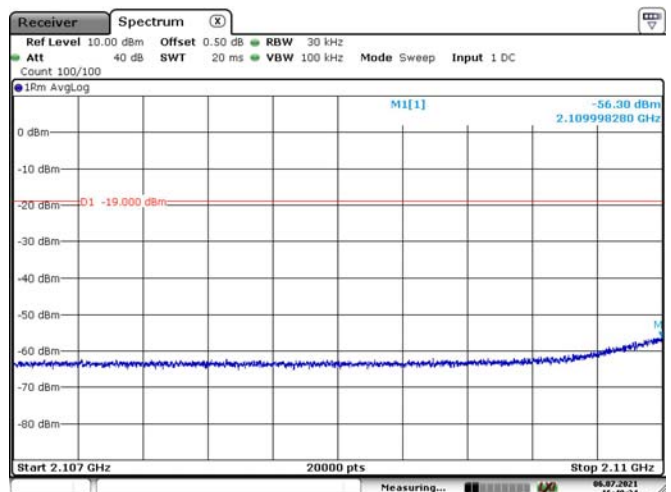

Date: 6.JUL.2021 16:49:25

Left Side-WCDMA-Pre AGC

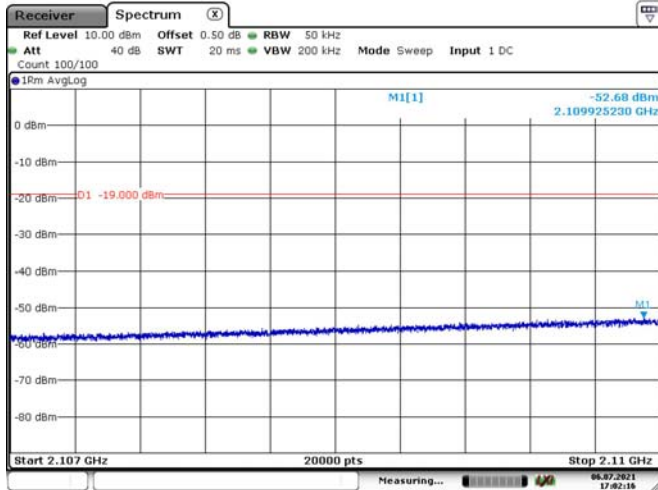

Date: 6.JUL.2021 17:02:17

Left Side-WCDMA-Above AGC

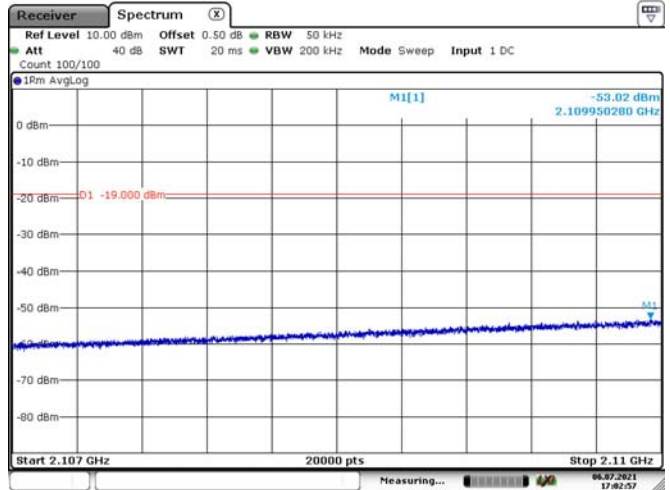

Date: 6.JUL.2021 17:02:57

Right Side-GSM-Pre AGC

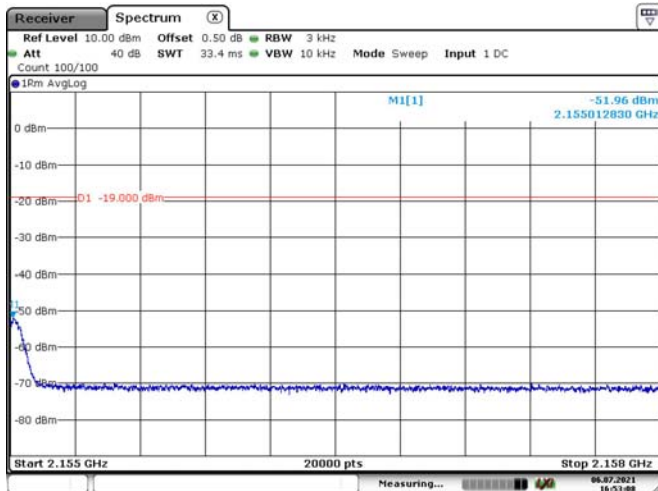

Date: 6.JUL.2021 16:53:08

Right Side-GSM-Above AGC

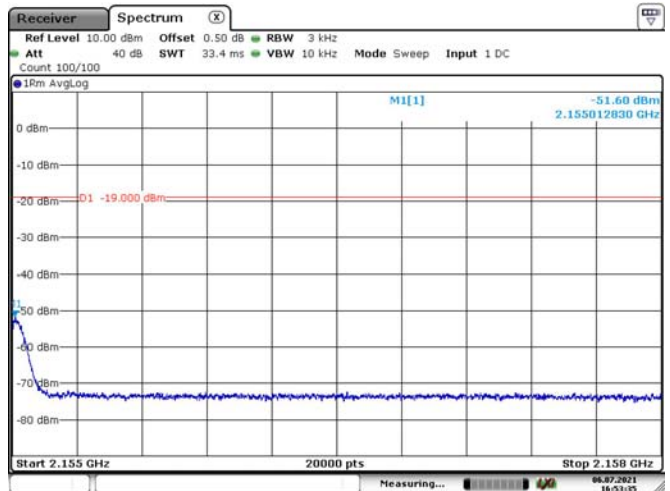

Date: 6.JUL.2021 16:53:36

Right Side-CDMA-Pre AGC

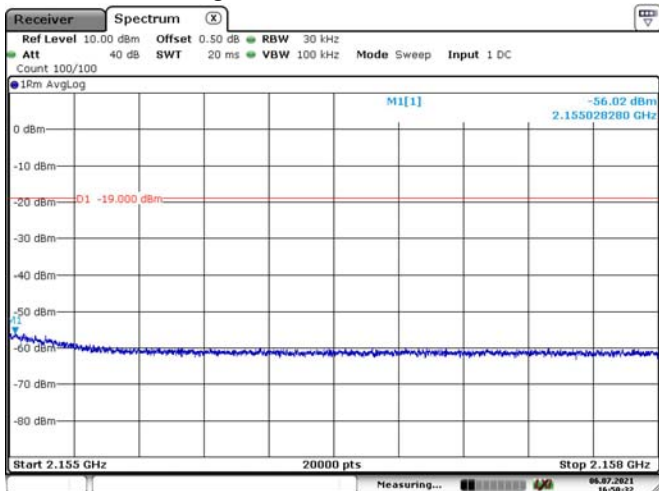

Date: 6.JUL.2021 16:50:33

Right Side-CDMA-Above AGC

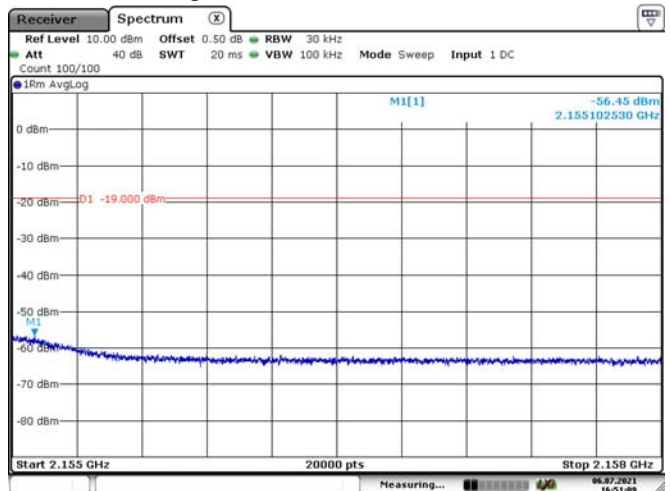

Date: 6.JUL.2021 16:51:09