

which may require that the measurement range defined by the start and stop frequencies above be subdivided, depending on the available number of measurement points provided by the spectrum analyzer.

- 9) Use the peak marker function to identify the highest amplitude level over each of the measured frequency ranges. Record the frequency and amplitude and capture a plot for inclusion in the test report.
- e) Repeat 7.6b) through 7.6d) for each supported frequency band of operation.

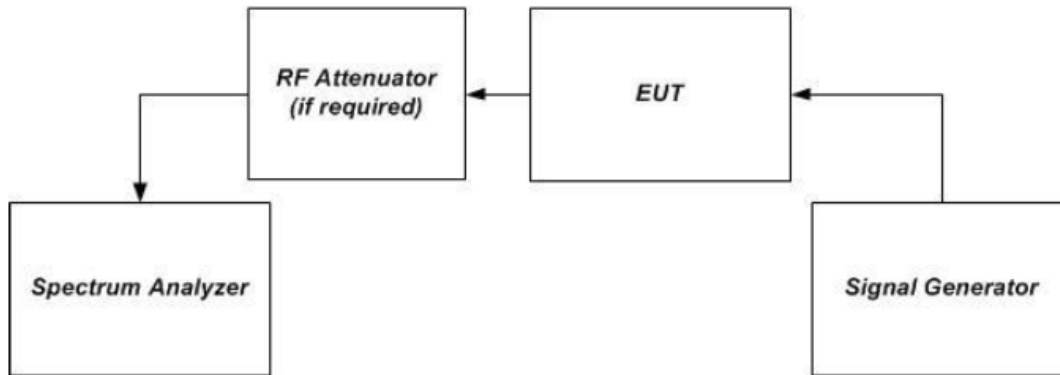
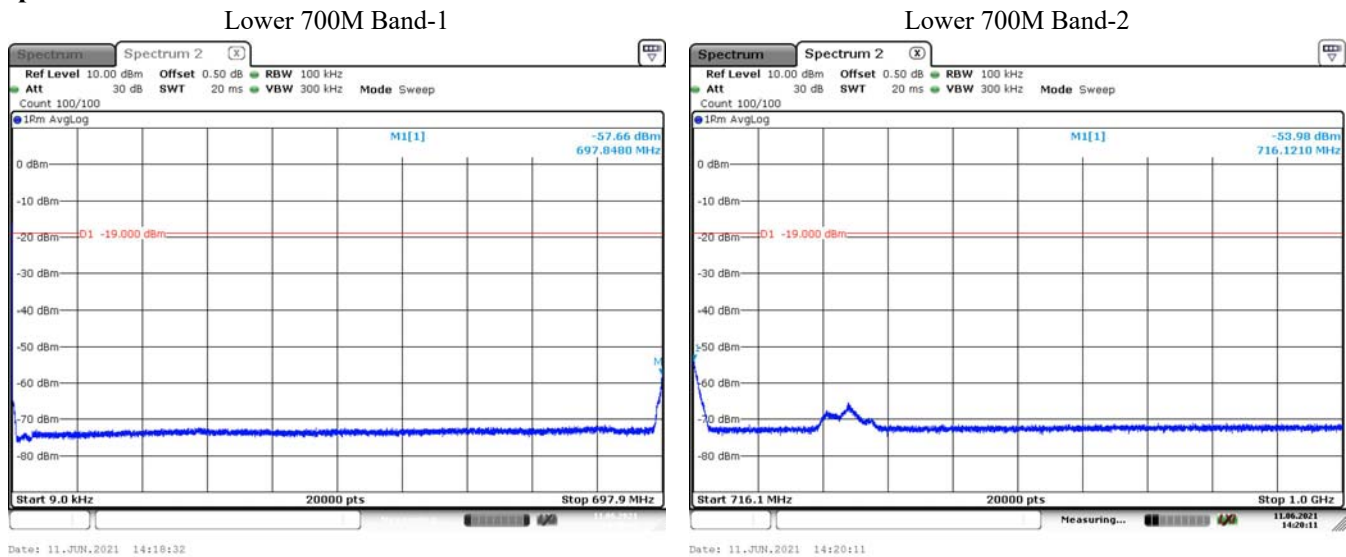

Figure 1 – Band verification test instrumentation setup

Test Data

Test Result: Compliance. Please refer to following plots.

Uplink



Lower 700M Band-3

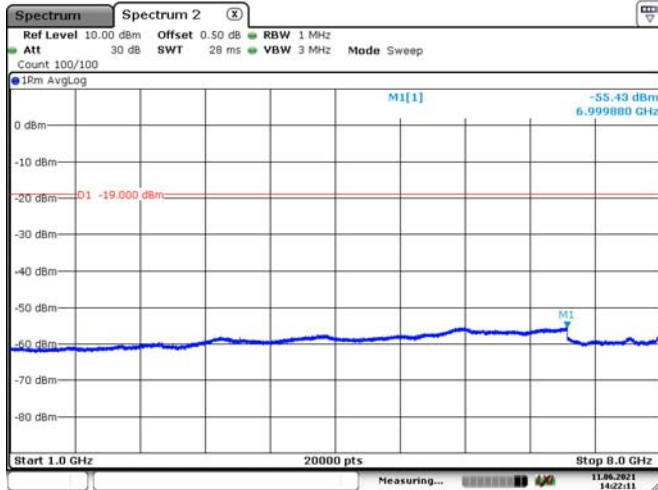

Date: 11.JUN.2021 14:22:12

Upper 700M Band-1

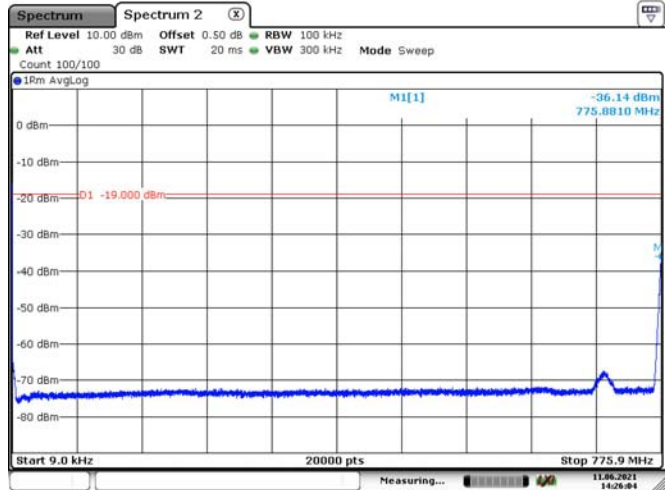

Date: 11.JUN.2021 14:26:05

Upper 700M Band-2

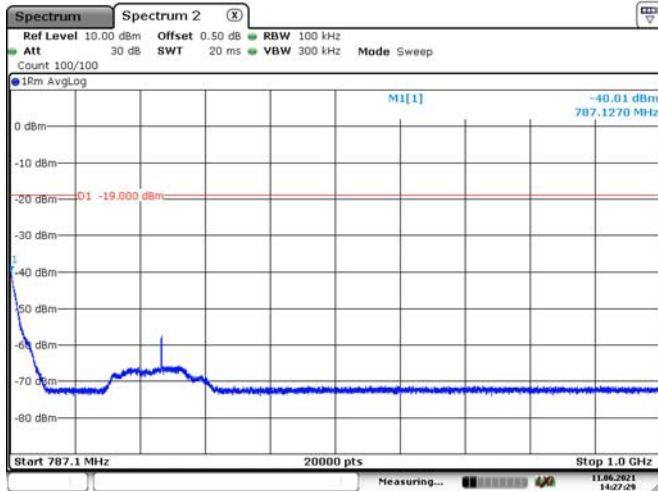

Date: 11.JUN.2021 14:27:29

Upper 700M Band-3

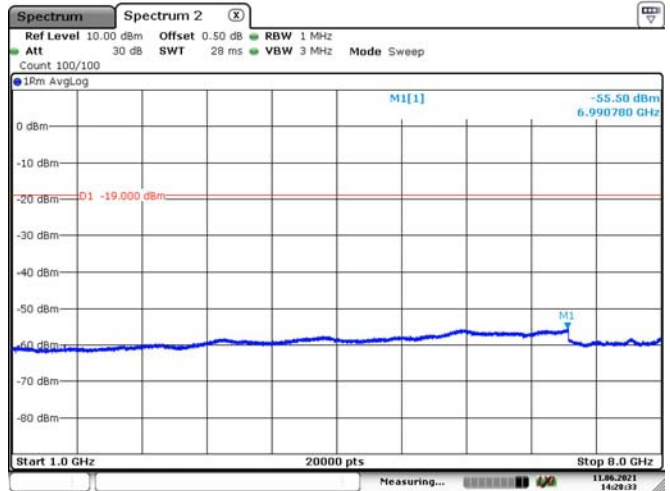

Date: 11.JUN.2021 14:28:33

Upper 700M Band-4

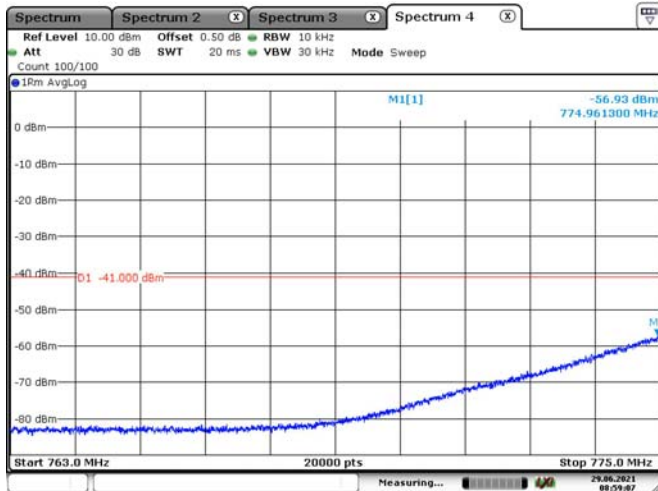

Date: 29.JUN.2021 08:59:07

Upper 700M Band-5

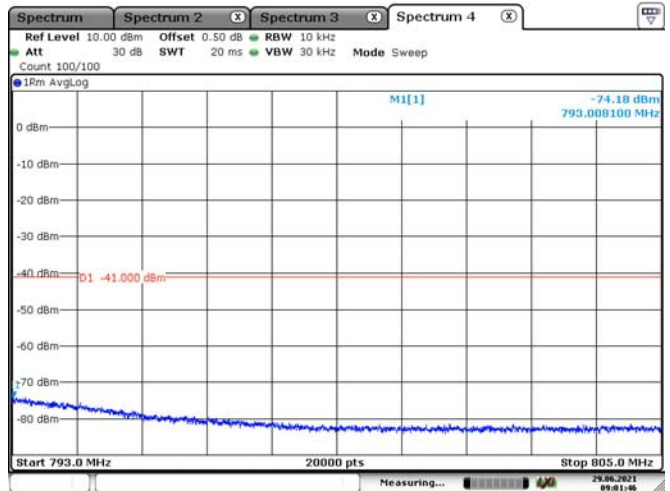

Date: 29.JUN.2021 09:01:46

Upper 700M Band-6

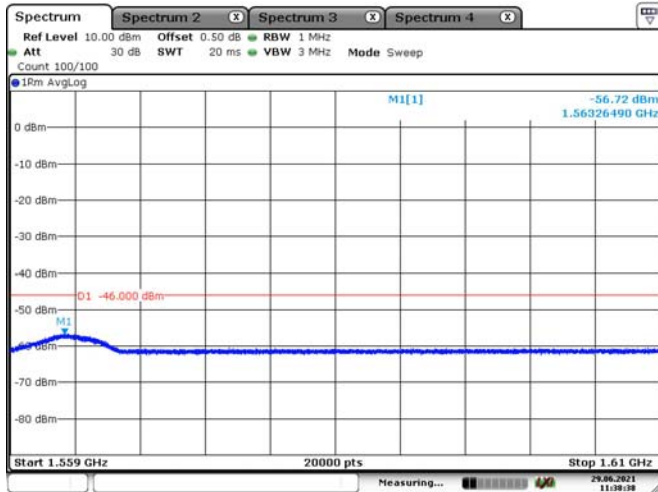

Date: 29 JUN 2021 11:38:39

Cellular Band-1

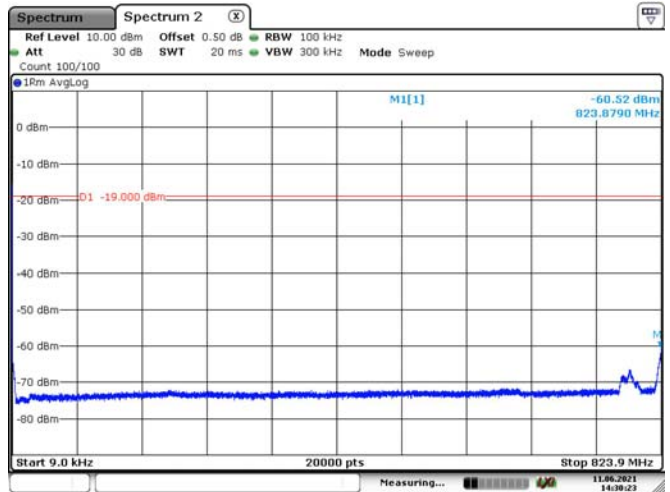

Date: 11 JUN 2021 14:30:24

Cellular Band-2

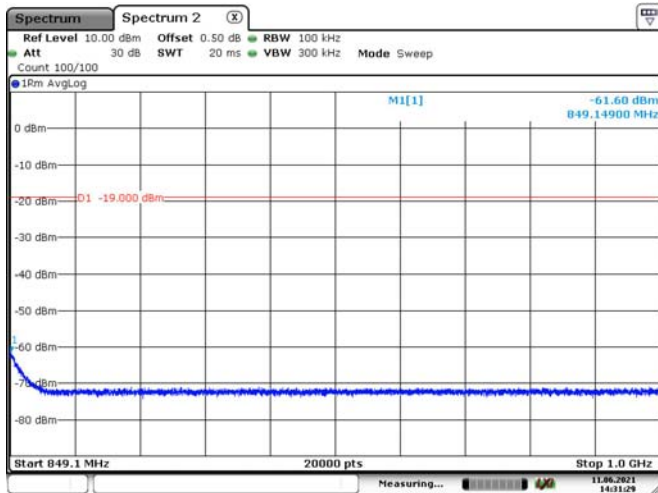

Date: 11 JUN 2021 14:31:29

Cellular Band-3

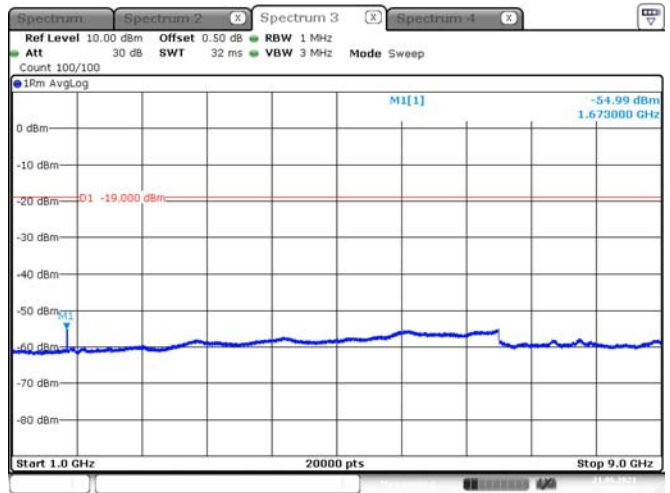

Date: 21 JUN 2021 05:01:57

AWS Band-1

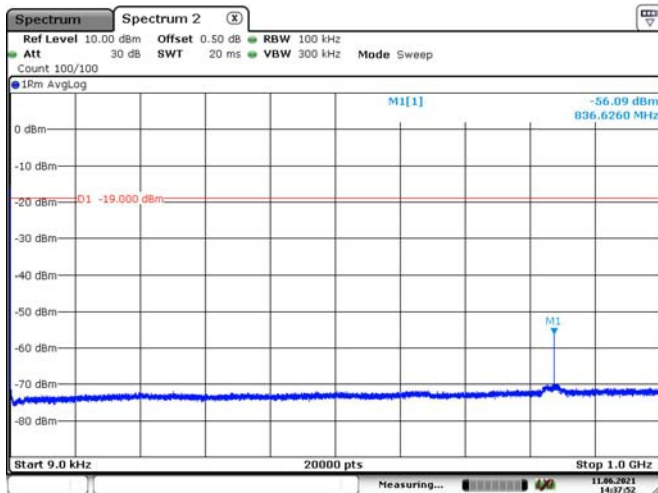

Date: 11 JUN 2021 14:37:52

AWS Band-2

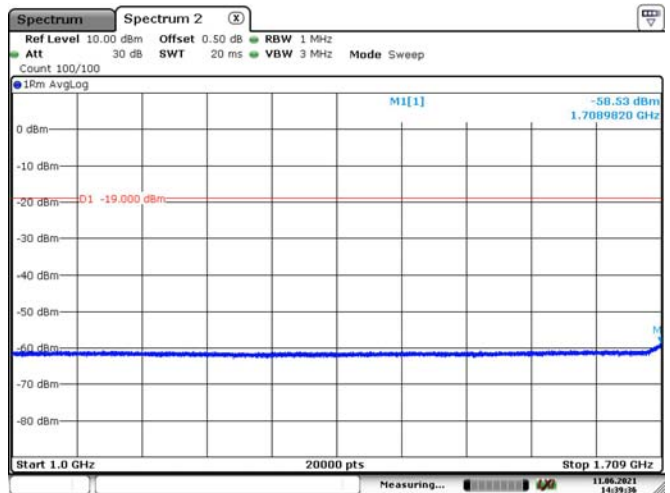

Date: 11 JUN 2021 14:39:37

AWS Band-3

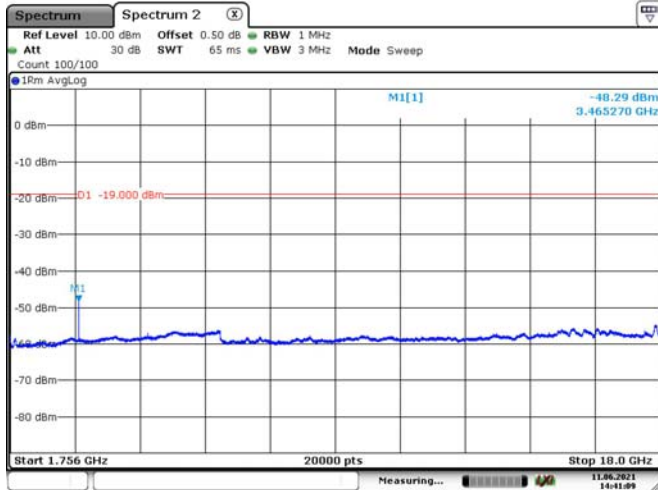

Date: 11 JUN 2021 14:41:10

PCS Band-1

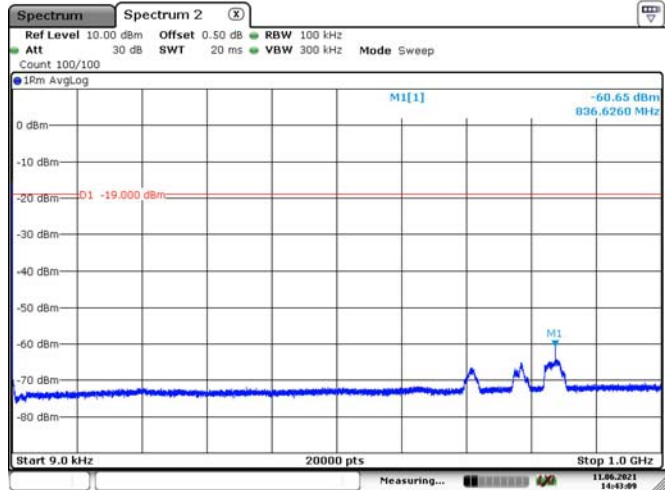

Date: 11 JUN 2021 14:43:09

PCS Band-2

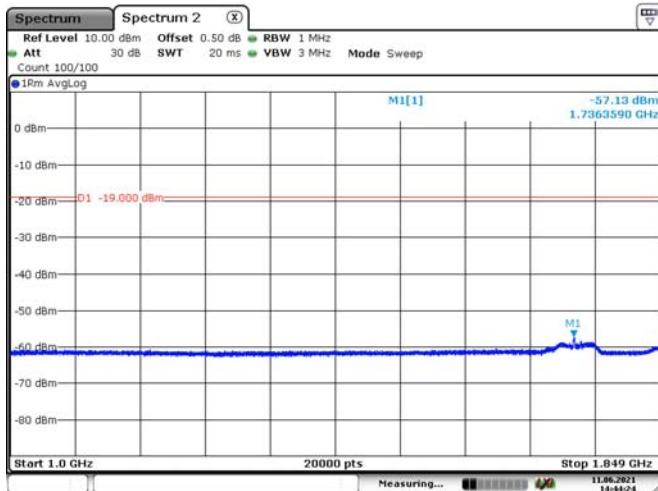

Date: 11 JUN 2021 14:44:25

PCS Band-3

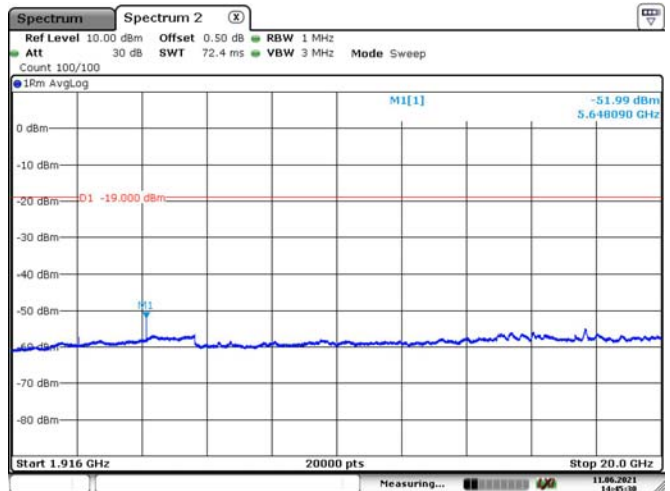

Date: 11 JUN 2021 14:45:30

Downlink

Lower 700M Band-1

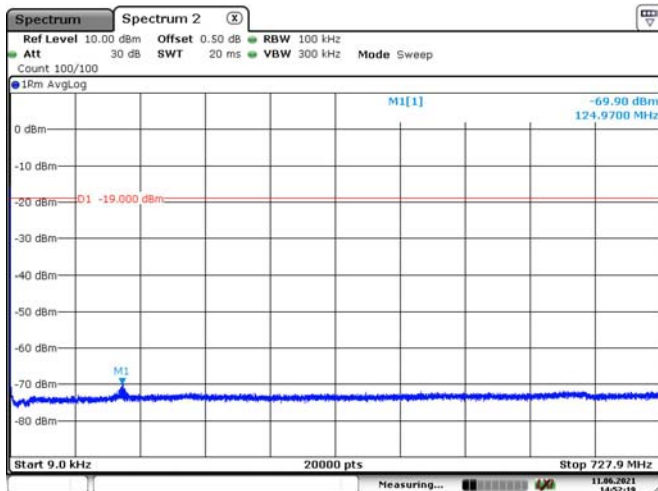

Date: 11 JUN 2021 14:52:19

Lower 700M Band-2

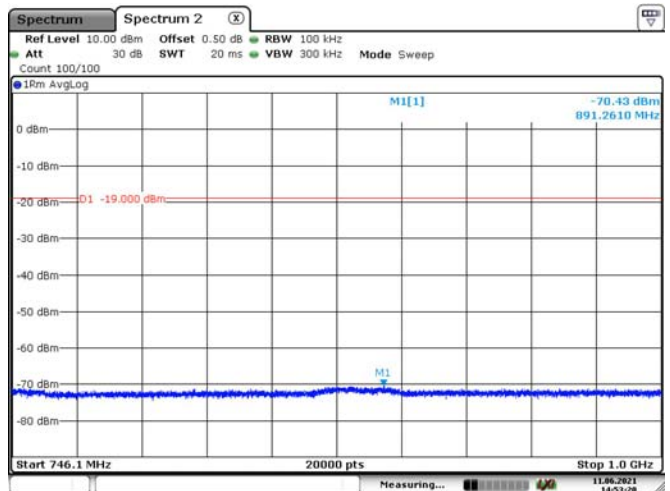

Date: 11 JUN 2021 14:53:20

Lower 700M Band-3

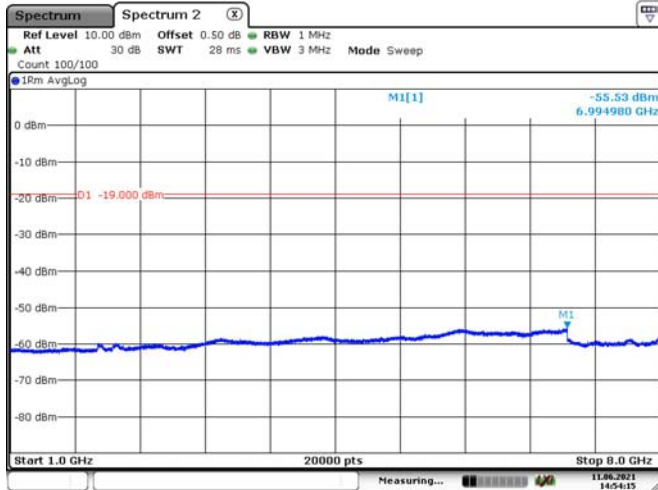

Date: 11.JUN.2021 14:54:16

Upper 700M Band-1

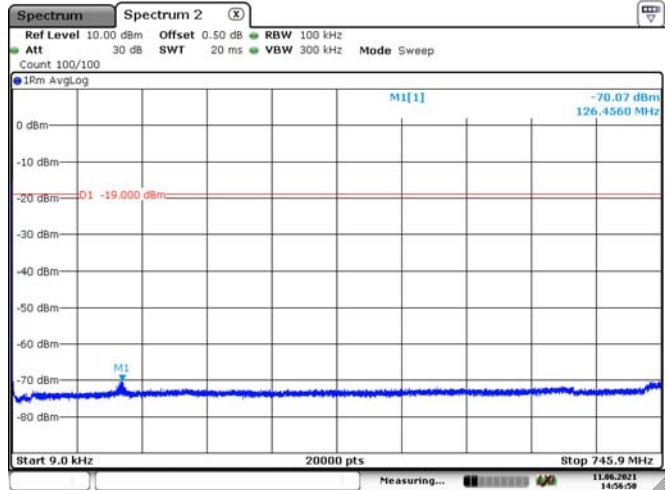

Date: 11.JUN.2021 14:56:50

Upper 700M Band-2

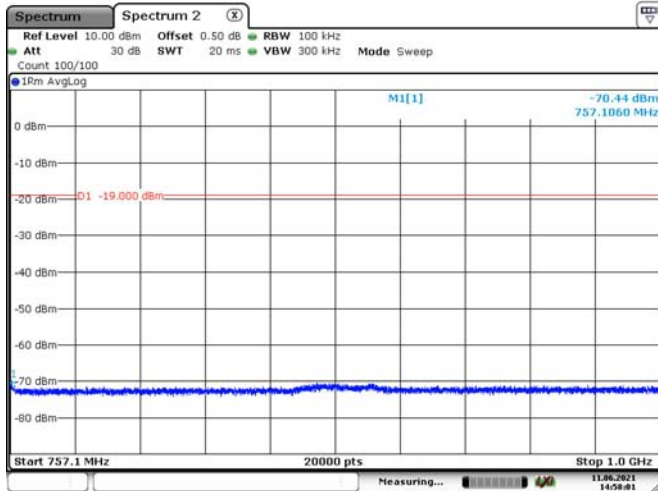

Date: 11.JUN.2021 14:58:01

Upper 700M Band-3

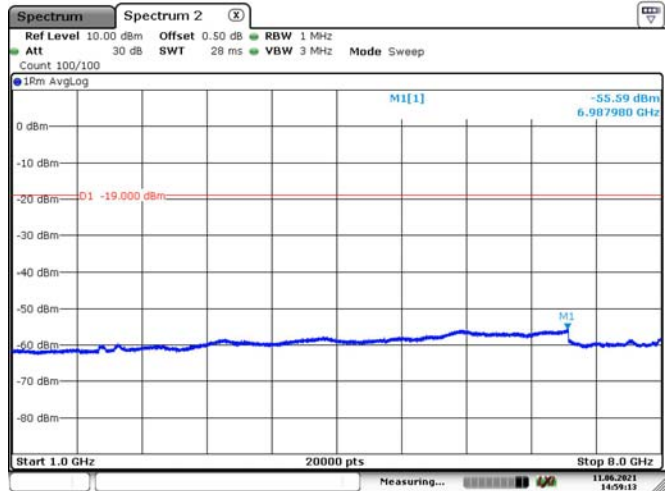

Date: 11.JUN.2021 14:59:13

Upper 700M Band-4

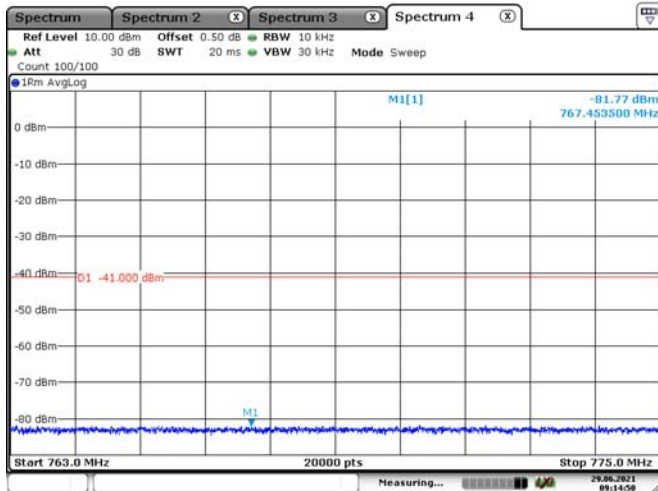

Date: 29.JUN.2021 09:14:51

Upper 700M Band-5

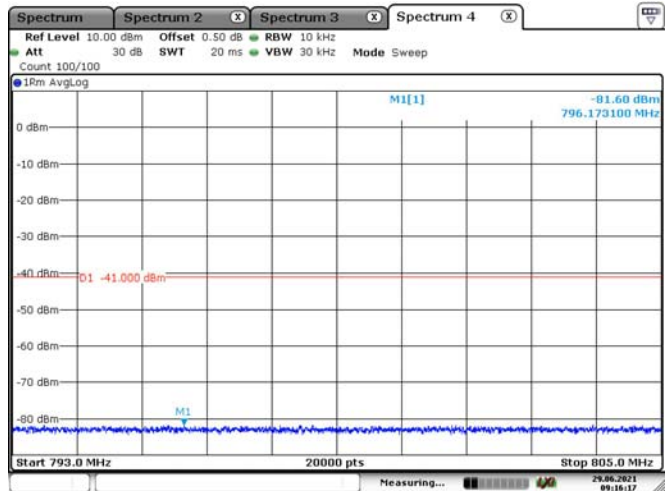

Date: 29.JUN.2021 09:16:17

Upper 700M Band-6

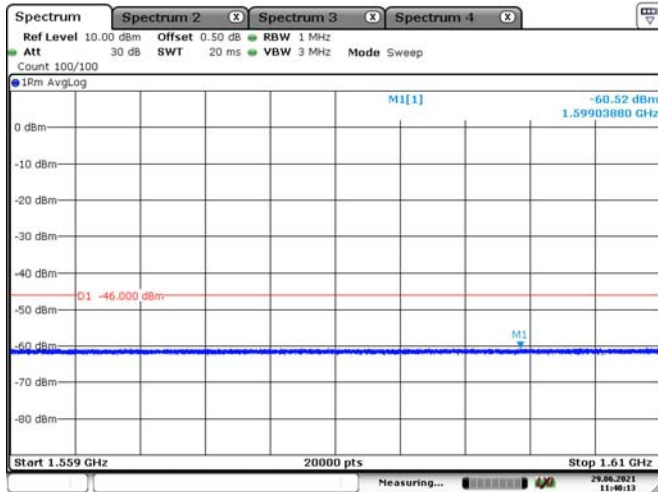

Cellular Band-1

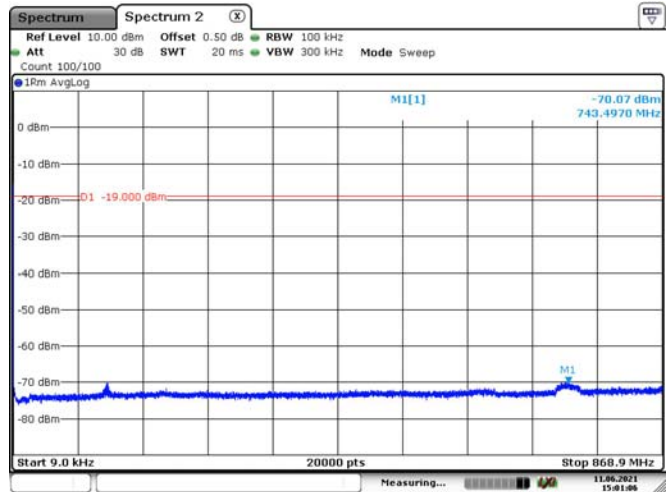

Cellular Band-2

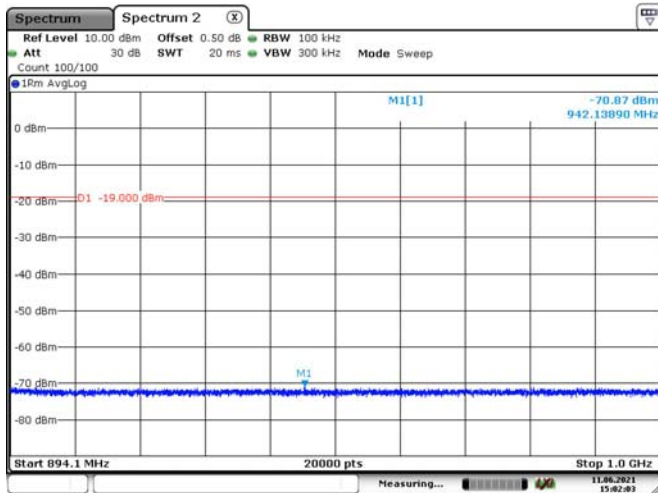

Cellular Band-3

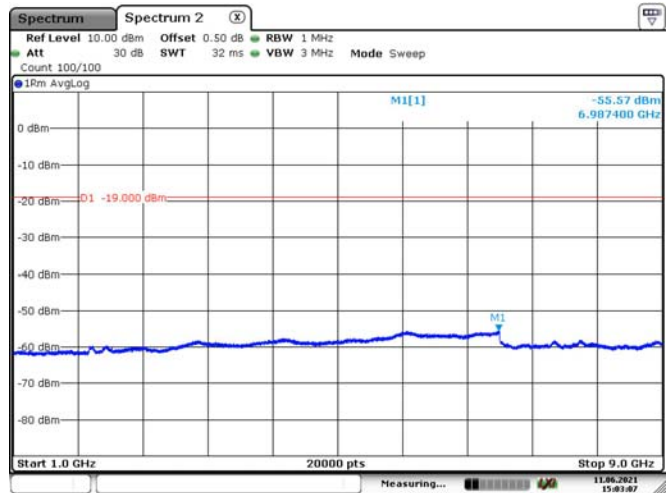

AWS Band-1

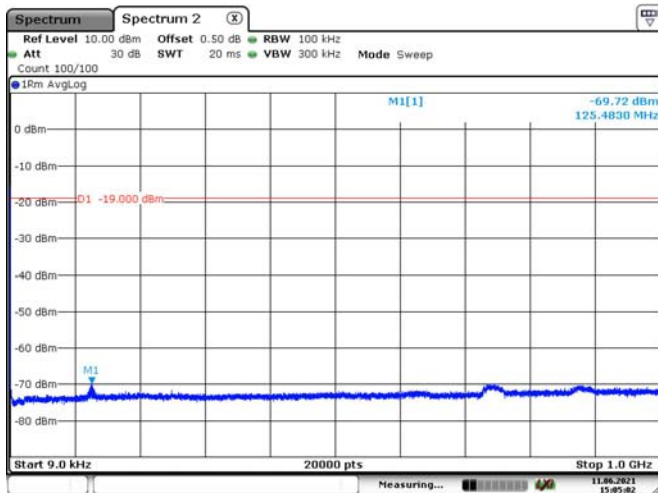

AWS Band-2

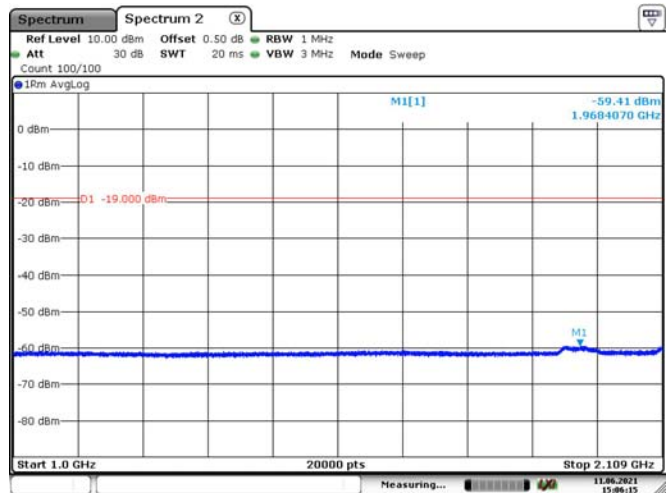

AWS Band-3

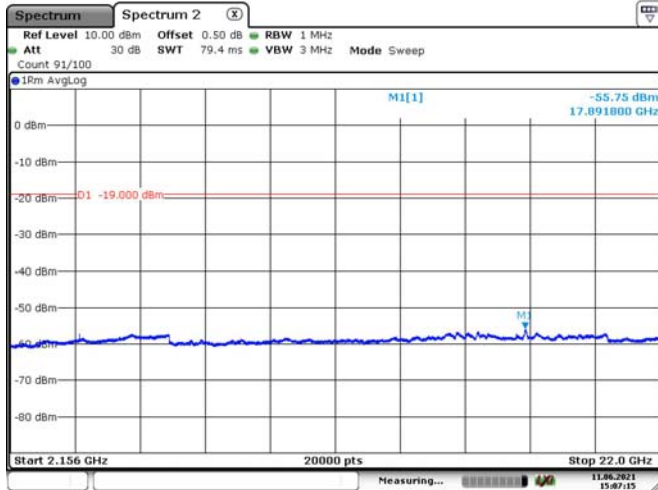

Date: 11.JUN.2021 15:07:16

PCS Band-1

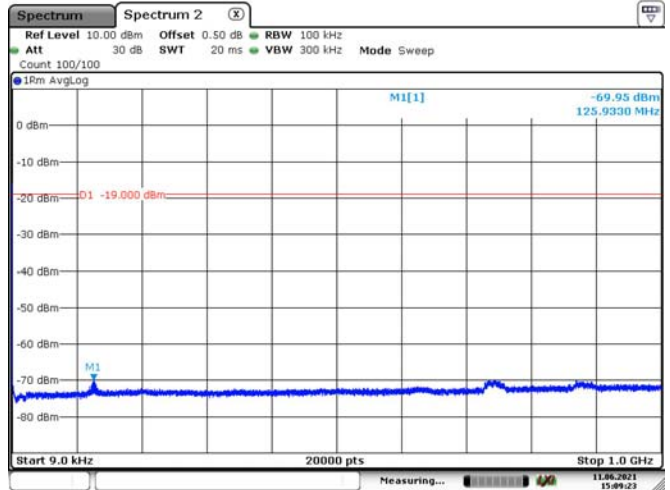

Date: 11.JUN.2021 15:09:23

PCS Band-2

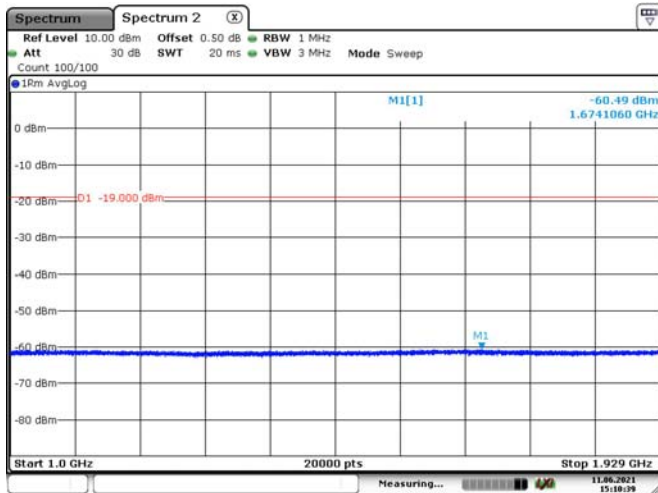

Date: 11.JUN.2021 15:10:40

PCS Band-3

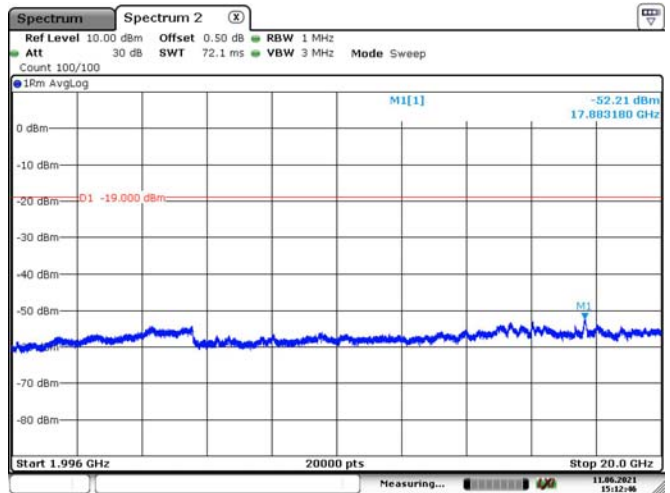

Date: 11.JUN.2021 15:12:47

7 - NOISE LIMITS

Applicable Standards

According to § 20.21(e)(8)(i)(A) *Noise Limits*; § 20.21(e)(8)(i)(H) *Transmit Power Off Mode* (uplink and downlink noise power); §20.21(e)(4) *Self-monitoring*.

Test Procedure

Maximum transmitter noise power level

- a) Connect the EUT to the test equipment as shown in **Figure 3**. Begin with the uplink output (donor) port connected to the spectrum analyzer. When measuring downlink noise, connect the downlink output (server) port to the spectrum analyzer.
- b) Set the spectrum analyzer RBW to 1 MHz with the VBW $\geq 3 * \text{RBW}$.
- c) Select the power averaging (rms) detector and trace average over at least 100 traces.
- d) Set the center frequency of the spectrum analyzer to the center of the CMRS band under test with the span ≥ 2 the CMRS band.
- e) Measure the maximum transmitter noise power level.
- f) Save the spectrum analyzer plot as necessary for inclusion in the final test report.
- g) Repeat 7.7b) to 7.7f) for all operational uplink and downlink bands.
- h) Connect the EUT to the test equipment as shown in Figure 4 for uplink noise power measurement in the presence a downlink signal. Affirm the coupled path of the RF coupler is connected to the spectrum analyzer.
- i) Configure the signal generator for AWGN operation with a 99% OBW of 4.1 MHz.
- j) Set the spectrum analyzer RBW for 1 MHz, VBW $\geq 3 * \text{RBW}$, with a power averaging (rms) detector with at least 100 trace averages.
- k) Set the center frequency of the spectrum analyzer to the center of the CMRS band under test, with the span $\geq 2 * \text{the CMRS band}$. This shall include all spectrum blocks in the particular CMRS band under test (see Appendix A).
- l) For uplink noise measurements, set the spectrum analyzer center frequency for the uplink band under test, and tune the signal generator to the center of the paired downlink band.
- m) Measure the maximum transmitter noise power level while varying the downlink signal generator output level from -90 dBm to -20 dBm , as measured at the input port (i.e., downlink signal level at the booster donor port node of Figure 4), in 1 dB steps inside the RSSI-dependent region, and in 10 dB steps outside the RSSI-dependent region. Report the six values closest to the limit, with at least two points within the RSSI-dependent region of the limit. See Appendix D for noise limits graphs.
- n) Repeat 7.7.1h) through 7.7.1m) for all operational uplink bands.

NOTE—Some signal boosters will require a signal generator input because they will not operate unless a signal is received at the input terminals. If this is the case, for the setups shown in Figure 3 and Figure 4 connect a second signal generator at the server port, then cycle the RF output of the second signal generator to simulate this function.

NOTE—Some signal boosters have a maximum transmitter noise power level that is less than the Transmit Power Off Mode of -70 dBm . For these boosters it is still necessary to confirm that the uplink noise power limits are met in the presence of a downlink signal. Test reports should show measurement data demonstrating compliance. Alternatively the applicant may provide attestation with detailed design information and explanation justifying the omission of the variable uplink testing.

Variable uplink noise timing

Variable uplink noise timing is to be measured as follows, using the test setup shown in **Figure 4**.

- a) Set the spectrum analyzer to the uplink frequency to be measured.
- b) Set the span to 0 Hz, with a sweep time of 10 seconds.
- c) Set the power level of signal generator to the lowest level of the RSSI-dependent noise [see 7.7.1m)].
- d) Select MAX HOLD and increase the power level of signal generator by 10 dB for mobile boosters, and 20 dB for fixed boosters.
- e) Confirm that the uplink noise decreases to the specified level within 1 second for mobile devices, and within 3 seconds for fixed devices.18
- f) Repeat 7.7.2a) to 7.7.2e) for all operational uplink bands.
- g) Include plots and summary table in test report.

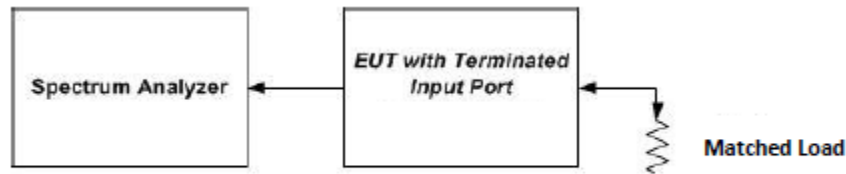

Figure 3 – Noise limit test setup (also used for 7.8)

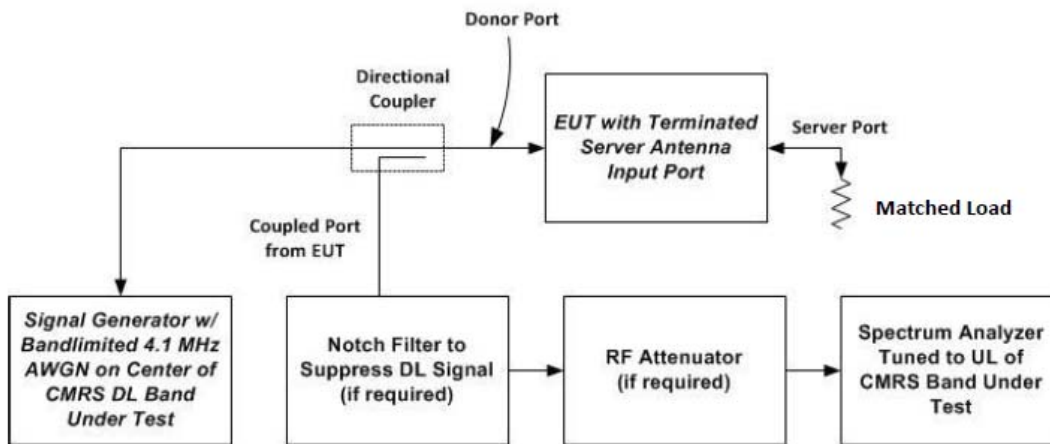

Figure 4 – Test setup for uplink noise power measurement in the presence of a downlink signal

Test Data

Test Result: Compliance. Please refer to following tables and plots.

Maximum Noise:

Mode	Operation Bands	Measured Value	Limit	Result
		dBm/MHz	dBm/MHz	
Uplink	Lower 700MHz	-64.24	-59	Compliance
	Upper 700MHz	-65.19	-59	Compliance
	Cellular	-64.25	-59	Compliance
	AWS	-69.01	-59	Compliance
	PCS	-70.44	-59	Compliance
Downlink	Lower 700MHz	-63.71	-59	Compliance
	Upper 700MHz	-66.08	-59	Compliance
	Cellular	-66.67	-59	Compliance
	AWS	-65.02	-59	Compliance
	PCS	-64.38	-59	Compliance

Note: Mobile booster maximum noise power shall not exceed -59 dBm/MHz.

Lower 700M Band-Uplink

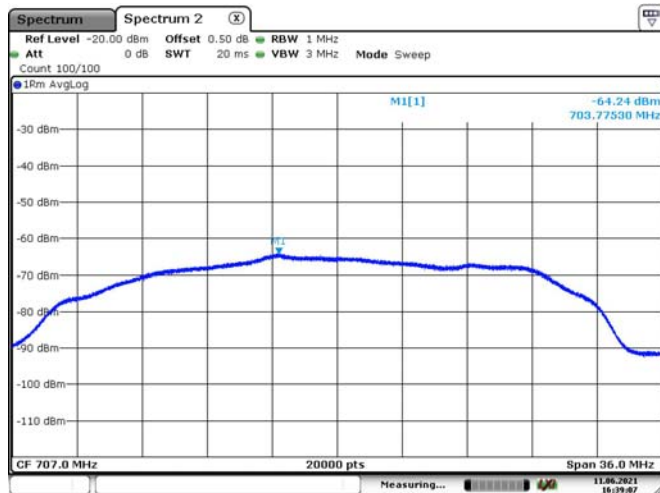

Date: 11.JUN.2021 16:39:07

Lower 700M Band-Downlink

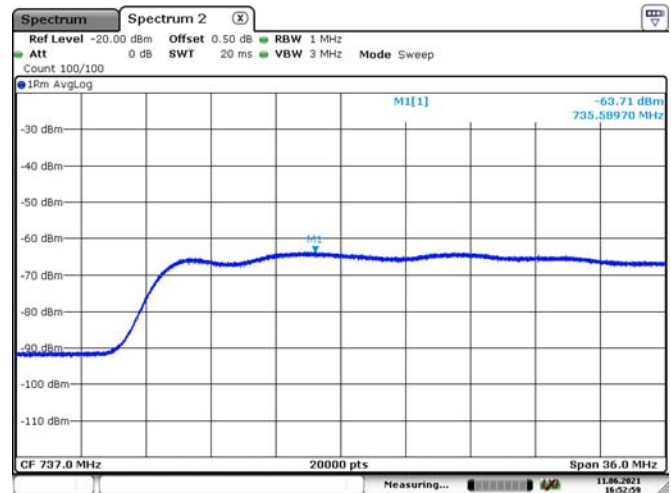

Date: 11.JUN.2021 16:52:59

Upper 700M Band-Uplink

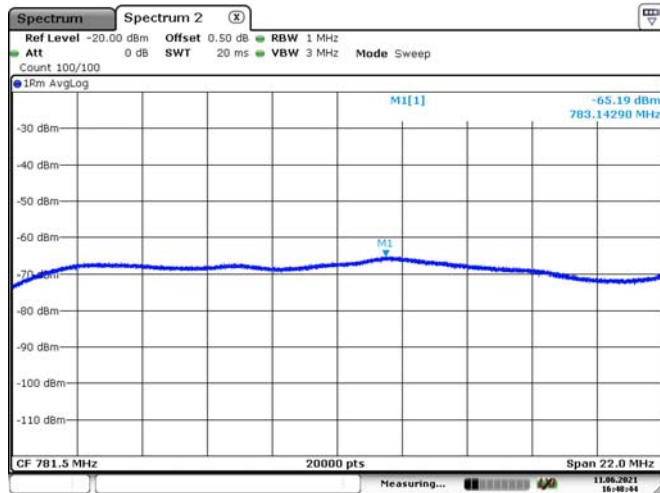

Date: 11.JUN.2021 16:48:44

Upper 700M Band-Downlink

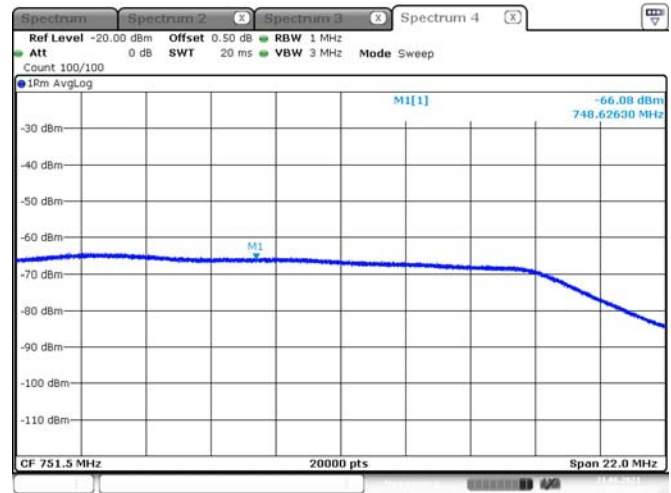

Date: 21.JUN.2021 05:11:14

Cellular Band-Uplink

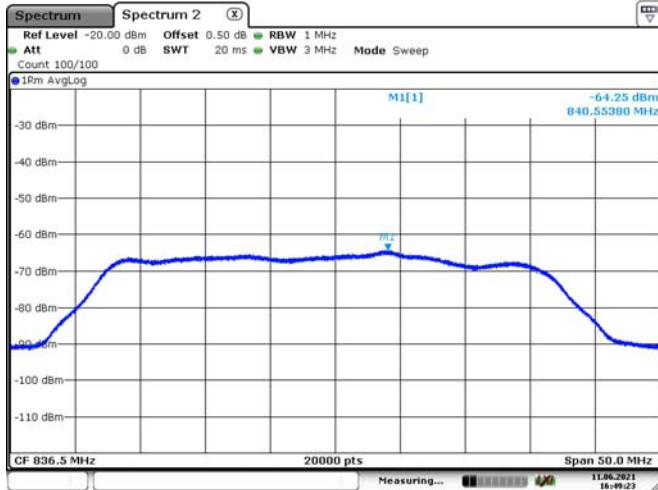

Date: 11.JUN.2021 16:49:23

Cellular Band-Downlink

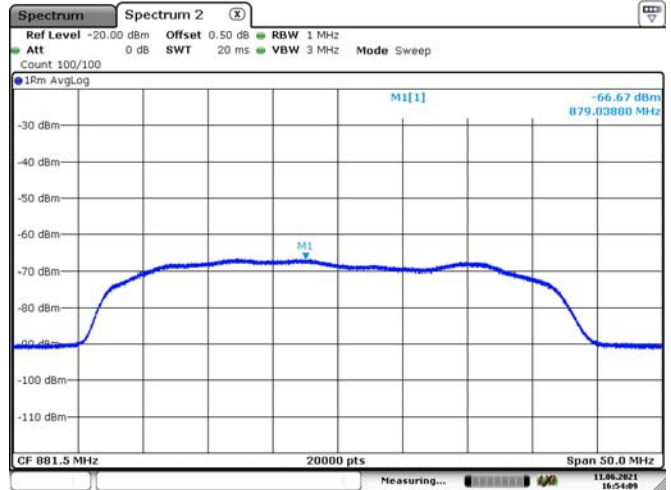

Date: 11.JUN.2021 16:54:09

AWS Band-Uplink

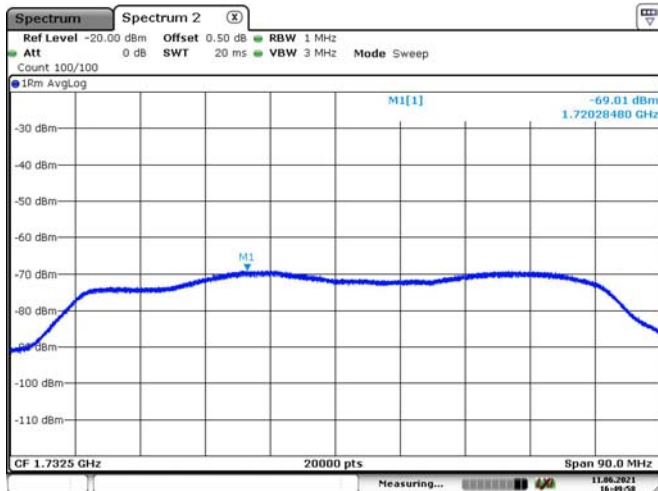

Date: 11.JUN.2021 16:49:58

AWS Band-Downlink

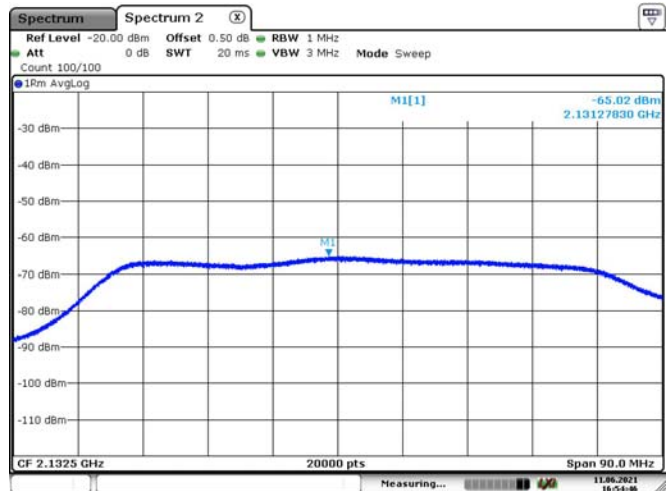

Date: 11.JUN.2021 16:54:46

PCS Band-Uplink

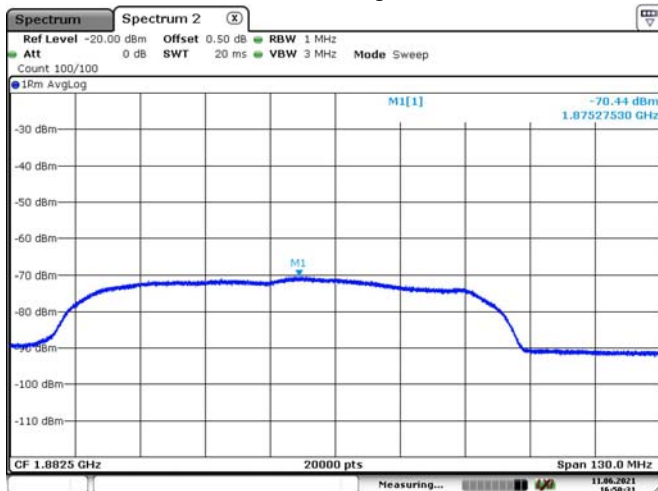

Date: 11.JUN.2021 16:50:31

PCS Band-Downlink

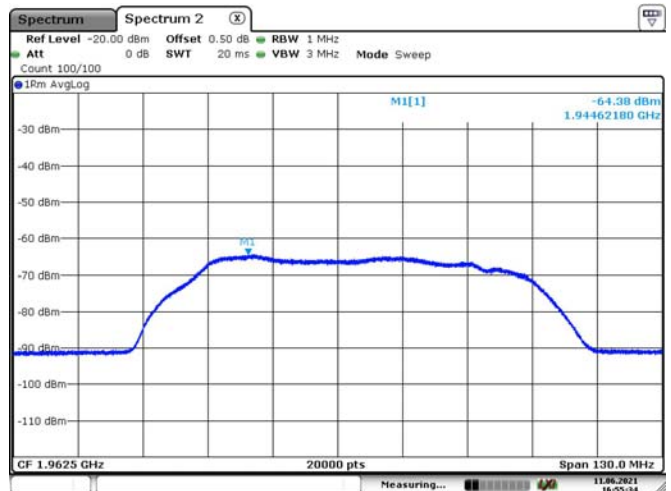

Date: 11.JUN.2021 16:55:34

Variable Uplink Noise Limit Test Result:

Operation Bands	RSSI	Measured Value	Limit	Results
	dBm	dBm/MHz	dBm/MHz	
Lower 700MHz	-90	-64.76	-59.00	Compliance
	-80	-64.73	-59.00	Compliance
	-70	-65.71	-59.00	Compliance
	-40	-64.75	-63.00	Compliance
	-34	-69.24	-69.00	Compliance
	-33	-80.12	-70.00	Compliance
Upper 700MHz	-90	-65.26	-59.00	Compliance
	-80	-65.06	-59.00	Compliance
	-70	-65.07	-59.00	Compliance
	-40	-68.12	-63.00	Compliance
	-34	-69.31	-69.00	Compliance
	-33	-80.42	-70.00	Compliance
Cellular	-90	-65.49	-59.00	Compliance
	-80	-65.67	-59.00	Compliance
	-70	-65.76	-59.00	Compliance
	-40	-67.33	-63.00	Compliance
	-34	-69.59	-69.00	Compliance
	-33	-80.23	-70.00	Compliance
AWS	-90	-69.73	-59.00	Compliance
	-80	-69.82	-59.00	Compliance
	-70	-69.71	-59.00	Compliance
	-40	-70.59	-63.00	Compliance
	-34	-71.13	-69.00	Compliance
	-33	-80.53	-70.00	Compliance
PCS	-90	-69.81	-59.00	Compliance
	-80	-69.86	-59.00	Compliance
	-70	-69.87	-59.00	Compliance
	-40	-72.21	-63.00	Compliance
	-34	-73.32	-69.00	Compliance
	-33	-80.64	-70.00	Compliance

Note:

According to KDB 935210 D03 Signal Booster Measurements v04r04 Annex D, the Variable uplink Noise limit is -103 dBm/MHz – RSSI in RSSI-Dependent Region, out of RSSI-Dependent Region, it is -59 dBm/MHz.

Variable Uplink Noise Timing:

Operating Band	Measured Value	Limit	Results
	s	s	
Lower 700MHz	0.08	1	Compliance
Upper 700MHz	0.08	1	Compliance
Cellular	0.20	1	Compliance
AWS	0.10	1	Compliance
PCS	0.12	1	Compliance

Note: The uplink noise decreases to the specified level within 1 second for mobile devices and 3 seconds for fixed devices.

Lower 700M Band

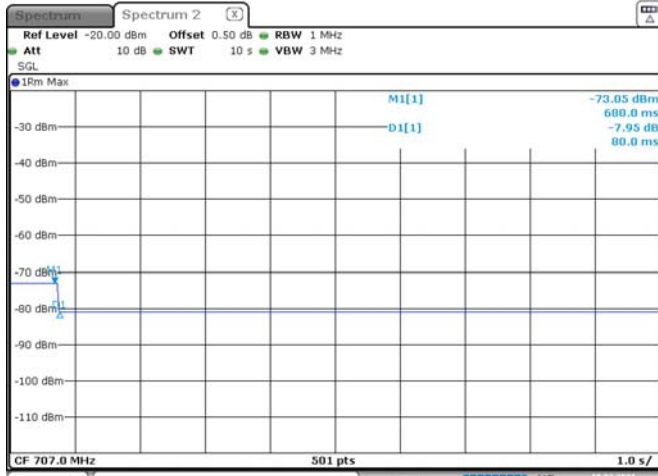

Date: 19.MAR.2021 09:29:33

Upper 700M Band

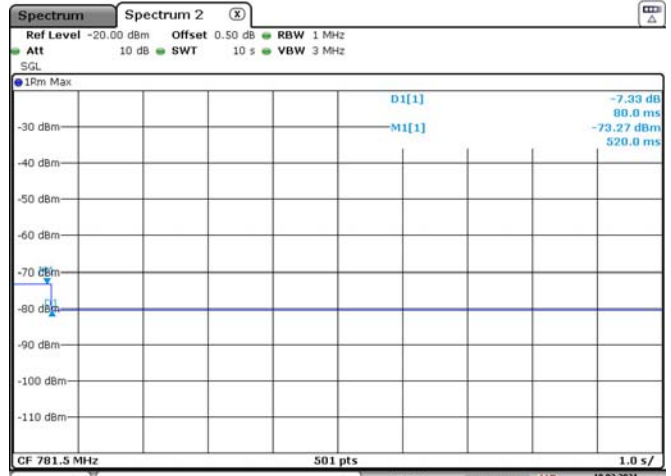

Date: 19.MAR.2021 09:39:40

Cellular Band

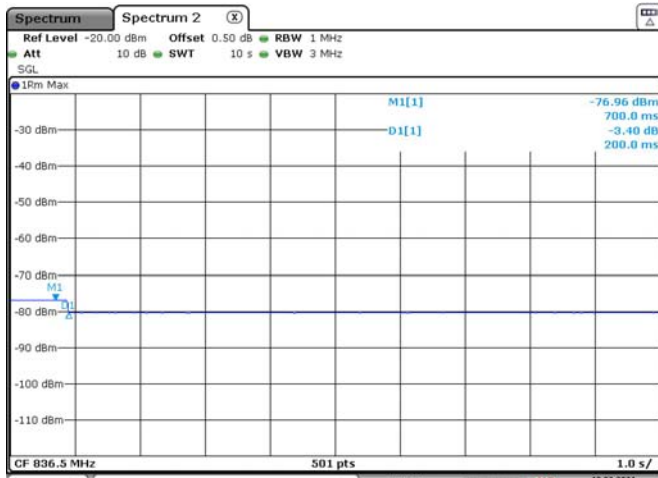

Date: 19.MAR.2021 09:34:41

AWS Band

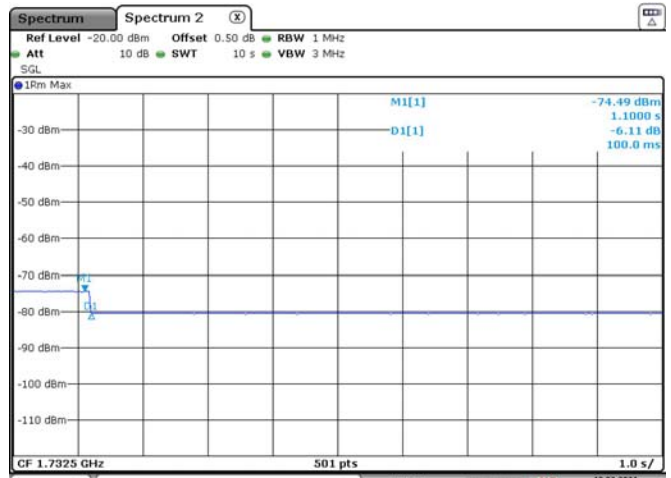

Date: 19.MAR.2021 09:37:03

PCS Band

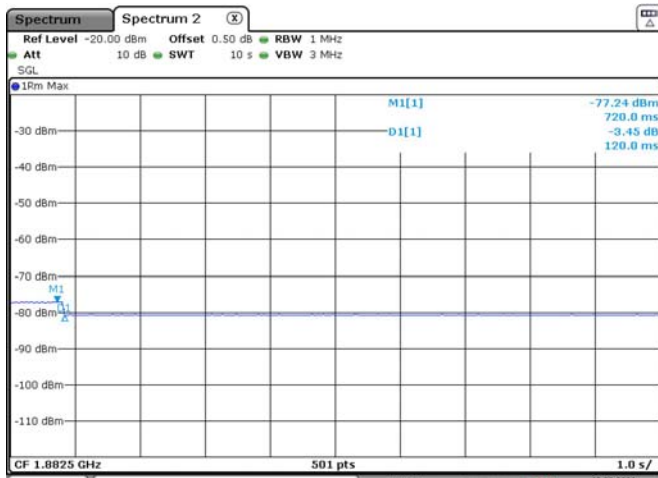

Date: 19.MAR.2021 09:38:24

8 - UPLINK INACTIVITY

Applicable Standards

According to § 20.21(e)(8)(i)(I) *Uplink Inactivity* & § 20.21(e)(4); § 20.21(e)(4) *Self-monitoring*.

Test Procedure

This measurement procedure is intended to demonstrate compliance to the uplink inactivity requirements specified for wideband consumer signal boosters in Section 20.21(e)(8)(i)(I).

- a) Connect the EUT to the test equipment as shown in **Figure 3** with the uplink output (donor) port connected to the spectrum analyzer.
- NOTE—Some signal boosters will require a signal generator input because they will not operate unless a signal is received at the input terminals. If this is the case for the setup shown in Figure 3 connect a signal generator at the server port, then cycle the RF output of the signal generator to simulate this function.*
- b) Select the power averaging (rms) detector.
- c) Set the spectrum analyzer RBW for 1 MHz with the VBW $\geq 3 * RBW$.
- d) Set the center frequency of the spectrum analyzer to the center of the uplink operational band.
- e) Set the span for 0 Hz with a single sweep time for a minimum of 330 seconds.
- f) Start to capture a new trace using MAX HOLD.
- g) After approximately 15 seconds, turn on the EUT power.
- h) After the full spectrum analyzer trace is complete, place a MARKER on the leading edge of the pulse, then use the DELTA MARKER METHOD to measure the time until the uplink becomes inactive.
- i) Affirm that the noise level is below the uplink inactivity noise power limit, as specified by the rules.
- j) Capture the plot for inclusion in the test report.
- k) Measure noise using procedures in 7.7.1a) to 7.7.1f).
- l) Repeat 7.8d) through 7.8k) for all operational uplink bands.

NOTE—Some signal boosters have a maximum transmitter noise power level that is less than the uplink inactivity limit. For these boosters it is still necessary to confirm the uplink activity timing requirement. Test reports should show measurement data demonstrating compliance. Alternatively the applicant may provide attestation with detailed design information and explanation justifying the omission of the uplink inactivity test procedure.

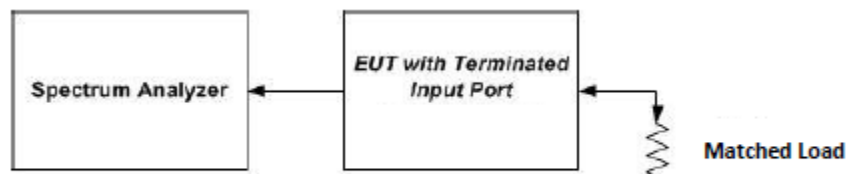

Figure 3 – Noise limit test setup (also used for 7.8)

Test Data

Test Result: Compliance. Please refer to following table and plots.

Operation Band	Measured value	Limit	Result
	s	s	
Lower 700MHz	264.00	300	Compliance
Upper 700MHz	263.00		Compliance
Cellular	263.00		Compliance
AWS	264.00		Compliance
PCS	263.00		Compliance

Note: When the consumer booster is not serving an active device connection after 5 minutes the uplink noise power not exceed -70 dBm/MHz.

Lower 700M Band

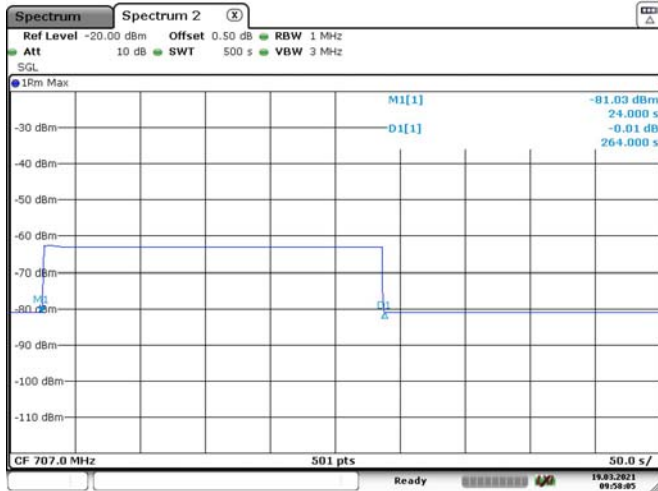

Date: 19.MAR.2021 09:58:06

Upper 700M Band

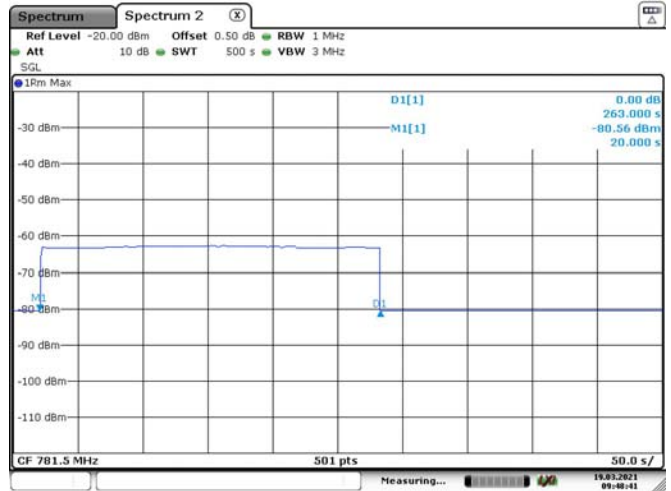

Date: 19.MAR.2021 09:40:41

Cellular Band



Date: 19.MAR.2021 10:09:16

AWS Band

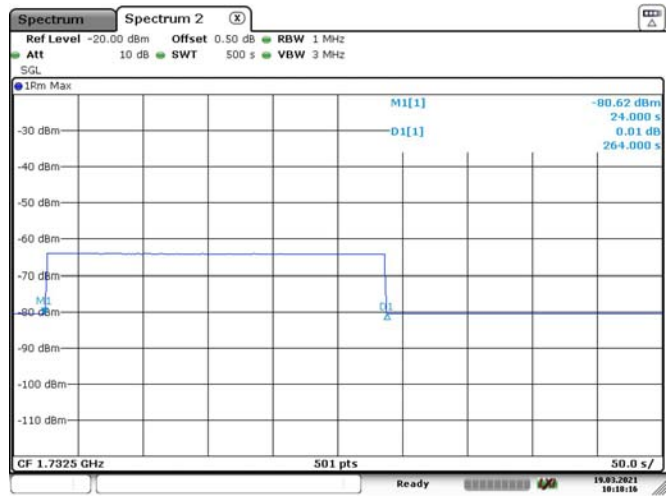

Date: 19.MAR.2021 10:18:16

PCS Band

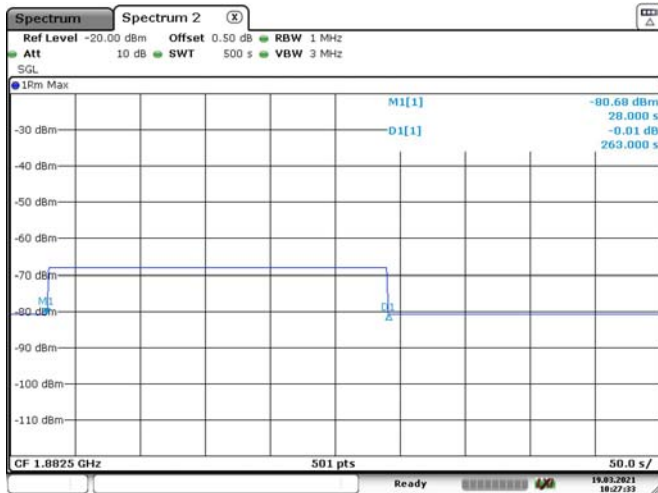

Date: 19.MAR.2021 10:27:33

9 - VARIABLE BOOSTER GAIN

Applicable Standards

According to § 20.21(e)(8)(i)(C)(1) *Booster Gain Limits* (variable gain); § 20.21(e)(8)(i)(H) *Transmit Power Off Mode* (uplink gain).

Test Procedure

Maximum gain

This procedure shall be used to demonstrate compliance to the booster gain limits specified for wideband consumer signal boosters in Section 20.21(e)(8)(i)(C) or Section 20.21(e)(8)(i)(H). The variable booster gain limits are expressed as a function of RSSI and MSCL, and are shown graphically in Appendix D. The RSSI is varied over a range of values as specified within the procedure. Refer to Appendix B of this document for guidance on determining the applicable MSCL value.

- a) Connect the EUT to the test equipment as shown in **Figure 5** with the uplink output (donor) port connected to signal generator #1. Affirm that the coupled path of the RF coupler is connected to the spectrum analyzer.
- b) Configure downlink signal generator #1 for AWGN operation with a 99% OBW of 4.1 MHz, tuned to the center of the operational band.
- c) Set the power level and frequency of signal generator #2 to a value that is 5 dB below the AGC level determined from 7.2. The signal type is AWGN with a 99% OBW of 4.1 MHz.
- d) Set RBW = 100 kHz.
- e) Set VBW \geq 300 kHz.
- f) Select the CHANNEL POWER measurement mode.
- g) Select the power averaging (rms) detector.
- h) Affirm that the number of measurement points per sweep $\geq (2*\text{span})/\text{RBW}$.
- i) Sweep time = auto couple or as necessary (but no less than auto couple value).
- j) Trace average at least 10 traces in power averaging (i.e., rms) mode.
- k) Measure the maximum channel power and compute maximum gain when varying the signal generator #1 output to a level from -90 dBm to -20 dBm, as measured at the input port (i.e., downlink signal level at the booster donor port node of Figure 5), in 1 dB steps inside the RSSI-dependent region, and 10 dB steps outside the RSSI-dependent region. Report the six values closest to the limit, including at least two points from within the RSSI-dependent region of operation. See gain limit in charts in Appendix D for uplink gain requirements. Additionally, document that the EUT provides equivalent uplink and downlink gain, and when operating in shutoff mode that the uplink and downlink gain is within the transmit power off mode gain limits.
- l) Repeat 7.9.1b) to 7.9.1k) for all operational uplink bands.

Variable uplink gain timing

Variable uplink gain timing is to be measured as follows, using the test setup shown in **Figure 5**.

- a) Set the spectrum analyzer to the uplink frequency to be measured.
- b) Set the span to 0 Hz with a sweep time of 10 seconds.
- c) Set the power level of signal generator #1 to the lowest level of the RSSI-dependent gain [see 7.9.1k)].
- d) Select MAX HOLD and increase the power level of signal generator #1 by 10 dB for mobile boosters, and by 20 dB for fixed indoor boosters. Signal generator #2 remains same, as described in 7.9.1c).
- e) Confirm that the uplink gain decreases to the specified levels, within 1 second for mobile devices, and within 3 seconds for fixed devices.
- f) Repeat 7.9.2a) to 7.9.2e) for all operational uplink bands.

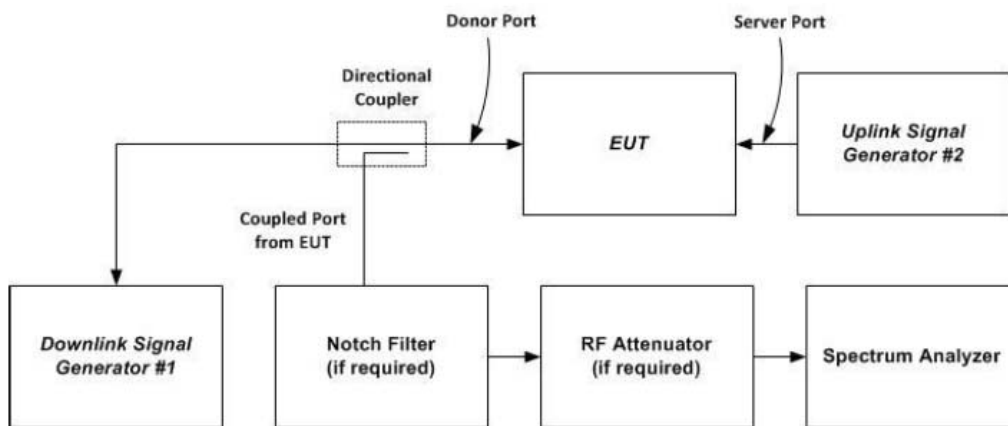

Figure 5 – Variable gain instrumentation test setup

Test Data

Test Result: Compliance. Please refer to following table.

MSCL Calculation:

For antenna model: ANT070101, ANT060303

Operation Bands	Frequency	Distance	Path Loss	Inside Antenna Gain	Inside Cable Loss	MSCL
	MHz					
Lower 700MHz	707	0.2	15.51	3	2.2	14.71
Upper 700MHz	781.5	0.2	16.38	3	2.3	15.68
Cellular	836.5	0.2	16.97	3	2.5	16.47
AWS	1732.5	0.2	23.29	3	4.1	24.39
PCS	1882.5	0.2	24.02	3	3.8	24.82

For other antenna model

Operation Bands	Frequency	Distance	Path Loss	Inside Antenna Gain	Inside Cable Loss	MSCL
	MHz					
Lower 700MHz	707	0.6	25.05	9	2.2	18.25
Upper 700MHz	781.5	0.6	25.92	9	2.3	19.22
Cellular	836.5	0.6	26.51	9	2.5	20.01
AWS	1732.5	0.6	32.84	10	4.1	26.94
PCS	1882.5	0.6	33.56	10	3.8	27.36

Note:

Path loss=20logf+20logd-27.5

f = frequency in MHz

d = separation distance in meters, please refer to the user manual

Compliance to applicable limits used highest gains from the list of antennas, cabling, and coupling devices declared by the manufacturer for use with the consumer booster.

Variable Booster Gain:

Note: Compare with the two MSCL results, and the worst case will be used.

Operation Bands	RSSI dBm	P _{in} dBm	P _{out} dBm	MSCL dB	Measured Value dB	Limit dB	Margin dB
Lower 700MHz	-60	-22.5	7.41	14.71	29.91	40.71	10.80
	-50	-22.5	-0.91	14.71	21.59	30.71	9.12
	-40	-22.5	-11.84	14.71	10.66	20.71	10.05
	-36	-22.5	-11.74	14.71	10.76	16.71	5.95
	-35	-22.5	-11.33	14.71	11.17	15.71	4.54
	-34	-22.5	-12.77	14.71	9.73	14.71	4.98
Upper 700MHz	-60	-21.5	10.11	15.68	31.61	41.68	10.07
	-50	-21.5	7.98	15.68	29.48	31.68	2.20
	-40	-21.5	-0.57	15.68	20.93	21.68	0.75
	-36	-21.5	-5.19	15.68	16.31	17.68	1.37
	-35	-21.5	-10.91	15.68	10.59	16.68	6.09
	-34	-21.5	-11.06	15.68	10.44	15.68	5.24
Cellular	-60	-24.5	7.47	16.47	31.97	42.47	10.50
	-50	-24.5	-0.91	16.47	23.59	32.47	8.88
	-40	-24.5	-8.31	16.47	16.19	22.47	6.28
	-36	-24.5	-11.23	16.47	13.27	18.47	5.20
	-35	-24.5	-11.65	16.47	12.85	17.47	4.62
	-34	-24.5	-11.67	16.47	12.83	16.47	3.64
AWS	-60	-19.5	10.03	24.39	29.53	50.39	20.86
	-50	-19.5	10.05	24.39	29.55	40.39	10.84
	-40	-19.5	1.71	24.39	21.21	30.39	9.18
	-36	-19.5	-7.84	24.39	11.66	26.39	14.73
	-35	-19.5	-8.69	24.39	10.81	25.39	14.58
	-34	-19.5	-10.57	24.39	8.93	24.39	15.46
PCS	-60	-21.5	9.41	24.82	30.91	50.82	19.91
	-50	-21.5	3.45	24.82	24.95	40.82	15.87
	-40	-21.5	-6.03	24.82	15.47	30.82	15.35
	-36	-21.5	-10.69	24.82	10.81	26.82	16.01
	-35	-21.5	-10.76	24.82	10.74	25.82	15.08
	-34	-21.5	-11.86	24.82	9.64	24.82	15.18

Note: According to KDB 935210 D03 Signal Booster Measurements v04r04 Annex D, Variable booster gain Limit: -34 dB - RSSI + MSCL in RSSI-Dependent Region, out of RSSI-Dependent Region, it is 50 dB when MSCL = 20dB.

Variable Gain Timing:

Operation Bands	Measured value	Limit	Results
MHz	s	s	
Lower 700MHz	0.100	1	Compliance
Upper 700MHz	0.120		Compliance
Cellular	0.100		Compliance
AWS	0.200		Compliance
PCS	0.080		Compliance
			Compliance

Note: The uplink noise decreases to the specified level within 1 second for mobile devices and 3 seconds for fixed devices.

Lower 700M Band



Date: 19.MAR.2021 11:18:13

Upper 700M Band

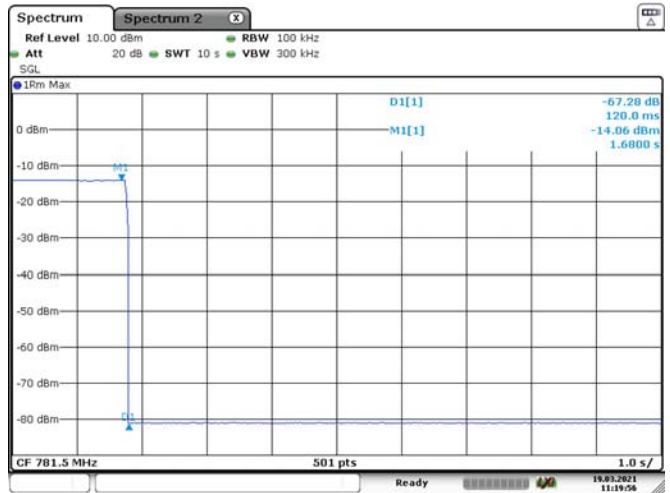

Date: 19.MAR.2021 11:19:56

Cellular Band

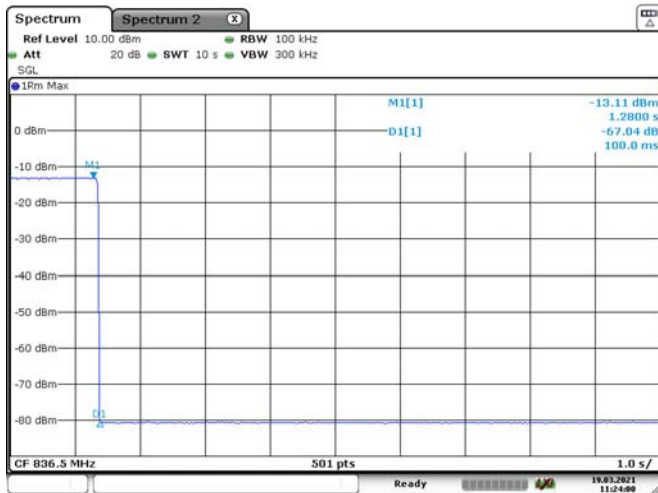

Date: 19.MAR.2021 11:24:00

AWS Band



Date: 19.MAR.2021 11:25:26

PCS Band



Date: 19.MAR.2021 11:26:26

10 - OCCUPIED BANDWIDTH

Applicable Standards

According to § 2.1049 *Measurements required: Occupied bandwidth.*

Test Procedure

This measurement is required to compare the consistency of the output signal relative to the input signal, and to satisfy the requirements of Section 2.1049.

- a) Connect the test equipment as shown in **Figure 6** to firstly measure the characteristics of the test signals produced by the signal generator.
- b) Set $VBW \geq 3 * RBW$.
- c) Set the center frequency of the spectrum analyzer to the center of the operational band. The span will be adjusted for each modulation type and OBW as necessary for accurately viewing the signals.
- d) Set the signal generator for power level to match the values obtained from the tests of 7.2.
- e) Set the signal generator modulation type for GSM with a PRBS pattern and allow the trace on the signal generator to stabilize adjusting the span as necessary.
- f) Set the spectrum analyzer RBW for 1% to 5% of the EBW.
- g) Capture the spectrum analyzer trace for inclusion in the test report.
- h) Repeat 7.10c) to 7.10g) for CDMA and W-CDMA modulation, adjusting the span as necessary. AWGN or LTE may be used in place of W-CDMA, as an option.
- i) Repeat 7.10c) to 7.10h) for all uplink and downlink operational bands.
- j) Connect the test equipment as shown in Figure 1, with the uplink output (donor) port connected to the spectrum analyzer, and the server port connected to the signal generator.
- k) Repeat 7.10c) to 7.10i) with this EUT uplink path test setup.
- l) Connect the test equipment as shown in Figure 1, with the downlink output (server) port connected to the spectrum analyzer, and the donor port connected to the signal generator.
- m) Repeat 7.10c) to 7.10i) with this EUT downlink path test setup.

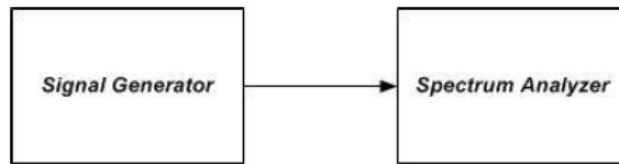

Figure 6 – Test setup for measuring characteristics of test signals used for subsequent EUT occupied bandwidth testing

Test Data

Test Result: Compliance. Please refer to following table and plots.

Mode	Operation Band	Signal Type	Input	Output
			MHz	MHz
Uplink	Lower 700MHz	GSM	0.246	0.244
		CDMA	1.269	1.275
		WCDMA	4.551	4.551
	Upper 700MHz	GSM	0.246	0.250
		CDMA	1.269	1.269
		WCDMA	4.531	4.651
	Cellular	GSM	0.246	0.246
		CDMA	1.269	1.281
		WCDMA	4.551	4.571
	AWS	GSM	0.246	0.246
		CDMA	1.275	1.281
		WCDMA	4.531	4.651
	PCS	GSM	0.246	0.246
		CDMA	1.269	1.275
		WCDMA	4.531	4.631
Downlink	Lower 700MHz	GSM	0.246	0.244
		CDMA	1.269	1.275
		WCDMA	4.551	4.531
	Upper 700MHz	GSM	0.246	0.244
		CDMA	1.269	1.275
		WCDMA	4.531	4.551
	Cellular	GSM	0.246	0.242
		CDMA	1.275	1.269
		WCDMA	4.531	4.551
	AWS	GSM	0.246	0.246
		CDMA	1.275	1.269
		WCDMA	4.531	4.571
	PCS	GSM	0.246	0.246
		CDMA	1.269	1.275
		WCDMA	4.551	4.551

Lower 700M Band Uplink

GSM-Input

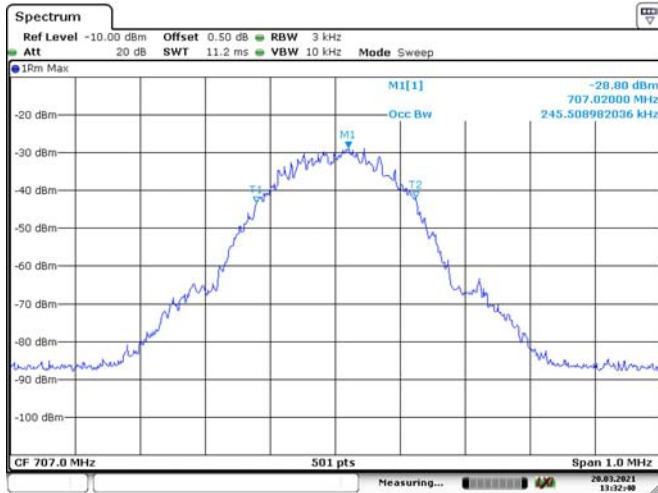

GSM-Output

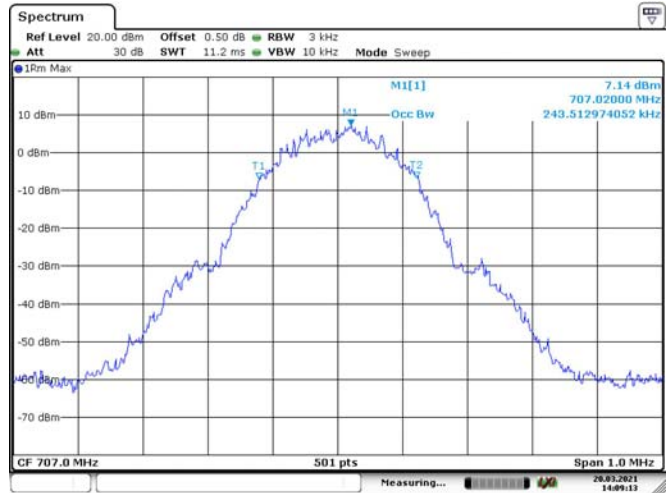

CDMA-Input

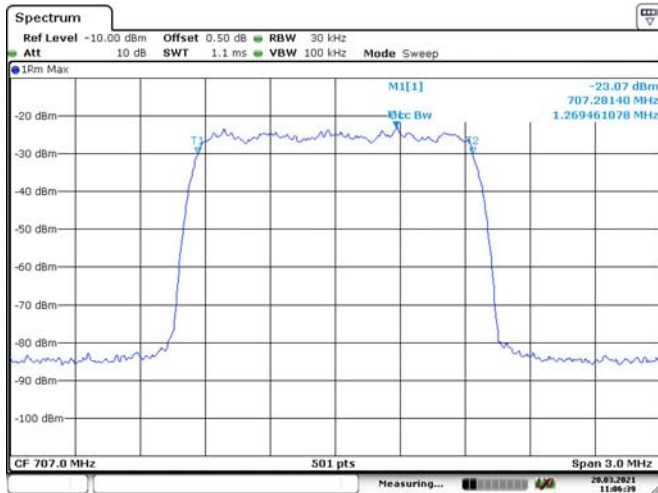

CDMA-Output

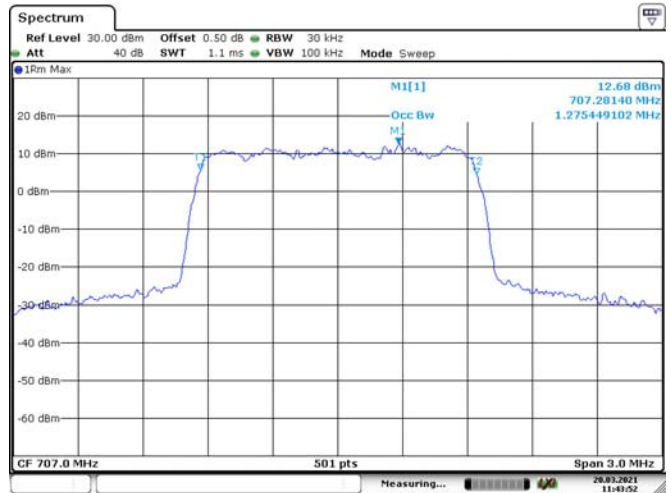

WCDMA-Input

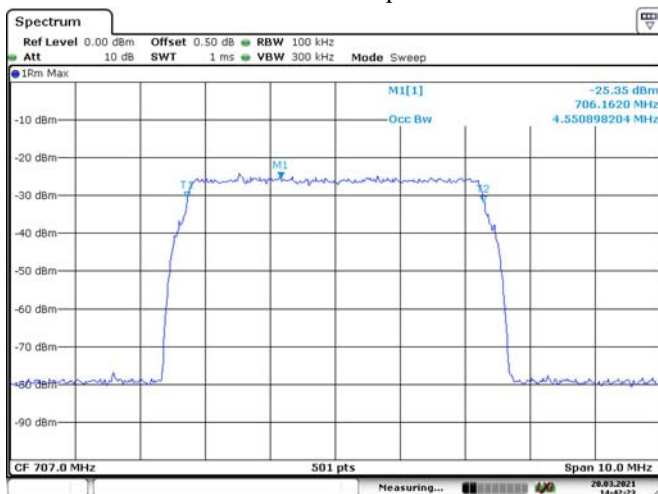

WCDMA-Output

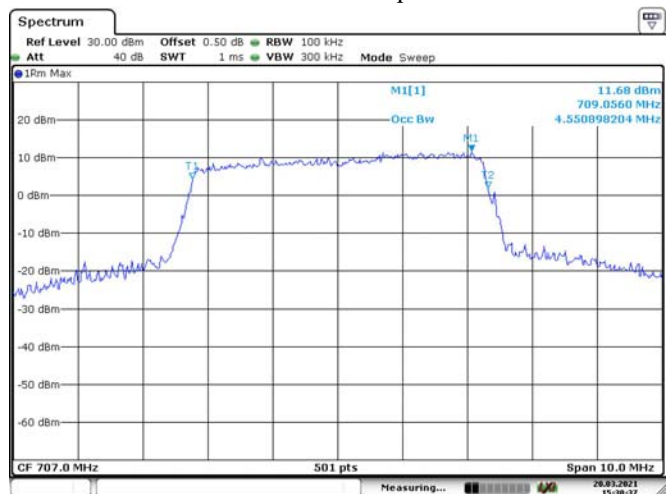

Upper 700M Band Uplink

GSM-Input

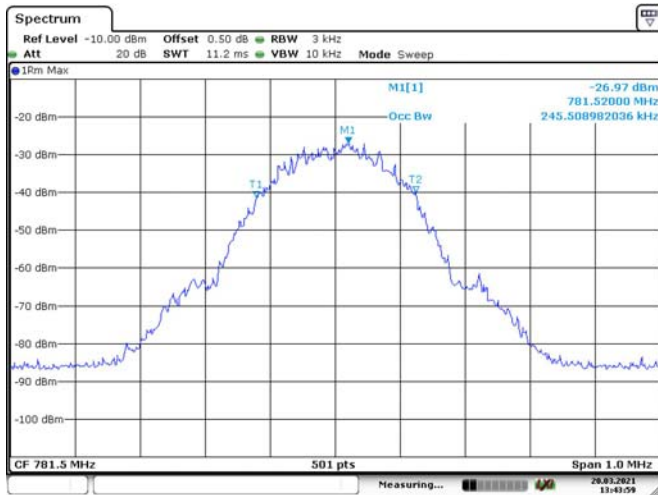

GSM-Output

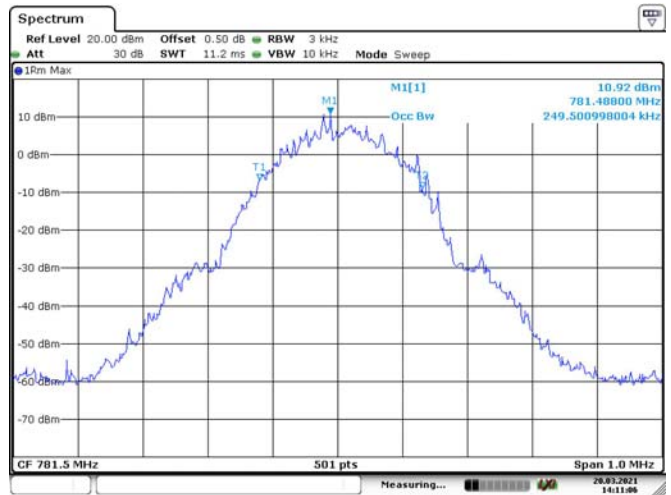

CDMA-Input



CDMA-Output

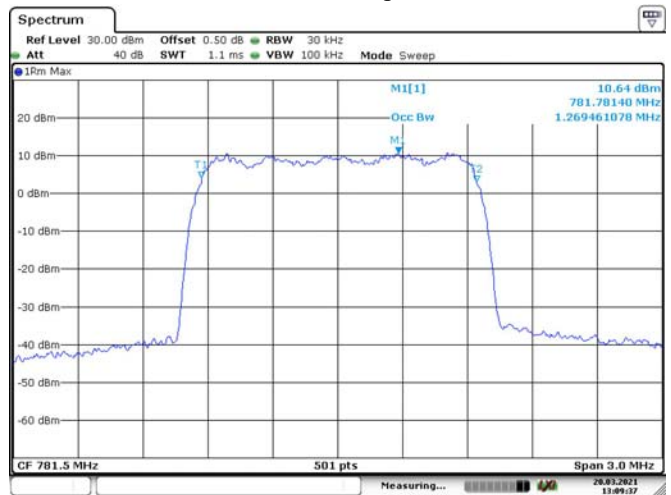

WCDMA-Input

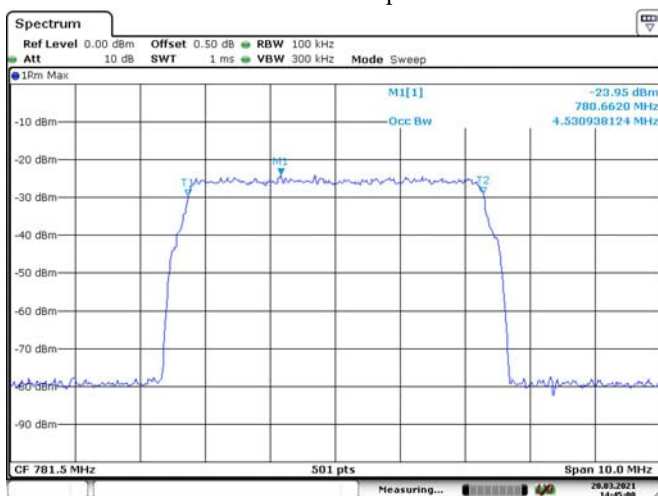

WCDMA-Output

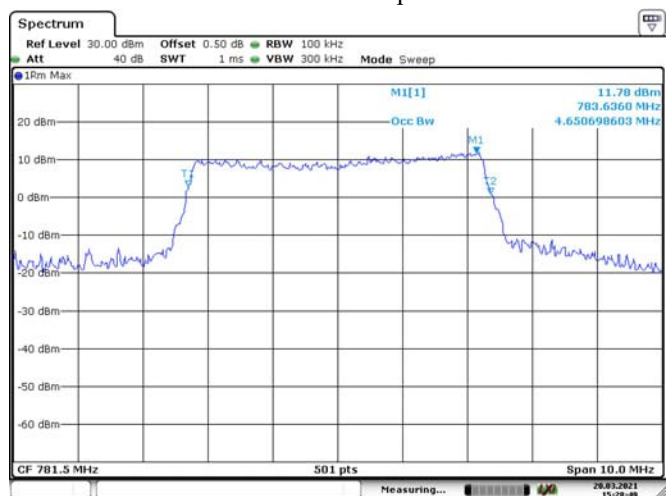

Cellular Band Uplink

GSM-Input



Date: 20.MAR.2021 13:45:54

GSM-Output

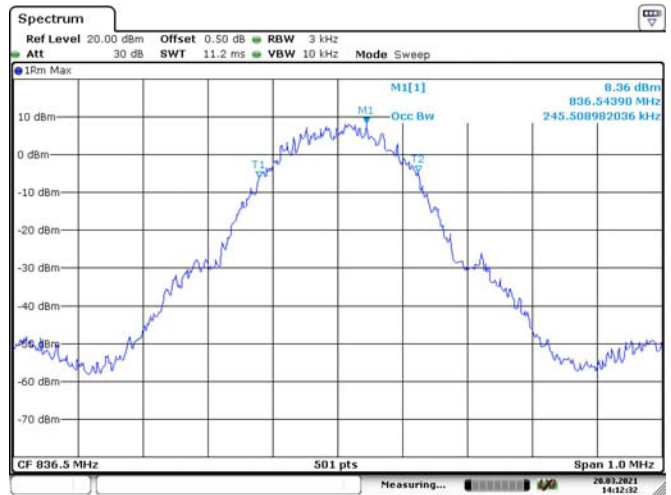

Date: 20.MAR.2021 14:12:32

CDMA-Input

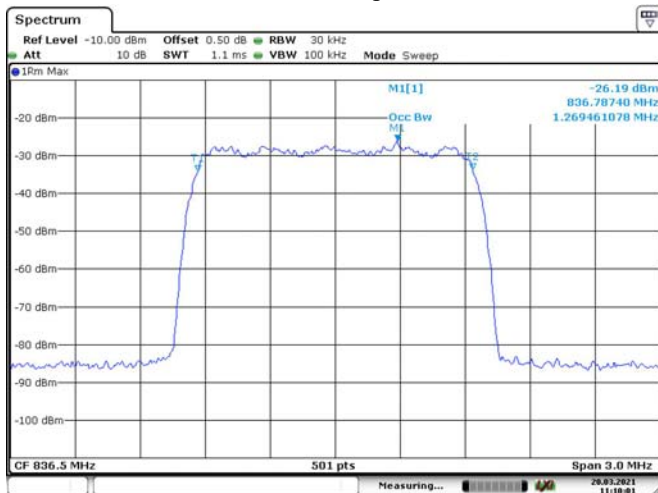

Date: 20.MAR.2021 11:10:02

CDMA-Output

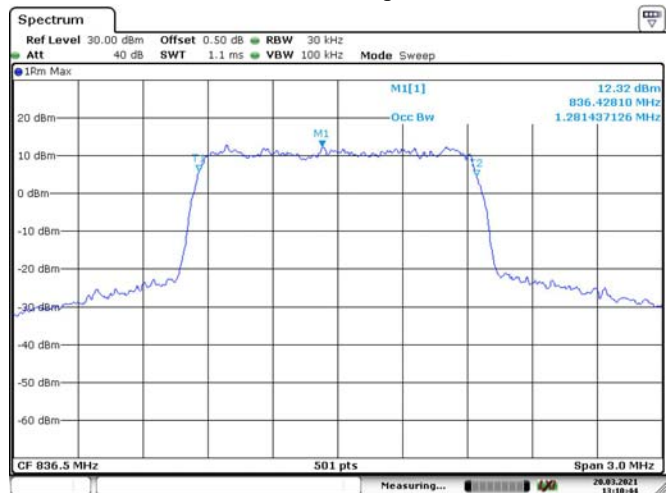

Date: 20.MAR.2021 13:10:44

WCDMA-Input

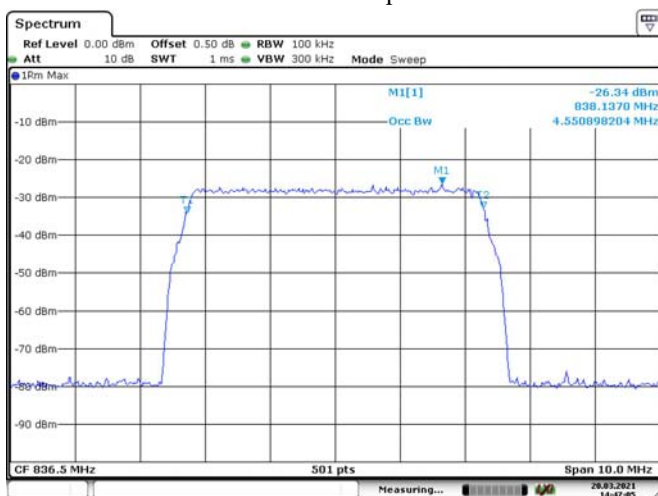

Date: 20.MAR.2021 14:47:05

WCDMA-Output

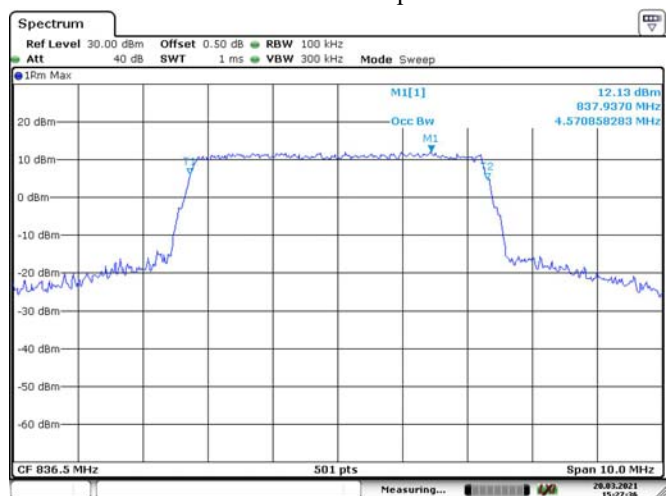

Date: 20.MAR.2021 15:27:36

AWS Band Uplink

GSM-Input

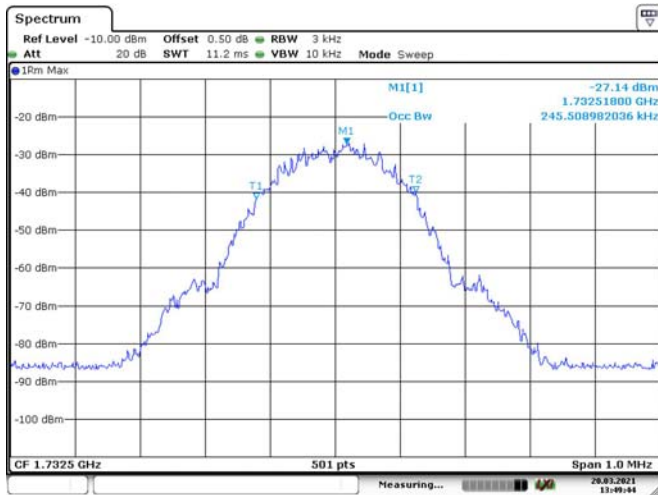

Date: 20.MAR.2021 13:49:44

GSM-Output

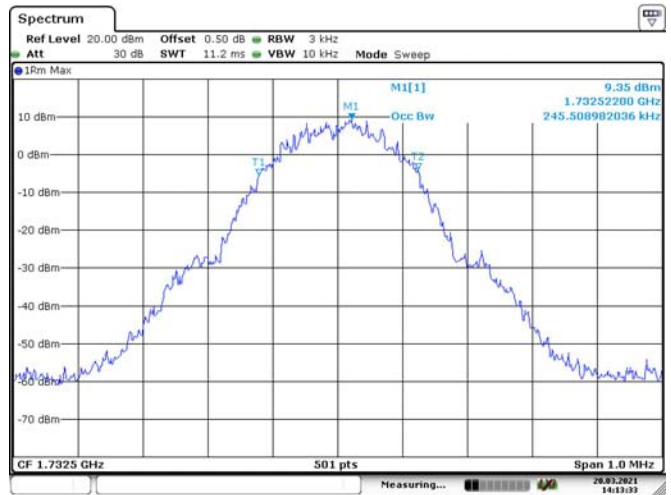

Date: 20.MAR.2021 14:13:33

CDMA-Input

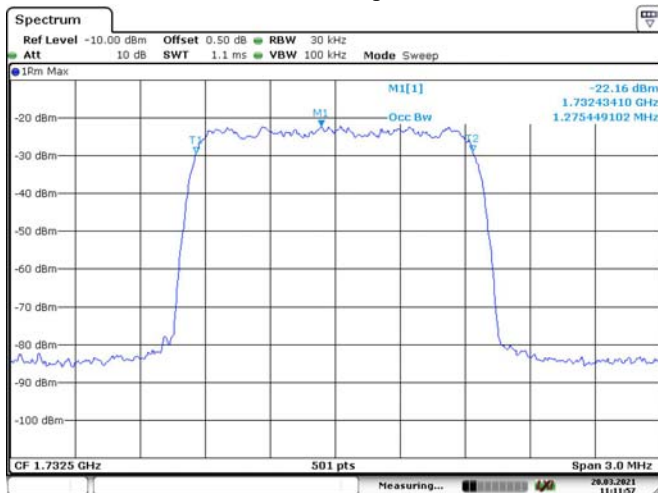

Date: 20.MAR.2021 11:11:57

CDMA-Output

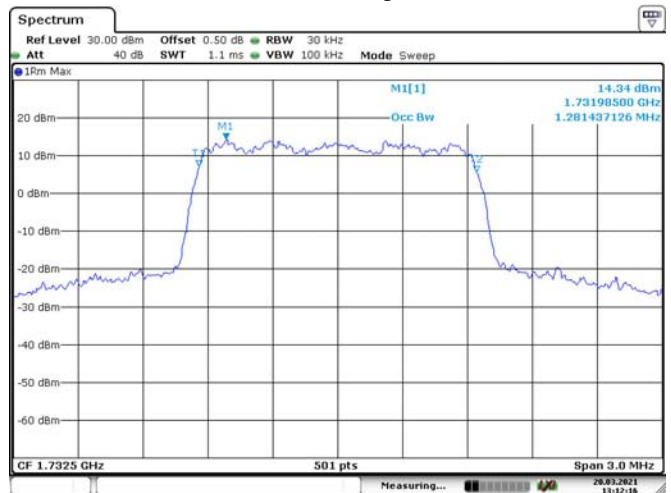

Date: 20.MAR.2021 13:12:17

WCDMA-Input

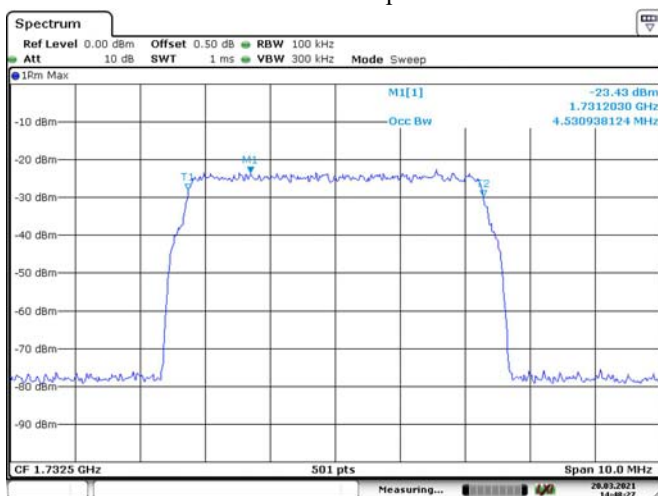

Date: 20.MAR.2021 14:48:27

WCDMA-Output

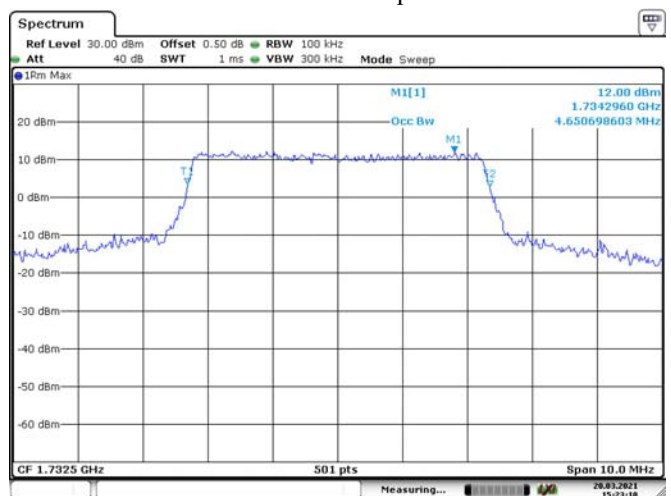

Date: 20.MAR.2021 15:23:11

PCS Band Uplink

GSM-Input

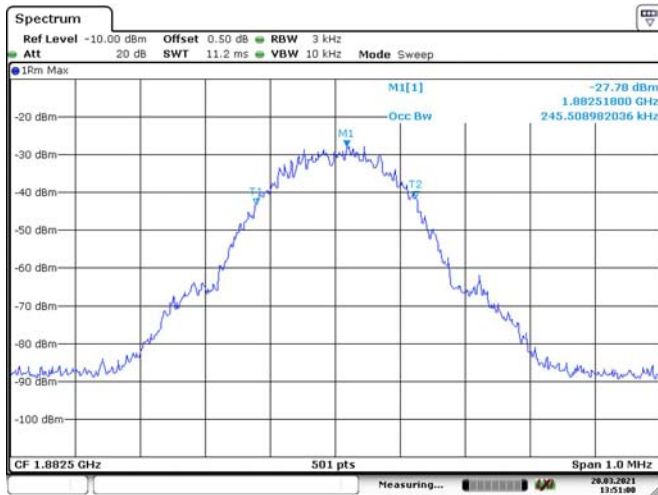

Date: 20.MAR.2021 13:51:00

GSM-Output

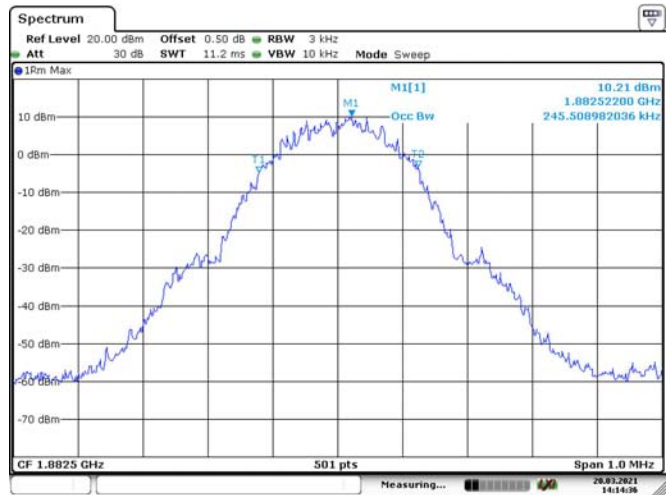

Date: 20.MAR.2021 14:14:36

CDMA-Input

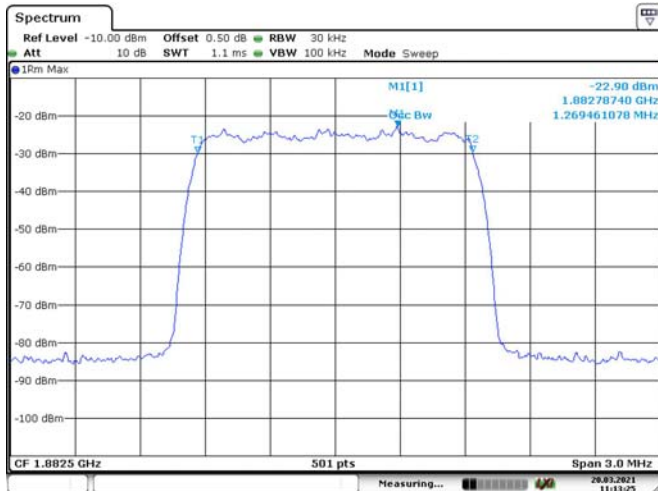

Date: 20.MAR.2021 11:13:25

CDMA-Output

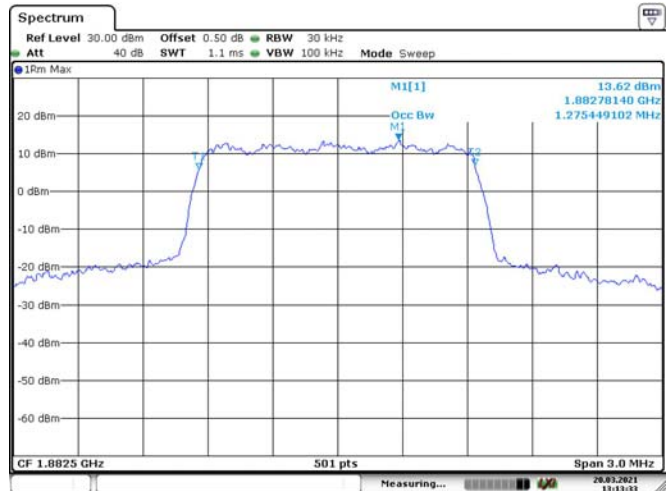

Date: 20.MAR.2021 13:13:34

WCDMA-Input

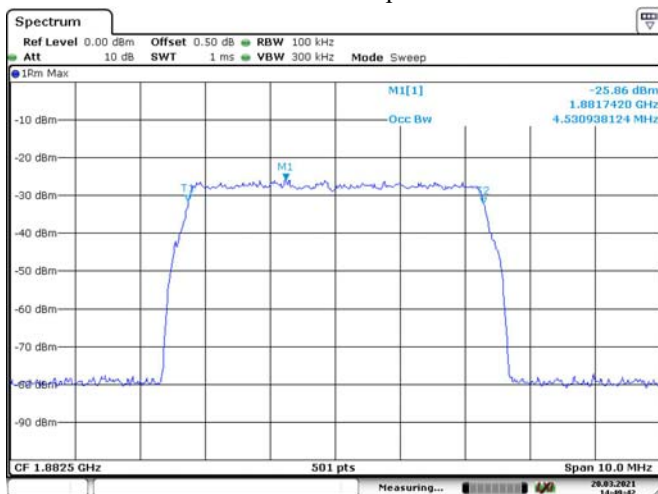

Date: 20.MAR.2021 14:49:41

WCDMA-Output

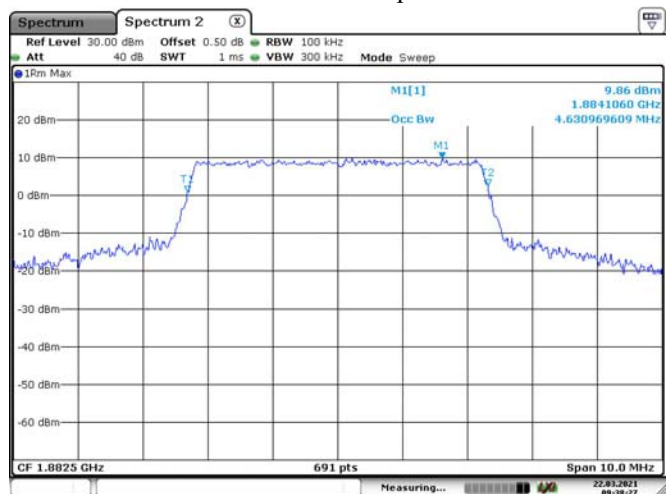

Date: 22.MAR.2021 09:38:27

Lower 700M Band Downlink

GSM-Input



GSM-Output



CDMA-Input

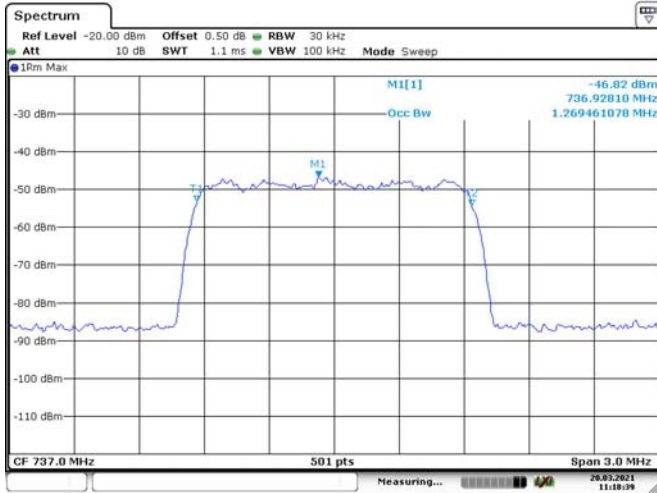

CDMA-Output

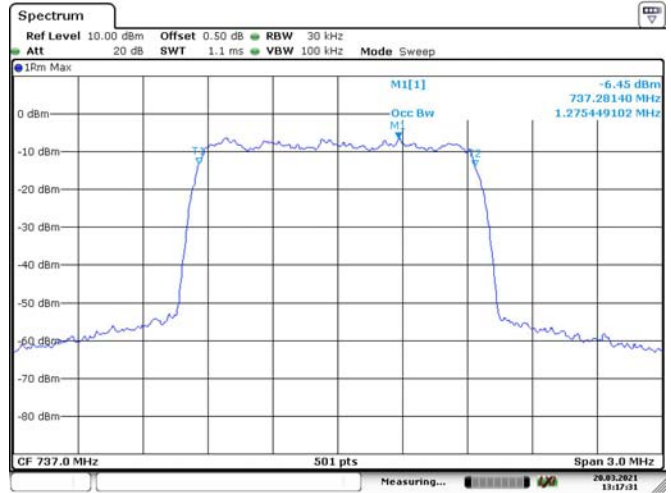

WCDMA-Input

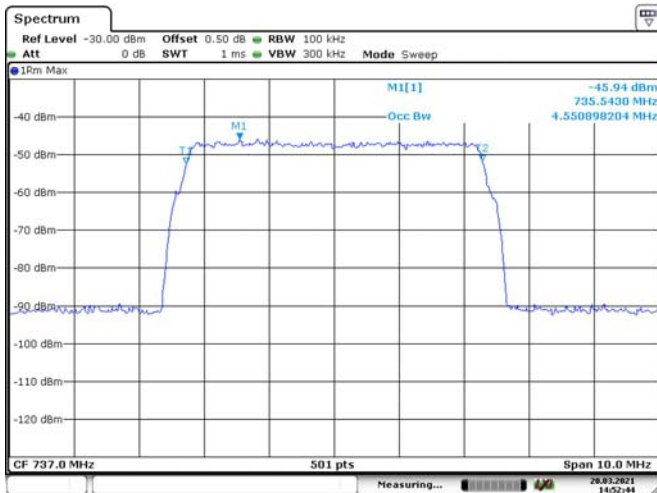

WCDMA-Output

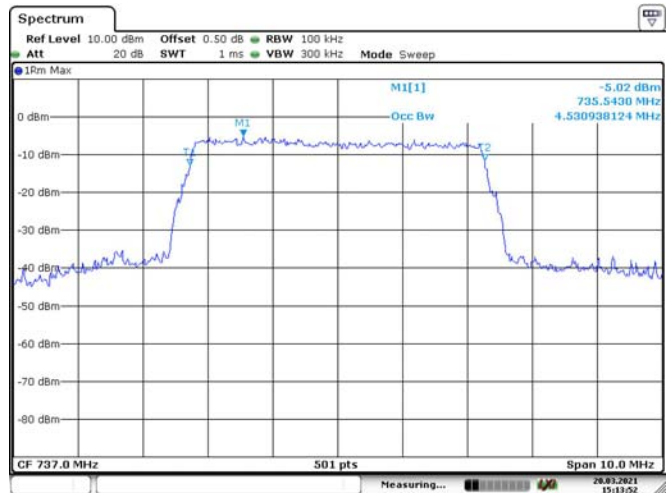

Upper 700M Band Downlink

GSM-Input

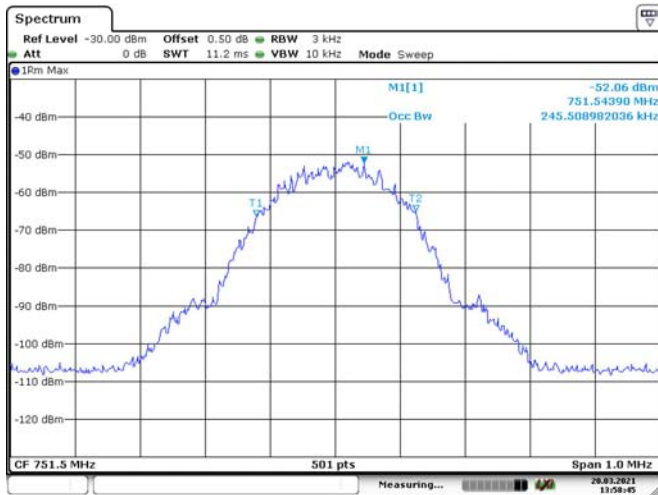

Date: 20.MAR.2021 13:58:45

GSM-Output

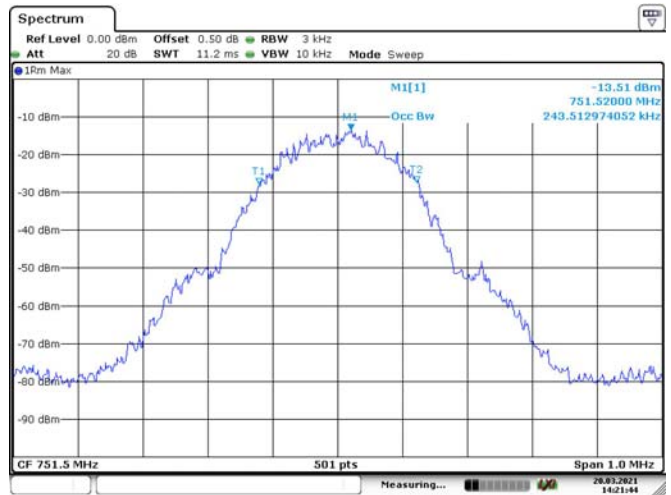

Date: 20.MAR.2021 14:21:44

CDMA-Input

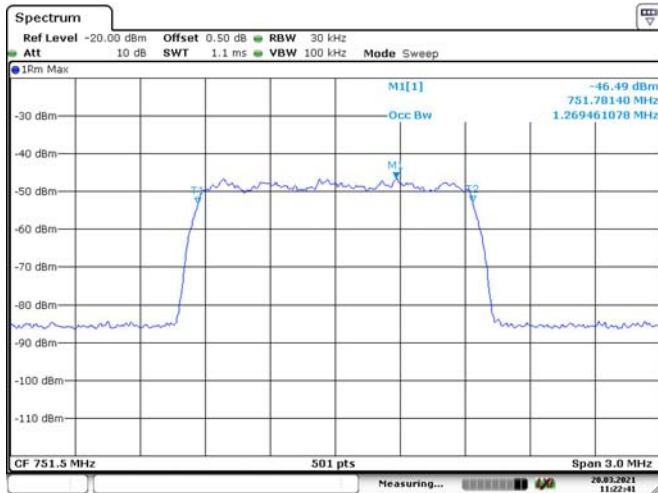

Date: 20.MAR.2021 11:22:41

CDMA-Output

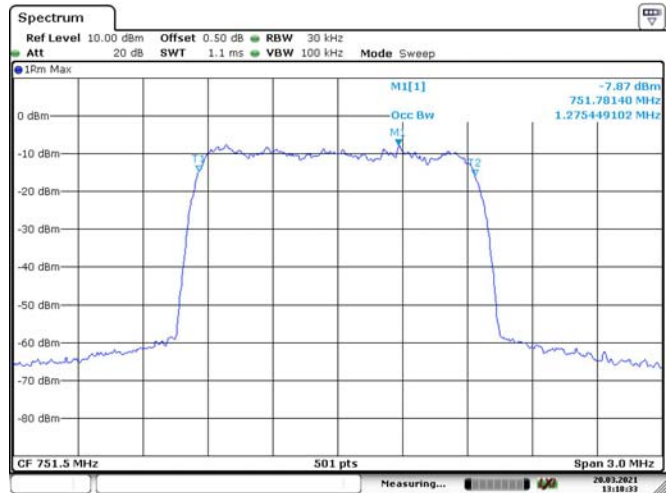

Date: 20.MAR.2021 13:18:34

WCDMA-Input

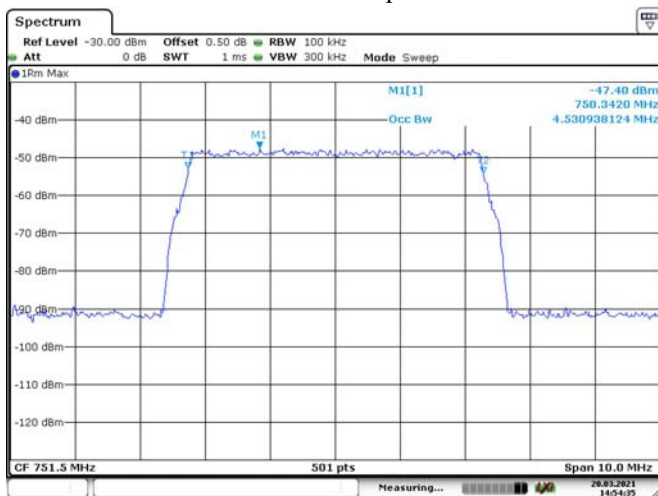

Date: 20.MAR.2021 14:54:35

WCDMA-Output

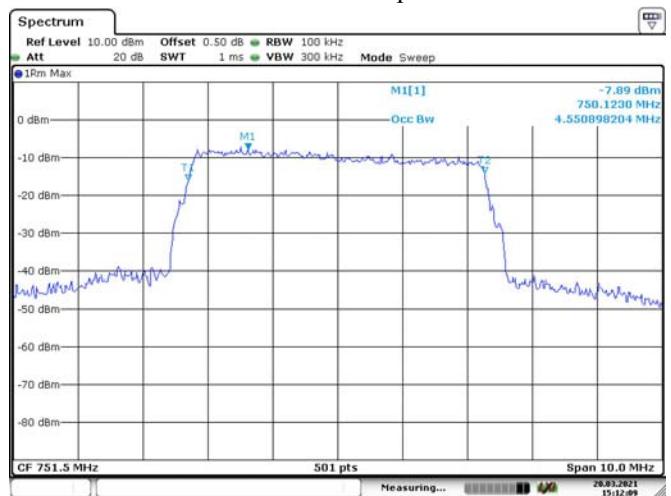

Date: 20.MAR.2021 15:12:09

Cellular 700M Band Downlink

GSM-Input



Date: 20.MAR.2021 13:59:58

GSM-Output

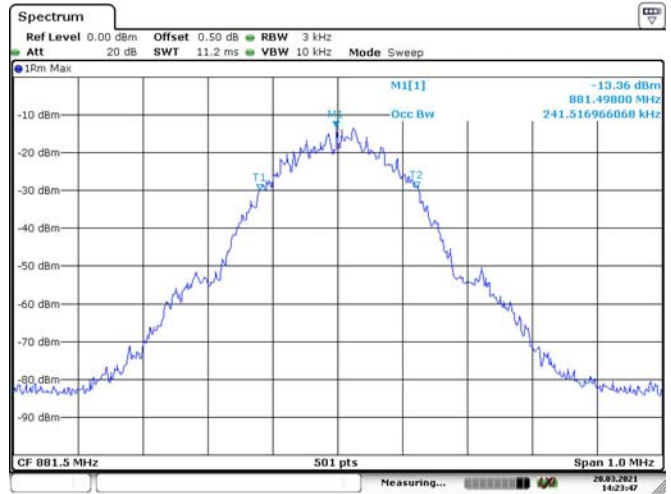

Date: 20.MAR.2021 14:23:47

CDMA-Input

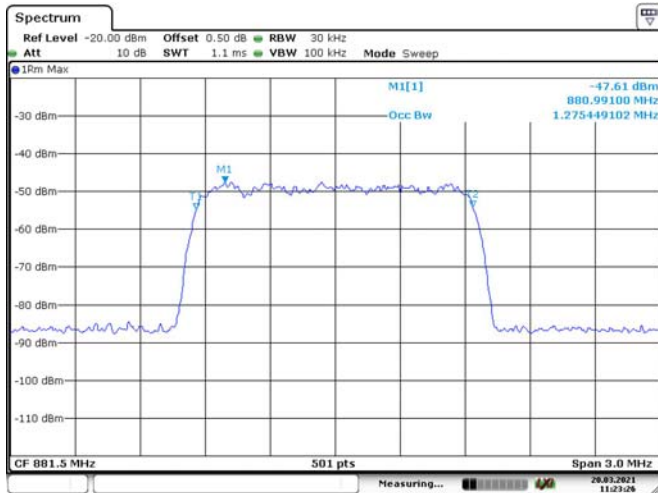

Date: 20.MAR.2021 11:23:26

CDMA-Output

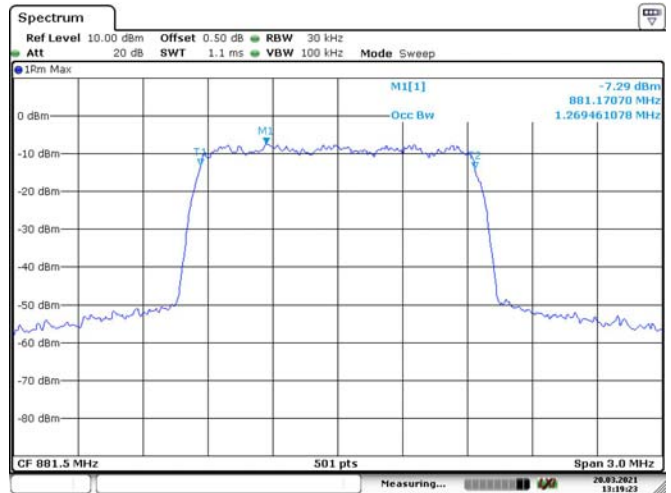

Date: 20.MAR.2021 13:19:24

WCDMA-Input

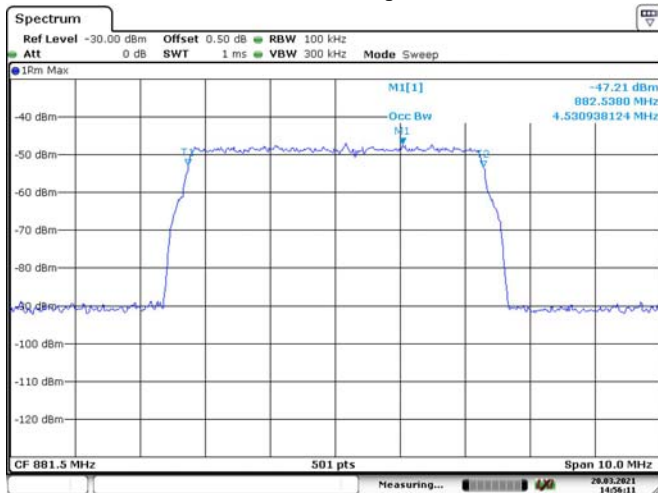

Date: 20.MAR.2021 14:56:11

WCDMA-Output

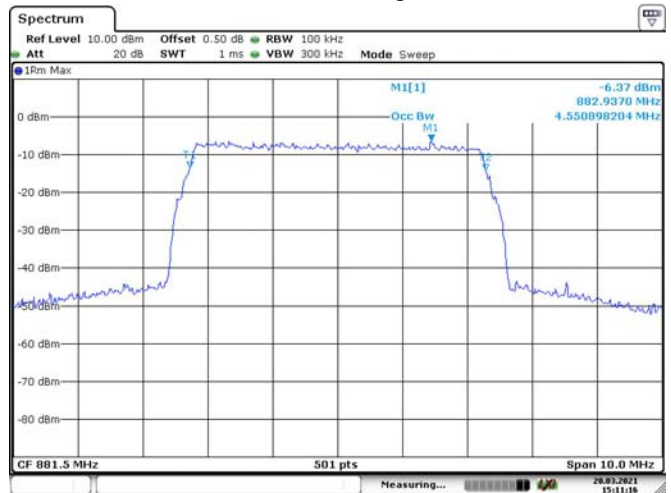

Date: 20.MAR.2021 15:11:16

AWS Band Downlink

GSM-Input

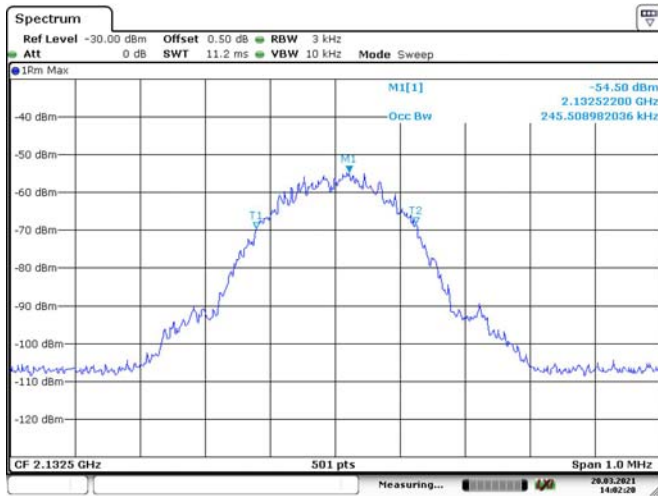

Date: 20.MAR.2021 14:02:20

GSM-Output



Date: 20.MAR.2021 14:25:41

CDMA-Input

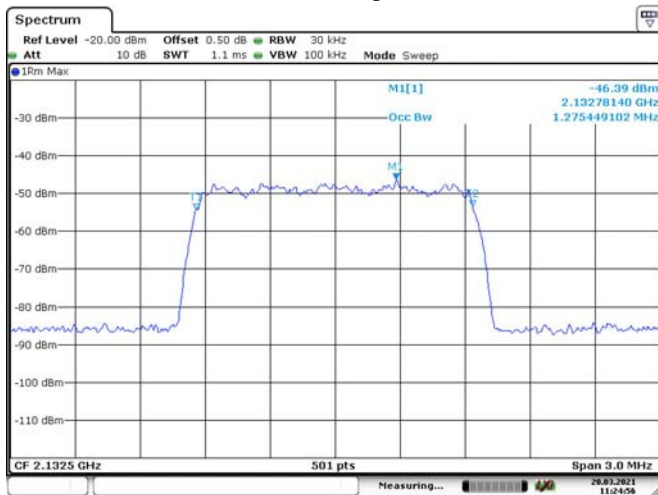

Date: 20.MAR.2021 11:24:57

CDMA-Output

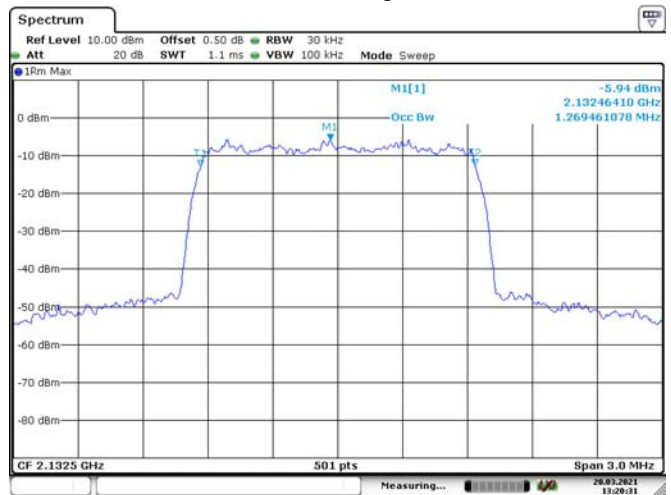

Date: 20.MAR.2021 13:20:32

WCDMA-Input

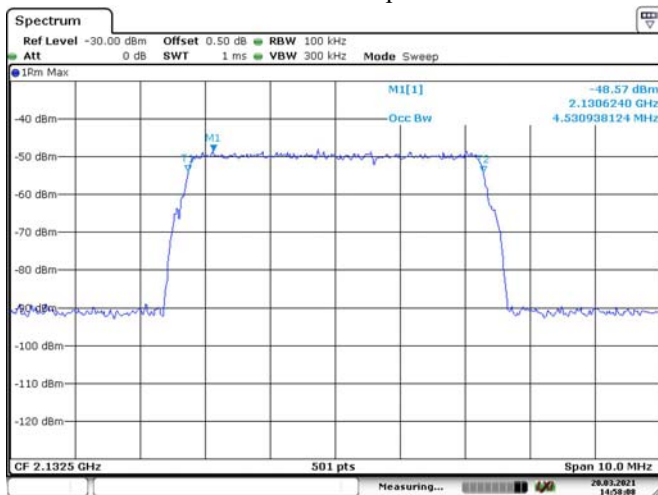

Date: 20.MAR.2021 14:58:08

WCDMA-Output

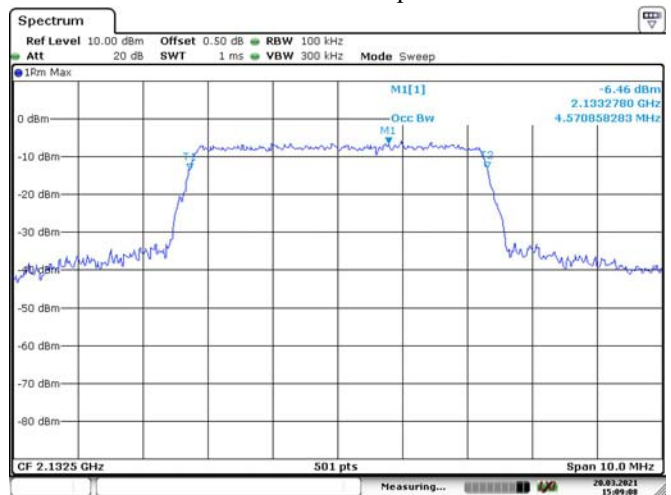

Date: 20.MAR.2021 15:09:08

PCS Band Downlink

GSM-Input

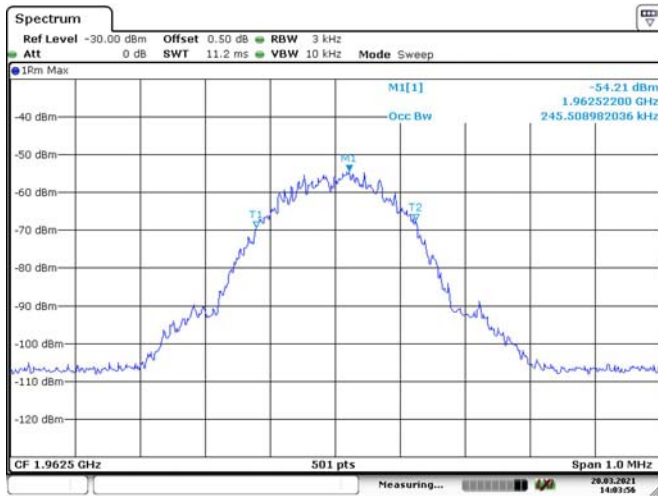

Date: 20.MAR.2021 14:03:56

GSM-Output

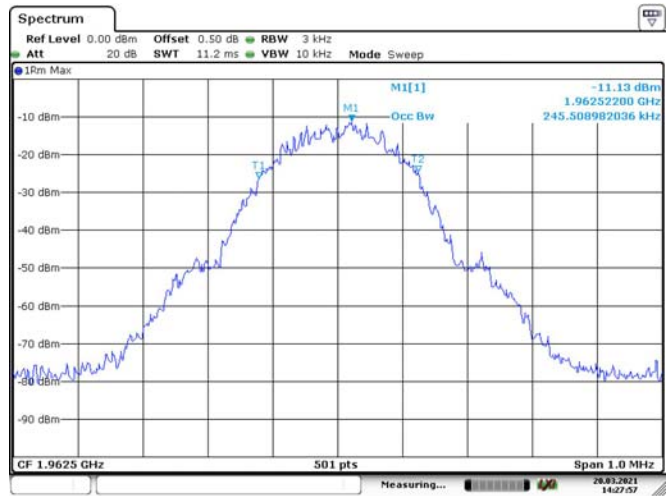

Date: 20.MAR.2021 14:27:57

CDMA-Input

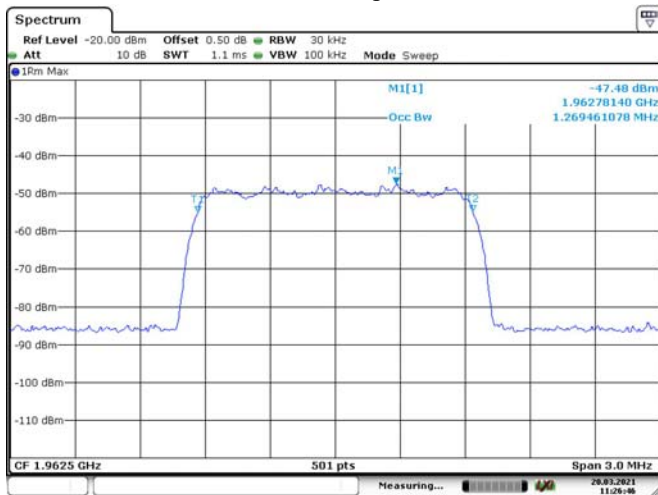

Date: 20.MAR.2021 11:26:46

CDMA-Output

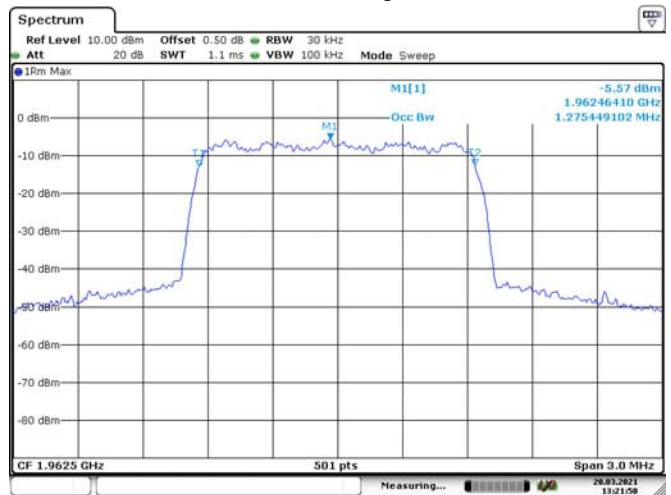

Date: 20.MAR.2021 13:21:51

WCDMA-Input

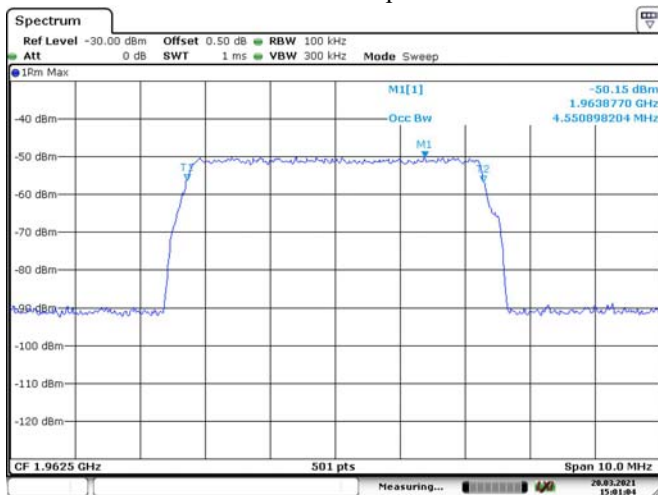

Date: 20.MAR.2021 15:01:04

WCDMA-Output

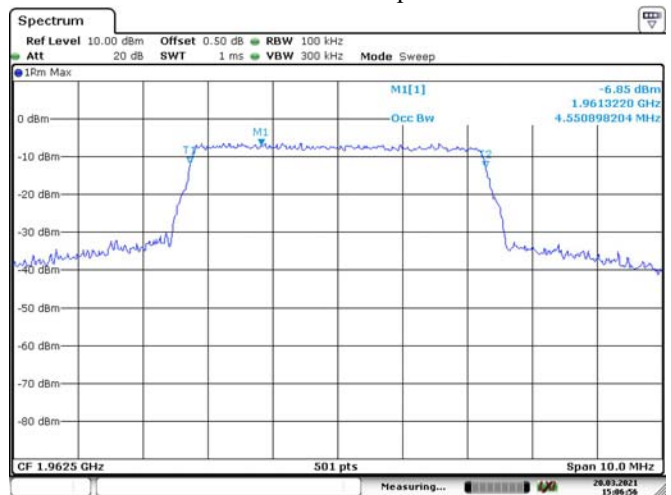

Date: 20.MAR.2021 15:06:56

11 - OSCILLATION DETECTION

Applicable Standards

According to § 20.21(e)(8)(ii)(A) *Anti-Oscillation*, §20.21(e)(4) *Self-monitoring*.

Use of two EUTs is permitted for this measurement, which can greatly reduce the test time required. One EUT shall operate in a normal mode, and the second EUT shall operate in a test mode that is capable of disabling the uplink inactivity function and/or allows a reduction to 5 seconds of the time between restarts.

The procedures in 7.11.3 and 7.11.4 do not apply for devices that operate only as direct-connection mobile boosters having gain of less than or equal to 15 dB.

Test Procedure

Oscillation restart tests

- a) Connect the normal-operating mode EUT to the test equipment as shown in **Figure 7** beginning with the spectrum analyzer on the uplink output (donor) port. Confirm that the RF coupled path is connected to the spectrum analyzer.

NOTE—The band-pass filter shall provide sufficient out-of-band rejection to prevent oscillations from occurring in bands not under test.

- b) Spectrum analyzer settings:
- 1) Center frequency at the center of the band under test
 - 2) Span equal or slightly exceeding the width of the band under test
 - 3) Continuous sweep, max-hold
 - 4) $RBW \geq 1$ MHz, $VBW > 3 * RBW$
- c) Decrease the variable attenuator until the spectrum analyzer displays a signal within the band under test. Using a marker, identify the approximate center frequency of this signal on the max-hold display, increase the attenuation by 10 dB, then reset the EUT (e.g., cycle ac/dc power).
- d) Repeat 7.11.2c) twice to ensure that the center of the signal created by the booster remains within 250 kHz of the spectrum analyzer display center frequency. If the frequency of the signal is unstable, confirm that the spectrum analyzer display is centered between the frequency extremes observed. If the signal is wider than 1 MHz, ensure that the spectrum analyzer display is centered on the signal by increasing the RBW. Reset the EUT (e.g., cycle ac/dc power) after each oscillation event, if necessary. Set the spectrum analyzer sweep trigger level to just below the peak amplitude of the displayed EUT oscillation signal.
- e) Set the spectrum analyzer to zero-span, with a sweep time of 5 seconds, and single-sweep with max-hold. The spectrum analyzer sweep trigger level in this and the subsequent steps shall be the level identified in 7.11.2d).
- f) Decrease the variable attenuator until the spectrum analyzer sweep is triggered, increase the attenuation by 10 dB, then reset the EUT (e.g., cycle ac/dc power).
- g) Reset the zero-span trigger of the spectrum analyzer, then repeat 7.11.2f) twice to ensure that the spectrum analyzer is reliably triggered, resetting the EUT (e.g., cycle ac/dc power) after each oscillation event if necessary.
- h) Reset the zero-span sweep trigger of the spectrum analyzer, and reset the EUT (e.g., cycle ac/dc power).
- i) Force the EUT into oscillation by reducing the attenuation.
- j) Use the marker function of the spectrum analyzer to measure the time from the onset of oscillation until the EUT turns off, by setting Marker 1 on the leading edge of the oscillation signal and Marker 2 on the trailing edge. The spectrum analyzer sweep time may be adjusted to improve the time resolution of these cursors.
- k) Capture the spectrum analyzer zero-span trace for inclusion in the test report. Report the power level associated with the oscillation separately if it can't be displayed on the trace.
- l) Repeat 7.11.2b) to 7.11.2k) for all operational uplink and downlink bands.
- m) Set the spectrum analyzer zero-span sweep time for longer than 60 seconds, then measure the restart time for each operational uplink and downlink band.
- n) Replace the normal-operating mode EUT with the EUT that supports an anti-oscillation test mode.
- o) Set the spectrum analyzer zero-span time for a minimum of 120 seconds, and a single sweep.
- p) Manually trigger the spectrum analyzer zero-span sweep, and manually force the booster into oscillation as described in 7.11.2i).

- q) When the sweep is complete, place cursors between the first two oscillation detections, and save the plot for inclusion in the test report. The time between restarts must match the manufacturer's timing for the test mode, and there shall be no more than 5 restarts.
- r) Repeat 7.11.2m) to 7.11.2q) for all operational uplink and downlink bands.

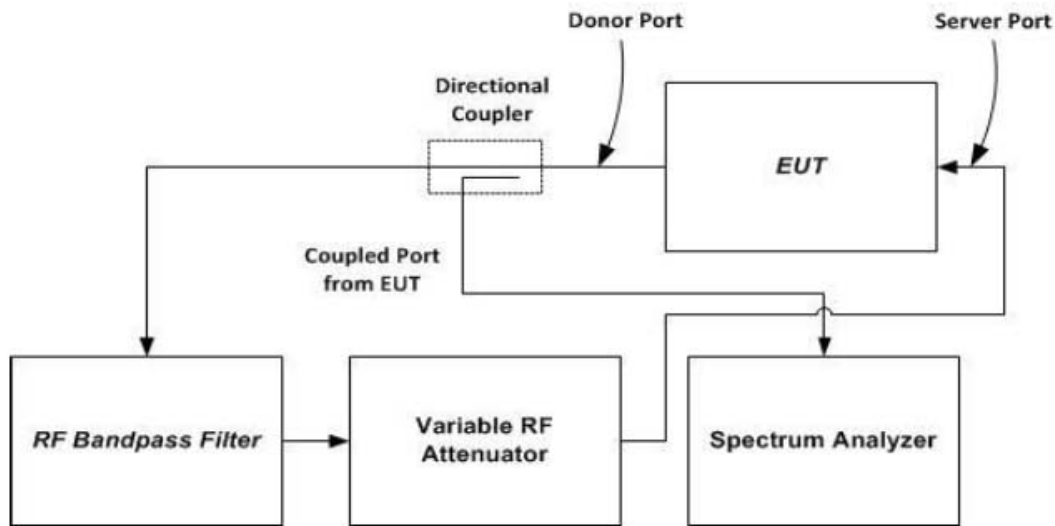

NOTE—This figure shows the test setup for uplink bands transmission path tests; i.e., signal flow is out from the donor port into the directional coupler. For downlink bands transmission path tests, the feedback signal flow path direction and equipment connections shall be reversed, i.e., signal flow is out from the server port into the directional coupler, and signal flow is into the donor port from the variable RF attenuator.

Figure 7 – Oscillation detection (7.11.2) test setup

Test procedure for measuring oscillation mitigation or shutdown

- a) Connect the normal-operating mode EUT to the test equipment as shown in **Figure 8**.
- b) Set the spectrum analyzer center frequency to the center of band under test, and use the following settings:
- 1) RBW=30 kHz, VBW $\geq 3 \times$ RBW,
 - 2) power averaging (rms) detector,
 - 3) trace averages ≥ 100 ,
 - 4) span $\geq 120\%$ of operational band under test,
 - 5) number of sweep points $\geq 2 \times$ Span/RBW.

NOTE—To measure 120% of the band under test in one span with spectrum analyzers having less than the required number of sweep points: Perform pretests with span equal to smaller band segments, such that 120% of the operational band is captured in multiple tests, using the setup parameters specified; record the center frequency of the strongest oscillation level occurring, and affirm this frequency is within the span and band segment used in this test.

- c) Configure the signal generator for AWGN operation with a 99% OBW of 4.1 MHz, tuned to the frequency of 2.5 MHz above the lower edge or below the upper edge of the operating band under test. Adjust the RF output level of the signal generator such that the measured power level of the AWGN signal at the output port of the booster is 30 dB less than the maximum power of the booster for the band under test. Affirm that the input signal is not obstructing the measurement of the strongest oscillation peak in the band, and is not included within the span in the measurement.
- 1) Boosters with operating spectrum passbands of 10 MHz or less may use a CW signal source at the band edge rather than AWGN.
 - 2) For device passbands greater than 10 MHz, standard CMRS signal sources (i.e., CDMA, W-CDMA, LTE) may be used instead of AWGN at the band edge.

- d) Set the variable attenuator to a high attenuation setting such that the booster will operate at maximum gain when powered on. Reset the EUT (e.g., cycle ac/dc power). Allow the EUT to complete its boot-up process, to reach full operational gain, and to stabilize its operation.
- e) Set the variable attenuator such that the insertion loss for the center of the band under test (isolation) between the booster donor port and server port is 5 dB greater than the maximum gain, as recorded in the maximum gain test procedure (see 7.3), for the band under test.
- f) Verify the EUT shuts down, i.e., to mitigate the oscillations. If the booster does not shut down, measure and verify the peak oscillation level as follows.
 - 1) Allow the spectrum analyzer trace to stabilize.
 - 2) Place the marker at the highest oscillation level occurring within the span, and record its output level and frequency.
 - 3) Set the spectrum analyzer center frequency to the frequency with the highest oscillation signal level, and reduce the span such that the upper and lower adjacent oscillation peaks are within the span.
 - 4) Use the Minimum Search Marker function to find the lowest output level that is within the span, and within the operational band under test, and record its output level and frequency.
 - 5) Affirm that the peak oscillation level measured in 7.11.3f2), does not exceed by 12.0 dB the minimal output level measured in 7.11.3f4). Record the measurement results of 7.11.3f2) and 7.11.3f4) in tabular format for inclusion in the test report.
 - 6) The procedure of 7.11.3f1) to 7.11.3.f5) allows the spectrum analyzer trace to stabilize, and verification of shutdown or oscillation level measurement must occur within 300 seconds.20
- g) Decrease the variable attenuator in 1 dB steps, and repeat step 7.11.3f) for each 1 dB step. Continue testing to the level when the insertion loss for the center of band under test (isolation) between the booster donor port and server port is 5 dB lower than the maximum gain (see 7.3).
- h) Repeat 7.11.3a) to 7.11.3g) for all operational uplink and downlink bands.

Test Data

Test Result: Compliance. Please refer to following table.

Oscillation Restart Time:

Mode	Operation Bands	Detection Time (s)		Power level dBm	Between restart time (s)		Number of restart		Result		
		Reading	Limit		Reading	Limit	Reading	Limit			
Uplink	Lower 700MHz	0.159	≤0.3	4.89	≥60	65.207	2	≤5	Compliance		
	Upper 700MHz	0.167		2.39					65.384	2	Compliance
	Cellular	0.159		5.82					65.087	2	Compliance
	AWS	0.159		1.43					65.217	2	Compliance
	PCS	0.167		-1.53					65.101	2	Compliance
Downlink	Lower 700MHz	0.159	≤1	-1.82	≥60	85.217	2	≤5	Compliance		
	Upper 700MHz	0.174		-0.07					85.507	2	Compliance
	Cellular	0.159		-5.94					65.087	2	Compliance
	AWS	0.174		-8.86					65.196	2	Compliance
	PCS	0.174		-13.39					65.391	2	Compliance

Lower 700M-Uplink

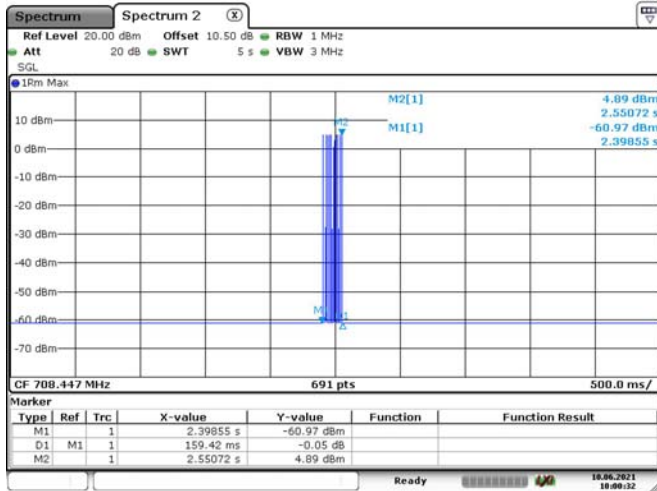

Date: 10 JUN 2021 10:00:33

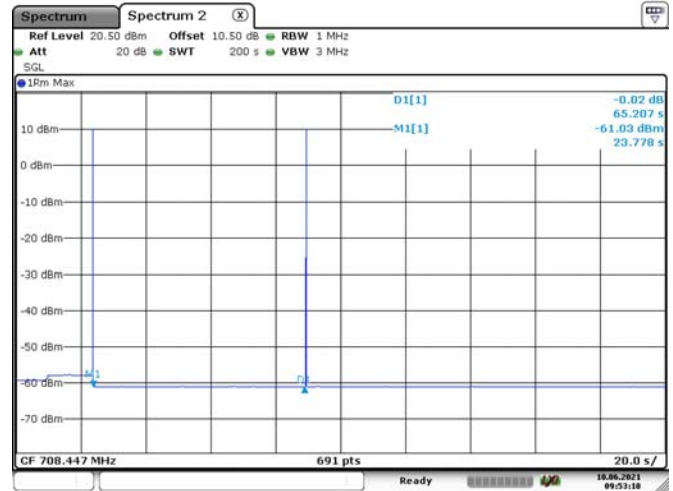

Date: 10 JUN 2021 09:53:11

Upper 700M-Uplink

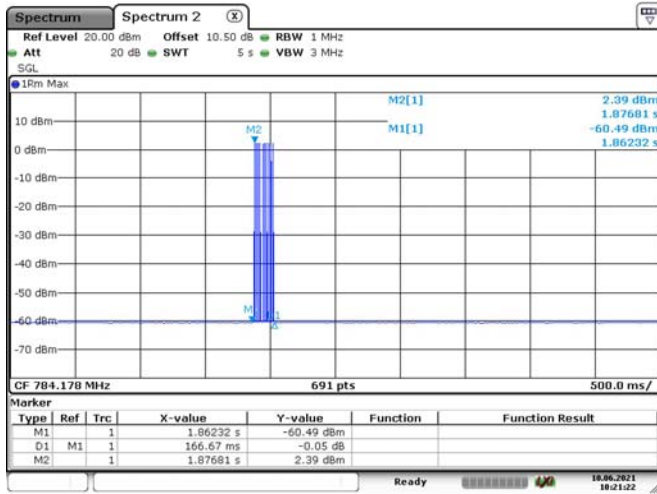

Date: 10 JUN 2021 10:21:23

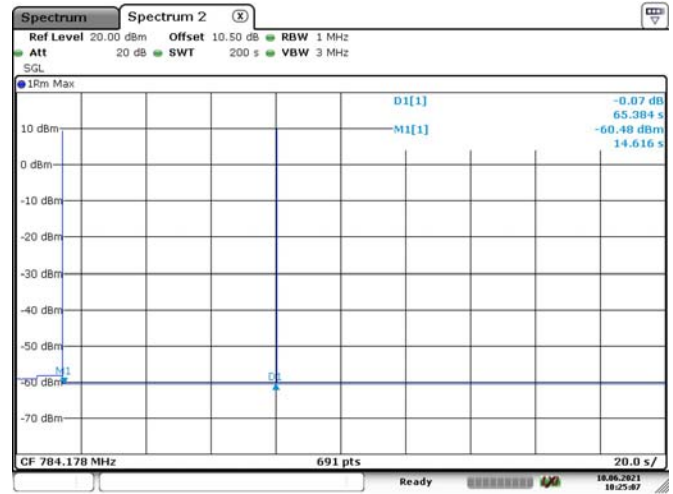

Date: 10 JUN 2021 10:25:07

Cellular-Uplink

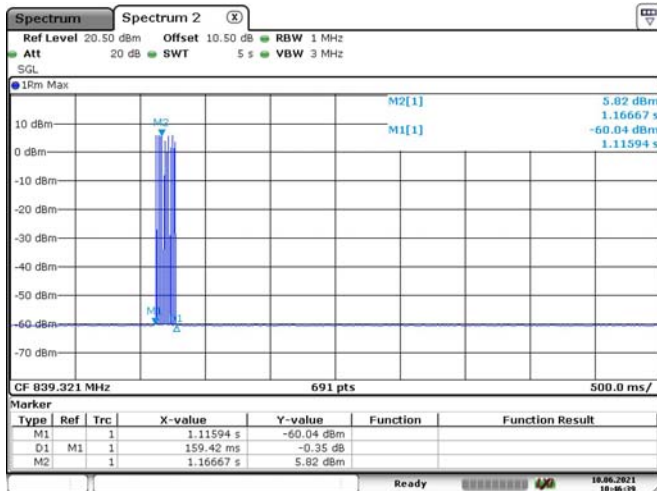

Date: 10 JUN 2021 10:46:40

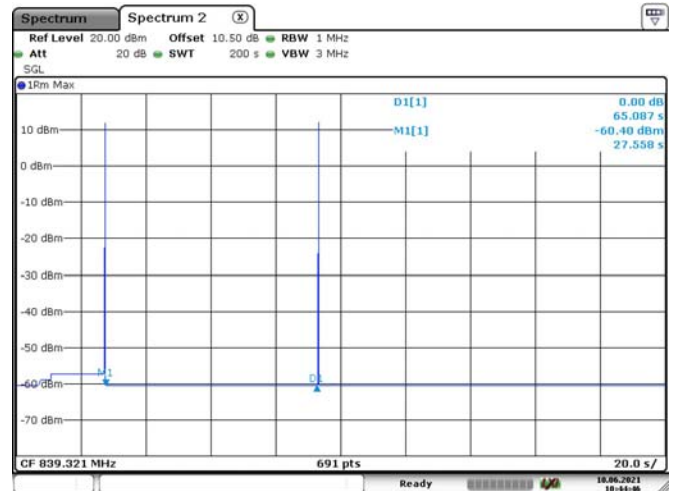

Date: 10 JUN 2021 10:44:46

AWS-Uplink

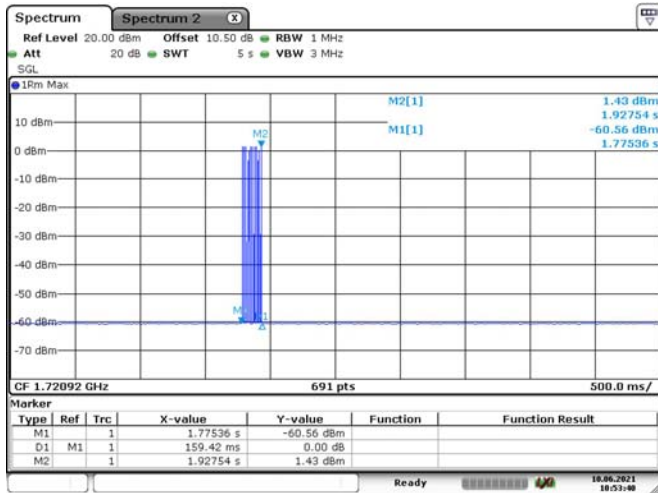

Date: 10 JUN 2021 10:53:40

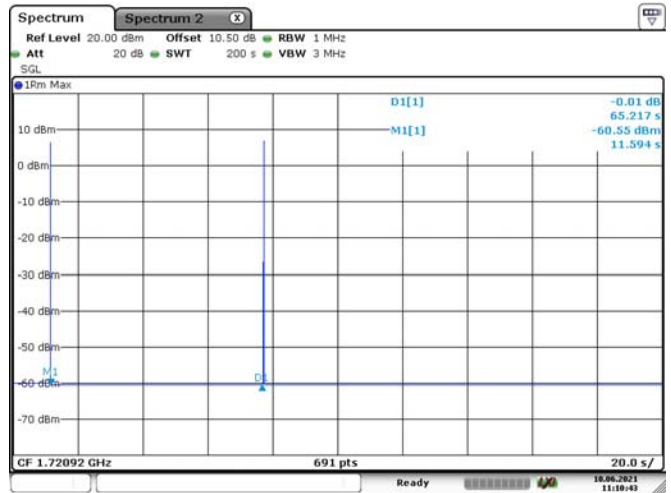

Date: 10 JUN 2021 11:10:44

PCS-Uplink

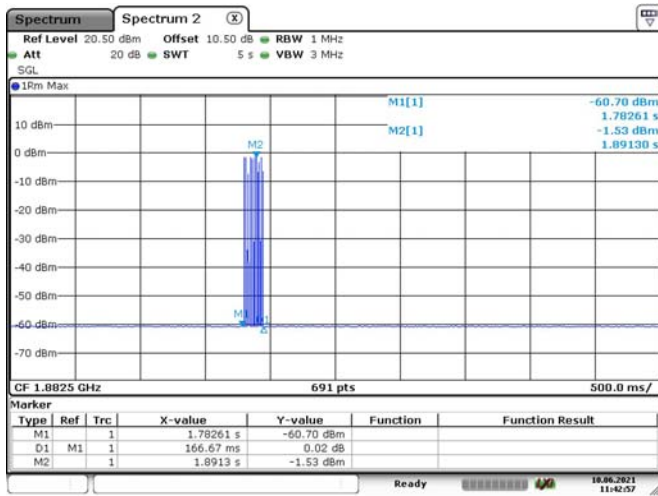

Date: 10 JUN 2021 11:42:57

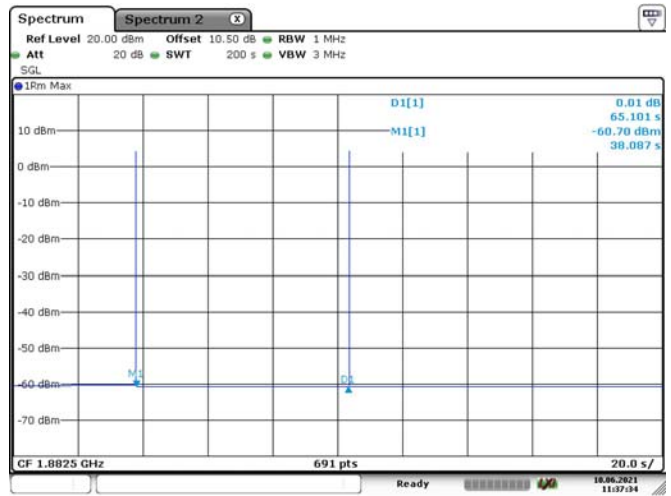

Date: 10 JUN 2021 11:37:34

Lower 700M-Downlink

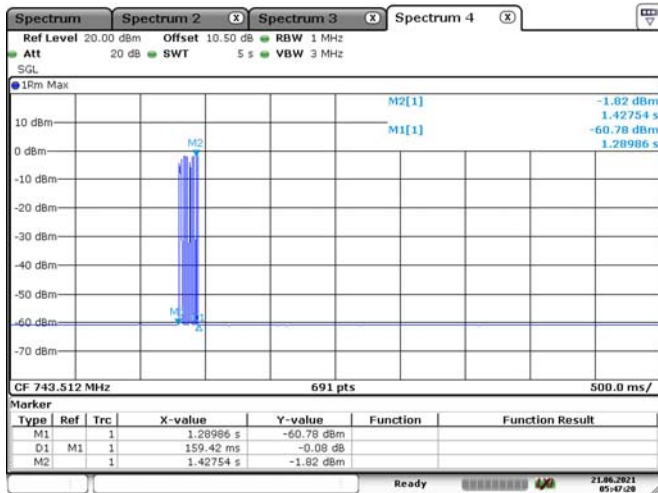

Date: 21 JUN 2021 05:47:21

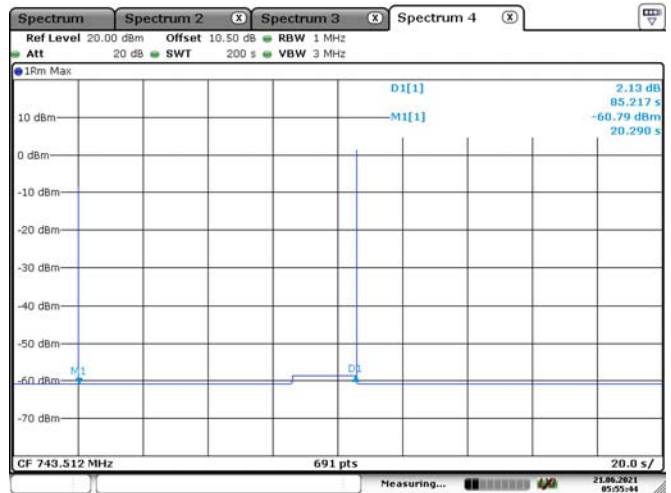

Date: 21 JUN 2021 05:55:44

Upper 700M-Downlink

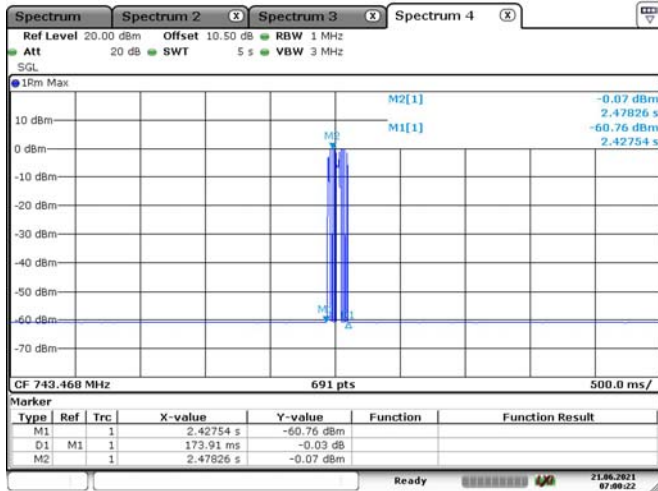

Date: 21 JUN 2021 07:00:23

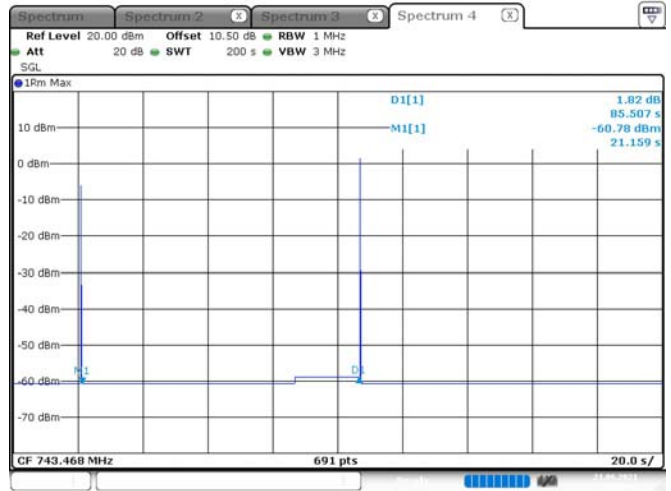

Date: 21 JUN 2021 07:07:49

Cellular-Downlink

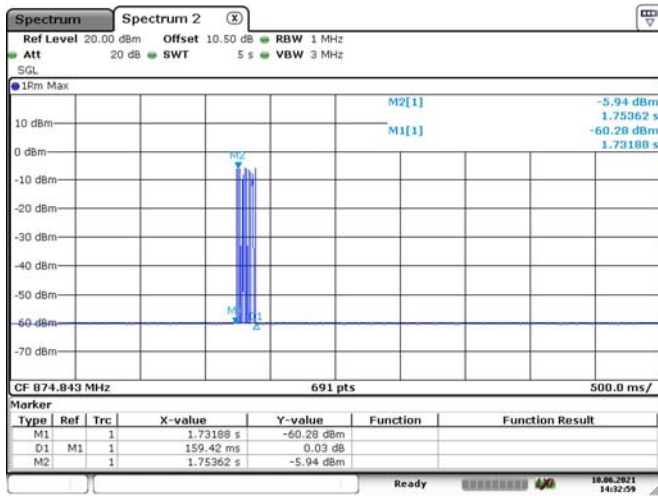

Date: 10 JUN 2021 14:33:00

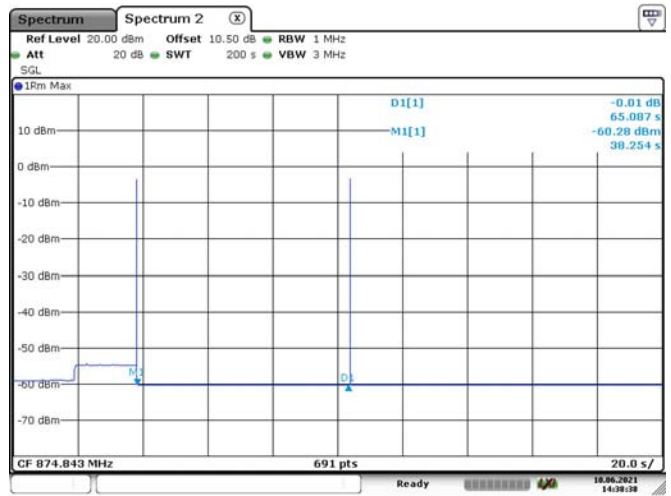

Date: 10 JUN 2021 14:38:38

AWS-Downlink

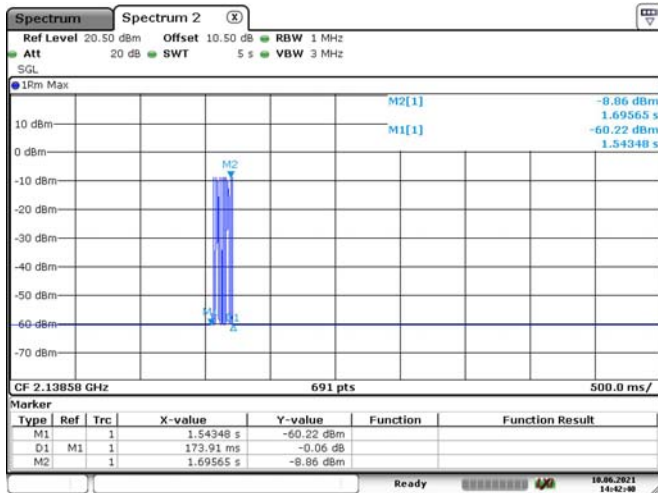

Date: 10 JUN 2021 14:42:40

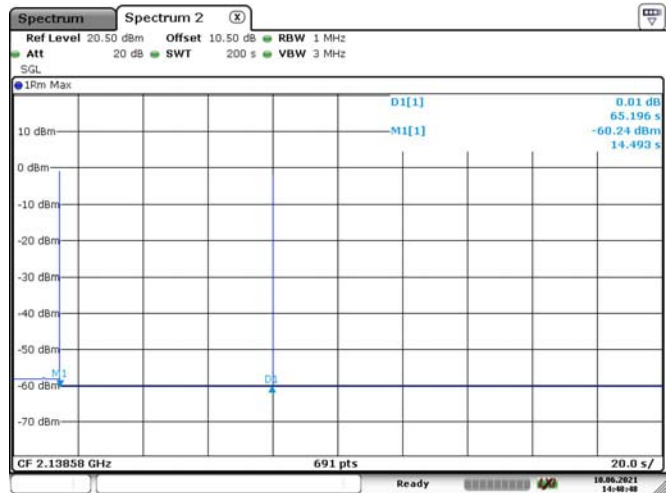

Date: 10 JUN 2021 14:48:48

PCS-Downlink

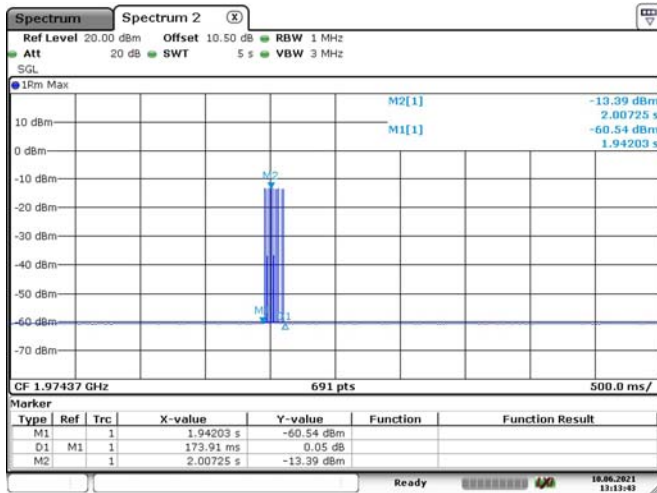

Date: 10.JUN.2021 13:13:44

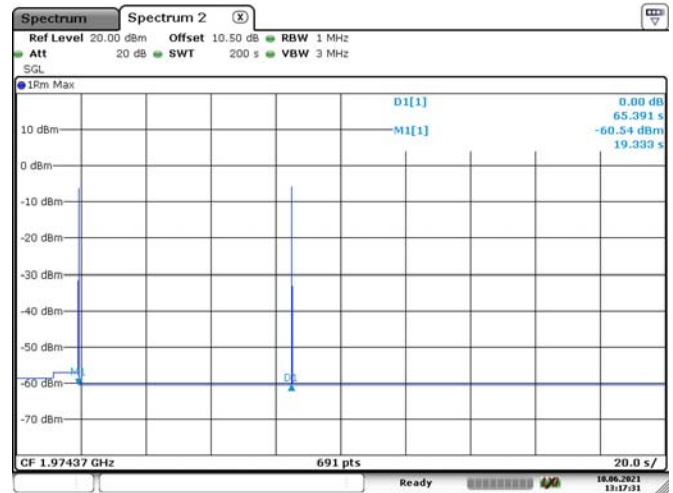

Date: 10.JUN.2021 13:17:31

Oscillation Mitigation or Shutdown:

Mode	Operation Band	Max gain dB	Isolation dB	Difference dB	Limit dB	Result
Uplink	Lower 700MHz	36.71	+5	11.70	12	Compliance
			+4	/	12	Compliance
			+3	/	12	Compliance
			+2	/	12	Compliance
			+1	/	12	Compliance
			+0	/	12	Compliance
			-1	/	12	Compliance
			-2	/	12	Compliance
			-3	/	12	Compliance
			-4	/	12	Compliance
	-5	/	12	Compliance		
	Upper 700MHz	37.01	+5	10.43	12	Compliance
			+4	10.07	12	Compliance
			+3	11.78	12	Compliance
			+2	/	12	Compliance
			+1	/	12	Compliance
			+0	/	12	Compliance
			-1	/	12	Compliance
			-2	/	12	Compliance
			-3	/	12	Compliance
			-4	/	12	Compliance
	-5	/	12	Compliance		
	Cellular	40.13	+5	9.39	12	Compliance
			+4	9.24	12	Compliance
			+3	10.53	12	Compliance
			+2	10.72	12	Compliance
			+1	/	12	Compliance
+0			/	12	Compliance	
-1			/	12	Compliance	
-2	/	12	Compliance			
-3	/	12	Compliance			
-4	/	12	Compliance			
-5	/	12	Compliance			

Mode	Operation Band	Max gain	Isolation	Difference	Limit	Result
		dB	dB	dB	dB	
Uplink	AWS	35.48	+5	10.37	12	Compliance
			+4	10.96	12	Compliance
			+3	11.87	12	Compliance
			+2	/	12	Compliance
			+1	/	12	Compliance
			+0	/	12	Compliance
			-1	/	12	Compliance
			-2	/	12	Compliance
			-3	/	12	Compliance
			-4	/	12	Compliance
	-5	/	12	Compliance		
	PCS	34.81	+5	10.23	12	Compliance
			+4	/	12	Compliance
			+3	/	12	Compliance
			+2	/	12	Compliance
			+1	/	12	Compliance
			+0	/	12	Compliance
			-1	/	12	Compliance
			-2	/	12	Compliance
			-3	/	12	Compliance
-4			/	12	Compliance	
-5	/	12	Compliance			
Downlink	Lower 700MHz	40.84	+5	11.17	12	Compliance
			+4	/	12	Compliance
			+3	/	12	Compliance
			+2	/	12	Compliance
			+1	/	12	Compliance
			+0	/	12	Compliance
			-1	/	12	Compliance
			-2	/	12	Compliance
			-3	/	12	Compliance
			-4	/	12	Compliance
	-5	/	12	Compliance		
	Upper 700MHz	39.86	+5	11.36	12	Compliance
			+4	/	12	Compliance
			+3	/	12	Compliance
			+2	/	12	Compliance
			+1	/	12	Compliance
			+0	/	12	Compliance
			-1	/	12	Compliance
			-2	/	12	Compliance
			-3	/	12	Compliance
			-4	/	12	Compliance
	-5	/	12	Compliance		
	Cellular	42.44	+5	11.26	12	Compliance
			+4	11.38	12	Compliance
			+3	10.54	12	Compliance
			+2	/	12	Compliance
			+1	/	12	Compliance
			+0	/	12	Compliance
			-1	/	12	Compliance
			-2	/	12	Compliance
-3			/	12	Compliance	
-4			/	12	Compliance	
-5	/	12	Compliance			

Mode	Operation Band	Max gain	Isolation	Difference	Limit	Result
		dB	dB	dB	dB	
Downlink	AWS	41.24	+5	9.88	12	Compliance
			+4	10.38	12	Compliance
			+3	/	12	Compliance
			+2	/	12	Compliance
			+1	/	12	Compliance
			+0	/	12	Compliance
			-1	/	12	Compliance
			-2	/	12	Compliance
			-3	/	12	Compliance
			-4	/	12	Compliance
	-5	/	12	Compliance		
	PCS	41.10	+5	10.70	12	Compliance
			+4	11.33	12	Compliance
			+3	/	12	Compliance
			+2	/	12	Compliance
			+1	/	12	Compliance
			+0	/	12	Compliance
			-1	/	12	Compliance
			-2	/	12	Compliance
			-3	/	12	Compliance
-4			/	12	Compliance	
-5	/	12	Compliance			

Note: "/" means that booster is shut down.

12 - RADIATED SPURIOUS EMISSIONS

Applicable Standards

According to § 2.1053 *Measurements required: Field strength of spurious radiation.*

Test Procedure

This procedure is intended to satisfy the requirements specified in Section 2.1053. The applicable limits are those specified for mobile station emissions in the rule part appropriate to the band of operation (see Appendix A).

Separate compliance requirements are applicable for any digital device circuitry that controls additional functions or capabilities and that is not used only to enable operation of the transmitter in a booster device [i.e., Section 15.3(k) digital device definition]. Separate compliance requirements are applicable for any receiver components/functions that tune within 30 MHz to 960 MHz contained in booster devices [Section 15.101(b)].

- a) Place the EUT on an OATS or semi-anechoic chamber turntable 3 m from the receiving antenna.
- b) Connect the EUT to the test equipment as shown in **Figure 10** beginning with the uplink output (donor) port.
- c) Set the signal generator to produce a CW signal with the frequency set to the center of the operational band under test, and the power level set at PIN as determined from measurement results per 7.2.
- d) Measure the radiated spurious emissions from the EUT from the lowest to the highest frequencies as specified in Section 2.1057. Maximize the radiated emissions by using the procedures described in ANSI C63.26.
- e) Capture the peak emissions plots using a peak detector with Max-Hold for inclusion in the test report. Tabular data is acceptable in lieu of spectrum analyzer plots.
- f) Repeat 7.12c) through 7.12e) for all uplink and downlink operational bands.

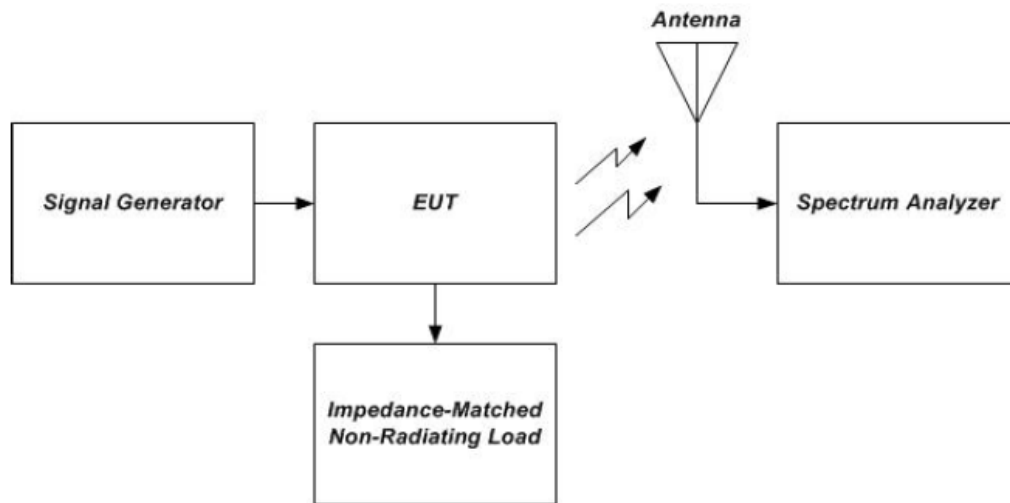

Figure 10 – Radiated spurious emissions test instrumentation setup

Test Data

Test Result: Compliance. Please refer to following tables.

Uplink:

Frequency (MHz)	Polar (H / V)	Receiver Reading (dBμV)	Substituted Method			Absolute Level (dBm)	Limit (dBm)	Margin (dB)
			Substituted Level (dBm)	Antenna Gain (dBd/dBi)	Cable Loss (dB)			
Lower 700MHz Band, Test Frequency 698.2MHz								
216.33	H	44.39	-64.45	0.00	0.49	-64.94	-19.00	45.94
87.69	V	59.58	-54.49	0.00	0.36	-54.85	-19.00	35.85
1396.40	H	37.36	-67.08	9.56	1.22	-58.74	-19.00	39.74
1396.40	V	36.40	-68.13	9.56	1.22	-59.79	-19.00	40.79
2094.60	H	36.02	-68.52	11.63	1.15	-58.04	-19.00	39.04
2094.60	V	35.73	-69.03	11.63	1.15	-58.55	-19.00	39.55
2792.80	H	35.96	-67.18	12.32	1.39	-56.25	-19.00	37.25
2792.80	V	37.16	-66.50	12.32	1.39	-55.57	-19.00	36.57
3491.00	H	36.48	-65.45	12.20	1.61	-54.86	-19.00	35.86
3491.00	V	37.24	-63.21	12.20	1.61	-52.62	-19.00	33.62
Lower 700MHz Band, Test Frequency 707 MHz								
262.47	H	52.66	-56.43	0.00	0.51	-56.94	-19.00	37.94
47.38	V	62.59	-34.50	-17.47	0.21	-52.18	-19.00	33.18
1414.00	H	36.36	-68.20	9.64	1.25	-59.81	-19.00	40.81
1414.00	V	36.64	-67.99	9.64	1.25	-59.60	-19.00	40.60
2121.00	H	36.19	-68.29	11.67	1.16	-57.78	-19.00	38.78
2121.00	V	37.07	-67.71	11.67	1.16	-57.20	-19.00	38.20
2828.00	H	37.00	-66.08	12.33	1.41	-55.16	-19.00	36.16
2828.00	V	36.24	-67.26	12.33	1.41	-56.34	-19.00	37.34
3535.00	H	36.50	-65.30	12.21	1.60	-54.69	-19.00	35.69
3535.00	V	36.77	-63.69	12.21	1.60	-53.08	-19.00	34.08
Lower 700MHz Band, Test Frequency 715.8 MHz								
102.33	H	51.62	-54.40	0.00	0.27	-54.67	-19.00	35.67
89.11	V	52.87	-60.49	0.00	0.36	-60.85	-19.00	41.85
1431.60	H	36.45	-68.23	9.71	1.27	-59.79	-19.00	40.79
1431.60	V	37.62	-67.10	9.71	1.27	-58.66	-19.00	39.66
2147.40	H	36.33	-68.10	11.71	1.16	-57.55	-19.00	38.55
2147.40	V	36.24	-68.56	11.71	1.16	-58.01	-19.00	39.01
2863.20	H	35.36	-67.66	12.35	1.43	-56.74	-19.00	37.74
2863.20	V	35.65	-67.68	12.35	1.43	-56.76	-19.00	37.76
3579.00	H	37.58	-64.09	12.22	1.58	-53.45	-19.00	34.45
3579.00	V	36.82	-63.71	12.22	1.58	-53.07	-19.00	34.07
Upper 700MHz Band, Test Frequency 776.2MHz								
251.36	H	47.02	-62.20	0.00	0.51	-62.71	-19.00	43.71
112.38	V	59.67	-51.78	0.00	0.29	-52.07	-19.00	33.07
1552.40	H	36.67	-68.45	10.16	1.33	-59.62	-19.00	40.62
1552.40	V	37.22	-67.83	10.16	1.33	-59.00	-19.00	40.00
2328.60	H	37.03	-67.00	11.96	1.20	-56.24	-19.00	37.24
2328.60	V	36.28	-68.66	11.96	1.20	-57.90	-19.00	38.90
3104.80	H	36.35	-66.25	12.36	1.52	-55.41	-19.00	36.41
3104.80	V	36.62	-65.58	12.36	1.52	-54.74	-19.00	35.74
3881.00	H	36.15	-64.58	12.28	1.49	-53.79	-19.00	34.79
3881.00	V	35.46	-65.53	12.28	1.49	-54.74	-19.00	35.74
Upper 700MHz Band, Test Frequency 781.5 MHz								
261.75	H	45.27	-63.83	0.00	0.51	-64.34	-19.00	45.34
93.85	V	61.35	-51.59	0.00	0.32	-51.91	-19.00	32.91
1563.00	H	37.08	-68.03	10.19	1.32	-59.16	-19.00	40.16
1563.00	V	36.33	-68.71	10.19	1.32	-59.84	-19.00	40.84
2344.50	H	36.48	-67.51	11.98	1.21	-56.74	-19.00	37.74
2344.50	V	36.75	-68.20	11.98	1.21	-57.43	-19.00	38.43

3126.00	H	36.34	-66.22	12.35	1.53	-55.40	-19.00	36.40
3126.00	V	35.68	-66.42	12.35	1.53	-55.60	-19.00	36.60
3907.50	H	34.76	-65.89	12.28	1.48	-55.09	-19.00	36.09
3907.50	V	35.21	-65.82	12.28	1.48	-55.02	-19.00	36.02
Upper 700MHz Band, Test Frequency 786.8 MHz								
183.69	H	46.73	-62.83	0.00	0.45	-63.28	-19.00	44.28
98.60	V	53.62	-59.36	0.00	0.27	-59.63	-19.00	40.63
1573.60	H	37.09	-68.01	10.22	1.32	-59.11	-19.00	40.11
1573.60	V	36.26	-68.77	10.22	1.32	-59.87	-19.00	40.87
2360.40	H	36.54	-67.42	12.00	1.21	-56.63	-19.00	37.63
2360.40	V	36.28	-68.68	12.00	1.21	-57.89	-19.00	38.89
3147.20	H	36.53	-65.99	12.34	1.53	-55.18	-19.00	36.18
3147.20	V	35.65	-66.35	12.34	1.53	-55.54	-19.00	36.54
3934.00	H	34.68	-65.88	12.29	1.47	-55.06	-19.00	36.06
3934.00	V	34.57	-66.50	12.29	1.47	-55.68	-19.00	36.68
Cellular Band, Test Frequency 824.2MHz								
315.36	H	48.25	-59.80	0.00	0.53	-60.33	-19.00	41.33
105.28	V	56.15	-56.18	0.00	0.27	-56.45	-19.00	37.45
1648.40	H	37.22	-67.82	10.45	1.28	-58.65	-19.00	39.65
1648.40	V	36.58	-68.39	10.45	1.28	-59.22	-19.00	40.22
2472.60	H	36.47	-67.24	12.16	1.23	-56.31	-19.00	37.31
2472.60	V	36.66	-68.39	12.16	1.23	-57.46	-19.00	38.46
3296.80	H	36.28	-65.98	12.28	1.57	-55.27	-19.00	36.27
3296.80	V	35.49	-65.84	12.28	1.57	-55.13	-19.00	36.13
4121.00	H	34.72	-65.35	12.57	1.47	-54.25	-19.00	35.25
4121.00	V	34.99	-65.78	12.57	1.47	-54.68	-19.00	35.68
Cellular Band, Test Frequency 836.5 MHz								
88.23	H	48.70	-62.76	0.00	0.36	-63.12	-19.00	44.12
68.25	V	54.16	-58.44	-5.93	0.24	-64.61	-19.00	45.61
1673.00	H	37.19	-67.83	10.52	1.27	-58.58	-19.00	39.58
1673.00	V	36.36	-68.59	10.52	1.27	-59.34	-19.00	40.34
2509.50	H	36.48	-67.15	12.20	1.24	-56.19	-19.00	37.19
2509.50	V	36.79	-68.23	12.20	1.24	-57.27	-19.00	38.27
3346.00	H	36.27	-65.91	12.26	1.58	-55.23	-19.00	36.23
3346.00	V	35.48	-65.63	12.26	1.58	-54.95	-19.00	35.95
4182.50	H	34.49	-65.43	12.70	1.48	-54.21	-19.00	35.21
4182.50	V	35.23	-65.33	12.70	1.48	-54.11	-19.00	35.11
Cellular Band, Test Frequency 848.8 MHz								
362.30	H	31.25	-75.00	0.00	0.58	-75.58	-19.00	56.58
198.36	V	49.65	-60.96	0.00	0.49	-61.45	-19.00	42.45
1697.60	H	37.18	-67.82	10.59	1.26	-58.49	-19.00	39.49
1697.60	V	36.36	-68.57	10.59	1.26	-59.24	-19.00	40.24
2546.40	H	36.42	-67.15	12.22	1.26	-56.19	-19.00	37.19
2546.40	V	36.73	-68.12	12.22	1.26	-57.16	-19.00	38.16
3395.20	H	36.27	-65.82	12.24	1.59	-55.17	-19.00	36.17
3395.20	V	35.36	-65.52	12.24	1.59	-54.87	-19.00	35.87
4244.00	H	34.72	-65.05	12.84	1.49	-53.70	-19.00	34.70
4244.00	V	34.86	-65.50	12.84	1.49	-54.15	-19.00	35.15
AWS Band, Test Frequency 1710.2 MHz								
76.92	H	47.59	-67.28	-1.54	0.34	-69.16	-19.00	50.16
98.37	V	55.89	-57.09	0.00	0.28	-57.37	-19.00	38.37
3420.40	H	36.40	-65.65	12.23	1.59	-55.01	-19.00	36.01
3420.40	V	35.54	-65.23	12.23	1.59	-54.59	-19.00	35.59
5130.60	H	36.40	-60.82	12.95	1.39	-49.26	-19.00	30.26
5130.60	V	35.40	-61.69	12.95	1.39	-50.13	-19.00	31.13
6840.80	H	36.70	-56.31	13.62	1.79	-44.48	-19.00	25.48
6840.80	V	35.70	-57.45	13.62	1.79	-45.62	-19.00	26.62
AWS Band, Test Frequency 1732.5 MHz								
267.39	H	43.36	-65.67	0.00	0.51	-66.18	-19.00	47.18
95.46	V	57.28	-55.67	0.00	0.31	-55.98	-19.00	36.98

3465.00	H	35.86	-66.11	12.21	1.60	-55.50	-19.00	36.50
3465.00	V	34.63	-65.94	12.21	1.60	-55.33	-19.00	36.33
5197.50	H	35.72	-61.40	12.92	1.36	-49.84	-19.00	30.84
5197.50	V	34.83	-62.26	12.92	1.36	-50.70	-19.00	31.70
6930.00	H	34.47	-58.23	13.50	1.81	-46.54	-19.00	27.54
6930.00	V	35.51	-57.36	13.50	1.81	-45.67	-19.00	26.67
AWS Band, Test Frequency 1754.8 MHz								
85.65	H	46.77	-66.02	0.00	0.37	-66.39	-19.00	47.39
162.31	V	46.33	-65.99	0.00	0.40	-66.39	-19.00	47.39
3509.60	H	35.75	-66.13	12.20	1.61	-55.54	-19.00	36.54
3509.60	V	34.89	-65.53	12.20	1.61	-54.94	-19.00	35.94
5264.40	H	35.68	-61.34	12.89	1.33	-49.78	-19.00	30.78
5264.40	V	34.77	-62.33	12.89	1.33	-50.77	-19.00	31.77
7019.20	H	34.56	-57.90	13.38	1.81	-46.33	-19.00	27.33
7019.20	V	35.63	-57.05	13.38	1.81	-45.48	-19.00	26.48
PCS Band, Test Frequency 1850.2MHz								
229.39	H	47.82	-61.17	0.00	0.50	-61.67	-19.00	42.67
75.67	V	46.35	-69.75	-2.17	0.32	-72.24	-19.00	53.24
3700.40	H	35.80	-65.49	12.24	1.55	-54.80	-19.00	35.80
3700.40	V	34.77	-65.94	12.24	1.55	-55.25	-19.00	36.25
5550.60	H	35.65	-60.88	12.87	1.26	-49.27	-19.00	30.27
5550.60	V	34.73	-62.19	12.87	1.26	-50.58	-19.00	31.58
7400.80	H	34.48	-58.25	12.92	1.42	-46.75	-19.00	27.75
7400.80	V	35.69	-57.64	12.92	1.42	-46.14	-19.00	27.14
PCS Band, Test Frequency 1882.5MHz								
106.39	H	48.35	-57.08	0.00	0.27	-57.35	-19.00	38.35
64.62	V	58.19	-52.12	-7.85	0.23	-60.20	-19.00	41.20
3765.00	H	36.43	-64.66	12.25	1.53	-53.94	-19.00	34.94
3765.00	V	34.78	-66.03	12.25	1.53	-55.31	-19.00	36.31
5647.50	H	35.52	-60.75	13.01	1.28	-49.02	-19.00	30.02
5647.50	V	34.69	-61.88	13.01	1.28	-50.15	-19.00	31.15
7530.00	H	34.76	-57.98	12.81	1.34	-46.51	-19.00	27.51
7530.00	V	35.51	-57.92	12.81	1.34	-46.45	-19.00	27.45
PCS Band, Test Frequency 1914.8MHz								
81.30	H	48.57	-66.48	0.00	0.38	-66.86	-19.00	47.86
56.40	V	52.65	-52.58	-11.96	0.22	-64.76	-19.00	45.76
3829.60	H	35.53	-65.36	12.27	1.50	-54.59	-19.00	35.59
3829.60	V	34.97	-65.94	12.27	1.50	-55.17	-19.00	36.17
5744.40	H	35.68	-60.33	13.14	1.31	-48.50	-19.00	29.50
5744.40	V	34.73	-61.48	13.14	1.31	-49.65	-19.00	30.65
7659.20	H	34.39	-58.09	12.86	1.44	-46.67	-19.00	27.67
7659.20	V	35.51	-57.62	12.86	1.44	-46.20	-19.00	27.20

Downlink:

Frequency (MHz)	Polar (H / V)	Receiver Reading (dBμV)	Substituted Method			Absolute Level (dBm)	Limit (dBm)	Margin (dB)
			Substituted Level (dBm)	Antenna Gain (dBd/dBi)	Cable Loss (dB)			
Lower 700MHz Band, Test Frequency 728.2MHz								
206.20	H	46.93	-61.78	0.00	0.49	-62.27	-19.00	43.27
89.70	V	58.45	-54.61	0.00	0.36	-54.97	-19.00	35.97
1456.40	H	37.69	-67.17	9.82	1.30	-58.65	-19.00	39.65
1456.40	V	37.55	-67.31	9.82	1.30	-58.79	-19.00	39.79
2184.60	H	36.19	-68.15	11.76	1.17	-57.56	-19.00	38.56
2184.60	V	36.92	-67.91	11.76	1.17	-57.32	-19.00	38.32
2912.80	H	36.65	-66.28	12.37	1.45	-55.36	-19.00	36.36
2912.80	V	36.13	-66.96	12.37	1.45	-56.04	-19.00	37.04
3641.00	H	36.54	-64.93	12.23	1.56	-54.26	-19.00	35.26
3641.00	V	37.36	-63.26	12.23	1.56	-52.59	-19.00	33.59
4369.20	H	36.40	-63.07	13.11	1.52	-51.48	-19.00	32.48
4369.20	V	36.02	-63.92	13.11	1.52	-52.33	-19.00	33.33
5097.40	H	35.73	-61.54	12.96	1.40	-49.98	-19.00	30.98
5097.40	V	35.96	-61.13	12.96	1.40	-49.57	-19.00	30.57
Lower 700MHz Band, Test Frequency 737 MHz								
203.40	H	46.90	-61.78	0.00	0.49	-62.27	-19.00	43.27
49.00	V	61.84	-37.91	-15.88	0.21	-54.00	-19.00	35.00
1474.00	H	37.62	-67.36	9.89	1.32	-58.79	-19.00	39.79
1474.00	V	39.16	-65.79	9.89	1.32	-57.22	-19.00	38.22
2211.00	H	37.46	-66.83	11.80	1.18	-56.21	-19.00	37.21
2211.00	V	36.76	-68.09	11.80	1.18	-57.47	-19.00	38.47
2948.00	H	36.75	-66.12	12.38	1.47	-55.21	-19.00	36.21
2948.00	V	37.40	-65.52	12.38	1.47	-54.61	-19.00	35.61
3685.00	H	36.36	-64.98	12.24	1.55	-54.29	-19.00	35.29
3685.00	V	36.64	-64.05	12.24	1.55	-53.36	-19.00	34.36
4422.00	H	36.19	-63.15	13.23	1.53	-51.45	-19.00	32.45
4422.00	V	37.07	-62.70	13.23	1.53	-51.00	-19.00	32.00
5159.00	H	37.00	-60.18	12.94	1.38	-48.62	-19.00	29.62
5159.00	V	36.24	-60.85	12.94	1.38	-49.29	-19.00	30.29
Lower 700MHz Band, Test Frequency 745.8 MHz								
89.70	H	46.48	-64.22	0.00	0.36	-64.58	-19.00	45.58
91.10	V	57.28	-55.64	0.00	0.35	-55.99	-19.00	36.99
1491.60	H	37.96	-67.14	9.96	1.34	-58.52	-19.00	39.52
1491.60	V	37.43	-67.61	9.96	1.34	-58.99	-19.00	39.99
2237.40	H	36.17	-68.06	11.83	1.18	-57.41	-19.00	38.41
2237.40	V	36.77	-68.10	11.83	1.18	-57.45	-19.00	38.45
2983.20	H	36.52	-66.29	12.39	1.49	-55.39	-19.00	36.39
2983.20	V	36.22	-66.53	12.39	1.49	-55.63	-19.00	36.63
3729.00	H	36.45	-64.75	12.25	1.54	-54.04	-19.00	35.04
3729.00	V	37.62	-63.14	12.25	1.54	-52.43	-19.00	33.43
4474.80	H	36.33	-62.88	13.34	1.54	-51.08	-19.00	32.08
4474.80	V	36.24	-63.35	13.34	1.54	-51.55	-19.00	32.55
5220.60	H	35.36	-61.72	12.91	1.35	-50.16	-19.00	31.16
Upper 700MHz Band, Test Frequency 746.2MHz								
203.40	H	48.08	-60.60	0.00	0.49	-61.09	-19.00	42.09
91.10	V	56.49	-56.43	0.00	0.35	-56.78	-19.00	37.78
1492.40	H	37.43	-67.68	9.97	1.34	-59.05	-19.00	40.05
1492.40	V	39.02	-66.03	9.97	1.34	-57.40	-19.00	38.40
2238.60	H	37.51	-66.72	11.83	1.18	-56.07	-19.00	37.07
2238.60	V	36.64	-68.23	11.83	1.18	-57.58	-19.00	38.58
2984.80	H	36.59	-66.22	12.39	1.49	-55.32	-19.00	36.32
2984.80	V	37.31	-65.43	12.39	1.49	-54.53	-19.00	35.53
3731.00	H	36.62	-64.57	12.25	1.54	-53.86	-19.00	34.86
3731.00	V	36.47	-64.29	12.25	1.54	-53.58	-19.00	34.58

4477.20	H	36.67	-62.54	13.35	1.54	-50.73	-19.00	31.73
4477.20	V	37.22	-62.37	13.35	1.54	-50.56	-19.00	31.56
5223.40	H	37.03	-60.05	12.91	1.35	-48.49	-19.00	29.49
5223.40	V	36.28	-60.81	12.91	1.35	-49.25	-19.00	30.25
Upper 700MHz Band, Test Frequency 751.5 MHz								
202.41	H	47.52	-61.15	0.00	0.49	-61.64	-19.00	42.64
49.00	V	58.36	-41.39	-15.88	0.21	-57.48	-19.00	38.48
1503.00	H	37.54	-67.62	10.01	1.35	-58.96	-19.00	39.96
1503.00	V	39.23	-65.86	10.01	1.35	-57.20	-19.00	38.20
2254.50	H	37.41	-66.78	11.86	1.19	-56.11	-19.00	37.11
2254.50	V	36.68	-68.20	11.86	1.19	-57.53	-19.00	38.53
3006.00	H	36.71	-66.06	12.40	1.50	-55.16	-19.00	36.16
3006.00	V	36.35	-66.29	12.40	1.50	-55.39	-19.00	36.39
3757.50	H	36.58	-64.53	12.25	1.53	-53.81	-19.00	34.81
3757.50	V	36.21	-64.59	12.25	1.53	-53.87	-19.00	34.87
4509.00	H	36.14	-62.98	13.39	1.54	-51.13	-19.00	32.13
4509.00	V	37.15	-62.32	13.39	1.54	-50.47	-19.00	31.47
5260.50	H	37.08	-59.94	12.90	1.34	-48.38	-19.00	29.38
5260.50	V	36.33	-60.77	12.90	1.34	-49.21	-19.00	30.21
Upper 700MHz Band, Test Frequency 756.8 MHz								
198.36	H	47.36	-61.37	0.00	0.49	-61.86	-19.00	42.86
90.68	V	56.39	-56.53	0.00	0.35	-56.88	-19.00	37.88
1513.60	H	37.28	-67.87	10.04	1.34	-59.17	-19.00	40.17
1513.60	V	39.07	-66.01	10.04	1.34	-57.31	-19.00	38.31
2270.40	H	37.41	-66.75	11.88	1.19	-56.06	-19.00	37.06
2270.40	V	36.52	-68.38	11.88	1.19	-57.69	-19.00	38.69
3027.20	H	36.66	-66.07	12.39	1.51	-55.19	-19.00	36.19
3027.20	V	37.15	-65.40	12.39	1.51	-54.52	-19.00	35.52
3784.00	H	36.58	-64.45	12.26	1.52	-53.71	-19.00	34.71
3784.00	V	36.71	-64.13	12.26	1.52	-53.39	-19.00	34.39
4540.80	H	36.62	-62.39	13.37	1.53	-50.55	-19.00	31.55
4540.80	V	37.27	-62.04	13.37	1.53	-50.20	-19.00	31.20
5297.60	H	37.09	-59.88	12.88	1.32	-48.32	-19.00	29.32
5297.60	V	36.26	-60.84	12.88	1.32	-49.28	-19.00	30.28
Cellular Band, Test Frequency 869.2MHz								
206.20	H	47.74	-60.97	0.00	0.49	-61.46	-19.00	42.46
92.36	V	57.66	-55.27	0.00	0.34	-55.61	-19.00	36.61
1738.40	H	37.41	-67.55	10.72	1.25	-58.08	-19.00	39.08
1738.40	V	39.24	-65.66	10.72	1.25	-56.19	-19.00	37.19
2607.60	H	37.43	-66.03	12.24	1.30	-55.09	-19.00	36.09
2607.60	V	36.51	-68.04	12.24	1.30	-57.10	-19.00	38.10
3476.80	H	36.53	-65.42	12.21	1.60	-54.81	-19.00	35.81
3476.80	V	37.24	-63.27	12.21	1.60	-52.66	-19.00	33.66
4346.00	H	36.61	-62.91	13.06	1.51	-51.36	-19.00	32.36
4346.00	V	36.43	-63.59	13.06	1.51	-52.04	-19.00	33.04
5215.20	H	36.28	-60.81	12.91	1.35	-49.25	-19.00	30.25
5215.20	V	37.34	-59.75	12.91	1.35	-48.19	-19.00	29.19
Cellular Band, Test Frequency 881.5 MHz								
86.90	H	47.08	-65.07	0.00	0.37	-65.44	-19.00	46.44
50.40	V	57.49	-44.14	-14.72	0.21	-59.07	-19.00	40.07
1763.00	H	37.67	-67.27	10.79	1.23	-57.71	-19.00	38.71
1763.00	V	39.43	-65.45	10.79	1.23	-55.89	-19.00	36.89
2644.50	H	37.52	-65.88	12.26	1.32	-54.94	-19.00	35.94
2644.50	V	36.71	-67.67	12.26	1.32	-56.73	-19.00	37.73
3526.00	H	36.52	-65.31	12.21	1.60	-54.70	-19.00	35.70
3526.00	V	37.30	-63.15	12.21	1.60	-52.54	-19.00	33.54
4407.50	H	36.44	-62.93	13.20	1.52	-51.25	-19.00	32.25
4407.50	V	36.53	-63.29	13.20	1.52	-51.61	-19.00	32.61
5289.00	H	36.26	-60.72	12.88	1.32	-49.16	-19.00	30.16
5289.00	V	37.16	-59.94	12.88	1.32	-48.38	-19.00	29.38

Cellular Band, Test Frequency 893.8 MHz								
53.20	H	45.02	-60.54	-13.43	0.22	-74.19	-19.00	55.19
51.33	V	57.26	-44.93	-14.29	0.21	-59.43	-19.00	40.43
1787.60	H	37.48	-67.44	10.86	1.22	-57.80	-19.00	38.80
1787.60	V	39.31	-65.55	10.86	1.22	-55.91	-19.00	36.91
2681.40	H	37.51	-65.82	12.27	1.33	-54.88	-19.00	35.88
2681.40	V	36.68	-67.52	12.27	1.33	-56.58	-19.00	37.58
3575.20	H	36.73	-64.95	12.22	1.59	-54.32	-19.00	35.32
3575.20	V	37.33	-63.19	12.22	1.59	-52.56	-19.00	33.56
4469.00	H	36.62	-62.61	13.33	1.53	-50.81	-19.00	31.81
4469.00	V	36.55	-63.06	13.33	1.53	-51.26	-19.00	32.26
5362.80	H	36.27	-60.60	12.85	1.29	-49.04	-19.00	30.04
5362.80	V	37.06	-60.04	12.85	1.29	-48.48	-19.00	29.48
AWS Band, Test Frequency 2110.2 MHz								
86.90	H	47.02	-65.13	0.00	0.37	-65.50	-19.00	46.50
88.63	V	58.15	-55.45	0.00	0.36	-55.81	-19.00	36.81
4220.40	H	35.94	-63.89	12.78	1.49	-52.60	-19.00	33.60
4220.40	V	34.59	-65.85	12.78	1.49	-54.56	-19.00	35.56
6330.60	H	35.67	-58.92	13.90	1.59	-46.61	-19.00	27.61
6330.60	V	34.46	-60.11	13.90	1.59	-47.80	-19.00	28.80
8440.80	H	34.33	-57.07	12.74	1.90	-46.23	-19.00	27.23
8440.80	V	35.34	-56.65	12.74	1.90	-45.81	-19.00	26.81
AWS Band, Test Frequency 2132.5 MHz								
205.40	H	46.33	-62.37	0.00	0.49	-62.86	-19.00	43.86
93.66	V	58.39	-54.55	0.00	0.32	-54.87	-19.00	35.87
4265.00	H	35.88	-63.84	12.88	1.50	-52.46	-19.00	33.46
4265.00	V	34.76	-65.53	12.88	1.50	-54.15	-19.00	35.15
6397.50	H	35.66	-58.78	13.98	1.63	-46.43	-19.00	27.43
6397.50	V	34.52	-59.91	13.98	1.63	-47.56	-19.00	28.56
8530.00	H	34.36	-56.95	12.70	1.92	-46.17	-19.00	27.17
8530.00	V	35.27	-56.68	12.70	1.92	-45.90	-19.00	26.90
AWS Band, Test Frequency 2154.8 MHz								
58.80	H	43.88	-63.07	-10.85	0.23	-74.15	-19.00	55.15
164.10	V	43.26	-69.05	0.00	0.41	-69.46	-19.00	50.46
4309.60	H	36.02	-63.59	12.98	1.51	-52.12	-19.00	33.12
4309.60	V	34.63	-65.51	12.98	1.51	-54.04	-19.00	35.04
6464.40	H	35.37	-58.92	14.06	1.67	-46.53	-19.00	27.53
6464.40	V	34.55	-59.74	14.06	1.67	-47.35	-19.00	28.35
8619.20	H	34.69	-56.51	12.70	1.89	-45.70	-19.00	26.70
8619.20	V	35.67	-56.32	12.70	1.89	-45.51	-19.00	26.51
PCS Band, Test Frequency 1930.2MHz								
217.33	H	49.56	-59.29	0.00	0.50	-59.79	-19.00	40.79
85.32	V	51.31	-63.95	0.00	0.37	-64.32	-19.00	45.32
3860.40	H	35.89	-64.90	12.27	1.49	-54.12	-19.00	35.12
3860.40	V	34.55	-66.41	12.27	1.49	-55.63	-19.00	36.63
5790.60	H	35.67	-60.22	13.21	1.33	-48.34	-19.00	29.34
5790.60	V	34.63	-61.41	13.21	1.33	-49.53	-19.00	30.53
7720.80	H	34.75	-57.60	12.89	1.48	-46.19	-19.00	27.19
7720.80	V	35.88	-57.11	12.89	1.48	-45.70	-19.00	26.70
PCS Band, Test Frequency 1962.5MHz								
95.35	H	46.33	-61.97	0.00	0.31	-62.28	-19.00	43.28
56.39	V	56.28	-48.94	-11.96	0.22	-61.12	-19.00	42.12
3925.00	H	35.76	-64.83	12.29	1.47	-54.01	-19.00	35.01
3925.00	V	34.89	-66.17	12.29	1.47	-55.35	-19.00	36.35
5887.50	H	35.77	-59.86	13.34	1.36	-47.88	-19.00	28.88
5887.50	V	34.69	-60.99	13.34	1.36	-49.01	-19.00	30.01
7850.00	H	34.27	-57.82	12.94	1.58	-46.46	-19.00	27.46
7850.00	V	35.46	-57.23	12.94	1.58	-45.87	-19.00	26.87
PCS Band, Test Frequency 1994.8MHz								
77.36	H	47.62	-67.37	-1.32	0.34	-69.03	-19.00	50.03

53.16	V	59.35	-43.94	-13.45	0.22	-57.61	-19.00	38.61
3989.60	H	35.87	-64.52	12.30	1.45	-53.67	-19.00	34.67
3989.60	V	34.65	-66.50	12.30	1.45	-55.65	-19.00	36.65
5984.40	H	35.72	-59.65	13.48	1.39	-47.56	-19.00	28.56
5984.40	V	34.67	-60.66	13.48	1.39	-48.57	-19.00	29.57
7979.20	H	34.63	-57.19	12.99	1.67	-45.87	-19.00	26.87
7979.20	V	35.57	-56.82	12.99	1.67	-45.50	-19.00	26.50

Note 1: The unit of antenna gain is dBd for frequency below 1GHz and is dBi for frequency above 1GHz.

Note 2:

Absolute Level = Substituted Level - Cable loss + Antenna Gain

Margin = Limit - Absolute Level

******* END OF REPORT *******