



Compliance Testing, LLC

Previously Flom Test Lab

EMI, EMC, RF Testing Experts Since 1963

toll-free: (866) 311-3268

fax: (480) 926-3598

<http://www.ComplianceTesting.com>

info@ComplianceTesting.com

Test Report

Prepared for: Shenzhen SolidRF, LLC

Model: M2M

Description: Dual Band Consumer BDA

FCC ID: A7V-SR42152001

To

FCC Part 20

Date of Issue: February 3, 2015

On the behalf of the applicant: Shenzhen SolidRF, LLC
E3 Building, Fenghuang Third Industry
Shenzhen, Guangdong, China 518103

Attention of: Johnny Zhing, Engineering Dept
Ph: (213) 995-7300
E-Mail: ning0508@gmail.com

Prepared By
Compliance Testing, LLC
1724 S. Nevada Way
Mesa, AZ 85204
(480) 926-3100 phone / (480) 926-3598 fax
www.compliancetesting.com
Project No: p1510005

Mike Graffeo
Project Test Engineer

This report may not be reproduced, except in full, without written permission from Compliance Testing.
All results contained herein relate only to the sample tested.

Test Report Revision History

Revision	Date	Revised By	Reason for Revision
1.0	January 29, 2015	Mike Graffeo	Original Document
2.0	February 25, 2015	Greg Corbin	Added EIRP information to output power table and corrected the gain limits on page 11.

Table of Contents

<u>Description</u>	<u>Page</u>
Standard Test Conditions and Engineering Practices	5
Test Result Summary	6
Authorized Frequency Band	7
Maximum Power and Gain	10
Intermodulation	12
Out-of-Band Emissions	15
Conducted Spurious Emissions	28
Noise Limits	37
Uplink Inactivity	43
Variable Gain	45
Occupied Bandwidth	48
Oscillation Detection	61
Radiated Spurious	69
Test Equipment Utilized	72

ILAC / A2LA

Compliance Testing, LLC, has been accredited in accordance with the recognized International Standard ISO/IEC 17025:2005. This accreditation demonstrates technical competence for a defined scope and the operation of a laboratory quality management system (refer to the joint ISO-ILAC-IAF Communiqué dated January 2009).

The tests results contained within this test report all fall within our scope of accreditation, unless noted below.

Please refer to <http://www.compliancetesting.com/labscope.html> for current scope of accreditation.

Testing Certificate Number: **2152.01**



FCC Site Reg. #349717

IC Site Reg. #2044A-2

Non-accredited tests contained in this report:

N/A

Test and Measurement Data

Sub-part
2.1033(c)(14):

All tests and measurement data shown were performed in accordance with FCC Rules and Regulations, Part 2, Subpart J and the following individual Parts: 20.21 in conjunction with latest version of KDB 935210.

Standard Test Conditions and Engineering Practices

Except as noted herein, the following conditions and procedures were observed during the testing:

In accordance with ANSI/C63.4-2009, and unless otherwise indicated in the specific measurement results, the ambient temperature of the actual EUT was maintained within the range of 10° to 40°C (50° to 104°F), unless the particular equipment requirements specified testing over a different temperature range. Also, unless otherwise indicated, the humidity levels were in the range of 10% to 90% relative humidity.

Environmental Conditions		
Temp (°C)	Humidity (%)	Pressure (mbar)
24.9 – 28.7	37.9 – 51.3	963.9 – 971.3

Measurement results, unless otherwise noted, are worst-case measurements.

EUT Description

Model: M2M

Description: Dual Band Consumer BDA

Firmware: 079 M2M-20150124.hex

Accessories: Power adaptor supplied from customer, model MX18W1-050300U

Additional Information:

The EUT is a M2M direct connect, bi-directional amplifier for the boosting of cellular phone signals and data communication devices. The following frequency bands and emission types are utilized.

Frequency Band (MHz)		
Uplink	824 - 849	1850 - 1910
Downlink	869 - 894	1930 - 1990
Modulation Type	GSM, CDMA, EDGE, HSPA, EVDO, LTE	

Emission Designators					
CDMA	HSPA	LTE	EVDO	EDGE	GSM
F9W	F9W	G7D	F9W	G7W	GXW

The modulation types and emission designators listed in the tables represent the modulations that the cell phone providers use for each frequency band. GSM, CDMA, and WCDMA represent all the modulation types (phase and amplitude or a combination thereof) utilized within the industry. EDGE, HSPA, LTE etc. are all protocols or multiplexing techniques using the base modulations.

EUT Operation during Tests

The EUT was in a normal operating condition.

Test Result Summary

Specification	Test Name	Pass, Fail, N/A	Comments
20.21(e)(3)	Authorized Frequency Band	Pass	
20.21(e)(8)(i)(B) 20.21(e)(8)(i)(C) 20.21(e)(8)(i)(D)	Maximum Power and Gain	Pass	
20.21(e)(8)(i)(F)	Intermodulation	Pass	
20.21(e)(8)(i)(E)	Out-of-Band Emissions	Pass	
2.1051 22.917(a) 24.238(a)	Conducted Spurious Emissions	Pass	
20.21(e)(8)(i)(A)	Noise Limits	Pass	
20.21(e)(8)(i)(I)	Uplink Inactivity	Pass	
20.21(e)(8)(i)(C)(1) 20.21(e)(8)(i)(H) 20.21(e)(8)(i)(C)(2)(iii)	Variable Gain	Pass	
2.1049	Occupied Bandwidth	Pass	
20.21(e)(8)(ii)(A)	Oscillation Detection	Pass	
2.1053	Radiated Spurious	Pass	
20.21(e)(8)(i)(B)	Spectrum Block Filtering	N/A	This only applies to devices utilizing spectrum block filtering

Authorized Frequency Band

Engineer: Mike Graffeo

Test Date: 1/19/15

Test Procedure

The EUT was connected to a spectrum analyzer through an attenuator with the losses being input into the spectrum analyzer as a combination of reference level offset and correction factor as needed to ensure accurate readings. A signal generator was utilized to produce a CW input signal tuned to the center channel of the operational band. The RF input level was increased to a point just prior to the AGC being in control of the power, then reduced 3 db. The Signal generator was set to sweep across 2X the operational band of the EUT while the spectrum analyzer was set to MAX HOLD. Two markers were placed at the edges of the operational band and a third marker was placed at the highest point within the band no closer than 2.5 MHz from the band edge.

Test Setup

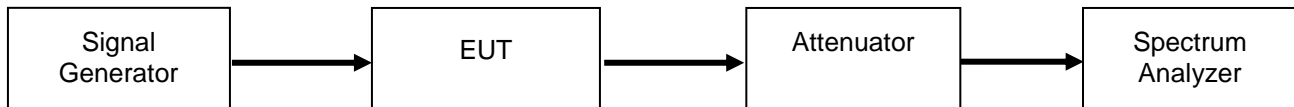

Uplink Test Results

824 - 849 MHz Band

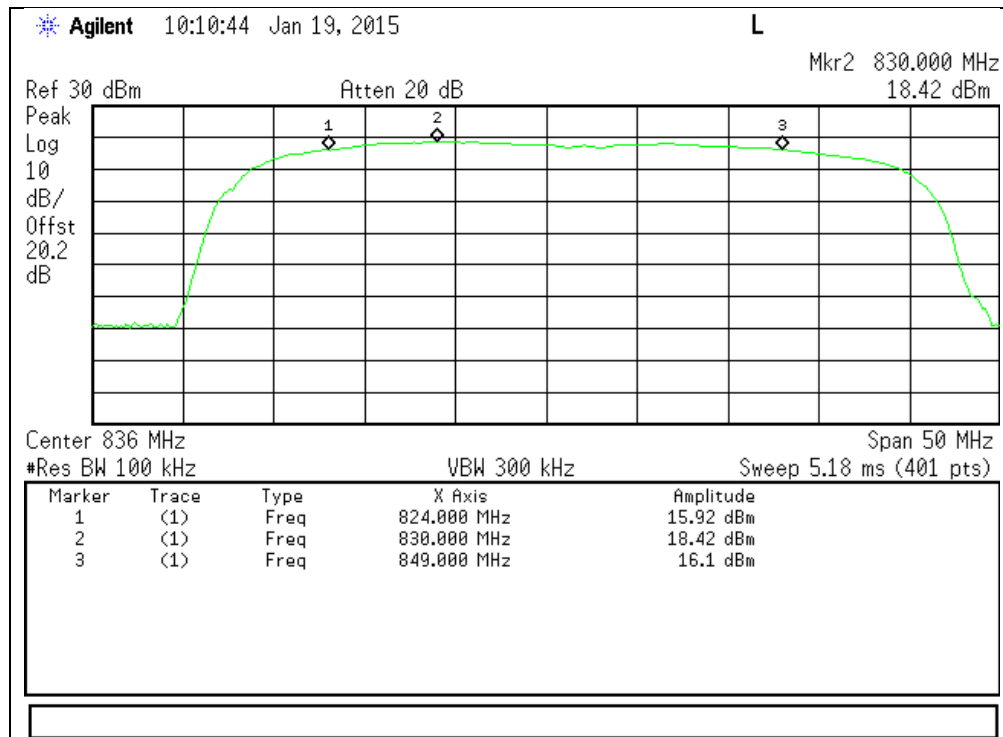

1850 - 1910 MHz Band

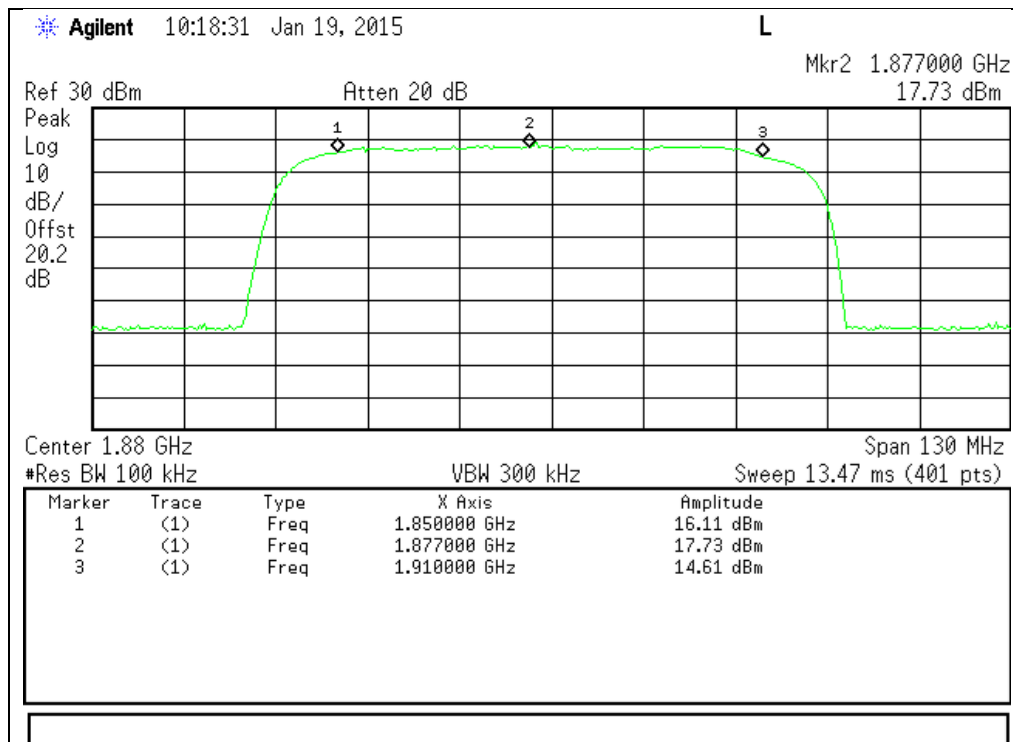

Downlink Test Results

869 - 894 MHz Band

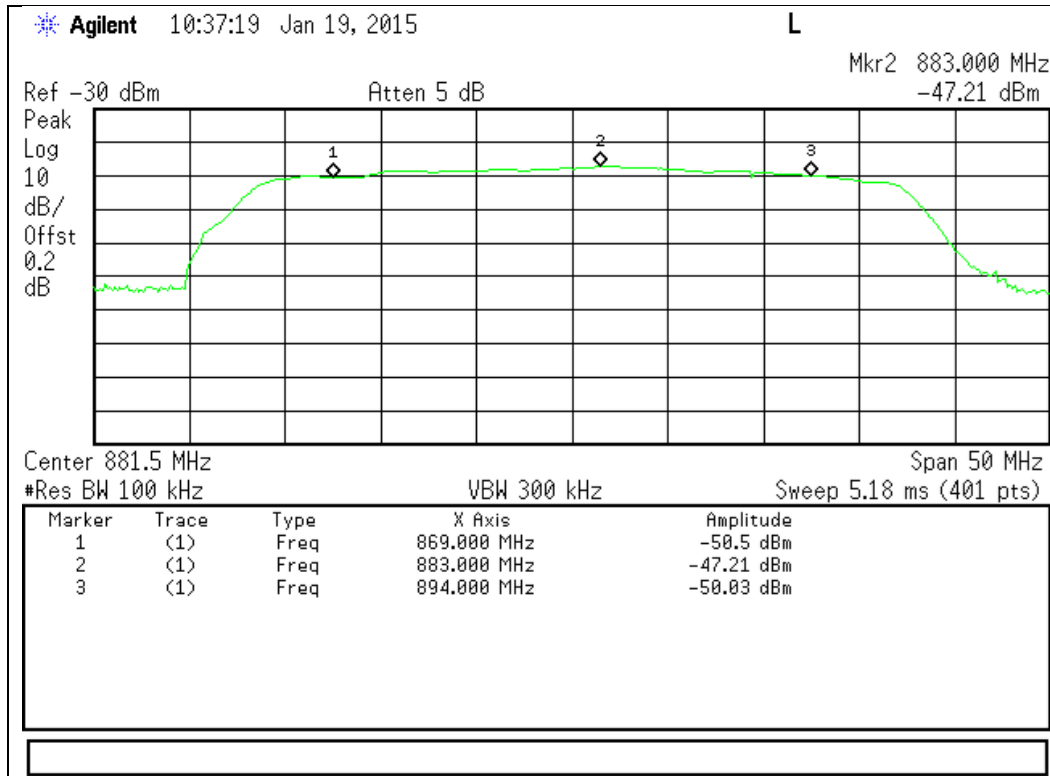

1930 - 1990 MHz Band

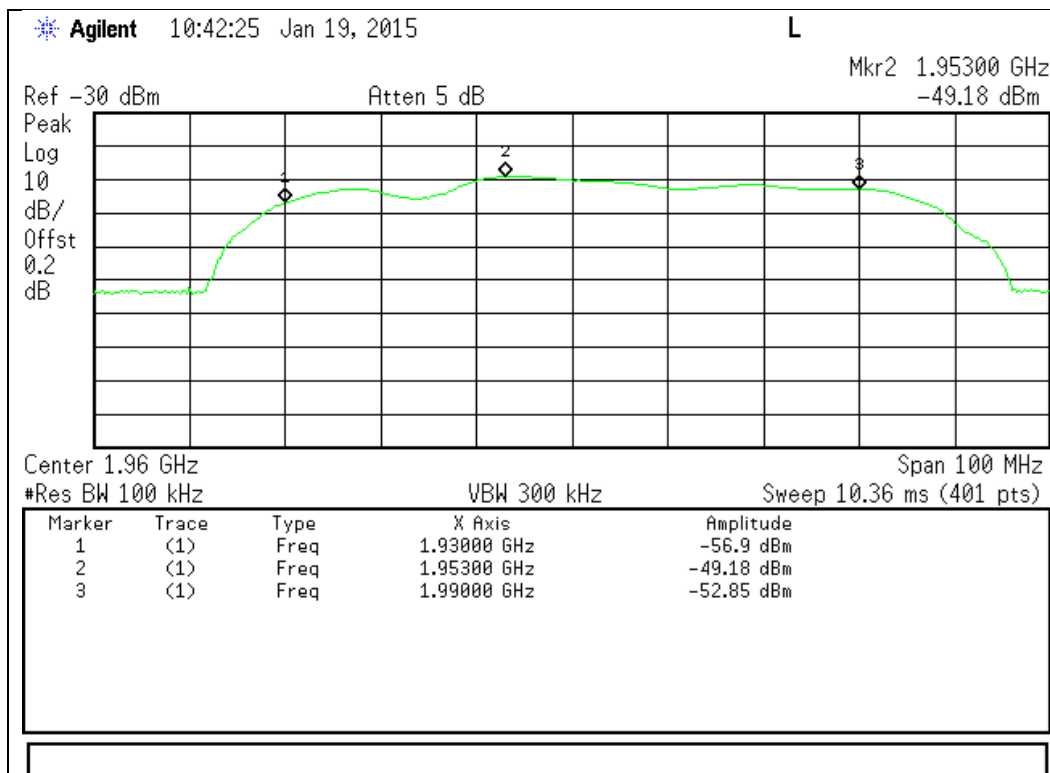

Maximum Power and Gain

Engineer: Mike Graffeo

Test Date: 10/21/2014

Test Procedure

The EUT was connected to a spectrum analyzer through an attenuator with the losses being input into the spectrum analyzer as a combination of reference level offset and correction factor as needed to ensure accurate readings. The spectrum analyzer and signal generator were tuned to the frequency with the highest power level in the band, as determined by the Authorized Frequency Band test. The RF input level was increased to a point just prior to the AGC being in control of the power for both pulsed single time slot GSM modulation and 4.1 MHz AWGN modulation. The maximum power was measured and verified to meet the minimum and maximum levels allowed, with the maximum gain being computed from these values. The uplink and downlink gain under each condition were verified to be within 9 dB of each other.

Gain limit for direct connect: 15dB

$EIRP = \text{Output Power} + \text{Antenna Gain} - \text{Cable Loss}$

Test Setup

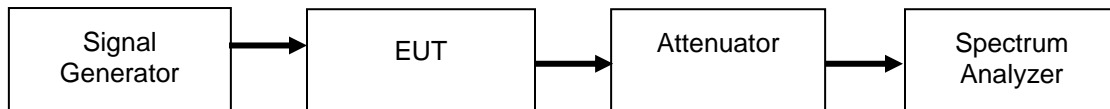

Uplink Power Test Results

Frequency Band (MHz)	Input Level (dBm)	Output Power (dBm)	Antenna Gain (dBi)	Cable Insertion Loss (dB)	Final EIRP (dBm)	Lower Limit (dBm)	Upper Limit (dBm)	Result
824 - 849 MHz Pulsed GSM	12.2	23.07	7	4.9	25.17	17	30	Pass
824 - 849 MHz AWGN	13.1	24.08	7	4.9	26.18	17	30	Pass
1850 - 1910 MHz Pulsed GSM	8.1	18.22	10	7.6	20.62	17	30	Pass
1850 - 1910 MHz AWGN	9.3	19.30	10	7.6	21.73	17	30	Pass

Downlink Power Test Results

Frequency Band (MHz)	Input Level (dBm)	Output Power (dBm)	Upper Limit (dBm)	Result
869 - 894 MHz Pulsed GSM	-58.0	-45.51	17	Pass
869 - 894 MHz AWGN	-52.9	-40.33	17	Pass
1930 - 1990 MHz Pulsed GSM	-47.8	-35.13	17	Pass
1930 - 1990 MHz AWGN	-44.8	-32.61	17	Pass

Uplink and Downlink Gain Test Results

Modulation	Uplink Frequency (MHz)	Downlink Frequency (MHz)	Uplink Gain (dB)	Uplink Limit (dB)	Downlink Gain (dB)	Downlink Limit (dB)	Delta (dB)	Limit (dB)	Margin (dB)
Pulsed GSM	830	883	10.87	15	12.5	15	1.62	9	-7.38
AWGN	830	883	10.98	15	12.6	15	1.59	9	-7.41
Pulsed GSM	1877	1953	10.12	15	12.7	15	2.55	9	-6.45
AWGN	1877	1953	10.00	15	12.2	15	2.19	9	-6.81

Intermodulation

Engineer: Mike Graffeo

Test Date: 10/22/2014

Test Procedure

The EUT was connected to a spectrum analyzer through an attenuator. Two signal generators were utilized to produce two CW signals 600 kHz apart and centered in the operational band. Attenuator and cable insertion loss correction factors were input to either the signal generator or the spectrum analyzer as required to ensure that accurate measurements were recorded. The input power was set so the booster output power was operating at 0.2 dB below the AGC Threshold and the RMS intermodulation products were measured to ensure they were less than -19 dBm in a 3 kHz RBW. The uplink and downlink intermodulation products were plotted, with the levels being listed in the summary tables.

Test Setup

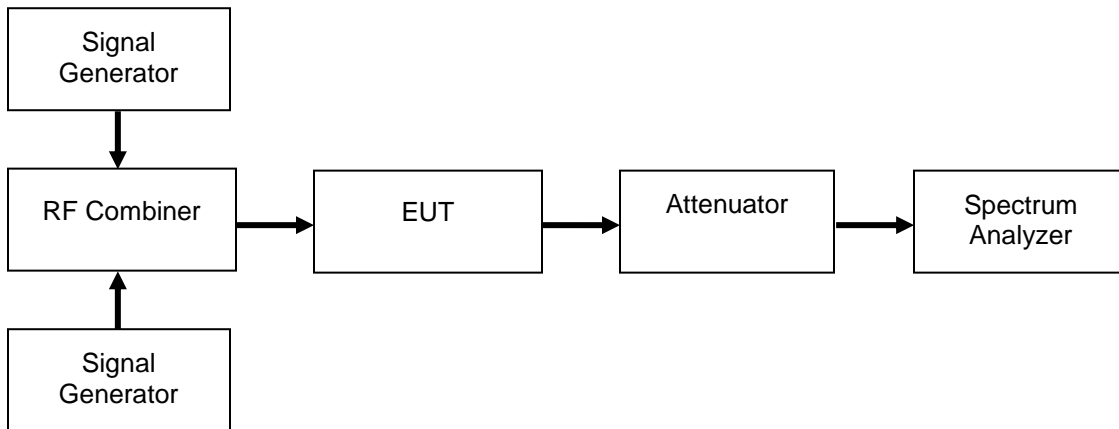

Uplink Test Results

Frequency Band (MHz)	Intermodulation Level (dBm)	Limit (dBm)	Result
824 - 849 MHz	-23.90	-19	Pass
1850 - 1910 MHz	-27.41	-19	Pass

Downlink Test Results

Frequency Band (MHz)	Intermodulation Level (dBm)	Limit (dBm)	Result
869 - 894 MHz	-87.50	-19	Pass
1930 - 1990 MHz	-87.42	-19	Pass

Uplink Test Results

824 - 849 MHz Band

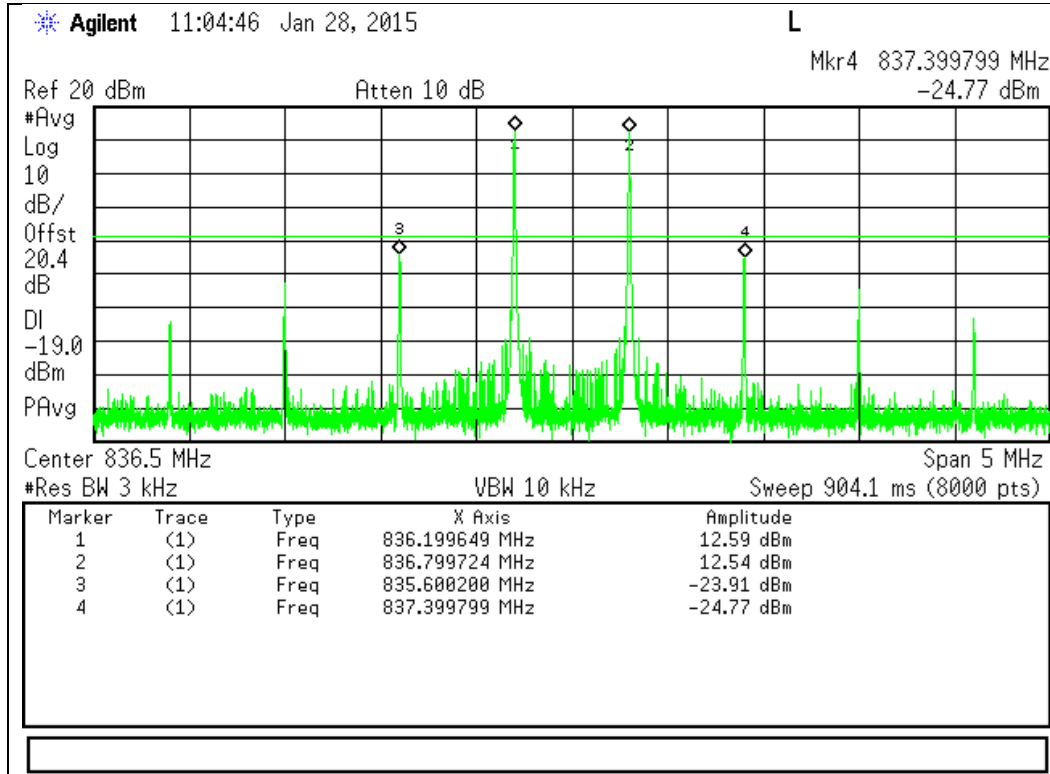

1850 - 1910 MHz Band

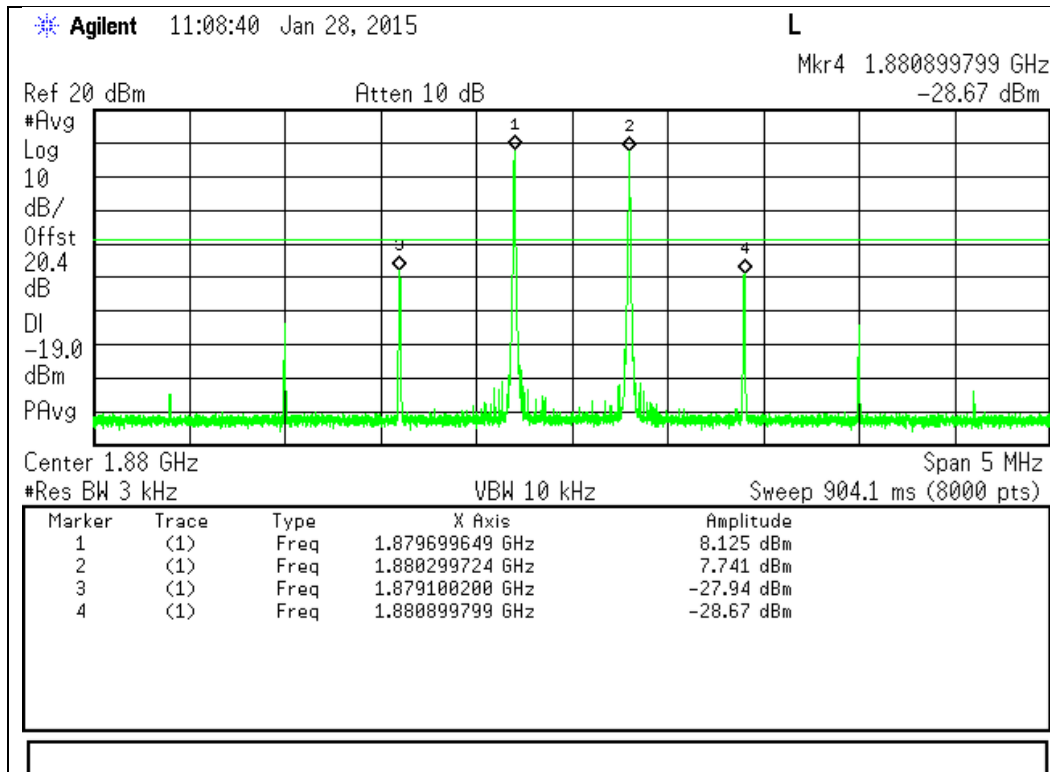

Downlink Test Results

869 - 894 MHz Band

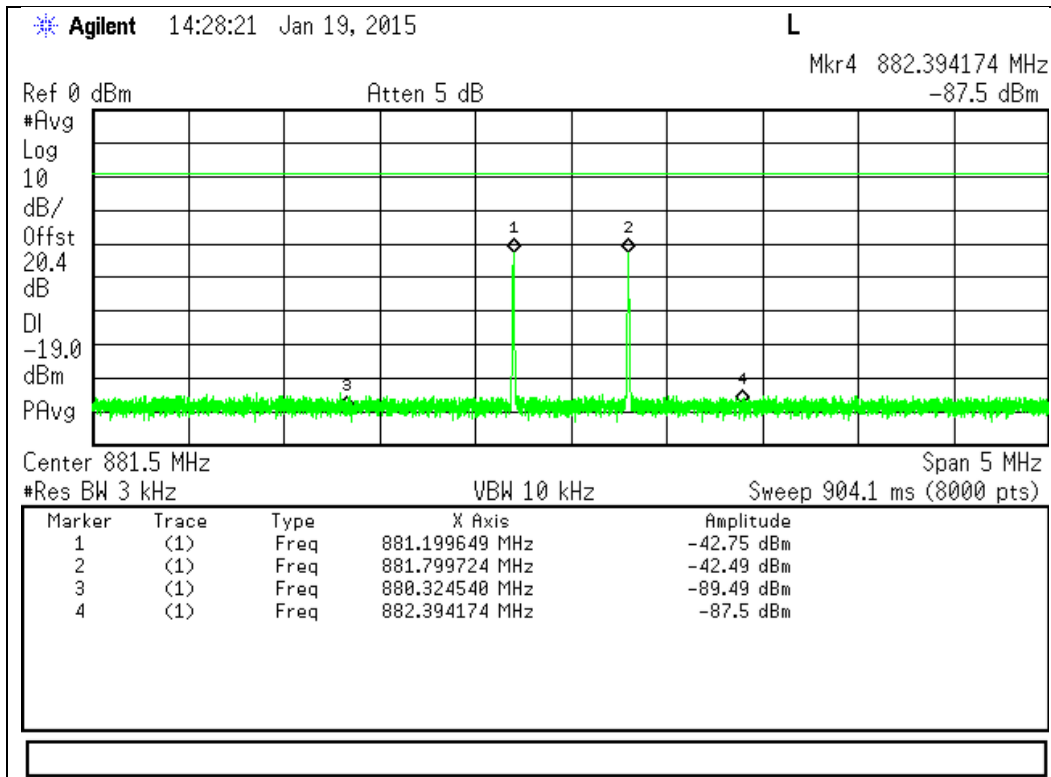

1930 - 1990 MHz Band

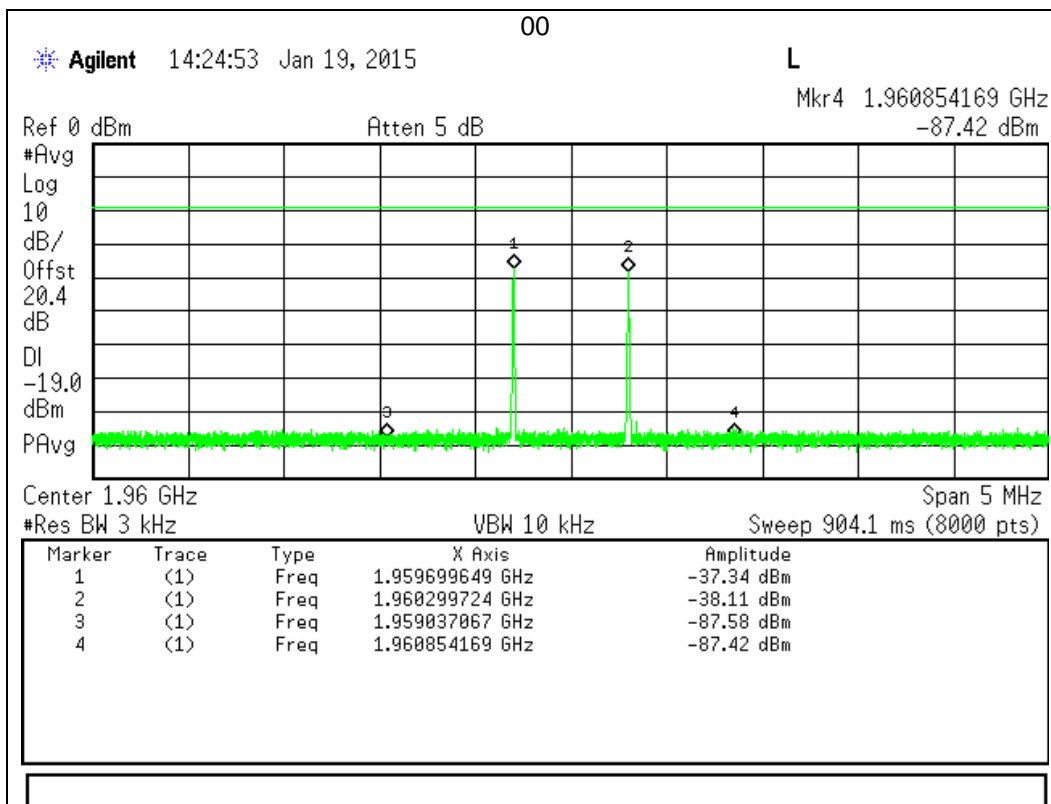

Out-of-Band Emissions

Engineer: Mike Graffeo

Test Date: 10/22/2014

Test Procedure

The EUT was connected to a spectrum analyzer through an attenuator with the losses being input into the spectrum analyzer as a combination of reference level offset and correction factor in order to ensure accurate readings. A signal generator was utilized to produce the following signals: GSM, CDMA, and WCDMA. The signal generator was tuned to the lowest allowable upper and lower channel within the EUT operational band for each respective modulation type. The RF input level was increased to a point just prior to the AGC being in control of the power. For each modulation type the Out of Band Emissions were measured to ensure they met the limits.

The following formula was used for calculating the limits:

$$\text{Limit} = P1 - 6 - (43 + 10\text{Log}(P2)) = -19\text{dBm}$$

P1 = power in dBm

P2 = power in Watts

Test Setup



GSM Uplink Test Plots

824 - 849 MHz Band Lower Band Edge

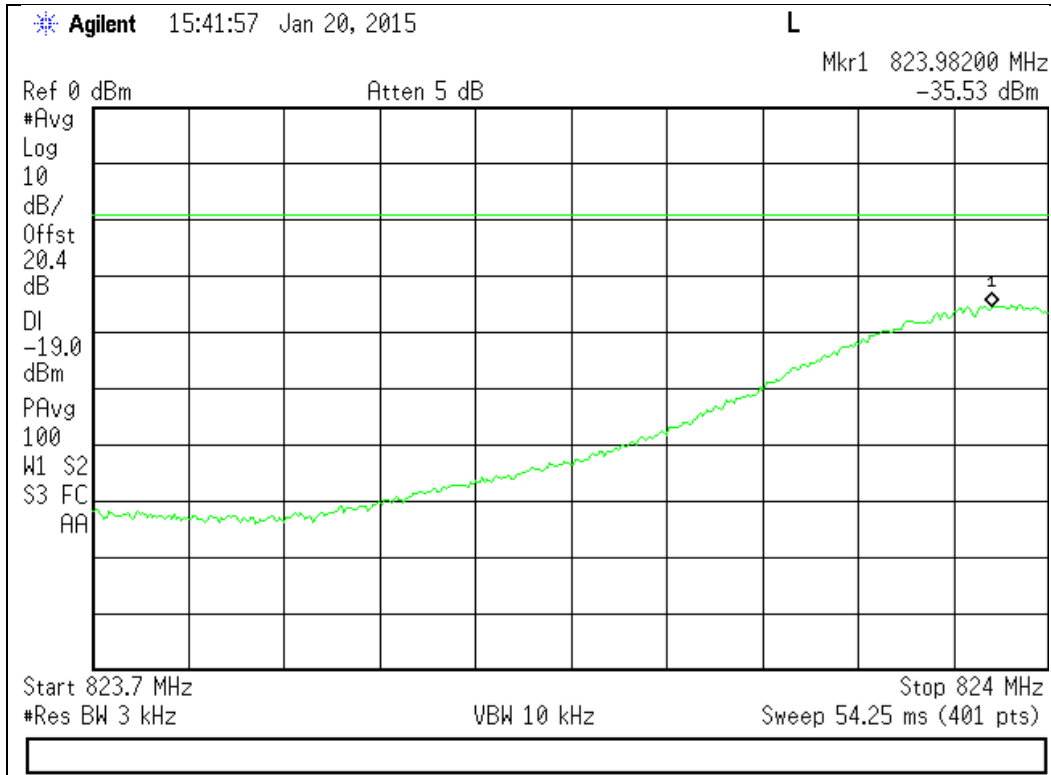

Upper Band Edge

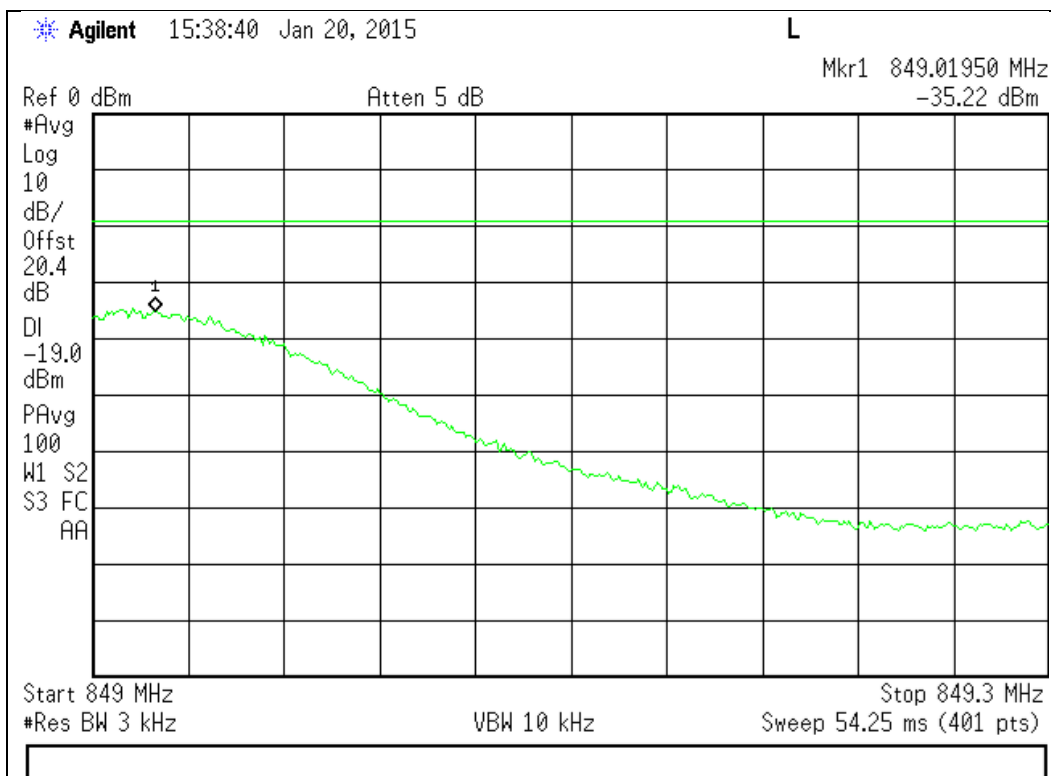

1850 - 1910 MHz Band

Lower Band Edge

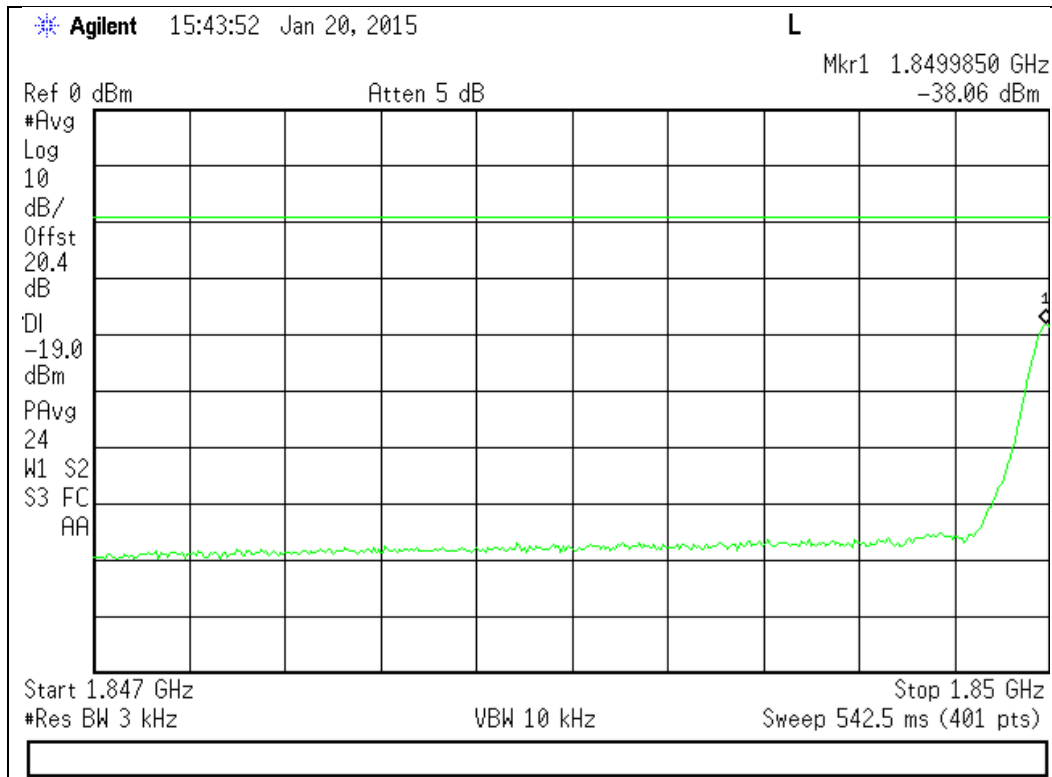

Upper Band Edge

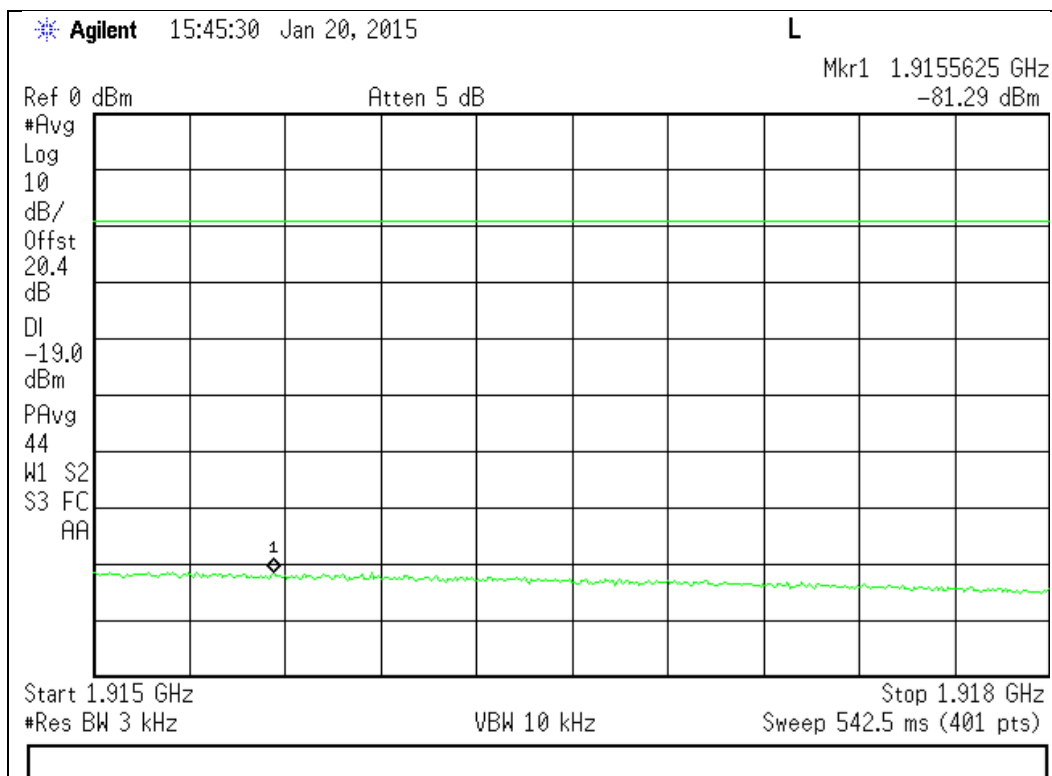

CDMA Uplink Test Plots

824 - 849 MHz Band

Lower Band Edge

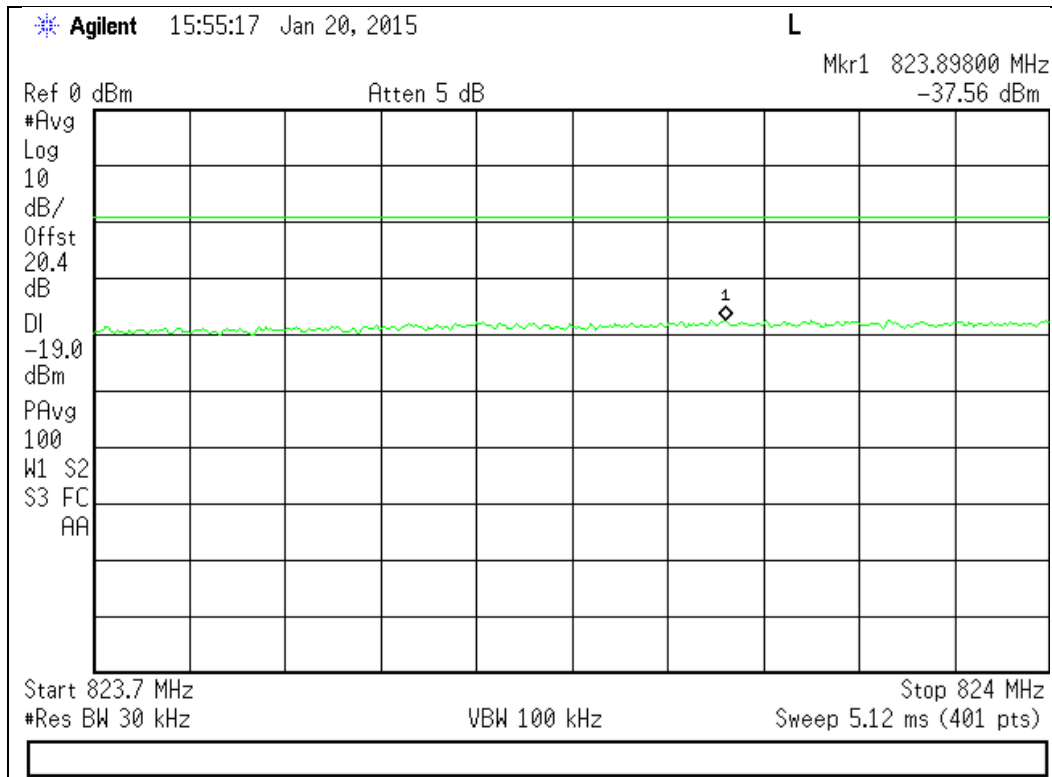

Upper Band Edge

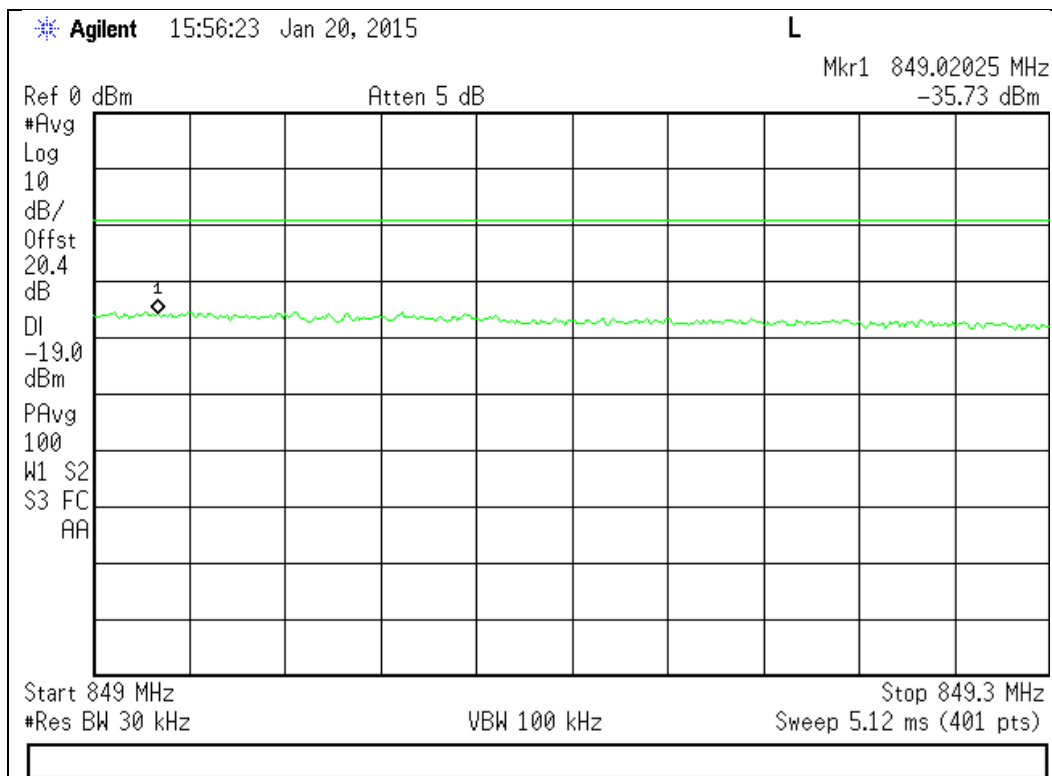

1850 - 1910 MHz Band

Lower Band Edge

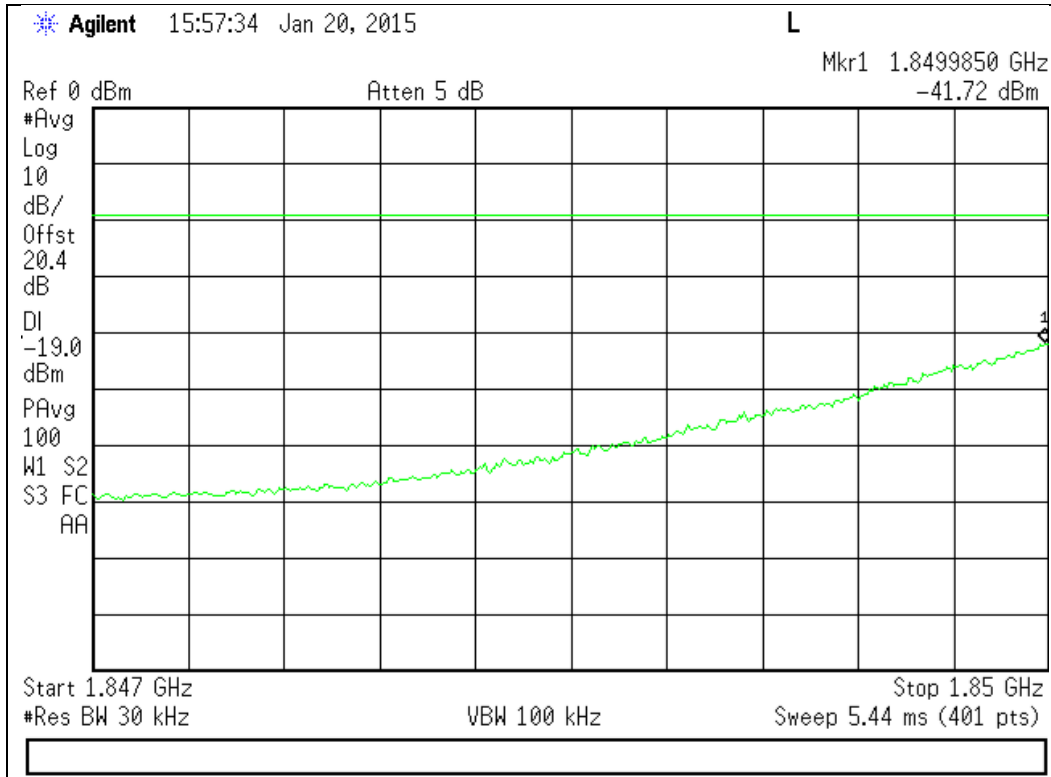

Upper Band Edge

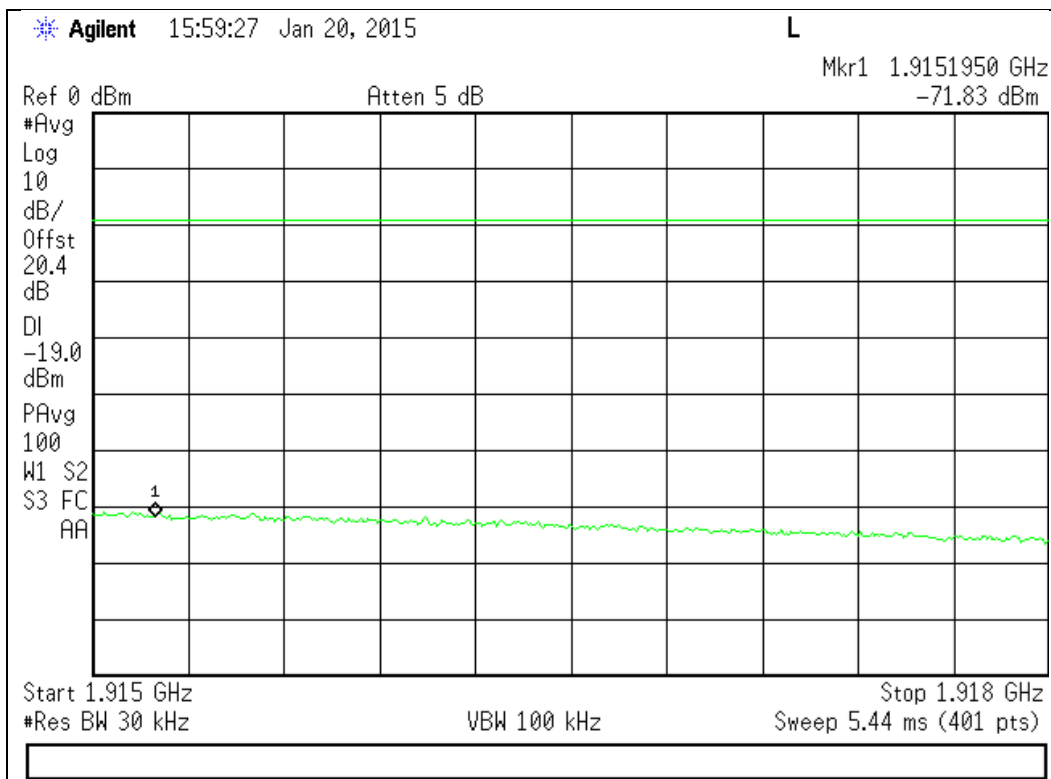

W-CDMA Uplink Test Plots

824 - 849 MHz Band

Lower Band Edge

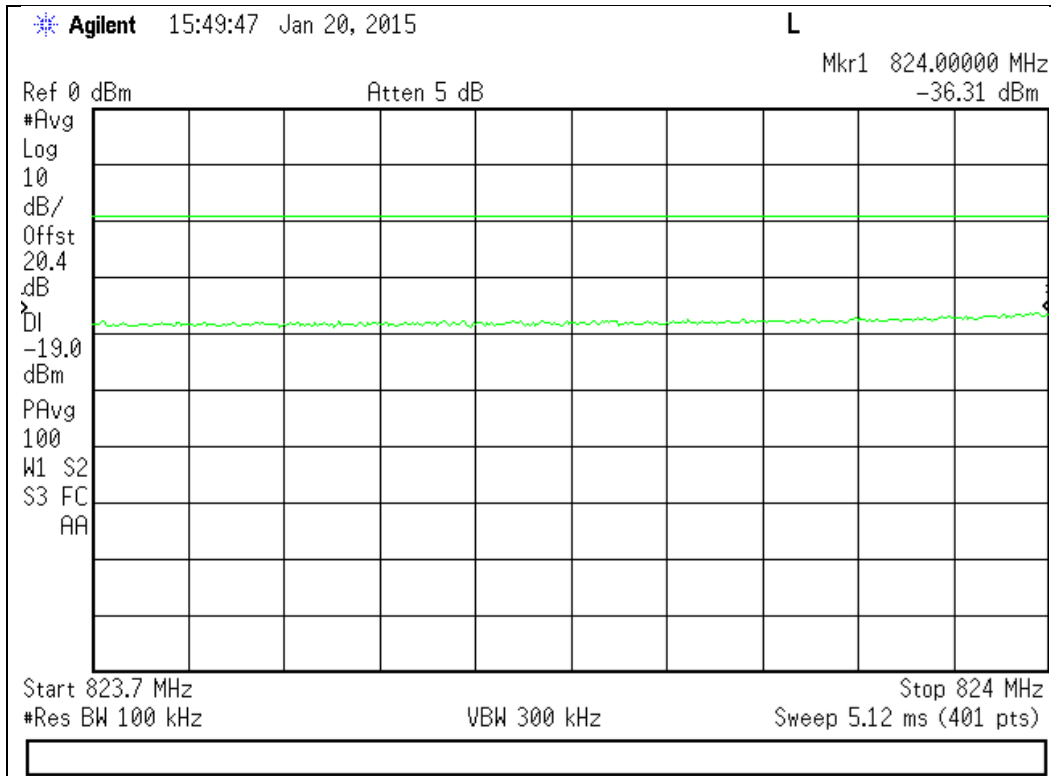

Upper Band Edge

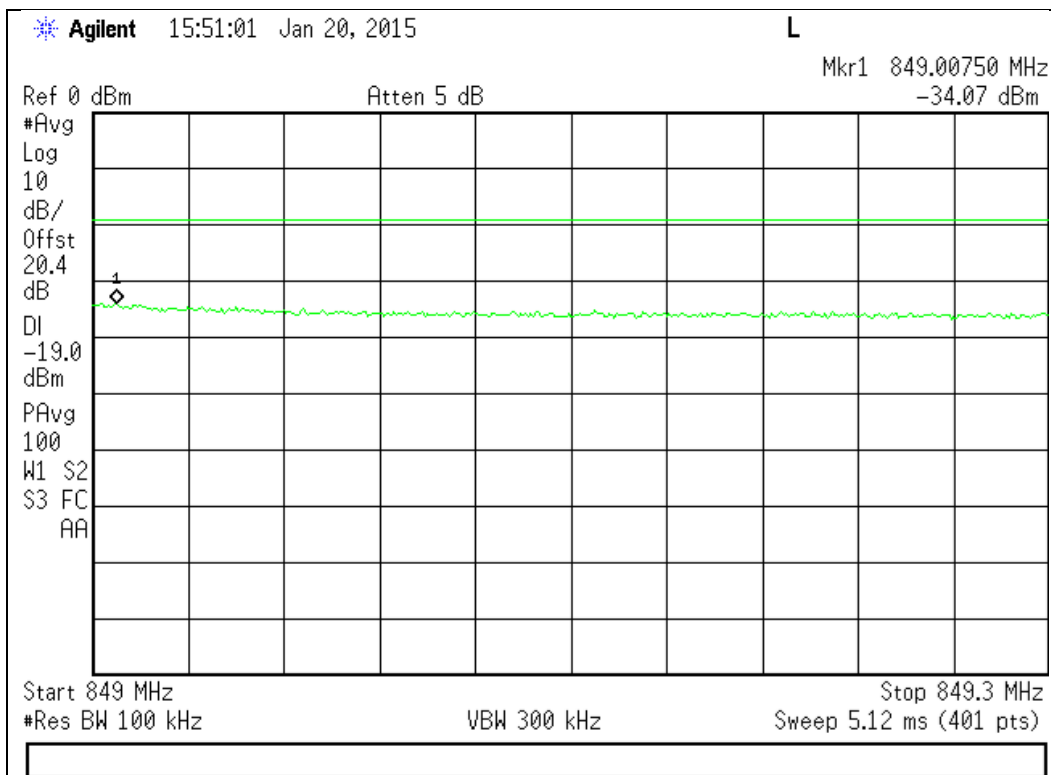

1850 - 1910 MHz Band

Lower Band Edge

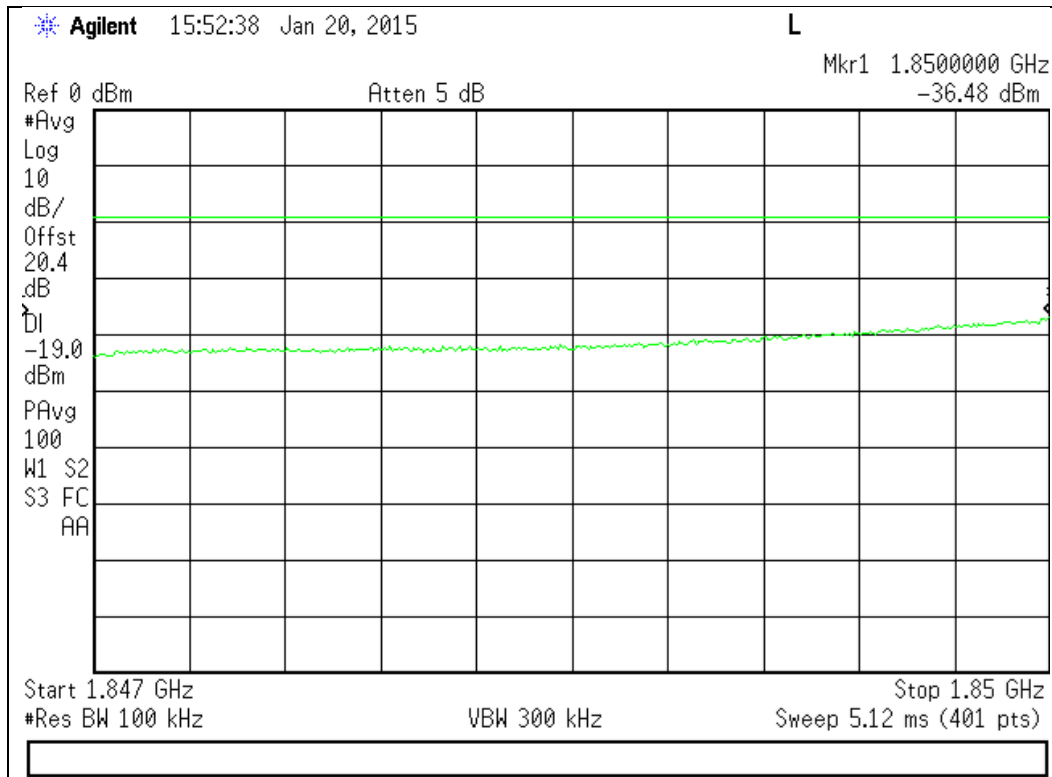

Upper Band Edge

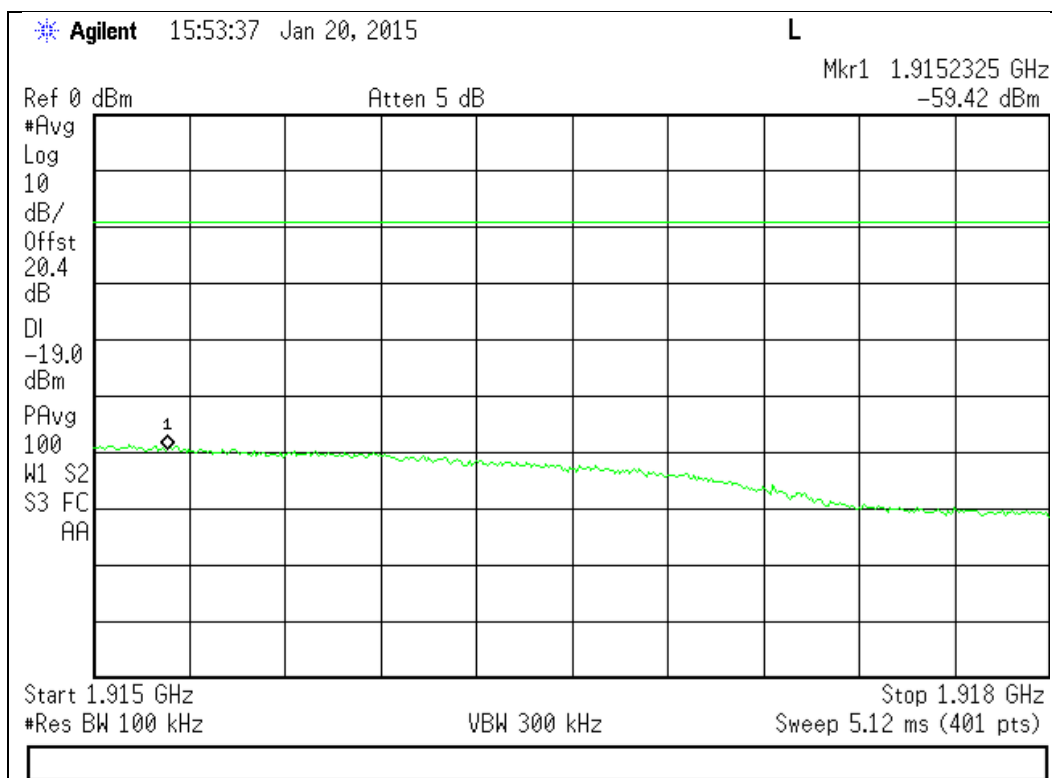

GSM Downlink Test Plots
869 - 894 MHz Band

Lower Band Edge

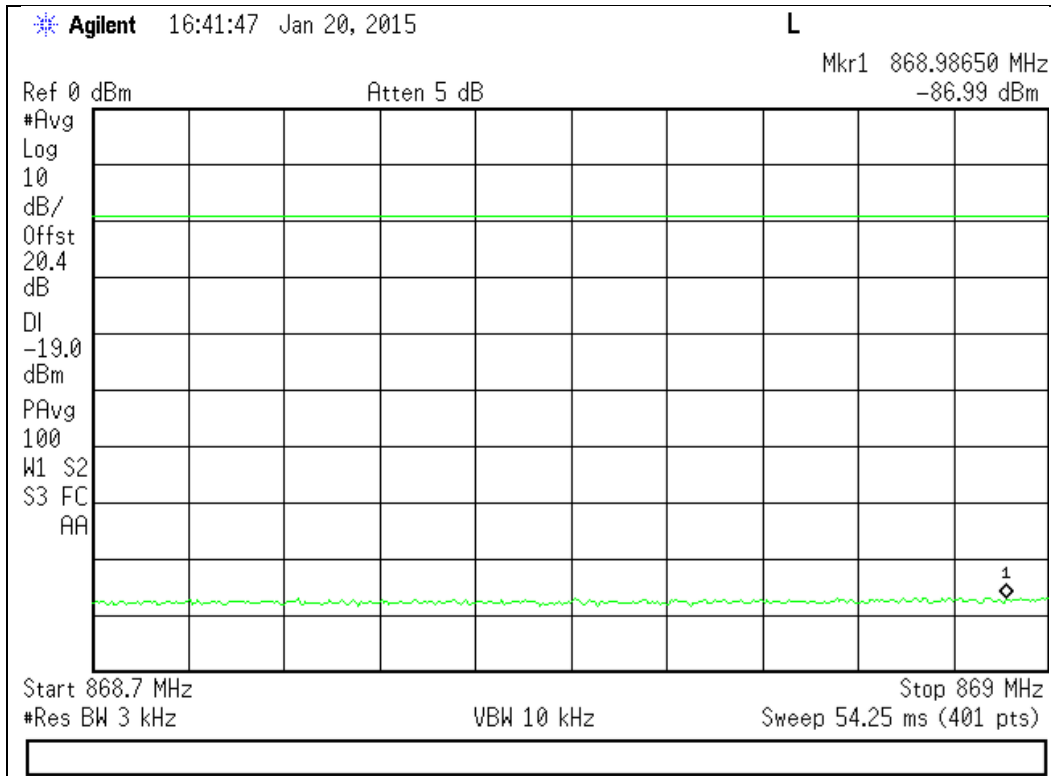

Upper Band Edge

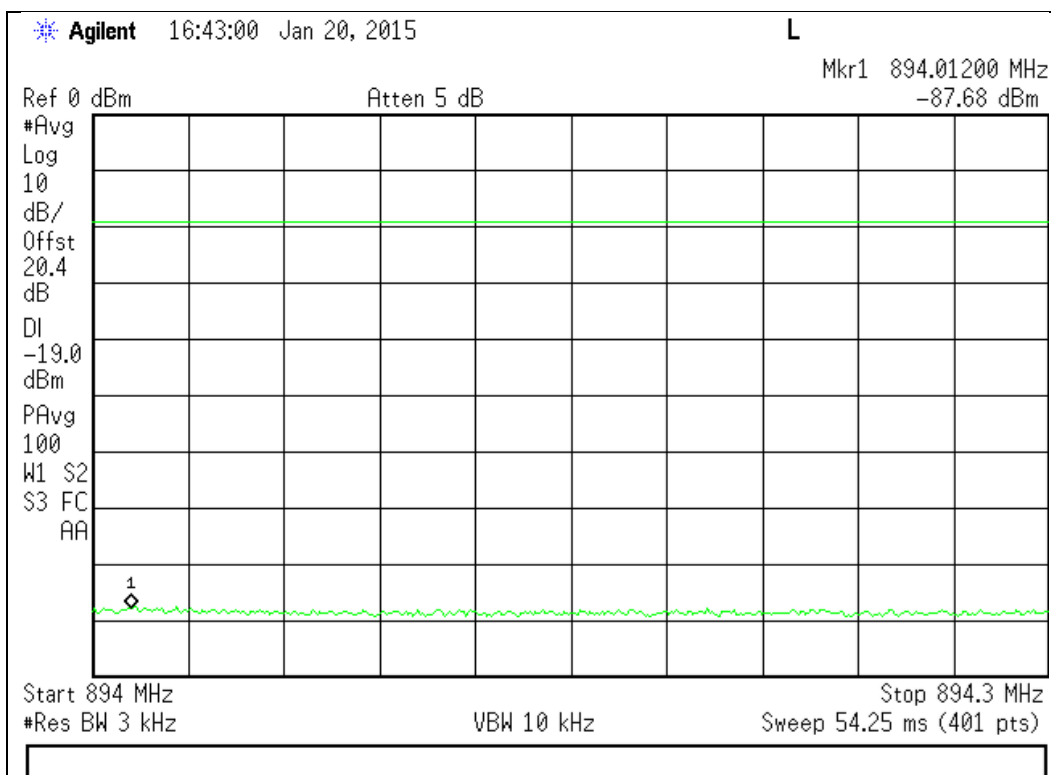

1930 - 1990 MHz Band

Lower Band Edge

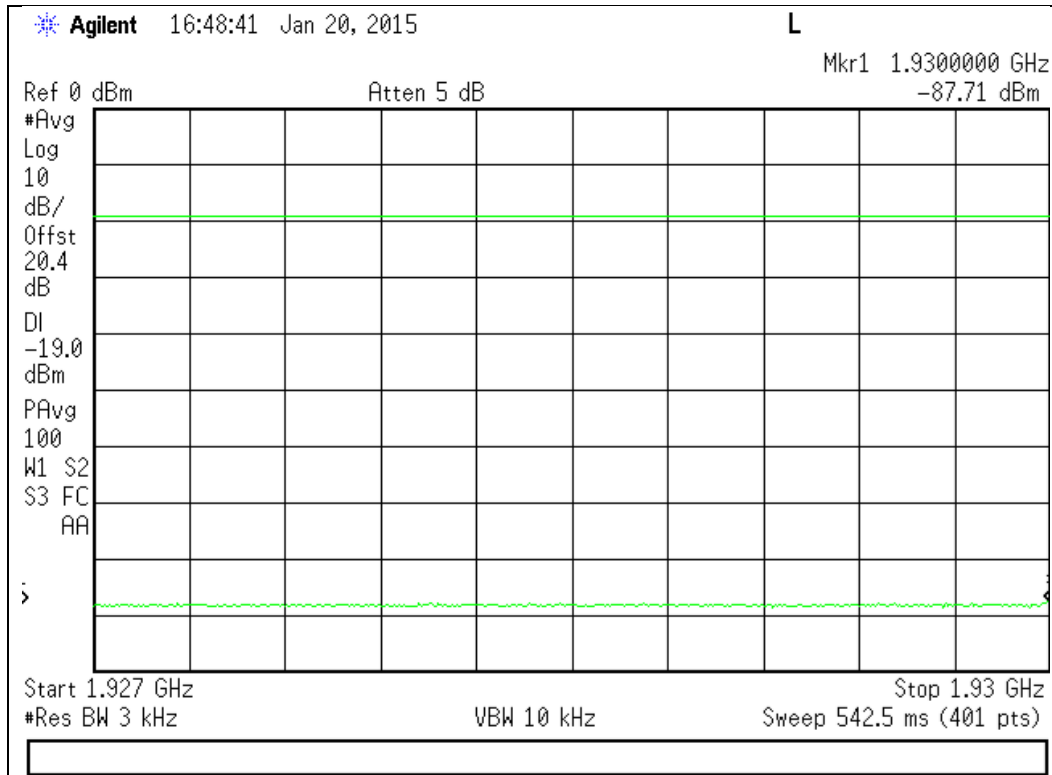

Upper Band Edge

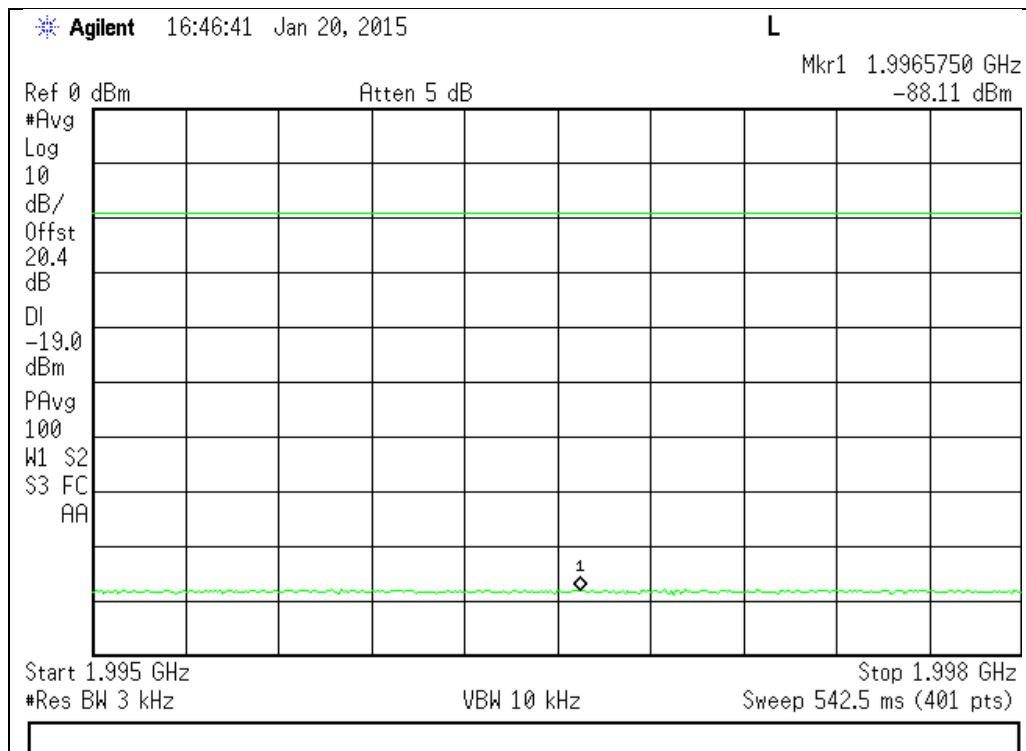

CDMA Downlink Test Plots

869 - 894 MHz Band

Lower Band Edge

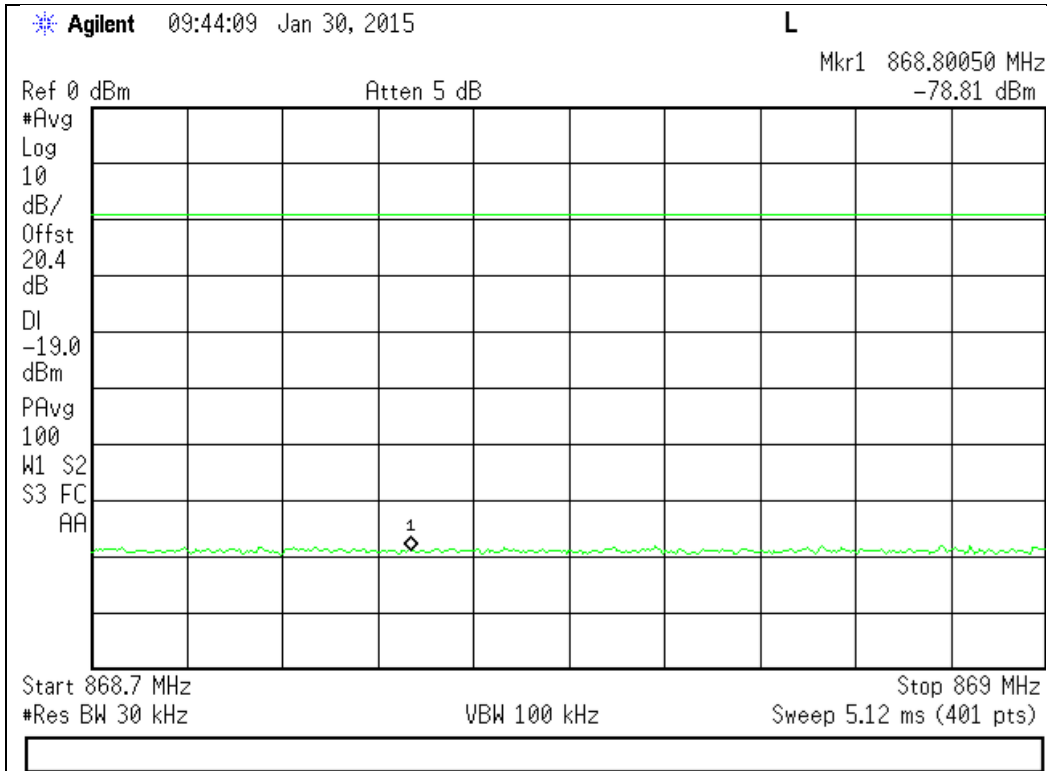

Upper Band Edge

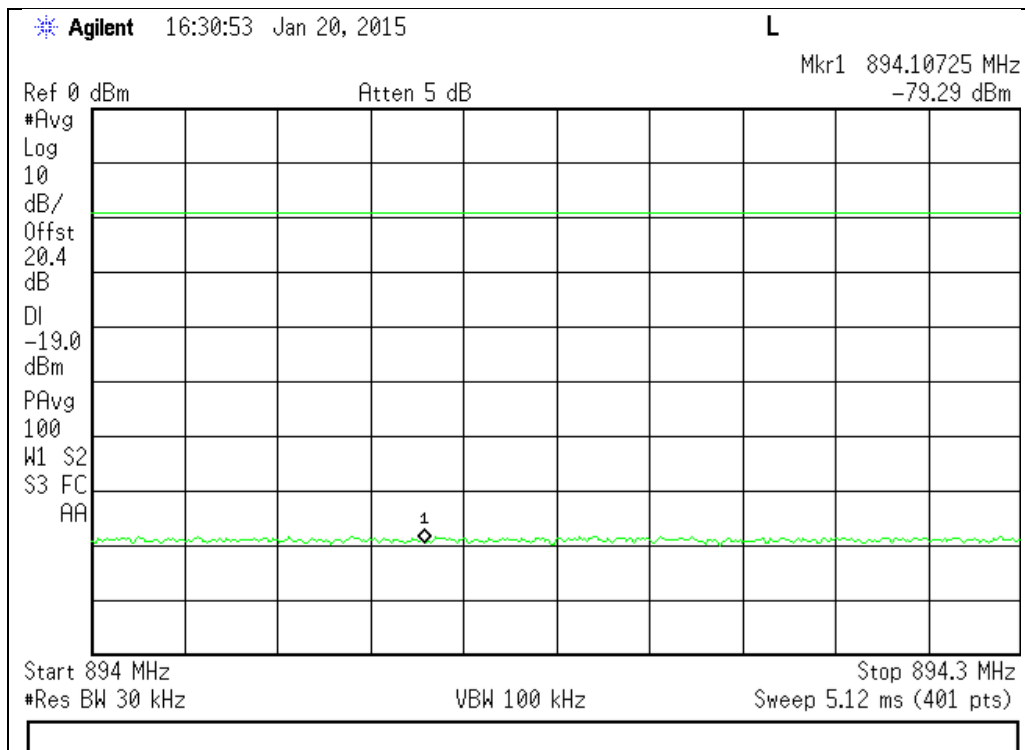

1930 - 1990 MHz Band

Lower Band Edge

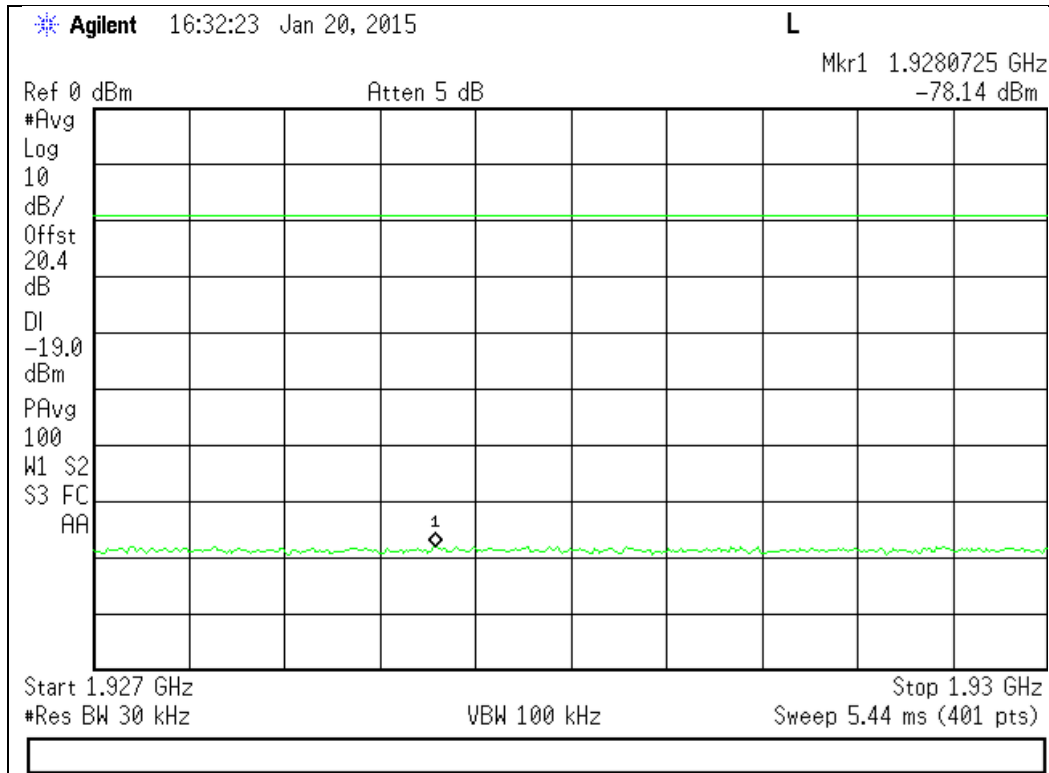

Upper Band Edge

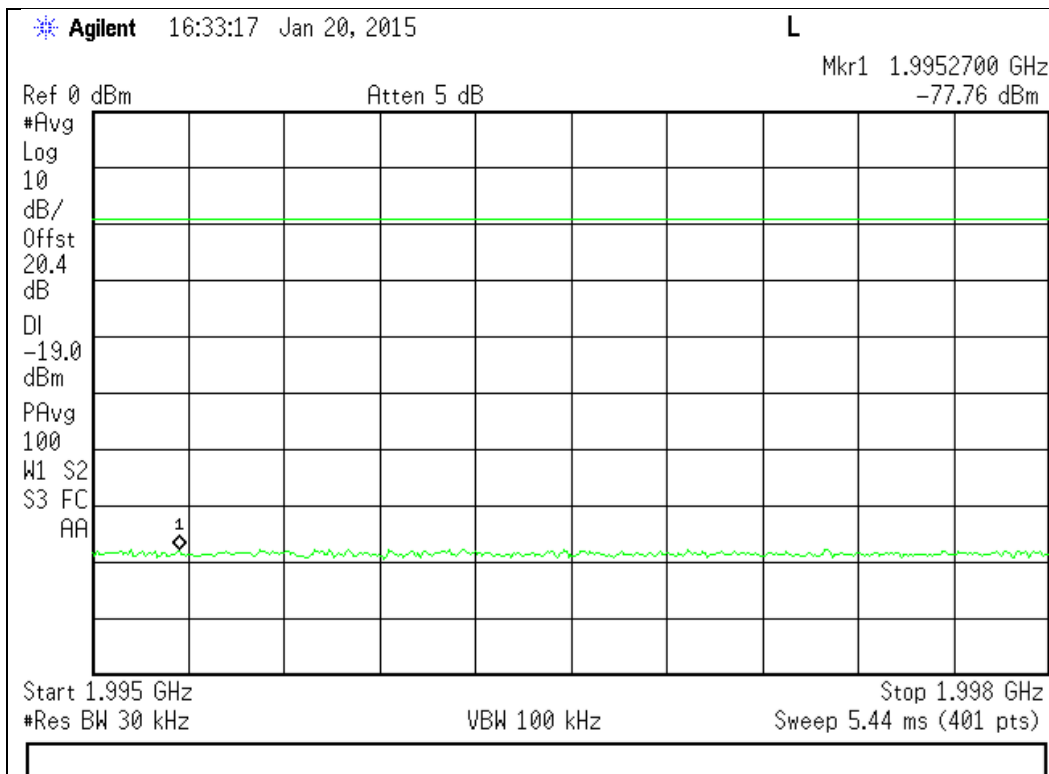

WCDMA Downlink Test Plots

869 - 894 MHz Band

Lower Band Edge

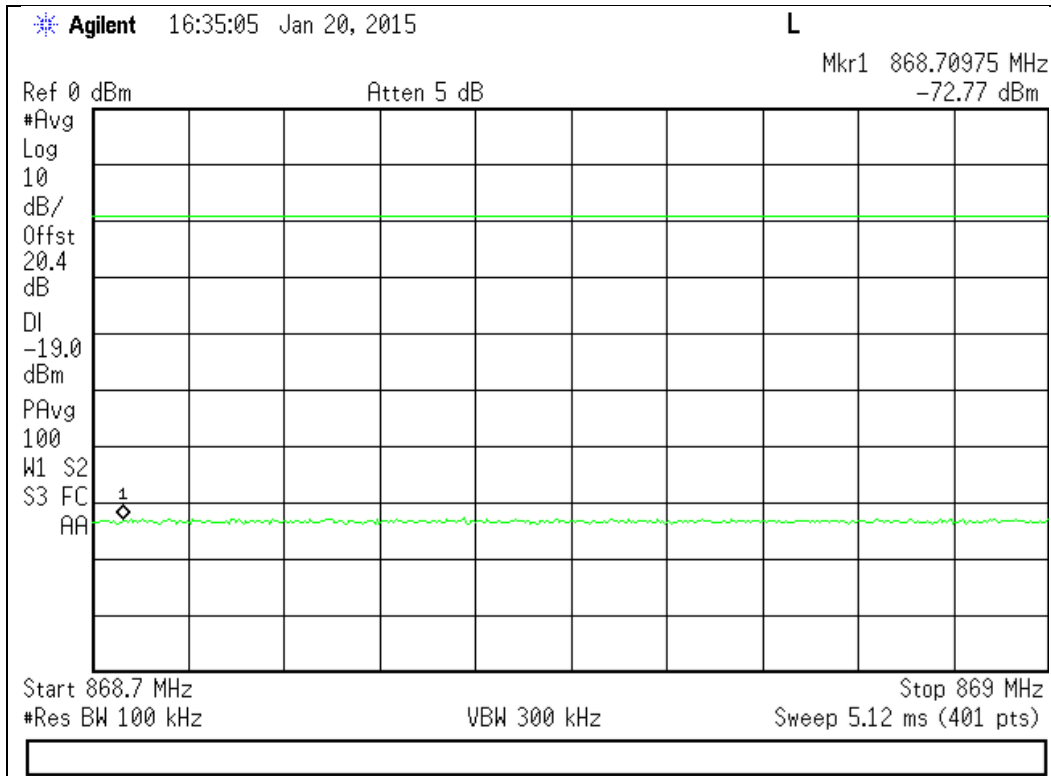

Upper Band Edge

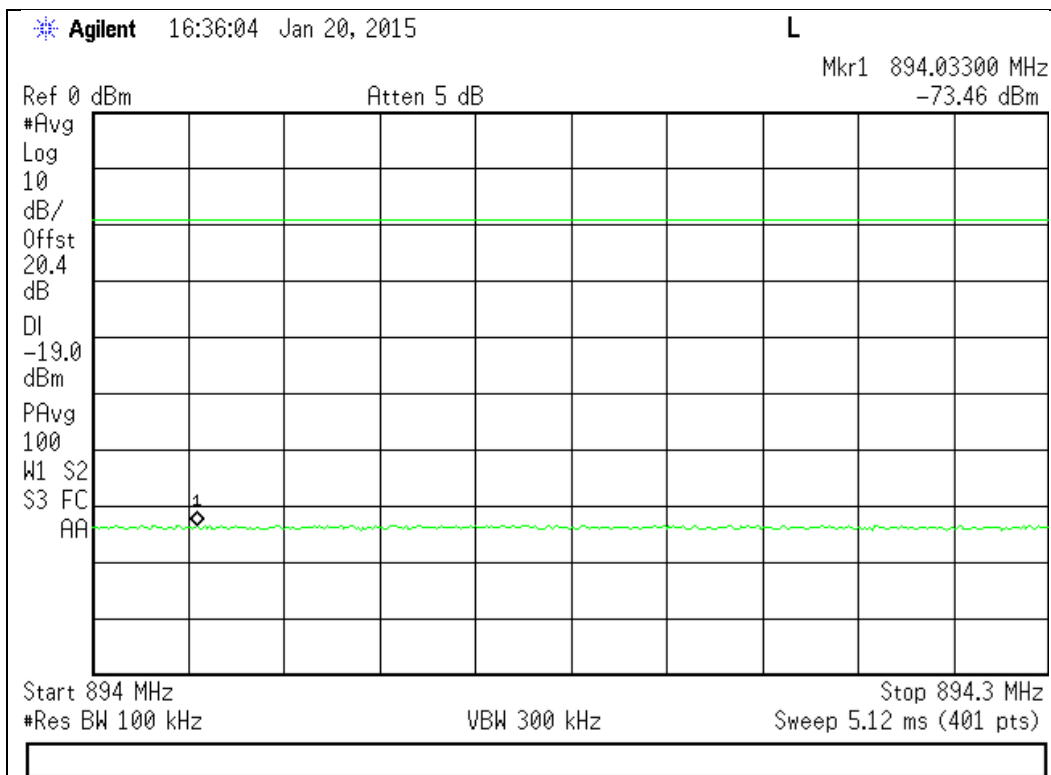

1930 - 1990 MHz Band

Lower Band Edge

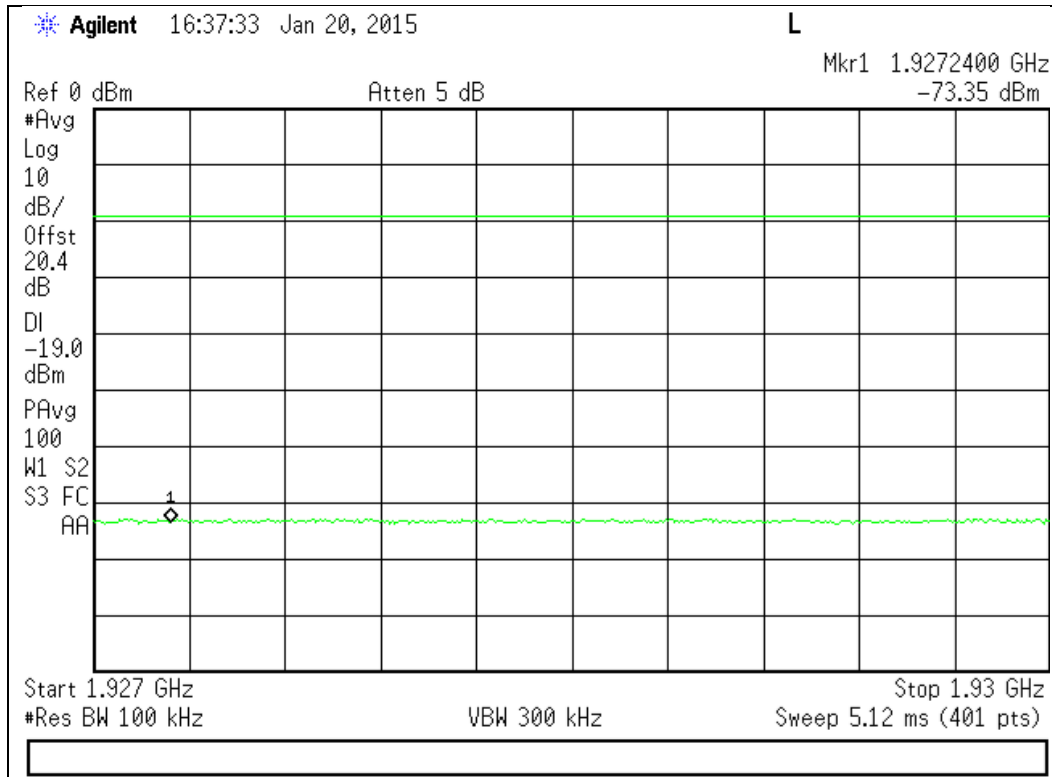

Upper Band Edge

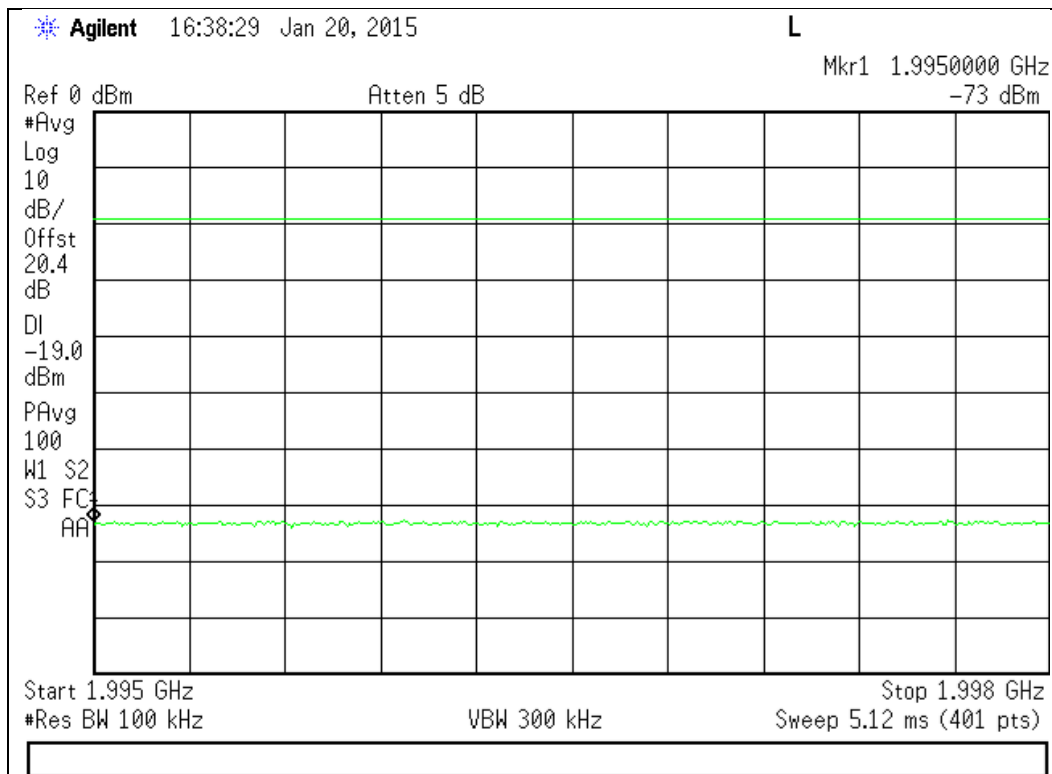

Conducted Spurious Emissions

Engineer: Mike Graffeo

Test Date: 1/20/2015

Test Procedure

The EUT was connected to a spectrum analyzer through an attenuator, with the losses being input into the spectrum analyzer as a combination of reference level offset and correction factor as needed to ensure accurate readings. A signal generator was utilized to produce a 4.1 MHz AWGN signal operating at 0.2 dB below the AGC Threshold. The conducted spurious emissions from 9 kHz to 10 times the highest tunable frequency for each operational band were measured (excluding the band defined by the Out of band emissions test). The emissions were plotted and the highest level was recorded in the summary table.

The following formulas are used for calculating the limits.

Conducted Spurious Emissions Limit = $P1 - (43 + 10\text{Log}(P2)) = -13 \text{ dBm}$

P1 = power in dBm

P2 = power in Watts

Test Setup

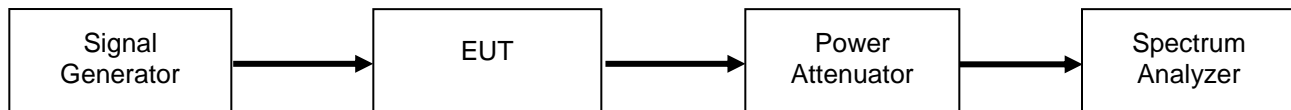

Uplink Test Plots

824 - 849 MHz Band Lower

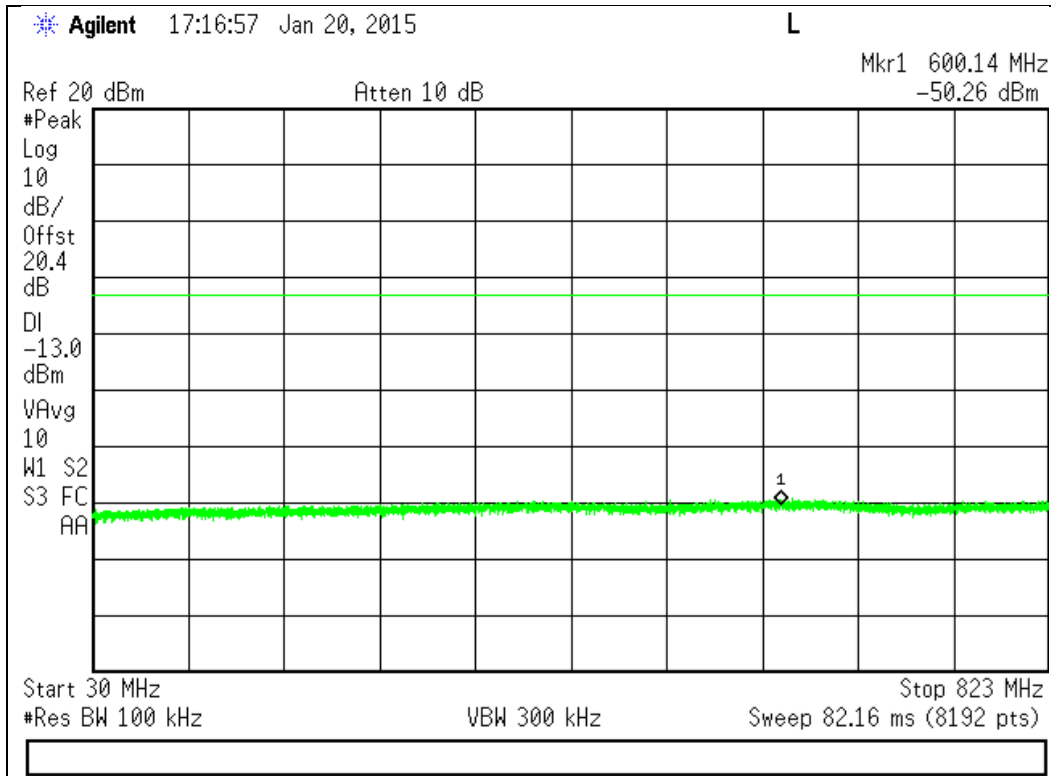

Upper

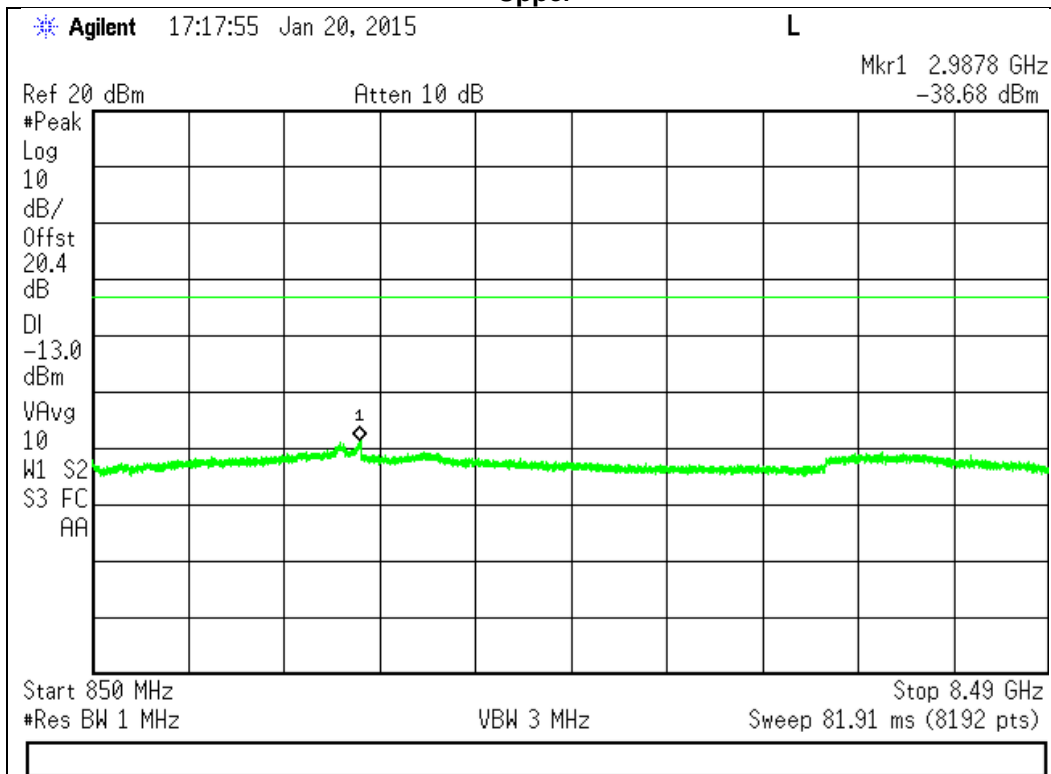

1850 - 1910 MHz Band
Lower

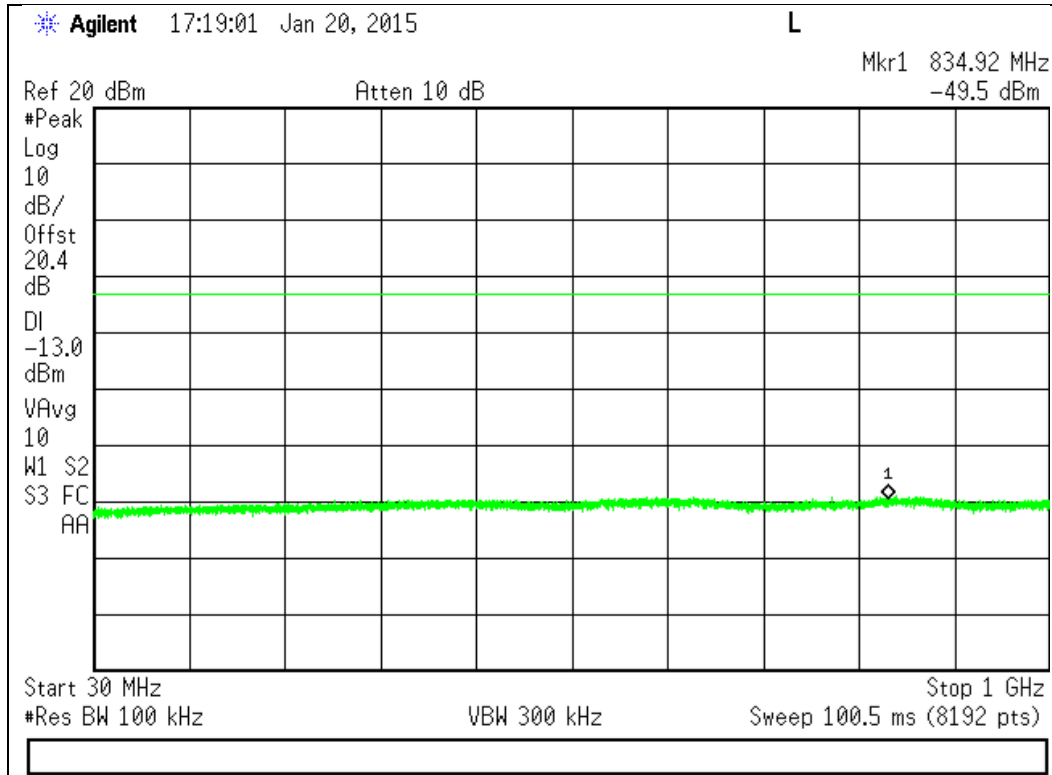

Upper 1

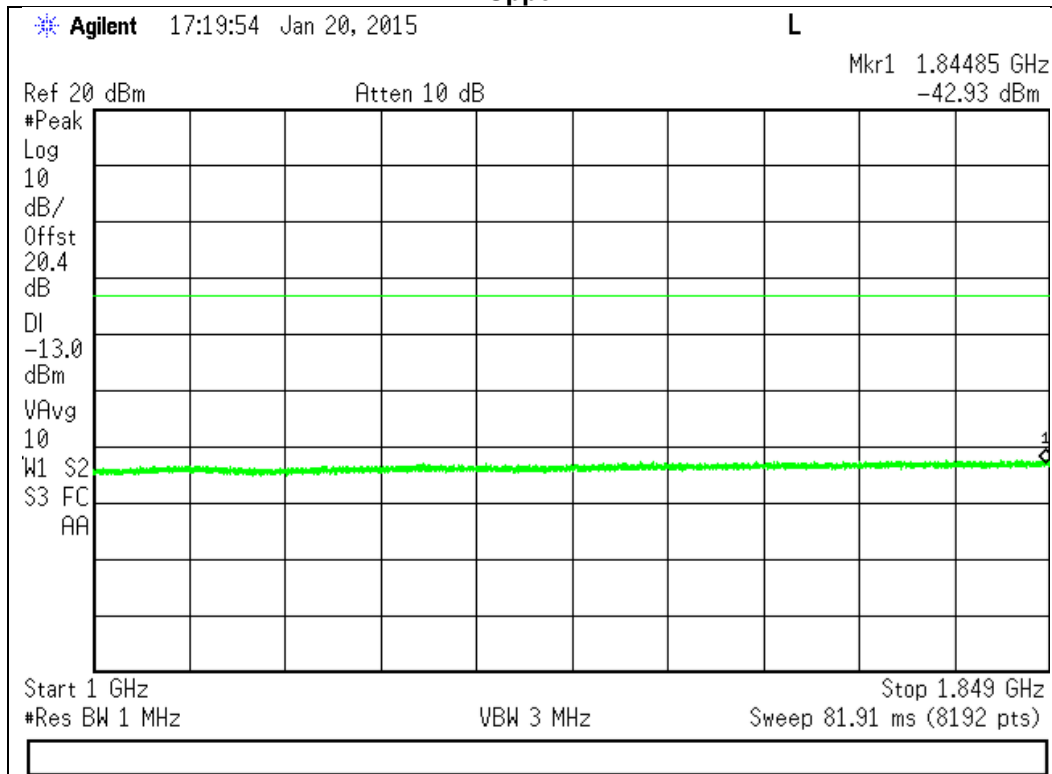

1850 - 1910 MHz Band (continued)

Upper 2

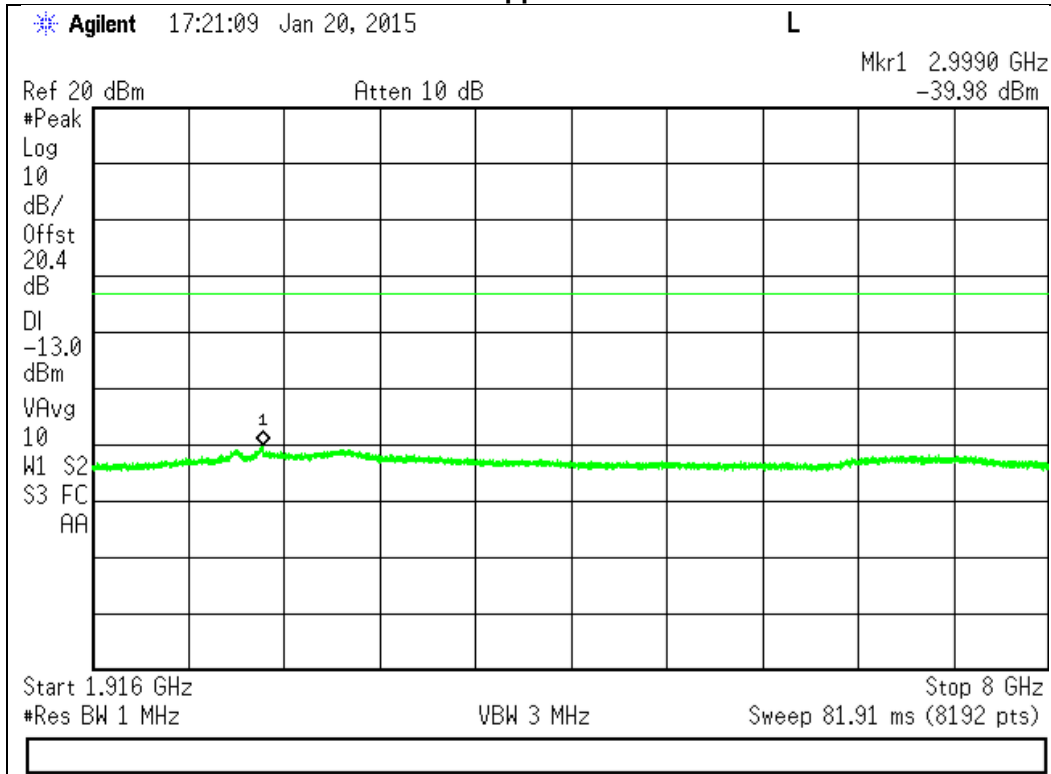

Upper 3

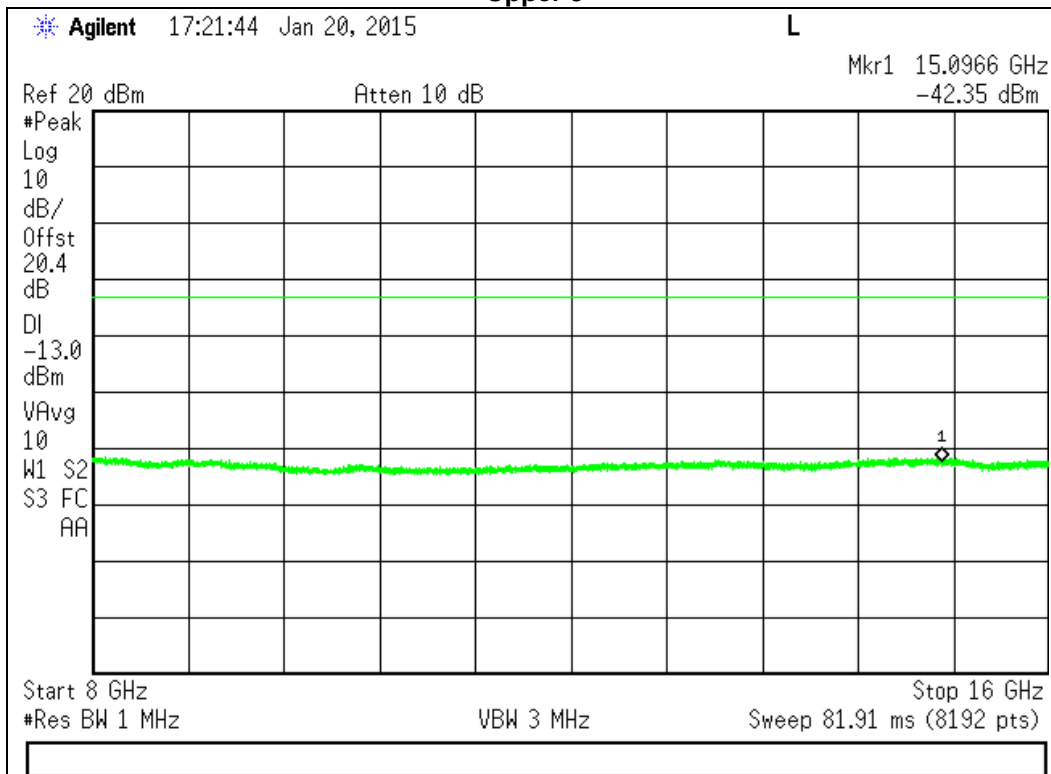

1850 - 1910 MHz Band (continued)

Upper 4

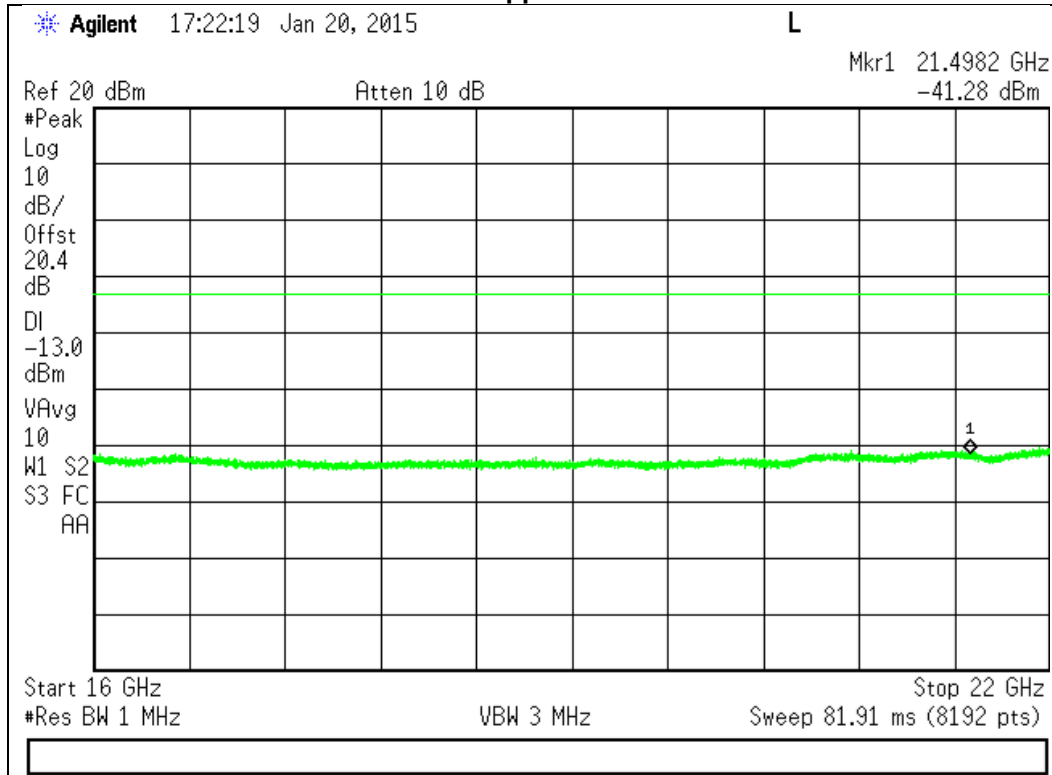

Downlink Test Plots

869 - 894 MHz Band Lower

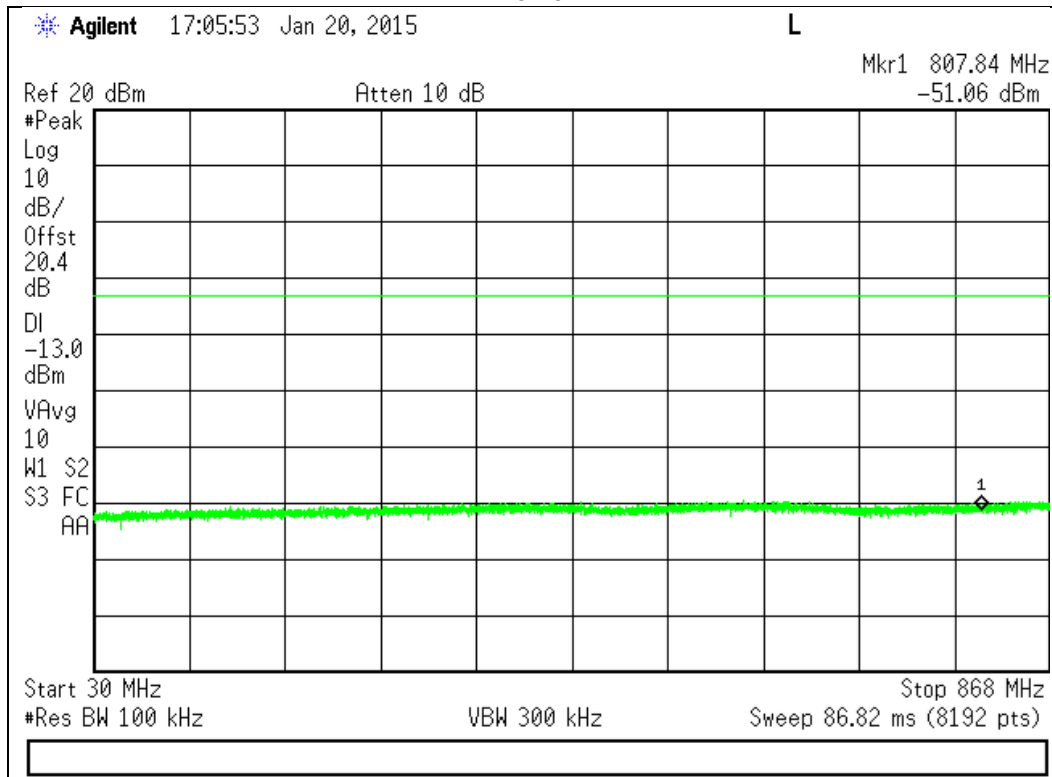

Upper

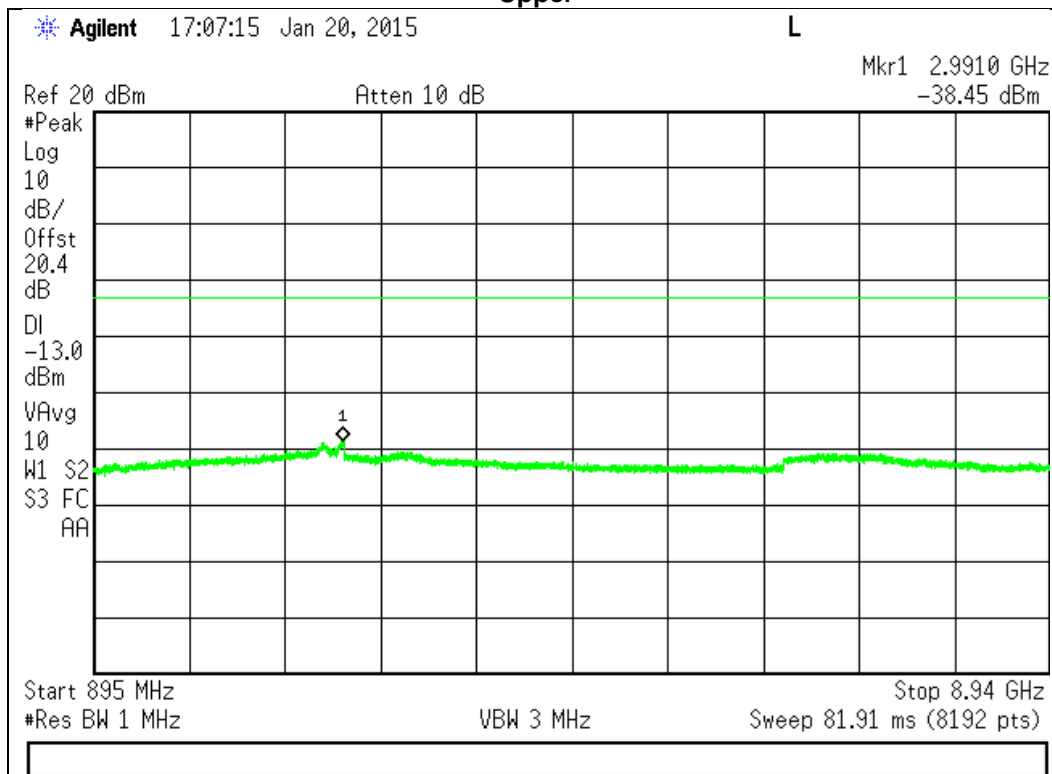

1930 - 1990 MHz Band
Lower

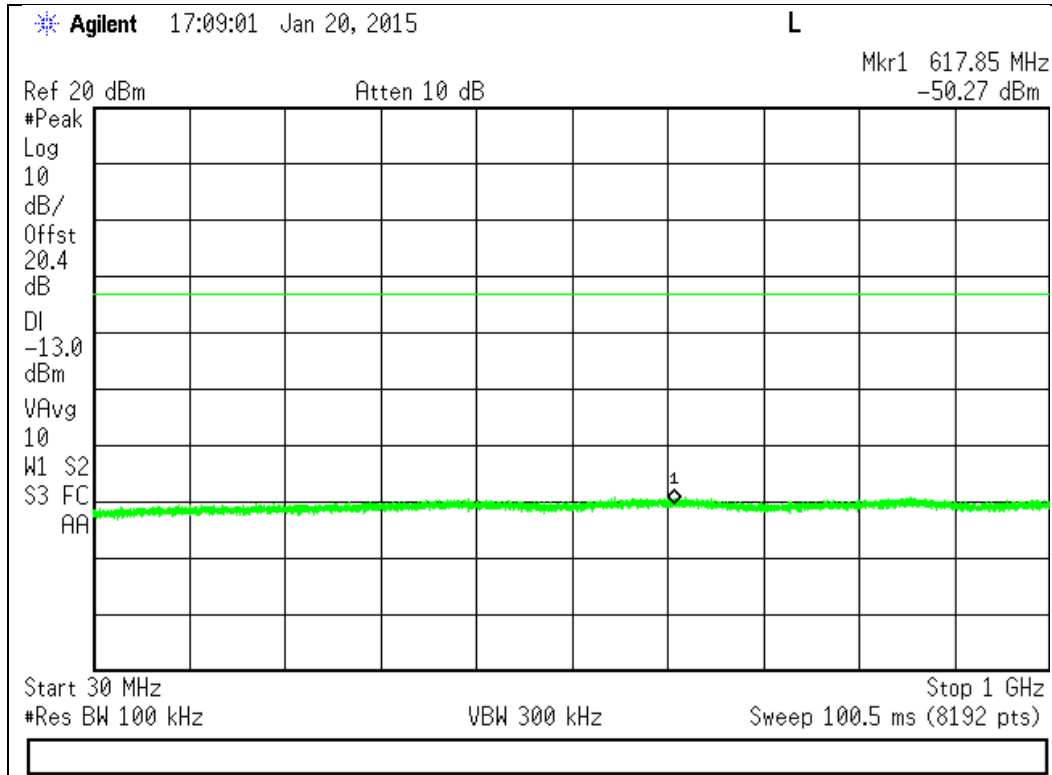

Upper 1

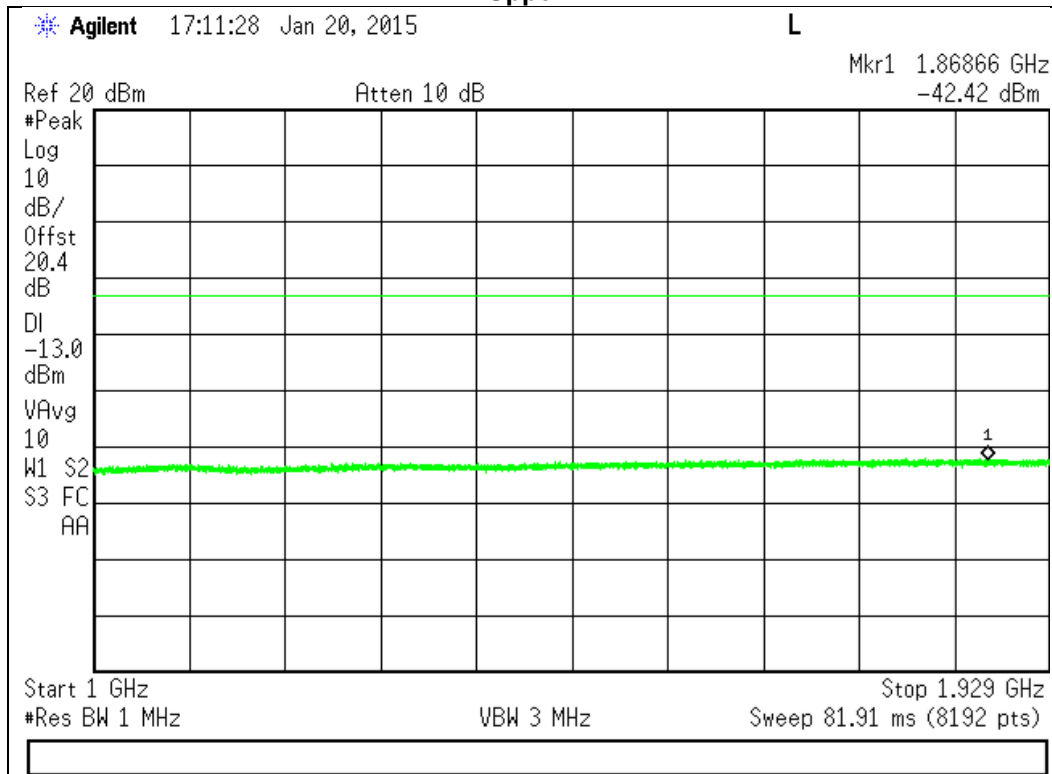

1930 - 1990 MHz Band (continued)

Upper 2

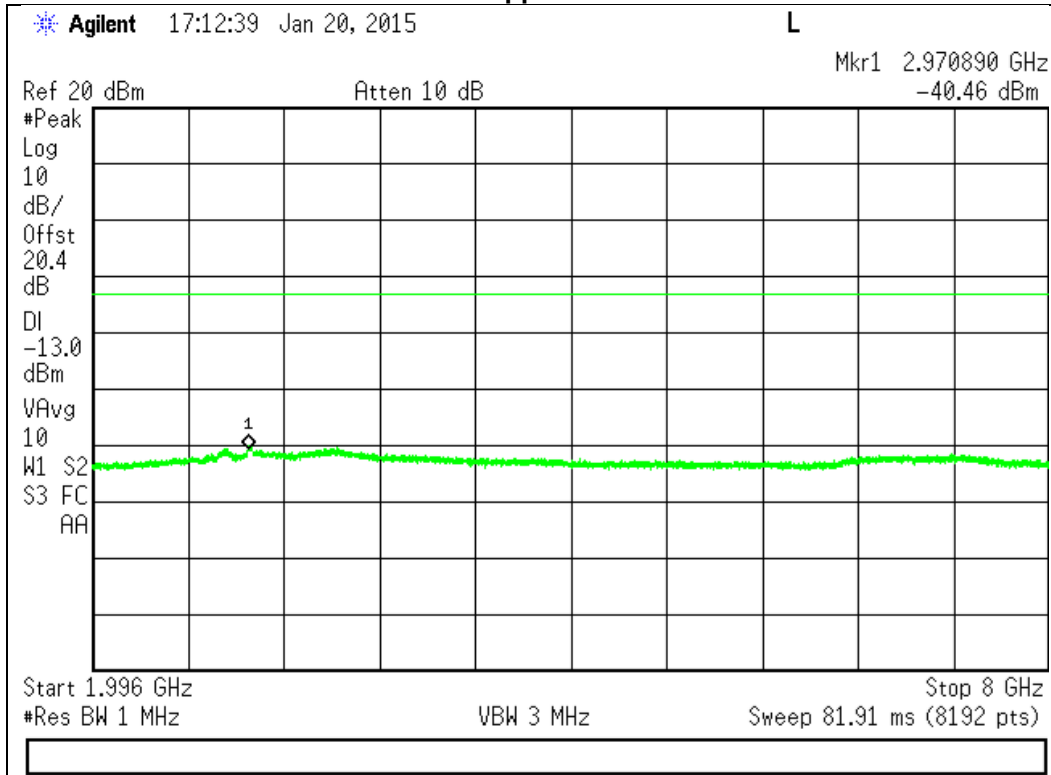

Upper 3

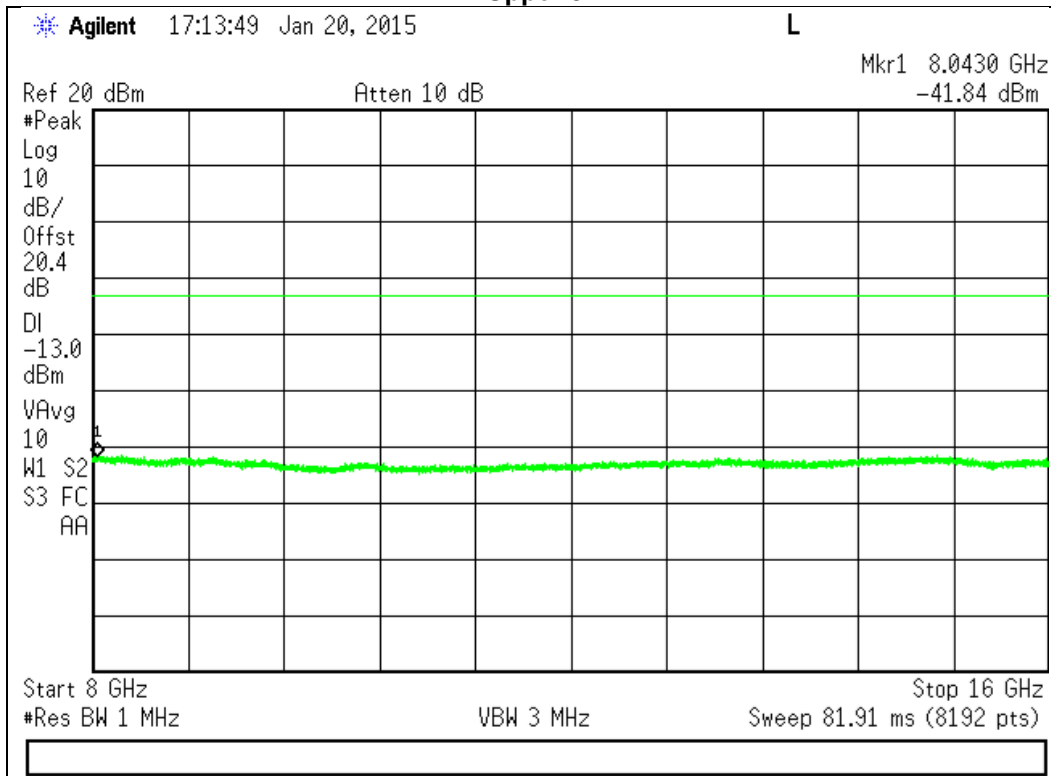

1930 - 1990 MHz Band (continued)

Upper 4

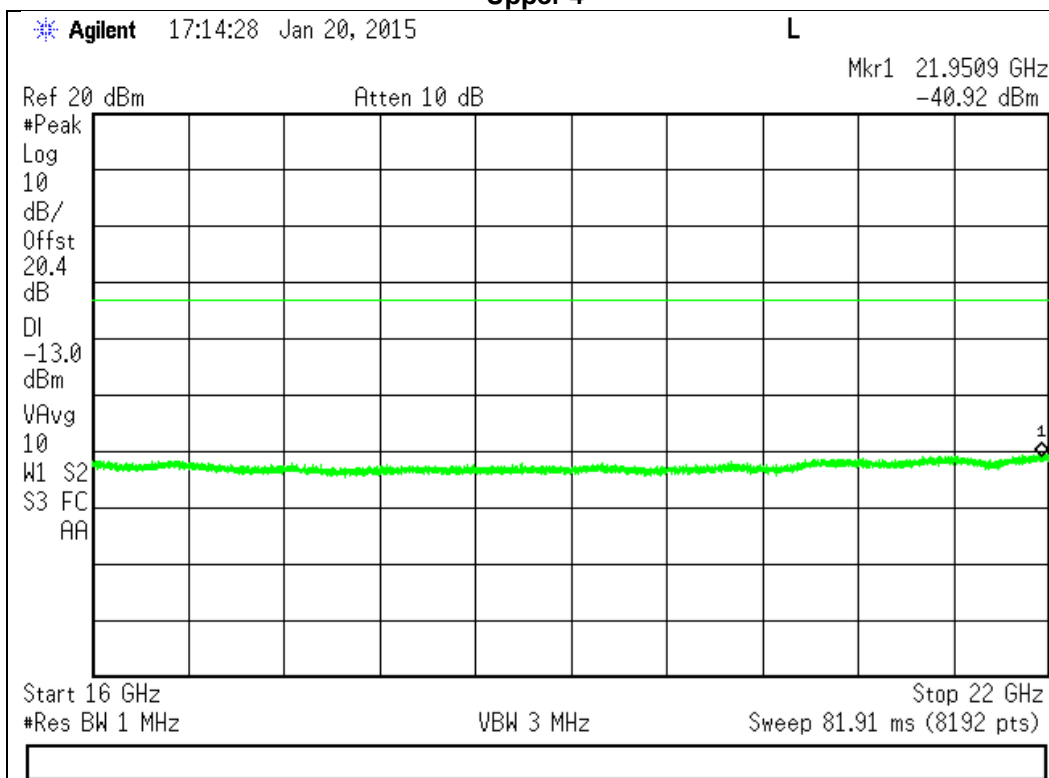

Noise Limits

Engineer: Mike Graffeo

Test Date: 1/19/2015

Test Procedure

The EUT was connected to a spectrum analyzer through an attenuator with the losses being input into the spectrum analyzer as a combination of reference level offset and correction factor as necessary to ensure that accurate readings were obtained. A series of three tests were performed: the maximum uplink and downlink noise, the variable noise for the uplink and downlink in the presence of a downlink signal, and the variable uplink noise timing. The detailed procedures from KDB 935210 D03 Wideband Consumer Signal Booster Measurement Guidance DR04-41516c were followed.

The Noise Limit is calculated using the following formula.

The following formulas are used for calculating the limits. Note – Downlink noise power limit is calculated with the center frequency of the associated uplink band.

Noise Limit = -59 dBm/MHz

Variable Noise = -103 dBm/MHz - RSSI

Test Setup

Maximum Noise Power



Variable Uplink Noise Power and Timing

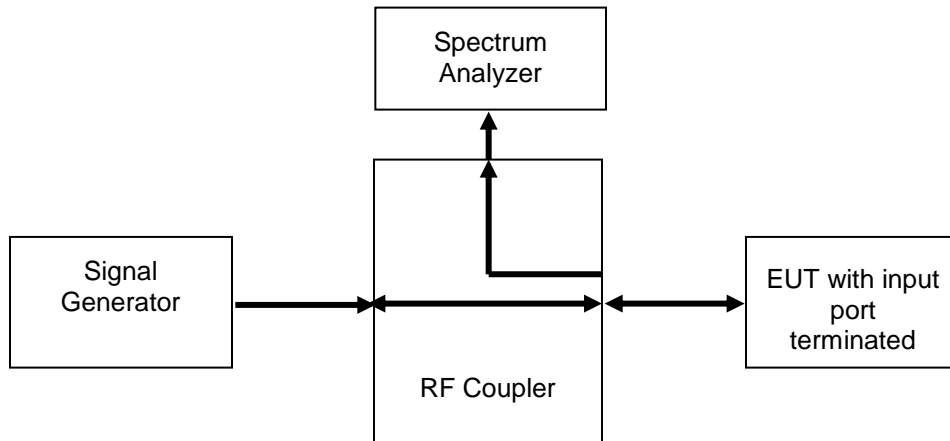

Maximum Uplink Noise Test Results

Frequency Band (MHz)	Measured Noise (dBm)	Limit (dBm)	Margin (dB)	Result
824 - 849	-72.24	-59.0	-13.2	Pass
1850 - 1910	-78.37	-59.0	-19.4	Pass

Maximum Downlink Noise Test Results

Frequency Band (MHz)	Measured Noise (dBm)	Limit (dBm)	Margin (dB)	Result
869 - 894	-94.82	-59.0	-35.8	Pass
1930 - 1990	-97.00	-59.0	-38.0	Pass

Uplink Noise Timing Test Results

Frequency Band (MHz)	Measured Timing (mS)	Limit (mS)	Result
824 - 849	24.00	3000.0	Pass
1850 - 1910	32.00	3000.0	Pass

**Variable Uplink Noise Limit Test Results
 (Green shade is RSSI dependent region)**

824 - 849 MHz (* =Transmit off)

RSSI (dBm)	Noise Limit (dBm)	Measured Noise (dBm)	Margin (dB)
-56.0	-59.0	-71.2	-12.2
-55.0	-59.0	-71.2	-12.2
-54.0	-59.0	-78.0 *	-19.0
-53.0	-59.0	-78.0 *	-19.0
-36.0	-67.0	-78.0 *	-11.0
-35.0	-68.0	-78.0 *	-10.0

1850 - 1910 MHz (* =Transmit off)

RSSI (dBm)	Noise Limit (dBm)	Measured Noise (dBm)	Margin (dB)
-46.0	-59.0	-78.0	-19.0
-45.0	-59.0	-78.0	-19.0
-36.0	-67.0	-78.0	-11.0
-35.0	-68.0	-78.0	-10.0
-34.0	-69.0	-81.0 *	-12.0
-33.0	-70.0	-81.0 *	-11.0

Maximum Uplink Noise Test Plots

824 - 849 MHz Band

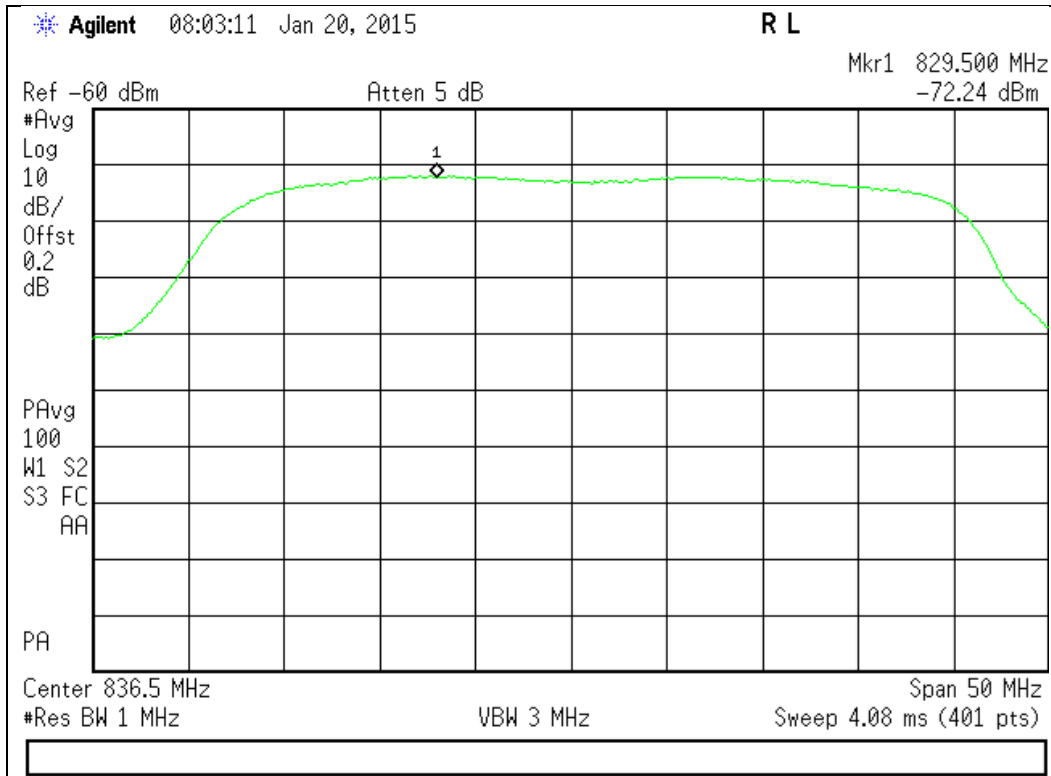

1850 - 1910 MHz Band

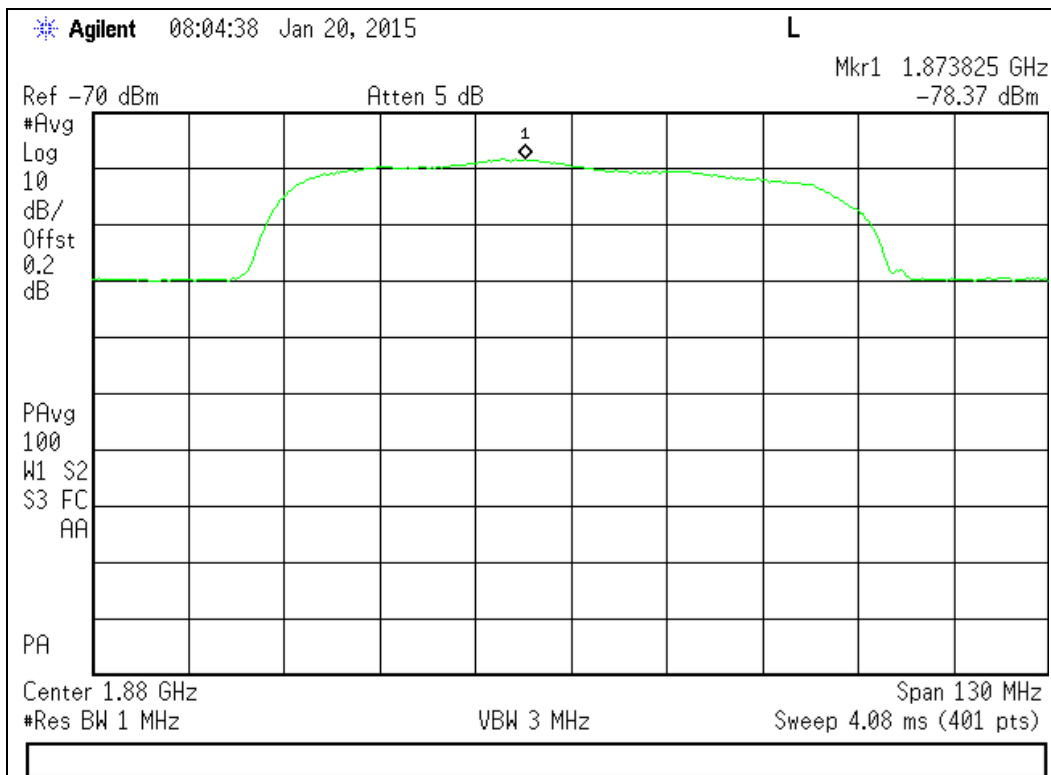

Maximum Downlink Noise Test Plots

869 - 894 MHz Band

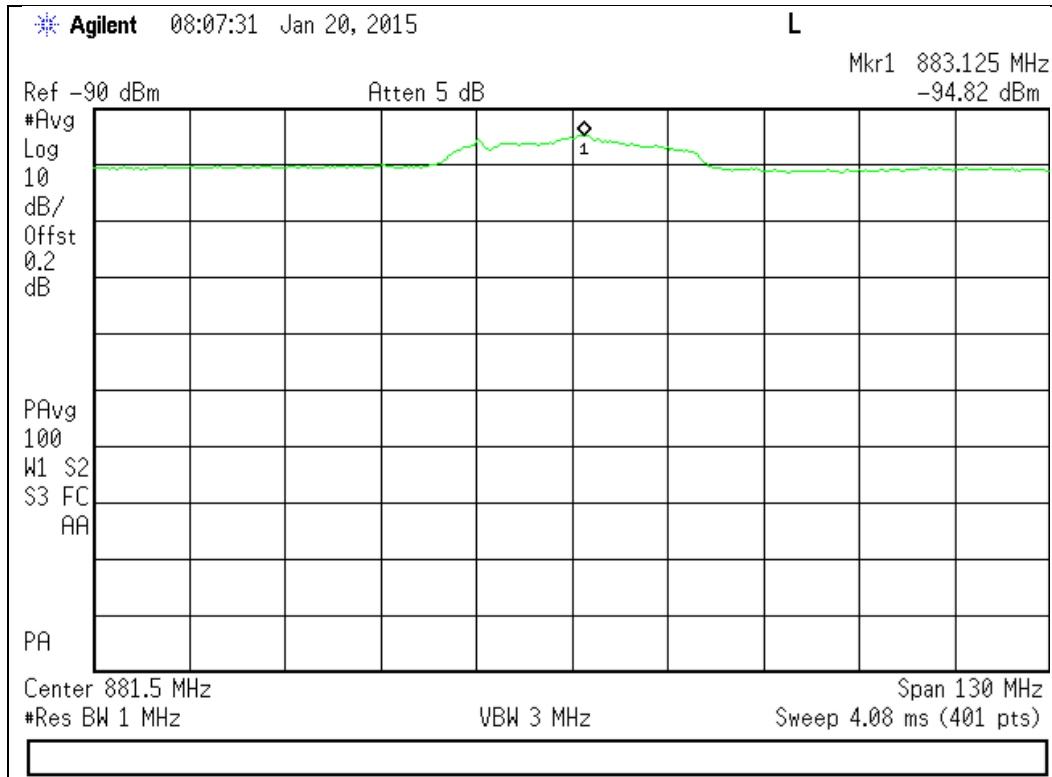

1930 - 1990 MHz Band

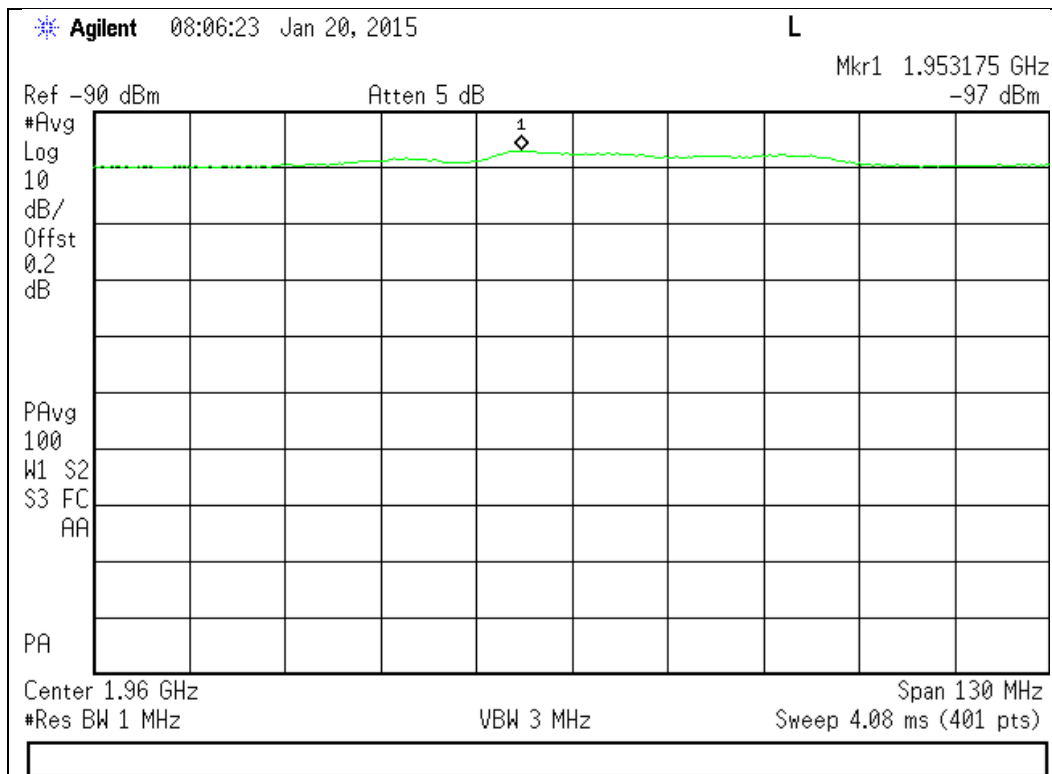

Uplink Noise Timing Test Plots

824 - 849 MHz Band

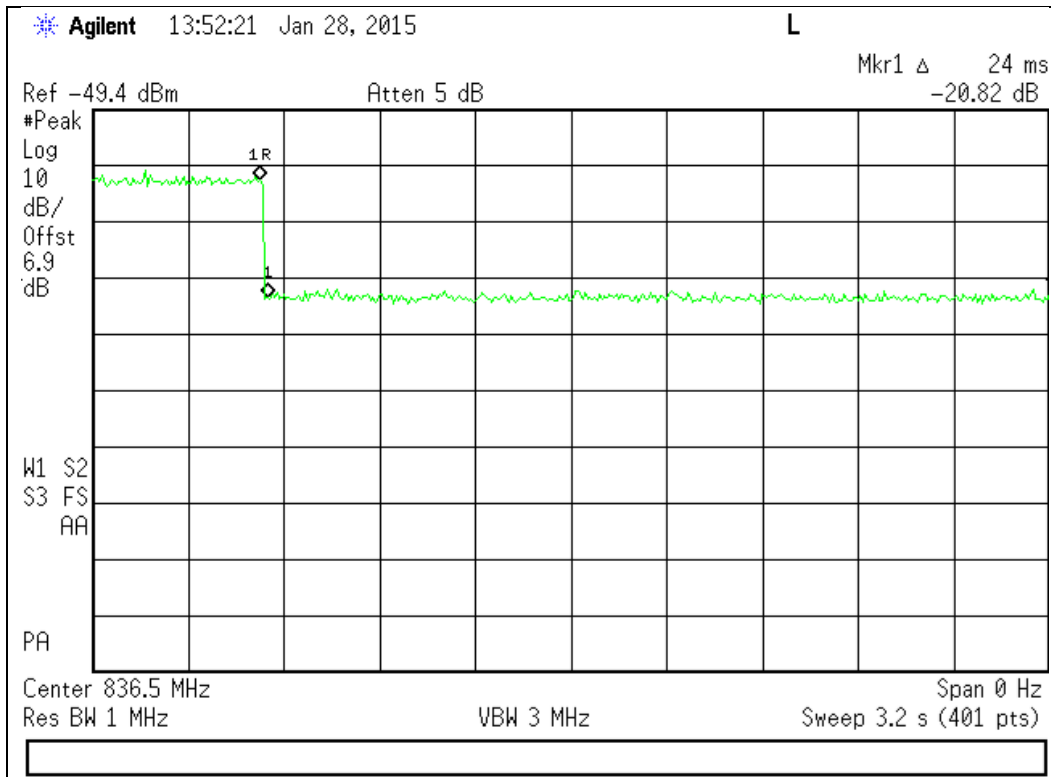

1850 - 1910 MHz Band

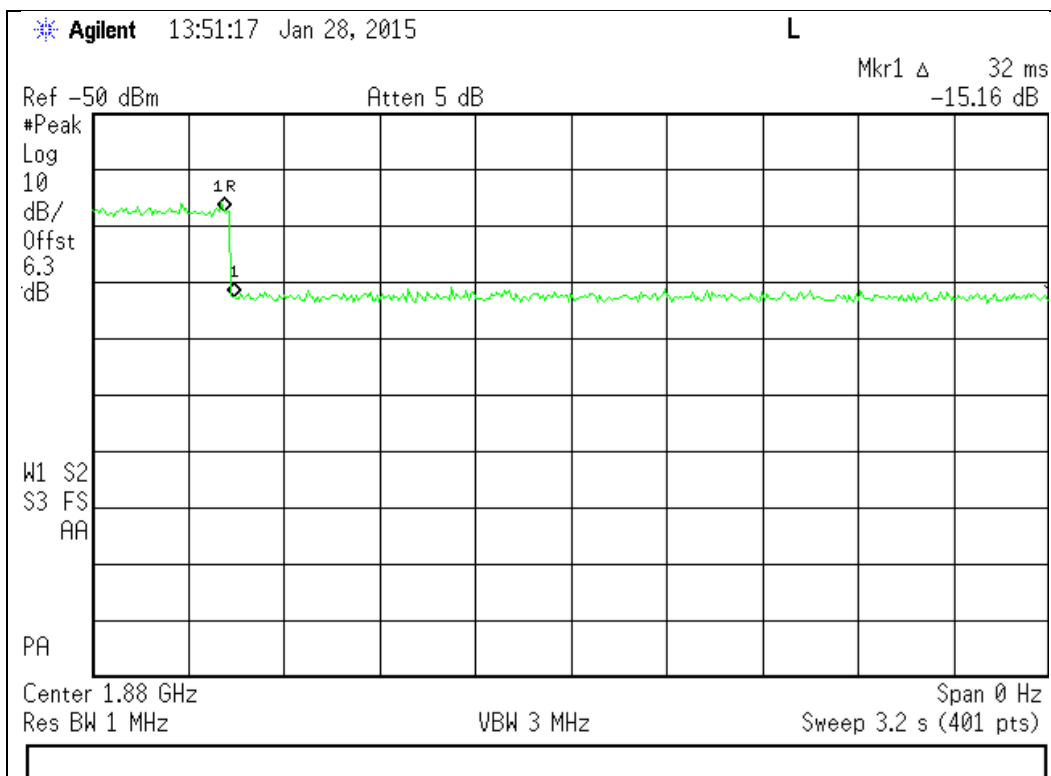

Uplink Inactivity

Engineer: Mike Graffeo

Test Date: 1/19/2015

Test Procedure

The EUT was connected directly to a spectrum analyzer set to operate in the center of the EUT operational uplink and downlink bands. The span was set to 0 Hz with a sweep time of 330 seconds and MAX HOLD operation. The EUT was powered on and the time for the uplink to return to an inactive state was measured using the DELTA MARKER method to ensure that it was less than 300 seconds. The noise level after the return to an inactive state was less than -70 dBm/MHz

Test Setup

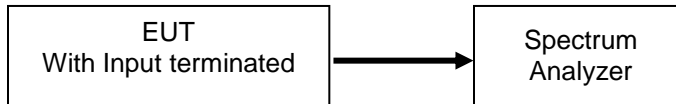

Uplink Test Results

Frequency Band (MHz)	Measured Time (Seconds)	Limit (Seconds)	Result
824 - 849	298.7	300	Pass
1850 - 1910	259.9	300	Pass

Uplink Inactivity Test Results

824 - 849 MHz

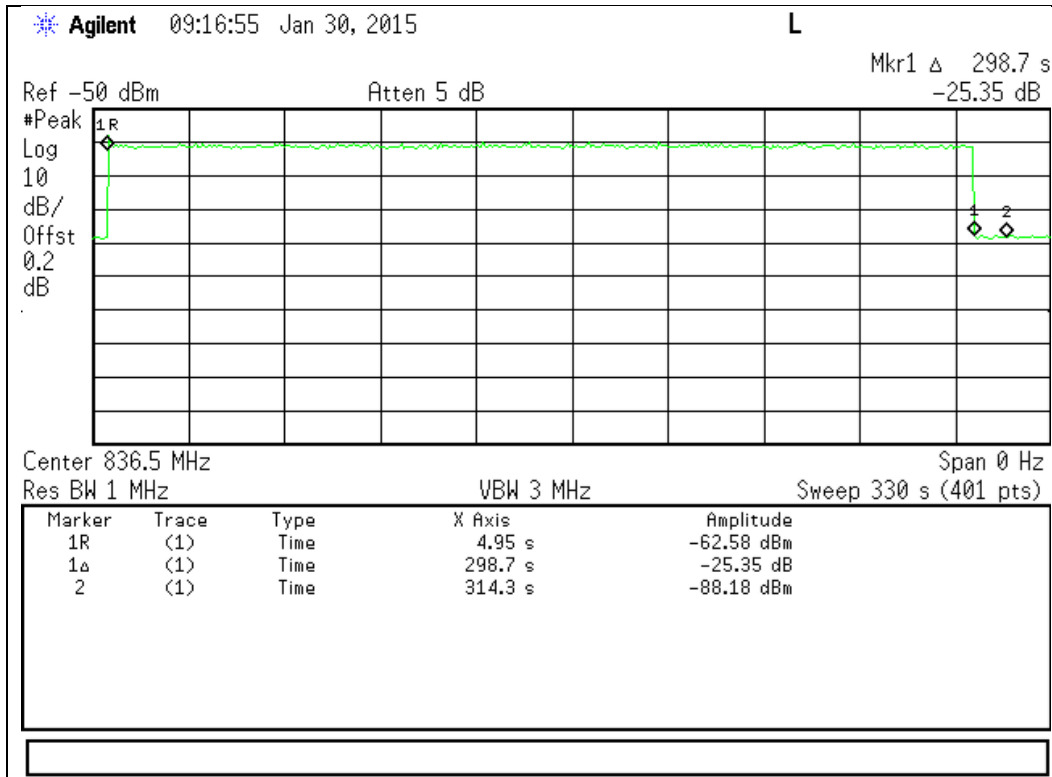

1850 - 1910 MHz

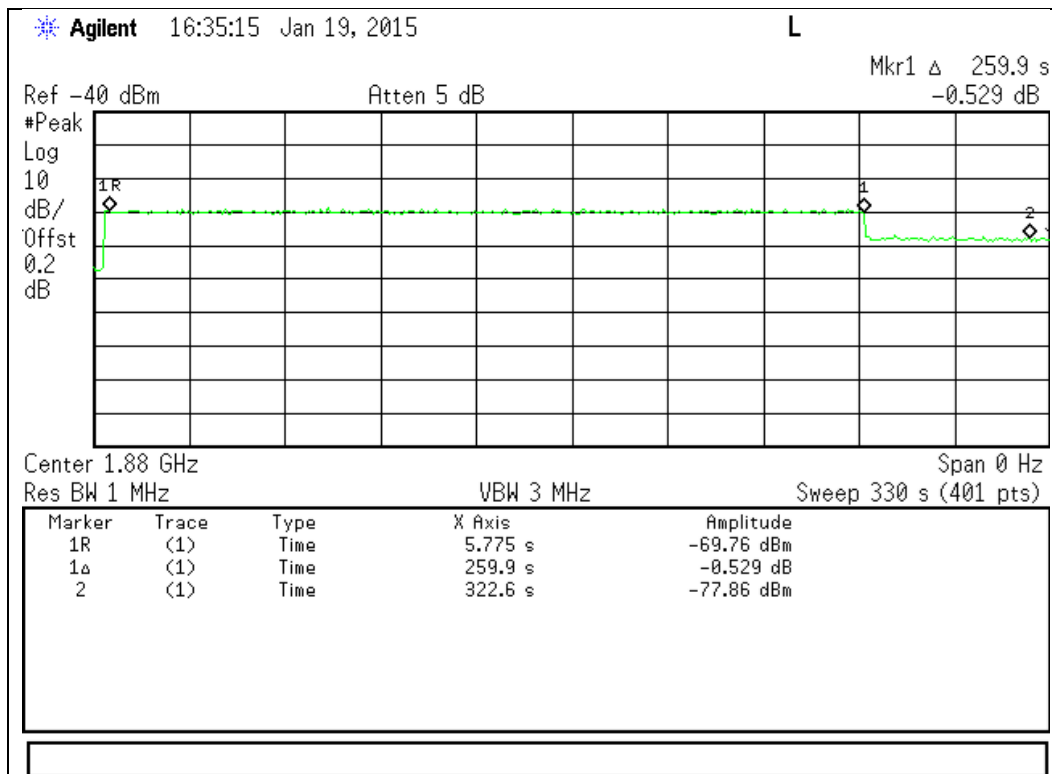

Variable Gain

Engineer: Mike Graffeo

Test Date: 1/28/2015

Test Procedure

The EUT was connected to a spectrum analyzer through an attenuator with the losses being input into the spectrum analyzer as a combination of reference level offset and correction factor in order to ensure accurate readings were obtained. The uplink gain in the presence of a downlink signal was measured for each operational uplink band using the detailed procedures from KDB 935210 D03 Wideband Consumer Signal Booster Measurement Guidance DR04-41516.

The following formula is used for calculating the limits:

$$\text{Variable Gain} = -34 \text{ dB} - \text{RSSI} + \text{MSCL}$$

Test Setup

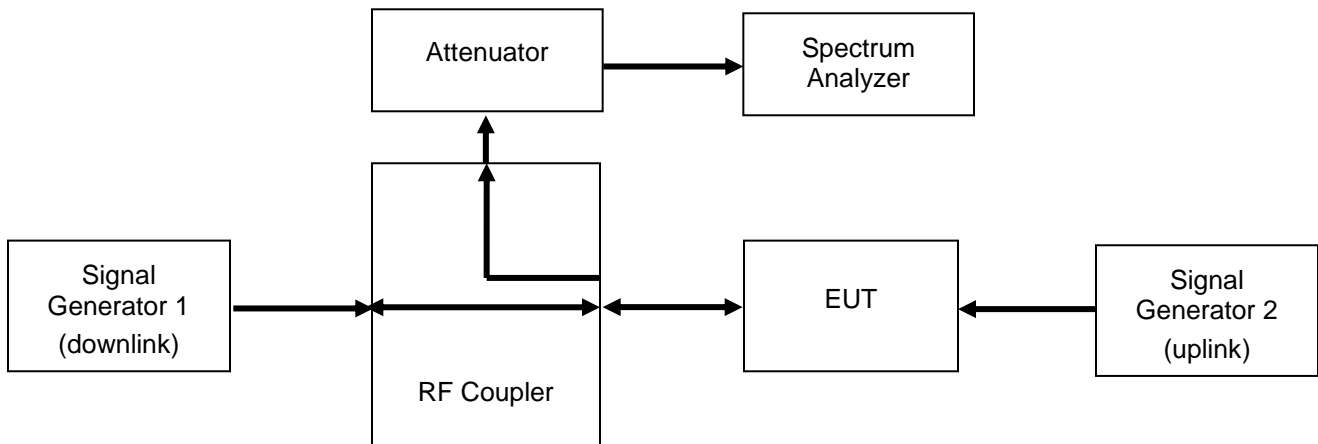

Uplink Test Results
 Green shade is RSSI dependent region)

824 - 849 MHz (* = Transmit off)

RSSI (dBm)	MSCL (dB)	Gain Limit (dBm)	P(in) (dBm)	P(out) (dBm)	Gain (dB)	Margin (dB)
-52.0	0.0	15.0	7.2	15.5	8.3	-6.7
-51.0	0.0	15.0	7.2	-42.0 *	-49.2	-64.2
-50.0	0.0	15.0	7.2	-42.0 *	-49.2	-64.2
-49.0	0.0	15.0	7.2	-42.0 *	-49.2	-64.2
-48.0	0.0	14.0	7.2	-42.0 *	-49.2	-63.2
-47.0	0.0	13.0	7.2	-42.0 *	-49.2	-62.2

1850 – 1910 MHz (* = Transmit off)

RSSI (dBm)	MSCL (dB)	Gain Limit (dBm)	P(in) (dBm)	P(out) (dBm)	Gain (dB)	Margin (dB)
-49.0	0.0	15.0	4.2	17.1	12.9	-2.1
-48.0	0.0	14.0	4.2	17.1	12.9	-1.1
-47.0	0.0	13.0	4.2	17.1	12.9	-0.1
-46.0	0.0	12.0	4.2	16.1	11.9	-0.1
-45.0	0.0	11.0	4.2	15.1	10.9	-0.1
-44.0	0.0	10.0	4.2	14.1	9.9	-0.1
-42.0	0.0	8.0	4.2	-42.0 *	-46.2	-54.2

Uplink Gain Timing Test Results

Frequency Band (MHz)	Measured Timing (mS)	Limit (mS)	Result
824 - 849	40.15	1000.0	Pass
1850 - 1910	32.00	1000.0	Pass

Uplink Gain Timing Plot 824 - 849 MHz

Agilent 13:33:01 Jan 28, 2015

L

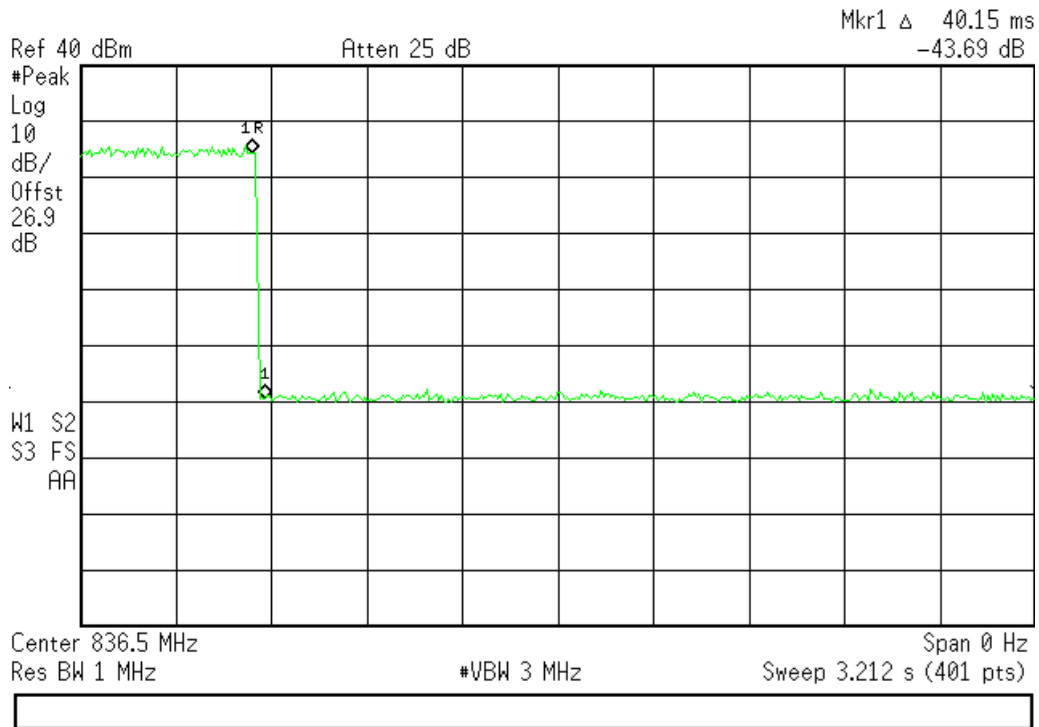

Uplink Gain Timing Plot 1850 - 1910 MHz

Agilent 13:40:55 Jan 28, 2015

L

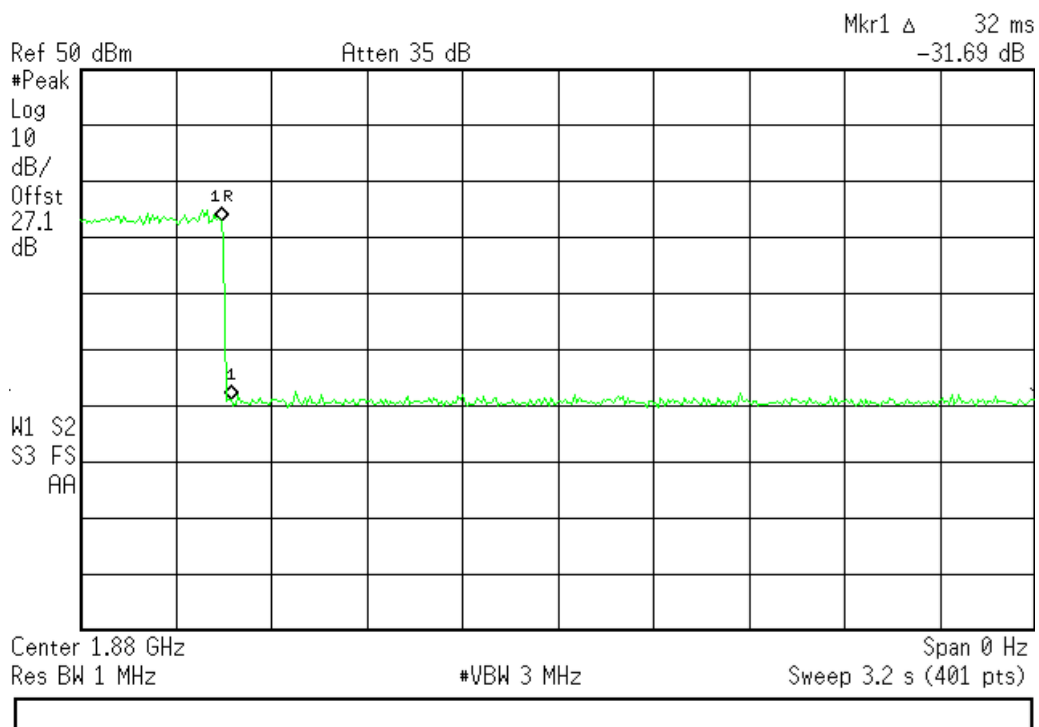

Occupied Bandwidth

Engineer: Mike Graffeo

Test Date: 1/19/2015

Test Procedure

The EUT was connected to a spectrum analyzer through an attenuator with the losses being input into the spectrum analyzer as a combination of reference level offset and correction factor as required to ensure that accurate readings were obtained. A signal generator was utilized to produce the following signals: GSM, CDMA, and WCDMA. The signal generator was tuned to the center channel of each of the EUT operational uplink and downlink bands with the RF level set at a point just prior to the AGC being in control of the power. For each modulation type, the input and output signal was measured and plotted to ensure that the signals were similar.

Test Setup

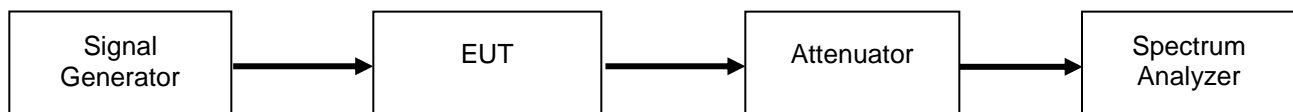

GSM Uplink Test Plots

824 - 849 MHz Band

Input

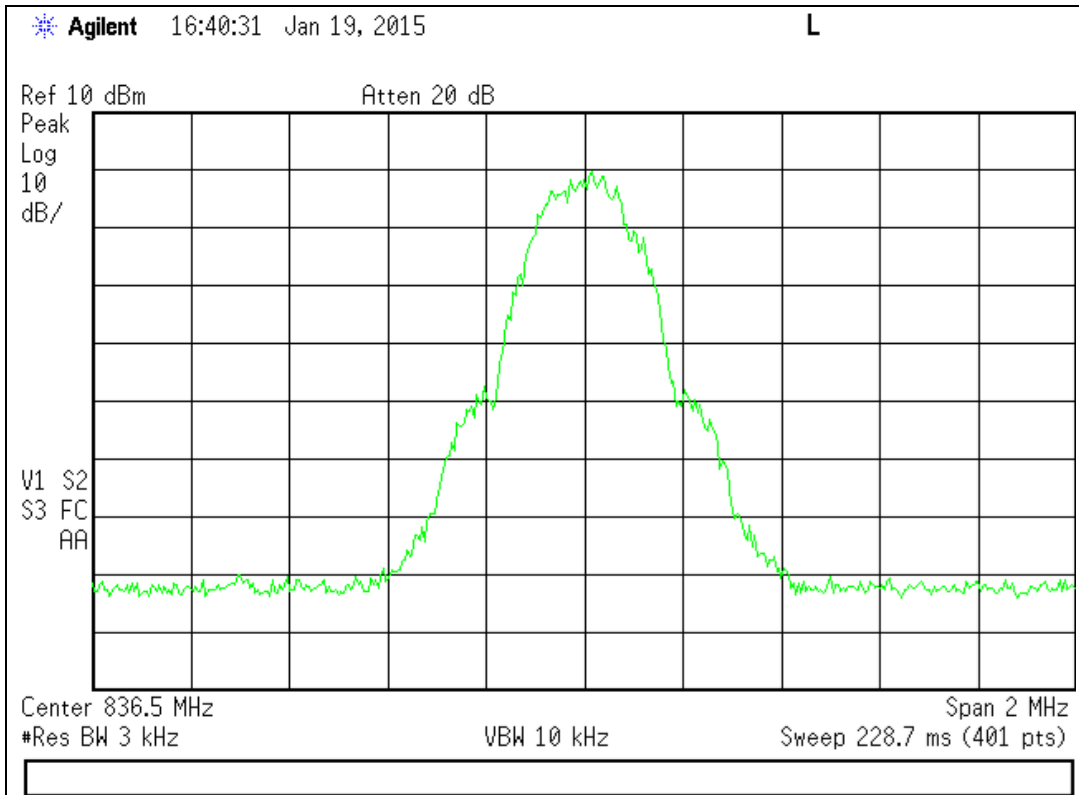

Output

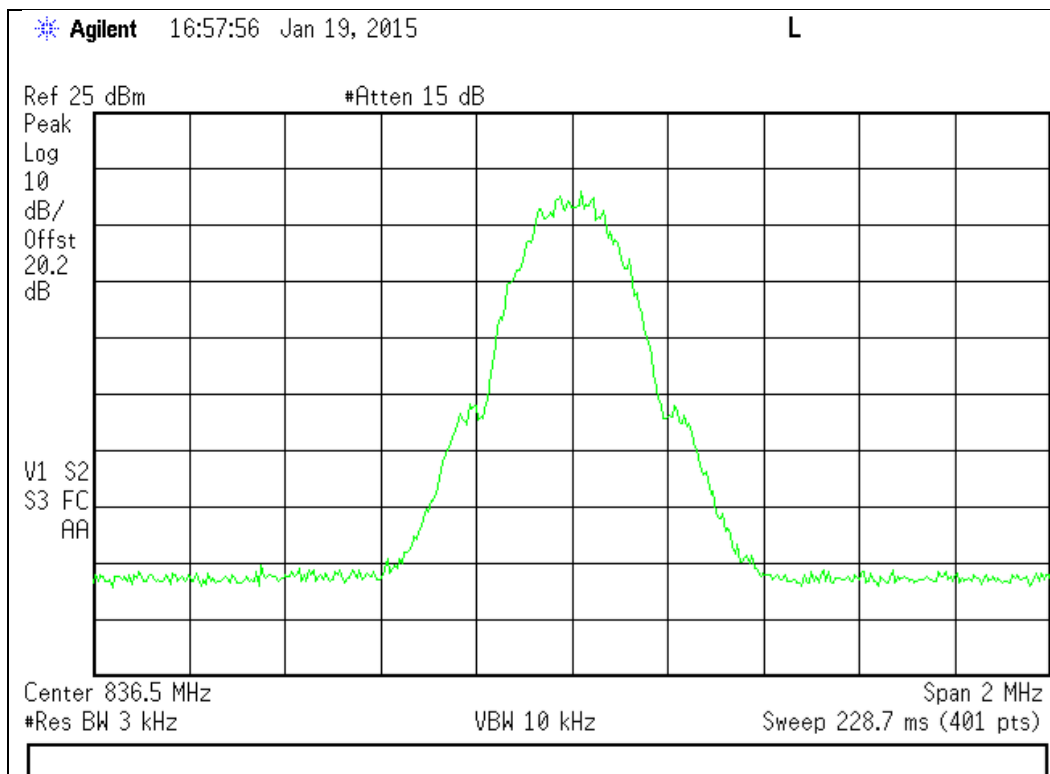

1850 - 1910 MHz Band

Input

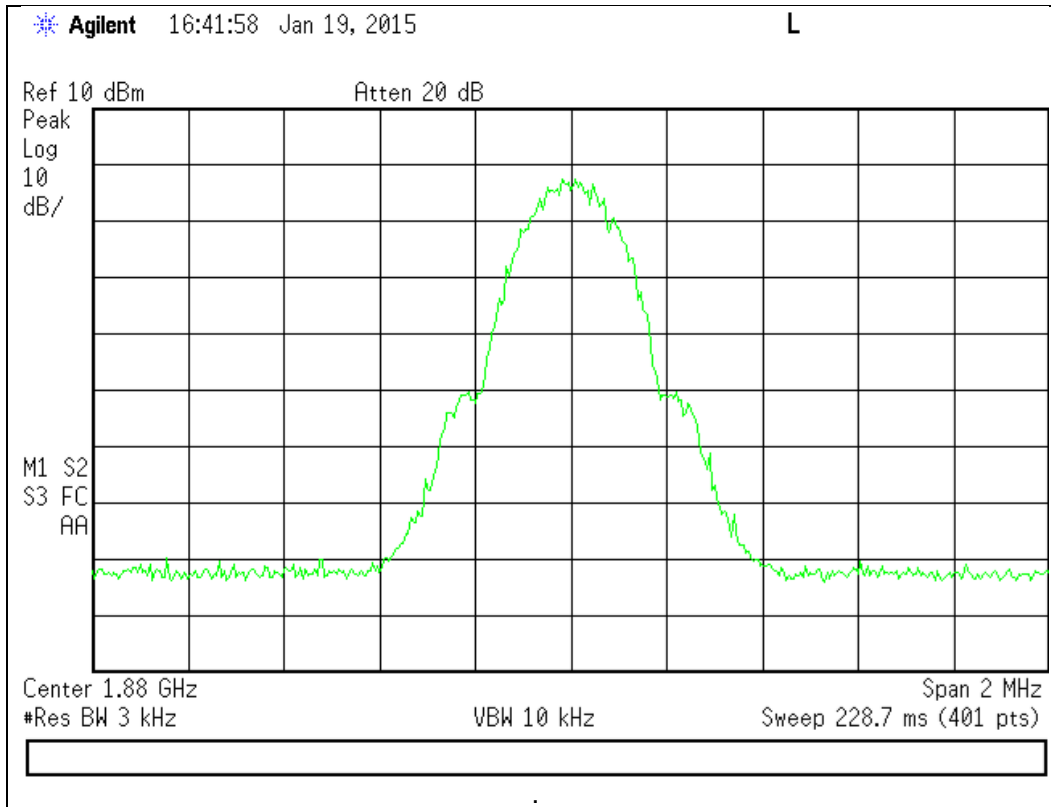

Output

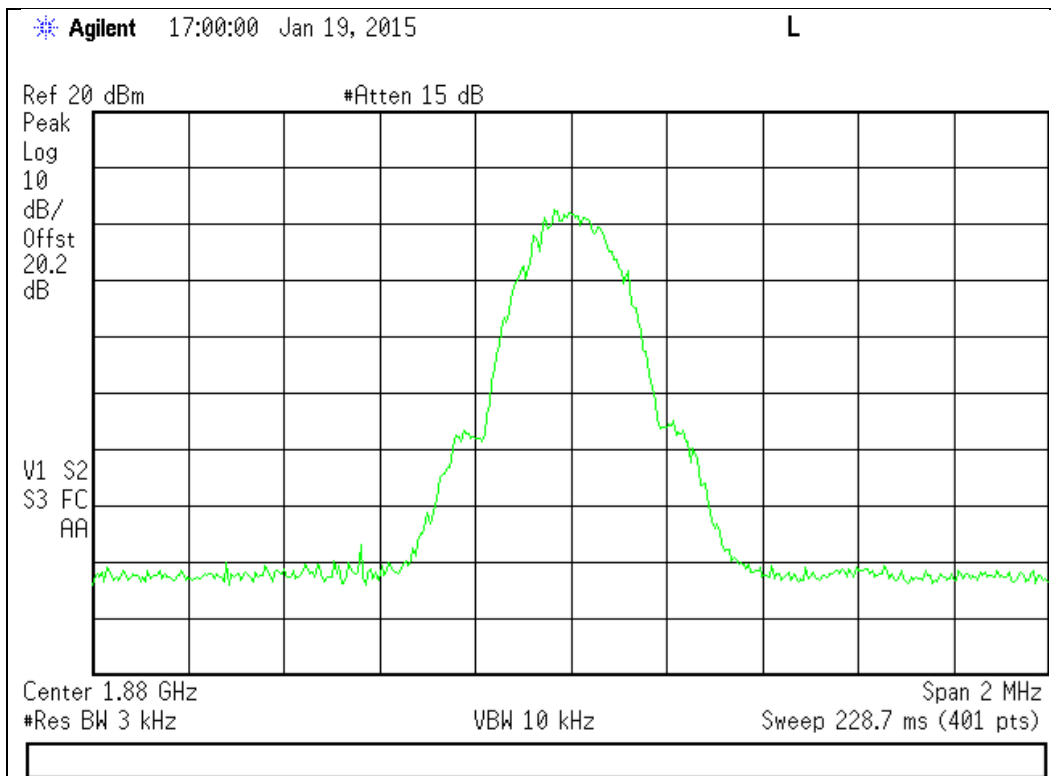

GSM Downlink Test Plots

869 - 894 MHz Band

Input

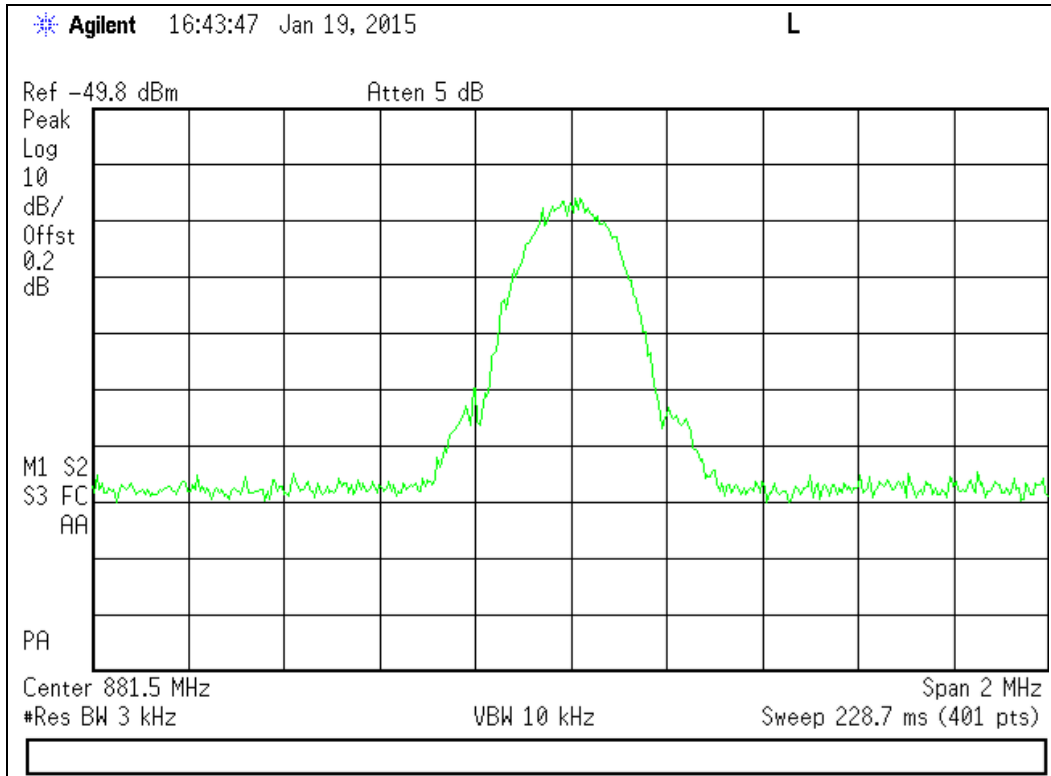

Output

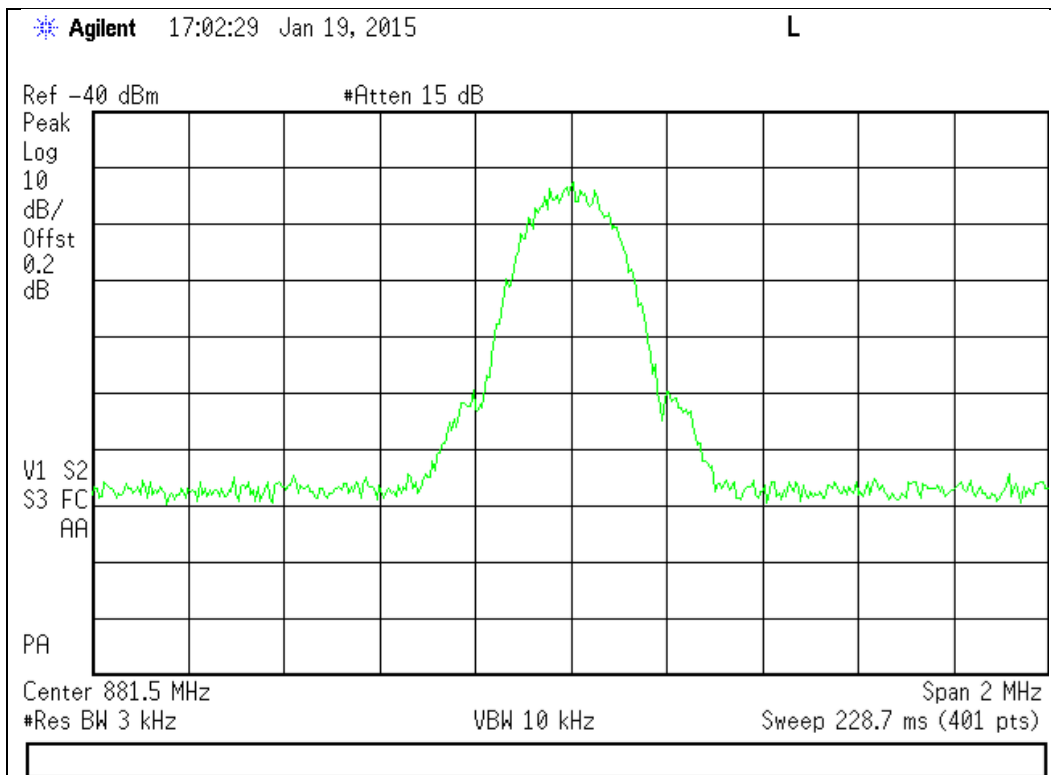

1930 - 1990 MHz Band

Input

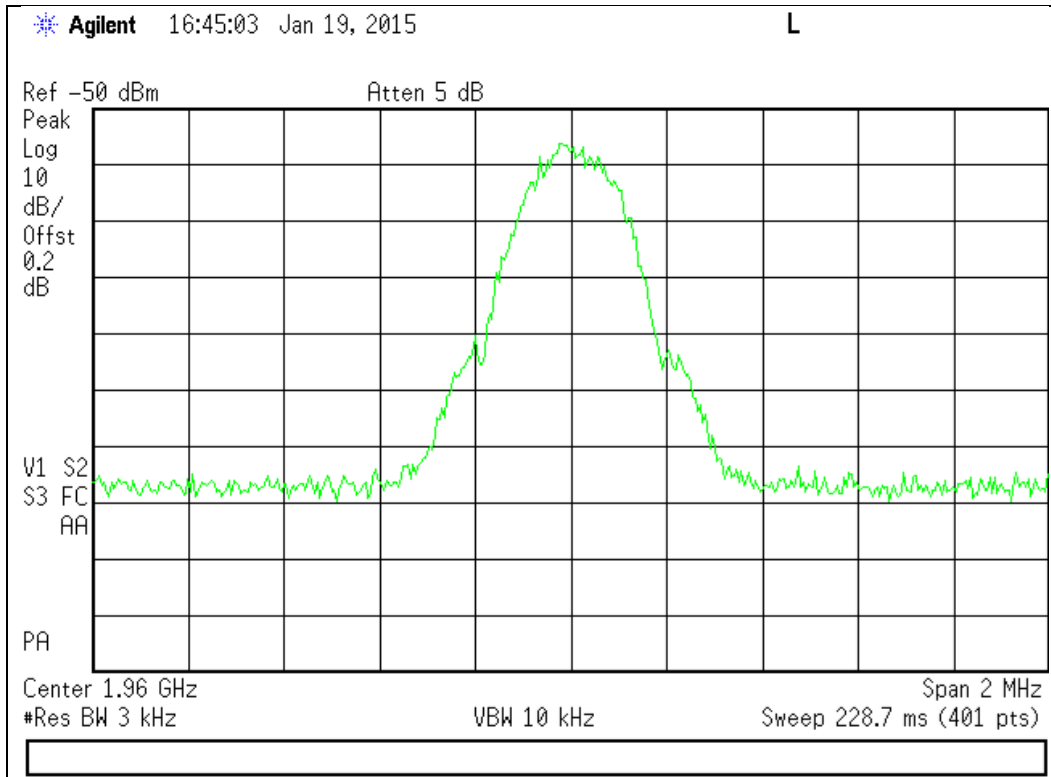

Output

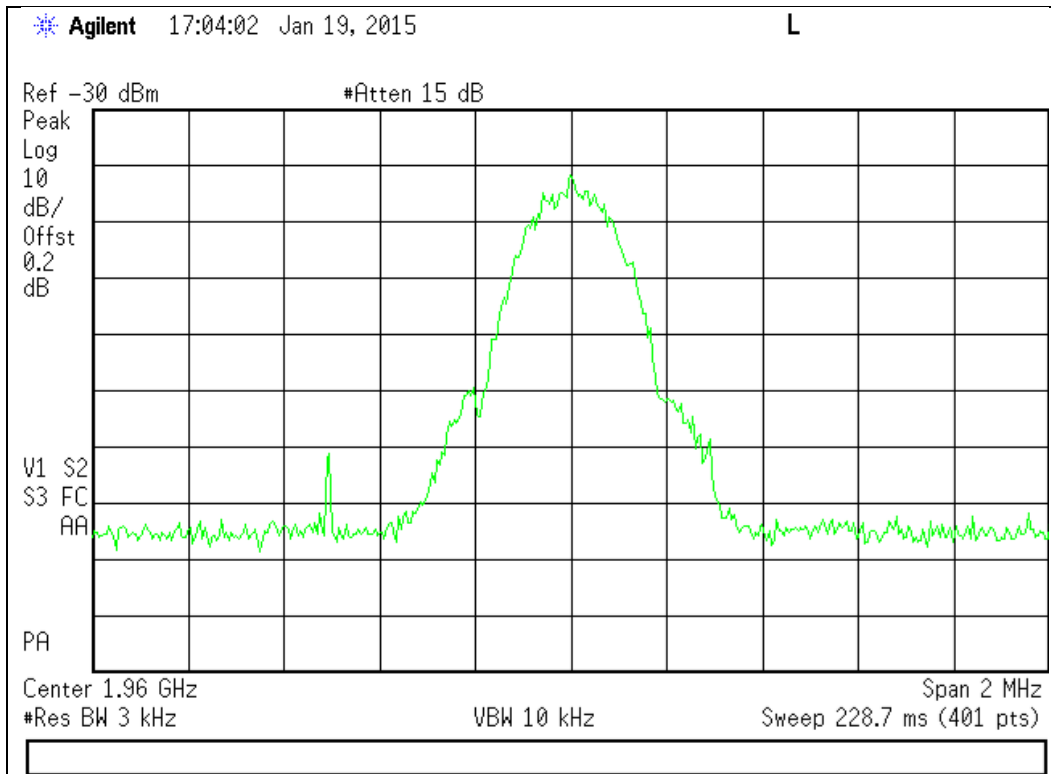

CDMA Uplink Test Plots

824 - 849 MHz Band

Input

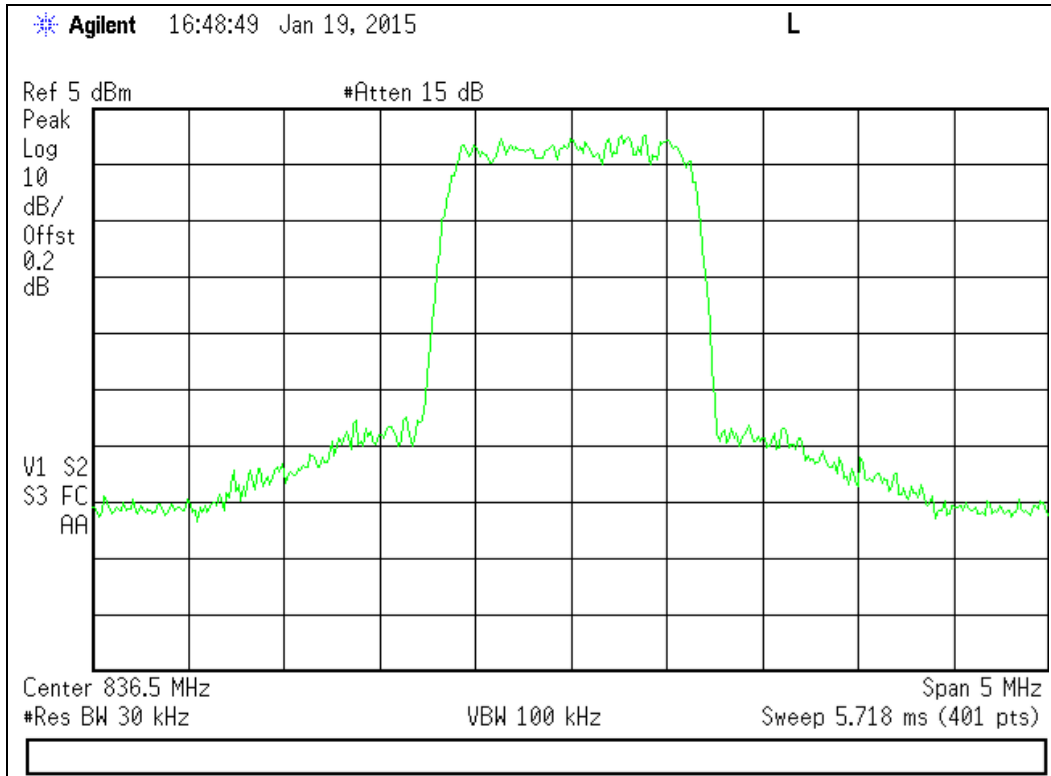

Output

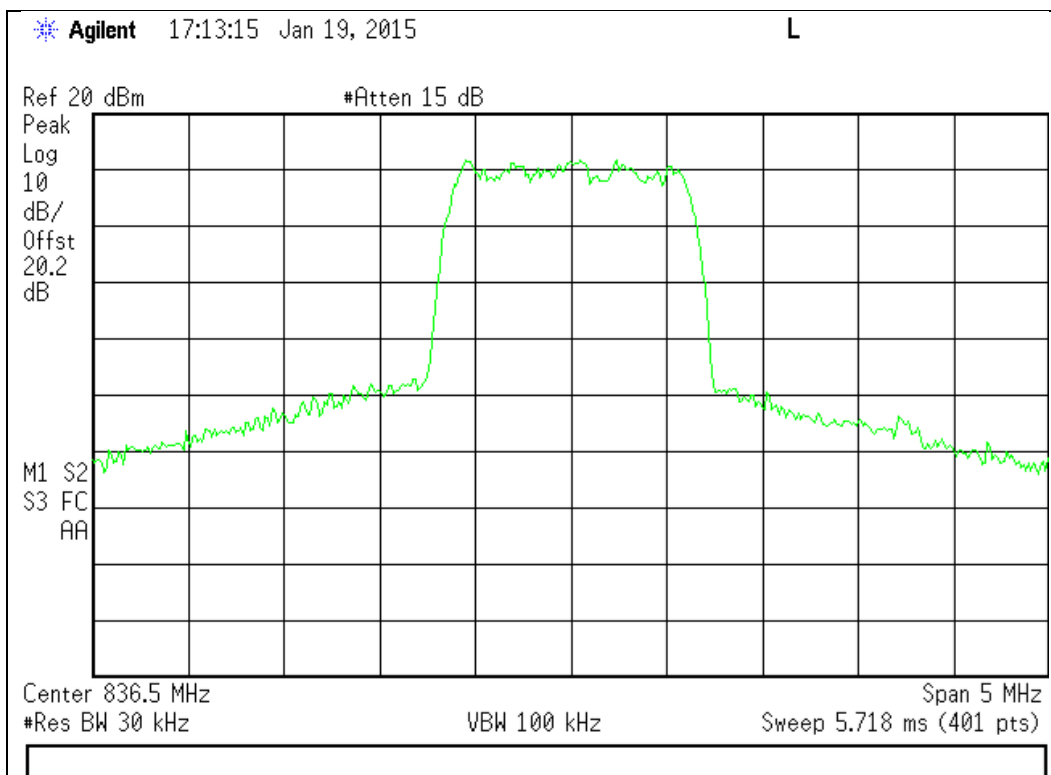

1850 - 1910 MHz Band

Input

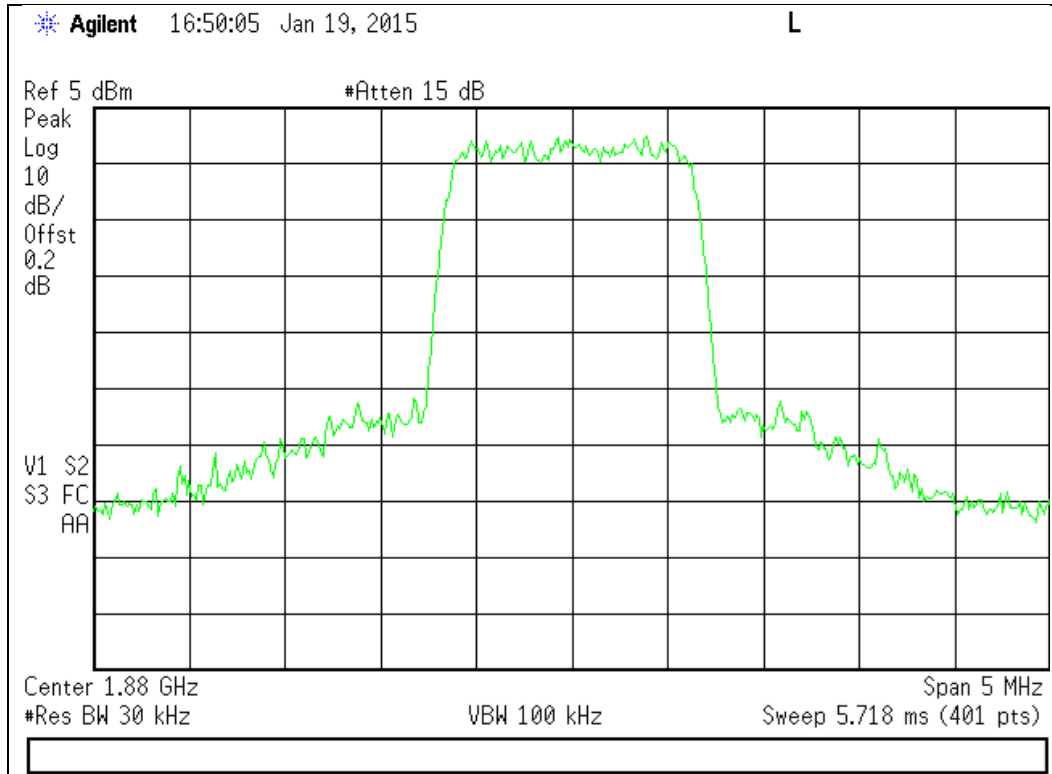

Output

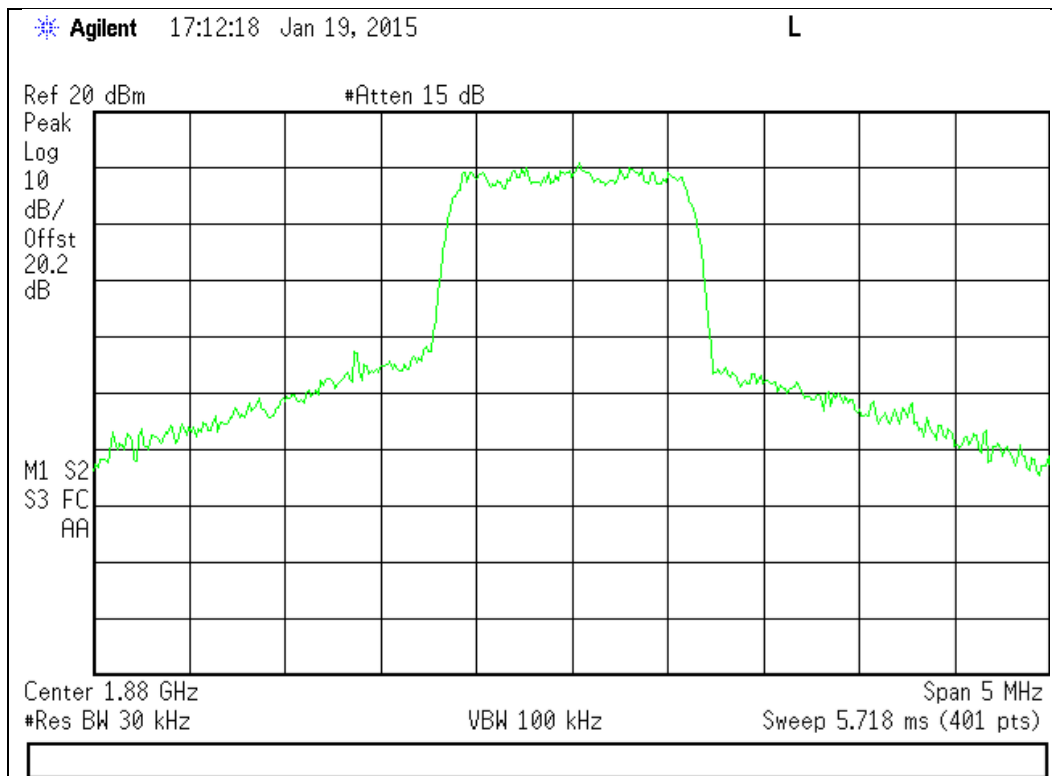

CDMA Downlink Test Plots

869 - 894 MHz Band

Input

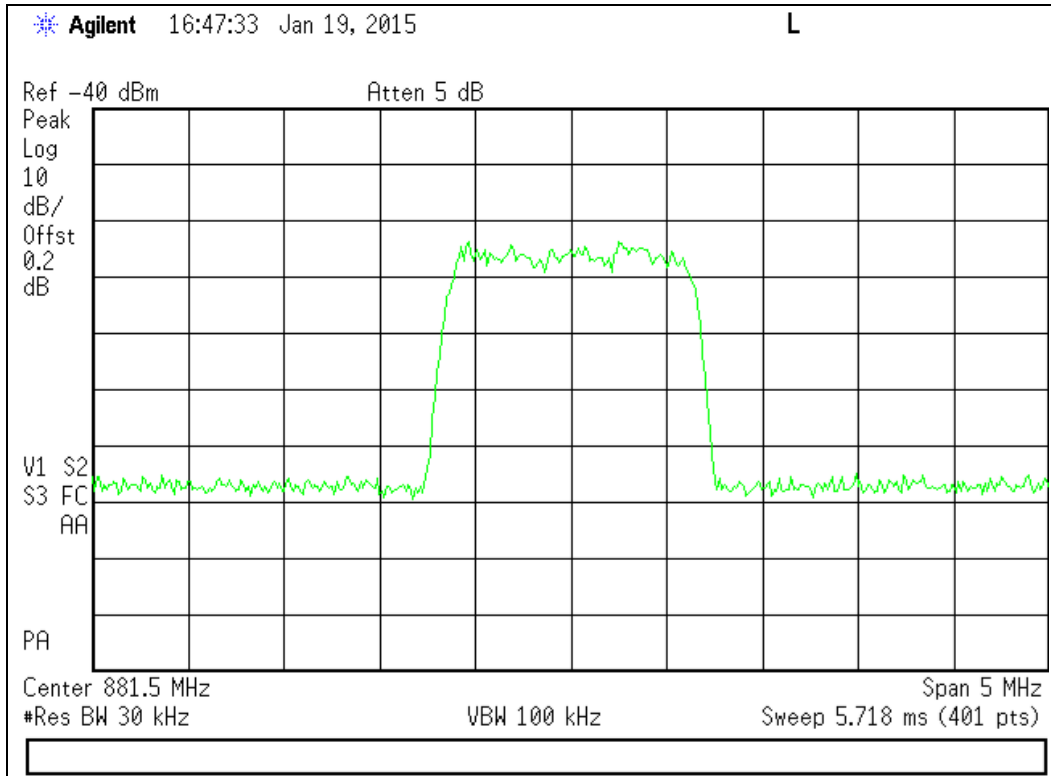

Output

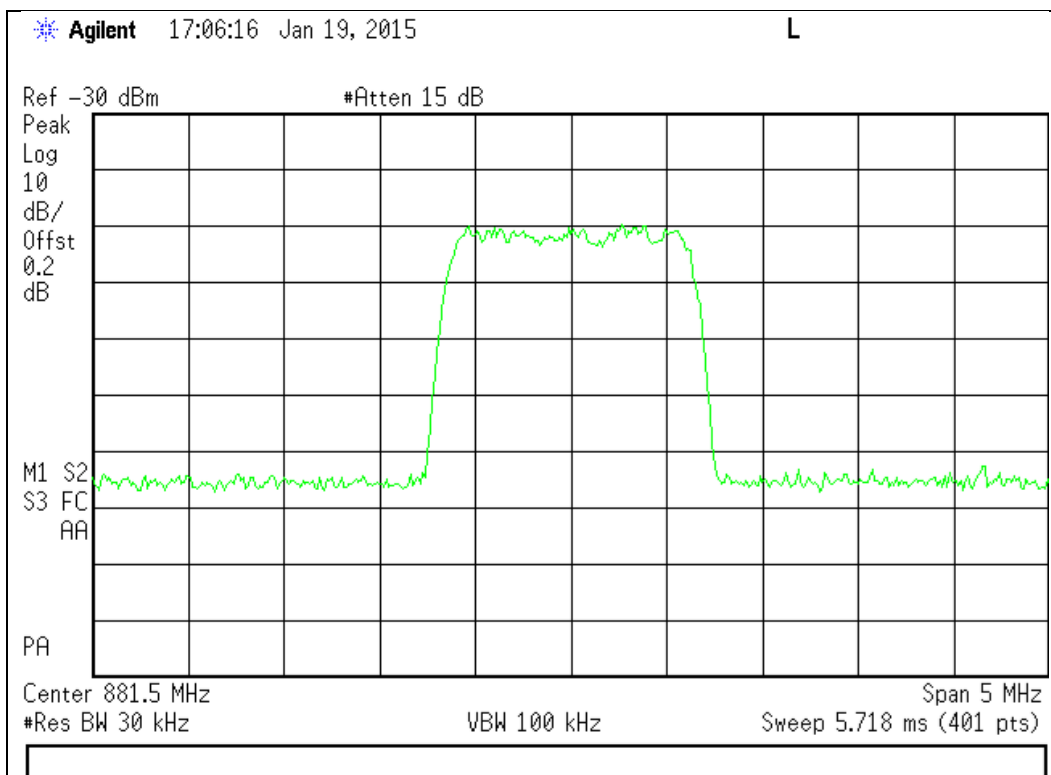

1930 - 1990 MHz Band

Input

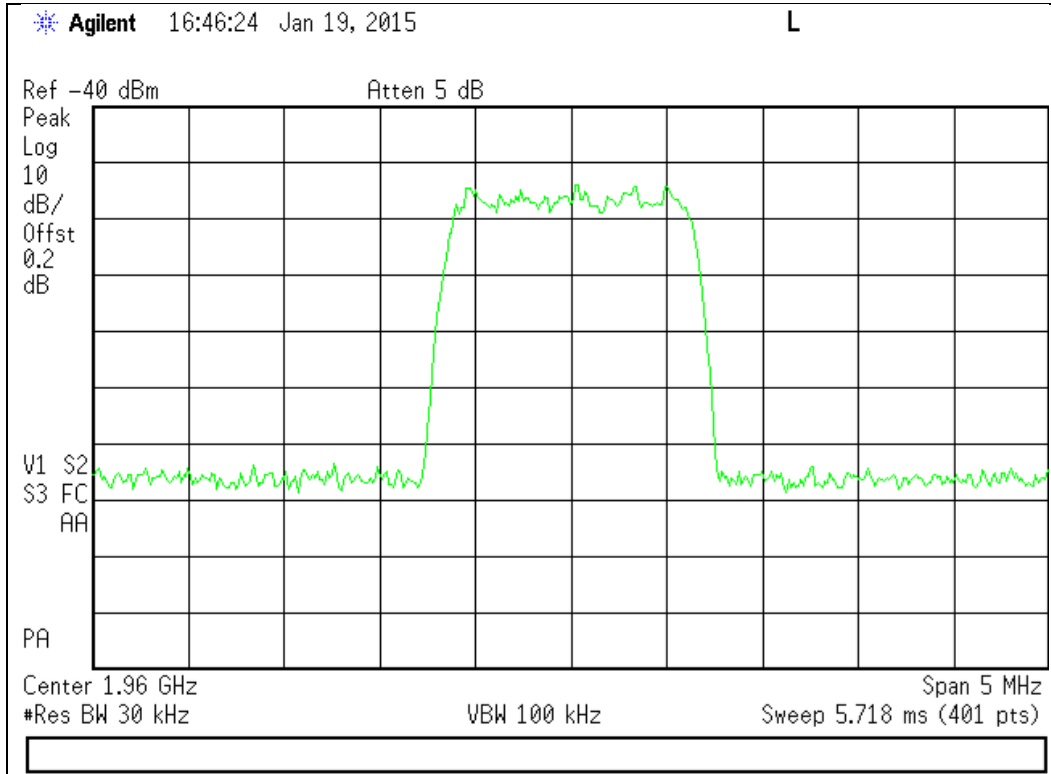

Output

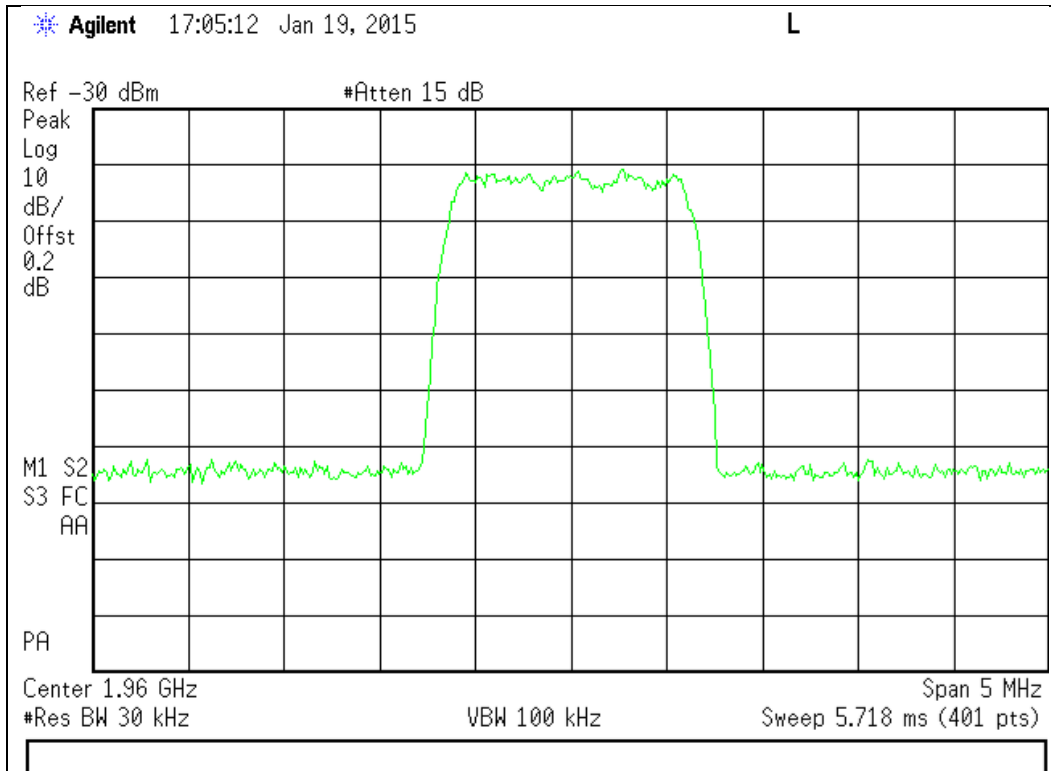

WCDMA Uplink Test Plots

824 - 849 MHz Band

Input

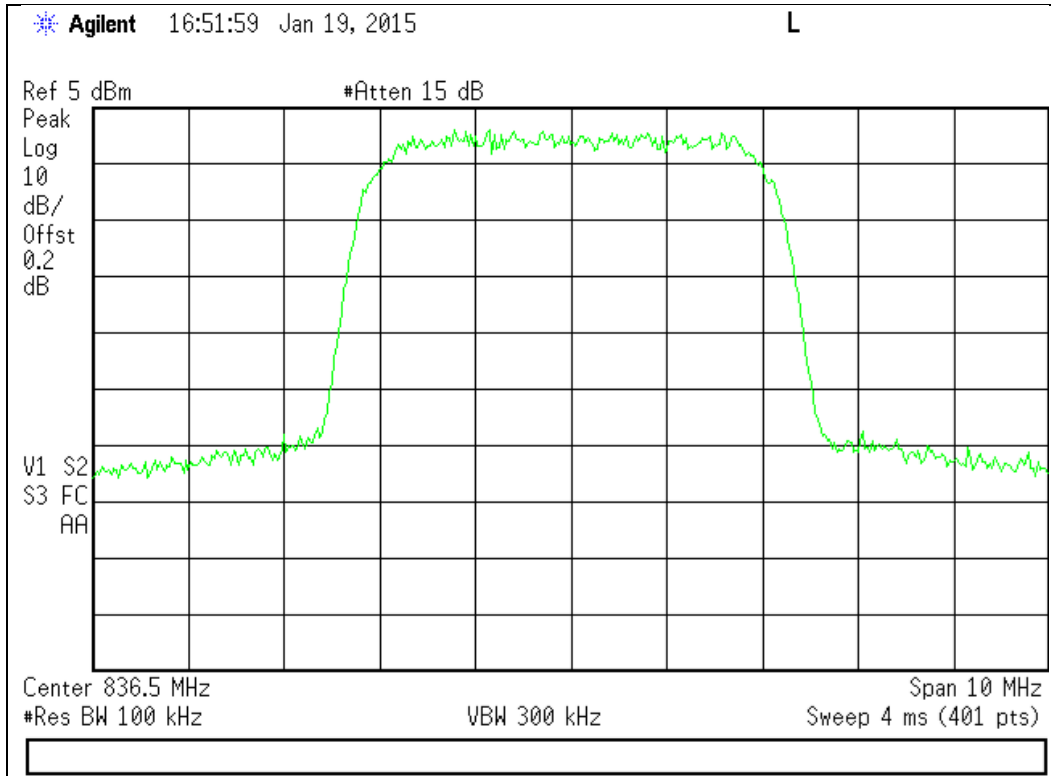

Output

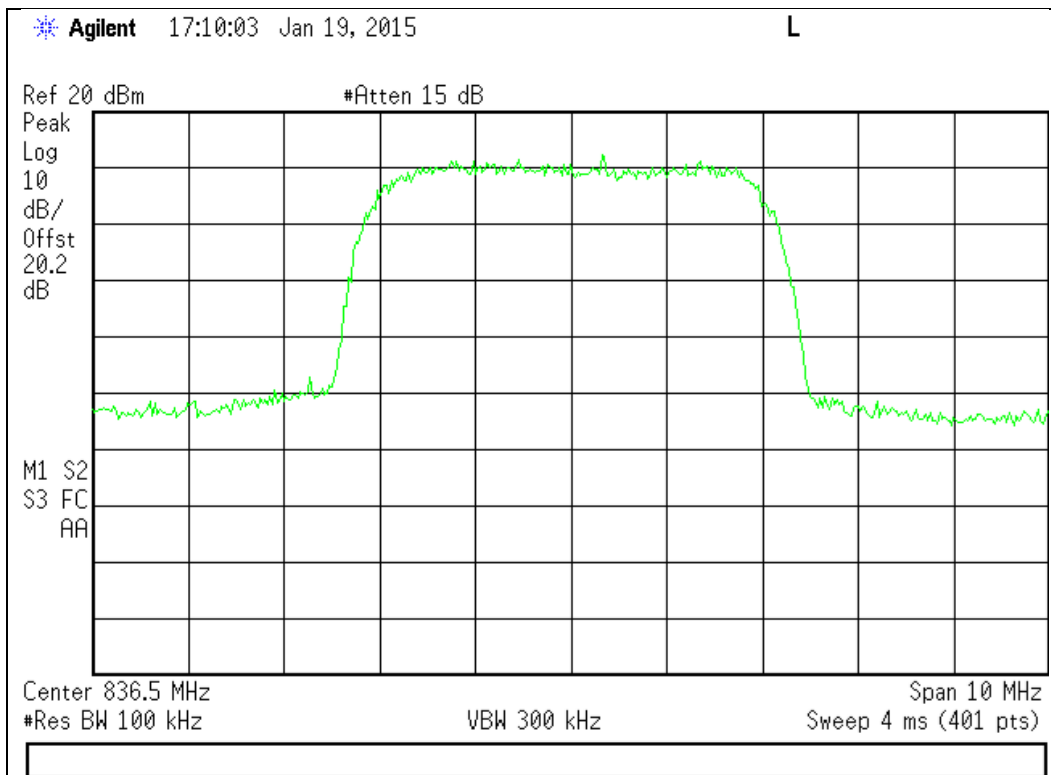

1850 - 1910 MHz Band

Input

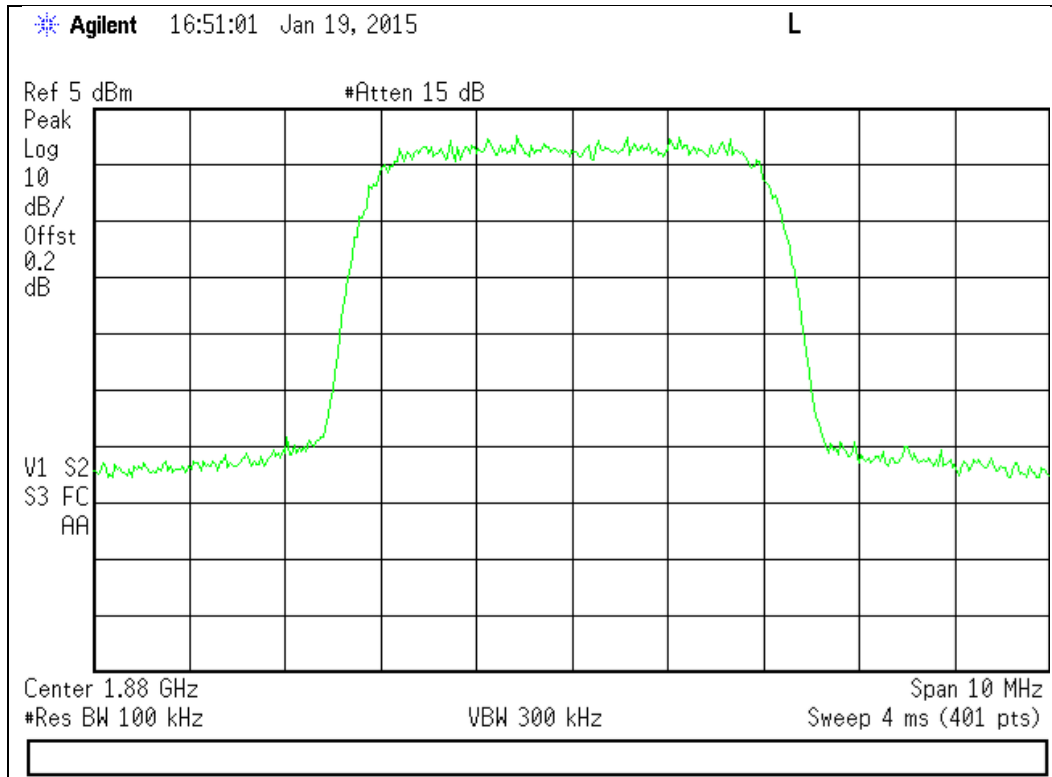

Output

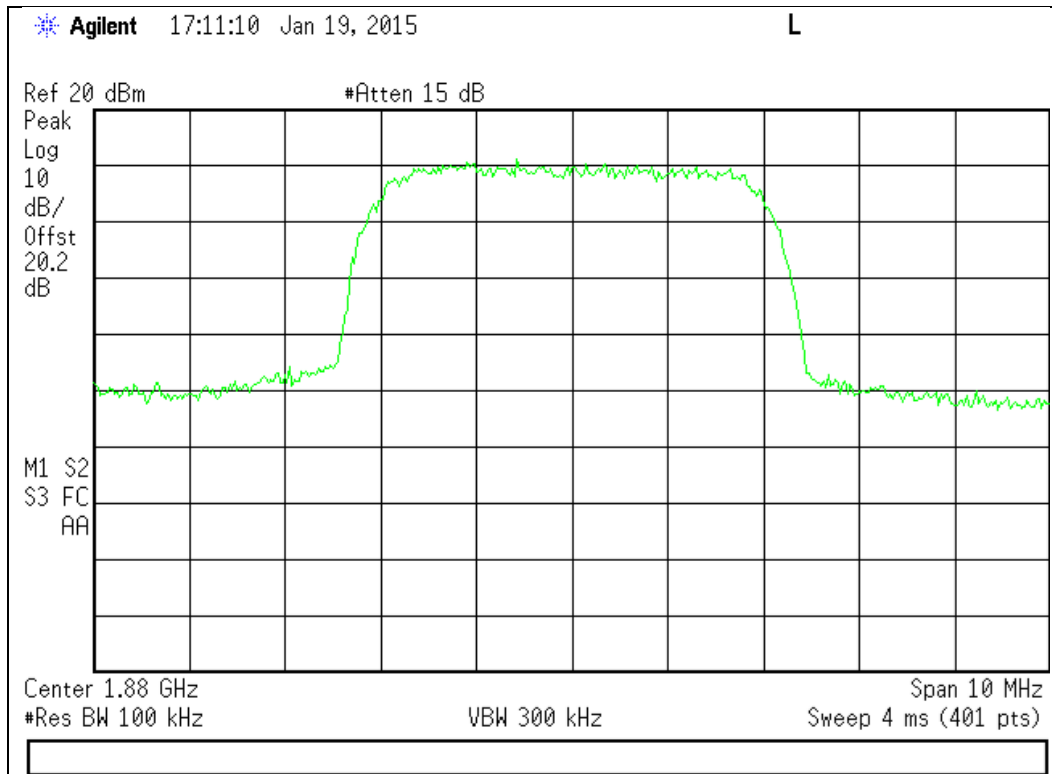

WCDMA Downlink Test Plots

869 - 894 MHz Band

Input

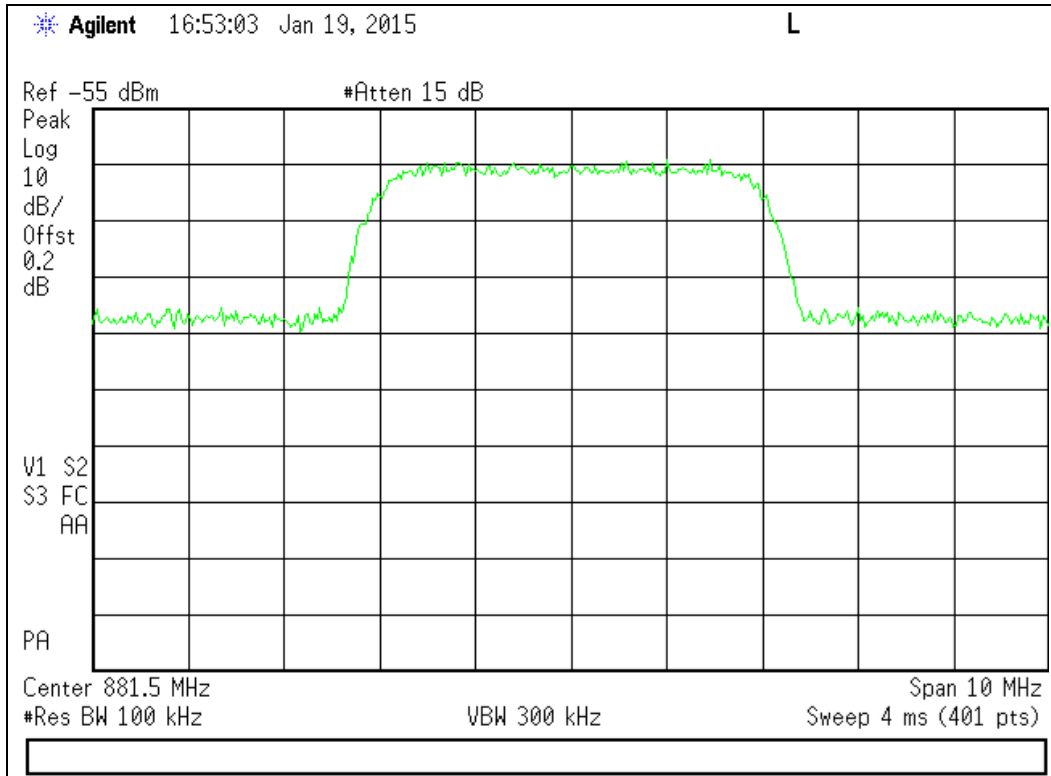

Output

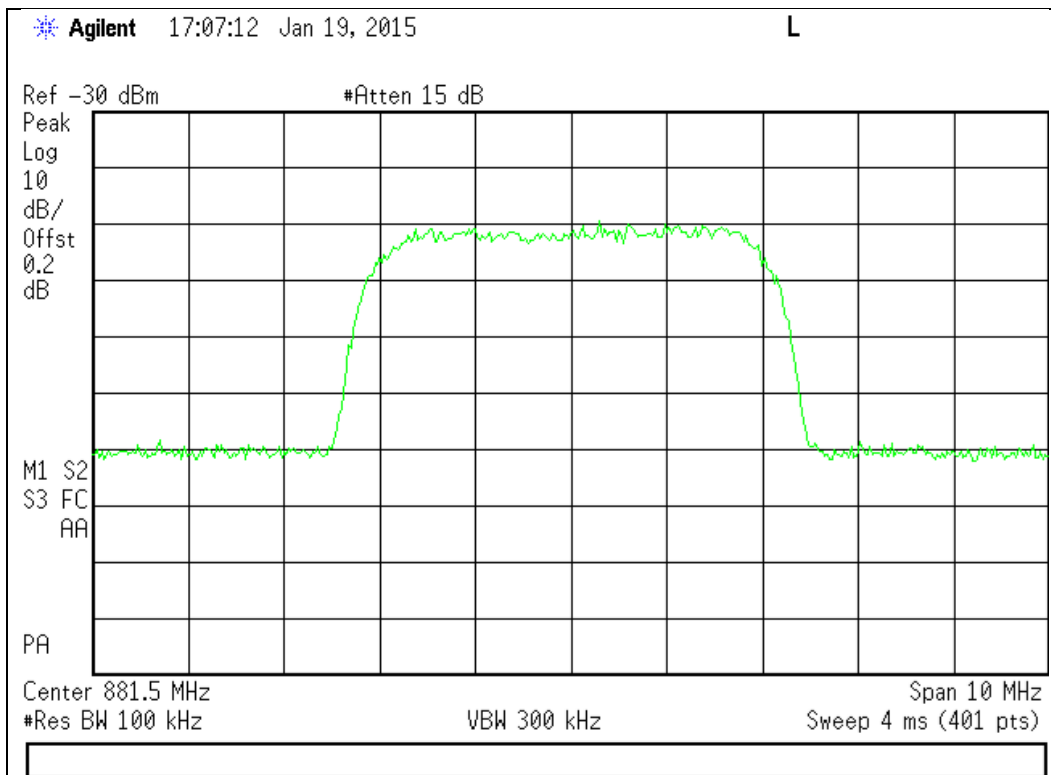

1930 - 1990 MHz Band

Input

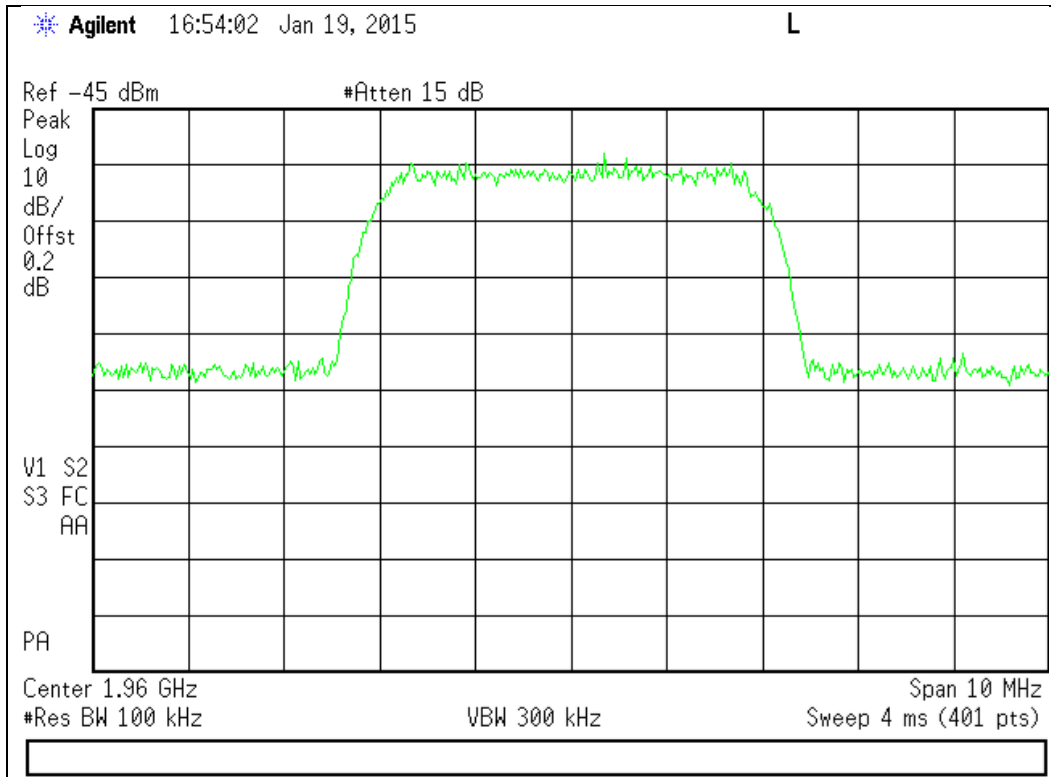

Output

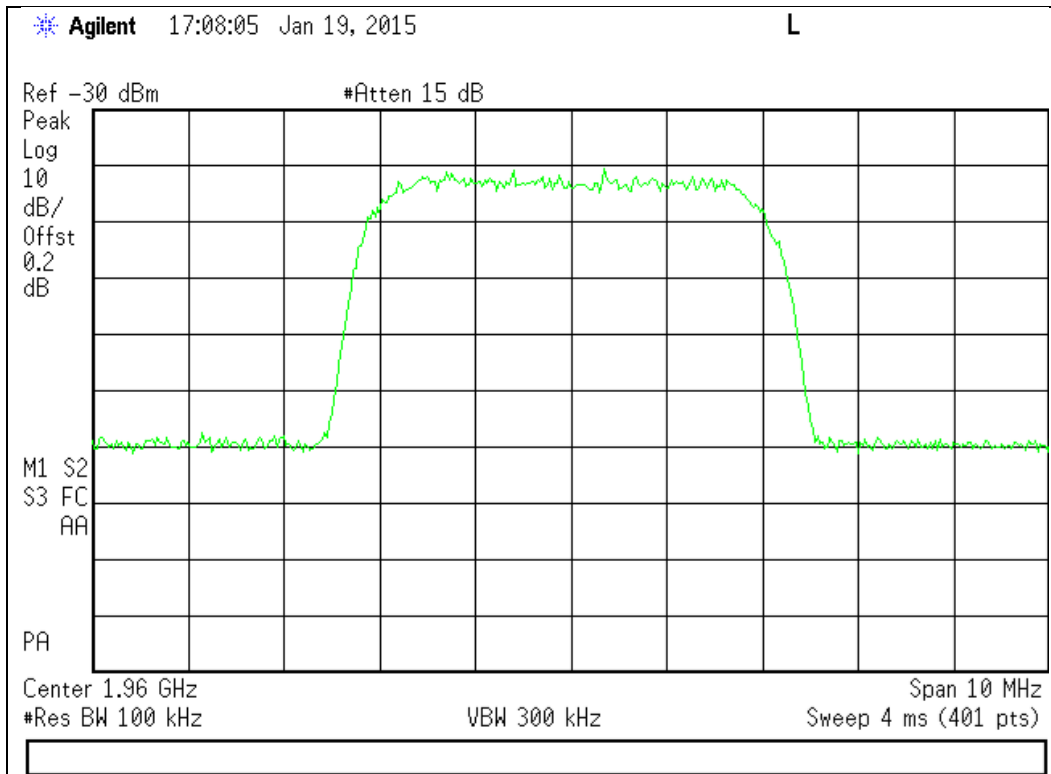

Oscillation Detection
Engineer: Mike Graffeo
Test Date: 1/19/2015

Test Procedure

The EUT was connected to a spectrum analyzer set for 0 Hz operation. The EUT uplink and downlink were fed back upon each other through a selectable band pass filter and variable attenuator. The EUT uplink and downlink were tested to ensure that the presence of oscillation was detected and that the EUT output turned off within 300 mS for the Uplink and 1 second for the Downlink and remained off for 1 minute. A EUT with test software was utilized to ensure that the EUT only had a maximum of 5 attempts at restart from oscillation before permanently shutting off.

Test Setup

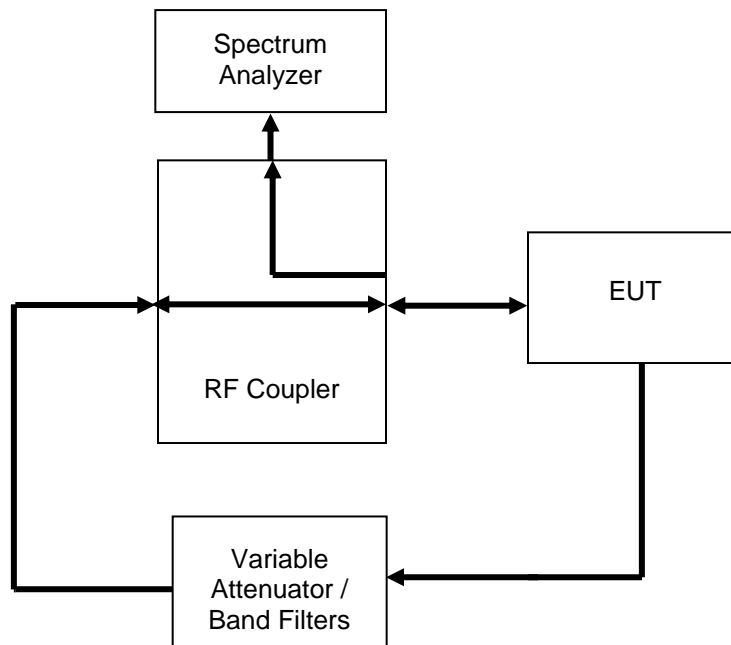

Uplink Detection Time Test Results

Frequency Band (MHz)	Measured Time (mS)	Limit (mS)	Result
824 - 849	34.2	300	Pass
1850 - 1910	14.4	300	Pass

Downlink Detection Time Test Results

Frequency Band (MHz)	Measured Time (mS)	Limit (mS)	Result
869 - 894	10.5	1000	Pass
1930 - 1990	13.5	1000	Pass

Uplink Restart Time Test Results

Frequency Band (MHz)	Measured Time (S)	Limit (S)	Result
824 - 849	65.6	≥60	Pass
1850 - 1910	65.6	≥60	Pass

Downlink Restart Time Test Results

Frequency Band (MHz)	Measured Time (S)	Limit (S)	Result
869 - 894	65.6	≥60	Pass
1930 - 1990	65.6	≥60	Pass

Uplink Restart Count Test Results

Frequency Band (MHz)	Restarts	Limit	Result
824 - 849	4	≤5	Pass
1850 - 1910	4	≤5	Pass

Downlink Restart Count Test Results

Frequency Band (MHz)	Restarts	Limit	Result
869 - 894	4	≤5	Pass
1930 - 1990	4	≤5	Pass

Uplink Detection Time Test Results

824 - 849 MHz Band

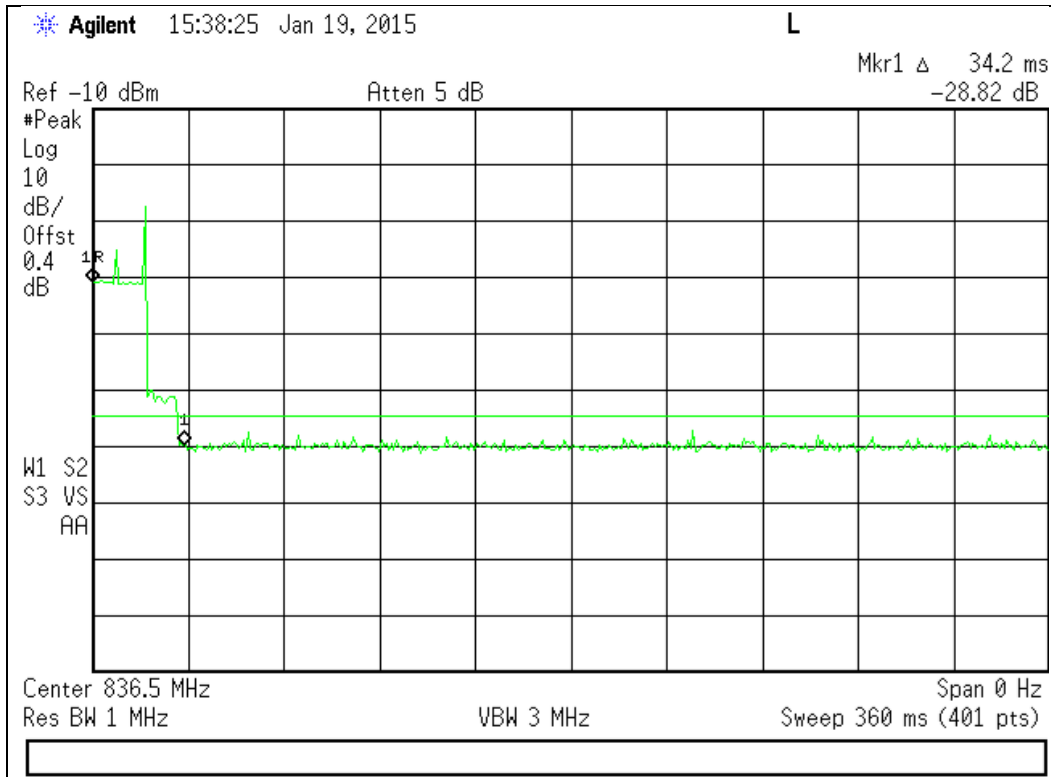

1850 - 1910 MHz Band

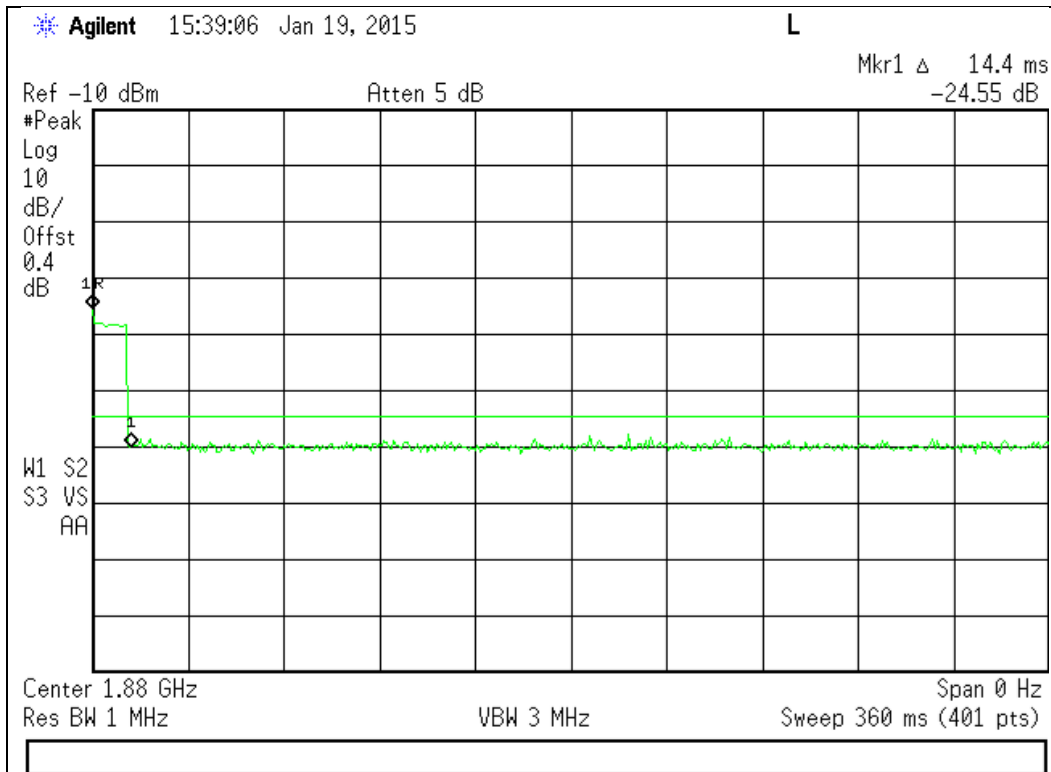

Uplink Restart Time Test Results

824 - 849 MHz Band

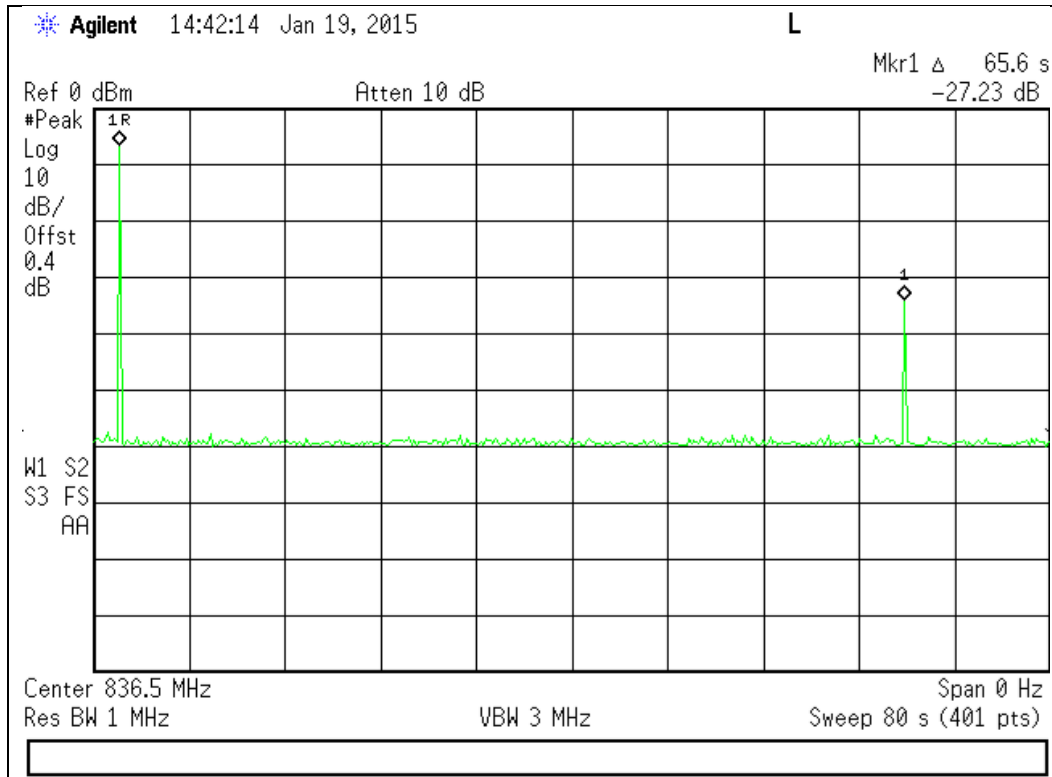

1850 - 1910 MHz Band

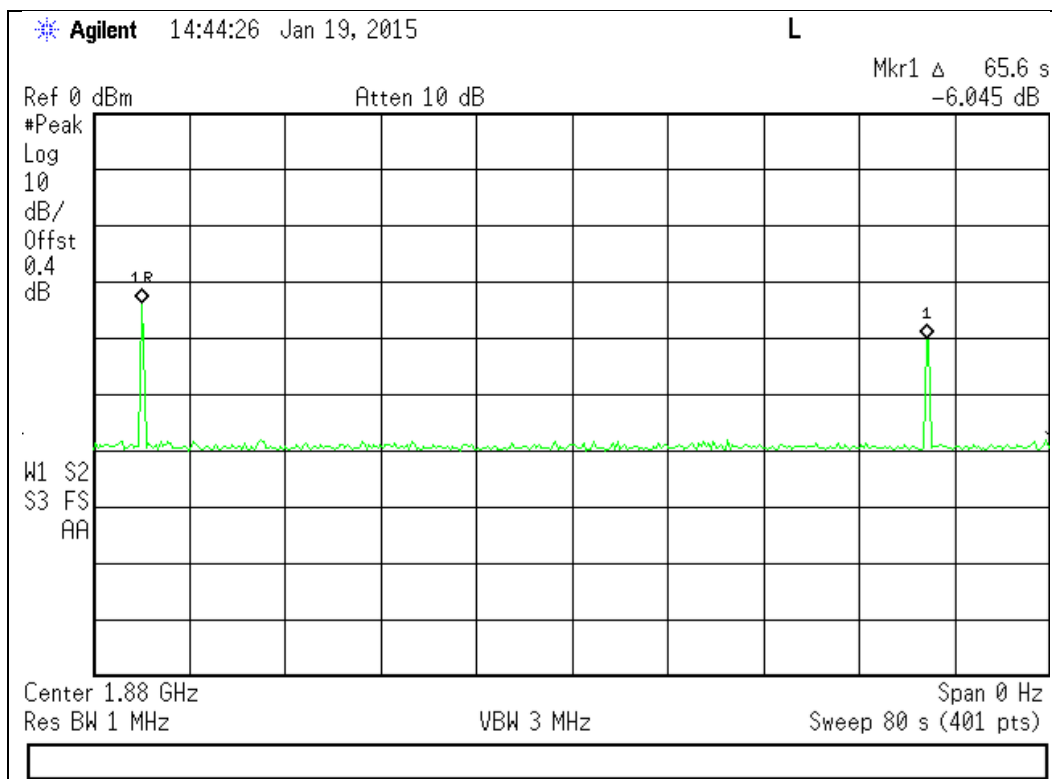

Uplink Restart Count Test Results

824 - 849 MHz Band

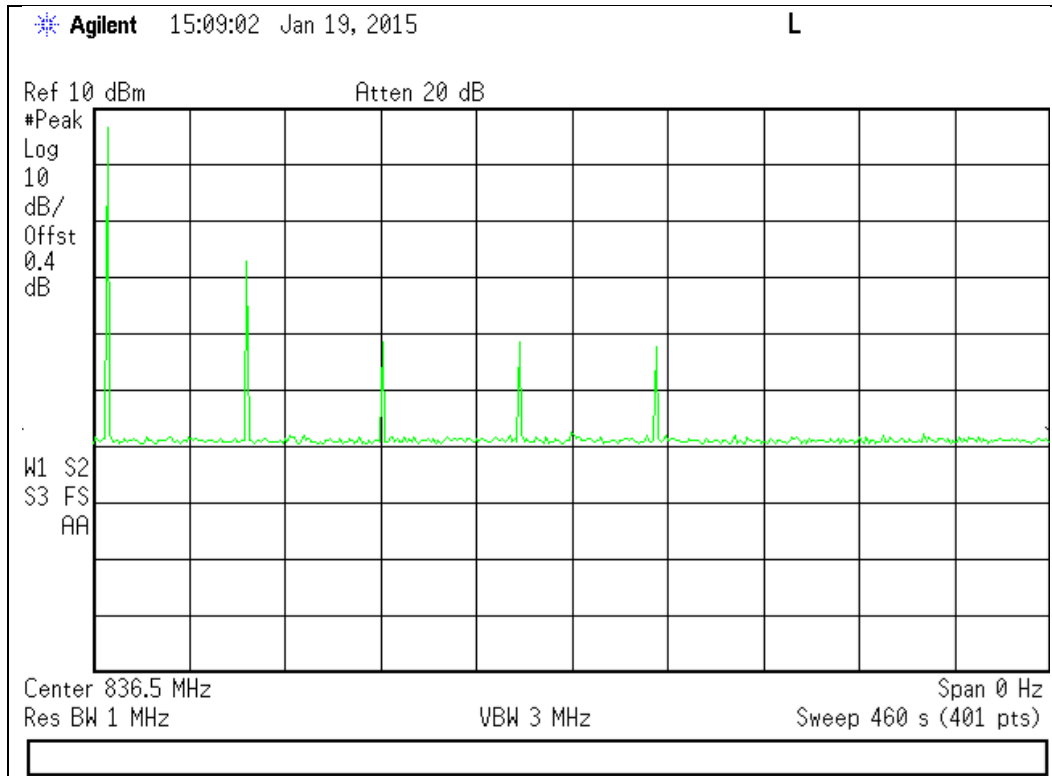

1850 - 1910 MHz Band

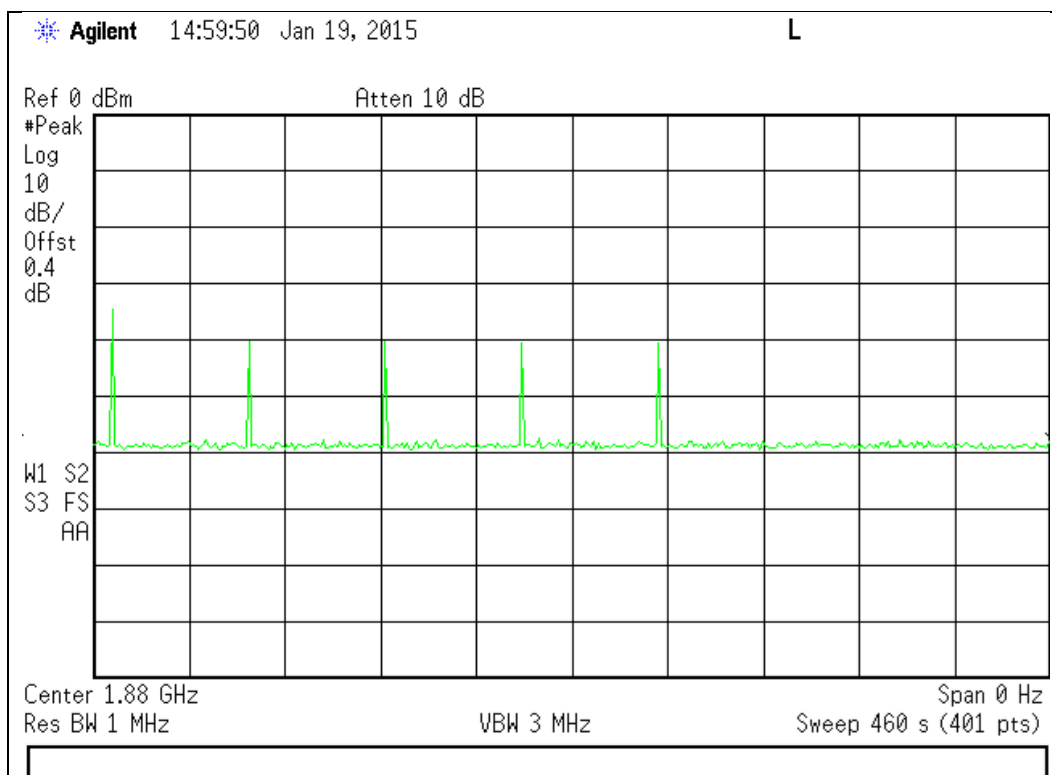

Downlink Detection Time Test Results

869 - 894 MHz Band

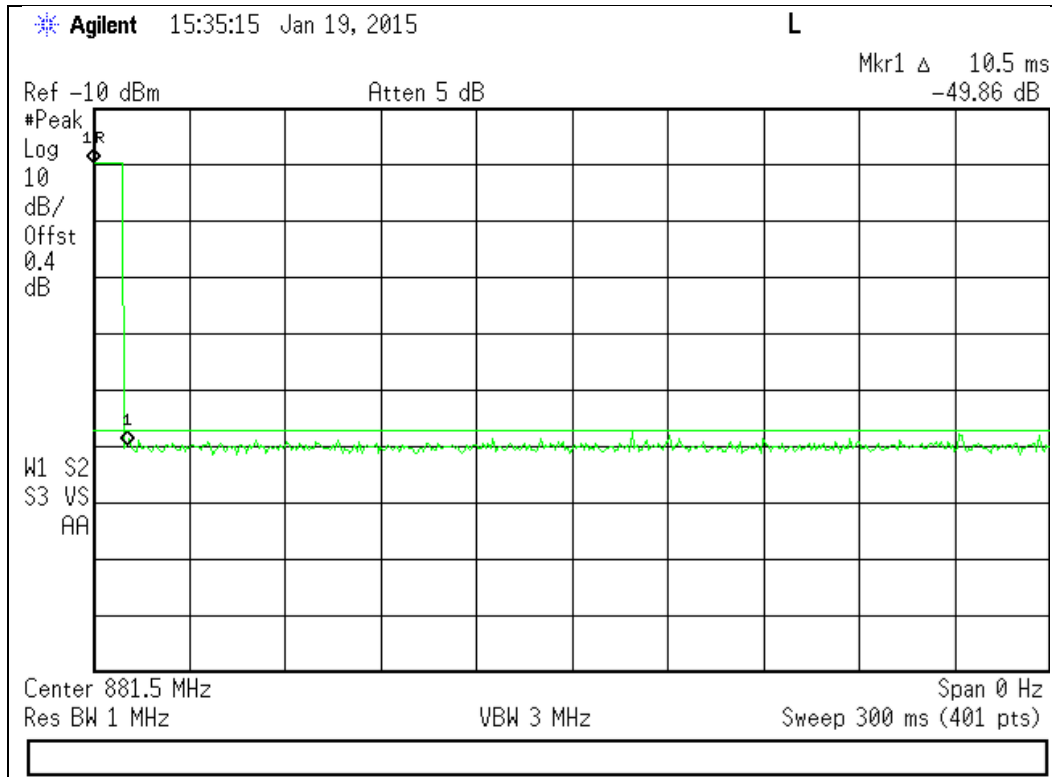

1930 - 1990 MHz Band

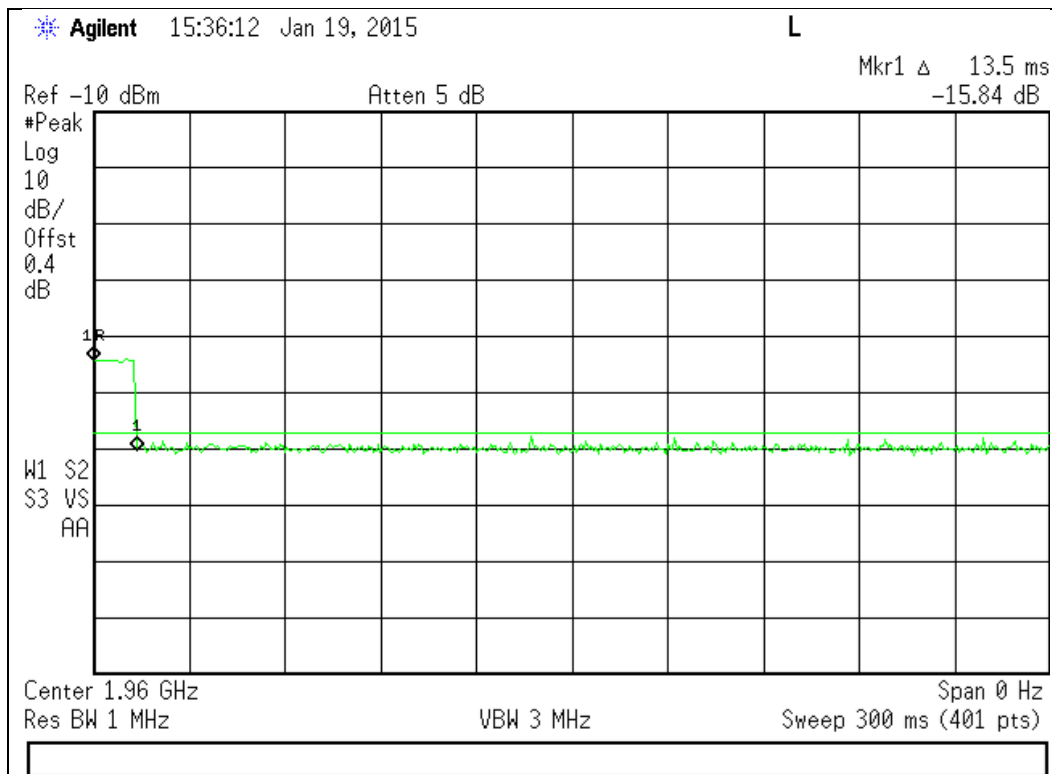

Downlink Restart Time Test Results

869 - 894 MHz Band

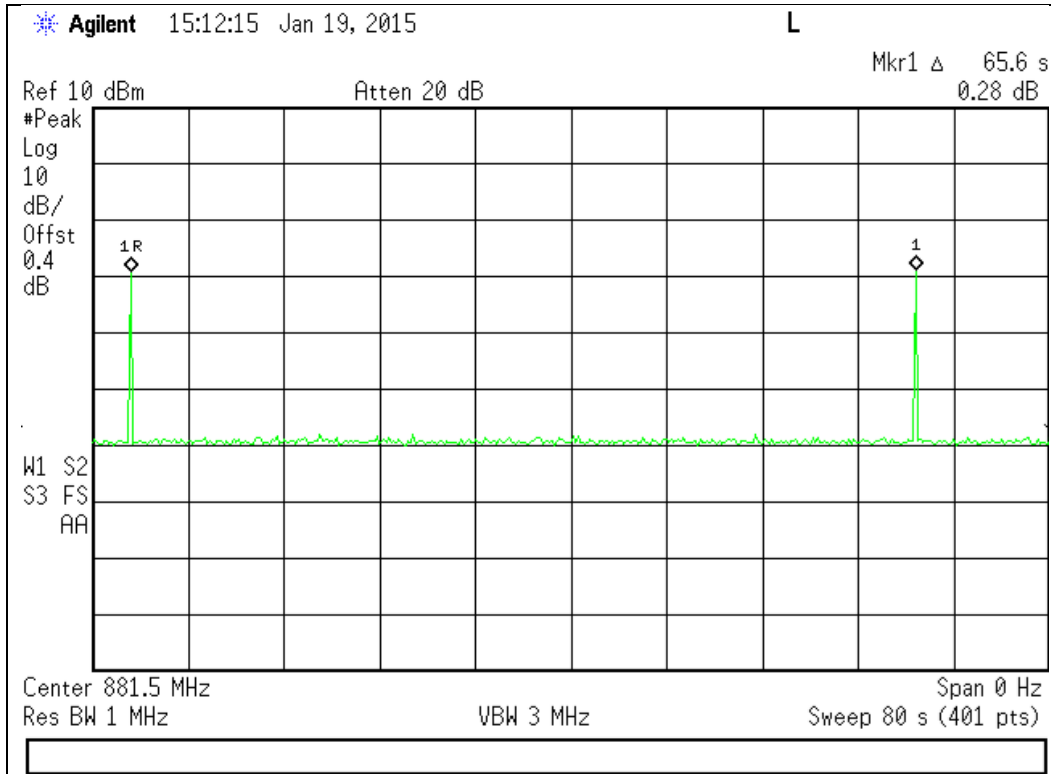

1930 - 1990 MHz Band

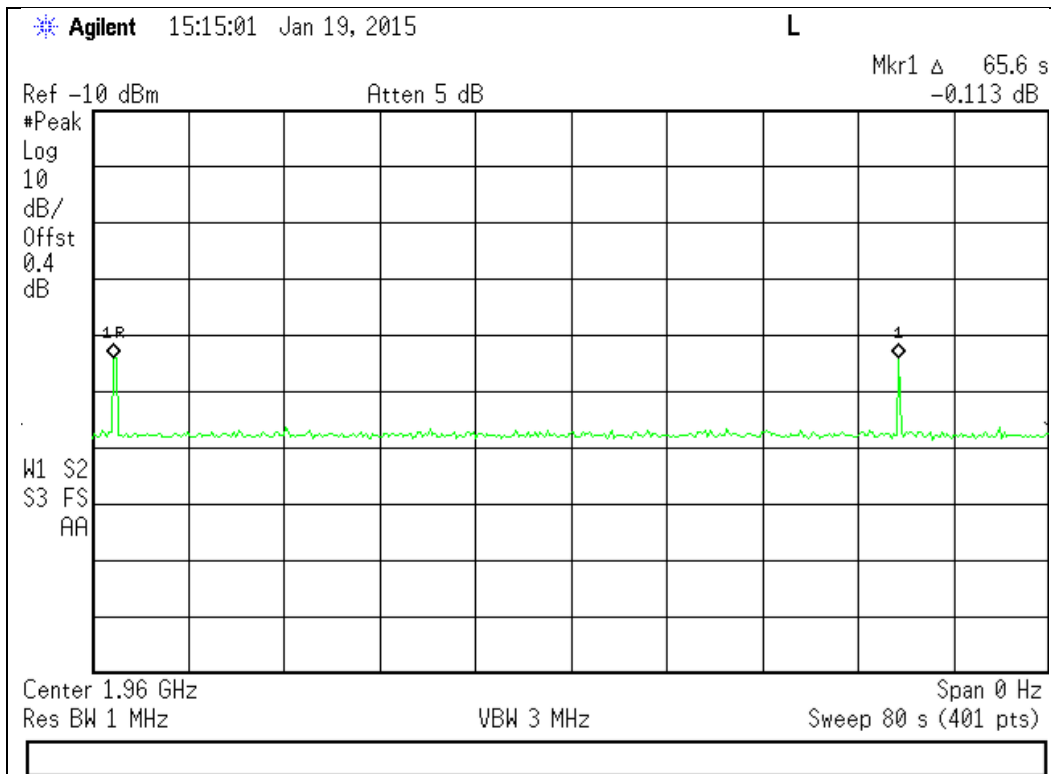

Downlink Restart Count Test Results

869 - 894 MHz Band

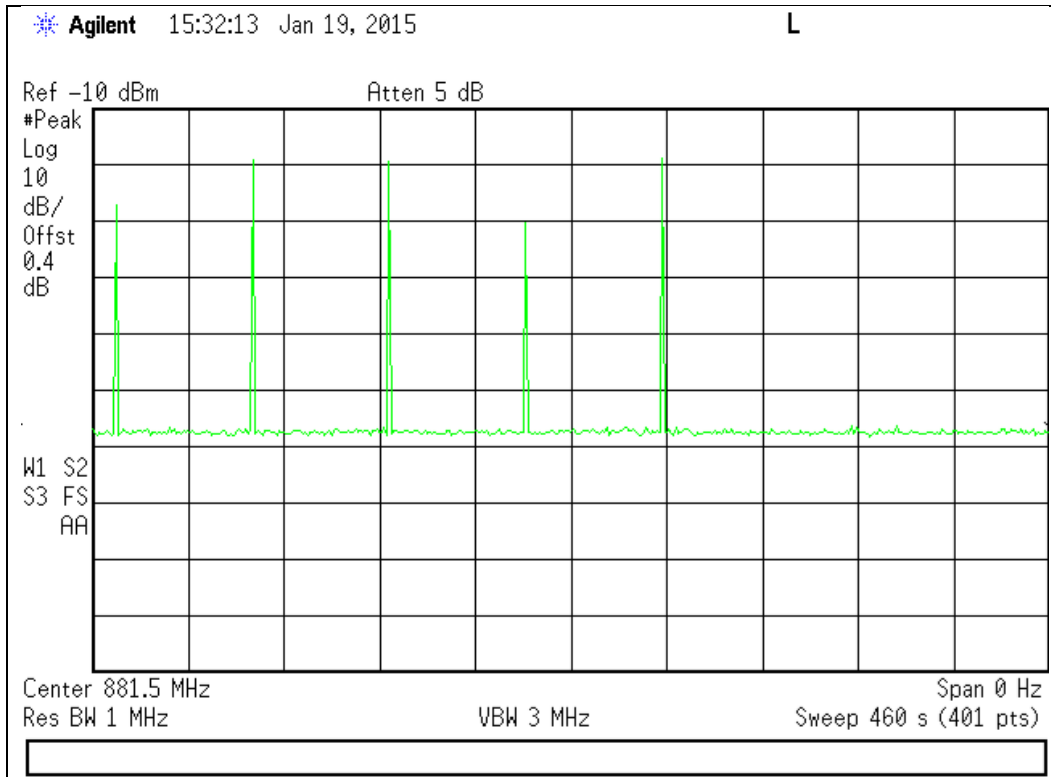

1930 - 1990 MHz Band

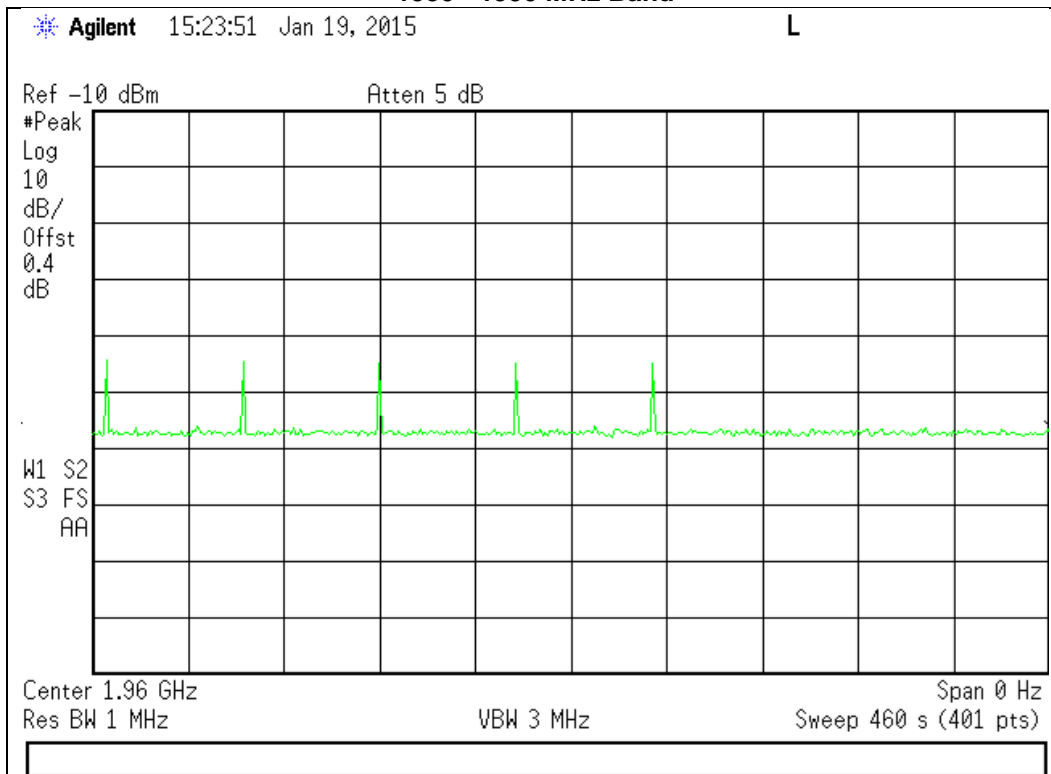

Radiated Spurious

Engineer: Mike Graffeo

Test Date: 1/29/2015

Test Procedure

The EUT was tested in a semi-anechoic chamber with the turntable set 3m from the receiving antenna. A spectrum analyzer was used to verify that the EUT met the requirements for Radiated Emissions. The EUT was tested by rotating it 360 degrees with the antenna in both the vertical and horizontal orientation while raised from 1 to 4 meters to ensure that the signal levels were maximized. All cable and antenna correction factors were input into the spectrum analyzer ensuring an accurate measurement in ERP/EIRP with the resultant power in dBm. A signal generator was used to provide a CW signal centered in each operational uplink and downlink band. The EUT output was terminated into a 50 Ohm non-radiating load.

The following formula was used for calculating the limits:

Radiated Spurious Emissions Limit = $P1 - (43 + 10\text{Log}(P2)) = -13\text{dBm}$

P1 = power in dBm

P2 = power in Watts

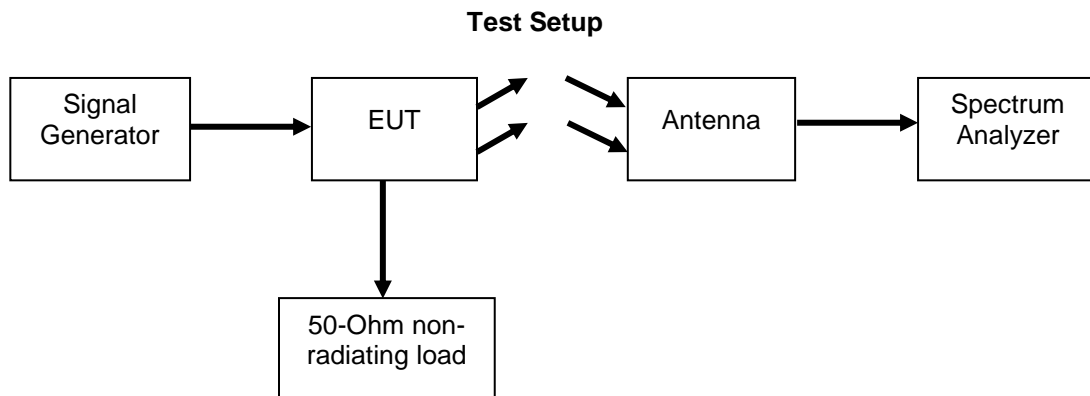

Uplink Test Results

824 - 849 MHz Band 836.5 MHz Tuned Frequency

Measured Frequency (MHz)	Measured Level (dBm)	Limit (dBm)	Result
1673	-52.95	-13	Pass
2509.5	-48.81	-13	Pass
3346	-46.12	-13	Pass

1850 - 1910 MHz Band 1880 MHz Tuned Frequency

Measured Frequency (MHz)	Measured Level (dBm)	Limit (dBm)	Result
3760	-45.38	-13	Pass
5640	-41.29	-13	Pass
7520	-32.92	-13	Pass

Downlink Test Results

869 - 894 MHz Band 881.5 MHz Tuned Frequency

Measured Frequency (MHz)	Measured Level (dBm)	Limit (dBm)	Result
1763	-52.03	-13	Pass
2644.5	-46.70	-13	Pass
3526	-44.57	-13	Pass

1930 - 1990 MHz Band 1960 MHz Tuned Frequency

Measured Frequency (MHz)	Measured Level (dBm)	Limit (dBm)	Result
3920	-45.22	-13	Pass
5880	-38.51	-13	Pass
7840	-31.91	-13	Pass

No other emissions were detected. All emissions were lower than -13 dBm.
 All emissions were system noise floor.

Test Equipment Utilized

Description	Manufacturer	Model #	CT Asset #	Last Cal Date	Cal Due Date
Horn Antenna, Amplified	ARA	DRG-118/A	i00271	5/8/14	5/8/16
Bi-Log Antenna	Schaffner	CBL 6111D	i00349	10/8/13	10/8/15
Humidity / Temp Meter	Newport	IBTHX-W-5	i00282	3/24/14	3/24/15
Voltmeter	Fluke	75III	i00320	3/24/14	3/24/15
EMI Analyzer *	Agilent	E7405A	i00379	1/14/14	1/14/15
Non-radiating load	Termaline	8201	i00334	Verified on: 1/11/15	
Signal Generator	Rohde & Schwarz	SMU200A	i00405	12/11/14	12/11/15
Signal Generator	Keysight (Agilent)	E4438C	I00457	9/26/2014	9/26/2016
RF Directional Coupler	Meca	CS06-1.500V	i00412	Verified on: 1/11/15	

In addition to the above listed equipment standard RF connectors and cables were utilized in the testing of the described equipment. Prior to testing these components were tested to verify proper operation.

* Lab Manager has approved a 30 day extension on this piece of equipment

END OF TEST REPORT