



SR14652002A
Cell Phone Signal Booster
Manual



Manufactured and Warranted by
SolidRF Inc.
www.solidRFinc.com

customer service number:

Office (435) 319-6858

Toll Free (877) 579-7878

US: Support@SolidRFINC.com

Canada: Support@SolidRF.ca

Operational Diagram
(How It Works)
Package Contents
Page 2

Basic Signal Level Knowledge
Page 3

Preparation
Page 4 - 7

Installation Step By Step
Page 8 - 16

Trouble Shooting
Page 17 - 26

Technical Specification
Warranty Information
Page 27

Safety Guidelines
Page 28

Working Diagram (How It Works)

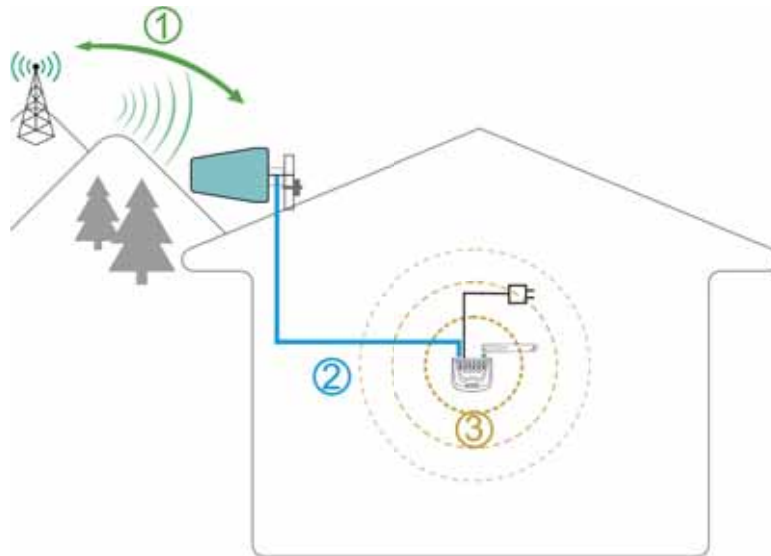

1. The outdoor antenna catches the signal from the tower.
2. Sends outside signal to the booster through a coax cable.
3. The booster amplifies the signal then rebroadcasts the signal indoors to all mobile devices within range.
4. The system also works in reverse; amplifying outgoing signal back to the tower.

 The coverage area and the **strength** of the boosted signal are directly related to two key factors:

1. Signal strength received by the outdoor unit. So, setting up the outside unit where the signal is the strongest will provide the best results.
2. Distance of **separation** between the outdoor unit and the indoor unit.

Package Contents

The kit includes the following items:

1. Outdoor Antenna (with mounting kits);
2. Booster (with indoor antenna);
3. Power supply;
4. 60 ft of RG6 cable, for connecting the outdoor unit and indoor unit;



Outdoor Antenna



Booster & Indoor Antenna



Power supply



RG6 cable

Signal transmission loss and power level

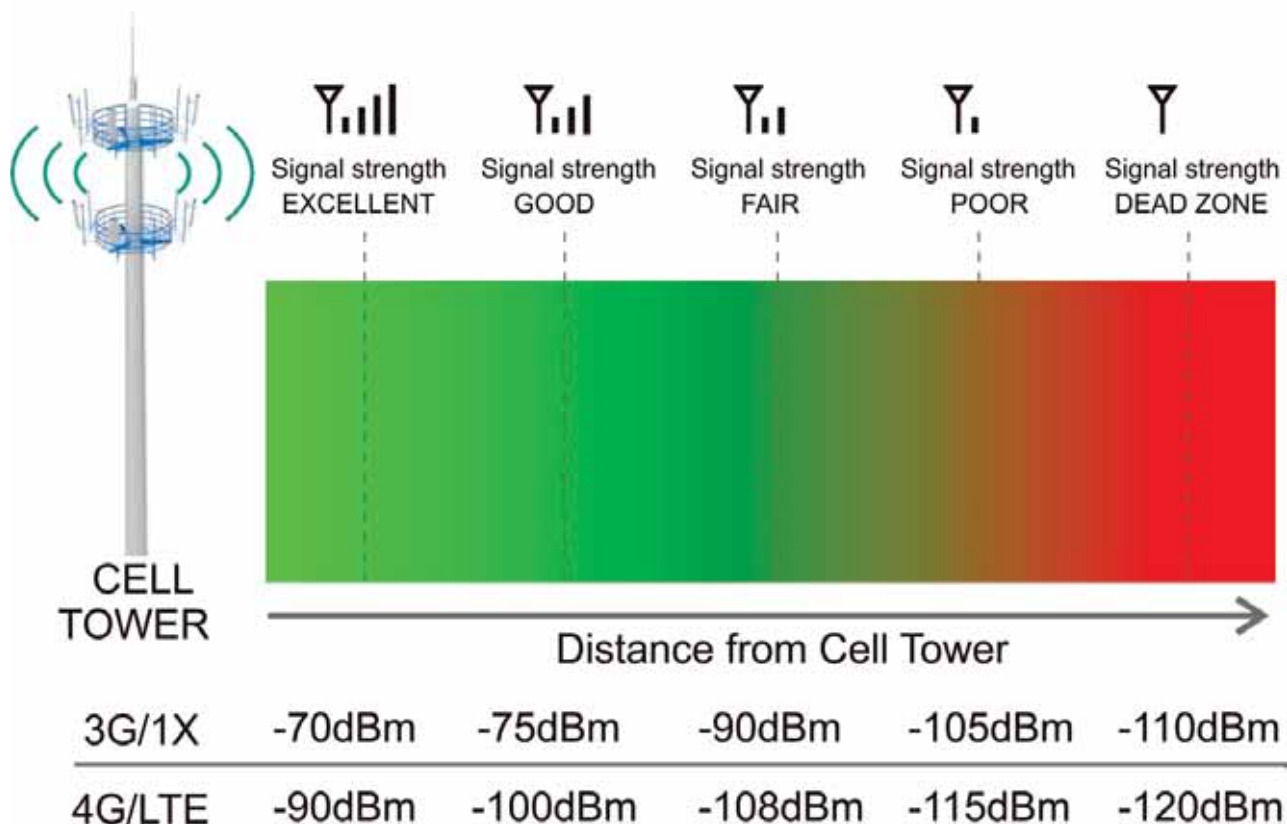

Coverage area ability

Note: FCC regulations limit the amplification of all cell phone boosters in order to prevent damage to the telecommunications infrastructure. Therefore, the maximum coverage area of a booster depends on the original power level of the signal captured by the outdoor unit.

⚠️ Notice: Not recommended when outdoor signal strength is less than -110dbm(3G/1x) or -120dBm(4G/LTE). The resulting coverage area of the boosted signal will be prohibitively small.

Power level at the outdoor antenna location	Coverage Area (sq. ft.)
Strong (5 bars on the cellphone)	2,000
Medium (3~4 bars on the cellphone)	1,000
Weak (1~2 bars on the cellphone)	300

Preparation

Find your cell tower nearby!

There are a variety of resources available online, here is a third party website recommended. Use it to locate your nearest cell tower: www.cellmapper.net

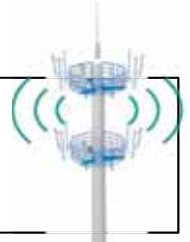

Note: This is very important step. If we use the wrong direction, we won't have good result.

Step 1: Visit website www.cellmapper.net

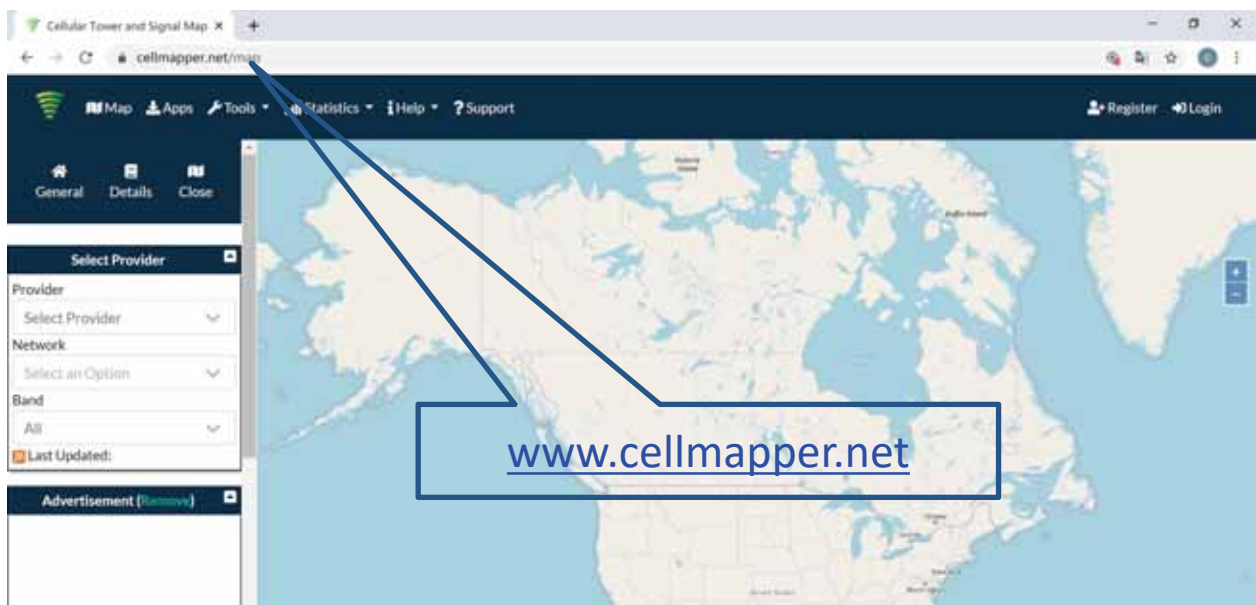

Step 2: Find your location on the map and zoom in on your area

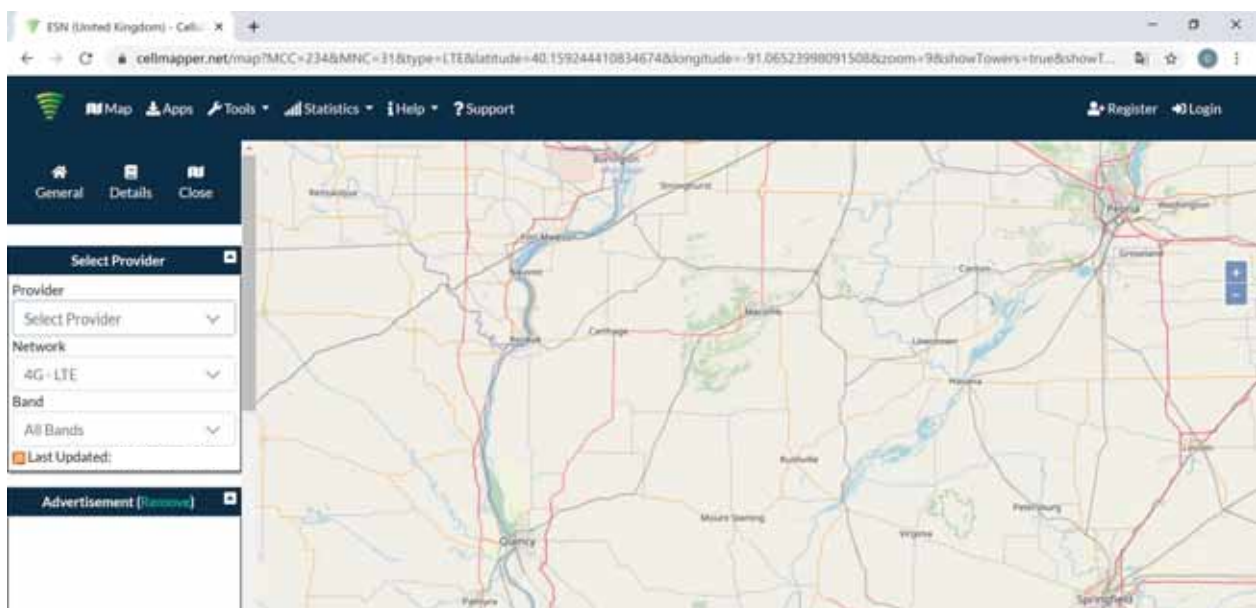

Step 3:. Select Provider. You will find the cell tower around your house.

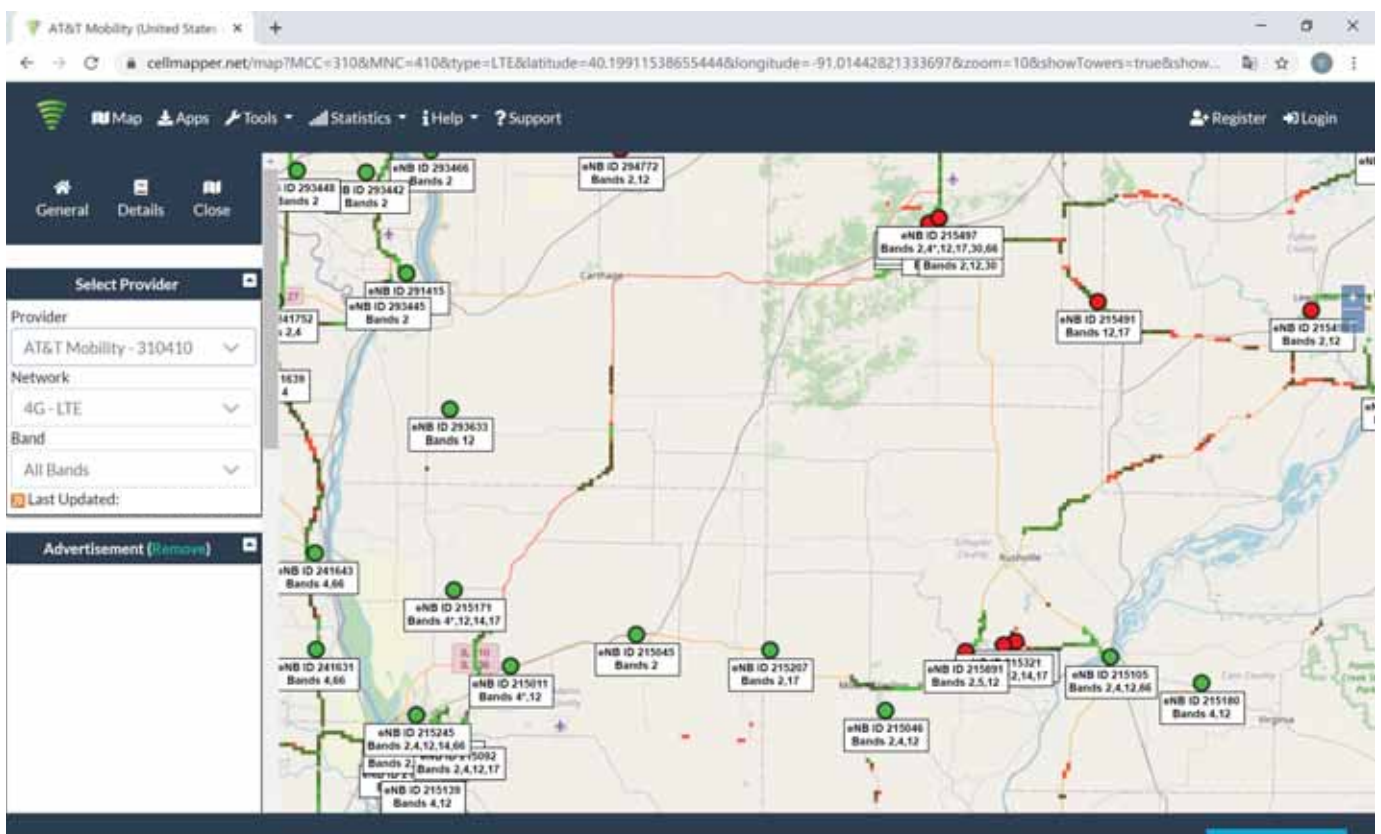
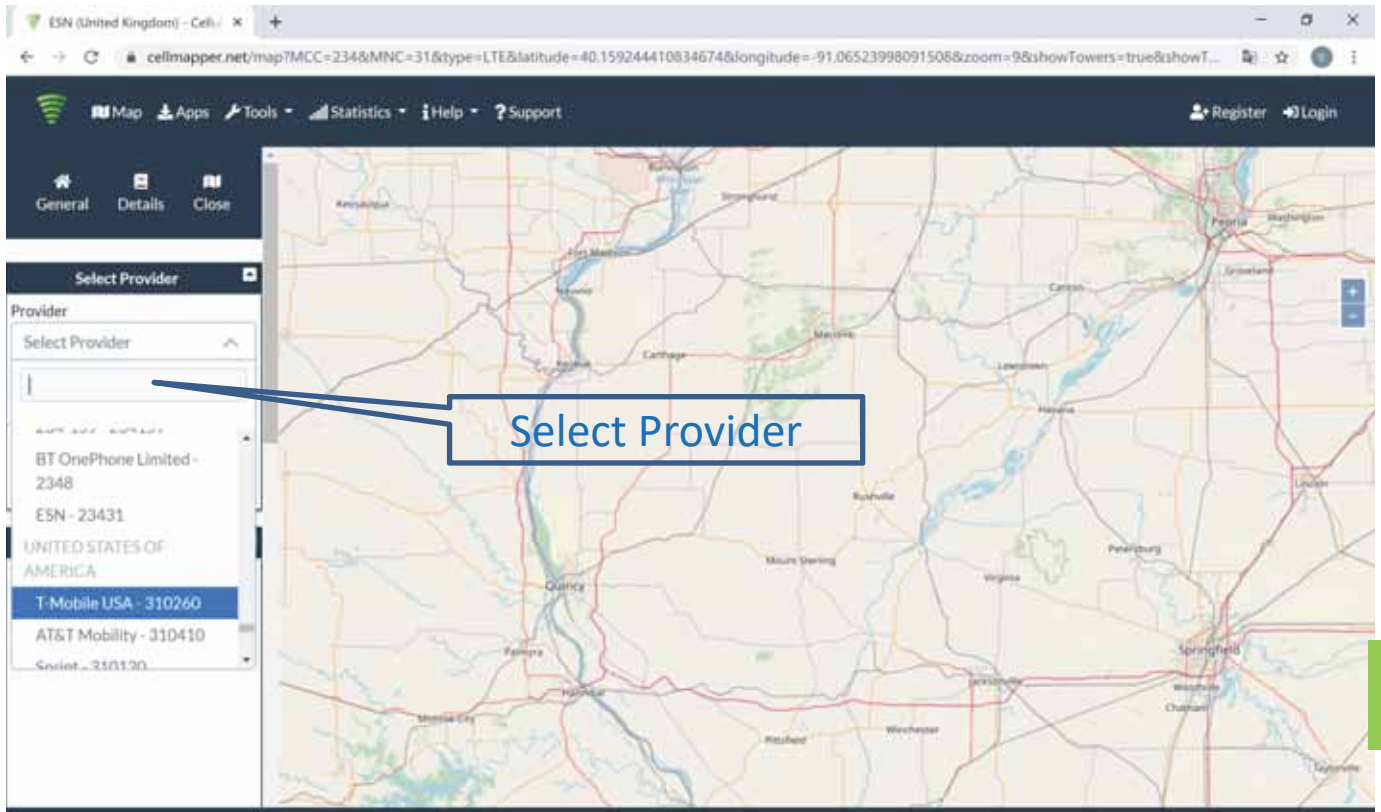

Step 4: Find your cell tower

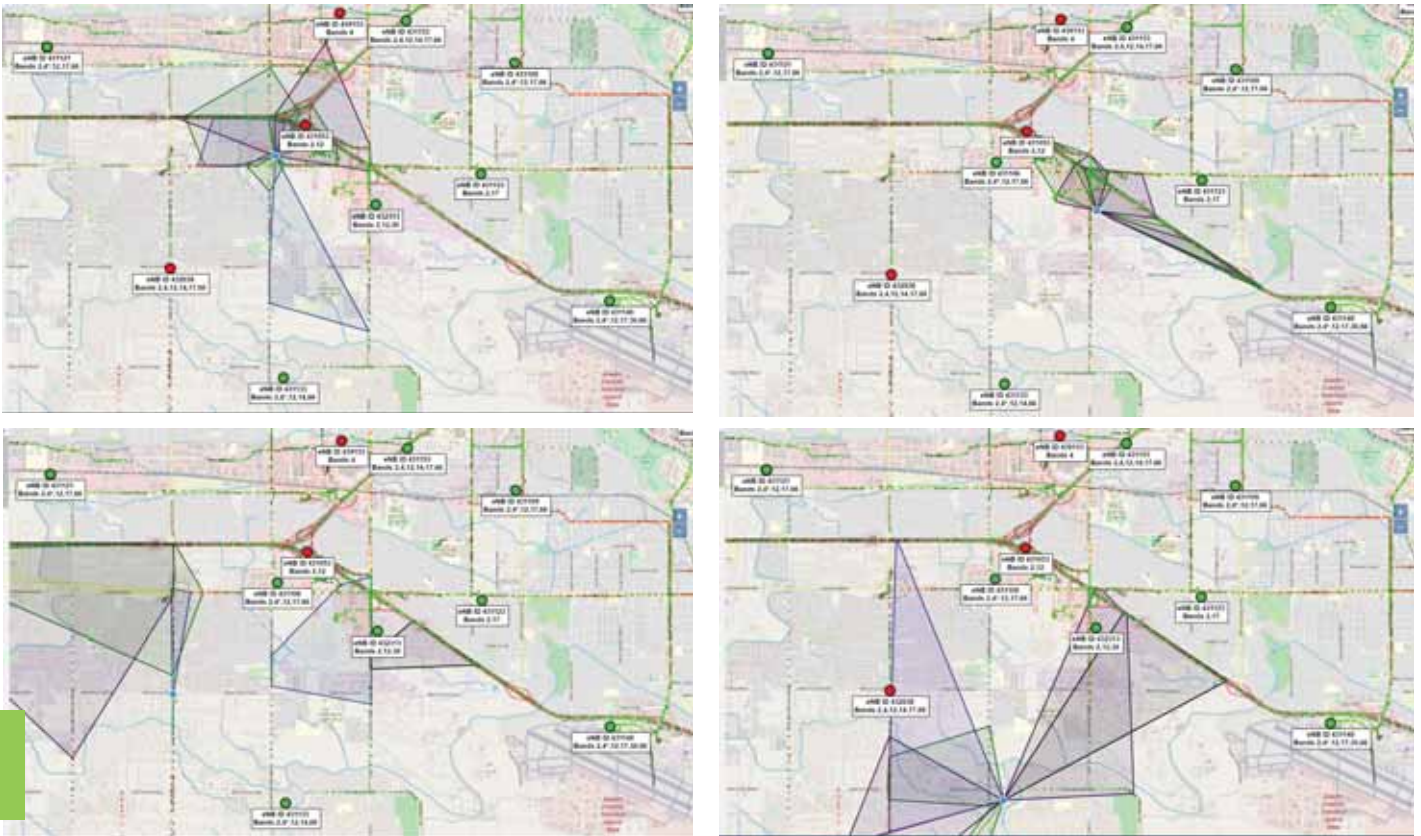

Click the red or green dot on the map that represents the base station, and the detailed information of the base station will be displayed.

- The first important information, you can see from the above four pictures, the coverage area (shaded part) of each base station is different. You have to find a base station with signal coverage to your house, or the coverage direction is facing you, and the coverage area is closest to you.

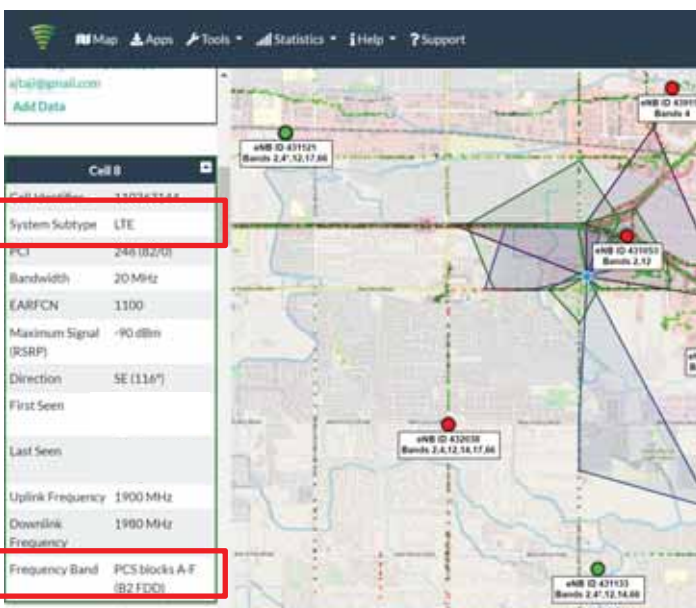

- The second important information, you can scroll the information content on the left to find the specific carrier information of this base station, including the communication standard and frequency band. Please reference the left picture, "LTE" and "B2 FDD" (Band 2, FDD).

Find The dBm Reading and Band Number On Your Phone

Having an accurate measurement of signal strength in decibels (dBm) is crucial when installing your system. Decibels accurately measure the signal strength you are receiving.

Note: Turn off your cell phone's WiFi to ensure you are checking the cellular connection. The dBm reading will be refreshed every 30-60 seconds. Want faster results? Once you have a reading, turn on airplane mode. Wait 15 seconds. Turn off airplane mode. The signal strength reading is refreshed.

iPhone: dial *3001#12345#* then press call

sel_plmn_mcc	312
ul_bw	100
sel_plmn_mnc	220
timestamp	2020-07-27 14:23:57 MDT
phy_cell_id	6
freq_band_ind	2
dl_bw	100
ul_freq	18000
num_mnc_digits	
dl_freq	

rsrp0	-107
rsrq0	-26
sinn0	10.0
rsrp1	-107
rsrq1	-27

Android: download third part APP-LTE Discovery

Band number

Receive level dBm

Band: 12
GCI: 00B6EE04
RSRQ: -9.8 dB
SNR: 11.2 dB

LTE: -98.0 dBm
GSM: -113.0 dBm

LAC: 20225
CID: 60932
RNC: 182
BER: N/A

Test Installation

We **STRONGLY** recommend doing a test installation before finalizing the installation. Doing a test installation of your cell phone booster ensures that you will get the optimal performance from your system.

Step1: Select the Location for the Outside Unit

! **Note:** This is the most critical step and will determine the overall performance of the booster system.

1. Generally, the strongest signal will be located on the side of your home facing the nearest cell tower. Keep in mind, the signal strength at ground level may be different from the signal strength at or above the roofline due to obstructions (trees, other buildings, etc.) that block the incoming signal. In most situations, the strongest signal is found about 25 feet above the ground on the side of your home facing the nearest cell tower.
2. The most ideal installation position is the corner of the building, choose the one facing your cell tower.

Four corner of the building are the most ideal position



Choose the one facing your cell tower

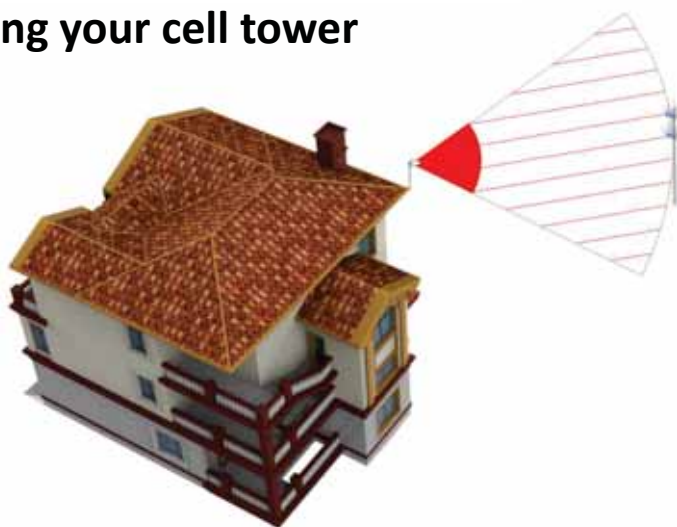

Step 2: Temporarily Mount the Outside Antenna

In addition to the four corners of the building, the chimney and the pole above the roof can also be selected. As long as the installation distance between indoor and outdoor antennas is maintained enough, satisfactory results can also be achieved.

Use one of the three options to mount the outside antenna on your roof on the side of the house with the strongest signal.

The height of the outside antenna should never exceed the highest point of your house. This is a precaution against damage and safety concerns caused by lightning strikes to the outside unit.

 **Outdoor antenna must be installed over the roof line.**



Caution

Trees will greatly attenuate wireless signals. If there are tall trees within 100 feet of the house. At the same time you can't find a stable signal above 3 bars, the outdoor antenna needs to be erected 60%(at least) to 80%(best) of the tree height. **Never exceed the trees!**

But according to FCC regulations, outdoor antenna height cannot exceed 30 feet.

At the same time, if the antenna exceeds the roof, please pay attention to lightning protection measures.

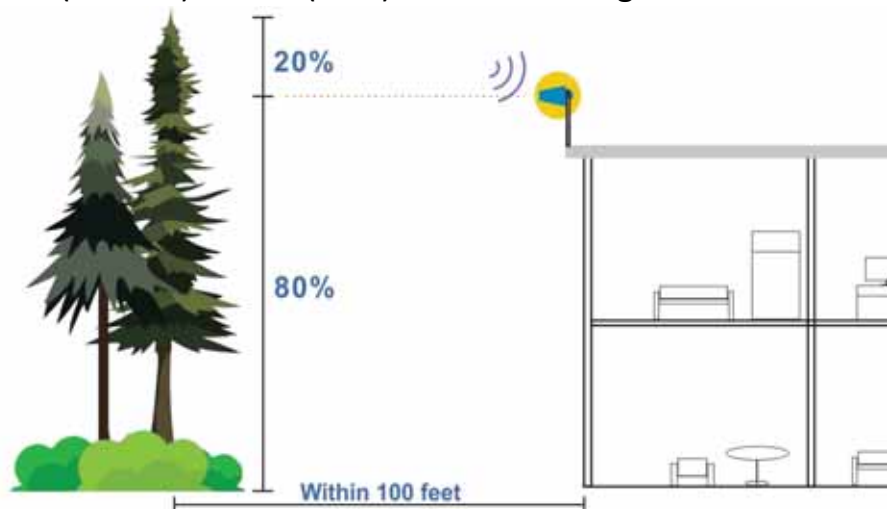

Step3: Select the Location for the Inside Antenna

In order to achieve the best signal coverage effect, there is a certain distance requirement between the indoor and outdoor units. Make sure the inside and outside units are facing away from each other.

Minimum Required Separation Distance Between Indoor and Outdoor Antenna :
Straight line distance over 30 feet(10 meters)
 or
20 ft (6 meters) horizontal distance
13 ft (4 meters) vertical distance(As far as possible)

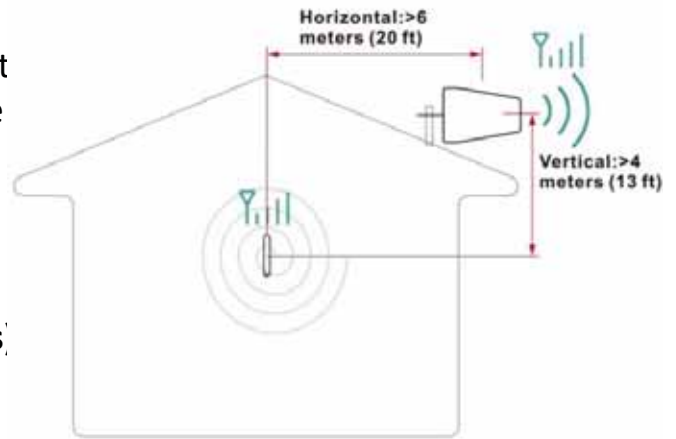

Measure the Signal Strength Inside your Home

- Test your current signal strength in multiple locations throughout the home
- Record the current signal strength in the table provided for reference



No	Location	Record(dBm)
1		
2		
3		

Top view of antenna beam shape and energy distribution

- For the outdoor antenna:
 1. The front radiation main beam angle is about 90 degrees;
 2. There is a very less energy radiation area behind the antenna, which we call it "blind area". The angle of the blind area is about 60 degrees;
- For the indoor antenna: The radiation beam is omnidirectional, the energy is evenly distributed in the direction of 360 degrees.

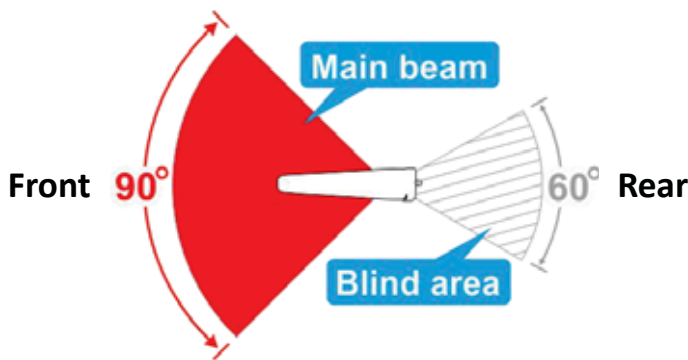

Outdoor antenna



Indoor antenna

Antenna mutual position(top view)

Ensure the distance, keep indoor antenna in the blind area(the best solution).

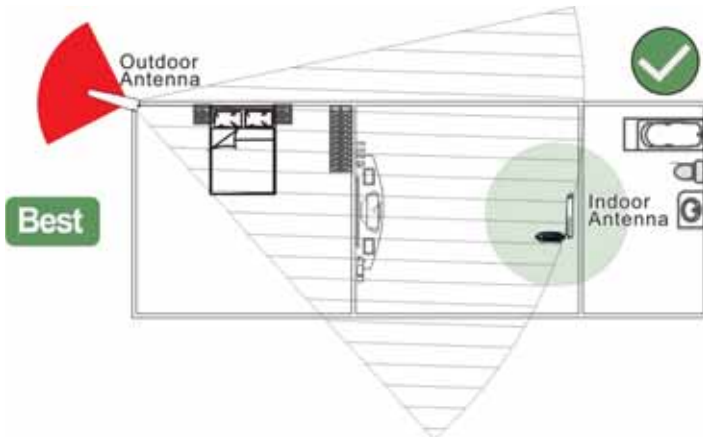

Ensure the distance, indoor antenna outside of blind area but it's at rear side of the outdoor antenna(good solution).

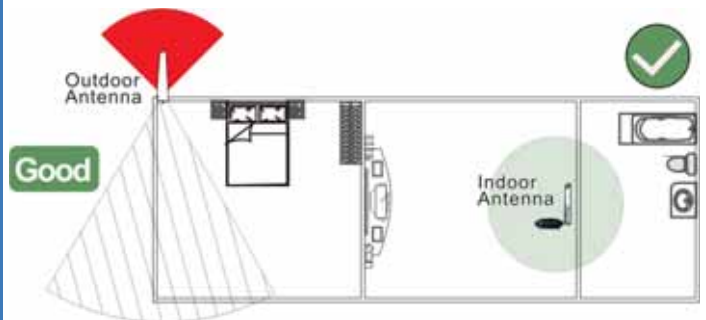

Do not face the outdoor antenna to the indoor antenna.

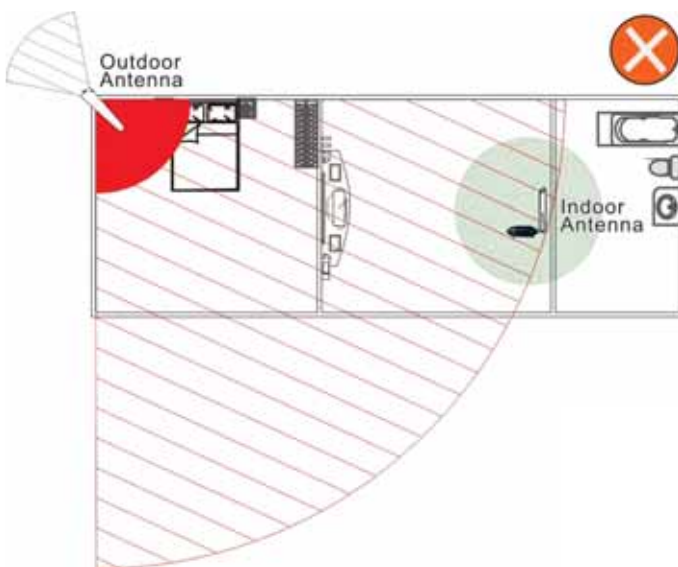

Do not set the indoor antenna at the front side of the outdoor antenna.

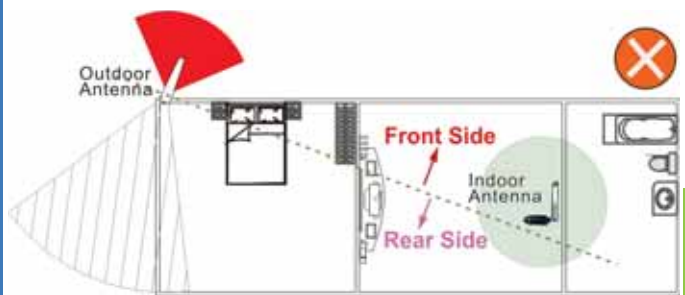

The indoor antenna is an omnidirectional antenna. Choosing a location in the middle of your home will help maximize coverage.



Step4: Connect the System

1. Connect the outside antenna to the 60 feet RG6 cable, Secure the cable near the antenna.



Secure the cable near the antenna to prevent cable damage caused by wind shaking

2. Connect the cable to "OUTSIDE" port on the booster.



3. Connect the indoor antenna to the "INSIDE" port on the booster.



4. Plug in the power adaptor and connect it to the nearest power outlet.



Correct Panel Lights - Self-test

The indicator light on the front panel indicates the status of the booster. Every time the booster is turned on, all the indicators will turn green for about 1 second and then go off. This means that the booster has passed the self-test and is in good condition. If you can see any flash or solid green, that means the separation is not enough or the outdoor antenna is facing the indoor antenna. Please go to "**Trouble Shooting**" on page 17 for detail information.



Power On



Flash once time



Go off

Step5: Evaluate the Effects

- Now that the booster is up-and-running, re-test the signal strength inside your home at the same locations from Step 3. If the number is higher (dBm reading is closer to zero) than the original reading, your booster is working.
- If your signal is not stronger, check the LED lights on the booster and refer to the “**Trouble Shooting**” on page 17 for detail information.



No	Location	Record(dBm)
1		
2		
3		

Note: Decibel Gain and Power Amplification may vary depending on the specifics of your situation. Different building materials and other obstructions in your home will result in different outcomes.

How to visually confirm that your installation is effective and correct?

At a distance of 6 feet from the indoor antenna, test the signal strength without obstruction. If this test result is 15~20db higher than your test result at the outdoor antenna position, then your system has reached the best effect.

For example, you test a signal of -90dbm at 6 feet away from the indoor antenna. Your outside antenna position record is -105dbm. So the improvement is:

$$-90\text{dbm} - (-105\text{dbm}) = 15\text{db}$$

If your results do not reach this range, please go to “**Trouble Shooting - No Improvement**” on page 24 for detail information.



Note1: In daily life, the signal dbm readings of our mobile phones range from -70dbm to -120dbm. Because it is a negative number, the smaller the number, the greater the signal strength.

Note2: In the case of no problems with the installation, the strength of the indoor signal depends entirely on the strength of the outdoor signal.

Step6: Finalizing Outdoor Antenna Installation

Once you have tested the performance of the signal booster and made all necessary adjustments, it's time to finalize the installation.

Outdoor Antenna Installation

Make sure that the outside unit is mounted at least 3 feet away from any windows.

Option A : Outside Roof Pole Mount (Best Choice) Use an existing pole to mount the outdoor unit in the optimal signal location. Use the picture for reference.

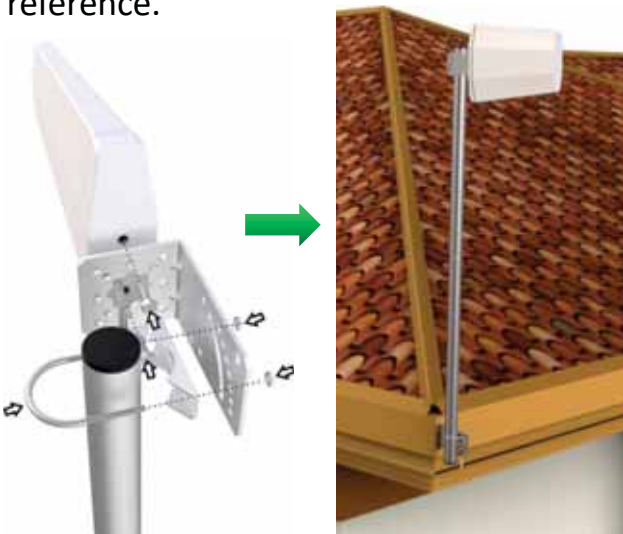

Option B : Mounting on the side of the chimney(Second Choice).

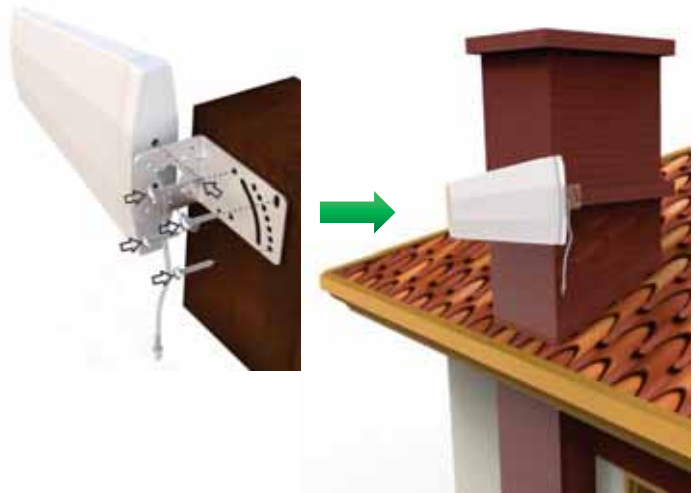

Seal and Fix the Connector

In particular, cables for outdoor antenna locations must be fixed. Otherwise, the internal wires of the cable will be pulled off after the wind has been shaken for a long time. The amplifier will not receive the signal and the system will fail completely.

 As shown in the figure, it is best to have the cable around a single turn shape and then fix it.

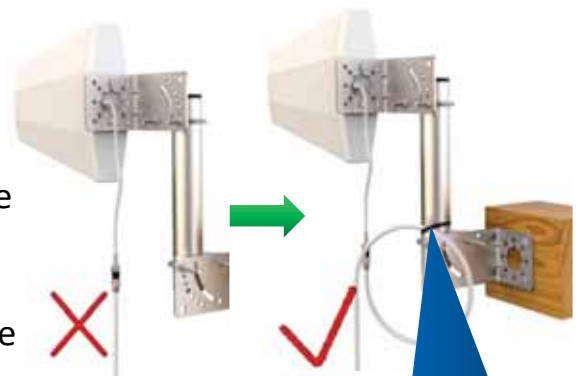

Secure the cable to prevent cable damage caused by wind shaking

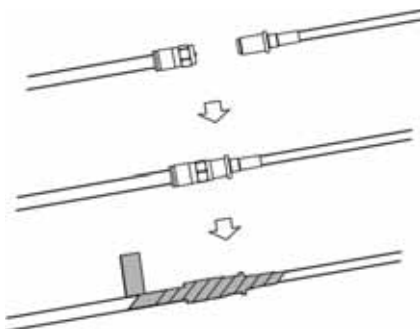

Long-term rain or moisture erosion can damage the electrical characteristics of outdoor antenna connectors. Make sure connectors are well screwed in and seal the connectors with glued tape.

Step7: Finalizing Indoor Installation

1. Choose right position for the indoor antenna

- 1 feet away from any other metallic objects
- 3 feet away from any windows

On the table



2. Mount the booster

- Choose a ventilated and dry place
- Keep away from heat
- Don't cover booster

On the wall



 Booster will about 30 degrees Fahrenheit higher than the ambient temperature, which is a normal phenomenon.

Step8: Finalizing and Securing Cable Route

- Find the best route for the cable. Follow the lines of your home to hide the cable in eaves or between the soffit and the exterior wall.
- If needed, cable clips can be purchased at most hardware stores.
- Whether the cable is properly secured is very important for the entire system. In most cases, the customer found that the booster did not work after working for a period of time because the cable was not installed securely.
- Carefully arrange the cable along the outside of the building and ensure that there are no folds or kinks. Fix the cable at each corner.

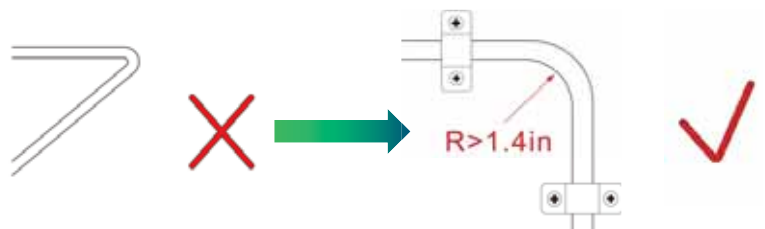

Caution

Seal and Fix the Connector

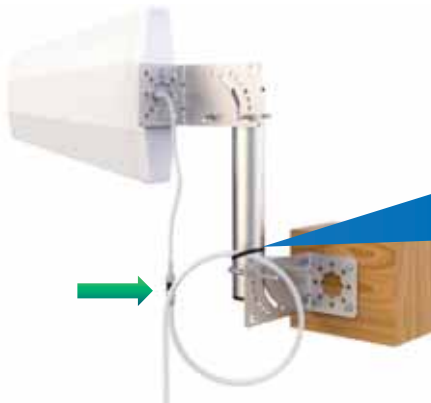
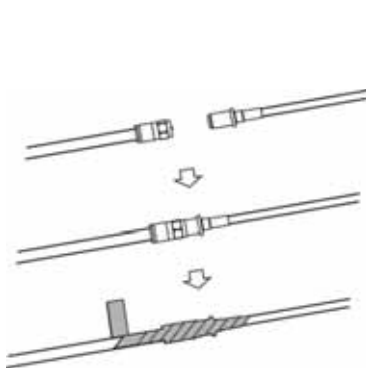

Secure the cable near the antenna to prevent cable damage caused by wind shaking

Properly Handle Excess Cables

If the coiled cable is too close to the antenna or booster, the system will be unstable. Make sure these coiled cables are more than 6 feet(2 meters) from the antenna or booster



Make sure these excess coiled cables are more than 6 feet(2 meters) from the antenna or booster can make your system work more stable.

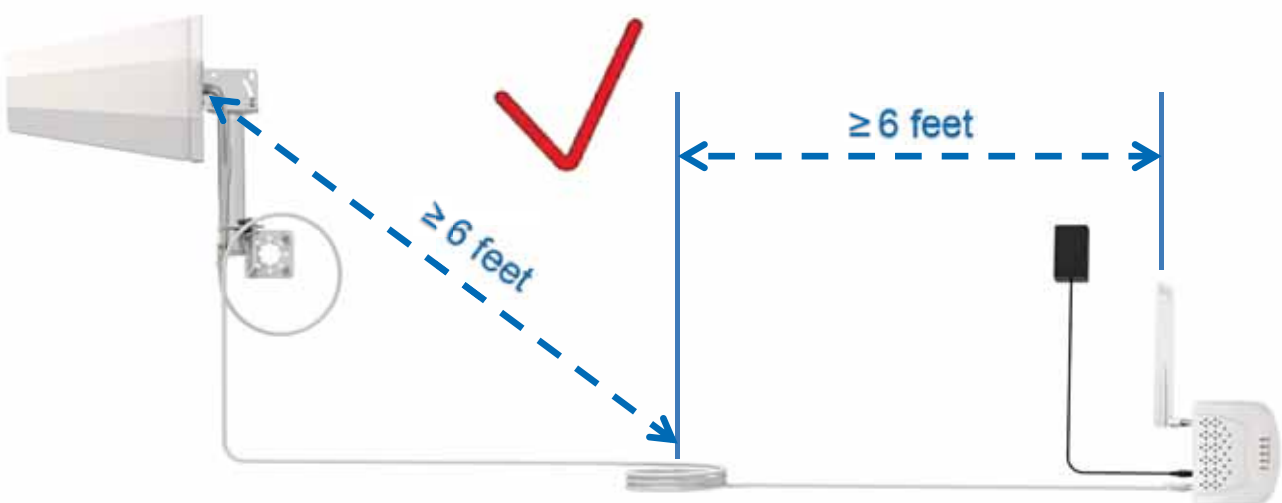

Trouble Shooting: Normal Working Status Indicator



Panel indicator Correct functioning:

- The indicator lights on the front panel indicate the status of each band of the booster. Every time the power is turned on, all the indicators will turn green for about 1 second and then go off. This means that the booster has passed the self-test and is in good condition. When there is no problem with the system, the indicator remains off during operation.

All the alarm lights should remain off during operation.

DC Power Indicator Correct functioning:

- Power Light should be solid green after powered on.

The LED will light up after power on.

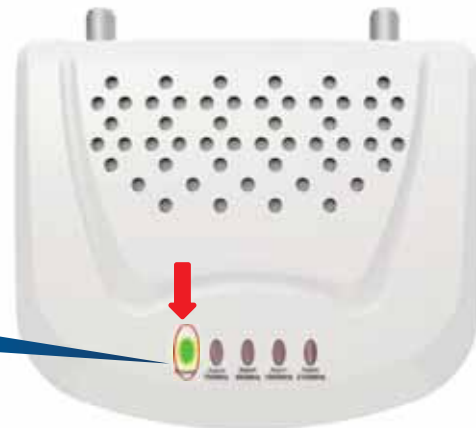

Trouble Shooting: No Power Light On



DC Power Indicator Off

- Please check your outlet, make sure it is normal;
- Contact us through email or phone call for replacement;

Trouble Shooting: Status Light Flash or Solid green

The panel indicator is flashing or solid green:

1. Booster has CPU inside, it will do the "Oscillation" test every time after power on. When it detect the Oscillation is happening, it will lower the gain of the relative band 1dB. And then test again, see if the oscillation is cancelled. If not it will lowered the gain 1dB again. This cycle will continue.
2. If the gain of the band is lowered by CPU between 1~15dB, and the oscillate stopped. The status indicator will flash 1~15 times for 2 cycles.
3. If the gain of the band is lowered by CPU between 16~25dB, and the oscillate stopped. The status indicator will flash all the time.
4. If the CPU can not eliminate the oscillation after reducing the gain by 25dB, it will shut down the corresponding band to stop the oscillation. The status light will solid red.



Meaning of indicator light

Indicator Status	Gain lowered	What to do?
Flash 1 to 15 times(2 cycle)	1~15 dB	If your coverage is good and reception is good, you can ignore the flash.
Flash all the time	15~25 dB	Check and install the whole system again.
Solid red	shut down	Check and install the whole system again.

 Every 3dB lower, the power level go down 50%. Every 6dB lower the power level go down 75%, the coverage radius go down 50%.

Basic Oscillation Knowledge

Have you ever had the experience of putting the microphone in front of the speaker and you'll hear a loud noise?

1. Microphone receive sound which from the speaker, and then send the sound to speaker;
2. Speaker boost the sound then broadcast the bigger sound to microphone again;
3. The sound gets louder and louder, and eventually it becomes noise.

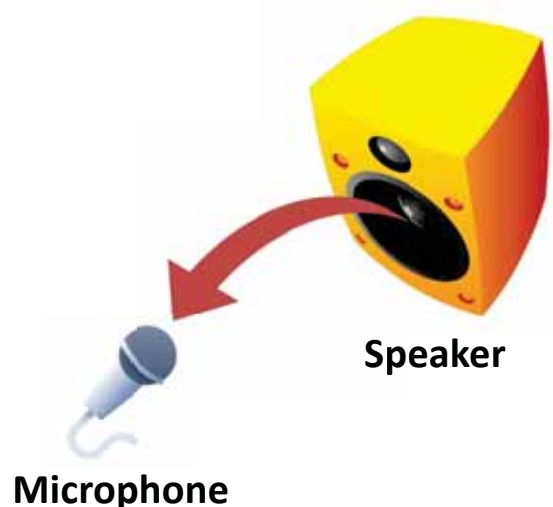

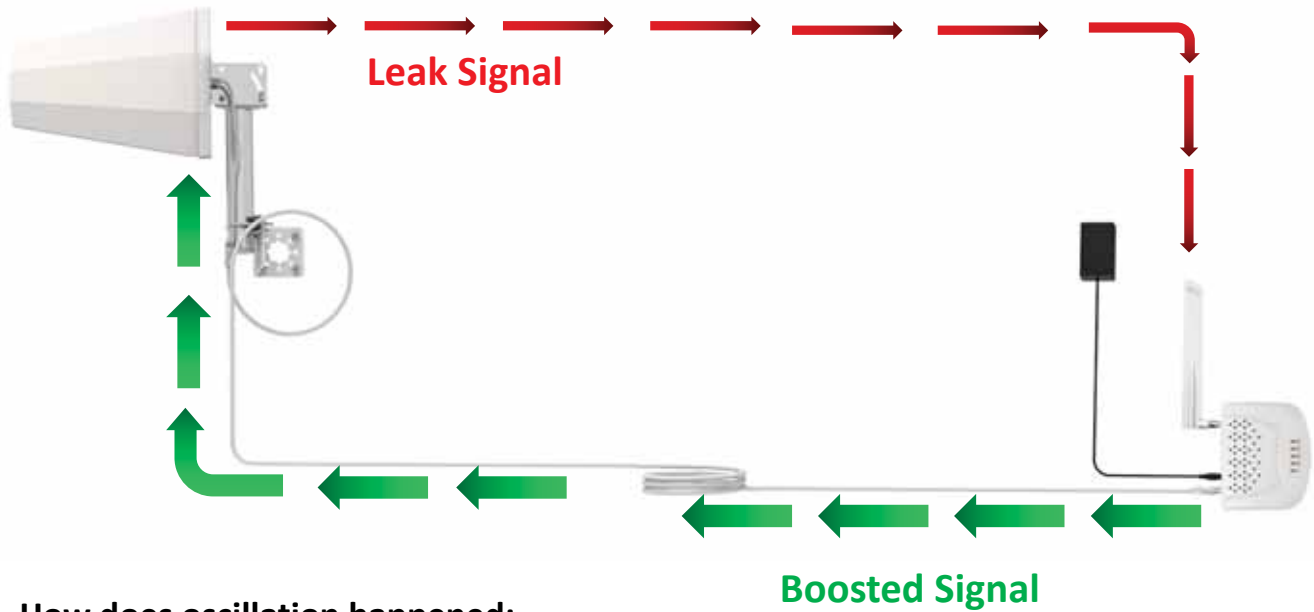

How does oscillation happened:

1. Indoor antenna receive leak signal from the outdoor antenna;
2. Booster amplify the signal and then transmit it to the outdoor antenna;
3. Outdoor antenna broadcast the signal in the air, some of the signal back to indoor antenna become leak signal;
4. If the gain of the booster higher than the loss of the leak signal, the leak signal will become bigger and bigger, finally oscillation happened.

Trouble Shooting: How to confirm that oscillation has occurred

1. Panel light flash or solid green after power on;
 2. Screw off the indoor antenna from the booster;
 3. Restart the power supply;
 4. All indicator lights flash once time after power on show self-test finished;
 5. The panel light doesn't flash or solid on.
- Such a situation means your system has oscillation problem.



Trouble Shooting: How to solve the problem of oscillation

Step 1: Keep enough distance between indoor and outdoor antennas

Minimum Required Separation Distance Between Indoor and Outdoor Antenna :
 Straight line distance over 30 feet(10 meters)
 or
 20 ft (6 meters) horizontal distance
 13 ft (4 meters) vertical distance(As far as possible)

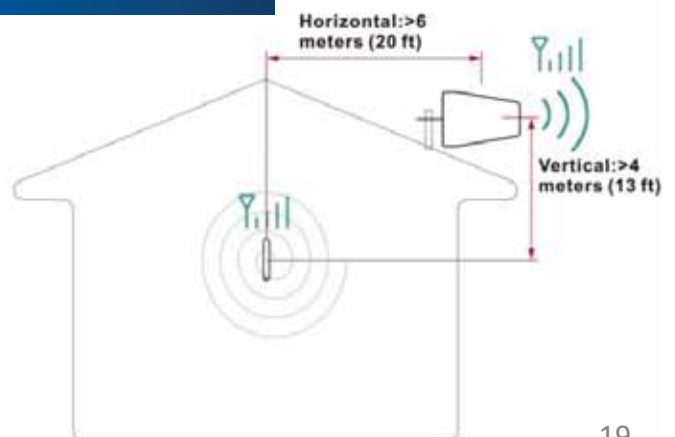

Step 2: Outdoor antenna must be installed over the roof line

The roof can block the signal coupling between the indoor and outdoor antennas, improve the stability of the system. Installing the outdoor antenna above the roof can form a large isolation area between the two antennas. Greatly reduce the signal leakage between the two antennas.



Step 3: Keep indoor antenna in the “blind area” of the outdoor antenna

1. The front radiation main beam angle is about 90 degrees;
2. There is a very less energy radiation area behind the antenna, which we call it “blind area”. The angle of the blind area is about 60 degrees;

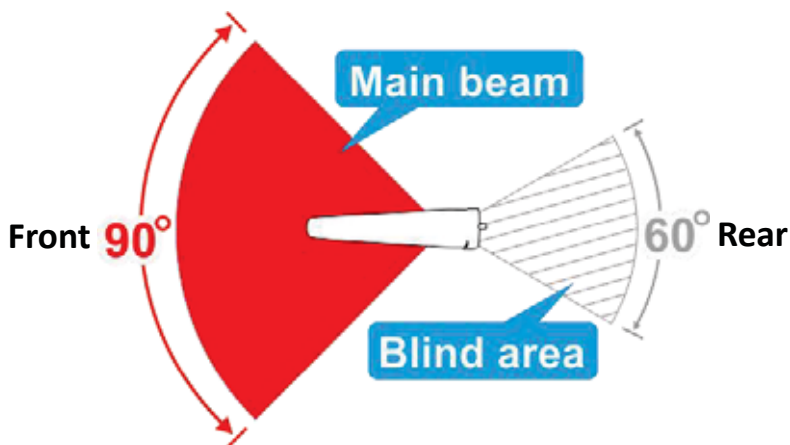

Top view(horizontal) of outdoor antenna



Outdoor antenna

If you have oscillating issue, at the same time, due to the structure or size of the house, your installation can not keep enough distance between indoor and outdoor antenna. Please setup your indoor antenna in the “blind area”, that will increase the isolation greatly. Effectively solve the problem of oscillation.

When you do this, your outdoor antenna may not right facing the cell tower. That is fine. Please understand that any direction in the main beam area will be the same reception. Remember, the antenna's forward horizontal main beam is about 90 degrees.

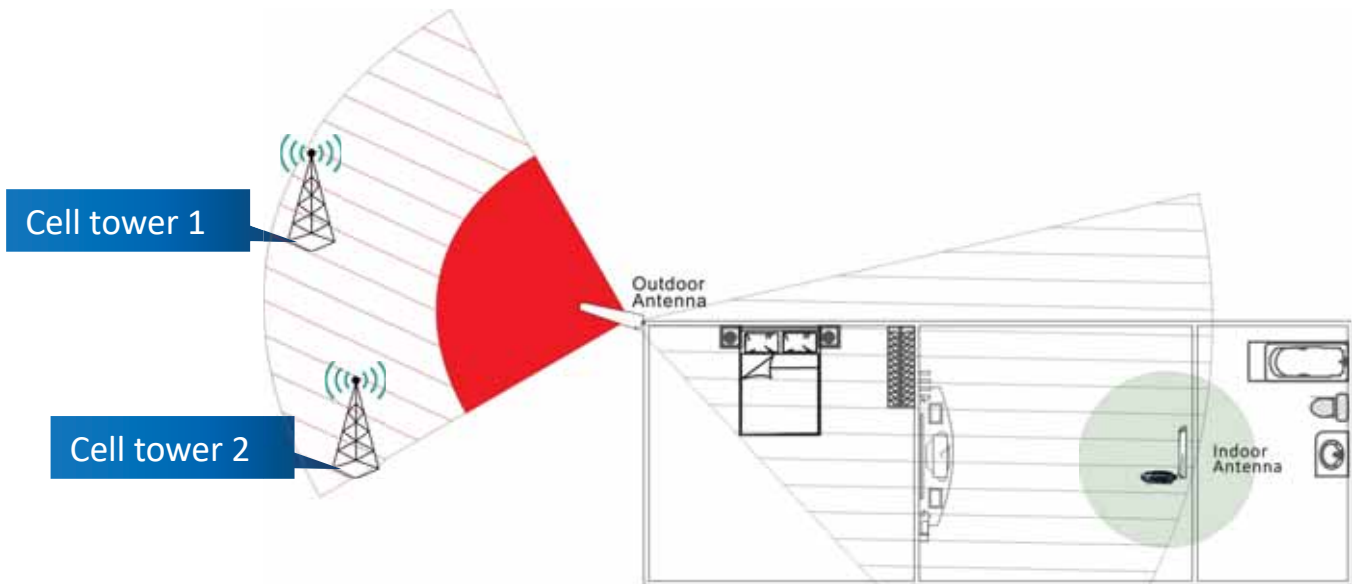

⚠ Cell tower No. 1 and No. 2 in the above picture, their signal received by outdoor antenna is the same.

Step 4: Check whether there is a reflecting surface formed by a large object in front of the outdoor antenna

1. Please understand that the physical properties of radio wave transmission are a bit like that of light. Will form a reflection on the surface of the object. The reflection efficiency varies according to the material of the object. Metal objects reflect the most strongly.
2. In some cases, the signal from the outdoor antenna will be reflected to the indoor antenna, causing oscillation.

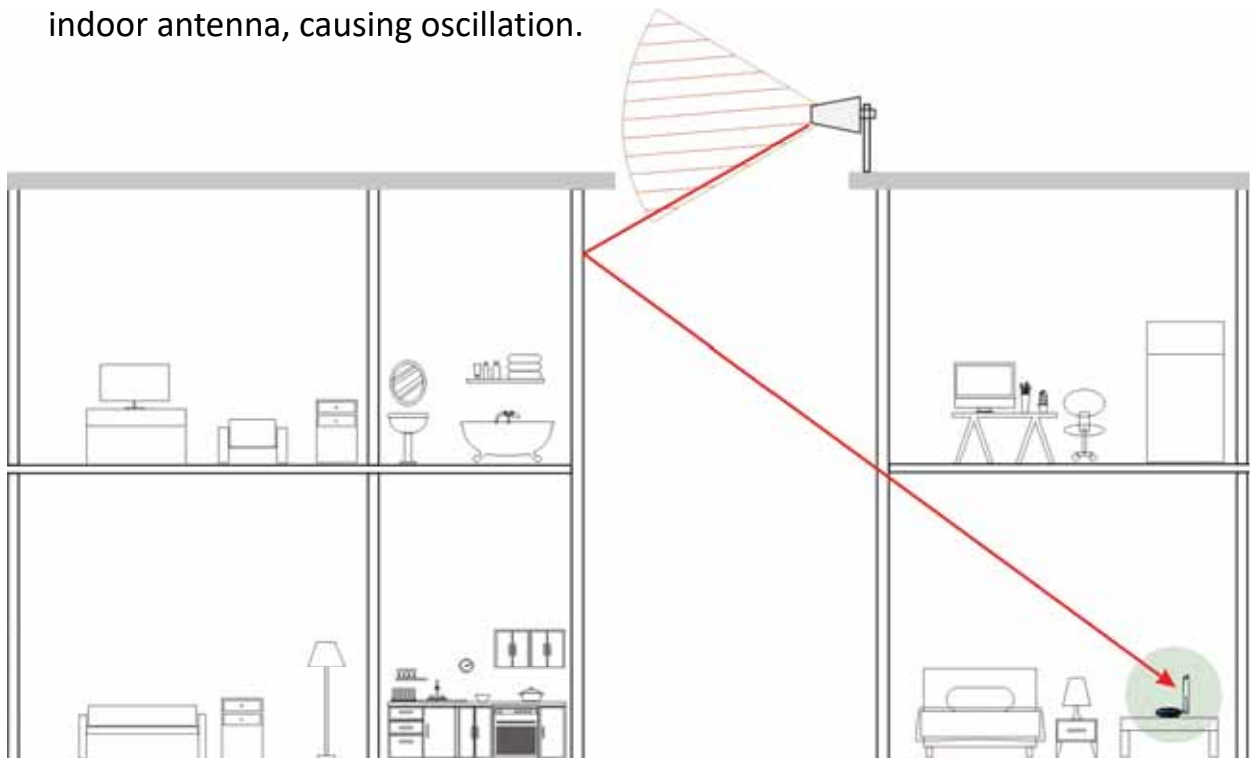

⚠ The vertical direction front radiation main beam angle is about 60 degrees.

Real case 1: Oscillation caused by signal reflection

Basic information description

1. The outdoor antenna is right facing the cell tower;
2. There is a iron warehouse in front of the outdoor antenna, about 100 ft away from the outdoor antenna;
3. Distance between the indoor and outdoor antenna is good enough;
4. Indoor antenna is setup in the “blind area” of the outdoor antenna;
5. Indicators for band 12 and band 13 on the panel always solid green after power on;

Case analysis:

The outer surface of the warehouse facing the outdoor antenna, become a big reflect surface. It reflect the signal from the outdoor antenna to the indoor antenna.

Solution:

Horizontal rotating outdoor antenna. Keep the cell tower at the edge of the main beam, same time move part of the warehouse out of the main beam. This reduces the energy of the reflected signal.

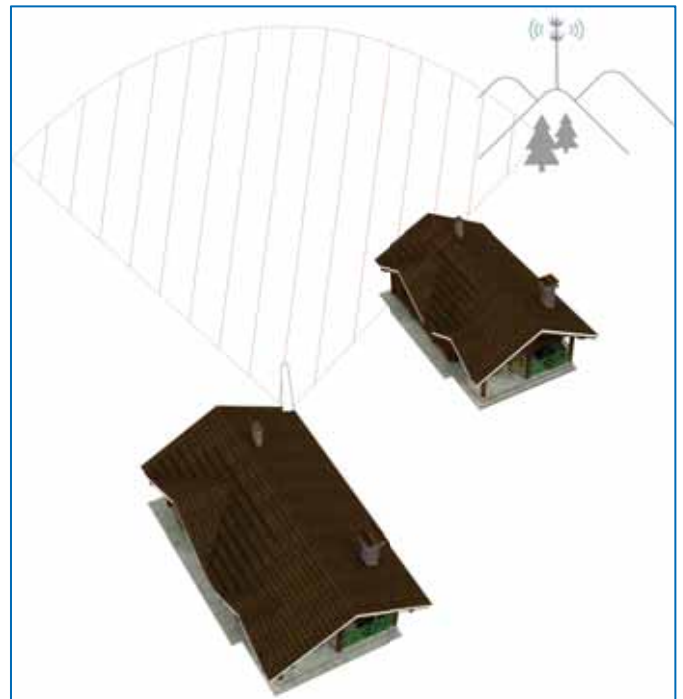
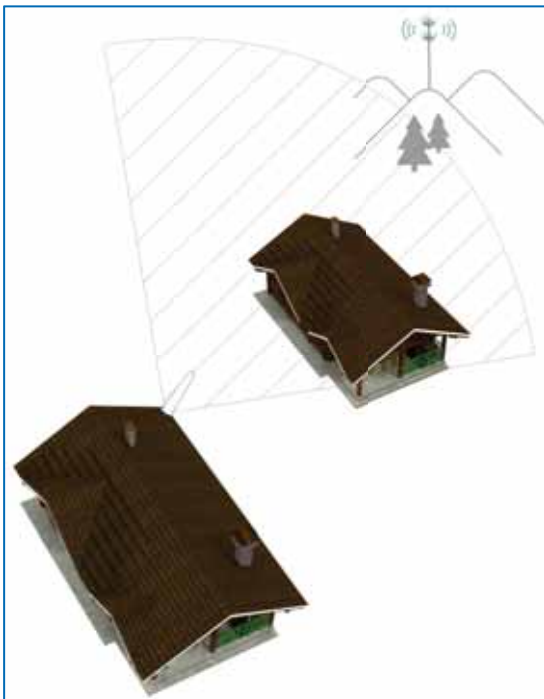

Real case 2: Oscillation caused by signal reflection

Basic information description

1. The outdoor antenna is right facing the cell tower;
2. There is a big building in front of the outdoor antenna, about 100 ft away from the outdoor antenna;
3. Distance between the indoor and outdoor antenna is good enough;
4. Indicators for band 12 and band 13 on the panel always solid green after power on. Other band indicators flash.

Case analysis:

The outer surface of the building facing the outdoor antenna, become a big reflect surface. It reflect the signal from the outdoor antenna to the indoor antenna.

Solution:

Vertical rotating outdoor antenna up 15 to 30 degree. Keep the cell tower at the bottom edge of the main beam, same time move part of the opposite building out of the main beam. This reduces the energy of the reflected signal.

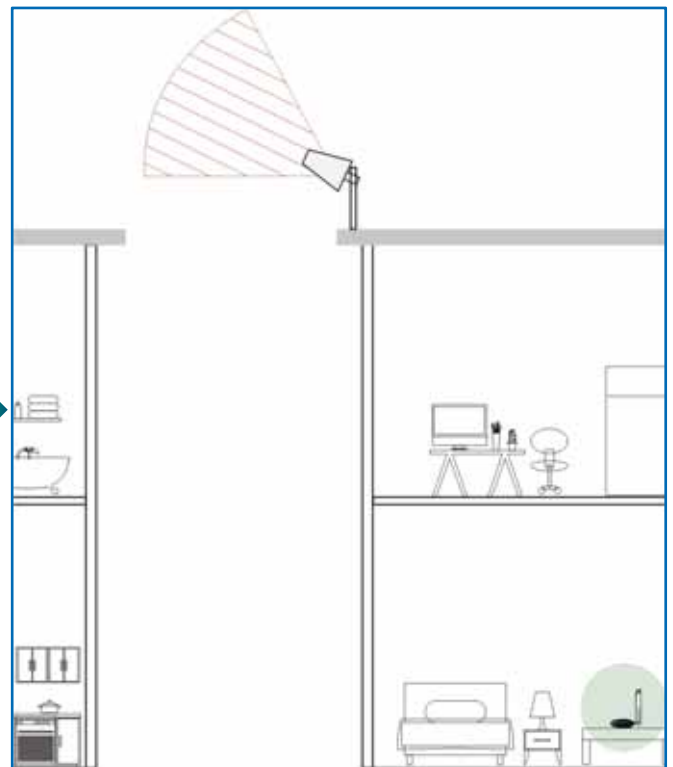
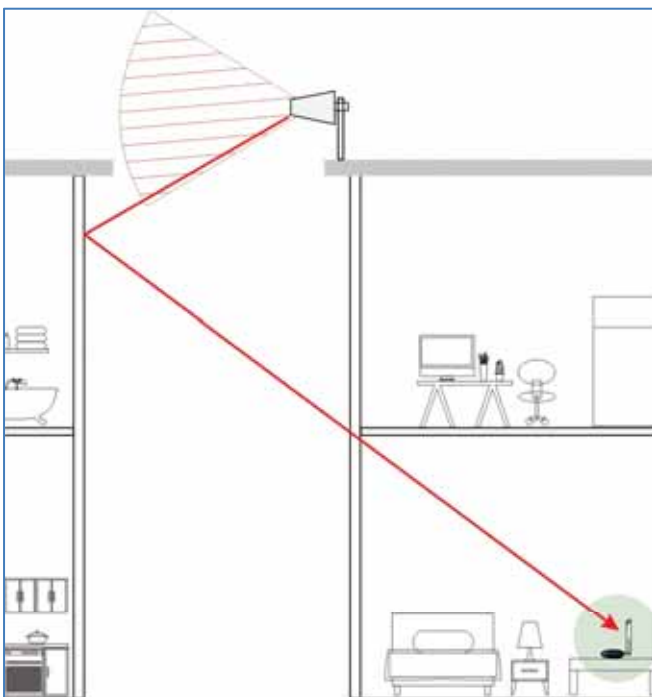

Trouble Shooting: No Signal Improvement

Follow the test method on page 13, if your signal doesn't improve at all. Please follow the steps below to find out the reason.

Step 1. Check band number. Make sure your band number belongs to one of the following: band 12/17/13/5/2/25. If not this booster can't help you.

Step 2. Check incoming signal level at outdoor antenna position.

Usage of a booster is not recommend when the outdoor signal is less than -110dbm(3G) or -120dBm(4G).

Step 3. Observe the indicator light on the control panel, if there is flashing or constant light alarm, please go back to page 18, solve the problem of oscillation first.



Trouble Shooting: The Signal Increase Was Not Obvious

Follow the test method on page 13, if your signal doesn't improve as much as 15 to 20 db. Please follow the steps below to make improvements.

Step 1. Find your cell tower direction. Check website www.cellmapper.net. Double check your outdoor antenna direction, see if it is facing the tower which coverage your house.

On the map, you can see three colors of dots representing the cell tower. Different colors represent different degrees of information accuracy.

Red pointer: Low accuracy and unlocated

Yellow pointer: unlocated

Green pointer: located



Many of our customers can have signal reception outside of the house, but have experienced the following two situations:

1. Only red dots can be found on the map around home. And through field observation, there are no cell towers in those places, or there have been.
2. There is no cell tower information on the map around the house.

Solution:

Walk around the house, make sure to walk close to the outside wall of the house. Find the best dbm reading position. That direction is the direction of your cell tower. Please understand that the main beam of the outdoor antenna is about 90 degree. As long as the cell tower is in this range, it can work normally. Best to choose the corner position of the building.

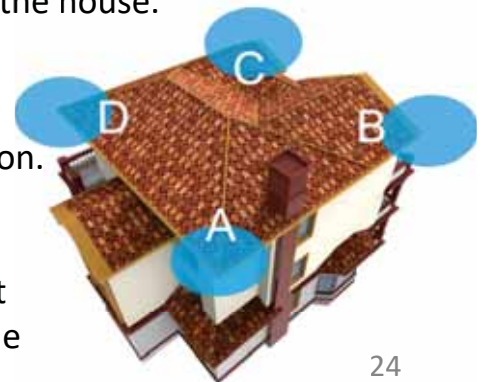

Trouble Shooting: The Signal Increase Was Not Obvious

Step 2. Improve the receiving conditions of outdoor antenna. Trees will greatly attenuate wireless signals. If there are tall trees around your house. At the same time you can't find a stable signal above 2 bars(-90dbm), the outdoor antenna needs to be erected 60%(at least) to 80%(best) of the tree height(**Never exceed the trees!**).

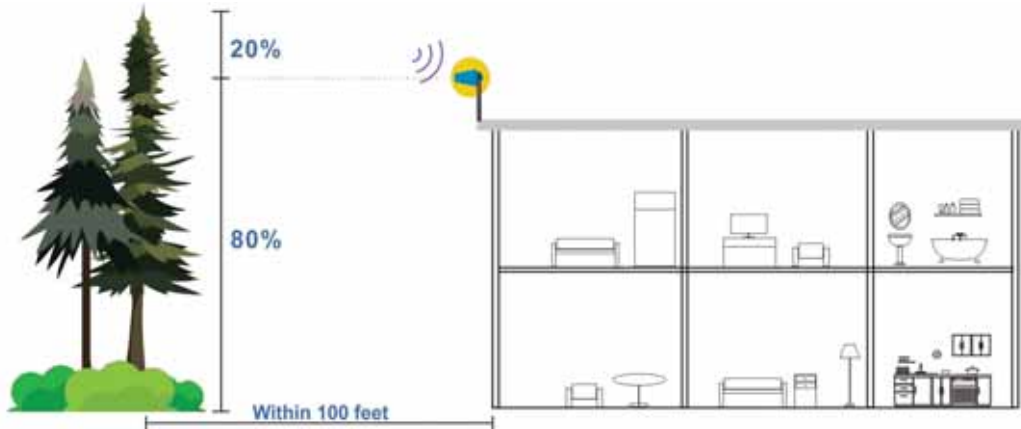

Solution:

Below two cases, customers all have signal improvement issue. After they raised the installation position of outdoor antenna again, the signal improvement was very obvious



Trouble Shooting: Frequent Customer Questions

Q1. Can I add more cables? How long can the longest increase be?

A: Please understand that more cables means more insertion loss, that will decrease the system gain, and will decrease the coverage area. So it will depend on how good your outdoor signal reception is. Please refer to the table below for consideration.

RG6

added length (ft)	30	60	120	180
Coverage radius reduction	40%	50%	75%	87.5%

RG11

added length (ft)	60	120	240	360
Coverage radius reduction	40%	50%	75%	87.5%

For example:

If you current coverage radius is 100 ft, and you add 120 ft RG6 cable to the system. Your final coverage radius will be $100 * (1 - 75\%) = 25$ ft.

Q2. Do I need to install a lightning arrester?

A: Please understand that our outdoor antenna is internal DC short circuit. So the external antenna has certain lightning protection capability. However, if it is directly hit by lightning, it will still damage the equipment. So the best way is not to install the antenna in the highest position of the building to avoid lightning. If lightning strikes are frequent in your area, it is safer to install arresters before cables enter the room.

Q3. The temperature is very high when the booster works. Is that normal?

A: Yes, when the booster works, the temperature will be 25 °C to 30 °C higher than the ambient temperature. Operating temperature range is 5°F to 140°F (-15°C~60 °C).

Q4. How many devices can this booster support?

A: Each band can support 5~10 users same time.

Technical Specification

Frequency (MHz)		LTE (band 12)	LTE (band 13)	Cellular (band5)	PCS (band 25/2)
	Uplink	698-716	777-787	824-849	1850-1915
	Downlink	728-746	746-757	869-894	1930-1995
Gain	Uplink	62	62	62	65
	Downlink	65	65	65	68
Output power	23dBm(Uplink)/3dBm(Downlink)				
Noise figure	<5dB				
In-band Flatness	<9dB				
Weight	0.65Kg				
EIRP	1W				
Impedance	50 ohm				
Operating temperature	5°F to 140°F (-15°C~60 °C)				
Current	≤1.5A(12V DC)				
Dimension(mm/in)	158*125*25/6.2*4.87*0.98				

WARRANTY



The Booster is covered under a three-year product warranty for failures or defects that result from craftsmanship and/or materials. Dated proof of purchase should be retained for use in warranty cases. Contact the retailer/reseller directly with any warranty issues, or alternatively contact the manufacturer in cases where the reseller is no longer available to handle warranty claims. In cases where the reseller is unavailable, the product may be returned to the manufacturer at the consumer's expense, with a dated proof of purchase and a return authorization letter which can be attained by contacting SolidRF.

This warranty does not apply to any signal booster components determined by SolidRF to have been subjected to misuse, abuse, neglect, tampering, or mishandling that result in damages to the physical or electronic properties of the product. Refurbished products that have been recertified to conform to product specifications may be used for product replacements.

DISCLAIMER: The information provided by SolidRF is believed to be complete and accurate, to the best of our knowledge. However, no responsibility is assumed by SolidRF for any business or personal losses arising from the use of the information herein contained, or for any infringements of patents or other rights of third parties that may result from its use.

Warnings and Recommendations

- ⚠ Warning: This consumer booster is for Consumer use only.
- ⚠ Warning: Unauthorized antennas, cables, and/or coupling devices are prohibited by FCC regulations. Please contact FCC for details: 1-888-CALL-FCC.
- ⚠ Warning: Outside antenna orientation must be back side of inside antenna is to prevent the indoor antenna receiving the signal emitted by outside antenna. Otherwise it will cause self-oscillation of booster.
- ⚠ Warning: RF safety, any antenna used with this device must be located at 20 cm (8 inches) away from persons or by bystanders.
- ⚠ Warning: It will damage the mobile device and the booster if connect them with a cable directly.
- ⚠ Warning: Use the power supply provided by SolidRF only. Other power supplies may cause damage of the booster.
- ⚠ Warning: Antenna installation is restricted to 10 meters or less height above ground, even if the antenna is installed inside when used with a mobile device that operates in the 1710-1755 MHz band. Violation of this requirement may subject the owner of the booster to potential FCC enforcement actions.
- ⚠ Warning: Never point the front of a directional antenna toward the inside antenna. Verify that both the outside antenna and the inside antenna are connected to the booster before powering up the booster .

(EN) RF Exposure: The manufacturer's rated output power of this equipment is for single carrier operation. For situations when multiple carrier signals are present, the rating would have to be reduced by 3.5 dB, especially where the output is re-radiated and can cause interference to adjacent band users. This power reduction is to be by means of input power or gain reduction and not by an attenuating at the output of the device.

(FR) Exposition RF: La puissance de sortie nominale du fabricant de cet équipement est pour le fonctionnement d'une seule porteuse. Pour les situations où plusieurs signaux de porteuse sont présents, la note devrait être réduite de 3,5 dB, en particulier lorsque le signal de sortie est rayonné et peut causer des interférences aux utilisateurs de bande adjacents. Cette réduction de puissance doit se faire au moyen d'une puissance d'entrée ou d'une réduction de gain et non pas par un atténuateur à la sortie du dispositif.

(EN) This device complies with Industry Canada license-exempt RSS standard(s). Operation is subject to the following two conditions: (1) this device may not cause interference, and (2) this device must accept any interference, including interference that may cause undesired operation of the device.

(FR) Le présent appareil est conforme aux CNR d'Industrie Canada applicables aux appareils radio exempts de licence. L'exploitation est autorisée aux deux conditions suivantes : (1) l'appareil ne doit pas produire de brouillage, et (2) l'utilisateur de l'appareil doit accepter tout brouillage radioélectrique subi, même si le brouillage est susceptible d'en compromettre le fonctionnement.

(EN) This system has been evaluated for RF Exposure per RSS-102 and is in compliance with the limits specified by Health Canada Safety Code 6. The system must be installed at a minimum separation distance from the antenna to a general bystander of 8 inches (20 cm) to maintain compliance with the General Population limits.

(FR) L'exposition aux radiofréquences de ce système a été évaluée selon la norme RSS -102 et est jugée conforme aux limites établies par le Code de sécurité 6 de Santé Canada. Le système doit être installé à une distance minimale de 8 pouces (21 cm) séparant l'antenne d'une personne présente en conformité avec les limites permises d'exposition du grand public.

Description of network protection features:

This booster including safeguards to protect the cellular network from interference. Each Signal Booster is individually tested and factory set to ensure FCC compliance.

1. The Signal Booster cannot be adjusted without factory reprogramming or disabling the hardware.
2. The Signal Booster will amplify, but **ONLY** incoming and outgoing signals in order to increase coverage of authorized frequency bands.
3. If the Signal Booster is not in use for five minutes, it will reduce gain until a signal is detected.
4. If a detected signal is too high in a frequency band, or if the Signal Booster detects an oscillation, the Signal Booster will automatically turn the power off on that band.
5. For a detected oscillation the Signal Booster will automatically resume normal operation after a minimum of 1 minute. After 5 times consecutive such automatic restarts, if the detected oscillation still remains, any problematic bands are permanently shut off until the Signal Booster has been manually restarted by reconnecting power supply to the Signal Booster.
6. Noise power, gain, and linearity are maintained by the Signal Booster's microprocessor.

This is a CONSUMER device

BEFORE USE, you MUST REGISTER THIS DEVICE with your wireless provider and have your provider's consent. Most wireless provider consent to the use of signal boosters. Some provider may not consent to the use of this device on their network. If you are unsure, contact your provider.

You MUST operate this device with approved antenna and cables as specified by the manufacturer. Antennas MUST be installed at least 20cm (8inches) from any person.

You MUST cease operating this device immediately if requested by the FCC or a licensed wireless service provider.

WARNING. E911 location information may not be provided or may be inaccurate for calls served by using this device.

This device may be operated ONLY in a fixed location for in-building use.

This device complies with Part 15 of FCC Rules. Operation is subject to the following two conditions: (1) this device may not cause harmful interference, and (2) this device must accept any interference received, including interference that may cause undesired operation.

Changes or modifications not expressly approved by the party responsible for compliance could void the user's authority to operate the equipment

Contact information for providers

A subscriber must have the consent of a wireless provider to operate a consumer signal booster. Please register your booster with your wireless service provider, refer to contact information for providers:

Sprint:

signalbooster@sprint.com

T-Mobile:

www.T-Mobile.com/BoosterRegistration

<https://support.t-mobile.com/docs/DOC-9827>

Verizon:

<http://www.verizonwireless.com/wcms/consumer/register-signal-booster.html>

AT&T:

<https://securec45.securewebsession.com/attsignalbooster.com/>

U.S. Cellular:

<http://www.uscellular.com/uscellular/support/fcc-booster-registration.jsp>

Metro PCS

<https://www.metropcs.com/support/signal-booster>

Safety Guidelines

To uphold network protection standards and ensure compliance, all active cellular devices must maintain a separation distance of at least six feet between the inside unit antenna and outside unit antenna and at least four feet of separation distance from the inside unit. Use only the power supply provided in this package. Use of a non-SolidRF product or accessory may result in damage to the equipment or

components of the equipment. The inside unit is designed for use in an indoor, temperature-controlled environment (less than 100 degrees Fahrenheit). It is not intended for use in attics or similar locations where temperatures may be in excess of that range.

RF Safety Warning: Any antenna used with this device must be located at least 8 inches from all persons.

This is a CONSUMER device.

BEFORE USE, you **MUST REGISTER THIS DEVICE** with your wireless provider and have your provider's consent. Most wireless providers consent to the use of signal boosters. Some providers may not consent to the use of this device on their network. If you are unsure, contact your provider.

In Canada, **BEFORE USE** you must meet all requirements set out in ISED CPC-2-1-05. You **MUST** operate this device with approved antennas and cables as specified by the manufacturer. Antennas **MUST** be installed at least 20 cm (8 inches) from (i.e., **MUST NOT** be installed within 20 cm of) any person.

You **MUST** cease operating this device immediately if requested by the FCC (or ISED in Canada) or licensed wireless service provider.

WARNING. E911 location information may not be provided or may be inaccurate for calls served by using this device.

This is a CONSUMER device.

BEFORE USE, you **MUST REGISTER THIS DEVICE** with your wireless provider and have your provider's consent. Most wireless providers consent to the use of signal boosters. Some providers may not consent to the use of this device on their network. If you are unsure, contact your provider.

In Canada, BEFORE USE you must meet all requirements set out in ISED CPC-2-1-05.

You **MUST** operate this device with approved antennas and cables as specified by the manufacturer. Antennas **MUST** be installed at least 20 cm (8 inches) from (i.e., **MUST NOT** be installed within 20 cm of) any person.

You **MUST** cease operating this device immediately if requested by the FCC (or ISED in Canada) or a licensed wireless service provider.

WARNING. E911 location information may not be provided or may be inaccurate for calls served by using this device.

This device may be operated ONLY in a fixed location (i.e., may operate in a fixed location only) for in-building use.

CPC-2-1-05 — Zone Enhancers - Spectrum management and telecommunications
<http://www.ic.gc.ca/eic/site/smt-gst.nsf/eng/sf08942.html>

Mobile phone is the minimum distance to use indoor antenna	
Inside server antenna types	Minimum separation distances D (m)
Ceiling mounted (e.g., dome-type) antennas	2
Wall mounted (i.e., panel or other type) antennas	1.0 or 2*
Table top antennas	1.0

Antenna Kitting Information

Component	Type specification	Gain/Loss				
		LTE-707	LTE-781	800MHz	1900MHz	
Outside Cable	RG6FF 90Feet	4.3dB	4.6dB	5dB	7.6dB	Suirongcable
Outside Cable	SRLMR400-75NN 75Feet	4.2dB	4.2dB	4.4dB	6.1dB	Suirongcable
Outside Cable	RG6FF 75Feet	3.6dB	3.8dB	4.2dB	6.3dB	Suirongcable
Outside Cable	LMR240 75Feet	4.88dB	5.25dB	5.63dB	8.25dB	Suirongcable
Outside Cable	RG6FF 60Feet	2.9dB	3.0dB	3.3dB	5dB	Suirongcable
Inside Cable	SRLMR400-30NN 30Feet	1.9dB	1.9dB	1.95dB	2.9dB	Suirongcable
Inside Cable	RG6FF 45Feet	2.2dB	2.3dB	2.5 dB	3.8 dB	Suirongcable
Inside Cable	LMR240 45Feet	2.9dB	3.15dB	3.38dB	4.87dB	Suirongcable
Inside Cable	LMR240 90Feet	5.85dB	6.3 dB	6.75 dB	9.9 dB	Suirongcable
Inside Cable	LMR240 60Feet	3.9dB	4.2dB	4.5dB	6.6dB	Suirongcable
Inside Cable	LMR240 45Feet	2.9dB	3.15dB	3.38dB	4.87dB	Suirongcable
Inside Cable	SRLMR400-30NN 30Feet	1.9dB	1.9dB	1.95dB	2.9dB	Suirongcable
Inside Cable	SRG58-30FN 30Feet	4.5dB	4.5dB	4.9dB	7.6dB	Suirongcable
Inside Cable	SRLMR400-20NN 20Feet	1.3dB	1.3dB	1.35dB	1.8dB	Suirongcable
Inside Cable	SRG58-15FN 15Feet	2.35dB	2.4dB	2.56dB	3.9dB	Suirongcable
Inside Cable	SRLMR400-30NN 30Feet	1.9dB	1.9dB	1.95dB	2.8dB	Suirongcable
Outside Antenna	ANT050701	7dBi	7dBi	7dBi	10dBi	Shenzhen Dachi Communications Co., Ltd.
Outside Antenna	ANT010901	9dBi	9dBi	9dBi	9dBi	Shenzhen Dachi Communications Co., Ltd.
Outside Antenna	ANT010701	9dBi	9dBi	9dBi	9dBi	Shenzhen Dachi Communications Co., Ltd.
Outside Antenna	ANT060302	3dBi	3dBi	3dBi	3.5dBi	Shenzhen Dachi Communications Co., Ltd.
Outside Antenna	ANT030301	3dBi	3dBi	3dBi	3dBi	Shenzhen Dachi Communications Co., Ltd.
Inside Antenna	ANT050701	7dBi	7dBi	7dBi	10dBi	Shenzhen Dachi Communications Co., Ltd.
Inside Antenna	ANT010901	9dBi	9dBi	9dBi	9dBi	Shenzhen Dachi Communications Co., Ltd.
Inside Antenna	ANT010701	9dBi	9dBi	9dBi	9dBi	Shenzhen Dachi Communications Co., Ltd.
Inside Antenna	ANT060302	3dBi	3dBi	3dBi	3.5dBi	Shenzhen Dachi Communications Co., Ltd.
Inside Antenna	ANT040301	3dBi	3dBi	3dBi	3dBi	Shenzhen Dachi Communications Co., Ltd.
Inside Antenna	ANT080301	3dBi	3dBi	3dBi	3dBi	Shenzhen Dachi Communications Co., Ltd.
Inside Antenna	ANT080302	3dBi	3dBi	3dBi	3dBi	Shenzhen Dachi Communications Co., Ltd.
Inside Antenna	ANT080303	3dBi	3dBi	3dBi	3dBi	Shenzhen Dachi Communications Co., Ltd.
Inside Antenna	ANT060301	3dBi	3dBi	3dBi	3dBi	Shenzhen Dachi Communications Co., Ltd.
Inside Antenna	ANT060303	3dBi	3dBi	3dBi	3dBi	Shenzhen Dachi Communications Co., Ltd.
Inside Antenna	ANT070101	1dBi	1dBi	1dBi	1dBi	Shenzhen Dachi Communications Co., Ltd.
Inside Antenna	SR-21300100	3dBi	3dBi	3dBi	3.5dBi	Shenzhen Dachi Communications Co., Ltd.
Lightning Protector	ACC010101	0.1 dB	0.1 dB	0.1 dB	0.18dB	Shenzhen Dachi Communications Co., Ltd.

Default combination:

SR14652002 A+ANT050701+RG6FF75Feet+ANT080301
SR14652002 B+ANT050701+RG6FF75Feet+ANT080302
SR14652002 C+ANT050701+RG6FF75Feet+ANT080303