



SWIFT. SILENT. SECURE.

LABEL SAMPLES – EA087 (MOVE ZR)

May 30, 2023



Top View of EA087 Housing (Label located in the red area inside the bottom channel)

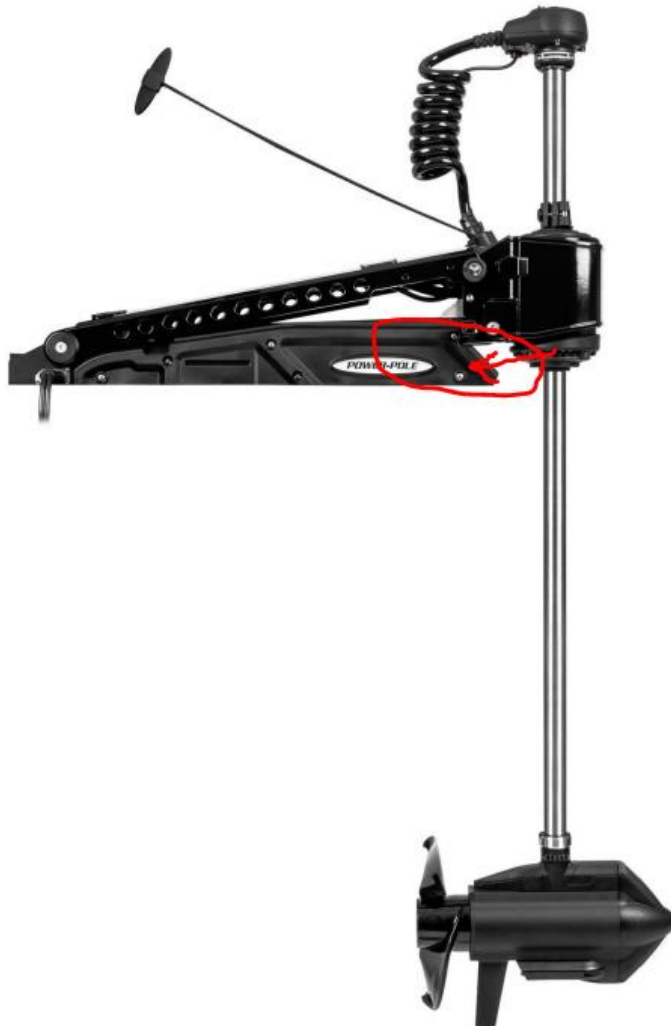

Side View of EA087 Housing (Label located in the red area inside the bottom channel)

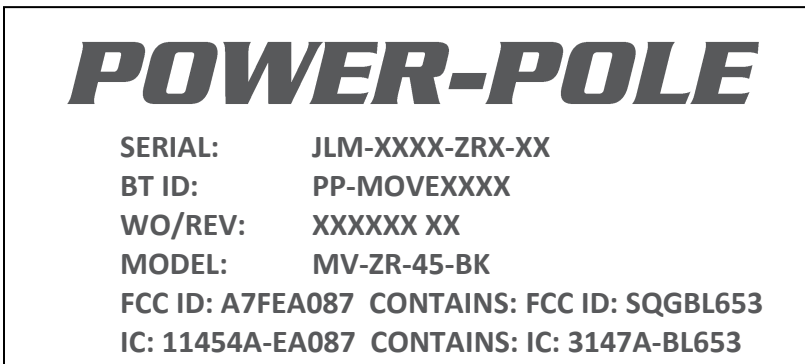

Specific Example of EA087 Label for Model: MV-ZR-45-BK (Size 2" Wide x 1" High)

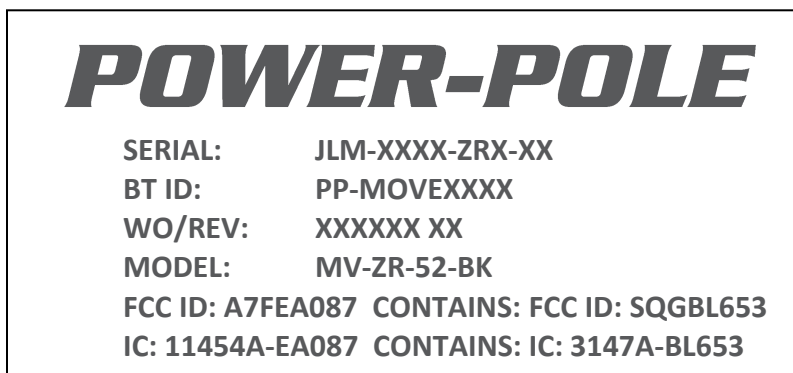

Specific Example of EA087 Label for Model: MV-ZR-52-BK (Size 2" Wide x 1" High)

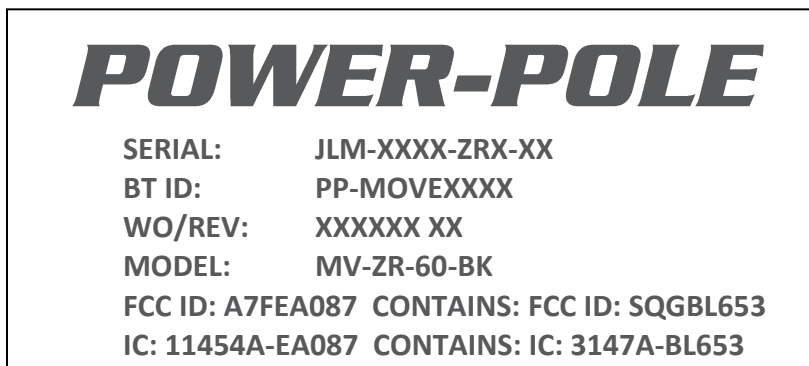

Specific Example of EA087 Label for Model: MV-ZR-60-BK (Size 2" Wide x 1" High)



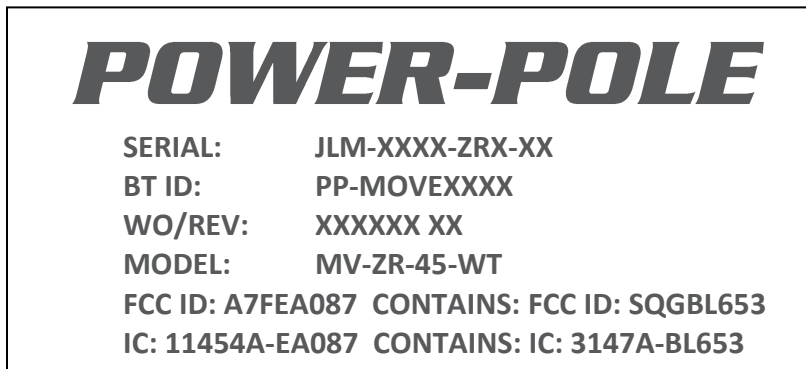

Specific Example of EA087 Label for Model: MV-ZR-45-WT (Size 2" Wide x 1" High)

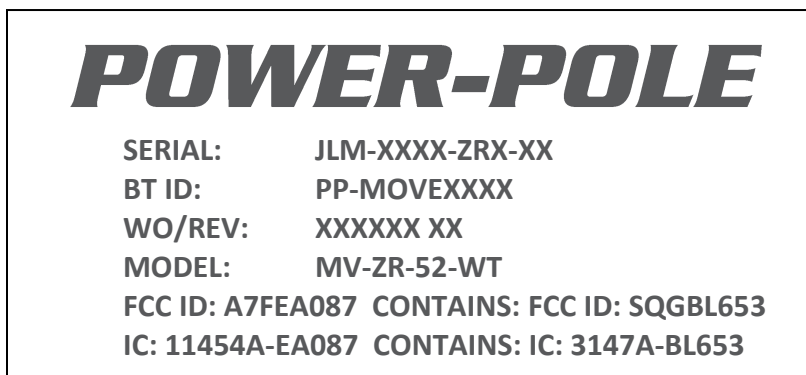

Specific Example of EA087 Label for Model: MV-ZR-52-WT (Size 2" Wide x 1" High)

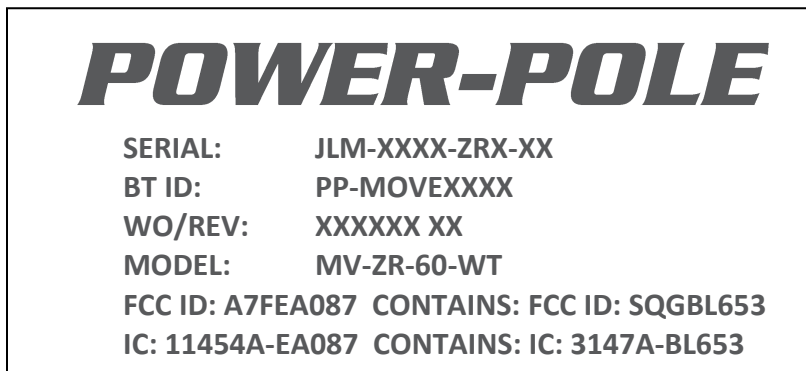

Specific Example of EA087 Label for Model: MV-ZR-60-WT (Size 2" Wide x 1" High)

