





DESKTOP AUDIO SYSTEM
TSX-B15

OWNER'S MANUAL



AB

IMPORTANT SAFETY INSTRUCTIONS

	CAUTION RISK OF ELECTRIC SHOCK DO NOT OPEN	
---	---	---

CAUTION: TO REDUCE THE RISK OF ELECTRIC SHOCK, DO NOT REMOVE COVER (OR BACK). NO USER-SERVICEABLE PARTS INSIDE. REFER SERVICING TO QUALIFIED SERVICE PERSONNEL.

• Explanation of Graphical Symbols



The lightning flash with arrowhead symbol, within an equilateral triangle, is intended to alert you to the presence of uninsulated “dangerous voltage” within the product’s enclosure that may be of sufficient magnitude to constitute a risk of electric shock to persons.



The exclamation point within an equilateral triangle is intended to alert you to the presence of important operating and maintenance (servicing) instructions in the literature accompanying the appliance.

IMPORTANT

Please record the serial number of this unit in the space below.

MODEL:

Serial No.:

The serial number is located on the rear of the unit. Retain this Owner’s Manual in a safe place for future reference.

- 1 Read these instructions.
- 2 Keep these instructions.
- 3 Heed all warnings.
- 4 Follow all instructions.
- 5 Do not use this apparatus near water.
- 6 Clean only with dry cloth.
- 7 Do not block any ventilation openings. Install in accordance with the manufacturer’s instructions.
- 8 Do not install near any heat sources such as radiators, heat registers, stoves, or other apparatus (including amplifiers) that produce heat.
- 9 Do not defeat the safety purpose of the polarized or grounding-type plug. A polarized plug has two blades with one wider than the other. A grounding type plug has two blades and a third grounding prong. The wide blade or the third prong are provided for your safety. If the provided plug does not fit into your outlet, consult an electrician for replacement of the obsolete outlet.
- 10 Protect the power cord from being walked on or pinched particularly at plugs, convenience receptacles, and the point where they exit from the apparatus.
- 11 Only use attachments/accessories specified by the manufacturer.
- 12 Use only with the cart, stand, tripod, bracket, or table specified by the manufacturer, or sold with the apparatus. When a cart is used, use caution when moving the cart/apparatus combination to avoid injury from tip-over. 
- 13 Unplug this apparatus during lightning storms or when unused for long periods of time.
- 14 Refer all servicing to qualified service personnel. Servicing is required when the apparatus has been damaged in any way, such as power-supply cord or plug is damaged, liquid has been spilled or objects have fallen into the apparatus, the apparatus has been exposed to rain or moisture, does not operate normally, or has been dropped.

We Want You Listening For A Lifetime



Yamaha and the Electronic Industries Association’s Consumer Electronics Group want you to get the most out of your equipment by playing it at a safe level. One that lets the sound come through loud and clear without annoying blaring or distortion – and, most importantly, without affecting your sensitive hearing. Since hearing damage from loud sounds is often undetectable until it is too late, Yamaha and the Electronic Industries Association’s Consumer Electronics Group recommend you to avoid prolonged exposure from excessive volume levels.

IMPORTANT SAFETY INSTRUCTIONS**En****FCC INFORMATION (for US customers)****1 IMPORTANT NOTICE: DO NOT MODIFY THIS UNIT!**

This product, when installed as indicated in the instructions contained in this manual, meets FCC requirements. Modifications not expressly approved by Yamaha may void your authority, granted by the FCC, to use the product.

2 IMPORTANT: When connecting this product to accessories and/or another product use only high quality shielded cables. Cable/s supplied with this product **MUST** be used. Follow all installation instructions. Failure to follow instructions could void your FCC authorization to use this product in the USA.**3 NOTE:** This product has been tested and found to comply with the requirements listed in FCC Regulations, Part 15 for Class "B" digital devices. Compliance with these requirements provides a reasonable level of assurance that your use of this product in a residential environment will not result in harmful interference with other electronic devices. This equipment generates/uses radio frequencies and, if not installed and used according to the instructions found in the users manual, may cause interference harmful to the operation of other electronic devices.

Compliance with FCC regulations does not guarantee that interference will not occur in all installations. If this product is found to be the source of interference, which can be determined by turning the unit "OFF" and "ON", please try to eliminate the problem by using one of the following measures:

Relocate either this product or the device that is being affected by the interference.

Utilize power outlets that are on different branch (circuit breaker or fuse) circuits or install AC line filter/s.

In the case of radio or TV interference, relocate/reorient the antenna. If the antenna lead-in is 300 ohm ribbon lead, change the lead-in to coaxial type cable.

If these corrective measures do not produce satisfactory results, please contact the local retailer authorized to distribute this type of product. If you can not locate the appropriate retailer, please contact Yamaha Corporation of America A/V Division, 6600 Orangethorpe Avenue, Buena Park, CA 90620, USA.

The above statements apply **ONLY** to those products distributed by Yamaha Corporation of America or its subsidiaries.

FCC CAUTION

Change or modifications not expressly approved by the party responsible for compliance could void the user's authority to operate the equipment.

FOR CANADIAN CUSTOMERS

To prevent electric shock, match wide blade of plug to wide slot and fully insert.
CAN ICES-3 (B)/NMB-3(B)

- This device complies with Part 15 of the FCC Rules and RSSGen of IC Rules.
 - Operation is subject to the following two conditions: 1) this device may not cause harmful interference, and 2) this device must accept any interference received including interference that may cause undesired operation of this device.
- See the "TROUBLESHOOTING" section at the end of this manual if interference to radio reception is suspected.

NOTICE

This equipment has been tested and found to comply with the limits for a Class B digital device, pursuant to part 15 of the FCC Rules. These limits are designed to provide reasonable protection against harmful interference in a residential installation.



This equipment generates, uses and can radiate radio frequency energy and, if not installed and used in accordance with the instructions, may cause harmful interference to radio communications. However, there is no guarantee that interference will not occur in a particular installation. If this equipment does cause harmful interference to radio or television reception, which can be determined by turning the equipment off and on, the user is encouraged to try to correct the interference by one or more of the following measures:

- Reorient or relocate the receiving antenna.
- Increase the separation between the equipment and receiver.
- Connect the equipment into an outlet on a circuit different from that to which the receiver is connected.
- Consult the dealer or an experienced radio/TV technician for help.

This equipment complies with FCC/IC radiation exposure limits set forth for uncontrolled equipment and meets the FCC radio frequency (RF) Exposure Guidelines in Supplement C to OET65 and RSS-102 of the IC radio frequency (RF) Exposure rules. This equipment has very low levels of RF energy that it deemed to comply without maximum permissive exposure evaluation (MPE). But it is desirable that it should be installed and operated with at least 20 cm and more between the radiator and person's body (excluding extremities: hands, wrists, feet and ankles).

This transmitter must not be co-located or operated in conjunction with any other antenna or transmitter.

PRÉCAUTIONS CONCERNANT LA SÉCURITÉ

	<p>CAUTION</p> <hr/> <p>RISK OF ELECTRIC SHOCK DO NOT OPEN</p>	
<p>ATTENTION : POUR RÉDUIRE LES RISQUES D'INCENDIE ET DE DÉCHARGE ÉLECTRIQUE, NE PAS RETIRER LE COUVERCLE (OU LE PANNEAU ARRIÈRE). AUCUNE PIÈCE INTERNE NE PEUT ÊTRE CHANGÉE PAR L'UTILISATEUR. POUR L'ENTRETIEN, S'ADRESSER À UN PERSONNEL QUALIFIÉ.</p>		

• Explication des symboles



L'éclair avec une flèche à l'intérieur d'un triangle équilatéral est destiné à attirer l'attention de l'utilisateur sur la présence d'une « tension dangereuse » non isolée à l'intérieur du produit, pouvant être suffisamment élevée pour constituer un risque d'électrocution.



Le point d'exclamation à l'intérieur d'un triangle équilatéral est destiné à attirer l'attention de l'utilisateur sur la présence d'instructions importantes sur l'emploi ou de la maintenance (réparation) de l'appareil dans la documentation fournie.

IMPORTANT

Veuillez enregistrer le numéro de série de cet appareil dans l'espace réservé à cet effet, ci-dessous.

MODÈLE :

No. de série :

Le numéro de série se trouve à l'arrière de l'appareil. Prière de conserver le mode d'emploi en lieu sûr pour toute référence future.

- 1 Lire ces instructions.
- 2 Conserver ces instructions.
- 3 Tenir compte de tous les avertissements.
- 4 Suivre toutes les instructions.
- 5 Ne pas utiliser cet appareil à proximité de l'eau.
- 6 Nettoyer cet appareil avec un chiffon sec seulement.
- 7 Ne pas recouvrir les ailettes de ventilation. Installer l'appareil selon les instructions du fabricant.
- 8 Ne pas installer près d'une source de chaleur, comme un appareil de chauffage, une résistance électrique, un poêle, ou tout autre appareil (amplificateurs compris) produisant de la chaleur.
- 9 Ne pas désamorcer le système de sécurité d'une fiche polarisée ou d'une fiche avec mise à la terre. Une fiche polarisée est munie de deux lames, dont l'une est plus large que l'autre. Une fiche avec mise à la terre est munie de deux lames et d'une broche de terre. La lame la plus large ou la troisième broche sont reliées à la terre pour des raisons de sécurité. Si la fiche fournie ne s'insère pas dans la prise, s'adresser à un électricien pour faire remplacer la prise obsolète.
- 10 Protéger le cordon d'alimentation de sorte qu'il ne risque pas d'être piétiné ou coincé, surtout au niveau des fiches, des prises et de sa sortie de l'appareil.
- 11 Utiliser seulement les fixations et accessoires spécifiés par le fabricant.
- 12 Utiliser seulement le chariot, socle, trépied, support ou meuble spécifié par le fabricant ou vendu avec l'appareil. Si un chariot est utilisé, faire attention de ne pas se blesser ou de le renverser pendant le transport de l'appareil. 
- 13 Débrancher cet appareil pendant les orages électriques, ou s'il ne doit pas être utilisé pendant un certain temps.
- 14 Pour toute inspection s'adresser à un personnel qualifié. Une inspection est nécessaire en cas de dommage, quel qu'il soit, par exemple cordon d'alimentation ou fiche endommagé, liquide répandu ou objet tombé à l'intérieur de l'appareil, exposition de l'appareil à la pluie ou à l'humidité, fonctionnement anormal ou chute de l'appareil.

Nous vous souhaitons un plaisir musical durable



Yamaha et le Groupe des Entreprises Électroniques Grand Public de l'Association des Industries Électroniques vous demandent de tirer le meilleur parti de votre équipement tout en écoutant à un niveau non dommageable pour l'ouïe, c'est-à-dire un niveau où vous pouvez obtenir un son fort et clair, sans hurlement ni distorsion, mais sans aucun danger pour l'ouïe. Comme les sons trop forts causent des lésions auditives qui ne peuvent être détectées qu'à long terme, lorsqu'il est trop tard, Yamaha et le Groupe des Entreprises Électroniques Grand Public de l'Association des Industries Électroniques vous conseillent l'écoute prolongée à des volumes excessifs.

PRÉCAUTIONS CONCERNANT LA SÉCURITÉ**Informations de la FCC (Pour les clients résidents aux États-Unis)****1 AVIS IMPORTANT : NE PAS APPORTER DE MODIFICATIONS À CET APPAREIL !**

Ce produit est conforme aux exigences de la FCC s'il est installé selon les instructions du mode d'emploi. Toute modification non approuvée expressément par Yamaha peut invalider l'autorisation, accordée par la FCC, d'utiliser ce produit.

2 IMPORTANT : N'utiliser que des câbles blindés de haute qualité pour le raccordement de ce produit à des accessoires et/ou à un autre produit. Seuls le ou les câbles fournis avec le produit DOIVENT être utilisés. Suivre les instructions concernant l'installation. Le non respect des instructions peut invalider l'autorisation, accordée par la FCC, d'utiliser ce produit aux États-Unis.

3 REMARQUE : Ce produit a été testé et déclaré conforme aux normes relatives aux appareils numériques de Classe "B", telles que fixées dans l'Article 15 de la Réglementation FCC. Ces normes sont destinées à assurer une protection suffisante contre les interférences nuisibles avec d'autres appareils électroniques dans une installation résidentielle. Cet équipement génère et utilise des fréquences radio qui, en cas d'installation et d'utilisation non conformes aux instructions du mode d'emploi, peuvent être à l'origine d'interférences empêchant d'autres appareils de fonctionner.

Cependant, la conformité à la Réglementation FCC ne garantit pas l'absence d'interférences dans une installation particulière. Si ce produit devait produire des interférences, ce qui peut être déterminé en "ÉTEIGNANT" et en "RALLUMANT" le produit, l'utilisateur est invité à essayer de corriger le problème d'une des manières suivantes :

Réorienter ce produit ou le dispositif affecté par les interférences.

Utiliser des prises d'alimentation branchées sur différents circuits (avec interrupteur de circuit ou fusible) ou installer un ou des filtres pour ligne secteur.

Dans le cas d'interférences radio ou TV, changer de place l'antenne et la réorienter. Si l'antenne est un conducteur plat de 300 ohms, remplacer ce câble par un câble de type coaxial.

Si ces mesures ne donnent pas les résultats escomptés, prière de contacter le détaillant local autorisé à commercialiser ce type de produit. Si ce n'est pas possible, veuillez contacter Yamaha Corporation of America A/V Division, 6600 Orangethorpe Avenue, Buena Park, CA 90620, États-Unis.

Les déclarations précédentes NE concernent QUE les produits commercialisés par Yamaha Corporation of America ou ses filiales.

PRÉCAUTION FCC

Tout changement ou toute modification non approuvée expressément par le tiers responsable peut aboutir à l'interdiction de faire fonctionner cet appareil.

POUR LES CONSOMMATEURS CANADIENS

Pour prévenir tout choc électrique, faites correspondre la broche large de la fiche à la fente large et insérez complètement.
CAN ICES-3 (B)/NMB-3(B)

- Cet appareil est conforme à la Partie 15 du Règlement FCC et au RSS-Gen du Règlement IC.
 - Le fonctionnement de cet appareil est soumis aux deux conditions suivantes : 1) cet appareil ne doit pas provoquer d'interférences nuisibles, et 2) cet appareil doit accepter les interférences reçues, notamment celles pouvant entraîner un dysfonctionnement.
- Reportez-vous à la section « GUIDE DE DÉPANNAGE » à la fin de ce manuel si vous soupçonnez que la réception radio subit des interférences.

REMARQUE

Cet appareil a été testé et il s'est avéré être conforme aux limites déterminées pour un appareil numérique de Classe B, conformément à la partie 15 du Règlement FCC. Ces limites sont destinées à offrir une protection raisonnable contre les interférences nuisibles pouvant survenir en cas d'utilisation de ce produit dans un environnement domestique. Cet appareil produit, utilise et peut émettre de l'énergie radioélectrique et, s'il n'est pas installé conformément aux instructions, peut provoquer des interférences radio. Il n'est toutefois pas garanti qu'aucune interférence ne se produira dans le cas d'une installation donnée. Si l'appareil provoque des interférences nuisibles à la réception de programmes radio ou de télévision, ce qui peut être déterminé en éteignant, puis en allumant l'appareil, l'utilisateur est prié de tenter de corriger le problème en prenant l'une ou plusieurs des mesures suivantes :

- Réorienter ou déplacer l'antenne réceptrice.
- Éloigner davantage l'appareil du récepteur.
- Raccorder l'appareil à une prise d'un circuit différent de celui du récepteur.
- Consulter le revendeur ou un technicien radio/télé expérimenté.

Cet appareil est conforme aux limites FCC/IC d'exposition aux rayonnements définies pour les appareils non commandés et satisfait aux directives d'exposition aux fréquences radio (RF) FCC de l'Annexe C des règlements OET65 et RSS-102 d'exposition aux fréquences radio (RF) IC. Cet appareil possède des niveaux d'énergie RF très bas, considérés conformes aux taux d'exposition maximum autorisés (MPE) non contrôlés. Mais il est toutefois préférable d'installer et d'utiliser l'appareil en conservant une distance minimum de 20 cm entre l'émetteur et toute personne (sauf les extrémités : mains, poignets, pieds et chevilles). Ce émetteur ne peut pas être placé à proximité de ou utilisé conjointement avec tout autre émetteur ou antenne.

ATTENTION : VEUILLEZ LIRE CE QUI SUIT AVANT D'UTILISER L'APPAREIL.

- 1 Pour utiliser l'appareil au mieux de ses possibilités, lisez attentivement ce mode d'emploi. Conservez-le soigneusement pour référence.
- 2 Installez cet appareil dans un endroit frais, bien aéré, sec et propre - à l'abri de la lumière du soleil, des sources de chaleur, des vibrations, des poussières, de l'humidité et du froid. Pour une aération correcte, tenez compte des distances minimales suivantes.
Au-dessus : 15 cm
À l'arrière : 10 cm
Sur les côtés : 10 cm
- 3 Placez l'appareil loin des équipements, moteurs et transformateurs électriques, pour éviter les ronflements parasites.
- 4 N'exposez pas l'appareil à des variations brutales de température, ne le placez pas dans un environnement très humide (par exemple dans une pièce contenant un humidificateur) car cela peut entraîner la condensation d'humidité à l'intérieur de l'appareil qui elle-même peut être responsable de décharge électrique, d'incendie, de dommage à l'appareil ou de blessure corporelle.
- 5 Évitez d'installer l'appareil dans un endroit où des objets peuvent tomber, ainsi que là où l'appareil pourrait être exposé à des éclaboussures ou des gouttes d'eau. Sur le dessus de l'appareil, ne placez pas :
 - d'autres appareils qui peuvent endommager la surface de l'appareil ou provoquer sa décoloration.
 - des objets se consumant (par exemple, une bougie) qui peuvent être responsables d'incendie, de dommage à l'appareil ou de blessure corporelle.
 - des récipients contenant des liquides qui peuvent être à l'origine de décharge électrique ou de dommage à l'appareil.
- 6 Ne couvrez pas l'appareil d'un journal, d'une nappe, d'un rideau, etc. car cela empêcherait l'évacuation de la chaleur. Toute augmentation de la température intérieure de l'appareil peut être responsable d'incendie, de dommage à l'appareil ou de blessure corporelle.
- 7 Ne branchez pas la fiche du câble d'alimentation de l'appareil sur une prise secteur aussi longtemps que tous les raccordements n'ont pas été effectués.
- 8 Ne pas faire fonctionner l'appareil à l'envers. Il risquerait de chauffer et d'être endommagé.
- 9 N'exercez aucune force excessive sur les commutateurs, les boutons et les cordons.
- 10 Pour débrancher la fiche du câble d'alimentation au niveau de la prise secteur, saisissez la fiche et ne tirez pas sur le cordon.
- 11 Ne nettoyez pas l'appareil au moyen d'un solvant chimique, ce qui pourrait endommager la finition. Utilisez un chiffon sec et propre.
- 12 N'alimentez l'appareil qu'à partir de la tension prescrite. Alimenter l'appareil sous une tension plus élevée est dangereux et peut être responsable d'incendie, de dommage à l'appareil ou de blessure corporelle. Yamaha ne saurait être tenue responsable des dommages résultant de l'alimentation de l'appareil sous une tension autre que celle prescrite.
- 13 Pour empêcher tout dommage causé par les éclairs, déconnectez la câble d'alimentation et toute antenne extérieure de la prise murale pendant un orage.
- 14 Ne tentez pas de modifier ni de réparer l'appareil. Consultez le service Yamaha compétent pour toute réparation qui serait requise. Le coffret de l'appareil ne doit jamais être ouvert, quelle que soit la raison.
- 15 Si vous envisagez de ne pas vous servir de l'appareil pendant une longue période (par exemple, pendant les vacances), débranchez la fiche du câble d'alimentation au niveau de la prise secteur.
- 16 Lisez la section intitulée « GUIDE DE DÉPANNAGE » où figurent une liste d'erreurs de manipulation communes avant de conclure que l'appareil présente une anomalie de fonctionnement.
- 17 Avant de déplacer l'appareil, appuyez sur  pour éteindre le système puis débranchez la fiche du câble d'alimentation au niveau de la prise secteur.
- 18 La condensation se forme lorsque la température ambiante change brusquement. En ce cas, débranchez la fiche du câble d'alimentation et laissez l'appareil reposer.
- 19 La température de l'appareil peut augmenter en raison d'une utilisation prolongée. En ce cas, coupez l'alimentation de l'appareil et laissez-le au repos pour qu'il refroidisse.
- 20 Installez cet appareil à proximité de la prise secteur et à un emplacement où la fiche du câble d'alimentation est facilement accessible.
- 21 Utilisez l'adaptateur secteur fourni avec cet appareil. L'emploi de tout autre adaptateur secteur peut causer un incendie ou endommager l'appareil.

Cet appareil n'est pas déconnecté du secteur tant qu'il reste branché à la prise de courant, même si l'appareil en soi est éteint par la touche . Dans cet état, l'appareil consomme une très faible quantité de courant.

AVERTISSEMENT
POUR RÉDUIRE LES RISQUES D'INCENDIE OU DE DÉCHARGE ÉLECTRIQUE, N'EXPOSEZ PAS CET APPAREIL À LA PLUIE OU À L'HUMIDITÉ.

Il y a un risque possible de création d'interférences, visibles sur les images en couleurs si cet appareil est placé à côté d'un téléviseur à tube cathodique (tube de Braun). Dans ce cas, éloigner l'unité du téléviseur.

Ne pas utiliser cet appareil à moins de 22 cm de personnes ayant un stimulateur cardiaque ou un défibrillateur.

Les ondes radio peuvent avoir une incidence sur les équipements électroniques médicaux.
N'utilisez pas cet appareil à proximité d'équipements médicaux ou à l'intérieur d'institutions médicales.

CONTENTS

NAMES OF PARTS AND THEIR FUNCTIONS	2
BASIC FUNCTIONS	4
LISTENING TO FM STATIONS	6
CHARGING WITH THE USB PORT	7
LISTENING TO EXTERNAL SOURCES	7
LISTENING TO MUSIC FROM YOUR <i>Bluetooth</i> COMPONENT	8
TROUBLESHOOTING	11
SPECIFICATIONS	13

■ Features

- Playback of *Bluetooth* devices, FM radio, and external devices with AUX connector.
 - Setting alarm using FM radio.
 - Supplying power to smartphones, tablets, etc. via USB port on the rear panel.
 - Rich sound by 5cm full-range custom speaker and DSP (Digital Signal Processor) made by Yamaha.
 - Enhanced treble and thick mid/bass, even when playing compressed audio source, such as MP3, etc. (Music Enhancer)
- **Note** indicates precautions for use of the unit and its feature limitations.
 -  indicates supplementary explanations for better use.

■ Supplied accessories

AC adaptor



FM antenna

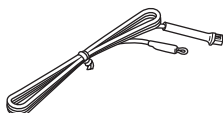

(DC 12 V, 1.5 A,
model number:
MU18-D120150-A1)



NAMES OF PARTS AND THEIR FUNCTIONS

■ Top panel



Press to turn the system on/off. Time is displayed even when the system is off.

Standby mode

- Press and hold  for more than 3 seconds to set the system to standby mode. All the indicators and display turn off, and *Bluetooth* operation, audio playback, input via buttons except  are disabled. This can reduce power consumption. To cancel standby mode, press .
- Even in system off/standby mode, the alarm function is available.

Auto-power off (☞ P. 5)

- If this unit is not operated for a certain period of time, the system will turn off automatically.

② Display



③ Indicators

: *Bluetooth* indicator. It lights during *Bluetooth* pairing and connection (☞ P. 8, 10).

AUX: AUX indicator. It lights when the **INPUT** connector is selected as an AUX input source (☞ P. 7).

RADIO: Radio indicator. It lights when the radio is selected as an input source (☞ P. 6).

((●)): Alarm indicator. It lights when the alarm function is on (☞ P. 4).

④ VOLUME

Controls volume. When you control the volume, the volume level will be displayed on the display.

⑤ CLOCK

Sets the clock (☞ P. 4).

Dimmer function

- Press **CLOCK** repeatedly to set the brightness of the display.
3 (brightest) → 2 → 1 (darkest)

⑥ ALARM

Sets the alarm (☞ P. 4).

⑦ TUNING

Adjust the time or radio frequency (☞ P. 4, 6).

⑧ PRESET

Stores up to five favorite FM radio stations (☞ P. 6).

⑨ SOURCE (PAIRING)

Selects an input source from *Bluetooth* () , **AUX**, or **RADIO**.

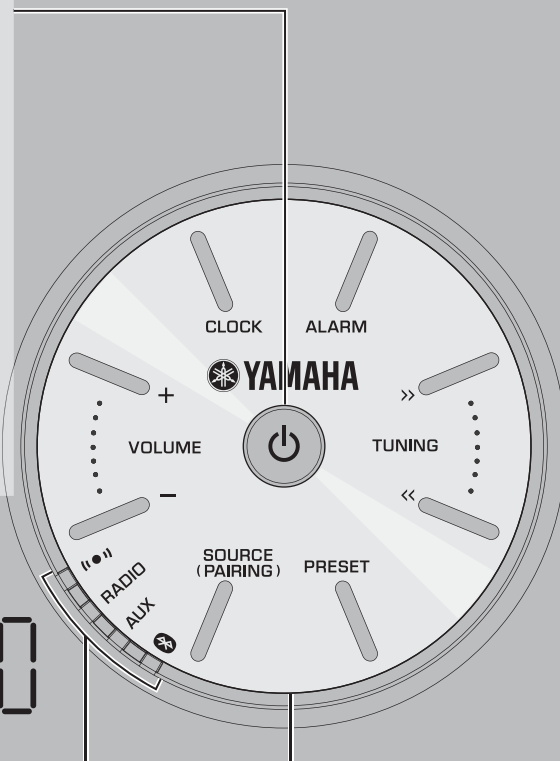

■ Rear panel

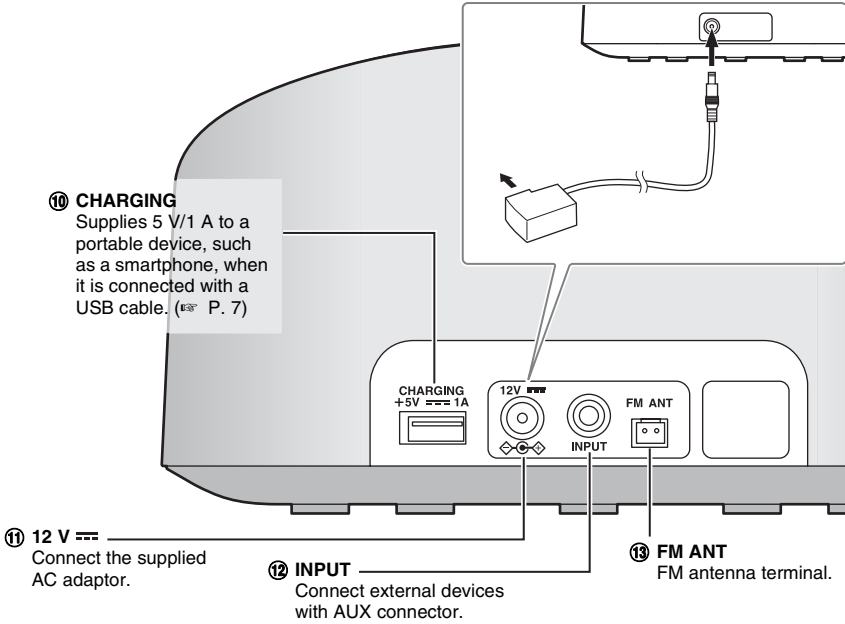

Connecting the FM antenna

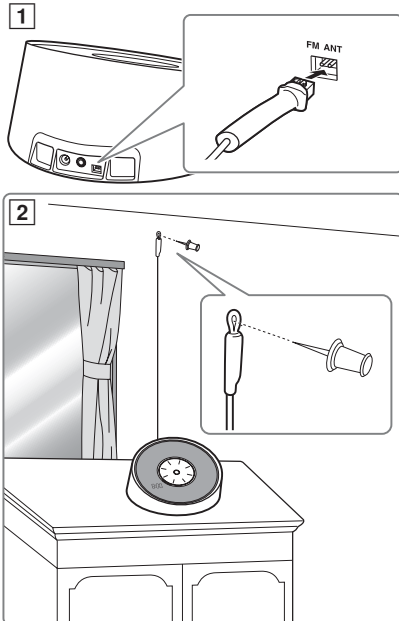

Caution

If you listen to an FM radio station while USB charging, noise may interfere with the radio reception. In this case, disconnect the USB cable from the unit.

- 1** Connect the supplied antenna to the unit.
- 2** Install it with a pin where the unit can obtain good reception.

Notes

- Be sure to stretch out the antenna as the illustration shows.
- If radio reception with the supplied antenna is not satisfactory, a commercially available outdoor antenna may improve reception.

BASIC FUNCTIONS

Adjusting the clock

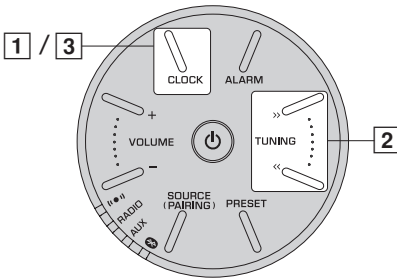

- 1 Press and hold **CLOCK**.
The display flashes.



- 2 Adjust the time with **TUNING**.

- 3 Press **CLOCK**.

If you want to cancel alarm setting mode, press .



If you press **PRESET** in step 2, you can select the time display format (12 hours/24 hours).

Note

The time settings are lost approximately one week after unplugging the unit.

Alarm setting

This unit can play back radio and beep sound at the set time.

■ Setting the time and sound

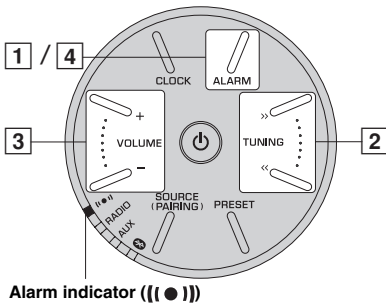

- 1 Press and hold **ALARM** for more than 2 seconds.

The alarm indicator ((●)) and display flash.



- 2 Set the alarm time with **TUNING**.

An alarm will sound only once at the specified time.

Radio will sound from 3 minutes before the alarm time, and then beep will sound at the alarm time.

- 3 Set the alarm volume with **VOLUME**.

The volume level is displayed and the alarm indicator ((●)) lights.



- 4 Press and hold **ALARM** for more than 2 seconds.

Alarm is set and the alarm indicator ((●)) lights.

■ Switching the alarm on/off

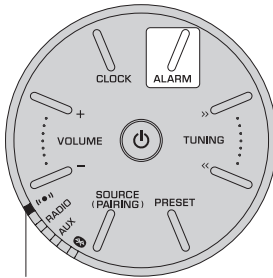

Alarm indicator ((●))

Press **ALARM**.

When the alarm is on, the alarm indicator ((●)) lights and alarm time is displayed for a while.

Operations during playing back alarm sound

At the set time, alarm sound plays back. During playback, operations below are available.

■ Stopping the alarm

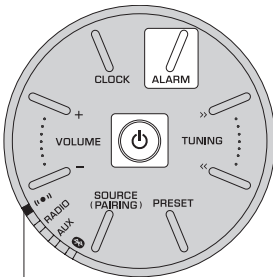

Alarm indicator ((●))

Press **ALARM** or **⏻**.



- Unless you stop the alarm, the alarm stops after 60 minutes automatically.
- When you stop the alarm, the alarm time setting, etc., is saved for convenient use next time.
- Press any buttons except **ALARM** and **⏻** once to stop the beep sound, and twice to stop the radio source (snooze function). 4 minutes after the radio source is stopped, it will start fading in again and after another minutes the beep sound will resume (double snooze function).
- When the snooze function is activated, the alarm indicator ((●)) and **⏻** flash.

Auto-power off

The system automatically turns off under the following circumstance. When the system is off, all the indicators turn off, and *Bluetooth* operation, audio playback, input via button operations except **⏻** are disabled.

- No components are connected via *Bluetooth* connection, **INPUT** connector, or radio source, or no sound is played back for more than 20 minutes.
- No operation is performed for more than 8 hours while music is being played back.

LISTENING TO FM STATIONS

Tuning radio stations

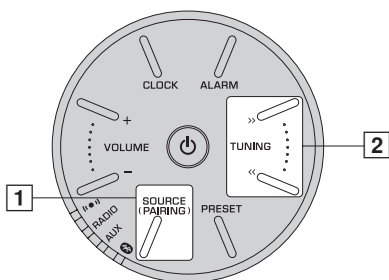

- 1 Press **SOURCE** to select **RADIO**.
The **RADIO** indicator lights.
- 2 For automatic tuning, press and hold **TUNING**.
For manual tuning, press **TUNING** repeatedly.

Note

If you tune to a station manually, the sound is monaural.

Presetting radio stations

You can store up to five favorite FM radio stations with the preset function.

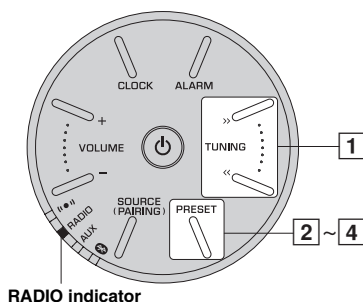

- 1 Press **TUNING** to select a favorite radio station.
The radio frequency is displayed temporarily.

102.80
MHz

- 2 Press and hold **PRESET** for 2 seconds.
The preset number is displayed on the display and flashes.

P 1

- 3 Press **PRESET** to select the preset number you want to store to.
- 4 Press and hold **PRESET** for 2 seconds to complete.

Selecting preset radio stations

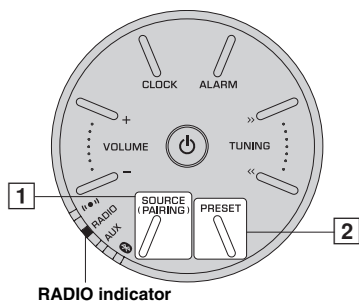

- 1 Press **SOURCE** to select **RADIO**.
The **RADIO** indicator lights.
- 2 Press **PRESET** repeatedly to select the preset radio station.

CHARGING WITH THE USB PORT

Connecting a portable device such as a smartphone or tablet computer to the USB port on this unit charges the connected device (power supply of up to 5V/1A is supported).

Prepare a USB cable that is compatible with the portable device and confirm that the device is supported for charging via USB connection before use. In addition, read the documentation provided with the portable device.

USB cable from portable device

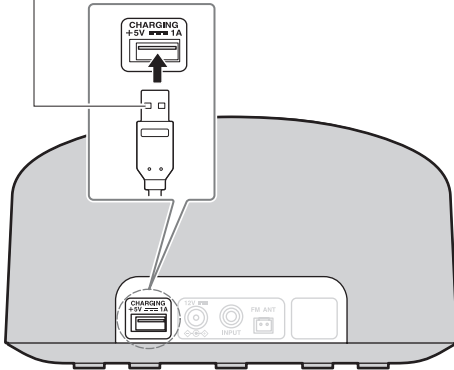

Rear panel

- 1 Connect your portable device to the USB port on this unit using a commercially available USB cable.
Charging automatically starts.
- 2 Disconnect the USB cable from the unit when charging completes.
Check the charging status on the portable device.

Notes

- The USB port is for charging use only. The USB port does not support audio playback.
- Charging may not be possible depending on the portable device.
- In standby mode, power supply stops, and charging is not available.
- This unit does not function as memory storage.
- Yamaha will not be held responsible for any damage to the portable device or data loss occurred while using this unit.
- Disconnect the USB cable immediately after charging completes, since power continues to be supplied to the connected device.

LISTENING TO EXTERNAL SOURCES

Rear panel

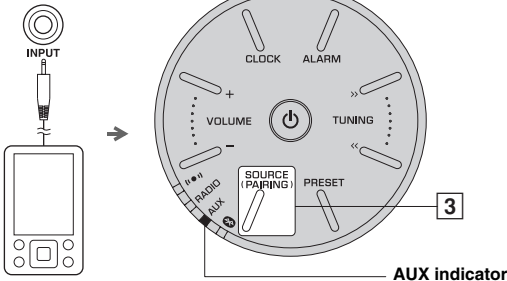

- 1 Connect your portable audio device to the **INPUT** connector using a commercially available 3.5 mm (1/8 in) mini plug cable.

Note

Turn down the volume of this unit and your portable audio device before connection.

- 2 Turn on the system.
- 3 Press **SOURCE** to set the playback source to **AUX**.
The **AUX** indicator lights.
- 4 Start playback on the connected portable audio device.

LISTENING TO MUSIC FROM YOUR *Bluetooth* COMPONENT

This unit provides *Bluetooth* functionality. You can enjoy wireless music playback from your *Bluetooth* component (smartphone, digital audio player, etc.). Please also refer to the owner's manual of your *Bluetooth* component.

Installation

Install in a stable place, being careful of the following points:

- Do not place on top of steel or other metal plates.
- Do not cover with a cloth, etc.
- Install in the same room as the device with which signals are to be exchanged (*Bluetooth* profile A2DP compatible smartphone, digital audio player, etc.) within a direct, line-of-sight distance of 10 m (33 ft).
- Make sure there are no obstacles between this unit and the *Bluetooth* component.

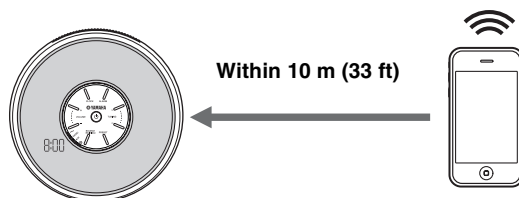

Pairing this unit with your Bluetooth component

Pairing is an operation that registers the communicating component (subsequently called “the other component”) with this unit. You will need to perform the pairing operation the first time you use your *Bluetooth* component with this unit, or if the pairing settings have been deleted. Once pairing has been completed, subsequent reconnection will be easy even after the *Bluetooth* connection is disconnected. If pairing is not successful, refer to the item “*Bluetooth*” in “TROUBLESHOOTING” (P. 12).



- This unit can be paired with up to four other components. When pairing with the fifth component has succeeded, pairing data for the component with the oldest connection date will be deleted.
- If this unit is connected via *Bluetooth* to another component, press and hold **SOURCE** to disconnect the *Bluetooth* connection before you perform the pairing operation.

■ If using an iPhone/iPad/iPod touch

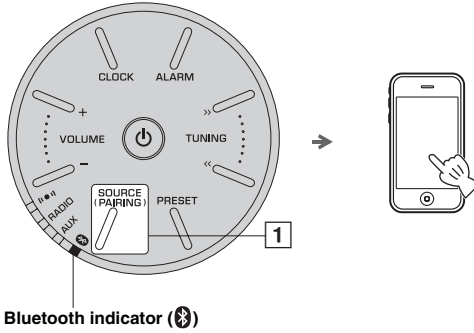

- 1 Press and hold **SOURCE** for more than 2 seconds to enter pairing mode.
 - Pairing mode lasts for 5 minutes.
 - In pairing mode, the *Bluetooth* indicator (B) will light in orange and blue alternately.
- 2 On your iPhone/iPad/iPod touch, turn [Settings] → [*Bluetooth*] on. The *Bluetooth* connection list will appear in [Devices]. (This procedure or display may differ depending on the type of your iPhone/iPad/iPod touch.)
- 3 From the *Bluetooth* connection list of the other component, choose this unit (TSX-B15 Yamaha). When pairing has been completed, your iPhone/iPad/iPod touch will indicate “Connected”. The *Bluetooth* indicator (B) will light in blue.

■ If using other than an iPhone/iPad/iPod touch

- 1 Press and hold **SOURCE** for more than 2 seconds to enter pairing mode.
 - Pairing mode lasts for 5 minutes.
 - In pairing mode, the *Bluetooth* indicator (B) will light in orange and blue alternately.
- 2 Perform *Bluetooth* pairing on the other component. For details, refer to the owner’s manual of the other component.
- 3 From the *Bluetooth* connection list of the other component, choose this unit (TSX-B15 Yamaha). When pairing has been completed, the Bluetooth indicator (B) will light in blue.



If you are prompted for a passkey, enter the numerals “0000”.

Listening to a Bluetooth component

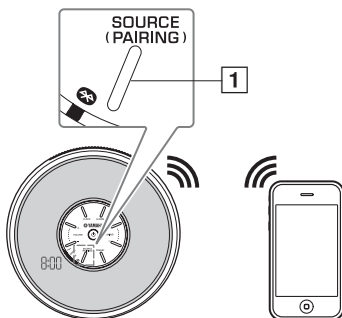

- 1 Press **SOURCE** to select  (*Bluetooth*).
- 2 Connect this unit and your other component via *Bluetooth*.
- 3 Play back music from your *Bluetooth* component.

Note

Take care that the volume setting of this unit is not too high. We recommend that you adjust the volume on the other component.





- While the system is turned off, if you connect a *Bluetooth* component to the unit, the system will automatically turn on.
- If you disconnect the *Bluetooth* connection from your other component while the playback source is set to *Bluetooth*, this unit will automatically turn off the system.

Connecting an already-paired component via Bluetooth

Once pairing with a component has been completed, connecting with that component via *Bluetooth* will be easy next time.

■ Connecting from this unit

Press **SOURCE** to select  (*Bluetooth*).

The *Bluetooth* indicator () will light in blue.

This unit will search for the other component that was most recently connected via *Bluetooth*, and will then establish a connection (You must first turn on the *Bluetooth* setting of the other component).

When the *Bluetooth* connection has been established, the *Bluetooth* indicator () will light in blue.

Note

Yamaha does not guarantee all connections between this unit and *Bluetooth* component.

■ Connecting from the other component

1 In the *Bluetooth* settings of the other component, turn *Bluetooth* on.

2 From the *Bluetooth* connection list of the other component, choose this unit (TSX-B15 Yamaha).

The *Bluetooth* connection will be established, and the *Bluetooth* indicator () will light in blue.

Note

Bluetooth connections cannot be established from the other component when this unit is in standby mode. Turn the system on.

Disconnecting a Bluetooth connection



If any of the following operations are performed while a *Bluetooth* connection is being used, the *Bluetooth* connection will be disconnected.

- Press and hold **SOURCE** for more than 2 seconds.
- Press **SOURCE** to select a playback source other than  (*Bluetooth*).
- Turn the system off.
- Disconnect the *Bluetooth* connection from the *Bluetooth* component.

TROUBLESHOOTING

Refer to the table below if the unit does not operate properly. If the problem you are experiencing is not listed below, or if the instruction below does not help, turn off the unit, disconnect the power cable, and contact the nearest authorized Yamaha dealer or service center.

General

Problem	Cause	Solution
The speakers make no sound.	The volume may be set to the minimum level.	Adjust the volume level.
	The source may be incorrect.	Select the correct source.
	The unit is setting the alarm.	Complete setting the alarm, or press  to cancel setting the alarm.
Sound suddenly turns off.	Auto-power off function is enabled after 8 hours passed with no operation.	Turn on the system and play the source again.
Sound is cracked/ distorted or there is abnormal noise.	Input source volume is excessive, or volume of this unit is excessive.	Adjust the volume with VOLUME .
The unit does not operate properly.	The unit may have received a strong electrical shock such as lightning or excessive static electricity, or power supply may have dropped.	Set the system to off, and disconnect the power cable. Wait about 30 seconds, reconnect the power cable, and turn on the system.
The system turns on but immediately shuts off.	The power cable may be connected improperly.	Make sure the power cable is plugged into the wall outlet firmly.
	The unit may have received a strong electrical shock such as lightning or excessive static electricity.	Set the system to off, and disconnect the power cable. Wait about 30 seconds, reconnect the power cable, and turn on the system.
A digital or high-frequency equipment produces noises.	The unit may be placed too close to the digital or high-frequency equipment.	Place the unit farther away from the equipment.
The clock setting has been cleared.	The unit is left more than one week after you disconnect the power cable from the wall outlet.	Plug the power cable into the wall outlet firmly, and set the clock again (Ⓜ P. 4).
Clock flashes and the unit cannot be operated.	The unit is setting CLOCK or ALARM .	Press  to cancel setting CLOCK or ALARM .

FM radio reception

Problem	Cause	Solution
Too much noise during stereo broadcast.	The radio station you selected may be far from your area, or the radio wave reception is weak in your area.	Try manual tuning to improve the signal quality (Ⓜ P. 6) or change the height or direction of the antenna, or relocate the unit (Ⓜ P. 2).

Bluetooth

Problem	Cause	Solution
Cannot make this unit paired with the other component.	The other component does not support A2DP.	Perform pairing operations with a component which supports A2DP.
	A <i>Bluetooth</i> adaptor, etc. that you want to pair with this unit has a password other than "0000".	Use a <i>Bluetooth</i> adaptor, etc. whose password is "0000".
	This unit and the other component are too far apart.	Move the other component closer to this unit.
	There is a device (microwave oven, wireless LAN, etc.) that outputs signals in the 2.4 GHz frequency band nearby.	Move this unit away from the device that is emitting radio-frequency signals.
Cannot establish a <i>Bluetooth</i> connection.	This unit is not registered on the other component's <i>Bluetooth</i> connection list.	Perform pairing operations again (☞ P. 8).
No sound is produced or the sound is interrupted during playback.	The <i>Bluetooth</i> connection of this unit with the other component is disconnected.	Perform <i>Bluetooth</i> connection operations again (☞ P. 10).
	This unit and the other component are too far apart.	Move the other component closer to this unit.
	There is a device (microwave oven, wireless LAN, etc.) that outputs signals in the 2.4 GHz frequency band nearby.	Move this unit away from the device that is emitting radio-frequency signals.
	The other component's <i>Bluetooth</i> function is off.	Turn on the <i>Bluetooth</i> function of the other component.
	The other component is not set to send <i>Bluetooth</i> audio signals to this unit.	Check that the <i>Bluetooth</i> function of the other component is set properly.
	The pairing setting of the other component is not set to this unit.	Set the pairing setting of the other component to this unit.
	The other component's volume is set to the minimum.	Increase the volume level.

USB port charging

Problem	Cause	Solution
Cannot charge the connected portable USB device.	An incompatible USB device is connected to the unit. Or the USB device is not connected to this unit properly.	Turn off the system and reconnect the USB device to the unit. If it does not resolve the problem, the USB device is not chargeable with the unit.

■ Resetting the unit

If the unit does not function properly, resetting the unit may solve the problem. To reset the unit, press and hold  for more than 10 seconds.

■ PLAYER SECTION

AUX IN

- Input connector
.....STEREO L/R: 3.5 mm (1/8 in) STEREO mini Jack

■ AMPLIFIER SECTION

- Driver unit5 cm (XX in) full-range driver × 2

■ *Bluetooth* SECTION

- *Bluetooth* version Ver. 2.1+EDR
- Supported protocols A2DP
- Supported codecs SBC
- Wireless output *Bluetooth* Class 2
- Maximum communication distance
..... 10 m (33 ft) (without obstructions)
- Supported contents protection SCMS-T method

■ TUNER SECTION

- Tuning range (FM) 87.5 to 108.0 MHz

■ CHARGING CONNECTOR SECTION

- Connector type USB type A
- Output rating 5 V/1 A

■ GENERAL

- Power Supply AC 100-240 V, 50/60 HZ
- Power consumption 11 W
- System off consumption 1.6 W
- Standby consumption 0.5 W or less
- Dimensions (W × H × D) 180 × 100 × 200 mm
(7 1/8 × 3 7/8 × 7 7/8 in)
- Weight 0.9 kg (2.0 lbs.)

Bluetooth

- *Bluetooth* is a technology for wireless communication between devices within an area of about 10 meters (33 ft) employing the 2.4 GHz frequency band, a band which can be used without a license.
- *Bluetooth* is a registered trademark of the *Bluetooth* SIG and is used by Yamaha in accordance with a license agreement.

Handling *Bluetooth* communications

- The 2.4 GHz band used by *Bluetooth* compatible devices is a radio band shared by many types of equipment. While *Bluetooth* compatible devices use a technology minimizing the influence of other components using the same radio band, such influence may reduce the speed or distance of communications and in some cases interrupt communications.
- The speed of signal transfer and the distance at which communication is possible differs according to the distance between the communicating devices, the presence of obstacles, radio wave conditions and the type of equipment.
- Yamaha does not guarantee all wireless connections between this unit and devices compatible with *Bluetooth* function.



© 2014 Yamaha Corporation

YAMAHA CORPORATION
Printed in China ZN35280