

Nemko Korea Co., Ltd.

155 & 159, Osan-Ro, Mohyeon-Eup, Cheoin-Gu, Yongin-Si, Gyeonggi-Do 16885 KOREA, REPUBLIC OF

TEL:+82 31 330-1700 FAX:+82 31 322 2332

FCC and IC EVALUATION REPORT FOR CERTIFICATION

Applicant :**YAMAHA CORPORATION****10-1, Nakazawa-Cho, NaKa-Ku, Hamamatsu
-Shi, Shizuoka-Ken, 430-8650, Japan****Attn. : Naohiro Emoto****Dates of Issue : July 28, 2022****Test Report No. : NK-21-R-025-2****Test Site : Nemko Korea Co., Ltd.****FCC ID****IC****Brand Name****Contact Person****A6RCS500****740B-CS500****YAMAHA CORPORATION****10-1, Nakazawa-Cho, Naka-Ku, Hamamatsu-Shi,
Shizuoka-Ken, 430-8650, Japan****Naohiro Emoto****Telephone No. : +81-53-460-2812**

Applied Standard: FCC 47 CFR Part 15.247
IC RSS-247 Issue 2 and IC RSS-GEN Issue 5
Classification: Digital Transmission System (DTS)
EUT Type: VIDEO CONFERENCE SYSTEM

The device bearing the brand name and model specified above has been shown to comply with the applicable technical standards as indicated in the measurement report and was tested in accordance with the measurement procedures specified in ANSI C63.10-2013. The client should not use it to claim product endorsement by TAF or any government agencies. The test results in the report only apply to the tested sample.

I attest to the accuracy of data and all measurements reported herein were performed by me or were made under my supervision and are correct to the best of my knowledge and belief. I assume full responsibility for the completeness of these measurements and vouch for the qualifications of all persons taking them.



Tested By : Yonghwan Kim
Test Engineer



Reviewed By : Hoonpyo Lee
Technical Manager

YAMAHA CORPORATION

Page 1 of 47

Revision History

Rev.	Issue Date	Revisions	Revised By
00	July 28, 2022	Initial issue	

TABLE OF CONTENTS

1. Scope	5
2. Introduction (Site Description)	6
2.1 Test facility	6
2.2 Accreditation and listing	7
3. Test Conditions & EUT Information	8
3.1 Operation During Test	8
3.1.1 Table of test power setting	8
3.1.2 Table of test channels	8
3.1.3 Antenna information	8
3.1.4 Additional Information Related to Testing	9
3.1.5 Table of test modes	9
3.2 Support Equipment	10
3.3 Setup Drawing	10
3.4 EUT Information	11
4. Summary of Test Results	12
5. Recommendation / Conclusion	13
6. Antenna Requirements	14
7. Description of Test	15
7.1 Conducted Emissions	15
7.2 Radiated Emissions	16
7.3 6 dB Bandwidth	17
7.4 Peak Output Power and E.I.R.P.	18
7.5 Peak Power Spectral Density	19
7.6 Conducted Spurious Emissions	20

8. Test Data	21
8.1 Conducted Emissions	21
8.2 Radiated Emissions	23
8.3 6 dB Bandwidth	25
8.4 Peak Output Power and E.I.R.P.	28
8.5 Peak Power Spectral Density	31
8.6 Conducted Spurious Emissions	34
8.7 Radiated Spurious Emissions	39
8.8 Radiated Band Edge	43
9. Test Equipment	45
10. Accuracy of Measurement	46

1. SCOPE

Measurement and determination of electromagnetic emissions (EME) of radio frequency devices including intentional and/or unintentional radiators for compliance with the technical rules and regulations of the Federal Communications Commission under FCC part 15 and IC RSS-247 Issue2.

Responsible Party :	YAMAHA CORPORATION 10-1, Nakazawa-Cho, Naka-Ku, Hamamatsu-Shi, Shizuoka-Ken, 430-8650, Japan
Contact Person :	Naohiro Emoto
Manufacturer :	YAMAHA CORPORATION 10-1, Nakazawa-Cho, Naka-Ku, Hamamatsu-Shi, Shizuoka-Ken, 430-8650, Japan

- FCC ID: A6RCS500
- IC: 740B-CS500
- Model: CS-500
- HVIN: CS-500
- Brand Name: 
- EUT Type: VIDEO CONFERENCE SYSTEM
- Classification: Digital Transmission System (DTS)
- Applied Standard: FCC 47 CFR Part 15.247
IC RSS-247 Issue 2 and IC RSS-GEN Issue 5
- Test Procedure(s): ANSI C63.10-2013
KDB 558074 D01 15.247 Meas Guidance v05r02
- Dates of Test: May 18, 2022 ~ July 18, 2022
- Place of Test: Nemko Korea Co., Ltd.

2. INTRODUCTION

2.1 Test facility

The measurement procedure described in American National Standard for Methods of Measurement of Radio-Noise Emissions from Low-Voltage Electrical and Electronic Equipment in the Range of 9 kHz to 40 GHz (ANSI C63.4-2014), the American National Standard for Testing Unlicensed Wireless Devices (ANSI C63.10-2013) was used in determining radiated and conducted emissions emanating from **YAMAHA CORPORATION FCC ID : A6RCS500 and IC : 740B-CS500.**

These measurement tests were conducted at **Nemko Korea Co., Ltd. EMC Laboratory .**

The site address 155 & 159, Osan-Ro, Mohyeon-Eup, Cheoin-Gu, Yongin-Si, Gyeonggi-Do 16885 KOREA, REPUBLIC OF.

The area of Nemko Korea Corporation Ltd. EMC Test Site is located in a mountain area at 80 km (48 miles) southeast and Incheon International Airport (Incheon Airport), 30 km (18miles) south-southeast from central Seoul.

It is located in the valley surrounded by mountains in all directions where ambient radio signal conditions are quiet and a favorable area to measure the radio frequency interference on open field test site for the computing and ISM devices manufactures.

The detailed description of the measurement facility was found to be in compliance with the requirements of ANSI C63.4-2014 according to §2.948.

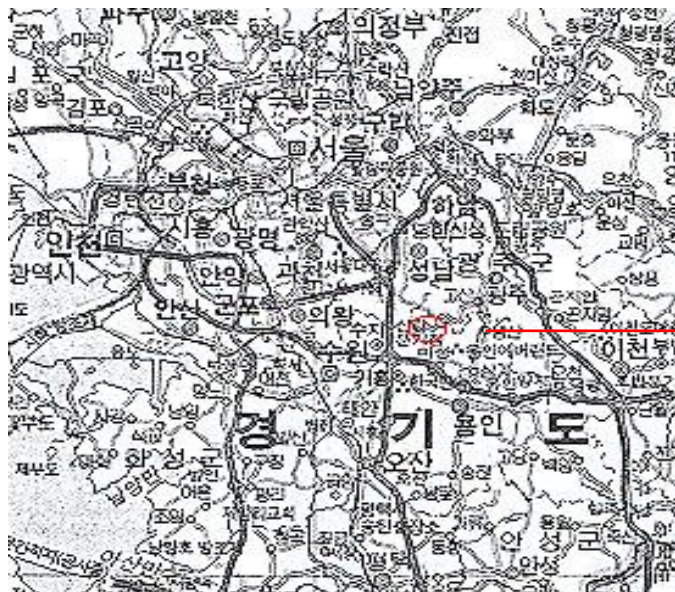







Nemko Korea Co., Ltd.
EMC Lab.
155 & 159, Osan-Ro, Mohyeon-Eup,
Cheoin-Gu, Yongin-Si, Gyeonggi-Do
16885 KOREA, REPUBLIC OF
Tel)+82-31-330-1700
Fax)+82-31-322-2332

Fig. 1. The map above shows the Seoul in Korea vicinity area.

The map also shows Nemko Korea Corporation Ltd. EMC Lab. and Incheon Airport.

2.2 Accreditation and listing

Accreditation type		Accreditation number
	CAB Accreditation for DOC	Designation No. KR0026
	KOLAS Accredited Lab. (Korea Laboratory Accreditation Scheme)	Registration No. KT155
	Canada IC Registered site	Site No. 2040E
	VCCI registration site(RE/CE/Telecom CE)	Member No. 2118
	EMC CBTL	TL124
	KCC(RRL)Designated Lab.	Registration No. KR0026

3. TEST CONDITIONS & EUT INFORMATION

3.1 Operation During Test

The EUT is the transceiver which is Bluetooth 5.0 supporting BDR/EDR/LE mode.

The Laptop was used to control the EUT to transmit the wanted TX channel continuously (duty cycle < 98%) by the testing program (QRCT) supported by manufacturer.

The operating voltage of EUT was 20 Vdc supplied from AC/DC adapter

The EUT was tested at the lowest, middle and the highest channels with the maximum output power in accordance with the manufacturer's specifications. The worst data were recorded in the report.

3.1.1 Table of test power setting

Frequency	Mode	Power setting Level
2 402 MHz ~ 2 480 MHz	LE	Default

3.1.2 Table of test frequency

Frequency band	Mode	Test Channel (CH)	Frequency (MHz)
2.4 GHz	LE	0	2 402
		20	2 442
		39	2 480

3.1.3 Antenna information

Frequency band	Mode	Antenna TX mode	Support CDD	Support MIMO
2.4 GHz	LE	<input checked="" type="checkbox"/> 1TX, <input type="checkbox"/> 2TX	<input type="checkbox"/> Yes, <input checked="" type="checkbox"/> No	<input type="checkbox"/> Yes, <input checked="" type="checkbox"/> No

3.1.4 Additional Information Related to Testing

The cable and attenuator loss from 30MHz to 26.5GHz was reflected in spectrum analyzer with correction factor for all conducted testing.

3.1.5 Table of test modes

2.4GHz - Part 15.247, RSS-247 Issue 2 and RSS-GEN Issue 5				
Test Items	Mode	Modulation	Test Channel (CH)	Remark
Conducted Emissions	LE	GFSK	0	-
Radiated Emissions	LE	GFSK	0	Radiated
6 dB Bandwidth	LE	GFSK	0/20/39	Conducted
Maximum Conducted Output Power	LE	GFSK	0/20/39	Conducted
Power Spectral Density	LE	GFSK	0/20/39	Conducted
Conducted Spurious Emission, Radiated Spurious Emission, Band edge Emission	LE	GFSK	0/20/39	Conducted, Radiated

3.2 Support Equipment

EUT	YAMAHA CORPORATION Model : CS-500	S/N: Z83000387
Laptop Computer	HP Model : G62-355TU	FCC DOC S/N : CNF0489WDT
AC/DC Adapter	HP Model : PPP009D 1.5 m unshielded power cable	FCC DOC S/N : WBGSV0ACXZH162

3.3 Setup Drawing

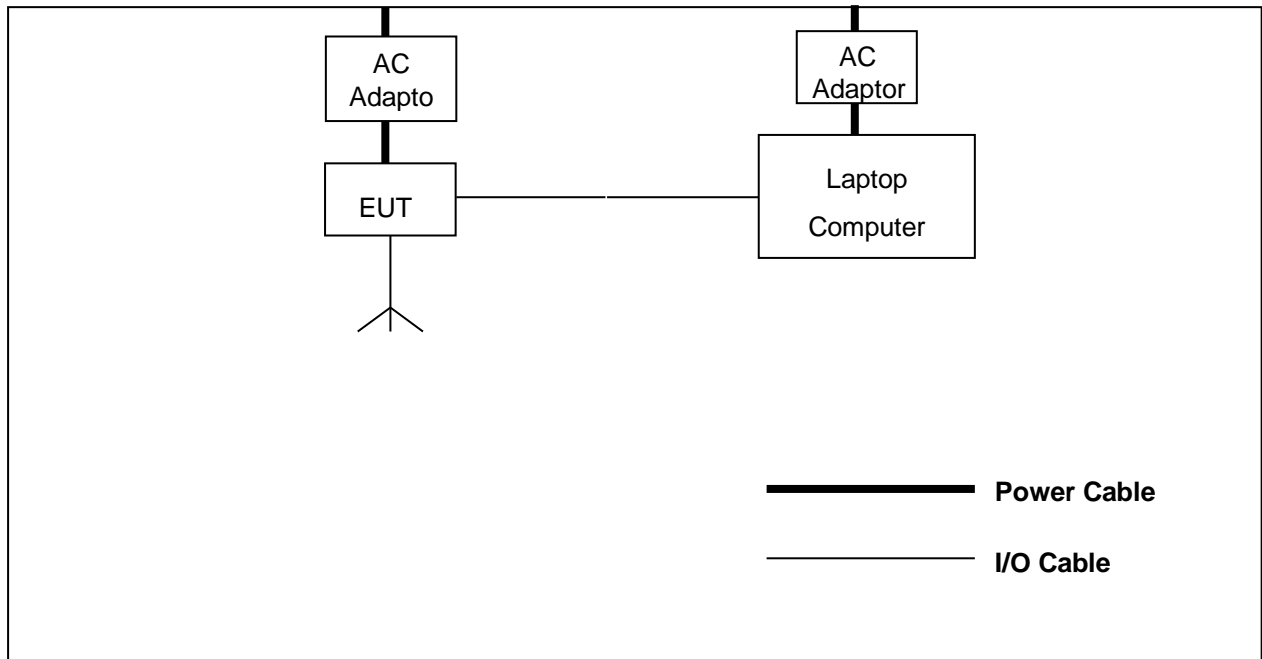

3.4 EUT Information

The EUT is the **YAMAHA CORPORATION VIDEO CONFERENCE SYSTEM FCC ID: A6RCS500, IC: 740B-CS500.**

Specifications:

EUT Type	VIDEO CONFERENCE SYSTEM
Model Name	CS-500
Brand Name	
Frequency of Operation	2 402 MHz ~ 2 480 MHz
Peak Output Power (Conducted)	3.24 dBm
FCC Classification	Digital Transmission System (DTS)
Number of Channels	40 CH
Modulations	GFSK(BLE)
Antenna Gain (peak)	2.5 dBi
Antenna Setup	1TX / 1RX
EUT Rated Voltage	20 Vdc, 2.1 A, 42 W
EUT Test Voltage	20 Vdc, 2.1 A, 42 W
Temperature Range	-10 °C ~ +70 °C
HVIN (Hardware Version Number)	CS-500
FVIN (Firmware Version Identification Number)	CS-500
Remarks	-

4. SUMMARY OF TEST RESULTS

The EUT has been tested according to the following specification:

Name of Test	FCC Paragraph No.	IC Paragraph No.	Result	Remark
Conducted Emission	15.207	RSS-GEN Issue 5 8.8	Complies	
Radiated Emission	15.209	RSS-GEN Issue 5 8.9	Complies	
6 dB Bandwidth	15.247(a)(2)	RSS-247 Issue 2 5.2	Complies	
Peak Output Power and E.I.R.P.	15.247(b)(3)	RSS-247 Issue 2 5.4	Complies	
Power Spectral Density	15.247(e)	RSS-247 Issue 2 5.2	Complies	
Conducted Spurious Emission	15.247(d)	RSS-247 Issue 2 5.5	Complies	
Radiated Spurious Emission	15.247(d)	RSS-247 Issue 2 5.5	Complies	
Maximum Permissible Exposure	1.1307(b)	RSS-102 Issue 5	Complies	

5. RECOMMENDATION/CONCLUSION

The data collected shows that the **YAMAHA CORPORATION VIDEO CONFERENCE SYSTEM FCC ID: A6RCS500, IC: 740B-CS500** is in compliance with Part 15.247 of the FCC Rule and RSS-247 Issue 2 of the IC Specification.

6. ANTENNA REQUIREMENTS

§15.203 of the FCC Rules part 15 Subpart C

: An intentional radiator shall be designed to ensure that no antenna other than that furnished by the responsible party shall be used with the device. The use of a permanently attached antenna or of an antenna that uses a unique coupling to the intentional radiator shall be considered sufficient to comply with the provisions of this section.

The antenna of the the **YAMAHA CORPORATION VIDEO CONFERENCE SYSTEM FCC ID: A6RCS500, IC: 740B-CS500** is **permanently attached** and there are no provisions for connection to an external antenna. It complies with the requirement of §15.203.

Used Antenna	
Model name	Max. gain (dBi)
	2.4 GHz
AFPBTCS8HOP	2.5

7. DESCRIPTION OF TESTS

7.1 Conducted Emissions

The Line conducted emission test facility is located inside a 4 x 7 x 2.5 meter shielded enclosure. It is manufactured by EM engineering. The shielding effectiveness of the shielded room is in accordance with MIL-STD-285 or NSA 65-6. A 1 m x 1.5 m wooden table 0.8 m height is placed 0.4 m away from the vertical wall and 1.5 m away from the side of wall of the shielded room. Rohde & Schwarz (ENV216) of the 50 ohm/50 μ H Line Impedance Stabilization Network (LISN) are bonded to the shielded room. The EUT is powered from the Rohde & Schwarz LISN (ENV216). Power to the LISNs are filtered by high-current high insertion loss Power line filters. The purpose of filter is to attenuate ambient signal interference and this filter is also bonded to shielded enclosure. All electrical cables are shielded by tinned copper zipper tubing with inner diameter of 1 / 2 ". If DC power device, power will be derived from the source power supply it normally will be powered from and this supply lines will be connected to the LISNs, All interconnecting cables more than 1 meter were shortened by non-inductive bundling (serpentine fashion) to a 1 meter length. Sufficient time for EUT, support equipment, and test equipment was allowed in order for them to warm up to their normal operating condition. The RF output of the LISN was connected to the spectrum analyzer to determine the frequency producing the maximum EME from the EUT. The spectrum was scanned from 150 kHz to 30 MHz with 200 msec sweep time. The frequency producing the maximum level was re-examined using the EMI test receiver. (Rohde & Schwarz ESCI). The detector functions were set to CISPR quasi-peak mode & average mode. The bandwidth of receiver was set to 9 kHz. The EUT, support equipment, and interconnecting cables were arranged and manipulated to maximize each EME emission. Each emission was maximized by; switching power lines; varying the mode of operation or resolution; clock or data exchange speed; scrolling H pattern to the EUT and of support equipment, and powering the monitor from the floor mounted outlet box and computer aux AC outlet, if applicable; whichever determined the worst case emission. Each EME reported was calibrated using the R&S signal generator.

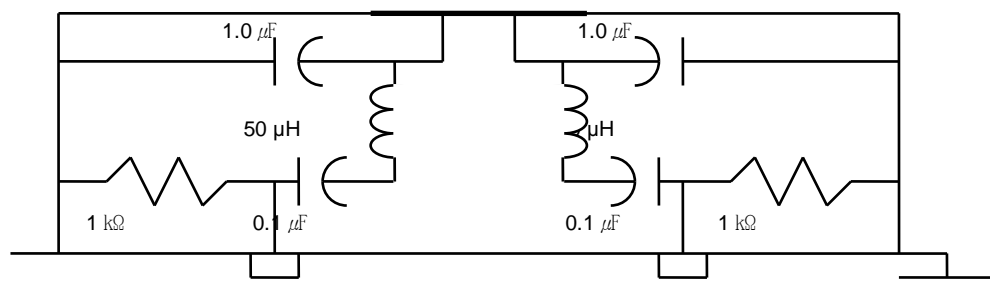

Fig. 2. LISN Schematic Diagram

7.2 Radiated Emissions

The measurement was performed at the test site that is specified in accordance with ANSI C63.10-2013.

The spurious emission was scanned from 9 kHz to 30 MHz using Loop Antenna(Rohde&Schwarz, HFH2-Z2) and 30 to 1000 MHz using Trilog broadband test antenna(Schwarzbeck, VULB 9163). Above 1 GHz, Horn antenna (Schwarzbeck HF907: up to 18 GHz, Q-par Angus QMS-00225 : 18 to 26.5 GHz) was used.

For emissions testing at below 1GHz, The test equipment was placed on turntable with 0.8 m above ground. For emission measurements above 1 GHz, The test equipment was placed on turntable with 1.5 m above ground. Sufficient time for the EUT, support equipment, and test equipment was allowed in order for them to warm up to their normal operating condition. The EUT, cable, wire arrangement and mode of operation that has the highest amplitude relative to the limit was selected. Then, the turn table was rotated from 0° to 360° and an antenna mast was moved from 1 m to 4 m height to maximize the suspected highest amplitude signal. The final maximized level was recorded.

At frequencies below 1000 MHz, measurements performed using the CISPR quasi-peak detection. At frequencies above 1000 MHz, measurements performed using the peak and average measurement procedures described in ANSI 63.10-2013 section 11.12. Peak emission levels were measured by setting the analyzer RBW = 1 MHz, VBW = 3 MHz, Detector = Peak, Trace mode = max hold. Average emission levels were measured by setting the analyzer RBW = 1 MHz, VBW = 10 kHz, Detector = Peak, Trace mode = max hold. Allow max hold to run for at least 50 times (1/duty cycle) traces.

Frequency (MHz)	Field strength (microvolts/meter)	Measurement distance (meters)
0.009–0.490	2400/F(kHz)	300
0.490–1.705	24000/F(kHz)	30
1.705–30.0	30	30
30–88	100	3
88–216	150	3
216–960	200	3
Above 960	500	3

Radiated Emissions Limits per 47 CFR 15.209(a) and RSS-GEN Issue 5 8.9

7.3 6 dB Bandwidth

Test Setup

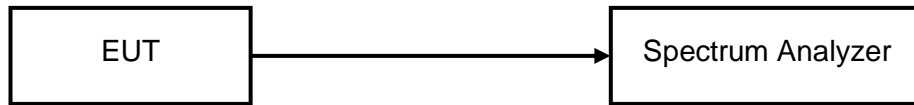

Test Procedure

EUTs 6 dB bandwidth is measured at low, middle, high channels with a spectrum analyzer connected to the antenna terminal while the EUTs operating at its maximum power control level. The spectrum analyzer setting is as follows.

RBW = 100 kHz

VBW > 3 x RBW

Detector = Peak

Trace mode = max hold

Sweep = auto couple

The bandwidth measurement function on the spectrum analyzer is used to measure the 6 dB bandwidth.

7.4 Peak Output Power and E.I.R.P.

Test Setup

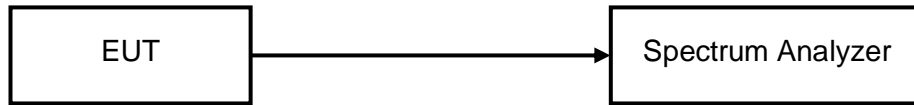

Test Procedure

EUTs Maximum Peak Conducted Output Power is measured at low, middle, high channels with a spectrum analyzer connected to the antenna terminal while the EUTs operating at its maximum power control level.

The spectrum analyzer setting is as follows.

RBW \geq DTS bandwidth

VBW \geq 3 x RBW

Span \geq 3 x RBW

Sweep time = auto couple

Detector = peak

Trace mode = max hold

Allow trace to fully stabilize.

Use peak marker function to determine the peak amplitude level.

7.5 Peak Power Spectral Density

Test Setup

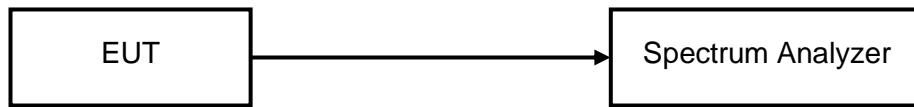

Test Procedure

EUTs Peak Power Spectral Density is measured at low, middle, high channels with a spectrum analyzer connected to the antenna terminal while the EUTs operating at its maximum power control level.

The spectrum analyzer setting is as follows.

Center frequency = DTS channel center frequency

Span = 1.5 times the DTS channel bandwidth

RBW \geq 3kHz

VBW \geq 3 x RBW

Detector = peak

Sweep time = auto couple

Trace mode = max hold

Allow the trace to stabilize.

The peak search function on the spectrum analyzer is used to determine the maximum amplitude level within the RBW.

7.6 Conducted Spurious Emissions

Test Setup

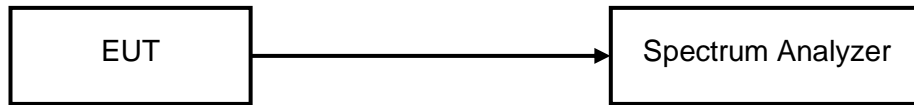

Test Procedure

EUTs Conducted spurious emissions are measured at low, middle, high channels with a spectrum analyzer connected to the antenna terminal while the EUTs operating at its maximum power control level. The spectrum analyzer setting is as follows.

1) Reference Level

Center frequency = DTS channel center frequency

Span $\geq 1.5 \times$ DTS bandwidth

RBW = 100 kHz

VBW $\geq 3 \times$ RBW

Detector = peak

Sweep time = auto couple

Trace mode = max hold

Allow trace to fully stabilize.

Use the peak marker function to determine the maximum PSD level.

Note that the channel found to contain the maximum PSD level can be used to establish the reference level.

2) Unwanted Emissions

Set the center frequency and span to encompass frequency range to be measured.

RBW = 100 kHz

VBW $\geq 3 \times$ RBW

Detector = peak

Sweep time = auto couple

Trace mode = max hold

Allow trace to fully stabilize.

Use the peak marker function to determine the maximum amplitude level.

8. TEST DATA

8.1 Conducted Emissions

FCC §15.207, RSS-GEN Issue 5 8.8

Result

Frequency (MHz)	Level (dB μ V)		*) Factor (dB)	**) Line	Limit (dB μ V)		Margin (dB)	
	Q-Peak	Average			Q-Peak	Average	Q-Peak	Average
0.16	52.3	32.4	9.90	L	65.6	55.6	13.3	23.2
0.19	45.9	29.2	9.90	N	63.7	53.7	17.8	24.5
0.20	45.2	28.8	9.90	N	63.4	53.3	18.2	24.5
0.40	45.6	36.3	9.90	N	57.8	47.8	12.2	11.5
0.41	45.5	36.7	9.90	L	57.4	47.4	11.9	10.7
21.63	40.1	35.4	10.40	L	60.0	50.0	19.9	14.6

Line Conducted Emissions Tabulated Data

Notes:

1. Measurements using CISPR quasi-peak mode & average mode.
2. The worst channel was investigated and the worst -case emission are reported. See attached Plots.
3. Lowest channel (2 402 MHz) is the worst case.
4. *) Factor = LISN + Cable Loss
5. **) LINE : L = Line , N = Neutral
6. The limit is on the FCC §15.207(a) and IC RSS-GEN issue5 8.8.

PLOTS OF EMISSIONS

Worst Case

Conducted Emission at the Mains port (Line + Neutral)

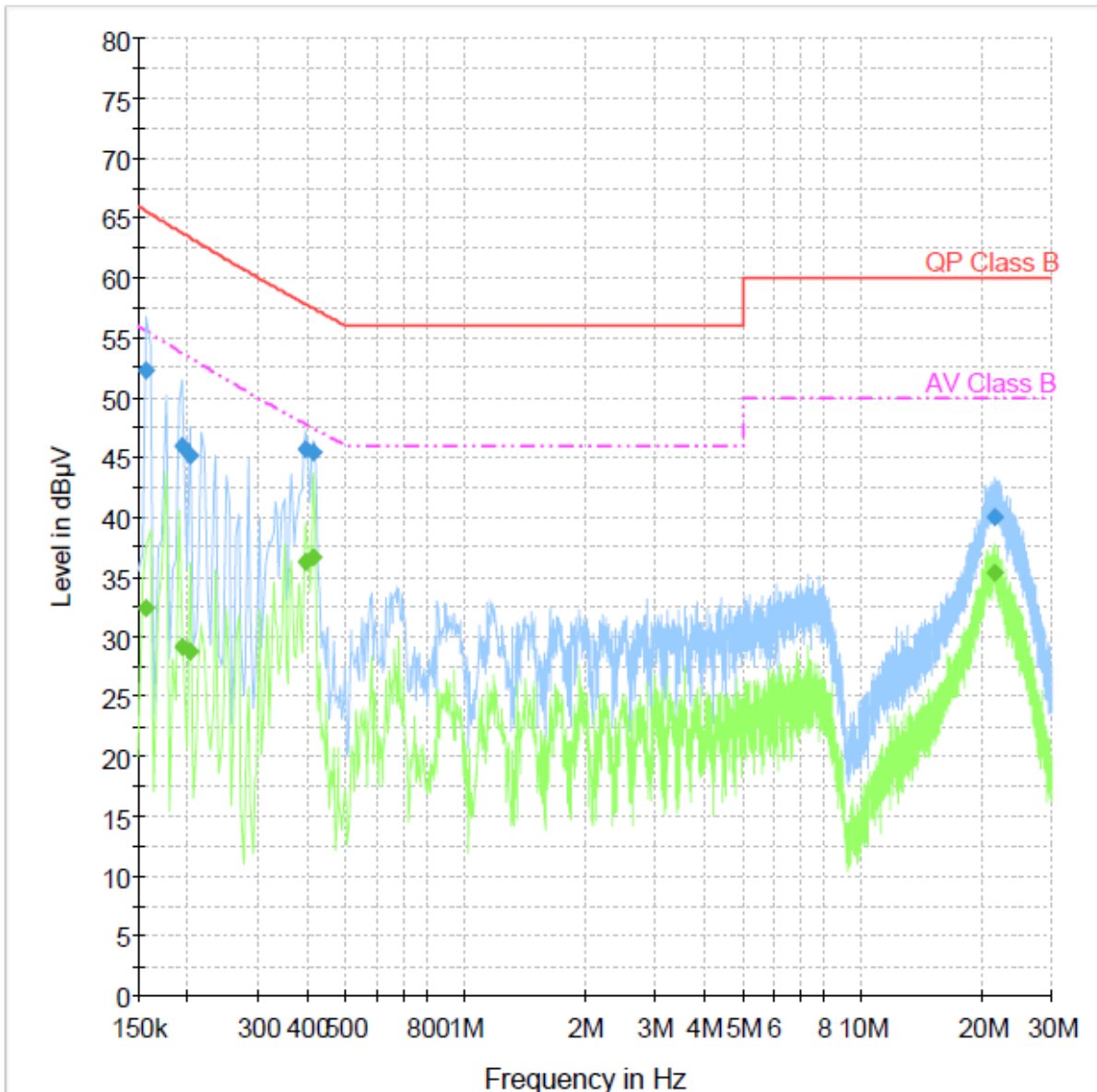

TEST DATA

8.2 Radiated Emissions

FCC §15.209, IC RSS-Gen Issue 5 8.9

Result

Frequency (MHz)	Reading (dBµV)	Pol* (H/V)	mode	AF+CL+Amp (dB)**	Result (dBµV/m)	Limit (dBµV/m)	Margin (dB)
30.00	59.44	V	QP	-24.4	35.04	40.0	4.96
88.63	48.51	V	QP	-26.3	22.21	43.5	21.29
137.94	65.48	V	QP	-27.9	37.58	43.5	5.92
275.79	56.20	H	QP	-22.0	34.20	46.0	11.80
719.99	46.85	H	QP	-12.2	34.65	46.0	11.35
960.01	45.61	V	QP	-9.8	35.81	56.0	20.19

Radiated Measurements at 3meters

Notes:

1. The worst-case emission was reported.
2. *Pol. H = Horizontal, V = Vertical
3. Lowest channel (2 402 MHz) is the worst case.
4. **AF + CL + Amp. = Antenna Factor + Cable Loss + Amplifier.
5. Measurements using CISPR quasi-peak mode below 1 GHz.
6. The radiated emissions testing were made by rotating the receive antenna with horizontal, Vertical polarization. The worst data was recorded.
7. No emission found between lowest internal used/generated frequency to 30MHz (9kHz~30MHz).
8. The limit is on the FCC §15.209 and RSS-Gen Issue5 8.9.

PLOTS OF EMISSIONS

Worst Case

Radiated emission below 1GHz_2 402 MHz

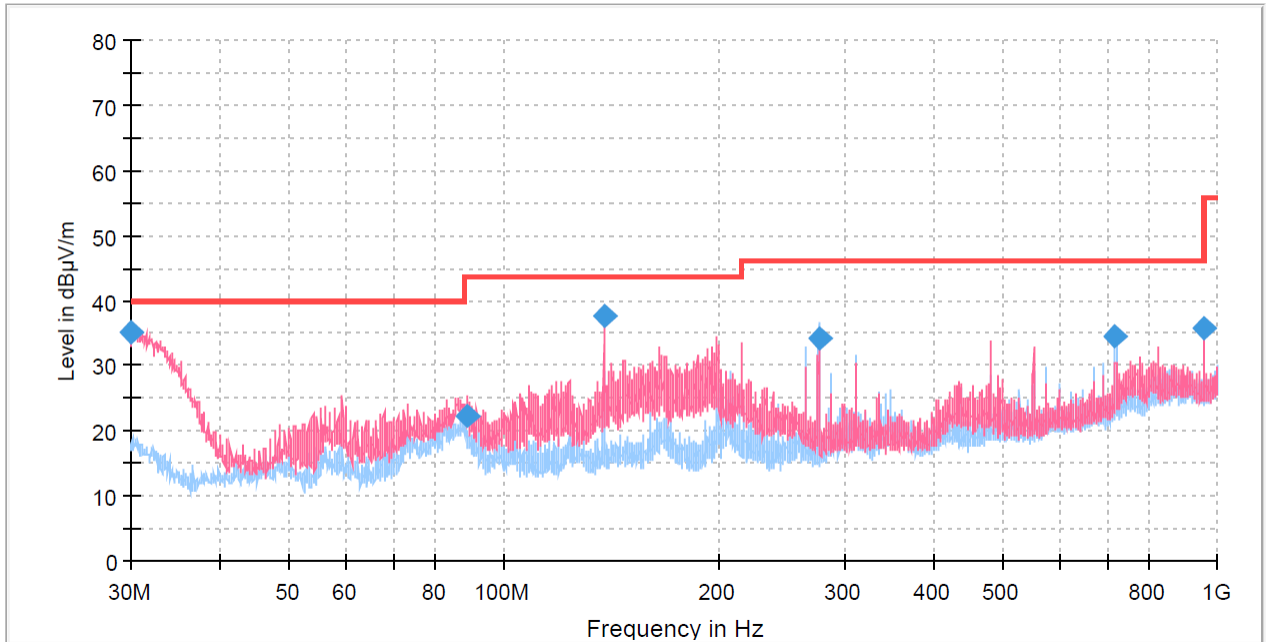

TEST DATA

8.3 6 dB Bandwidth

FCC §15.247(a)(2), IC RSS-247 Issue 2 5.2

Test Mode : Set to Lowest channel, Middle channel and Highest channel,

Result

Mode	Channel	Frequency (MHz)	6 dB modulated bandwidth (MHz)	Limit (MHz)	Margin (MHz)	99% emission bandwidth (MHz)
LE 1M	Lowest	2 402	0.68	0.50	0.18	1.09
	Middle	2 442	0.66	0.50	0.16	1.09
	Highest	2 480	0.67	0.50	0.17	1.09

PLOTS OF EMISSIONS

6 dB & 99% Bandwidth, Lowest Channel (2 402 MHz)

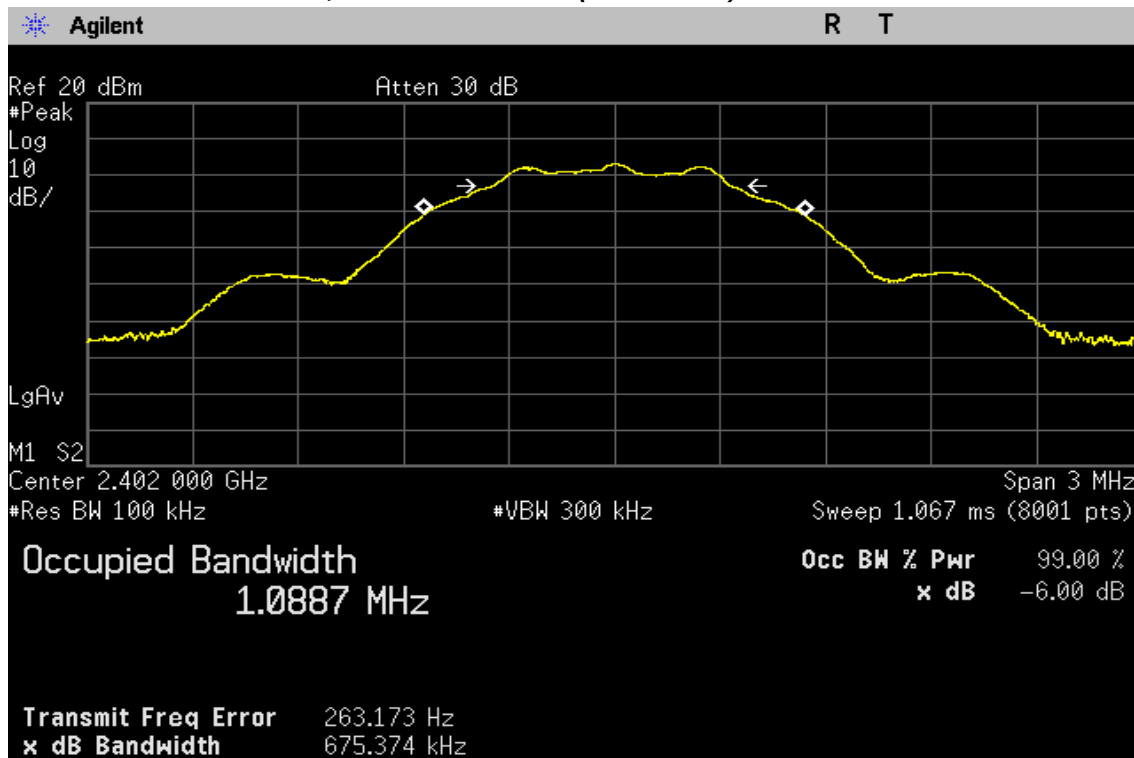

6 dB & 99% Bandwidth, Middle Channel (2 442 MHz)

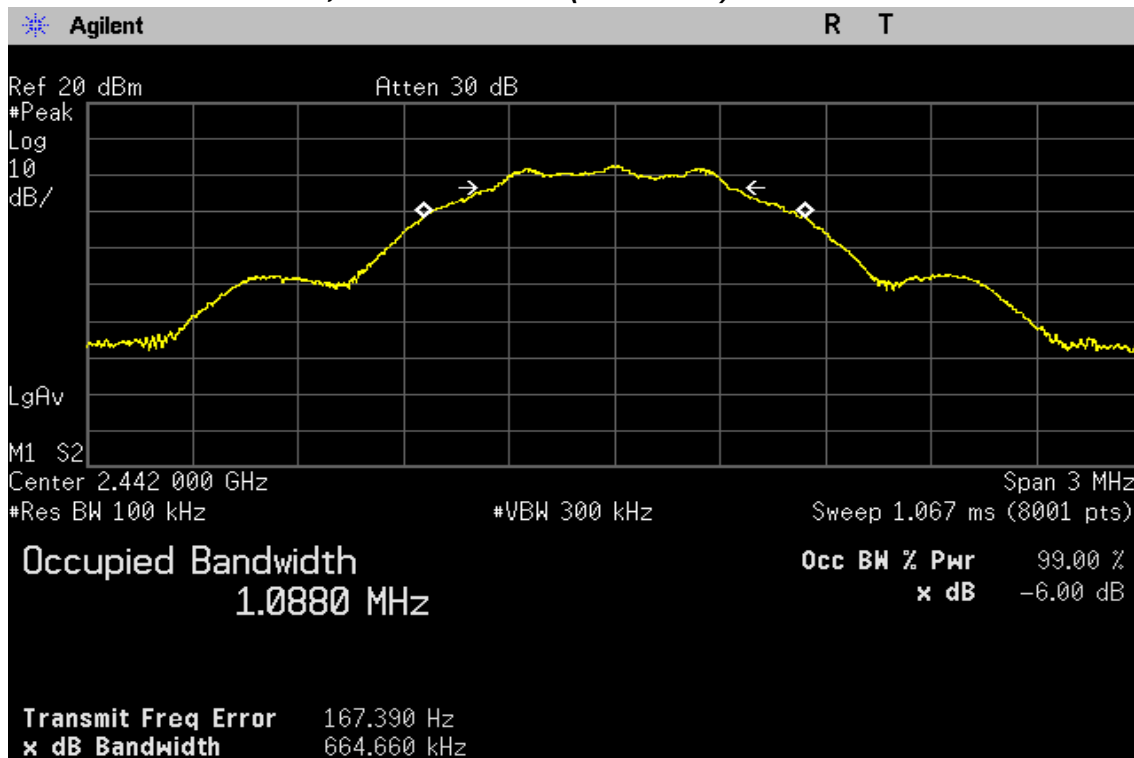

PLOTS OF EMISSIONS

6 dB & 99% Bandwidth, Highest Channel (2 480 MHz)

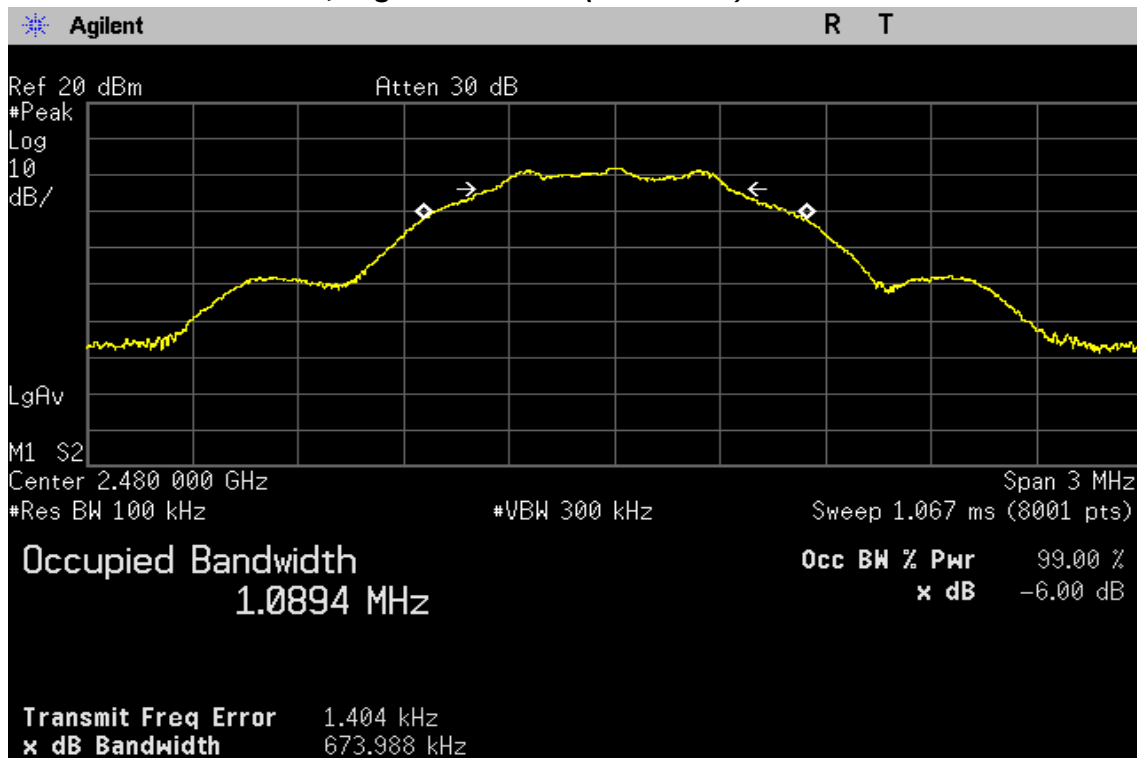

TEST DATA

8.4 Peak Output Power and E.I.R.P.

FCC §15.247(b)(3), IC RSS-247 Issue 2 5.4

Test Mode : Set to Lowest channel, Middle channel and Highest channel,

Result

Mode	Channel	Frequency (MHz)	Peak Output Power (dBm)	Limit (dBm)	E.I.R.P (dBm)	E.I.R.P Limit (dBm)
LE 1M	Lowest	2 402	3.24	30.00	5.74	36.00
	Middle	2 442	2.71	30.00	5.21	36.00
	Highest	2 480	2.09	30.00	4.59	36.00

Note:

1. E.I.R.P was calculated by following equation according to KDB412172 D01 Determining ERP and EIRP v01r01.

$$E.I.R.P = P_T + G_T - L_C$$

P_T = Peak outputpower (dBm)

G_T = Gain of the transmitting antenna in dBi, Directional antenna gain is **2.50 dBi**.

L_C = Signal attenuation in the connecting cable between the transmitter and antenna in dB. This factor of an integral antenna is negligible.

2. The following equation was used for spectrum offset:

$$\text{Spectrum offset (dB)} = \text{Attenuator (dB)} + \text{Cable Loss (dB)} + \text{SMA Type Connector Loss (dB)}$$

PLOTS OF EMISSIONS

Maximum Peak Output Power, Lowest Channel (2 402 MHz)

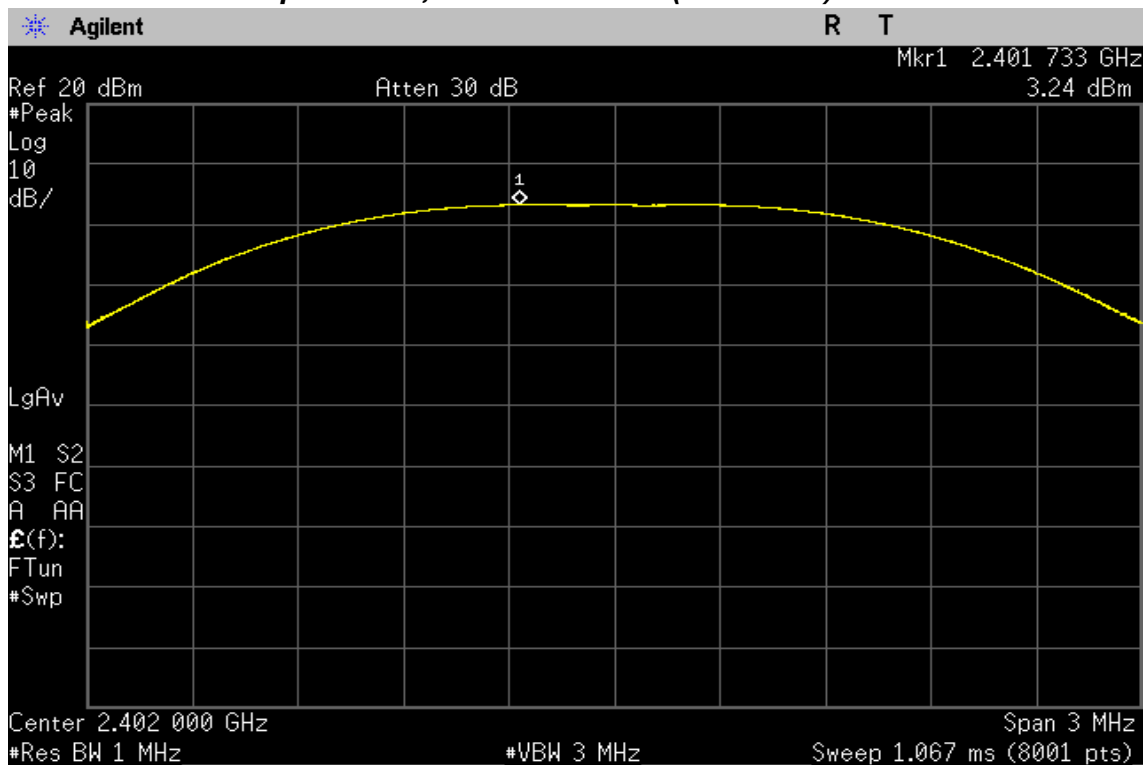

Maximum Peak Output Power, Middle Channel (2 442 MHz)

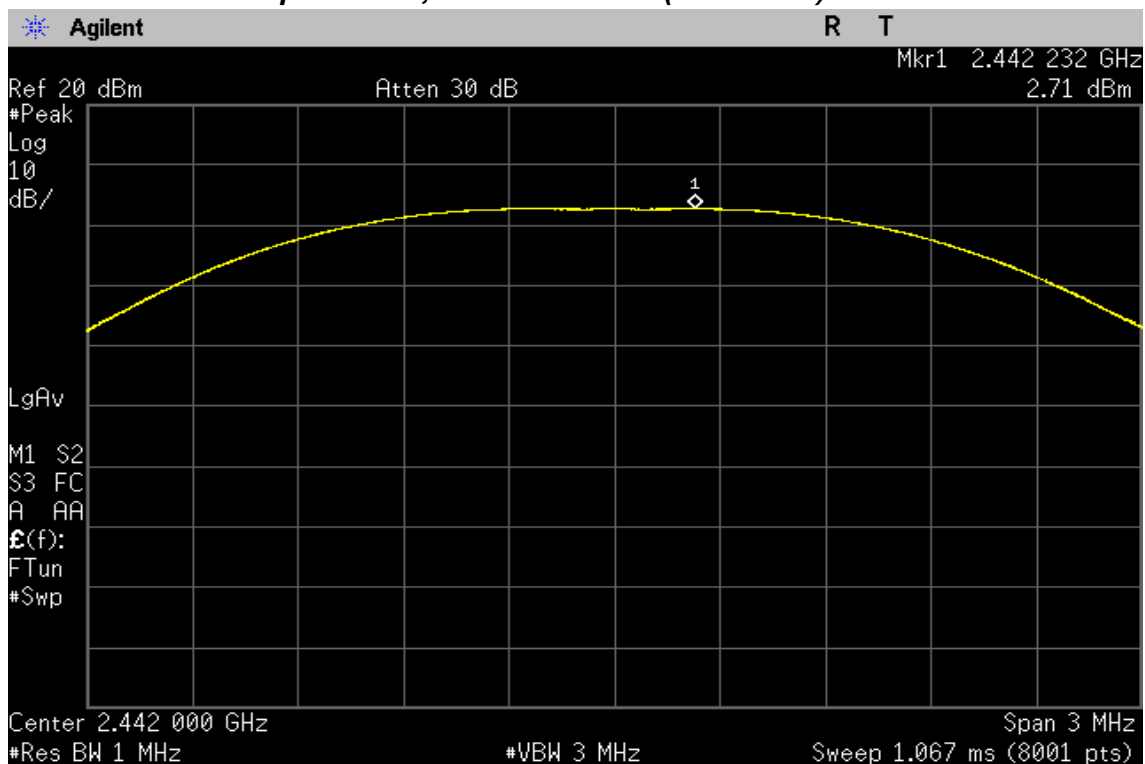

PLOTS OF EMISSIONS

Maximum Peak Output Power, Highest Channel (2 480 MHz)

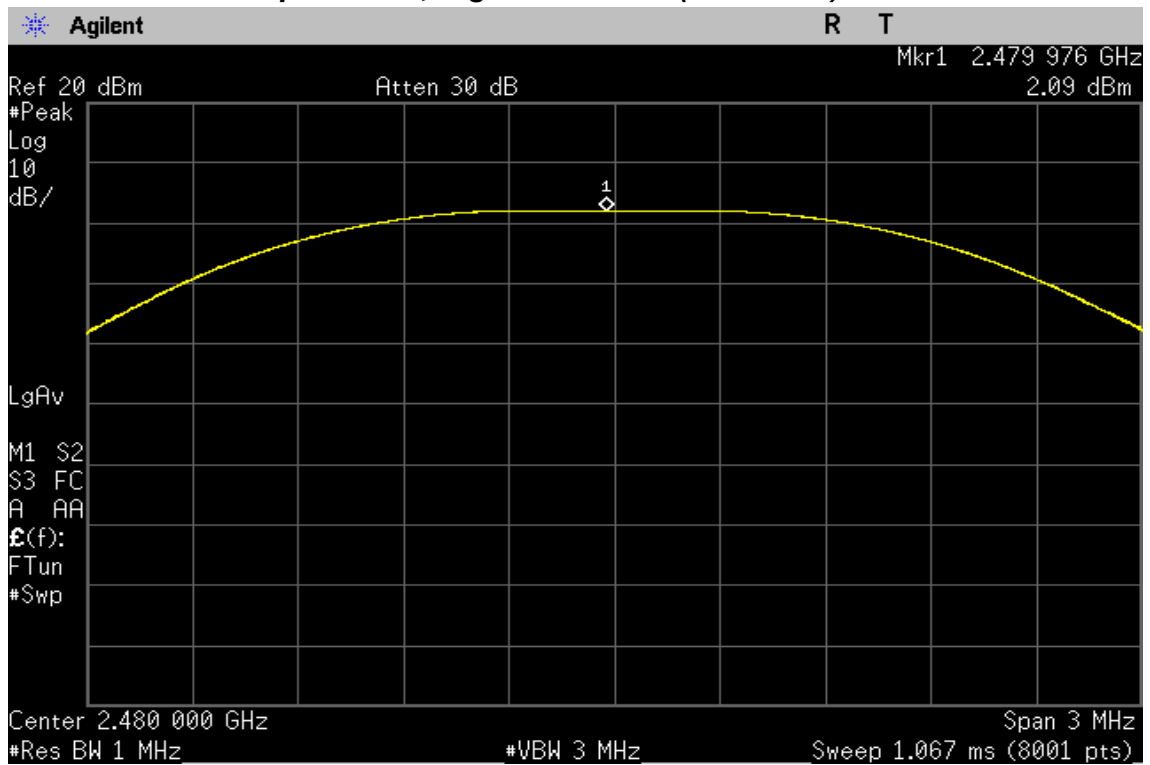

TEST DATA

8.5 Peak Power Spectral Density

FCC §15.247(e), IC RSS-247 Issue 2 5.2

Test Mode : Set to Lowest channel, Middle channel and Highest channel,

Result

Mode	Channel	Frequency (MHz)	Peak Power Spectral Density (dBm/10kHz)	Limit (dBm/3kHz)
LE 1M	Lowest	2 402	-7.20	8.00
	Middle	2 442	-7.64	8.00
	Highest	2 480	-8.12	8.00

Note:

1. The following equation was used for spectrum offset:

$$\text{Spectrum offset (dB)} = \text{Attenuator (dB)} + \text{Cable Loss (dB)} + \text{SMA Type Connector Loss (dB)}$$

PLOTS OF EMISSIONS

Peak Power Spectral Density, Lowest Channel (2 402 MHz)

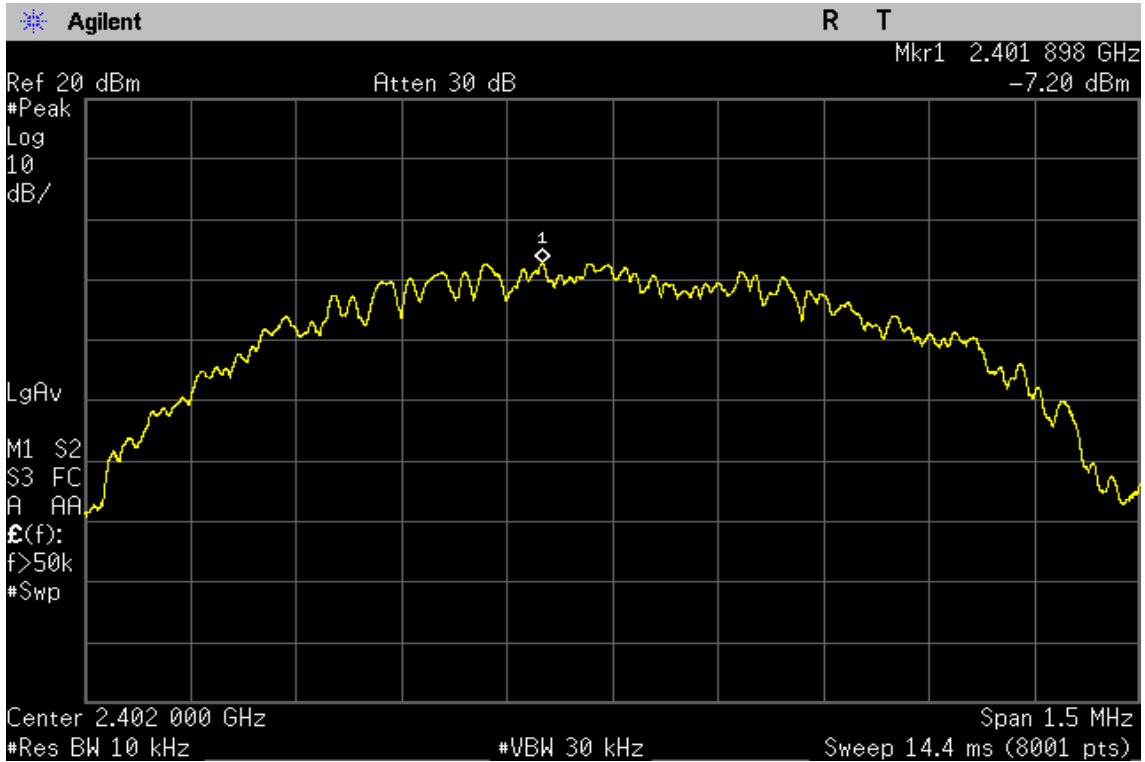

Peak Power Spectral Density, Middle Channel (2 442 MHz)

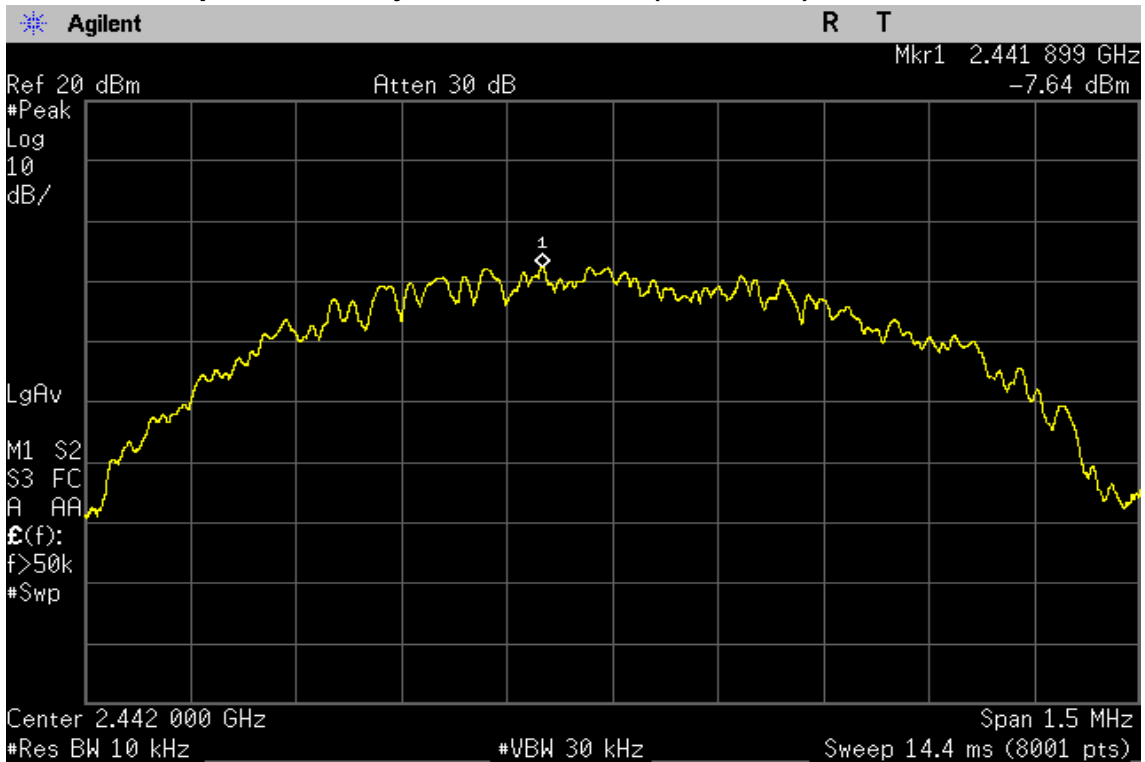

PLOTS OF EMISSIONS

Peak Power Spectral Density, Highest Channel (2 480 MHz)

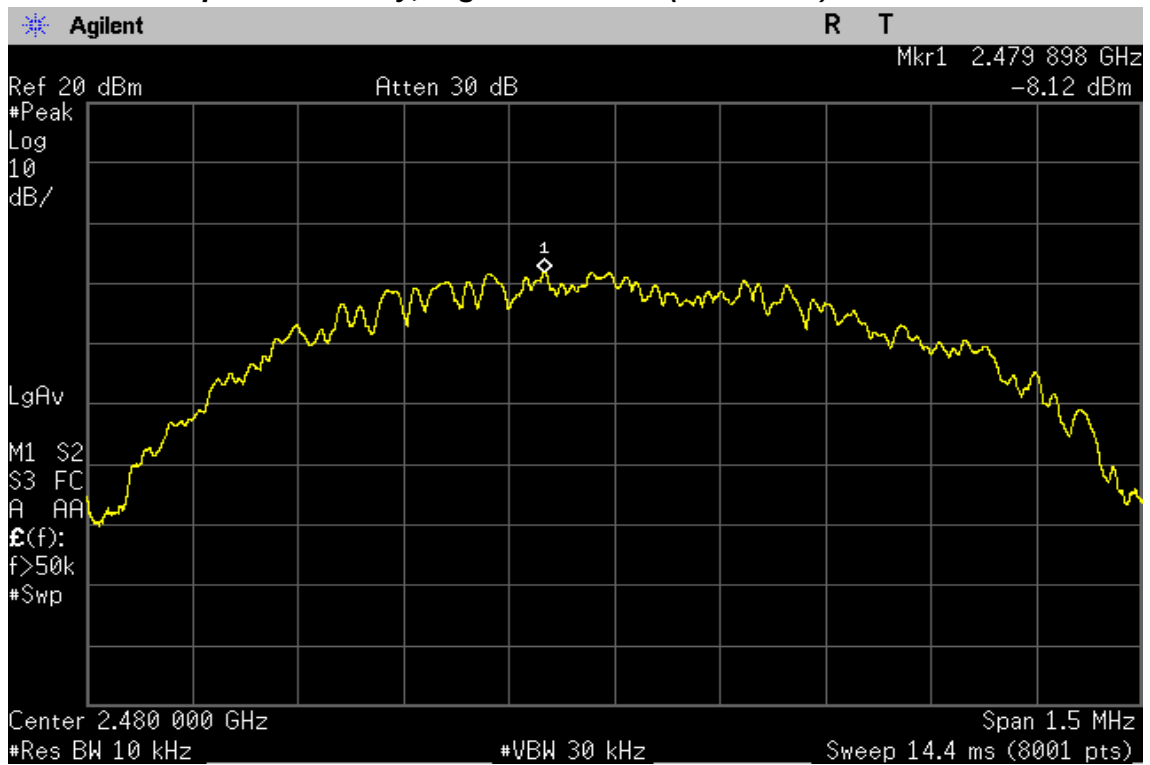

TEST DATA

8.6 Conducted Spurious Emissions

FCC §15.247(d), IC RSS-247 Issue 2 5.5

Test Mode : Set to Lowest channel, Middle channel and Highest channel,

Result

Mode	Channel	Frequency (MHz)	Reference Level (dBm/100kHz)	Conducted Spurious Emissions (dBc)	Limit (dBc)
LE 1M	Lowest	2 402	2.94	More than 20 dBc	20
	Middle	2 442	2.49	More than 20 dBc	20
	Highest	2 480	1.90	More than 20 dBc	20

Notes:

The cable and attenuator loss from 30 MHz to 26.5 GHz was reflected in spectrum analyzer with correction factor for the spurious emissions test.

PLOTS OF EMISSIONS

Reference Power Spectral Density, Lowest Channel (2 402 MHz)

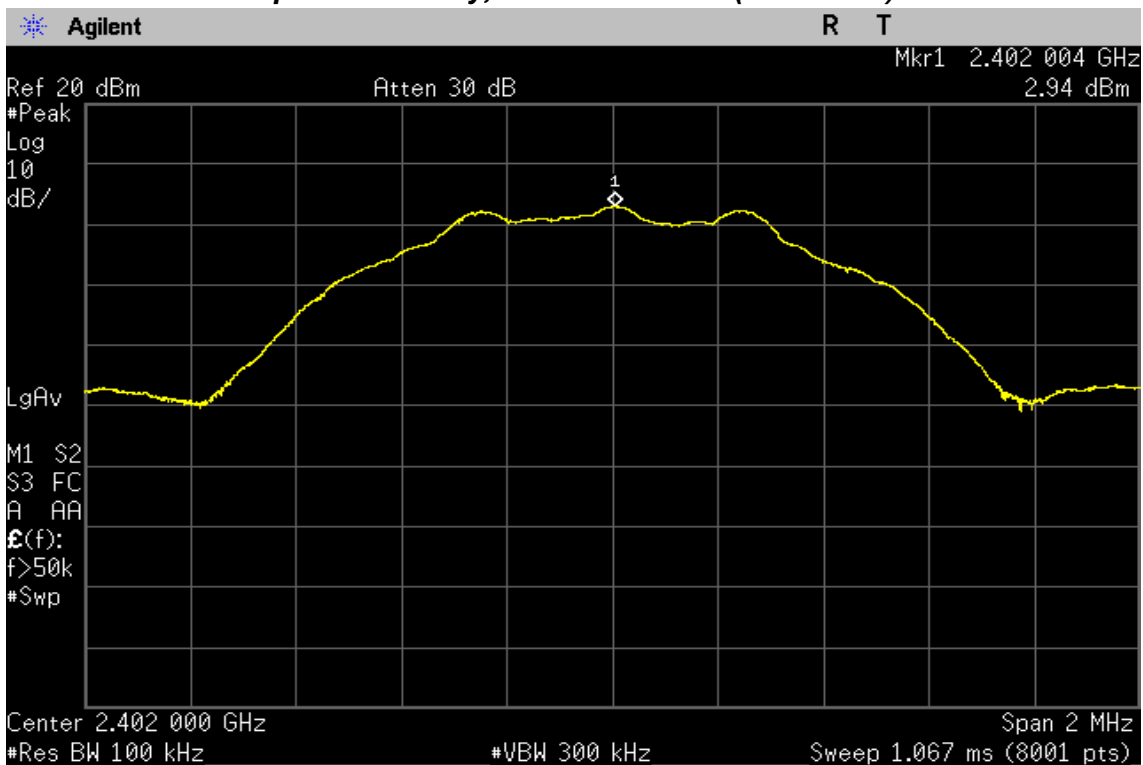

Band Edge, Lowest Channel (2 402 MHz)

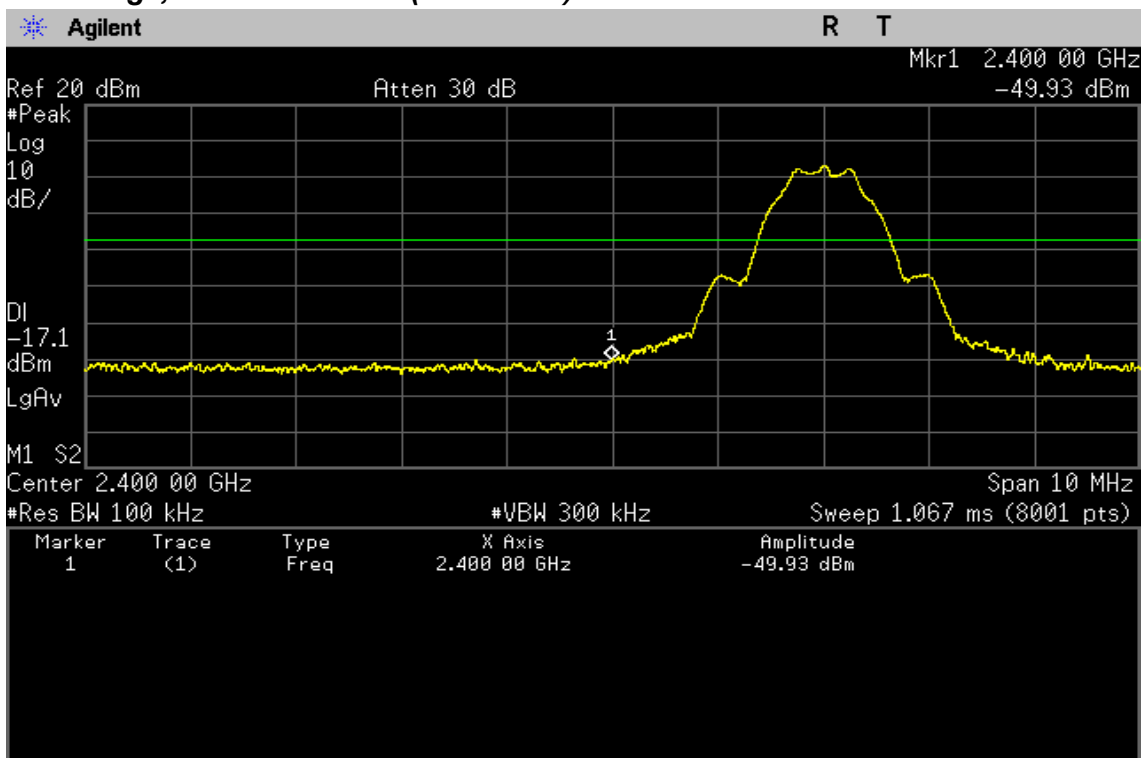

PLOTS OF EMISSIONS

Conducted Spurious Emissions, 30 MHz ~ 26.5 GHz (2 402 MHz)

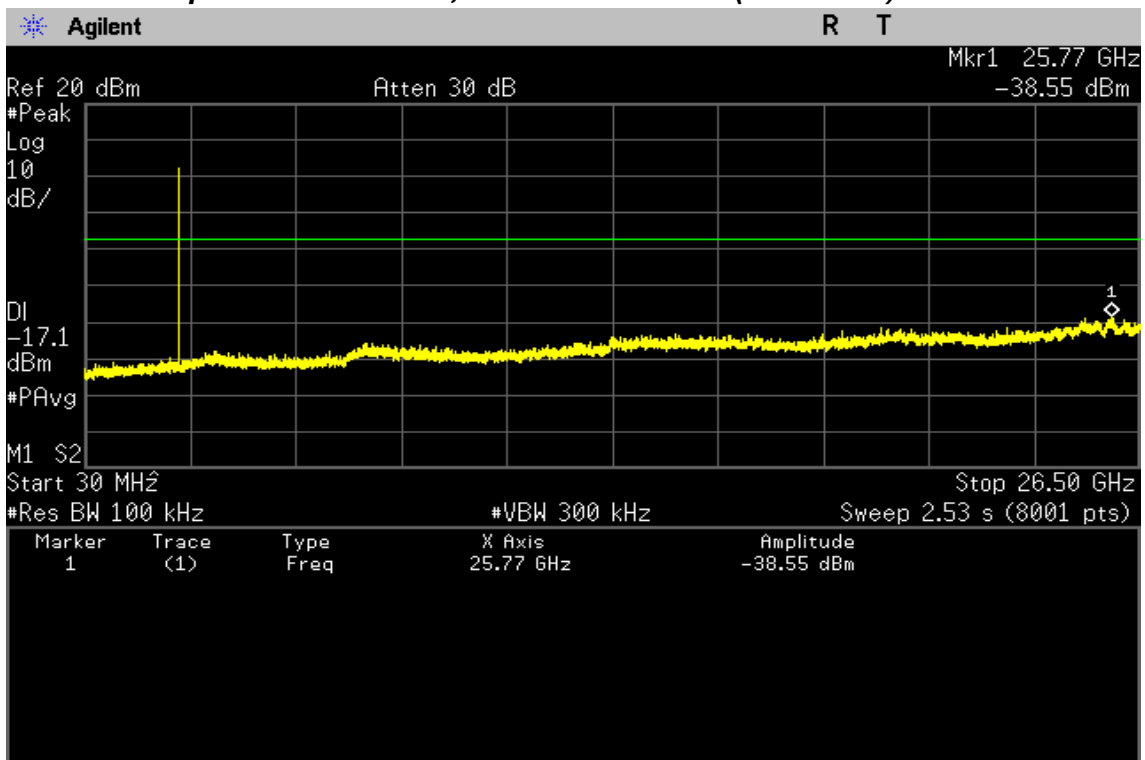

Reference Power Spectral Density, Middle Channel (2 442 MHz)

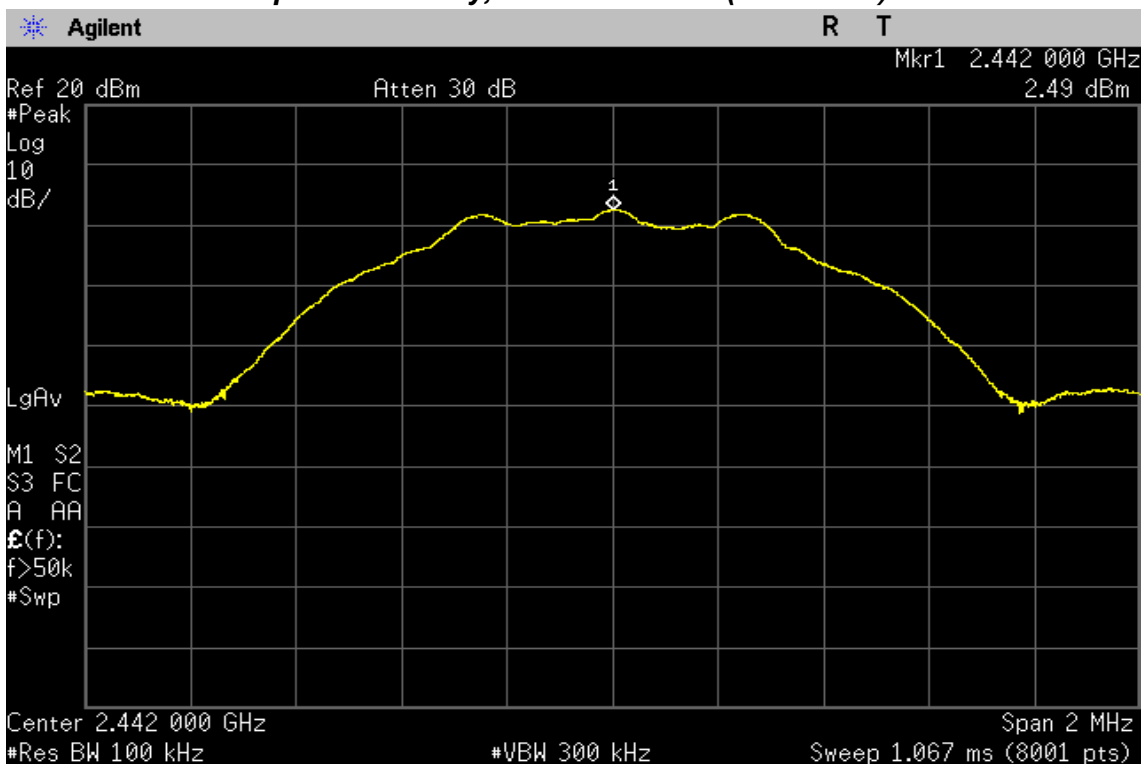

PLOTS OF EMISSIONS

Conducted Spurious Emissions, 30 MHz ~ 26.5 GHz (2 442 MHz)

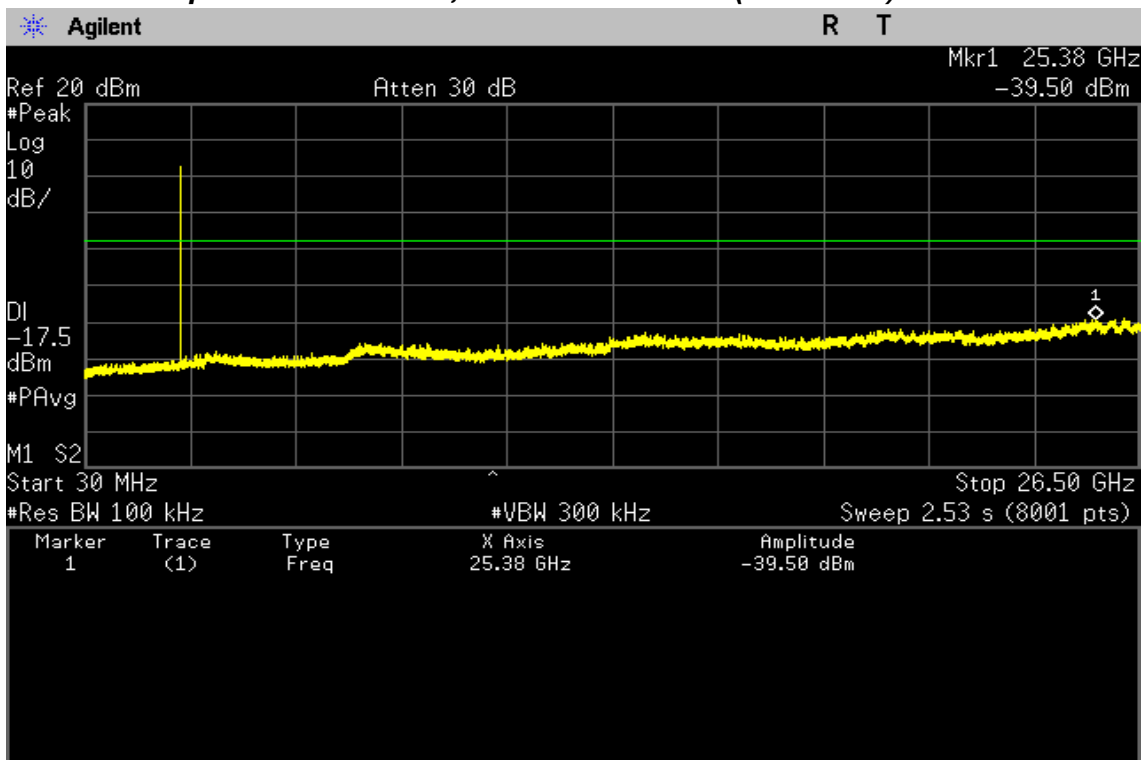

Reference Power Spectral Density, Highest Channel (2 480 MHz)

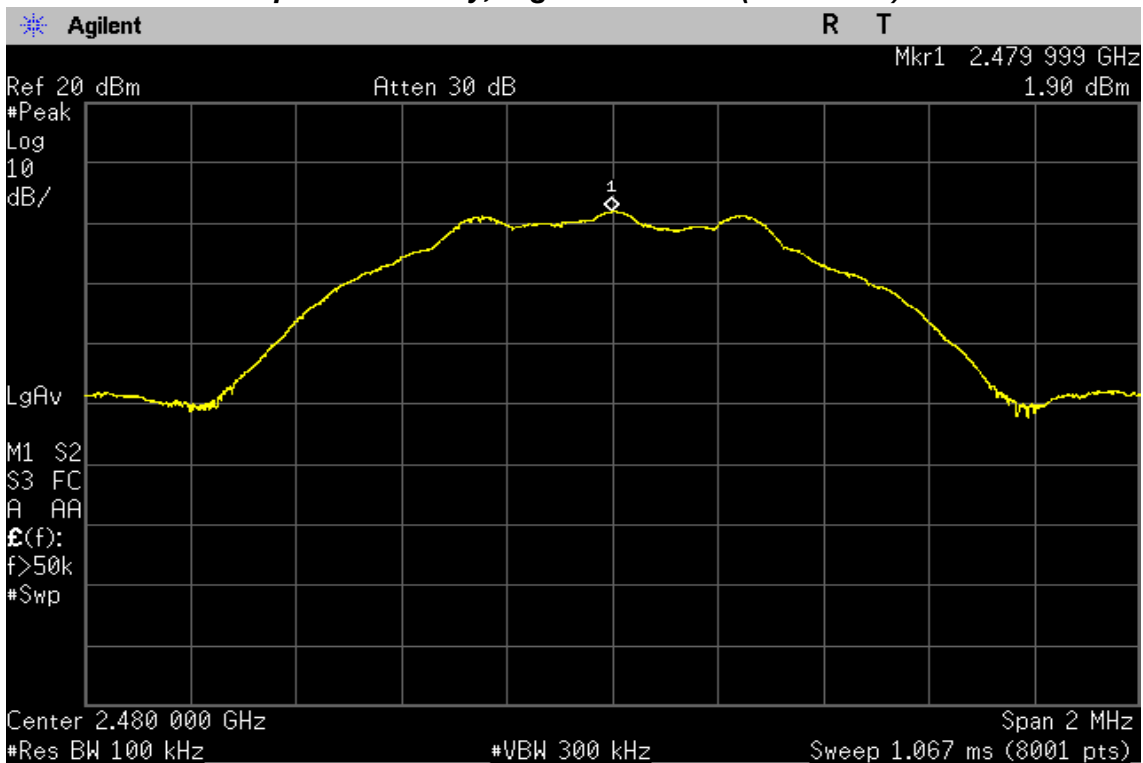

PLOTS OF EMISSIONS

Band Edge, Highest Channel (2 480 MHz)

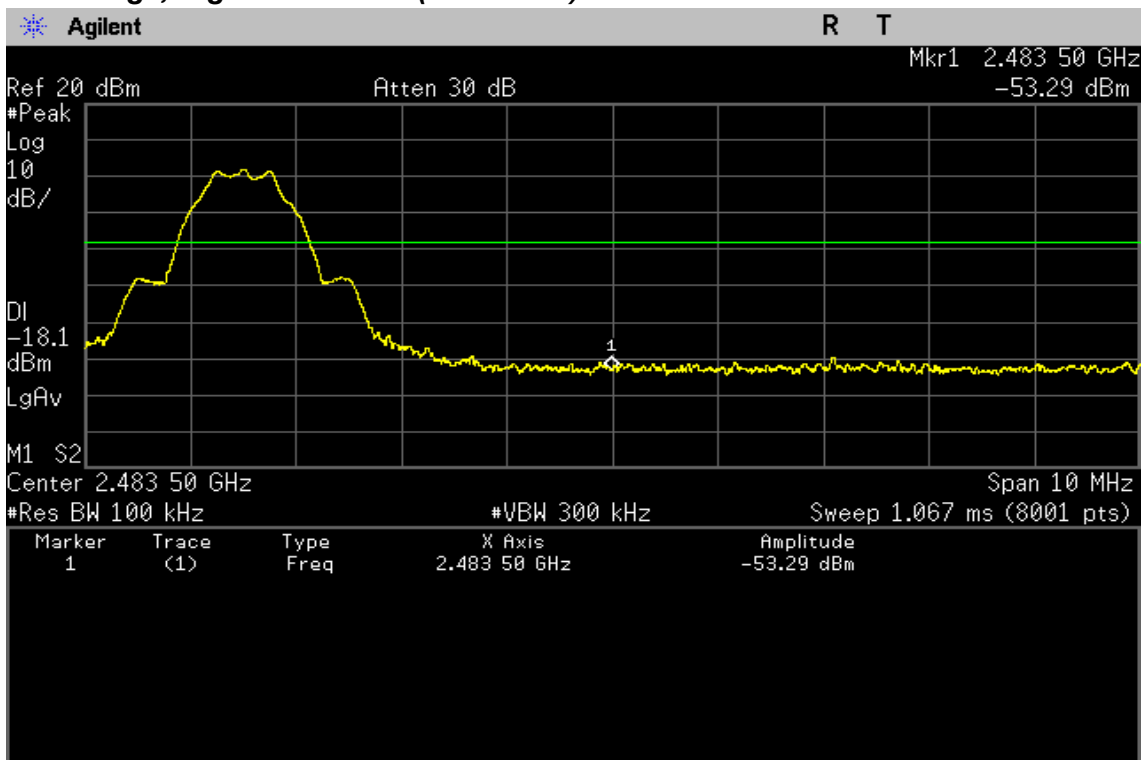

Conducted Spurious Emissions, 30 MHz ~ 26.5 GHz (2 480 MHz)

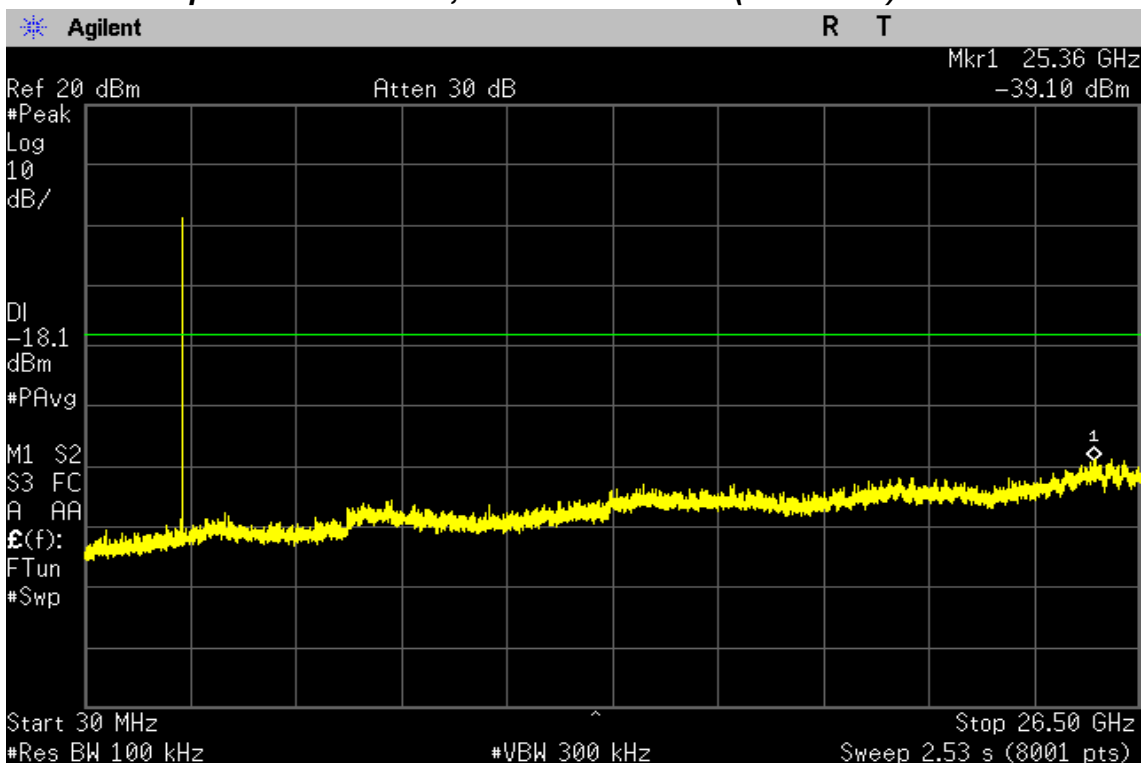

TEST DATA

8.7 Radiated Spurious Emissions

FCC §15.247(d), IC RSS-247 Issue 2 5.5

Test Mode : Set to Lowest channel, Middle channel and Highest channel,

Result

Lowest Channel

Frequency (MHz)	Reading (dBµV)	Pol* (H/V)	mode	AF+CL+Amp (dB)**	Result (dBµV/m)	Limit (dBµV/m)	Margin (dB)
4911.88	46.0	H	peak	2.2	48.18	74.0	25.82
7450.00	42.8	H	peak	6.6	49.42	74.0	24.58

Middle Channel

Frequency (MHz)	Reading (dBµV)	Pol* (H/V)	mode	AF+CL+Amp (dB)**	Result (dBµV/m)	Limit (dBµV/m)	Margin (dB)
5146.88	45.8	V	peak	2.4	48.17	74.0	25.83
7748.13	41.7	V	peak	7.2	48.93	74.0	25.07

Highest Channel

Frequency (MHz)	Reading (dBµV)	Pol* (H/V)	mode	AF+CL+Amp (dB)**	Result (dBµV/m)	Limit (dBµV/m)	Margin (dB)
4957.50	45.3	V	peak	2.4	47.65	74.0	26.35
7263.13	42.4	H	peak	6.1	48.54	74.0	25.46

Note:

1. *Pol. H = Horizontal V = Vertical
2. **AF + CL + Amp. = Antenna Factor + Cable Loss + Amplifier.
3. Average measurement was not performed when peak-detected emission complies with the average limit.
4. Other spurious was under 20 dB below Fundamental.
5. Lowest channel (2 402 MHz) was the worst condition.
6. The radiated emissions testing were made by rotating the receive antenna with horizontal, Vertical polarization. The worst data was recorded.
7. Peak emissions were measured using RBW = 1 MHz, VBW = 3 MHz, Detector = Peak.
8. Average emissions were measured using RBW = 1 MHz, VBW = 10 kHz, Detector = Peak.
9. The spectrum was measured from 1 GHz to 10th harmonic and the worst-case emissions were reported. No significant emissions were found beyond the 3rd harmonic for this device.

PLOTS OF EMISSIONS

Worst Case

Lowest channel : 1 GHz to 8 GHz_Peak

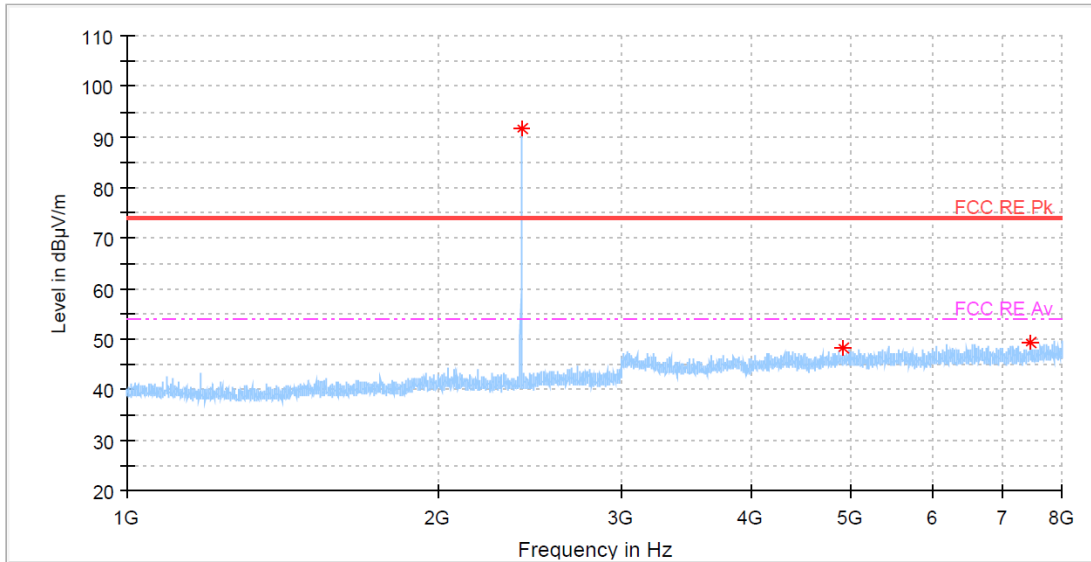

Lowest channel : 8 GHz to 18 GHz_Peak

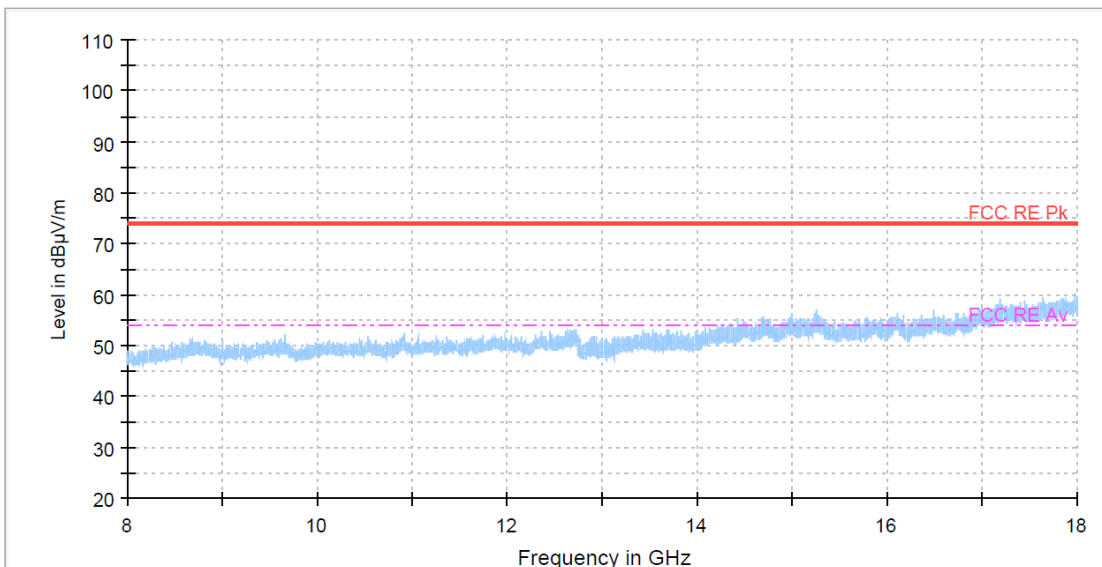

PLOTS OF EMISSIONS

Lowest channel : 8 GHz to 18 GHz_ Average

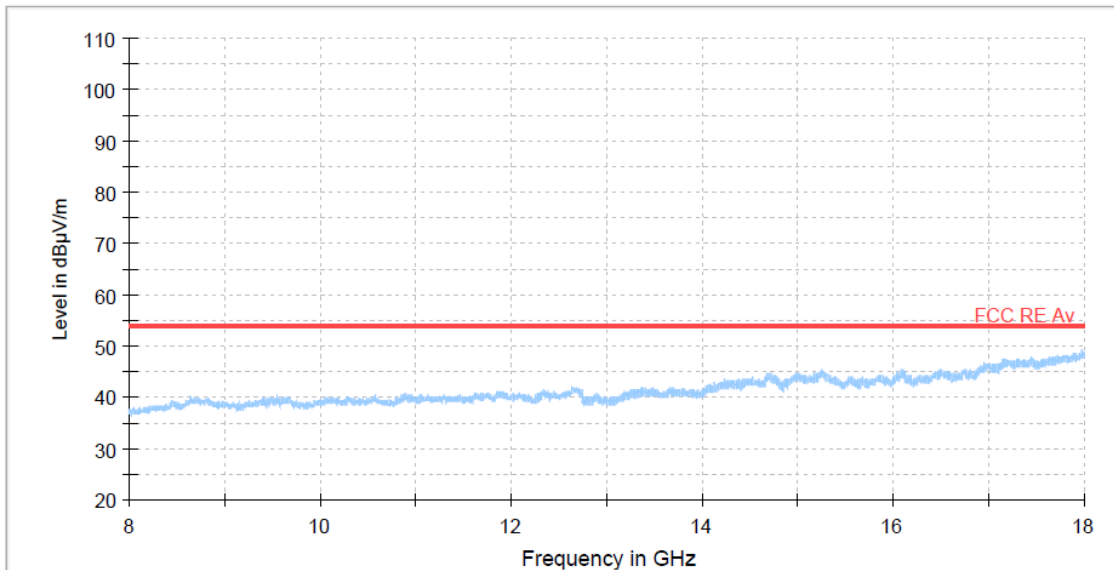

Lowest channel : 18 GHz to 26.5 GHz_ Peak

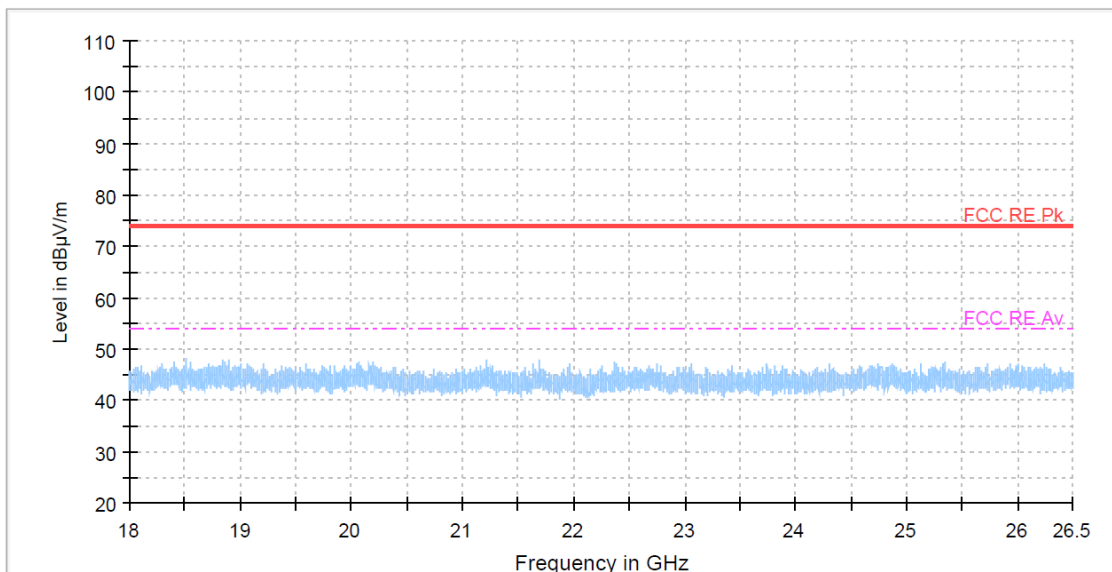

TEST DATA

8.8 Radiated Band Edge

FCC §15.247(d), IC RSS-247 Issue 2 5.5

Test Mode : Set to Lowest channel and Highest channel

Result

Lowest Channel

Frequency (MHz)	Reading (dBμV)	Pol* (H/V)	mode	AF+CL+Amp (dB)**	Result (dBμV/m)	Limit (dBμV/m)	Margin (dB)
2382.09	49.5	V	peak	-8.0	41.47	74.0	32.53
2390.00	47.7	v	peak	-7.9	39.78	74.0	34.22

Highest Channel

Frequency (MHz)	Reading (dBμV)	Pol* (H/V)	mode	AF+CL+Amp (dB)**	Result (dBμV/m)	Limit (dBμV/m)	Margin (dB)
2483.50	47.6	H	peak	-7.2	40.37	74.0	33.63
2485.53	49.4	H	peak	-7.2	42.23	74.0	31.77

Note:

1. *Pol. H = Horizontal V = Vertical
2. **AF + CL + Amp. = Antenna Factor + Cable Loss + Amplifier.
3. Average measurement was not performed when peak-detected emission complies with the average limit.
4. Other spurious was under 20 dB below Fundamental.
5. Highest channel (2 480 MHz) mode was the worst condition.
6. The radiated emissions testing were made by rotating the receive antenna with horizontal, Vertical polarization. The worst data was recorded.
7. Peak emissions were measured using RBW = 1 MHz, VBW = 3 MHz, Detector = Peak.

PLOT OF TEST DATA

Worst Case

Highest Channel Peak

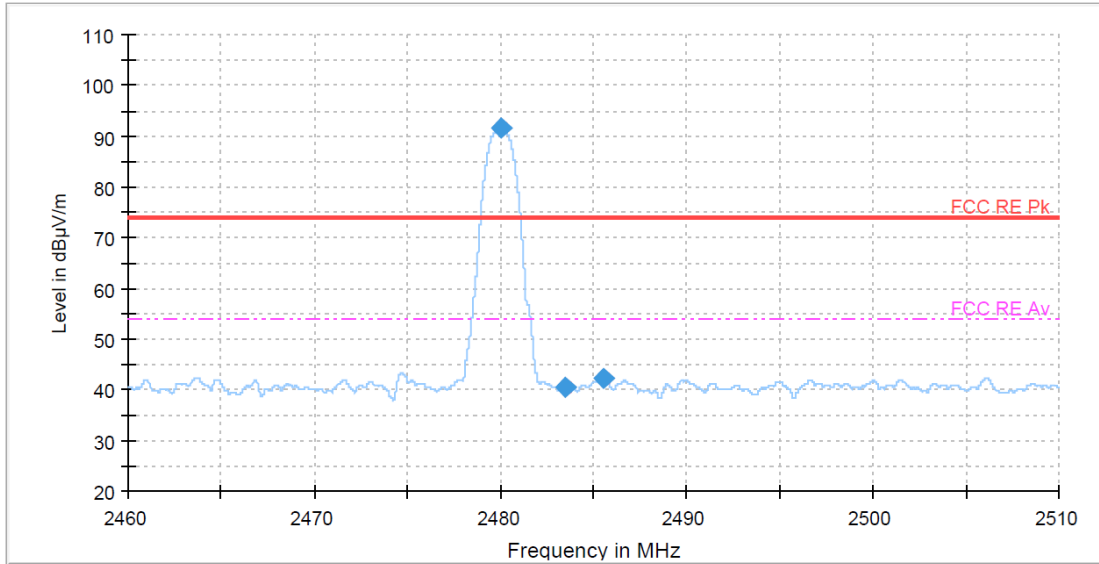

9. TEST EQUIPMENT

No.	Instrument	Manufacturer	Model	Serial No.	Calibration Date	Calibration Interval
1	*Test Receiver	R & S	ESW44	103091	May. 16 2022	1 year
2	*Test Receiver	R & S	ESCI	101041	Apr. 05 2022	1 year
3	*Attenuator	FAIRVIEW	SA3N5W-06	N/A	Apr. 06 2022	1 year
4	*Attenuator	FAIRVIEW	SA3N5W-10	N/A	Apr. 06 2022	1 year
5	*Attenuator	FAIRVIEW	SA26B-10	1643	Jul. 06 2022	1 year
6	*Amplifier	R & S	SCU 01	10029	Apr. 05 2022	1 year
7	*Amplifier	R & S	SCU 18	10065	Apr. 05 2022	1 year
8	*Amplifier	R & S	SCU26D	1984522	Jul. 08 2022	1 year
9	Amplifier	R & S	SCU40	100380	Jul. 08 2022	1 year
10	Spectrum Analyzer	R & S	FSW43	100732	Apr. 05 2022	1 year
11	*Spectrum Analyzer	Agilent	E4440A	MY44303257	Oct. 13 2021	1 year
12	*Loop Antenna	R & S	HFH2-Z2	100279	Mar. 14 2022	1 year
13	*Horn Antenna	R & S	HF907	102585	Jul. 08 2022	1 year
14	*Horn Antenna	Q-par Angus	QMS-00225	17637	Sep. 15 2021	1 year
15	Horn Antenna	Q-par Angus	QSH22K20	8180	Jul. 14 2022	1 year
16	*Trilog-Broadband Antenna	SCHWARZBECK	VULB 9163	01431	May. 11 2021	2 year
17	*LISN	R & S	ENV216	101156	Apr. 05 2022	1 year
18	Position Controller	INNCO	CO2000	12480406/L	N/A	N/A
19	*Controller	INNCO	CO3000	CO3000/937/38330516/L	N/A	N/A
20	Turn Table	INNCO	DS1200S	N/A	N/A	N/A
21	*Turn Table	INNCO	DT2000-2t	N/A	N/A	N/A
22	Antenna Mast	INNCO	MA4000	N/A	N/A	N/A
23	*TILT Antenna Mast	INNCO	MA4640-XP-EP	N/A	N/A	N/A
24	Open Switch And Control Unit	R & S	OSP-120	100081	N/A	N/A
25	*Open Switch And Control Unit	R & S	OSP-120	101766	N/A	N/A
26	Shielded Room	Seo-Young EMC	N/A	N/A	N/A	N/A
27	*Anechoic Chamber	Seo-Young EMC	N/A	N/A	N/A	N/A
28	WiFi Filter Bank	R & S	U083	N/A	N/A	N/A
29	*WiFi Filter Bank	R & S	U082	N/A	N/A	N/A

*) Test equipment used during the test

10. ACCURACY OF MEASUREMENT

The Measurement Uncertainties stated were calculated in accordance with the requirements of measurement uncertainty contained in CISPR 16-4-2 with the confidence level of 95%

1. Conducted Uncertainty Calculation

Source of Uncertainty	X_i	Uncertainty of X_i		Coverage factor k	$u(X_i)$ (dB)	C_i	$C_i u(X_i)$ (dB)
		Value (dB)	Probability Distribution				
Receiver reading	RI	± 0.1	normal 1	1.000	0.1	1	0.1
Attenuation AMN-Receiver	LC	± 0.08	normal 2	2.000	0.04	1	0.04
AMN Voltage division factor	LAMN	± 0.8	normal 2	2.000	0.4	1	0.4
Sine wave voltage	dVSW	± 2.00	normal 2	2.000	1.00	1	1.00
Pulse amplitude response	dVPA	± 1.50	rectangular	1.732	0.87	1	0.87
Pulse repetition rate response	dVPR	± 1.50	rectangular	1.732	0.87	1	0.87
Noise floor proximity	dVNF	± 0.00	-	-	0.00	1	0.00
AMN Impedance	dZ	± 1.80	triangular	2.449	0.73	1	0.73
Ⓐ Mismatch	M	+ 0.70	U-Shaped	1.414	0.49	1	0.49
Ⓑ Mismatch	M	- 0.80	U-Shaped	1.414	- 0.56	1	- 0.56
Measurement System Repeatability	RS	0.05	normal 1	1.000	0.05	1	0.05
Remark	Ⓐ: AMN-Receiver Mismatch : + Ⓑ: AMN-Receiver Mismatch : -						
Combined Standard Uncertainty	Normal			± 1.88			
Expanded Uncertainty U	Normal ($k = 2$)			± 3.76			

2. Radiation Uncertainty Calculation

Source of Uncertainty	X_i	Uncertainty of X_i		Coverage factor k	$u(X_i)$ (dB)	C_i	$C_i u(X_i)$ (dB)
		Value (dB)	Probability Distribution				
Measurement System Repeatability	RS	0.34	normal 1	1.00	0.34	1	0.34
Receiver reading	Ri	± 0.02	normal 2	2.00	0.01	1	0.01
Sine wave voltage	dVsw	± 0.17	normal 2	2.00	0.09	1	0.09
Pulse amplitude response	dVpa	± 0.92	normal 2	2.00	0.46	1	0.46
Pulse repetition rate response	dVpr	± 0.35	normal 2	2.00	0.18	1	0.18
Noise floor proximity	dVnf	± 0.50	normal 2	2.00	0.25	1	0.25
Antenna Factor Calibration	AF	± 2.00	rectangular	$\sqrt{3}$	1.15	1	1.15
Cable Loss	CL	± 1.00	normal 2	2.00	0.50	1	0.50
Antenna Directivity	AD	± 0.00	rectangular	$\sqrt{3}$	0.00	1	0.00
Antenna Factor Height Dependence	AH	± 2.00	rectangular	$\sqrt{3}$	1.15	1	1.15
Antenna Phase Centre Variation	AP	± 0.20	rectangular	$\sqrt{3}$	0.12	1	0.12
Antenna Factor Frequency Interpolation	Ai	± 0.25	rectangular	$\sqrt{3}$	0.14	1	0.14
Site Imperfections	Si	± 4.00	triangular	$\sqrt{6}$	1.63	1	1.63
Measurement Distance Variation	DV	± 0.60	rectangular	$\sqrt{3}$	0.35	1	0.35
Antenna Balance	Dbal	± 0.90	rectangular	$\sqrt{3}$	0.52	1	0.52
Cross Polarisation	DCross	± 0.00	rectangular	$\sqrt{3}$	0.00	1	0.18
Mismatch	M	+ 0.98 - 1.11	U-Shaped	$\sqrt{2}$	0.74	1	0.74
EUT Volume Diameter	Vd	0.33	normal 1	1.00	0.33	1	0.11
Remark							
Combined Standard Uncertainty	Normal						
Expanded Uncertainty U	Normal ($k = 2$)						