

FCC SAR Test Report

Report No. : W7L-P21090018SA01
 Applicant : MUNIC
 Address : 100 Avenue de Stalingrad 94800 Villejuif – France
 Product : telematics embedded system
 FCC ID : A6GC4D-4G4USV8
 Brand : MUNIC
 Model No. : C4D-4G4USAA_V8+
 Standards : FCC 47 CFR Part 2 (2.1093) / IEEE C95.1:1992 / IEEE 1528:2013
 KDB 865664 D01 v01r04 / KDB 865664 D02 v01r02 / KDB 248227 D01 v02r02
 KDB 447498 D01 v06 / KDB 941225 D05 v02r05
 Sample Received Date : Oct. 10, 2021
 Date of Testing : Oct. 13, 2021 ~ Oct. 19, 2021
 FCC Designation No. : CN1171

CERTIFICATION: The above equipment have been tested by **BV 7LAYERS COMMUNICATIONS TECHNOLOGY (SHENZHEN) CO. LTD.**, and found compliance with the requirement of the above standards. The test record, data evaluation & Equipment Under Test (EUT) configurations represented herein are true and accurate accounts of the measurements of the sample’s SAR characteristics under the conditions specified in this report. It should not be reproduced except in full, without the written approval of our laboratory. The client should not use it to claim product certification, approval, or endorsement by A2LA or any government agencies.

Prepared By : Jerry Chen
 Jerry Chen / Engineer



Approved By : Luke Lu
 Luke Lu / Manager

This report is governed by, and incorporates by reference, CPS Conditions of Service as posted at the date of issuance of this report at <http://www.bureauveritas.com/home/about-us/our-business/cps/about-us/terms-conditions> and is intended for your exclusive use. Any copying or replication of this report to or for any other person or entity, or use of our name or trademark, is permitted only with our prior written permission. This report sets forth our findings solely with respect to the test samples identified herein. The results set forth in this report are not indicative or representative of the quality or characteristics of the lot from which a test sample was taken or any similar or identical product unless specifically and expressly noted. Our report includes all of the tests requested by you and the results thereof based upon the information that you provided to us. Measurement uncertainty is only provided upon request for accredited tests. You have 60 days from date of issuance of this report to notify us of any material error or omission caused by our negligence or if you require measurement uncertainty; provided, however, that such notice shall be in writing and shall specifically address the issue you wish to raise. A failure to raise such issue within the prescribed time shall constitute your unqualified acceptance of the completeness of this report, the tests conducted and the correctness of the report contents.

Table of Contents

Release Control Record	3
1. Summary of Maximum SAR Value	4
2. Description of Equipment Under Test	5
3. SAR Measurement System	6
3.1 Definition of Specific Absorption Rate (SAR)	6
3.2 SPEAG DASY System	6
3.2.1 Robot.....	7
3.2.2 Probes.....	8
3.2.3 Data Acquisition Electronics (DAE)	8
3.2.4 Phantoms	9
3.2.5 Device Holder.....	10
3.2.6 System Validation Dipoles	10
3.2.7 Tissue Simulating Liquids.....	11
3.3 SAR System Verification	14
3.4 SAR Measurement Procedure	15
3.4.1 Area & Zoom Scan Procedure	15
3.4.2 Volume Scan Procedure.....	15
3.4.3 Power Drift Monitoring.....	16
3.4.4 Spatial Peak SAR Evaluation	16
3.4.5 SAR Averaged Methods	16
4. SAR Measurement Evaluation	17
4.1 EUT Configuration and Setting.....	17
4.2 EUT Testing Position	20
4.2.1 Body Exposure Conditions	20
4.2.2 Extremity Exposure Conditions	20
4.3 Tissue Verification	21
4.4 System Verification.....	21
4.5 Maximum Output Power.....	22
4.5.1 Maximum Conducted Power	22
4.5.2 Measured Conducted Power Result.....	23
4.6 SAR Testing Results	33
4.6.1 SAR Test Reduction Considerations	33
4.6.2 SAR Results for Body Exposure Condition (Separation Distance is 1.5 cm Gap)	35
4.6.3 SAR Results for Extremity Exposure Condition (Separation Distance is 0 cm Gap)	37
4.6.4 SAR Measurement Variability.....	39
4.6.5 Simultaneous Multi-band Transmission Evaluation	40
5. Calibration of Test Equipment.....	43
6. Measurement Uncertainty	44
7. Information on the Testing Laboratories	46
Appendix A. SAR Plots of System Verification	
Appendix B. SAR Plots of SAR Measurement	
Appendix C. Calibration Certificate for Probe and Dipole	
Appendix D. Photographs of EUT and Setup	

1. Summary of Maximum SAR Value

Equipment Class	Mode	Highest Reported Body SAR _{1g} (1.5cm Gap) (W/kg)	Highest Reported Extremity SAR _{10g} (0cm Gap) (W/kg)
PCB	LTE 2	1.31	3.30
	LTE 5	0.11	0.40
	LTE 12	0.42	0.63
	LTE 66 / 4	1.34	3.04
	LTE 71	0.29	0.65
DTS	2.4G WLAN	0.17	0.76
NII	5.2G WLAN	0.19	0.53
	5.8G WLAN	0.46	1.09
DSS	Bluetooth	0.02	0.08
Highest Simultaneous Transmission SAR		1.59	3.78

Note:

- The SAR limit (**Head & Body: SAR_{1g} 1.6 W/kg, Extremity: SAR_{10g} 4.0 W/kg**) for general population / uncontrolled exposure is specified in FCC 47 CFR part 2 (2.1093) and ANSI/IEEE C95.1-1992.

2. Description of Equipment Under Test

EUT Type	telematics embedded system
FCC ID	A6GC4D-4G4USV8
Brand Name	MUNIC
Model Name	C4D-4G4USAA_V8+
HW Version	HW.01
SW Version	SW.01
Tx Frequency Bands (Unit: MHz)	LTE Band 2 : 1850.7 ~ 1909.3 (1.4M), 1851.5 ~ 1908.5 (3M), 1852.5 ~ 1907.5 (5M), 1855 ~ 1905 (10M), 1857.5 ~ 1902.5 (15M), 1860 ~ 1900 (20M) LTE Band 4 : 1710.7 ~ 1754.3 (1.4M), 1711.5 ~ 1753.5 (3M), 1712.5 ~ 1752.5 (5M), 1715 ~ 1750 (10M), 1717.5 ~ 1747.5 (15M), 1720 ~ 1745 (20M) LTE Band 5 : 824.7 ~ 848.3 (1.4M), 825.5 ~ 847.5 (3M), 826.5 ~ 846.5 (5M), 829 ~ 844 (10M) LTE Band 12 : 699.7 ~ 715.3 (1.4M), 700.5 ~ 714.5 (3M), 701.5 ~ 713.5 (5M), 704 ~ 711 (10M) LTE Band 66 : 1710.7 ~ 1779.3 (1.4M), 1711.5 ~ 1778.5 (3M), 1712.5 ~ 1777.5 (5M), 1715 ~ 1775 (10M), 1717.5 ~ 1772.5 (15M), 1720 ~ 1770 (20M) LTE Band 71 : 665.5 ~ 695.5 (5M), 668 ~ 693 (10M), 670.5 ~ 690.5 (15M), 673 ~ 688 (20M) WLAN : 2412 ~ 2462, 5180 ~ 5240, 5745 ~ 5825 Bluetooth : 2402 ~ 2480
Uplink Modulations	WCDMA : QPSK LTE : QPSK, 16QAM 802.11b : DSSS 802.11a/g/n/ac : OFDM Bluetooth : GFSK, $\pi/4$ -DQPSK, 8-DPSK
Maximum Tune-up Conducted Power (Unit: dBm)	Please refer to section 4.5.1 of this report.
Antenna Type	WLAN / BT: PIFA Antenna WWAN: Fixed Internal Antenna
EUT Stage	Identical Prototype

Note:

1. The above EUT information is declared by manufacturer and for more detailed features description please refers to the manufacturer's specifications or User's Manual.
2. This device supports both LTE B4 and B66. Since the supported frequency span for LTE B4 falls completely within the B66 · they have the same target power, and share the same transmission path, therefore SAR was only assessed for LTE B66.

3. SAR Measurement System

3.1 Definition of Specific Absorption Rate (SAR)

SAR is related to the rate at which energy is absorbed per unit mass in an object exposed to a radio field. The SAR distribution in a biological body is complicated and is usually carried out by experimental techniques or numerical modeling. The standard recommends limits for two tiers of groups, occupational/controlled and general population/uncontrolled, based on a person's awareness and ability to exercise control over his or her exposure. In general, occupational/controlled exposure limits are higher than the limits for general population/uncontrolled.

The SAR definition is the time derivative (rate) of the incremental energy (dW) absorbed by (dissipated in) an incremental mass (dm) contained in a volume element (dv) of a given density (ρ). The equation description is as below:

$$\text{SAR} = \frac{d}{dt} \left(\frac{dW}{dm} \right) = \frac{d}{dt} \left(\frac{dW}{\rho dv} \right)$$

SAR is expressed in units of Watts per kilogram (W/kg)

SAR measurement can be related to the electrical field in the tissue by

$$\text{SAR} = \frac{\sigma |E|^2}{\rho}$$

Where: σ is the conductivity of the tissue, ρ is the mass density of the tissue and E is the RMS electrical field strength.

3.2 SPEAG DASY System

DASY system consists of high precision robot, probe alignment sensor, phantom, robot controller, controlled measurement server and near-field probe. The robot includes six axes that can move to the precision position of the DASY5 software defined. The DASY software can define the area that is detected by the probe. The robot is connected to controlled box. Controlled measurement server is connected to the controlled robot box. The DAE includes amplifier, signal multiplexing, AD converter, offset measurement and surface detection. It is connected to the Electro-optical coupler (ECO). The ECO performs the conversion from the optical into digital electric signal of the DAE and transfers data to the PC.

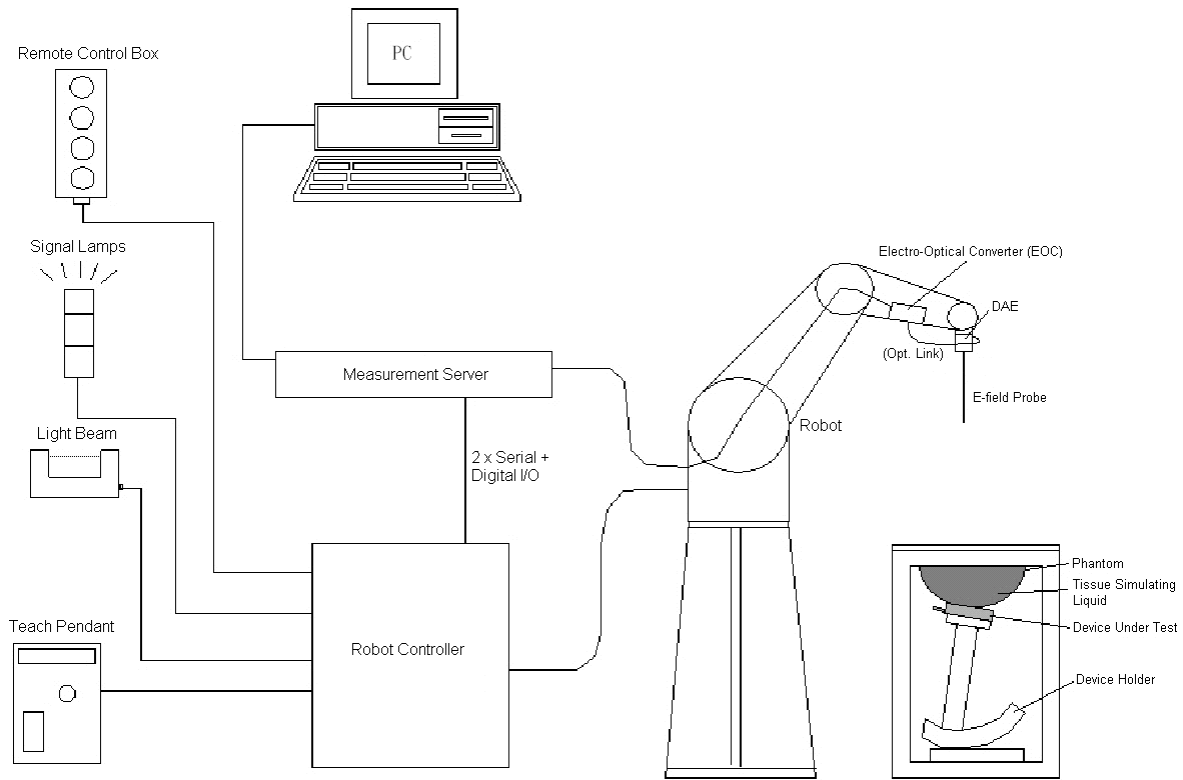

Fig-3.1 DASY System Setup

3.2.1 Robot

The DASY system uses the high precision robots from Stäubli SA (France). For the 6-axis controller system, the robot controller version (DASY5: CS8c) from Stäubli is used. The Stäubli robot series have many features that are important for our application:

- High precision (repeatability ± 0.035 mm)
- High reliability (industrial design)
- Jerk-free straight movements
- Low ELF interference (the closed metallic construction shields against motor control fields)





Fig-3.2 DASY5

FCC SAR Test Report

3.2.2 Probes

The SAR measurement is conducted with the dosimetric probe. The probe is specially designed and calibrated for use in liquid with high permittivity. The dosimetric probe has special calibration in liquid at different frequency.

Model	EX3DV4	
Construction	Symmetrical design with triangular core. Built-in shielding against static charges. PEEK enclosure material (resistant to organic solvents, e.g., DGBE).	
Frequency	10 MHz to 6 GHz Linearity: ± 0.2 dB	
Directivity	± 0.3 dB in HSL (rotation around probe axis) ± 0.5 dB in tissue material (rotation normal to probe axis)	
Dynamic Range	10 μ W/g to 100 mW/g Linearity: ± 0.2 dB (noise: typically < 1 μ W/g)	
Dimensions	Overall length: 337 mm (Tip: 20 mm) Tip diameter: 2.5 mm (Body: 12 mm) Typical distance from probe tip to dipole centers: 1 mm	

Model	ES3DV3	
Construction	Symmetrical design with triangular core. Interleaved sensors. Built-in shielding against static charges. PEEK enclosure material (resistant to organic solvents, e.g., DGBE).	
Frequency	10 MHz to 4 GHz Linearity: ± 0.2 dB	
Directivity	± 0.2 dB in HSL (rotation around probe axis) ± 0.3 dB in tissue material (rotation normal to probe axis)	
Dynamic Range	5 μ W/g to 100 mW/g Linearity: ± 0.2 dB	
Dimensions	Overall length: 337 mm (Tip: 20 mm) Tip diameter: 3.9 mm (Body: 12 mm) Distance from probe tip to dipole centers: 2.0 mm	

3.2.3 Data Acquisition Electronics (DAE)

Model	DAE3, DAE4	
Construction	Signal amplifier, multiplexer, A/D converter and control logic. Serial optical link for communication with DASY embedded system (fully remote controlled). Two step probe touch detector for mechanical surface detection and emergency robot stop.	
Measurement Range	-100 to +300 mV (16 bit resolution and two range settings: 4mV, 400mV)	
Input Offset Voltage	< 5 μ V (with auto zero)	
Input Bias Current	< 50 fA	
Dimensions	60 x 60 x 68 mm	

3.2.4 Phantoms

Model	Twin SAM	
Construction	The shell corresponds to the specifications of the Specific Anthropomorphic Mannequin (SAM) phantom defined in IEEE 1528 and IEC 62209-1. It enables the dosimetric evaluation of left and right hand phone usage as well as body mounted usage at the flat phantom region. A cover prevents evaporation of the liquid. Reference markings on the phantom allow the complete setup of all predefined phantom positions and measurement grids by teaching three points with the robot.	
Material	Vinylester, glass fiber reinforced (VE-GF)	
Shell Thickness	2 ± 0.2 mm (6 ± 0.2 mm at ear point)	
Dimensions	Length: 1000 mm Width: 500 mm Height: adjustable feet	
Filling Volume	approx. 25 liters	

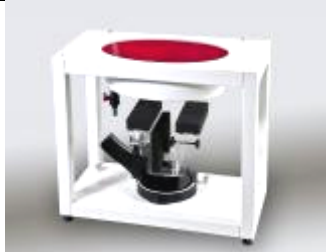
Model	ELI	
Construction	Phantom for compliance testing of handheld and body-mounted wireless devices in the frequency range of 30 MHz to 6 GHz. ELI is fully compatible with the IEC 62209-2 standard and all known tissue simulating liquids. ELI has been optimized regarding its performance and can be integrated into our standard phantom tables. A cover prevents evaporation of the liquid. Reference markings on the phantom allow installation of the complete setup, including all predefined phantom positions and measurement grids, by teaching three points. The phantom is compatible with all SPEAG dosimetric probes and dipoles.	
Material	Vinylester, glass fiber reinforced (VE-GF)	
Shell Thickness	2.0 ± 0.2 mm (bottom plate)	
Dimensions	Major axis: 600 mm Minor axis: 400 mm	
Filling Volume	approx. 30 liters	

FCC SAR Test Report

3.2.5 Device Holder

Model	Mounting Device	
Construction	In combination with the Twin SAM Phantom or ELI4, the Mounting Device enables the rotation of the mounted transmitter device in spherical coordinates. Rotation point is the ear opening point. Transmitter devices can be easily and accurately positioned according to IEC, IEEE, FCC or other specifications. The device holder can be locked for positioning at different phantom sections (left head, right head, flat).	
Material	POM	

Model	Laptop Extensions Kit	
Construction	Simple but effective and easy-to-use extension for Mounting Device that facilitates the testing of larger devices according to IEC 62209-2 (e.g., laptops, cameras, etc.). It is lightweight and fits easily on the upper part of the Mounting Device in place of the phone positioner.	
Material	POM, Acrylic glass, Foam	

3.2.6 System Validation Dipoles

Model	D-Serial	
Construction	Symmetrical dipole with 1/4 balun. Enables measurement of feed point impedance with NWA. Matched for use near flat phantoms filled with tissue simulating solutions.	
Frequency	750 MHz to 5800 MHz	
Return Loss	> 20 dB	
Power Capability	> 100 W (f < 1GHz), > 40 W (f > 1GHz)	

3.2.7 Tissue Simulating Liquids

For SAR measurement of the field distribution inside the phantom, the phantom must be filled with homogeneous tissue simulating liquid to a depth of at least 15 cm. For head SAR testing, the liquid height from the ear reference point (ERP) of the phantom to the liquid top surface is larger than 15 cm. For body SAR testing, the liquid height from the center of the flat phantom to the liquid top surface is larger than 15 cm. The nominal dielectric values of the tissue simulating liquids in the phantom and the tolerance of 5% are listed in Table-3.1.

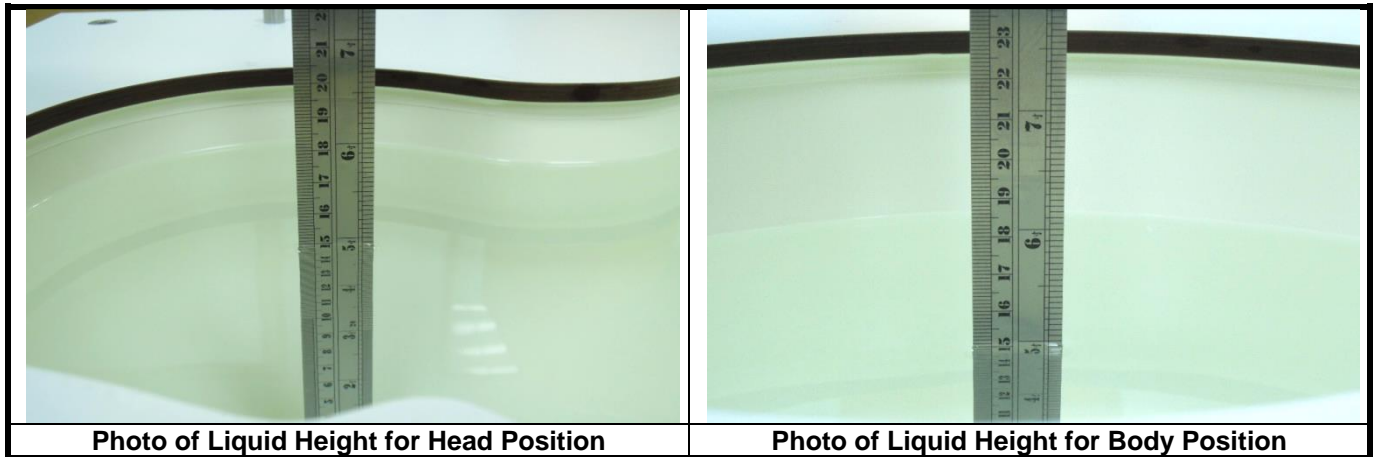

The dielectric properties of the head tissue simulating liquids are defined in IEEE 1528, and KDB 865664 D01 Appendix A. For the body tissue simulating liquids, the dielectric properties are defined in KDB 865664 D01 Appendix A. The dielectric properties of the tissue simulating liquids were verified prior to the SAR evaluation using a dielectric assessment kit and a network analyzer.

Table-3.1 Targets of Tissue Simulating Liquid

Frequency (MHz)	Target Permittivity	Range of $\pm 5\%$	Target Conductivity	Range of $\pm 5\%$
For Head				
750	41.9	39.8 ~ 44.0	0.89	0.85 ~ 0.93
835	41.5	39.4 ~ 43.6	0.90	0.86 ~ 0.95
900	41.5	39.4 ~ 43.6	0.97	0.92 ~ 1.02
1450	40.5	38.5 ~ 42.5	1.20	1.14 ~ 1.26
1640	40.3	38.3 ~ 42.3	1.29	1.23 ~ 1.35
1750	40.1	38.1 ~ 42.1	1.37	1.30 ~ 1.44
1800	40.0	38.0 ~ 42.0	1.40	1.33 ~ 1.47
1900	40.0	38.0 ~ 42.0	1.40	1.33 ~ 1.47
2000	40.0	38.0 ~ 42.0	1.40	1.33 ~ 1.47
2300	39.5	37.5 ~ 41.5	1.67	1.59 ~ 1.75
2450	39.2	37.2 ~ 41.2	1.80	1.71 ~ 1.89
2600	39.0	37.1 ~ 41.0	1.96	1.86 ~ 2.06
3500	37.9	36.0 ~ 39.8	2.91	2.76 ~ 3.06
5200	36.0	34.2 ~ 37.8	4.66	4.43 ~ 4.89
5300	35.9	34.1 ~ 37.7	4.76	4.52 ~ 5.00
5500	35.6	33.8 ~ 37.4	4.96	4.71 ~ 5.21
5600	35.5	33.7 ~ 37.3	5.07	4.82 ~ 5.32
5800	35.3	33.5 ~ 37.1	5.27	5.01 ~ 5.53

FCC SAR Test Report

The following table gives the recipes for tissue simulating liquids.

Table-3.2 Recipes of Tissue Simulating Liquid

Tissue Type	Bactericide	DGBE	HEC	NaCl	Sucrose	Triton X-100	Water	Diethylene Glycol Mono-hexylether
H750	0.2	-	0.2	1.5	56.0	-	42.1	-
H835	0.2	-	0.2	1.5	57.0	-	41.1	-
H900	0.2	-	0.2	1.4	58.0	-	40.2	-
H1450	-	43.3	-	0.6	-	-	56.1	-
H1640	-	45.8	-	0.5	-	-	53.7	-
H1750	-	47.0	-	0.4	-	-	52.6	-
H1800	-	44.5	-	0.3	-	-	55.2	-
H1900	-	44.5	-	0.2	-	-	55.3	-
H2000	-	44.5	-	0.1	-	-	55.4	-
H2300	-	44.9	-	0.1	-	-	55.0	-
H2450	-	45.0	-	0.1	-	-	54.9	-
H2600	-	45.1	-	0.1	-	-	54.8	-
H3500	-	8.0	-	0.2	-	20.0	71.8	-
H5G	-	-	-	-	-	17.2	65.5	17.3

3.3 SAR System Verification

The system check verifies that the system operates within its specifications. It is performed daily or before every SAR measurement. The system check uses normal SAR measurements in the flat section of the phantom with a matched dipole at a specified distance. The system verification setup is shown as below.

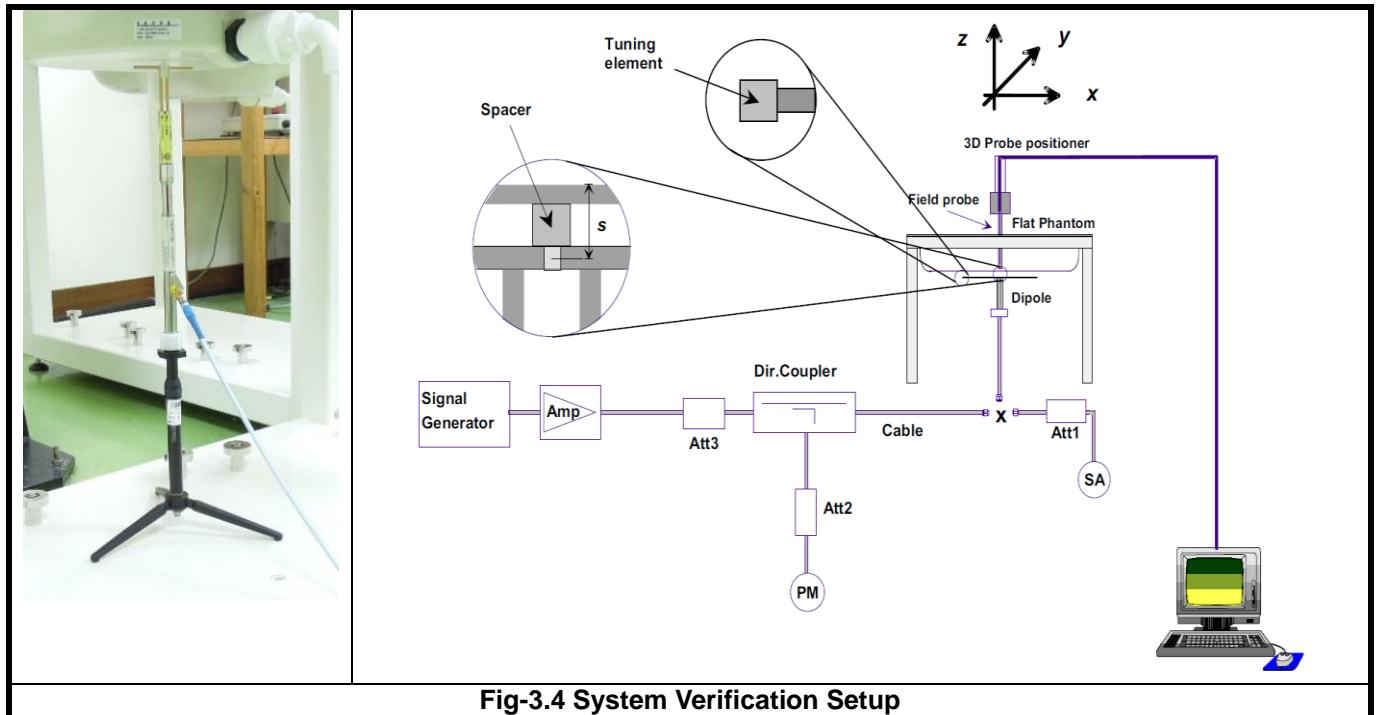

Fig-3.4 System Verification Setup

The validation dipole is placed beneath the flat phantom with the specific spacer in place. The distance spacer is touch the phantom surface with a light pressure at the reference marking and be oriented parallel to the long side of the phantom. The spectrum analyzer measures the forward power at the location of the system check dipole connector. The signal generator is adjusted for the desired forward power (250 mW is used for 700 MHz to 3 GHz, 100 mW is used for 3.5 GHz to 6 GHz) at the dipole connector and the power meter is read at that level. After connecting the cable to the dipole, the signal generator is readjusted for the same reading at power meter.

After system check testing, the SAR result will be normalized to 1W forward input power and compared with the reference SAR value derived from validation dipole certificate report. The deviation of system check should be within 10 %.

3.4 SAR Measurement Procedure

According to the SAR test standard, the recommended procedure for assessing the peak spatial-average SAR value consists of the following steps:

- (a) Power reference measurement
- (b) Area scan
- (c) Zoom scan
- (d) Power drift measurement

The SAR measurement procedures for each of test conditions are as follows:

- (a) Make EUT to transmit maximum output power
- (b) Measure conducted output power through RF cable
- (c) Place the EUT in the specific position of phantom
- (d) Perform SAR testing steps on the DASY system
- (e) Record the SAR value

3.4.1 Area & Zoom Scan Procedure

First Area Scan is used to locate the approximate location(s) of the local peak SAR value(s). The measurement grid within an Area Scan is defined by the grid extent, grid step size and grid offset. Next, in order to determine the EM field distribution in a three-dimensional spatial extension, Zoom Scan is required. The Zoom Scan is performed around the highest E-field value to determine the averaged SAR-distribution over 10 g. According to KDB 865664 D01, the resolution for Area and Zoom scan is specified in the table below.

Items	<= 2 GHz	2-3 GHz	3-4 GHz	4-5 GHz	5-6 GHz
Area Scan ($\Delta x, \Delta y$)	<= 15 mm	<= 12 mm	<= 12 mm	<= 10 mm	<= 10 mm
Zoom Scan ($\Delta x, \Delta y$)	<= 8 mm	<= 5 mm	<= 5 mm	<= 4 mm	<= 4 mm
Zoom Scan (Δz)	<= 5 mm	<= 5 mm	<= 4 mm	<= 3 mm	<= 2 mm
Zoom Scan Volume	>= 30 mm	>= 30 mm	>= 28 mm	>= 25 mm	>= 22 mm

Note:

When zoom scan is required and report SAR is <= 1.4 W/kg, the zoom scan resolution of $\Delta x / \Delta y$ (2-3GHz: <= 8 mm, 3-4GHz: <= 7 mm, 4-6GHz: <= 5 mm) may be applied.

3.4.2 Volume Scan Procedure

The volume scan is used for assess overlapping SAR distributions for antennas transmitting in different frequency bands. It is equivalent to an oversized zoom scan used in standalone measurements. The measurement volume will be used to enclose all the simultaneous transmitting antennas. For antennas transmitting simultaneously in different frequency bands, the volume scan is measured separately in each frequency band. In order to sum correctly to compute the 1g aggregate SAR, the EUT remain in the same test position for all measurements and all volume scan use the same spatial resolution and grid spacing. When all volume scan were completed, the software, SEMCAD postprocessor can combine and subsequently superpose these measurement data to calculating the multiband SAR.

3.4.3 Power Drift Monitoring

All SAR testing is under the EUT install full charged battery and transmit maximum output power. In DASY measurement software, the power reference measurement and power drift measurement procedures are used for monitoring the power drift of EUT during SAR test. Both these procedures measure the field at a specified reference position before and after the SAR testing. The software will calculate the field difference in dB. If the power drift more than 5%, the SAR will be retested.

3.4.4 Spatial Peak SAR Evaluation

The procedure for spatial peak SAR evaluation has been implemented according to the test standard. It can be conducted for 1g and 10g, as well as for user-specific masses. The DASY software includes all numerical procedures necessary to evaluate the spatial peak SAR value.

The base for the evaluation is a "cube" measurement. The measured volume must include the 1g and 10g cubes with the highest averaged SAR values. For that purpose, the center of the measured volume is aligned to the interpolated peak SAR value of a previously performed area scan.

The entire evaluation of the spatial peak values is performed within the post-processing engine (SEMCAD). The system always gives the maximum values for the 1g and 10g cubes. The algorithm to find the cube with highest averaged SAR is divided into the following stages:

- (a) Extraction of the measured data (grid and values) from the Zoom Scan
- (b) Calculation of the SAR value at every measurement point based on all stored data (A/D values and measurement parameters)
- (c) Generation of a high-resolution mesh within the measured volume
- (d) Interpolation of all measured values from the measurement grid to the high-resolution grid
- (e) Extrapolation of the entire 3-D field distribution to the phantom surface over the distance from sensor to surface
- (f) Calculation of the averaged SAR within masses of 1g and 10g

3.4.5 SAR Averaged Methods

In DASY, the interpolation and extrapolation are both based on the modified Quadratic Shepard's method. The interpolation scheme combines a least-square fitted function method and a weighted average method which are the two basic types of computational interpolation and approximation.

Extrapolation routines are used to obtain SAR values between the lowest measurement points and the inner phantom surface. The extrapolation distance is determined by the surface detection distance and the probe sensor offset. The uncertainty increases with the extrapolation distance. To keep the uncertainty within 1% for the 1 g and 10 g cubes, the extrapolation distance should not be larger than 5 mm.

4. SAR Measurement Evaluation

4.1 EUT Configuration and Setting

<Connections between EUT and System Simulator>

For WWAN SAR testing, the EUT was linked and controlled by base station emulator (Agilent E5515C is used for GSM/WCDMA/CDMA, and Anritsu MT8820C is used for LTE). Communication between the EUT and the emulator was established by air link. The distance between the EUT and the communicating antenna of the emulator is larger than 50 cm and the output power radiated from the emulator antenna is at least 30 dB smaller than the output power of EUT. The EUT was set from the emulator to radiate maximum output power during SAR testing.

<Considerations Related to LTE for Setup and Testing>

This device contains LTE transmitter which follows 3GPP standards, is category 4, supports both QPSK and 16QAM modulations, and supported LTE band and channel bandwidth is listed in below. The output power was tested per 3GPP TS 36.521-1 maximum transmit procedures for both QPSK and 16QAM modulation. The results please refer to section 4.6 of this report.

EUT Supported LTE Band and Channel Bandwidth						
LTE Band	BW 1.4 MHz	BW 3 MHz	BW 5 MHz	BW 10 MHz	BW 15 MHz	BW 20 MHz
2	V	V	V	V	V	V
4	V	V	V	V	V	V
5	V	V	V	V		
12	V	V	V	V		
66	V	V	V	V	V	V
71			V	V	V	V

The LTE maximum power reduction (MPR) in accordance with 3GPP TS 36.101 is active all times during LTE operation. The allowed MPR for the maximum output power is specified in below.

Modulation	Channel Bandwidth / RB Configurations						LTE MPR Setting (dB)
	BW 1.4 MHz	BW 3 MHz	BW 5 MHz	BW 10 MHz	BW 15 MHz	BW 20 MHz	
QPSK	> 5	> 4	> 8	> 12	> 16	> 18	1
16QAM	<= 5	<= 4	<= 8	<= 12	<= 16	<= 18	1
16QAM	> 5	> 4	> 8	> 12	> 16	> 18	2

Note: MPR is according to the standard and implemented in the circuit (mandatory).

In addition, the device is compliant with additional maximum power reduction (A-MPR) requirements defined in 3GPP TS 36.101 section 6.2.4 that was disabled for all FCC compliance testing.

During LTE SAR testing, the related parameters of operating band, channel bandwidth, uplink channel number, modulation type, and RB was set in base station simulator. When the EUT has registered and communicated to base station simulator, the simulator set to make EUT transmitting the maximum radiated power.

<Considerations Related to WLAN for Setup and Testing>

In general, various vendor specific external test software and chipset based internal test modes are typically used for SAR measurement. These chipset based test mode utilities are generally hardware and manufacturer dependent, and often include substantial flexibility to reconfigure or reprogram a device. A Wi-Fi device must be configured to transmit continuously at the required data rate, channel bandwidth and signal modulation, using the highest transmission duty factor supported by the test mode tools for SAR measurement. The test frequencies established using test mode must correspond to the actual channel frequencies. When 802.11 frame gaps are accounted for in the transmission, a maximum transmission duty factor of 92 - 96% is typically achievable in most test mode configurations. A minimum transmission duty factor of 85% is required to avoid certain hardware and device implementation issues related to wide range SAR scaling. In addition, a periodic transmission duty factor is required for current generation SAR systems to measure SAR correctly. The reported SAR must be scaled to 100% transmission duty factor to determine compliance at the maximum tune-up tolerance limit.

According to KDB 248227 D01, this device has installed WLAN engineering testing software which can provide continuous transmitting RF signal. During WLAN SAR testing, this device was operated to transmit continuously at the maximum transmission duty with specified transmission mode, operating frequency, lowest data rate, and maximum output power.

Initial Test Configuration

An initial test configuration is determined for OFDM transmission modes in 2.4 GHz and 5 GHz bands according to the channel bandwidth, modulation and data rate combination(s) with the highest maximum output power specified for production units in each standalone and aggregated frequency band. When the same maximum power is specified for multiple transmission modes in a frequency band, the largest channel bandwidth, lowest order modulation, lowest data rate and lowest order 802.11a/g/n/ac mode is used for SAR measurement, on the highest measured output power channel in the initial test configuration, for each frequency band.

Subsequent Test Configuration

SAR measurement requirements for the remaining 802.11 transmission mode configurations that have not been tested in the initial test configuration are determined separately for each standalone and aggregated frequency band, in each exposure condition, according to the maximum output power specified for production units. Additional power measurements may be required to determine if SAR measurements are required for subsequent highest output power channels in a subsequent test configuration. When the highest reported SAR for the initial test configuration according to the initial test position or fixed exposure position requirements, is adjusted by the ratio of the subsequent test configuration to initial test configuration specified maximum output power and the adjusted SAR is ≤ 1.2 W/kg, SAR is not required for that subsequent test configuration.

SAR Test Configuration and Channel Selection

When multiple channel bandwidth configurations in a frequency band have the same specified maximum output power, the initial test configuration is using largest channel bandwidth, lowest order modulation, lowest data rate, and lowest order 802.11 mode (i.e., 802.11a is chosen over 802.11n then 802.11ac or 802.11g is chosen over 802.11n). After an initial test configuration is determined, if multiple test channels have the same measured maximum output power, the channel chosen for SAR measurement is determined according to the following.

1) The channel closest to mid-band frequency is selected for SAR measurement.

FCC SAR Test Report

2) For channels with equal separation from mid-band frequency; for example, high and low channels or two mid-band channels, the higher frequency (number) channel is selected for SAR measurement.

Test Reduction for U-NII-1 (5.2 GHz) and U-NII-2A (5.3 GHz) Bands

For devices that operate in both U-NII bands using the same transmitter and antenna(s), SAR test reduction is determined according to the following.

- 1) When the same maximum output power is specified for both bands, begin SAR measurement in U-NII-2A band by applying the OFDM SAR requirements. If the highest reported SAR for a test configuration is ≤ 1.2 W/kg, SAR is not required for U-NII-1 band for that configuration (802.11 mode and exposure condition).
- 2) When different maximum output power is specified for the bands, begin SAR measurement in the band with higher specified maximum output power. The highest reported SAR for the tested configuration is adjusted by the ratio of lower to higher specified maximum output power for the two bands. When the adjusted SAR is ≤ 1.2 W/kg, SAR is not required for the band with lower maximum output power in that test configuration.

<Considerations Related to Bluetooth for Setup and Testing>

This device has installed Bluetooth engineering testing software which can provide continuous transmitting RF signal. During Bluetooth SAR testing, this device was operated to transmit continuously at the maximum transmission duty with specified transmission mode, operating frequency, lowest data rate, and maximum output power.

<Duty Cycle of Test Signal>

BT

GFSK: Duty cycle = $2.87 / 3.74 = 0.7673$

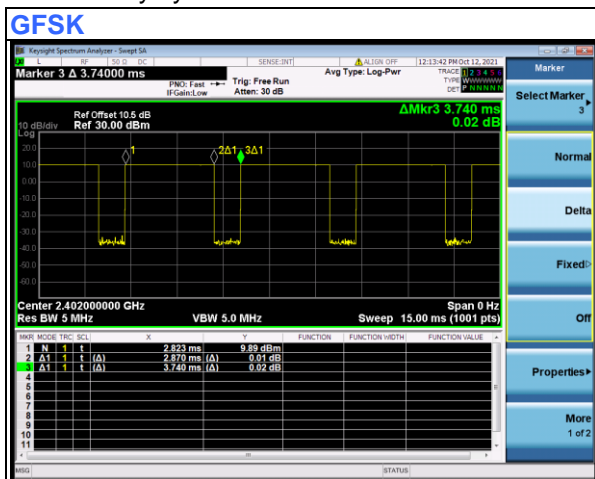

4.2 EUT Testing Position

4.2.1 Body Exposure Conditions

This EUT was tested for five surfaces of the EUT as Front Face, Rear Face, Left Side, Right Side and Top Side. The separation distance between this EUT and phantom is 1.5 cm.

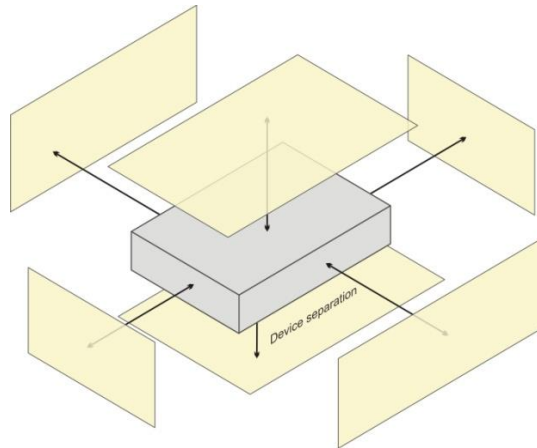

4.2.2 Extremity Exposure Conditions

Devices that are designed or intended for use on extremities or mainly operated in extremity only exposure conditions; i.e., hands, wrists, feet and ankles, may require extremity SAR evaluation. When the device also operates in close proximity to the user's body, SAR compliance for the body is also required. When extremity SAR testing is required, a flat phantom must be used if the exposure condition is more conservative than the actual use conditions; otherwise, a KDB inquiry is required to determine the phantom and test requirements. Body SAR compliance is also tested with a flat phantom. For devices with irregular shapes or form factors that do not conform to a flat phantom, and/or unusual operating configurations and exposure conditions, a KDB inquiry is also required to determine the appropriate SAR measurement procedures.

4.3 Tissue Verification

The measuring results for tissue simulating liquid are shown as below.

Test Date	Tissue Type	Frequency (MHz)	Liquid Temp. (°C)	Measured Conductivity (σ)	Measured Permittivity (ε _r)	Target Conductivity (σ)	Target Permittivity (ε _r)	Conductivity Deviation (%)	Permittivity Deviation (%)
Oct. 13, 2021	Head	750	22.5	0.882	40.513	0.89	41.90	-0.90	-3.31
Oct. 14, 2021	Head	835	22.7	0.906	41.947	0.90	41.50	0.67	1.08
Oct. 15, 2021	Head	1750	22.8	1.345	40.248	1.37	40.10	-1.82	0.37
Oct. 16, 2021	Head	1900	22.6	1.430	39.948	1.40	40.00	2.14	-0.13
Oct. 17, 2021	Head	2450	22.7	1.786	39.390	1.80	39.20	-0.78	0.48
Oct. 18, 2021	Head	5250	22.6	4.638	37.088	4.71	35.90	-1.53	3.31
Oct. 19, 2021	Head	5800	22.8	5.276	36.199	5.27	35.30	0.11	2.55

Note:

The dielectric properties of the tissue simulating liquid must be measured within 24 hours before the SAR testing and within ±10% of the target values. Liquid temperature during the SAR testing must be within ±2 °C.

4.4 System Verification

The measuring result for system verification is tabulated as below.

Test Date	Mode	Frequency (MHz)	1W Target SAR-1g (W/kg)	Measured SAR-1g (W/kg)	Normalized to 1W SAR-1g (W/kg)	Deviation (%)	Dipole S/N	Probe S/N	DAE S/N
Oct. 13, 2021	Head	750	8.34	2.10	8.40	0.72	1067	3268	1288
Oct. 14, 2021	Head	835	9.47	2.25	9.00	-4.96	4d139	3268	1288
Oct. 15, 2021	Head	1750	36.60	8.58	34.32	-6.23	1071	3268	1288
Oct. 16, 2021	Head	1900	39.70	9.69	38.76	-2.37	5d159	3268	1288
Oct. 17, 2021	Head	2450	53.60	13.00	52.00	-2.99	893	3268	1288
Oct. 18, 2021	Head	5250	76.90	7.45	74.50	-3.12	1133	3873	905
Oct. 19, 2021	Head	5800	78.00	7.59	75.90	-2.69	1133	3873	905

Note:

Comparing to the reference SAR value provided by SPEAG, the validation data should be within its specification of 10 %. The result indicates the system check can meet the variation criterion and the plots can be referred to Appendix A of this report.

4.5 Maximum Output Power

4.5.1 Maximum Conducted Power

The maximum conducted average power (Unit: dBm) including tune-up tolerance is shown as below.

Mode	LTE 2	LTE 4	LTE 5	LTE 12
QPSK / 16QAM	23.0 / 22.0	23.5 / 22.5	25.0 / 24.0	25.0 / 24.0

Mode	LTE 66	LTE 71
QPSK / 16QAM	23.5 / 22.5	23.5 / 22.5

Mode	2.4G WLAN	5.2G WLAN	5.8G WLAN
802.11b	18.0	N/A	N/A
802.11g	17.5	N/A	N/A
802.11a	N/A	14.5	15.0
802.11n HT20	15.5	14.0	15.0
802.11n HT40	15.0	14.0	14.0
802.11ac VHT20	N/A	13.0	13.0
802.11ac VHT40	N/A	13.0	13.0
802.11ac VHT80	N/A	9.0	13.0

Mode	2.4G Bluetooth
GFSK	9.0
$\pi/4$ -DQPSK	6.0
8-DPSK	6.0
LE	-1.5

4.5.2 Measured Conducted Power Result

The measuring conducted average power (Unit: dBm) is shown as below.

Band / BW	RB Size	RB Offset	QPSK			3GPP MPR (dB)	16QAM			3GPP MPR (dB)
			Low CH 18607	Mid CH 18900	High CH 19193		Low CH 18607	Mid CH 18900	High CH 19193	
			1850.7 MHz	1880.0 MHz	1909.3 MHz		1850.7 MHz	1880.0 MHz	1909.3 MHz	
2 / 1.4M	1	0	21.65	21.59	21.44	0	21.67	21.75	21.47	1
	1	2	21.95	21.86	21.77	0	21.72	21.78	21.57	1
	1	5	21.54	21.43	21.32	0	20.79	21.08	20.69	1
	3	0	21.72	21.64	21.64	0	21.47	21.68	21.30	1
	3	1	21.96	21.87	21.68	0	21.19	21.58	21.08	1
	3	3	21.71	21.62	21.59	0	21.09	21.33	20.96	1
	6	0	20.84	20.69	20.64	1	20.16	20.44	19.93	2

Band / BW	RB Size	RB Offset	QPSK			3GPP MPR (dB)	16QAM			3GPP MPR (dB)
			Low CH 18615	Mid CH 18900	High CH 19185		Low CH 18615	Mid CH 18900	High CH 19185	
			1851.5 MHz	1880.0 MHz	1908.5 MHz		1851.5 MHz	1880.0 MHz	1908.5 MHz	
2 / 3M	1	0	22.50	22.79	22.26	0	21.64	21.81	21.50	1
	1	7	22.24	22.55	22.10	0	21.69	21.76	21.55	1
	1	14	21.86	22.14	21.68	0	20.82	21.08	20.69	1
	8	0	21.31	21.62	21.24	1	20.43	20.69	20.30	2
	8	3	21.31	21.64	21.12	1	20.24	20.53	20.11	2
	8	7	21.12	21.48	21.07	1	20.11	20.31	19.92	2
	15	0	21.20	21.44	20.97	1	20.16	20.38	19.96	2

Band / BW	RB Size	RB Offset	QPSK			3GPP MPR (dB)	16QAM			3GPP MPR (dB)
			Low CH 18625	Mid CH 18900	High CH 19175		Low CH 18625	Mid CH 18900	High CH 19175	
			1852.5 MHz	1880.0 MHz	1907.5 MHz		1852.5 MHz	1880.0 MHz	1907.5 MHz	
2 / 5M	1	0	22.51	22.74	22.27	0	21.65	21.77	21.50	1
	1	12	22.29	22.52	22.10	0	21.66	21.79	21.54	1
	1	24	21.87	22.13	21.72	0	20.82	21.08	20.68	1
	12	0	21.34	21.62	21.21	1	20.43	20.67	20.27	2
	12	6	21.31	21.65	21.13	1	20.21	20.57	20.07	2
	12	13	21.16	21.44	21.08	1	20.06	20.33	19.95	2
	25	0	21.18	21.47	21.00	1	20.16	20.39	19.93	2

FCC SAR Test Report

Band / BW	RB Size	RB Offset	QPSK			3GPP MPR (dB)	16QAM			3GPP MPR (dB)
			Low CH 18650	Mid CH 18900	High CH 19150		Low CH 18650	Mid CH 18900	High CH 19150	
			1855.0 MHz	1880.0 MHz	1905.0 MHz		1855.0 MHz	1880.0 MHz	1905.0 MHz	
2 / 10M	1	0	22.48	22.77	22.27	0	21.65	21.74	21.46	1
	1	24	22.29	22.52	22.11	0	21.71	21.75	21.57	1
	1	49	21.84	22.17	21.68	0	20.82	21.09	20.65	1
	25	0	21.35	21.61	21.24	1	20.45	20.65	20.33	2
	25	12	21.37	21.59	21.13	1	20.25	20.51	20.12	2
	25	25	21.14	21.41	21.07	1	20.05	20.34	19.92	2
	50	0	21.23	21.47	20.97	1	20.20	20.38	19.97	2

Band / BW	RB Size	RB Offset	QPSK			3GPP MPR (dB)	16QAM			3GPP MPR (dB)
			Low CH 18675	Mid CH 18900	High CH 19125		Low CH 18675	Mid CH 18900	High CH 19125	
			1857.5 MHz	1880.0 MHz	1902.5 MHz		1857.5 MHz	1880.0 MHz	1902.5 MHz	
2 / 15M	1	0	22.55	22.77	22.24	0	21.69	21.81	21.46	1
	1	37	22.27	22.57	22.06	0	21.70	21.76	21.57	1
	1	74	21.90	22.20	21.69	0	20.78	21.14	20.67	1
	36	0	21.32	21.62	21.25	1	20.49	20.65	20.34	2
	36	19	21.38	21.64	21.13	1	20.19	20.55	20.08	2
	36	39	21.12	21.42	21.07	1	20.10	20.32	19.95	2
	75	0	21.23	21.45	21.02	1	20.21	20.41	19.90	2

Band / BW	RB Size	RB Offset	QPSK			3GPP MPR (dB)	16QAM			3GPP MPR (dB)
			Low CH 18700	Mid CH 18900	High CH 19100		Low CH 18700	Mid CH 18900	High CH 19100	
			1860.0 MHz	1880.0 MHz	1900.0 MHz		1860.0 MHz	1880.0 MHz	1900.0 MHz	
2 / 20M	1	0	22.56	22.81	22.75	0	21.72	21.82	21.52	1
	1	50	22.31	22.60	22.12	0	21.74	21.81	21.59	1
	1	99	21.92	22.21	21.73	0	20.84	21.16	20.70	1
	50	0	21.38	21.67	21.26	1	20.51	20.73	20.35	2
	50	25	21.39	21.66	21.18	1	20.27	20.59	20.13	2
	50	50	21.20	21.49	21.09	1	20.13	20.38	19.97	2
	100	0	21.24	21.49	21.05	1	20.22	20.46	19.98	2

FCC SAR Test Report

Band / BW	RB Size	RB Offset	QPSK			3GPP MPR (dB)	16QAM			3GPP MPR (dB)
			Low CH 19957	Mid CH 20175	High CH 20393		Low CH 19957	Mid CH 20175	High CH 20393	
			1710.7 MHz	1732.5 MHz	1754.3 MHz		1710.7 MHz	1732.5 MHz	1754.3 MHz	
4 / 1.4M	1	0	22.87	22.47	22.68	0	21.33	20.92	21.15	1
	1	2	22.35	21.92	22.19	0	21.24	20.76	21.11	1
	1	5	22.64	22.19	22.44	0	21.21	20.81	21.13	1
	3	0	22.48	22.06	22.42	0	21.38	20.90	21.23	1
	3	1	22.53	22.10	22.27	0	21.27	20.97	21.18	1
	3	3	22.31	21.88	22.21	0	21.41	20.96	21.30	1
	6	0	21.41	20.92	21.23	1	20.42	20.01	20.21	2

Band / BW	RB Size	RB Offset	QPSK			3GPP MPR (dB)	16QAM			3GPP MPR (dB)
			Low CH 19965	Mid CH 20175	High CH 20385		Low CH 19965	Mid CH 20175	High CH 20385	
			1711.5 MHz	1732.5 MHz	1753.5 MHz		1711.5 MHz	1732.5 MHz	1753.5 MHz	
4 / 3M	1	0	22.89	22.49	22.67	0	21.30	20.98	21.18	1
	1	7	22.31	21.93	22.19	0	21.21	20.79	21.09	1
	1	14	22.60	22.19	22.44	0	21.24	20.81	21.13	1
	8	0	21.47	21.09	21.42	1	20.34	19.91	20.23	2
	8	3	21.46	21.10	21.29	1	20.32	19.92	20.21	2
	8	7	21.28	20.95	21.25	1	20.43	19.94	20.26	2
	15	0	21.38	20.93	21.17	1	20.42	19.95	20.24	2

Band / BW	RB Size	RB Offset	QPSK			3GPP MPR (dB)	16QAM			3GPP MPR (dB)
			Low CH 19975	Mid CH 20175	High CH 20375		Low CH 19975	Mid CH 20175	High CH 20375	
			1712.5 MHz	1732.5 MHz	1752.5 MHz		1712.5 MHz	1732.5 MHz	1752.5 MHz	
4 / 5M	1	0	22.90	22.44	22.68	0	21.31	20.94	21.18	1
	1	12	22.36	21.90	22.19	0	21.18	20.82	21.08	1
	1	24	22.61	22.18	22.48	0	21.24	20.81	21.12	1
	12	0	21.50	21.09	21.39	1	20.34	19.89	20.20	2
	12	6	21.46	21.11	21.30	1	20.29	19.96	20.17	2
	12	13	21.32	20.91	21.26	1	20.38	19.96	20.29	2
	25	0	21.36	20.96	21.20	1	20.42	19.96	20.21	2

Band / BW	RB Size	RB Offset	QPSK			3GPP MPR (dB)	16QAM			3GPP MPR (dB)
			Low CH 20000	Mid CH 20175	High CH 20350		Low CH 20000	Mid CH 20175	High CH 20350	
			1715.0 MHz	1732.5 MHz	1750.0 MHz		1715.0 MHz	1732.5 MHz	1750.0 MHz	
4 / 10M	1	0	22.87	22.47	22.68	0	21.31	20.91	21.14	1
	1	24	22.36	21.90	22.20	0	21.23	20.78	21.11	1
	1	49	22.58	22.22	22.44	0	21.24	20.82	21.09	1
	25	0	21.51	21.08	21.42	1	20.36	19.87	20.26	2
	25	12	21.52	21.05	21.30	1	20.33	19.90	20.22	2
	25	25	21.30	20.88	21.25	1	20.37	19.97	20.26	2
	50	0	21.41	20.96	21.17	1	20.46	19.95	20.25	2

FCC SAR Test Report

Band / BW	RB Size	RB Offset	QPSK			3GPP MPR (dB)	16QAM			3GPP MPR (dB)
			Low CH 20025	Mid CH 20175	High CH 20325		Low CH 20025	Mid CH 20175	High CH 20325	
			1717.5 MHz	1732.5 MHz	1747.5 MHz		1717.5 MHz	1732.5 MHz	1747.5 MHz	
4 / 15M	1	0	22.94	22.47	22.65	0	21.35	20.98	21.14	1
	1	37	22.34	21.95	22.15	0	21.22	20.79	21.11	1
	1	74	22.64	22.25	22.45	0	21.20	20.87	21.11	1
	36	0	21.48	21.09	21.43	1	20.40	19.87	20.27	2
	36	19	21.53	21.10	21.30	1	20.27	19.94	20.18	2
	36	39	21.28	20.89	21.25	1	20.42	19.95	20.29	2
	75	0	21.41	20.94	21.22	1	20.47	19.98	20.18	2

Band / BW	RB Size	RB Offset	QPSK			3GPP MPR (dB)	16QAM			3GPP MPR (dB)
			Low CH 20050	Mid CH 20175	High CH 20300		Low CH 20050	Mid CH 20175	High CH 20300	
			1720.0 MHz	1732.5 MHz	1745.0 MHz		1720.0 MHz	1732.5 MHz	1745.0 MHz	
4 / 20M	1	0	22.95	22.51	22.73	0	21.38	20.99	21.20	1
	1	50	22.38	21.98	22.21	0	21.26	20.84	21.13	1
	1	99	22.66	22.26	22.49	0	21.26	20.89	21.14	1
	50	0	21.54	21.14	21.44	1	20.42	19.95	20.28	2
	50	25	21.52	21.12	21.35	1	20.35	19.98	20.23	2
	50	50	21.36	20.96	21.27	1	20.45	20.01	20.31	2
	100	0	21.42	20.98	21.25	1	20.48	20.03	20.26	2

Band / BW	RB Size	RB Offset	QPSK			3GPP MPR (dB)	16QAM			3GPP MPR (dB)
			Low CH 20407	Mid CH 20525	High CH 20643		Low CH 20407	Mid CH 20525	High CH 20643	
			824.7 MHz	836.5 MHz	848.3 MHz		824.7 MHz	836.5 MHz	848.3 MHz	
5 / 1.4M	1	0	23.21	23.37	23.66	0	22.24	22.38	22.71	1
	1	2	23.49	23.54	23.92	0	22.25	22.39	22.70	1
	1	5	23.28	23.34	23.71	0	22.44	22.49	22.90	1
	3	0	23.13	23.24	23.58	0	22.17	22.32	22.58	1
	3	1	23.15	23.35	23.53	0	22.12	22.37	22.57	1
	3	3	23.17	23.27	23.61	0	22.30	22.45	22.80	1
	6	0	22.24	22.37	22.66	1	21.14	21.31	21.58	2

Band / BW	RB Size	RB Offset	QPSK			3GPP MPR (dB)	16QAM			3GPP MPR (dB)
			Low CH 20415	Mid CH 20525	High CH 20635		Low CH 20415	Mid CH 20525	High CH 20635	
			825.5 MHz	836.5 MHz	847.5 MHz		825.5 MHz	836.5 MHz	847.5 MHz	
5 / 3M	1	0	23.23	23.39	23.65	0	22.21	22.44	22.74	1
	1	7	23.45	23.55	23.92	0	22.22	22.42	22.68	1
	1	14	23.24	23.34	23.71	0	22.47	22.49	22.90	1
	8	0	22.12	22.27	22.58	1	21.13	21.33	21.58	2
	8	3	22.08	22.35	22.55	1	21.17	21.32	21.60	2
	8	7	22.14	22.34	22.65	1	21.32	21.43	21.76	2
	15	0	22.21	22.38	22.60	1	21.14	21.25	21.61	2

FCC SAR Test Report

Band / BW	RB Size	RB Offset	QPSK			3GPP MPR (dB)	16QAM			3GPP MPR (dB)
			Low CH 20425	Mid CH 20525	High CH 20625		Low CH 20425	Mid CH 20525	High CH 20625	
			826.5 MHz	836.5 MHz	846.5 MHz		826.5 MHz	836.5 MHz	846.5 MHz	
5 / 5M	1	0	23.24	23.34	23.66	0	22.22	22.40	22.74	1
	1	12	23.50	23.52	23.92	0	22.19	22.45	22.67	1
	1	24	23.25	23.33	23.75	0	22.47	22.49	22.89	1
	12	0	22.15	22.27	22.55	1	21.13	21.31	21.55	2
	12	6	22.08	22.36	22.56	1	21.14	21.36	21.56	2
	12	13	22.18	22.30	22.66	1	21.27	21.45	21.79	2
	25	0	22.19	22.41	22.63	1	21.14	21.26	21.58	2

Band / BW	RB Size	RB Offset	QPSK			3GPP MPR (dB)	16QAM			3GPP MPR (dB)
			Low CH 20450	Mid CH 20525	High CH 20600		Low CH 20450	Mid CH 20525	High CH 20600	
			829.0 MHz	836.5 MHz	844.0 MHz		829.0 MHz	836.5 MHz	844.0 MHz	
5 / 10M	1	0	23.29	23.41	23.71	0	22.29	22.45	22.76	1
	1	24	23.52	23.60	23.94	0	22.27	22.47	22.72	1
	1	49	23.30	23.41	23.76	0	22.49	22.57	22.91	1
	25	0	22.19	22.32	22.60	1	21.21	21.37	21.63	2
	25	12	22.16	22.37	22.61	1	21.20	21.38	21.62	2
	25	25	22.22	22.35	22.67	1	21.34	21.50	21.81	2
	50	0	22.25	22.43	22.68	1	21.20	21.33	21.63	2

Band / BW	RB Size	RB Offset	QPSK			3GPP MPR (dB)	16QAM			3GPP MPR (dB)
			Low CH 23017	Mid CH 23095	High CH 23173		Low CH 23017	Mid CH 23095	High CH 23173	
			699.7 MHz	707.5 MHz	715.3 MHz		699.7 MHz	707.5 MHz	715.3 MHz	
12 / 1.4M	1	0	24.18	24.47	24.08	0	23.12	23.39	23.04	1
	1	2	23.96	24.14	23.84	0	23.21	23.48	23.11	1
	1	5	23.84	24.03	23.72	0	23.13	23.31	23.04	1
	3	0	23.86	24.10	23.76	0	22.94	23.22	22.80	1
	3	1	23.82	24.15	23.65	0	22.89	23.27	22.79	1
	3	3	23.86	24.09	23.75	0	22.96	23.24	22.91	1
	6	0	23.18	23.44	23.05	1	21.79	22.09	21.68	2

Band / BW	RB Size	RB Offset	QPSK			3GPP MPR (dB)	16QAM			3GPP MPR (dB)
			Low CH 23025	Mid CH 23095	High CH 23165		Low CH 23025	Mid CH 23095	High CH 23165	
			700.5 MHz	707.5 MHz	714.5 MHz		700.5 MHz	707.5 MHz	714.5 MHz	
12 / 3M	1	0	24.20	24.49	24.07	0	23.09	23.45	23.07	1
	1	7	23.92	24.15	23.84	0	23.18	23.51	23.09	1
	1	14	23.80	24.03	23.72	0	23.16	23.31	23.04	1
	8	0	22.85	23.13	22.76	1	21.90	22.23	21.80	2
	8	3	22.75	23.15	22.67	1	21.94	22.22	21.82	2
	8	7	22.83	23.16	22.79	1	21.98	22.22	21.87	2
	15	0	23.15	23.45	22.99	1	21.79	22.03	21.71	2

FCC SAR Test Report

Band / BW	RB Size	RB Offset	QPSK			3GPP MPR (dB)	16QAM			3GPP MPR (dB)
			Low CH 23035	Mid CH 23095	High CH 23155		Low CH 23035	Mid CH 23095	High CH 23155	
			701.5 MHz	707.5 MHz	713.5 MHz		701.5 MHz	707.5 MHz	713.5 MHz	
12 / 5M	1	0	24.21	24.44	24.08	0	23.10	23.41	23.07	1
	1	12	23.97	24.12	23.84	0	23.15	23.54	23.08	1
	1	24	23.81	24.02	23.76	0	23.16	23.31	23.03	1
	12	0	22.88	23.13	22.73	1	21.90	22.21	21.77	2
	12	6	22.75	23.16	22.68	1	21.91	22.26	21.78	2
	12	13	22.87	23.12	22.80	1	21.93	22.24	21.90	2
	25	0	23.13	23.48	23.02	1	21.79	22.04	21.68	2

Band / BW	RB Size	RB Offset	QPSK			3GPP MPR (dB)	16QAM			3GPP MPR (dB)
			Low CH 23060	Mid CH 23095	High CH 23130		Low CH 23060	Mid CH 23095	High CH 23130	
			704.0 MHz	707.5 MHz	711.0 MHz		704.0 MHz	707.5 MHz	711.0 MHz	
12 / 10M	1	0	24.26	24.51	24.13	0	23.17	23.46	23.09	1
	1	24	23.99	24.20	23.86	0	23.23	23.56	23.13	1
	1	49	23.86	24.10	23.77	0	23.18	23.39	23.05	1
	25	0	22.92	23.18	22.78	1	21.98	22.27	21.85	2
	25	12	22.83	23.17	22.73	1	21.97	22.28	21.84	2
	25	25	22.91	23.17	22.81	1	22.00	22.29	21.92	2
	50	0	23.19	23.50	23.07	1	21.85	22.11	21.73	2

Band / BW	RB Size	RB Offset	QPSK			3GPP MPR (dB)	16QAM			3GPP MPR (dB)
			Low CH 131979	Mid CH 132322	High CH 132665		Low CH 131979	Mid CH 132322	High CH 132665	
			1710.7 MHz	1745.0 MHz	1779.3 MHz		1710.7 MHz	1745.0 MHz	1779.3 MHz	
66 / 1.4M	1	0	22.77	23.07	23.10	0	22.06	22.35	22.40	1
	1	2	23.01	23.28	23.37	0	21.93	22.15	22.32	1
	1	5	22.71	22.96	23.03	0	21.45	21.75	21.89	1
	3	0	22.92	23.20	23.38	0	21.75	21.97	22.12	1
	3	1	22.68	22.95	22.94	0	21.85	22.25	22.28	1
	3	3	22.75	23.02	23.17	0	21.76	22.01	22.17	1
	6	0	21.83	22.04	22.17	1	20.71	21.00	21.02	2

Band / BW	RB Size	RB Offset	QPSK			3GPP MPR (dB)	16QAM			3GPP MPR (dB)
			Low CH 131987	Mid CH 132322	High CH 132657		Low CH 131987	Mid CH 132322	High CH 132657	
			1711.5 MHz	1745.0 MHz	1778.5 MHz		1711.5 MHz	1745.0 MHz	1778.5 MHz	
66 / 3M	1	0	22.79	23.09	23.09	0	22.03	22.41	22.43	1
	1	7	22.97	23.29	23.37	0	21.90	22.18	22.30	1
	1	14	22.67	22.96	23.03	0	21.48	21.75	21.89	1
	8	0	21.91	22.23	22.38	1	20.71	20.98	21.12	2
	8	3	21.61	21.95	21.96	1	20.90	21.20	21.31	2
	8	7	21.72	22.09	22.21	1	20.78	20.99	21.13	2
	15	0	21.80	22.05	22.11	1	20.71	20.94	21.05	2

FCC SAR Test Report

Band / BW	RB Size	RB Offset	QPSK			3GPP MPR (dB)	16QAM			3GPP MPR (dB)
			Low CH 131997	Mid CH 132322	High CH 132647		Low CH 131997	Mid CH 132322	High CH 132647	
			1712.5 MHz	1745.0 MHz	1777.5 MHz		1712.5 MHz	1745.0 MHz	1777.5 MHz	
66 / 5M	1	0	22.80	23.04	23.10	0	22.04	22.37	22.43	1
	1	12	23.02	23.26	23.37	0	21.87	22.21	22.29	1
	1	24	22.68	22.95	23.07	0	21.48	21.75	21.88	1
	12	0	21.94	22.23	22.35	1	20.71	20.96	21.09	2
	12	6	21.61	21.96	21.97	1	20.87	21.24	21.27	2
	12	13	21.76	22.05	22.22	1	20.73	21.01	21.16	2
	25	0	21.78	22.08	22.14	1	20.71	20.95	21.02	2

Band / BW	RB Size	RB Offset	QPSK			3GPP MPR (dB)	16QAM			3GPP MPR (dB)
			Low CH 132022	Mid CH 132322	High CH 132622		Low CH 132022	Mid CH 132322	High CH 132622	
			1715.0 MHz	1745.0 MHz	1775.0 MHz		1715.0 MHz	1745.0 MHz	1775.0 MHz	
66 / 10M	1	0	22.77	23.07	23.10	0	22.04	22.34	22.39	1
	1	24	23.02	23.26	23.38	0	21.92	22.17	22.32	1
	1	49	22.65	22.99	23.03	0	21.48	21.76	21.85	1
	25	0	21.95	22.22	22.38	1	20.73	20.94	21.15	2
	25	12	21.67	21.90	21.97	1	20.91	21.18	21.32	2
	25	25	21.74	22.02	22.21	1	20.72	21.02	21.13	2
	50	0	21.83	22.08	22.11	1	20.75	20.94	21.06	2

Band / BW	RB Size	RB Offset	QPSK			3GPP MPR (dB)	16QAM			3GPP MPR (dB)
			Low CH 132047	Mid CH 132322	High CH 132597		Low CH 132047	Mid CH 132322	High CH 132597	
			1717.5 MHz	1745.0 MHz	1772.5 MHz		1717.5 MHz	1745.0 MHz	1772.5 MHz	
66 / 15M	1	0	22.84	23.07	23.07	0	22.08	22.41	22.39	1
	1	37	23.00	23.31	23.33	0	21.91	22.18	22.32	1
	1	74	22.71	23.02	23.04	0	21.44	21.81	21.87	1
	36	0	21.92	22.23	22.39	1	20.77	20.94	21.16	2
	36	19	21.68	21.95	21.97	1	20.85	21.22	21.28	2
	36	39	21.72	22.03	22.21	1	20.77	21.00	21.16	2
	75	0	21.83	22.06	22.16	1	20.76	20.97	20.99	2

Band / BW	RB Size	RB Offset	QPSK			3GPP MPR (dB)	16QAM			3GPP MPR (dB)
			Low CH 132072	Mid CH 132322	High CH 132572		Low CH 132072	Mid CH 132322	High CH 132572	
			1720.0 MHz	1745.0 MHz	1770.0 MHz		1720.0 MHz	1745.0 MHz	1770.0 MHz	
66 / 20M	1	0	22.85	23.11	23.15	0	22.11	22.42	22.45	1
	1	50	23.04	23.34	23.39	0	21.95	22.23	22.34	1
	1	99	22.73	23.03	23.08	0	21.50	21.83	21.90	1
	50	0	21.98	22.28	22.40	1	20.79	21.02	21.17	2
	50	25	21.69	21.97	22.02	1	20.93	21.26	21.33	2
	50	50	21.80	22.10	22.23	1	20.80	21.06	21.18	2
	100	0	21.84	22.10	22.19	1	20.77	21.02	21.07	2

FCC SAR Test Report

Band / BW	RB Size	RB Offset	QPSK			3GPP MPR (dB)	16QAM			3GPP MPR (dB)
			Low CH 133147	Mid CH 133247	High CH 133447		Low CH 133147	Mid CH 133247	High CH 133447	
			665.5 MHz	675.5 MHz	695.5 MHz		665.5 MHz	675.5 MHz	695.5 MHz	
71 / 5M	1	0	22.76	22.52	22.92	0	22.14	21.99	22.39	1
	1	12	22.87	22.63	23.08	0	22.32	22.18	22.40	1
	1	24	22.40	22.19	22.65	0	22.29	22.08	22.35	1
	12	0	21.54	21.35	21.81	1	20.54	20.31	20.78	2
	12	6	21.62	21.49	21.84	1	20.49	20.38	20.75	2
	12	13	21.68	21.49	22.00	1	20.57	20.37	20.86	2
	25	0	21.62	21.44	21.84	1	20.50	20.26	20.67	2

Band / BW	RB Size	RB Offset	QPSK			3GPP MPR (dB)	16QAM			3GPP MPR (dB)
			Low CH 133172	Mid CH 133272	High CH 133422		Low CH 133172	Mid CH 133272	High CH 133422	
			668.0 MHz	678.0 MHz	693.0 MHz		668.0 MHz	678.0 MHz	693.0 MHz	
71 / 10M	1	0	22.73	22.55	22.92	0	22.14	21.96	22.35	1
	1	24	22.87	22.63	23.09	0	22.37	22.14	22.43	1
	1	49	22.37	22.23	22.61	0	22.29	22.09	22.32	1
	25	0	21.55	21.34	21.84	1	20.56	20.29	20.84	2
	25	12	21.68	21.43	21.84	1	20.53	20.32	20.80	2
	25	25	21.66	21.46	21.99	1	20.56	20.38	20.83	2
	50	0	21.67	21.44	21.81	1	20.54	20.25	20.71	2

Band / BW	RB Size	RB Offset	QPSK			3GPP MPR (dB)	16QAM			3GPP MPR (dB)
			Low CH 133197	Mid CH 133297	High CH 133397		Low CH 133197	Mid CH 133297	High CH 133397	
			670.5 MHz	680.5 MHz	690.5 MHz		670.5 MHz	680.5 MHz	690.5 MHz	
71 / 15M	1	0	22.80	22.55	22.89	0	22.18	22.03	22.35	1
	1	37	22.85	22.68	23.04	0	22.36	22.15	22.43	1
	1	74	22.43	22.26	22.62	0	22.25	22.14	22.34	1
	36	0	21.52	21.35	21.85	1	20.60	20.29	20.85	2
	36	19	21.69	21.48	21.84	1	20.47	20.36	20.76	2
	36	39	21.64	21.47	21.99	1	20.61	20.36	20.86	2
	75	0	21.67	21.42	21.86	1	20.55	20.28	20.64	2

Band / BW	RB Size	RB Offset	QPSK			3GPP MPR (dB)	16QAM			3GPP MPR (dB)
			Low CH 133222	Mid CH 133322	High CH 133372		Low CH 133222	Mid CH 133322	High CH 133372	
			673.0 MHz	683.0 MHz	688.0 MHz		673.0 MHz	683.0 MHz	688.0 MHz	
71 / 20M	1	0	22.81	22.59	22.97	0	22.21	22.04	22.41	1
	1	50	22.89	22.71	23.10	0	22.40	22.20	22.45	1
	1	99	22.45	22.27	22.66	0	22.31	22.16	22.37	1
	50	0	21.58	21.40	21.86	1	20.62	20.37	20.86	2
	50	25	21.70	21.50	21.89	1	20.55	20.40	20.81	2
	50	50	21.72	21.54	22.01	1	20.64	20.42	20.88	2
	100	0	21.68	21.46	21.89	1	20.56	20.33	20.72	2

FCC SAR Test Report

2.4GHz WLAN	Mode	Channel	Frequency (MHz)	Average power (dBm)
	802.11b 1Mbps	1	2412	17.28
		6	2437	17.34
		11	2462	16.78
	802.11g 6Mbps	1	2412	16.26
		6	2437	16.58
		11	2462	16.82
	802.11n-HT20 MCS0	1	2412	15.08
		6	2437	14.70
		11	2462	14.75
802.11n-HT40 MCS0	3	2422	14.02	
	6	2437	14.82	
	9	2452	13.38	

5.2GHz WLAN	Mode	Channel	Frequency (MHz)	Average power (dBm)
	802.11a 6Mbps	36	5180	13.98
		40	5200	13.92
		44	5220	13.85
		48	5240	13.78
	802.11n-HT20 MCS0	36	5180	13.40
		40	5200	13.34
		44	5220	13.26
		48	5240	13.22
	802.11n-HT40 MCS0	38	5190	10.32
		46	5230	13.62
	802.11ac-VHT20 MCS0	36	5180	12.48
		40	5200	12.32
		44	5220	12.37
	802.11ac-VHT40 MCS0	48	5240	12.43
		38	5190	12.40
46		5230	12.32	
802.11ac-VHT80 MCS0	42	5210	8.67	

FCC SAR Test Report

5.8GHz WLAN	Mode	Channel	Frequency (MHz)	Average power (dBm)
	802.11a 6Mbps	149	5745	14.06
		157	5785	14.02
		165	5825	13.81
	802.11n-HT20 MCS0	149	5745	13.72
		157	5785	13.25
		165	5825	13.62
	802.11n-HT40 MCS0	151	5755	13.58
		159	5795	13.50
	802.11ac-VHT20 MCS0	149	5745	12.78
157		5785	12.37	
165		5825	12.28	
802.11ac-VHT40 MCS0	151	5755	11.75	
	159	5795	12.02	
802.11ac-VHT80 MCS0	155	5775	11.82	

<Bluetooth>

Mode	Bluetooth GFSK		
Channel / Frequency (MHz)	0 (2402)	39 (2441)	78 (2480)
Average Power	8.86	8.60	6.98
Mode	Bluetooth $\pi/4$ -DQPSK		
Channel / Frequency (MHz)	0 (2402)	39 (2441)	78 (2480)
Average Power	5.78	5.69	3.90
Mode	Bluetooth 8-DPSK		
Channel / Frequency (MHz)	0 (2402)	39 (2441)	78 (2480)
Average Power	5.80	5.72	3.94
Mode	Bluetooth LE(1Mbps)		
Channel / Frequency (MHz)	0 (2402)	19 (2440)	39 (2480)
Average Power	-1.92	-2.00	-2.80

4.6 SAR Testing Results

4.6.1 SAR Test Reduction Considerations

<KDB 447498 D01, General RF Exposure Guidance>

Testing of other required channels within the operating mode of a frequency band is not required when the reported SAR for the mid-band or highest output power channel is:

- (1) ≤ 0.8 W/kg or 2.0 W/kg, for 1-g or 10-g respectively, when the transmission band is ≤ 100 MHz
- (2) ≤ 0.6 W/kg or 1.5 W/kg, for 1-g or 10-g respectively, when the transmission band is between 100 MHz and 200 MHz
- (3) ≤ 0.4 W/kg or 1.0 W/kg, for 1-g or 10-g respectively, when the transmission band is ≥ 200 MHz

<KDB 941225 D05, SAR Evaluation Considerations for LTE Devices>

- (1) QPSK with 1 RB and 50% RB allocation

Start with the largest channel bandwidth and measure SAR, using the RB offset and required test channel combination with the highest maximum output power among RB offsets at the upper edge, middle and lower edge of each required test channel. When the reported SAR is ≤ 0.8 W/kg, testing of the remaining RB offset configurations and required test channels is not required; otherwise, SAR is required for the remaining required test channels and only for the RB offset configuration with the highest output power for that channel. When the reported SAR of a required test channel is > 1.45 W/kg, SAR is required for all three RB offset configurations for that required test channel.

- (2) QPSK with 100% RB allocation

SAR is not required when the highest maximum output power for 100% RB allocation is less than the highest maximum output power in 50% and 1 RB allocations and the highest reported SAR for 1 RB and 50% RB allocation are ≤ 0.8 W/kg. Otherwise, SAR is measured for the highest output power channel; and if the reported SAR is > 1.45 W/kg, the remaining required test channels must also be tested.

- (3) Higher order modulations

SAR is required only when the highest maximum output power for the configuration in the higher order modulation is $> 1/2$ dB higher than the same configuration in QPSK or when the reported SAR for the QPSK configuration is > 1.45 W/kg.

- (4) Other channel bandwidth

SAR is required when the highest maximum output power of the smaller channel bandwidth is $> 1/2$ dB higher than the equivalent channel configurations in the largest channel bandwidth configuration or the reported SAR of a configuration for the largest channel bandwidth is > 1.45 W/kg.

<KDB 248227 D01, SAR Guidance for Wi-Fi Transmitters>

- (1) For handsets operating next to ear, hotspot mode or mini-tablet configurations, the initial test position procedures were applied. The test position with the highest extrapolated peak SAR will be used as the initial test position. When the reported SAR of initial test position is ≤ 0.4 W/kg, SAR testing for remaining test positions is not required. Otherwise, SAR is evaluated at the subsequent highest peak SAR positions until the reported SAR result is ≤ 0.8 W/kg or all test positions are measured.
- (2) For WLAN 2.4 GHz, the highest measured maximum output power channel for DSSS was selected for SAR measurement. When the reported SAR is ≤ 0.8 W/kg, no further SAR testing is required. Otherwise, SAR is evaluated at the next highest measured output power channel. When any reported SAR is > 1.2 W/kg, SAR is required for the third channel. For OFDM modes (802.11g/n), SAR is not required when the highest reported SAR for DSSS is adjusted by the ratio of OFDM to DSSS specified maximum output power and it is ≤ 1.2 W/kg.
- (3) For WLAN 5 GHz, the initial test configuration was selected according to the transmission mode with the highest maximum output power. When the reported SAR of initial test configuration is > 0.8 W/kg, SAR is required for the subsequent highest measured output power channel until the reported SAR result is ≤ 1.2 W/kg or all required channels are measured. For other transmission modes, SAR is not required when the highest reported SAR for initial test configuration is adjusted by the ratio of subsequent test configuration to initial test configuration specified maximum output power and it is ≤ 1.2 W/kg.
- (4) For WLAN MIMO mode, the power-based standalone SAR test exclusion or the sum of SAR provision in KDB 447498 to determine simultaneous transmission SAR test exclusion should be applied. Otherwise, SAR for MIMO mode will be measured with all applicable antennas transmitting simultaneously at the specified maximum output power of MIMO operation.

FCC SAR Test Report

4.6.2 SAR Results for Body Exposure Condition (Separation Distance is 1.5 cm Gap)

<FDD-LTE>

Plot No.	Band	Mode	Test Position	Separation Distance (cm)	Ch.	RB	offset	Max. Tune-up Power (dBm)	Measured Conducted Power (dBm)	Power Drift (dB)	Measured SAR-1g (W/kg)	Tune-up Scaling Factor	Scaled SAR-1g (W/kg)
	LTE 2	QPSK20M	Front Face	1.5	18900	1	0	23.0	22.81	0.14	0.867	1.04	0.91
	LTE 2	QPSK20M	Rear Face	1.5	18900	1	0	23.0	22.81	-0.08	0.187	1.04	0.20
	LTE 2	QPSK20M	Right side	1.5	18900	1	0	23.0	22.81	0.01	0.025	1.04	0.03
	LTE 2	QPSK20M	Left side	1.5	18900	1	0	23.0	22.81	-0.1	1.150	1.04	1.20
	LTE 2	QPSK20M	Top side	1.5	18900	1	0	23.0	22.81	0.04	0.211	1.04	0.22
	LTE 2	QPSK20M	Front Face	1.5	18900	50	0	22.0	21.67	0	0.668	1.08	0.72
	LTE 2	QPSK20M	Rear Face	1.5	18900	50	0	22.0	21.67	-0.07	0.145	1.08	0.16
	LTE 2	QPSK20M	Right side	1.5	18900	50	0	22.0	21.67	0.07	0.017	1.08	0.02
	LTE 2	QPSK20M	Left side	1.5	18900	50	0	22.0	21.67	-0.07	1.000	1.08	1.08
	LTE 2	QPSK20M	Top side	1.5	18900	50	0	22.0	21.67	-0.03	0.163	1.08	0.18
	LTE 2	QPSK20M	Front Face	1.5	18700	1	0	23.0	22.56	0.17	0.826	1.11	0.91
	LTE 2	QPSK20M	Front Face	1.5	19100	1	0	23.0	22.75	0.15	0.820	1.06	0.87
	LTE 2	QPSK20M	Front Face	1.5	18700	50	0	22.0	21.38	0.03	0.616	1.15	0.71
	LTE 2	QPSK20M	Front Face	1.5	19100	50	0	22.0	21.26	0.06	0.652	1.19	0.77
	LTE 2	QPSK20M	Left side	1.5	18700	1	0	23.0	22.56	-0.11	1.160	1.11	1.28
1	LTE 2	QPSK20M	Left side	1.5	19100	1	0	23.0	22.75	-0.16	1.240	1.06	1.31
	LTE 2	QPSK20M	Left side	1.5	18700	50	0	22.0	21.38	-0.02	0.943	1.15	1.09
	LTE 2	QPSK20M	Left side	1.5	19100	50	0	22.0	21.26	-0.03	1.050	1.19	1.25
	LTE 2	QPSK20M	Front Face	1.5	18900	100	0	22.0	21.49	0.07	0.738	1.12	0.83
	LTE 2	QPSK20M	Left side	1.5	18900	100	0	22.0	21.49	-0.03	1.010	1.12	1.14
2	LTE 5	QPSK10M	Front Face	1.5	20600	1	24	25.0	23.94	0.06	0.090	1.28	0.11
	LTE 5	QPSK10M	Rear Face	1.5	20600	1	24	25.0	23.94	0.01	0.036	1.28	0.05
	LTE 5	QPSK10M	Right side	1.5	20600	1	24	25.0	23.94	0.09	0.005	1.28	0.01
	LTE 5	QPSK10M	Left side	1.5	20600	1	24	25.0	23.94	0.02	0.024	1.28	0.03
	LTE 5	QPSK10M	Top side	1.5	20600	1	24	25.0	23.94	0.03	0.020	1.28	0.03
	LTE 5	QPSK10M	Front Face	1.5	20600	25	25	24.0	22.67	0.08	0.058	1.36	0.08
	LTE 5	QPSK10M	Rear Face	1.5	20600	25	25	24.0	22.67	-0.19	0.023	1.36	0.03
	LTE 5	QPSK10M	Right side	1.5	20600	25	25	24.0	22.67	0	0.004	1.36	0.01
	LTE 5	QPSK10M	Left side	1.5	20600	25	25	24.0	22.67	0.07	0.018	1.36	0.02
	LTE 5	QPSK10M	Top side	1.5	20600	25	25	24.0	22.67	-0.03	0.016	1.36	0.02
3	LTE 12	QPSK10M	Front Face	1.5	23095	1	0	25.0	24.51	-0.06	0.372	1.12	0.42
	LTE 12	QPSK10M	Rear Face	1.5	23095	1	0	25.0	24.51	-0.11	0.156	1.12	0.17
	LTE 12	QPSK10M	Right side	1.5	23095	1	0	25.0	24.51	0.01	0.045	1.12	0.05
	LTE 12	QPSK10M	Left side	1.5	23095	1	0	25.0	24.51	-0.04	0.052	1.12	0.06
	LTE 12	QPSK10M	Top side	1.5	23095	1	0	25.0	24.51	-0.12	0.123	1.12	0.14
	LTE 12	QPSK10M	Front Face	1.5	23095	25	0	24.0	23.18	0.05	0.282	1.21	0.34
	LTE 12	QPSK10M	Rear Face	1.5	23095	25	0	24.0	23.18	-0.01	0.210	1.21	0.25
	LTE 12	QPSK10M	Right side	1.5	23095	25	0	24.0	23.18	0.02	0.033	1.21	0.04
	LTE 12	QPSK10M	Left side	1.5	23095	25	0	24.0	23.18	0.1	0.036	1.21	0.04
	LTE 12	QPSK10M	Top side	1.5	23095	25	0	24.0	23.18	0.14	0.099	1.21	0.12
	LTE 66	QPSK20M	Front Face	1.5	132572	1	50	23.5	23.39	-0.18	0.923	1.03	0.95
	LTE 66	QPSK20M	Rear Face	1.5	132572	1	50	23.5	23.39	0.03	0.362	1.03	0.37
	LTE 66	QPSK20M	Right side	1.5	132572	1	50	23.5	23.39	-0.1	0.082	1.03	0.08
	LTE 66	QPSK20M	Left side	1.5	132572	1	50	23.5	23.39	0.1	1.230	1.03	1.26
	LTE 66	QPSK20M	Top side	1.5	132572	1	50	23.5	23.39	0.08	0.250	1.03	0.26
	LTE 66	QPSK20M	Front Face	1.5	132572	50	0	22.5	22.40	0.07	0.639	1.02	0.65
	LTE 66	QPSK20M	Rear Face	1.5	132572	50	0	22.5	22.40	0.17	0.267	1.02	0.27
	LTE 66	QPSK20M	Right side	1.5	132572	50	0	22.5	22.40	0	0.099	1.02	0.10
	LTE 66	QPSK20M	Left side	1.5	132572	50	0	22.5	22.40	0.02	1.040	1.02	1.06
	LTE 66	QPSK20M	Top side	1.5	132572	50	0	22.5	22.40	0.1	0.145	1.02	0.15
	LTE 66	QPSK20M	Front Face	1.5	132072	1	50	23.5	23.04	-0.07	0.842	1.11	0.94
	LTE 66	QPSK20M	Front Face	1.5	132322	1	50	23.5	23.34	0.01	0.633	1.04	0.66
	LTE 66	QPSK20M	Left side	1.5	132072	1	50	23.5	23.04	0.03	1.200	1.11	1.33
4	LTE 66	QPSK20M	Left side	1.5	132322	1	50	23.5	23.34	-0.07	1.290	1.04	1.34
	LTE 66	QPSK20M	Left side	1.5	132072	50	0	22.5	21.98	0.01	1.020	1.13	1.15
	LTE 66	QPSK20M	Left side	1.5	132322	50	0	22.5	22.28	-0.08	1.040	1.05	1.09
	LTE 66	QPSK20M	Front Face	1.5	132572	100	0	22.5	22.19	0.09	0.692	1.07	0.74
	LTE 66	QPSK20M	Left side	1.5	132572	100	0	22.5	22.19	-0.07	1.040	1.07	1.12

FCC SAR Test Report

Plot No.	Band	Mode	Test Position	Separation Distance (cm)	Ch.	RB	offset	Max. Tune-up Power (dBm)	Measured Conducted Power (dBm)	Power Drift (dB)	Measured SAR-1g (W/kg)	Tune-up Scaling Factor	Scaled SAR-1g (W/kg)
5	LTE 71	QPSK20M	Front Face	1.5	133372	1	50	23.5	23.10	-0.11	0.262	1.10	0.29
	LTE 71	QPSK20M	Rear Face	1.5	133372	1	50	23.5	23.10	-0.02	0.130	1.10	0.14
	LTE 71	QPSK20M	Right side	1.5	133372	1	50	23.5	23.10	-0.13	0.024	1.10	0.03
	LTE 71	QPSK20M	Left side	1.5	133372	1	50	23.5	23.10	0.06	0.075	1.10	0.08
	LTE 71	QPSK20M	Top side	1.5	133372	1	50	23.5	23.10	0.1	0.076	1.10	0.08
	LTE 71	QPSK20M	Front Face	1.5	133372	50	50	22.5	22.01	0.06	0.194	1.12	0.22
	LTE 71	QPSK20M	Rear Face	1.5	133372	50	50	22.5	22.01	0.04	0.097	1.12	0.11
	LTE 71	QPSK20M	Right side	1.5	133372	50	50	22.5	22.01	-0.06	0.018	1.12	0.02
	LTE 71	QPSK20M	Left side	1.5	133372	50	50	22.5	22.01	0	0.054	1.12	0.06
	LTE 71	QPSK20M	Top side	1.5	133372	50	50	22.5	22.01	0.02	0.061	1.12	0.07

<WLAN / BT >

Plot No.	Band	Mode	Test Position	Separation Distance (cm)	Ch.	Duty Cycle %	Max. Tune-up Power (dBm)	Measured Conducted Power (dBm)	Power Drift (dB)	Measured SAR-1g (W/kg)	Duty Cycle Scaling Factor	Tune-up Scaling Factor	Scaled SAR-1g (W/kg)	
	WLAN2.4G	802.11b	Front Face	1.5	6	99.2	18.0	17.34	0.01	0.092	1.01	1.16	0.11	
	WLAN2.4G	802.11b	Rear Face	1.5	6	99.2	18.0	17.34	0.09	0.094	1.01	1.16	0.11	
	6	WLAN2.4G	802.11b	Right side	1.5	6	99.2	18.0	17.34	0.01	0.143	1.01	1.16	0.17
	WLAN2.4G	802.11b	Left side	1.5	6	99.2	18.0	17.34	0	0.011	1.01	1.16	0.01	
	WLAN2.4G	802.11b	Top side	1.5	6	99.2	18.0	17.34	0.01	0.024	1.01	1.16	0.03	
	WLAN5G	802.11a	Front Face	1.5	36	95.1	14.5	13.98	-0.02	0.045	1.05	1.13	0.05	
	7	WLAN5G	802.11a	Rear Face	1.5	36	95.1	14.5	13.98	0.07	0.157	1.05	1.13	0.19
	WLAN5G	802.11a	Right side	1.5	36	95.1	14.5	13.98	-0.08	0.119	1.05	1.13	0.14	
	WLAN5G	802.11a	Left side	1.5	36	95.1	14.5	13.98	-0.07	0.034	1.05	1.13	0.04	
	WLAN5G	802.11a	Top side	1.5	36	95.1	14.5	13.98	0.1	0.054	1.05	1.13	0.06	
	WLAN5G	802.11a	Front Face	1.5	149	94.2	15.0	14.06	0.08	0.079	1.06	1.24	0.10	
	8	WLAN5G	802.11a	Rear Face	1.5	149	94.2	15.0	14.06	0.03	0.351	1.06	1.24	0.46
	WLAN5G	802.11a	Right side	1.5	149	94.2	15.0	14.06	0.11	0.177	1.06	1.24	0.23	
	WLAN5G	802.11a	Left side	1.5	149	94.2	15.0	14.06	0.15	0.022	1.06	1.24	0.03	
	WLAN5G	802.11a	Top side	1.5	149	94.2	15.0	14.06	0.07	0.085	1.06	1.24	0.11	
	BT	GFSK	Front Face	1.5	0	76.7	9.0	8.86	0.01	0.00801	1.30	1.03	0.01	
	BT	GFSK	Rear Face	1.5	0	76.7	9.0	8.86	0.1	0.00855	1.30	1.03	0.01	
	9	BT	GFSK	Right side	1.5	0	76.7	9.0	8.86	-0.01	0.0142	1.30	1.03	0.02
	BT	GFSK	Left side	1.5	0	76.7	9.0	8.86	-0.09	0.000304	1.30	1.03	0.00	
	BT	GFSK	Top side	1.5	0	76.7	9.0	8.86	0	0	1.30	1.03	0.00	

FCC SAR Test Report

4.6.3 SAR Results for Extremity Exposure Condition (Separation Distance is 0 cm Gap)

<FDD-LTE>

Plot No.	Band	Mode	Test Position	Separation Distance (cm)	Ch.	RB	offset	Max. Tune-up Power (dBm)	Measured Conducted Power (dBm)	Power Drift (dB)	Measured SAR-10g (W/kg)	Tune-up Scaling Factor	Scaled SAR-10g (W/kg)
	LTE 2	QPSK20M	Front Face	0	18900	1	0	23.0	22.81	0.04	2.870	1.04	3.00
	LTE 2	QPSK20M	Rear Face	0	18900	1	0	23.0	22.81	-0.05	0.675	1.04	0.71
	LTE 2	QPSK20M	Right side	0	18900	1	0	23.0	22.81	0.16	0.137	1.04	0.14
	LTE 2	QPSK20M	Left side	0	18900	1	0	23.0	22.81	-0.11	1.380	1.04	1.44
	LTE 2	QPSK20M	Top side	0	18900	1	0	23.0	22.81	0.06	0.794	1.04	0.83
	LTE 2	QPSK20M	Front Face	0	18900	50	0	22.0	21.67	0.06	2.370	1.08	2.56
	LTE 2	QPSK20M	Rear Face	0	18900	50	0	22.0	21.67	0.05	0.560	1.08	0.60
	LTE 2	QPSK20M	Right side	0	18900	50	0	22.0	21.67	-0.12	0.109	1.08	0.12
	LTE 2	QPSK20M	Left side	0	18900	50	0	22.0	21.67	0	1.140	1.08	1.23
	LTE 2	QPSK20M	Top side	0	18900	50	0	22.0	21.67	-0.17	0.634	1.08	0.68
10	LTE 2	QPSK20M	Front Face	0	18700	1	0	23.0	22.56	0.09	2.980	1.11	3.30
	LTE 2	QPSK20M	Front Face	0	19100	1	0	23.0	22.75	0.09	2.790	1.06	2.96
	LTE 2	QPSK20M	Front Face	0	18700	50	0	22.0	21.38	0.09	2.490	1.15	2.87
	LTE 2	QPSK20M	Front Face	0	19100	50	0	22.0	21.26	0.01	2.270	1.19	2.69
	LTE 2	QPSK20M	Front Face	0	18900	100	0	22.0	21.49	0.06	2.420	1.12	2.72
11	LTE 5	QPSK10M	Front Face	0	20600	1	24	24.5	23.94	0.01	0.356	1.14	0.40
	LTE 5	QPSK10M	Rear Face	0	20600	1	24	24.5	23.94	0.08	0.100	1.14	0.11
	LTE 5	QPSK10M	Right side	0	20600	1	24	24.5	23.94	0.06	0.017	1.14	0.02
	LTE 5	QPSK10M	Left side	0	20600	1	24	24.5	23.94	-0.08	0.120	1.14	0.14
	LTE 5	QPSK10M	Top side	0	20600	1	24	24.5	23.94	0.06	0.075	1.14	0.09
	LTE 5	QPSK10M	Front Face	0	20600	25	25	23.5	22.67	0	0.268	1.21	0.32
	LTE 5	QPSK10M	Rear Face	0	20600	25	25	23.5	22.67	-0.1	0.074	1.21	0.09
	LTE 5	QPSK10M	Right side	0	20600	25	25	23.5	22.67	0.09	0.013	1.21	0.02
	LTE 5	QPSK10M	Left side	0	20600	25	25	23.5	22.67	-0.01	0.094	1.21	0.11
	LTE 5	QPSK10M	Top side	0	20600	25	25	23.5	22.67	-0.05	0.052	1.21	0.06
12	LTE 12	QPSK10M	Front Face	0	23095	1	0	25.0	24.51	-0.12	0.564	1.12	0.63
	LTE 12	QPSK10M	Rear Face	0	23095	1	0	25.0	24.51	-0.16	0.429	1.12	0.48
	LTE 12	QPSK10M	Right side	0	23095	1	0	25.0	24.51	-0.02	0.132	1.12	0.15
	LTE 12	QPSK10M	Left side	0	23095	1	0	25.0	24.51	-0.01	0.129	1.12	0.14
	LTE 12	QPSK10M	Top side	0	23095	1	0	25.0	24.51	-0.03	0.394	1.12	0.44
	LTE 12	QPSK10M	Front Face	0	23095	25	0	24.0	23.18	0.14	0.425	1.21	0.51
	LTE 12	QPSK10M	Rear Face	0	23095	25	0	24.0	23.18	0.03	0.337	1.21	0.41
	LTE 12	QPSK10M	Right side	0	23095	25	0	24.0	23.18	-0.02	0.099	1.21	0.12
	LTE 12	QPSK10M	Left side	0	23095	25	0	24.0	23.18	-0.07	0.104	1.21	0.13
	LTE 12	QPSK10M	Top side	0	23095	25	0	24.0	23.18	0.03	0.321	1.21	0.39
13	LTE 66	QPSK20M	Front Face	0	132572	1	50	23.5	23.39	0.06	2.960	1.03	3.04
	LTE 66	QPSK20M	Rear Face	0	132572	1	50	23.5	23.39	0.01	1.090	1.03	1.12
	LTE 66	QPSK20M	Right side	0	132572	1	50	23.5	23.39	-0.05	0.350	1.03	0.36
	LTE 66	QPSK20M	Left side	0	132572	1	50	23.5	23.39	-0.1	2.560	1.03	2.63
	LTE 66	QPSK20M	Top side	0	132572	1	50	23.5	23.39	-0.01	0.805	1.03	0.83
	LTE 66	QPSK20M	Front Face	0	132572	50	0	22.5	22.40	0.12	2.460	1.02	2.52
	LTE 66	QPSK20M	Rear Face	0	132572	50	0	22.5	22.40	0.06	0.870	1.02	0.89
	LTE 66	QPSK20M	Right side	0	132572	50	0	22.5	22.40	-0.06	0.286	1.02	0.29
	LTE 66	QPSK20M	Left side	0	132572	50	0	22.5	22.40	-0.02	2.090	1.02	2.14
	LTE 66	QPSK20M	Top side	0	132572	50	0	22.5	22.40	-0.09	0.651	1.02	0.67
	LTE 66	QPSK20M	Front Face	0	132072	1	50	23.5	23.04	0.01	2.330	1.11	2.59
	LTE 66	QPSK20M	Front Face	0	132322	1	50	23.5	23.34	0.02	2.840	1.04	2.95
	LTE 66	QPSK20M	Front Face	0	132072	50	0	22.5	21.98	0.1	1.840	1.13	2.07
	LTE 66	QPSK20M	Front Face	0	132322	50	0	22.5	22.28	0.13	2.230	1.05	2.35
	LTE 66	QPSK20M	Left side	0	132072	1	50	23.5	23.04	0.06	2.540	1.11	2.82
	LTE 66	QPSK20M	Left side	0	132322	1	50	23.5	23.34	-0.01	2.560	1.04	2.66
	LTE 66	QPSK20M	Left side	0	132072	50	0	22.5	21.98	-0.01	1.930	1.13	2.18
	LTE 66	QPSK20M	Left side	0	132322	50	0	22.5	22.28	-0.06	2.110	1.05	2.22
	LTE 66	QPSK20M	Front Face	0	132572	100	0	22.5	22.19	0.18	2.520	1.07	2.71
	LTE 66	QPSK20M	Left side	0	132572	100	0	22.5	22.19	-0.11	2.040	1.07	2.19



FCC SAR Test Report

Plot No.	Band	Mode	Test Position	Separation Distance (cm)	Ch.	RB	offset	Max. Tune-up Power (dBm)	Measured Conducted Power (dBm)	Power Drift (dB)	Measured SAR-10g (W/kg)	Tune-up Scaling Factor	Scaled SAR-10g (W/kg)
14	LTE 71	QPSK20M	Front Face	0	133372	1	50	23.5	23.10	0.13	0.593	1.10	0.65
	LTE 71	QPSK20M	Rear Face	0	133372	1	50	23.5	23.10	0	0.308	1.10	0.34
	LTE 71	QPSK20M	Right side	0	133372	1	50	23.5	23.10	-0.01	0.208	1.10	0.23
	LTE 71	QPSK20M	Left side	0	133372	1	50	23.5	23.10	-0.14	0.120	1.10	0.13
	LTE 71	QPSK20M	Top side	0	133372	1	50	23.5	23.10	-0.03	0.287	1.10	0.31
	LTE 71	QPSK20M	Front Face	0	133372	50	50	22.5	22.01	-0.02	0.476	1.12	0.53
	LTE 71	QPSK20M	Rear Face	0	133372	50	50	22.5	22.01	-0.03	0.235	1.12	0.26
	LTE 71	QPSK20M	Right side	0	133372	50	50	22.5	22.01	-0.14	0.133	1.12	0.15
	LTE 71	QPSK20M	Left side	0	133372	50	50	22.5	22.01	-0.03	0.088	1.12	0.10
	LTE 71	QPSK20M	Top side	0	133372	50	50	22.5	22.01	0	0.209	1.12	0.23

<WLAN / BT >

Plot No.	Band	Mode	Test Position	Separation Distance (cm)	Ch.	Duty Cycle %	Max. Tune-up Power (dBm)	Measured Conducted Power (dBm)	Power Drift (dB)	Measured SAR-10g (W/kg)	Duty Cycle Scaling Factor	Tune-up Scaling Factor	Scaled SAR-10g (W/kg)
	WLAN2.4G	802.11b	Front Face	0	6	99.2	18.0	17.34	0.05	0.368	1.01	1.16	0.43
15	WLAN2.4G	802.11b	Rear Face	0	6	99.2	18.0	17.34	0.03	0.644	1.01	1.16	0.76
	WLAN2.4G	802.11b	Right side	0	6	99.2	18.0	17.34	0.06	0.603	1.01	1.16	0.71
	WLAN2.4G	802.11b	Left side	0	6	99.2	18.0	17.34	-0.07	0.016	1.01	1.16	0.02
	WLAN2.4G	802.11b	Top side	0	6	99.2	18.0	17.34	0.03	0.046	1.01	1.16	0.05
	WLAN5G	802.11a	Front Face	0	36	95.1	14.5	13.98	0.04	0.132	1.05	1.13	0.16
16	WLAN5G	802.11a	Rear Face	0	36	95.1	14.5	13.98	0.04	0.444	1.05	1.13	0.53
	WLAN5G	802.11a	Right side	0	36	95.1	14.5	13.98	0.07	0.374	1.05	1.13	0.44
	WLAN5G	802.11a	Left side	0	36	95.1	14.5	13.98	0	0.046	1.05	1.13	0.05
	WLAN5G	802.11a	Top side	0	36	95.1	14.5	13.98	0.05	0.050	1.05	1.13	0.06
	WLAN5G	802.11a	Front Face	0	149	94.2	15.0	14.06	0.02	0.100	1.06	1.24	0.13
17	WLAN5G	802.11a	Rear Face	0	149	94.2	15.0	14.06	0.04	0.827	1.06	1.24	1.09
	WLAN5G	802.11a	Right side	0	149	94.2	15.0	14.06	0.15	0.626	1.06	1.24	0.83
	WLAN5G	802.11a	Left side	0	149	94.2	15.0	14.06	0.04	0.021	1.06	1.24	0.03
	WLAN5G	802.11a	Top side	0	149	94.2	15.0	14.06	0.06	0.083	1.06	1.24	0.11
	BT	GFSK	Front Face	0	0	76.7	9.0	8.86	0.15	0.039	1.30	1.03	0.05
18	BT	GFSK	Rear Face	0	0	76.7	9.0	8.86	-0.07	0.062	1.30	1.03	0.08
	BT	GFSK	Right side	0	0	76.7	9.0	8.86	0	0.055	1.30	1.03	0.07
	BT	GFSK	Left side	0	0	76.7	9.0	8.86	0.01	0.000211	1.30	1.03	0.00
	BT	GFSK	Top side	0	0	76.7	9.0	8.86	0.04	0.000699	1.30	1.03	0.00

FCC SAR Test Report

4.6.4 SAR Measurement Variability

According to KDB 865664 D01, SAR measurement variability was assessed for each frequency band, which is determined by the SAR probe calibration point and tissue-equivalent medium used for the device measurements. When both head and body tissue-equivalent media are required for SAR measurements in a frequency band, the variability measurement procedures should be applied to the tissue medium with the highest measured SAR, using the highest measured SAR configuration for that tissue-equivalent medium. Alternatively, if the highest measured SAR for both head and body tissue-equivalent media are ≤ 1.45 W/kg and the ratio of these highest SAR values, i.e., largest divided by smallest value, is ≤ 1.10 , the highest SAR configuration for either head or body tissue-equivalent medium may be used to perform the repeated measurement. These additional measurements are repeated after the completion of all measurements requiring the same head or body tissue-equivalent medium in a frequency band. The test device should be returned to ambient conditions (normal room temperature) with the battery fully charged before it is re-mounted on the device holder for the repeated measurement(s) to minimize any unexpected variations in the repeated results.

SAR repeated measurement procedure:

1. When the highest measured SAR is < 0.80 W/kg, repeated measurement is not required.
2. When the highest measured SAR is ≥ 0.80 W/kg, repeat that measurement once.
3. If the ratio of largest to smallest SAR for the original and first repeated measurements is > 1.20 , or when the original or repeated measurement is ≥ 1.45 W/kg, perform a second repeated measurement.
4. If the ratio of largest to smallest SAR for the original, first and second repeated measurements is > 1.20 , and the original, first or second repeated measurement is ≥ 1.5 W/kg, perform a third repeated measurement.

Band	Test Position	Ch.	Original Measured SAR-1g (W/kg)	1st Repeated SAR-1g (W/kg)	L/S Ratio	2nd Repeated SAR-1g (W/kg)	L/S Ratio	3rd Repeated SAR-1g (W/kg)	L/S Ratio
LTE 66	Left side	132322	1.290	1.180	1.09	N/A	N/A	N/A	N/A
LTE 2	Left side	19100	1.240	1.130	1.10	N/A	N/A	N/A	N/A

Band	Test Position	Ch.	Original Measured SAR-10g (W/kg)	1st Repeated SAR-10g (W/kg)	L/S Ratio	2nd Repeated SAR-10g (W/kg)	L/S Ratio	3rd Repeated SAR-10g (W/kg)	L/S Ratio
LTE 66	Front Face	132572	2.960	2.840	1.04	N/A	N/A	N/A	N/A
LTE 2	Front Face	18700	2.980	2.870	1.04	N/A	N/A	N/A	N/A

FCC SAR Test Report

4.6.5 Simultaneous Multi-band Transmission Evaluation

The simultaneous transmission possibilities for this device are listed as below.

Simultaneous TX Combination	Capable Transmit Configurations	Body Exposure Condition
1	WWAN + WLAN2.4G	Yes
2	WWAN + WLAN5G	Yes
3	WWAN + BT	Yes
4	WLAN2.4G + BT	Yes
5	WLAN5G + BT	Yes
6	WWAN + WLAN5G + BT	Yes
7	WWAN + WLAN2.4G + BT	Yes

Note:

1. The 2.4G WLAN and 5G WLAN cannot transmit simultaneously.

<SAR Summation Analysis>

Simultaneous transmission SAR test exclusion is determined for each operating configuration and exposure condition according to the reported standalone SAR of each applicable simultaneous transmitting antenna. When the sum of SAR_{1g} of all simultaneously transmitting antennas in an operating mode and exposure condition combination is within the SAR limit (SAR_{1g} 1.6 W/kg), the simultaneous transmission SAR is not required. When the sum of SAR_{1g} is greater than the SAR limit (SAR_{1g} 1.6 W/kg), SAR test exclusion is determined by the SPLSR.

WWAN Band	Exposure Position	1	2	3	4	1+2+4 Summed 1g SAR (W/kg)	1+3+4 Summed 1g SAR (W/kg)
		WWAN	2.4GHz WLAN Ant 1	5GHz WLAN Ant 1	Bluetooth Ant 1		
		1g SAR (W/kg)	1g SAR (W/kg)	1g SAR (W/kg)	1g SAR (W/kg)		
LTE Band 2	Front Face at 15mm	0.91	0.11	0.10	0.01	1.03	1.03
	Rear Face at 15mm	0.20	0.11	0.46	0.01	0.32	0.67
	Left Side at 15mm	1.31	0.17	0.23	0.02	1.50	1.57
	Right Side at 15mm	0.03	0.01	0.04	0.00	0.04	0.07
	Top Side at 15mm	0.22	0.03	0.11	0.00	0.25	0.33
LTE Band 5	Front Face at 15mm	0.11	0.11	0.10	0.01	0.23	0.23
	Rear Face at 15mm	0.05	0.11	0.46	0.01	0.17	0.52
	Left Side at 15mm	0.03	0.17	0.23	0.02	0.22	0.28
	Right Side at 15mm	0.01	0.01	0.04	0.00	0.02	0.05
	Top Side at 15mm	0.03	0.03	0.11	0.00	0.05	0.14
LTE Band 12	Front Face at 15mm	0.42	0.11	0.10	0.01	0.54	0.53
	Rear Face at 15mm	0.25	0.11	0.46	0.01	0.38	0.73
	Left Side at 15mm	0.06	0.17	0.23	0.02	0.25	0.31
	Right Side at 15mm	0.05	0.01	0.04	0.00	0.06	0.09
	Top Side at 15mm	0.14	0.03	0.11	0.00	0.17	0.25
LTE Band 4 / 66	Front Face at 15mm	0.95	0.11	0.10	0.01	1.07	1.06
	Rear Face at 15mm	0.37	0.11	0.46	0.01	0.49	0.85



FCC SAR Test Report

WWAN Band	Exposure Position	1	2	3	4	1+2+4 Summed 1g SAR (W/kg)	1+3+4 Summed 1g SAR (W/kg)
		WWAN	2.4GHz WLAN Ant 1	5GHz WLAN Ant 1	Bluetooth Ant 1		
		1g SAR (W/kg)	1g SAR (W/kg)	1g SAR (W/kg)	1g SAR (W/kg)		
	Left Side at 15mm	1.34	0.17	0.23	0.02	1.53	1.59
	Right Side at 15mm	0.10	0.01	0.04	0.00	0.11	0.14
	Top Side at 15mm	0.26	0.03	0.11	0.00	0.28	0.37
LTE Band 71	Front Face at 15mm	0.29	0.11	0.10	0.01	0.41	0.40
	Rear Face at 15mm	0.14	0.11	0.46	0.01	0.27	0.62
	Left Side at 15mm	0.08	0.17	0.23	0.02	0.27	0.33
	Right Side at 15mm	0.03	0.01	0.04	0.00	0.04	0.07
	Top Side at 15mm	0.08	0.03	0.11	0.00	0.11	0.20

WWAN Band	Exposure Position	1	2	3	4	1+2+4 Summed 10g SAR (W/kg)	1+3+4 Summed 10g SAR (W/kg)
		WWAN	2.4GHz WLAN Ant 1	5GHz WLAN Ant 1	Bluetooth Ant 1		
		10g SAR (W/kg)	10g SAR (W/kg)	10g SAR (W/kg)	10g SAR (W/kg)		
LTE Band 2	Front Face at 0mm	3.30	0.43	0.16	0.05	3.78	3.51
	Rear Face at 0mm	0.71	0.76	1.37	0.08	1.54	2.16
	Left Side at 0mm	1.44	0.02	0.05	0.07	1.53	1.57
	Right Side at 0mm	0.14	0.71	1.07	0.00	0.85	1.22
	Top Side at 0mm	0.83	0.05	0.12	0.00	0.89	0.95
LTE Band 5	Front Face at 0mm	0.40	0.43	0.16	0.05	0.89	0.61
	Rear Face at 0mm	0.11	0.76	1.37	0.08	0.95	1.57
	Left Side at 0mm	0.14	0.02	0.05	0.07	0.23	0.27
	Right Side at 0mm	0.02	0.71	1.07	0.00	0.73	1.09
	Top Side at 0mm	0.09	0.05	0.12	0.00	0.14	0.21
LTE Band 12	Front Face at 0mm	0.63	0.43	0.16	0.05	1.12	0.84
	Rear Face at 0mm	0.48	0.76	1.37	0.08	1.32	1.94
	Left Side at 0mm	0.14	0.02	0.05	0.07	0.24	0.27
	Right Side at 0mm	0.15	0.71	1.07	0.00	0.86	1.22
	Top Side at 0mm	0.44	0.05	0.12	0.00	0.50	0.57
LTE Band 4 / 66	Front Face at 0mm	3.04	0.43	0.16	0.05	3.52	3.25
	Rear Face at 0mm	1.12	0.76	1.37	0.08	1.96	2.58
	Left Side at 0mm	2.82	0.02	0.05	0.07	2.92	2.95
	Right Side at 0mm	0.36	0.71	1.07	0.00	1.07	1.43
	Top Side at 0mm	0.83	0.05	0.12	0.00	0.88	0.95
LTE Band 71	Front Face at 0mm	0.65	0.43	0.16	0.05	1.14	0.86
	Rear Face at 0mm	0.34	0.76	1.37	0.08	1.18	1.80
	Left Side at 0mm	0.13	0.02	0.05	0.07	0.22	0.26



FCC SAR Test Report

WWAN Band	Exposure Position	1	2	3	4	1+2+4 Summed 10g SAR (W/kg)	1+3+4 Summed 10g SAR (W/kg)
		WWAN	2.4GHz WLAN Ant 1	5GHz WLAN Ant 1	Bluetooth Ant 1		
		10g SAR (W/kg)	10g SAR (W/kg)	10g SAR (W/kg)	10g SAR (W/kg)		
	Right Side at 0mm	0.23	0.71	1.07	0.00	0.94	1.30
	Top Side at 0mm	0.31	0.05	0.12	0.00	0.37	0.44

Test Engineer : Gengdong Deng,

5. Calibration of Test Equipment

Equipment	Manufacturer	Model	SN	Cal. Date	Cal. Interval
System Validation Dipole	SPEAG	D750V3	1067	Sep. 16, 2021	1 Year
System Validation Dipole	SPEAG	D835V2	4d139	Sep. 17, 2021	1 Year
System Validation Dipole	SPEAG	D1750V2	1071	Sep. 18, 2021	1 Year
System Validation Dipole	SPEAG	D1900V2	5d159	Sep. 16, 2021	1 Year
System Validation Dipole	SPEAG	D2450V2	839	Sep. 18, 2021	1 Year
System Validation Dipole	SPEAG	D5GHzV2	1133	Sep. 14, 2021	1 Year
Dosimetric E-Field Probe	SPEAG	ES3DV3	3268	Aug. 24, 2021	1 Year
Data Acquisition Electronics	SPEAG	DAE4	1288	Aug. 20, 2021	1 Year
Dosimetric E-Field Probe	SPEAG	EX3DV4	3783	Aug. 25, 2021	1 Year
Data Acquisition Electronics	SPEAG	DAE4	905	Jun. 22, 2021	1 Year
Radio Communication Analyzer	ANRITSU	MT8820C	6201465426	Feb. 25, 2021	1 Year
ENA Series Network Analyzer	Agilent	E5071C	MY46214638	Jun. 03, 2021	1 Year
Spectrum Analyzer	KEYSIGHT	N9010A	MY54510355	Jun. 03, 2021	1 Year
MXG Analog Signal Generator	KEYSIGHT	N5183A	MY50143024	Mar. 09, 2021	1 Year
Power Meter	Agilent	N1914A	MY52180044	Mar. 02, 2021	1 Year
Power Sensor	Agilent	E9304A H18	MY52050011	Feb. 25, 2021	1 Year
Power Meter	ANRITSU	ML2495A	1506002	Apr. 07, 2021	1 Year
Power Sensor	ANRITSU	MA2411B	1339353	May. 07, 2021	1 Year
Temp. & Humi. Recorder	CLOCK	HTC-1	157248	Jun. 02, 2021	1 Year
Electronic Thermometer	YONGFA	YF-160A	120100323	Jun. 02, 2021	1 Year
Coupler	Woken	0110A056020-10	COM27RW1A3	Jun. 02, 2021	1 Year

6. Measurement Uncertainty

DASY5 Uncertainty Budget								
Error Description	Uncertainty Value (±%)	Probability	Divisor	(Ci) 1g	(Ci) 10g	Standard Uncertainty (1g) (±%)	Standard Uncertainty (10g) (±%)	(Vi) Veff
Measurement System								
Probe Calibration	6.0	N	1	1	1	6.0	6.0	∞
Axial Isotropy	4.7	R	1.732	0.7	0.7	1.9	1.9	∞
Hemispherical Isotropy	9.6	R	1.732	0.7	0.7	3.9	3.9	∞
Boundary Effects	1.0	R	1.732	1	1	0.6	0.6	∞
Linearity	4.7	R	1.732	1	1	2.7	2.7	∞
System Detection Limits	1.0	R	1.732	1	1	0.6	0.6	∞
Modulation Response	3.2	R	1.732	1	1	1.8	1.8	∞
Readout Electronics	0.3	N	1	1	1	0.3	0.3	∞
Response Time	0.0	R	1.732	1	1	0.0	0.0	∞
Integration Time	2.6	R	1.732	1	1	1.5	1.5	∞
RF Ambient Noise	3.0	R	1.732	1	1	1.7	1.7	∞
RF Ambient Reflections	3.0	R	1.732	1	1	1.7	1.7	∞
Probe Positioner	0.4	R	1.732	1	1	0.2	0.2	∞
Probe Positioning	2.9	R	1.732	1	1	1.7	1.7	∞
Max. SAR Eval.	2.0	R	1.732	1	1	1.2	1.2	∞
Test Sample Related								
Device Positioning	3.0	N	1	1	1	3.0	3.0	35
Device Holder	3.6	N	1	1	1	3.6	3.6	12
Power Drift	5.0	R	1.732	1	1	2.9	2.9	∞
Power Scaling	0.0	R	1.732	1	1	0.0	0.0	∞
Phantom and Setup								
Phantom Uncertainty	6.1	R	1.732	1	1	3.5	3.5	∞
SAR correction	0.0	R	1.732	1	0.84	0.0	0.0	∞
Liquid Conductivity Repeatability	0.2	N	1	0.78	0.71	0.1	0.1	5
Liquid Conductivity (target)	5.0	R	1.732	0.78	0.71	2.3	2.0	∞
Liquid Conductivity (mea.)	2.5	R	1.732	0.78	0.71	1.1	1.0	∞
Temp. unc. - Conductivity	3.4	R	1.732	0.78	0.71	1.5	1.4	∞
Liquid Permittivity Repeatability	0.15	N	1	0.23	0.26	0.0	0.0	5
Liquid Permittivity (target)	5.0	R	1.732	0.23	0.26	0.7	0.8	∞
Liquid Permittivity (mea.)	2.5	R	1.732	0.23	0.26	0.3	0.4	∞
Temp. unc. - Permittivity	0.83	R	1.732	0.23	0.26	0.1	0.1	∞
Combined Std. Uncertainty						11.4%	11.4%	1013
Coverage Factor for 95 %						K=2	K=2	
Expanded STD Uncertainty						22.9%	22.7%	

Uncertainty budget for frequency range 30 MHz to 3 GHz

FCC SAR Test Report

DASY5 Uncertainty Budget								
Error Description	Uncertainty Value (±%)	Probability	Divisor	(Ci) 1g	(Ci) 10g	Standard Uncertainty (1g) (±%)	Standard Uncertainty (10g) (±%)	(Vi) Veff
Measurement System								
Probe Calibration	6.55	N	1	1	1	6.5	6.5	∞
Axial Isotropy	4.7	R	1.732	0.7	0.7	1.9	1.9	∞
Hemispherical Isotropy	9.6	R	1.732	0.7	0.7	3.9	3.9	∞
Boundary Effects	2.0	R	1.732	1	1	1.2	1.2	∞
Linearity	4.7	R	1.732	1	1	2.7	2.7	∞
System Detection Limits	1.0	R	1.732	1	1	0.6	0.6	∞
Modulation Response	3.2	R	1.732	1	1	1.8	1.8	∞
Readout Electronics	0.3	N	1	1	1	0.3	0.3	∞
Response Time	0.0	R	1.732	1	1	0.0	0.0	∞
Integration Time	2.6	R	1.732	1	1	1.5	1.5	∞
RF Ambient Noise	3.0	R	1.732	1	1	1.7	1.7	∞
RF Ambient Reflections	3.0	R	1.732	1	1	1.7	1.7	∞
Probe Positioner	0.4	R	1.732	1	1	0.2	0.2	∞
Probe Positioning	6.7	R	1.732	1	1	3.9	3.9	∞
Max. SAR Eval.	4.0	R	1.732	1	1	2.3	2.3	∞
Test Sample Related								
Device Positioning	3.0	N	1	1	1	3.0	3.0	35
Device Holder	3.6	N	1	1	1	3.6	3.6	12
Power Drift	5.0	R	1.732	1	1	2.9	2.9	∞
Power Scaling	0.0	R	1.732	1	1	0.0	0.0	∞
Phantom and Setup								
Phantom Uncertainty	6.6	R	1.732	1	1	3.8	3.8	∞
SAR correction	0.0	R	1.732	1	0.84	0.0	0.0	∞
Liquid Conductivity Repeatability	0.2	N	1	0.78	0.71	0.1	0.1	5
Liquid Conductivity (target)	5.0	R	1.732	0.78	0.71	2.3	2.0	∞
Liquid Conductivity (mea.)	2.5	R	1.732	0.78	0.71	1.1	1.0	∞
Temp. unc. - Conductivity	3.4	R	1.732	0.78	0.71	1.5	1.4	∞
Liquid Permittivity Repeatability	0.15	N	1	0.23	0.26	0.0	0.0	5
Liquid Permittivity (target)	5.0	R	1.732	0.23	0.26	0.7	0.8	∞
Liquid Permittivity (mea.)	2.5	R	1.732	0.23	0.26	0.3	0.4	∞
Temp. unc. - Permittivity	0.83	R	1.732	0.23	0.26	0.1	0.1	∞
Combined Std. Uncertainty						12.5%	12.5%	1458
Coverage Factor for 95 %						K=2	K=2	
Expanded STD Uncertainty						25.0%	24.9%	

Uncertainty budget for frequency range 3 GHz to 6 GHz

7. Information on the Testing Laboratories

We, BV 7LAYERS COMMUNICATIONS TECHNOLOGY (SHENZHEN) CO. LTD., were founded in 2015 to provide our best service in EMC, Radio, Telecom and Safety consultation. Our laboratories are accredited and approved according to ISO/IEC 17025.

If you have any comments, please feel free to contact us at the following:

Add: No. B102, Dazu Chuangxin Mansion, North of Beihuan Avenue, North Area, Hi-Tech Industry Park, Nanshan District, Shenzhen, Guangdong, China

Tel: 86-755-8869-6566

Fax: 86-755-8869-6577

Email: customerservice.sw@cn.bureauveritas.com

Web Site: www.bureauveritas.com

The road map of all our labs can be found in our web site also.

---END---

Appendix A. SAR Plots of System Verification

The plots for system verification with largest deviation for each SAR system combination are shown as follows.

System Check_HSL750_211013

DUT: Dipole:750 MHz;Type:D750V3

Communication System: UID 0, CW; Frequency: 750 MHz;Duty Cycle: 1:1

Medium: HSL750_1013 Medium parameters used: $f = 750$ MHz; $\sigma = 0.882$ S/m; $\epsilon_r = 40.513$; $\rho = 1000$ kg/m³

Ambient Temperature : 23.2°C; Liquid Temperature : 22.5°C

DASY5 Configuration:

- Probe: ES3DV3 - SN3268; ConvF(6.6, 6.6, 6.6); Calibrated: 2021/8/24;
- Sensor-Surface: 4mm (Mechanical Surface Detection)
- Electronics: DAE4 Sn1288; Calibrated: 2021/8/20
- Phantom: SAM (Front) with CRP v5.0; Type: QD000P40CD; Serial: TP:1610
- Measurement SW: DASY52, Version 52.8 (8); SEMCAD X Version 14.6.10 (7331)

Pin=250mW/Area Scan (71x131x1): Interpolated grid: dx=1.500 mm, dy=1.500 mm

Maximum value of SAR (interpolated) = 2.78 W/kg

Pin=250mW/Zoom Scan (5x5x7)/Cube 0: Measurement grid: dx=8mm, dy=8mm, dz=5mm

Reference Value = 55.71 V/m; Power Drift = 0.03 dB

Peak SAR (extrapolated) = 3.22 W/kg

SAR(1 g) = 2.1 W/kg; SAR(10 g) = 1.38 W/kg

Maximum value of SAR (measured) = 2.83 W/kg

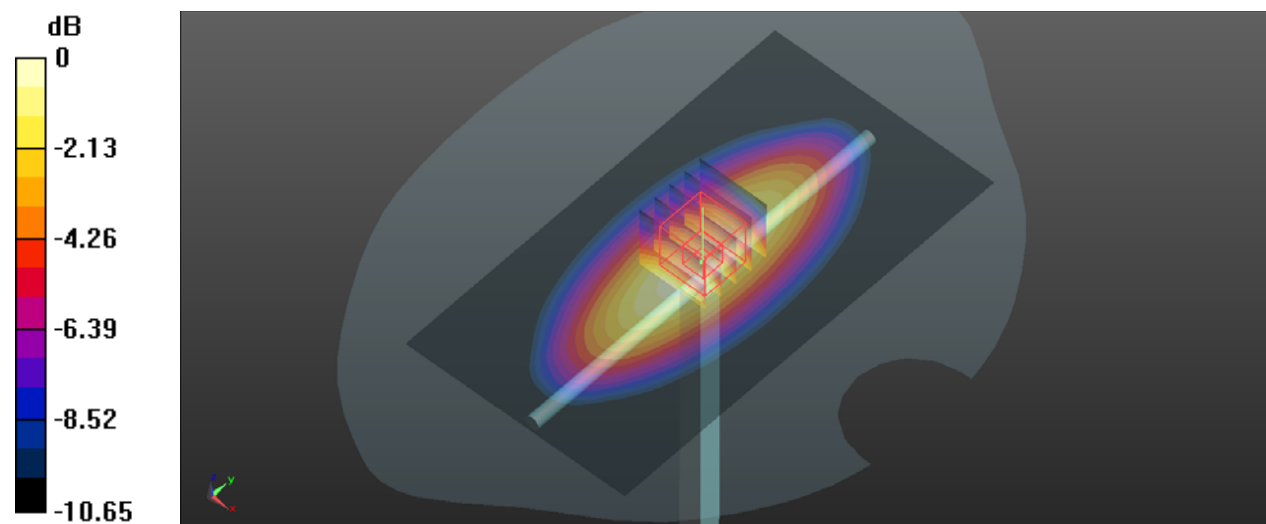

System Check_HSL835_211014

DUT: Dipole:835 MHz;Type:D835V2

Communication System: UID 0, CW; Frequency: 835 MHz;Duty Cycle: 1:1
Medium: HSL835_1014 Medium parameters used: $f = 835 \text{ MHz}$; $\sigma = 0.906 \text{ S/m}$; $\epsilon_r = 41.947$; $\rho = 1000 \text{ kg/m}^3$
Ambient Temperature : 23.4°C ; Liquid Temperature : 22.7°C

DASY5 Configuration:

- Probe: ES3DV3 - SN3268; ConvF(6.04, 6.04, 6.04); Calibrated: 2021/8/24;
- Sensor-Surface: 4mm (Mechanical Surface Detection)
- Electronics: DAE4 Sn1288; Calibrated: 2021/8/20
- Phantom: SAM (Front) with CRP v5.0; Type: QD000P40CD; Serial: TP:1610
- Measurement SW: DASY52, Version 52.8 (8); SEMCAD X Version 14.6.10 (7331)

Pin=250mW/Area Scan (71x121x1): Interpolated grid: $dx=1.500 \text{ mm}$, $dy=1.500 \text{ mm}$
Maximum value of SAR (interpolated) = 2.42 W/kg

Pin=250mW/Zoom Scan (5x5x7)/Cube 0: Measurement grid: $dx=8\text{mm}$, $dy=8\text{mm}$, $dz=5\text{mm}$
Reference Value = 52.79 V/m ; Power Drift = -0.15 dB
Peak SAR (extrapolated) = 3.31 W/kg
SAR(1 g) = 2.25 W/kg ; SAR(10 g) = 1.47 W/kg
Maximum value of SAR (measured) = 2.44 W/kg

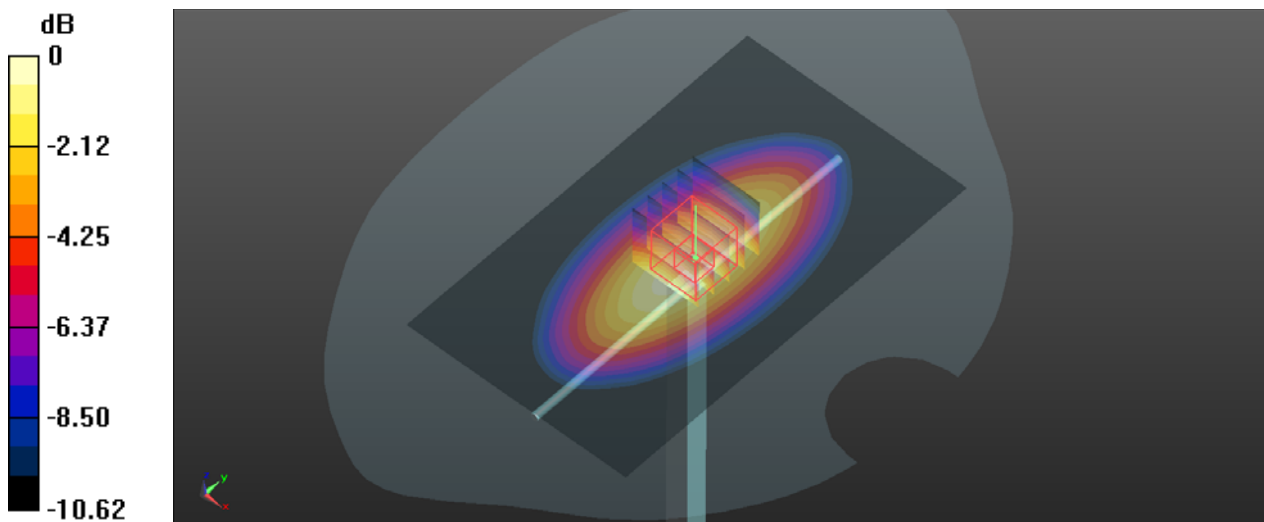

0 dB = 2.44 W/kg