

FCC Test Report

FCC ID : N7NBX3210
Equipment : AirPrime BX3210 Module
Brand Name : Sierra Wireless Inc.
Model Name : AirPrime BX3210 Module
Applicant/ Manufacturer : Sierra Wireless Inc.
13811 Wireless Way, Richmond,
BC V6V 3A4, Canada
Standard : 47 CFR FCC Part 15.247

The product was received on Feb. 27, 2019, and testing was started from Feb. 28, 2019 and completed on Mar. 06, 2019. We, SPORTON INTERNATIONAL INC. EMC & Wireless Communications Laboratory, would like to declare that the tested sample has been evaluated in accordance with the procedures given in ANSI C63.10-2013 and shown compliance with the applicable technical standards.

The report must not be used by the client to claim product certification, approval, or endorsement by TAF or any agency of government.

The test results in this report apply exclusively to the tested model / sample. Without written approval of SPORTON INTERNATIONAL INC. EMC & Wireless Communications Laboratory, the test report shall not be reproduced except in full.



Approved by: Allen Lin

SPORTON INTERNATIONAL INC. EMC & Wireless Communications Laboratory

No. 52, Huaya 1st Rd., Guishan Dist., Taoyuan City, Taiwan (R.O.C.)



Table of Contents

HISTORY OF THIS TEST REPORT3

SUMMARY OF TEST RESULT4

1 GENERAL DESCRIPTION5

1.1 Information.....5

1.2 Testing Applied Standards7

1.3 Testing Location Information7

1.4 Measurement Uncertainty7

2 TEST CONFIGURATION OF EUT.....8

2.1 Test Condition8

2.2 Test Channel Mode8

2.3 The Worst Case Measurement Configuration.....9

2.4 Support Equipment.....9

2.5 Test Setup Diagram10

3 TRANSMITTER TEST RESULT11

3.1 AC Power-line Conducted Emissions11

3.2 20dB Bandwidth and Carrier Frequency Separation.....13

3.3 Maximum Conducted Output Power14

3.4 Number of Hopping Frequencies and Hopping Bandedge15

3.5 Time of Occupancy (Dwell Time)16

3.6 Emissions in Non-restricted Frequency Bands17

3.7 Emissions in Restricted Frequency Bands.....18

4 TEST EQUIPMENT AND CALIBRATION DATA.....21

APPENDIX A. TEST RESULTS OF 20DB BANDWIDTH AND CARRIER FREQUENCY SEPARATION

APPENDIX B. TEST RESULTS OF MAXIMUM CONDUCTED OUTPUT POWER

APPENDIX C. TEST RESULTS OF NUMBER OF HOPPING FREQUENCIES AND HOPPING BANDEDGE

APPENDIX D. TEST RESULTS OF TIME OF OCCUPANCY (DWELL TIME)

APPENDIX E. TEST RESULTS OF EMISSIONS IN NON-RESTRICTED FREQUENCY BANDS

APPENDIX F. TEST RESULTS OF EMISSIONS IN RESTRICTED FREQUENCY BANDS

APPENDIX G. TEST PHOTOS

PHOTOGRAPHS OF EUT V01



Summary of Test Result

Report Clause	Ref. Std. Clause	Test Items	Result (PASS/FAIL)	Remark
1.1.2	15.203	Antenna Requirement	PASS	FCC 15.203
3.1	15.207	AC Power-line Conducted Emissions	Not Required	FCC 15.207
3.2	15.247(a)	20dB Bandwidth	PASS	15.247(a)
3.2	15.247(a)	Carrier Frequency Separation	PASS	15.247(a)
3.3	15.247(b)	Maximum Conducted Output Power	PASS	15.247(b)
3.4	15.247(a)	Number of Hopping Frequencies and Hopping Bandedge	PASS	15.247(a)
3.5	15.247(a)	Time of Occupancy (Dwell Time)	PASS	15.247(a)
3.6	15.247(d)	Emissions in Non-restricted Frequency Bands	PASS	15.247(d)
3.7	15.247(d)	Emissions in Restricted Frequency Bands	PASS	Restricted Bands: FCC 15.209

Declaration of Conformity:
The test results with all measurement uncertainty excluded are presented in accordance with the regulation limits or requirements declared by manufacturers.
Comments and explanations:
None

Reviewed by: Jackson Tsai

Report Producer: Michelle Tsai

1 General Description

1.1 Information

1.1.1 RF General Information

Frequency Range (MHz)	Bluetooth Version	Ch. Frequency (MHz)	Channel Number
2400-2483.5	BR / EDR	2402-2480	0-78 [79]

Band	Mode	BWch (MHz)	Nant
2.4-2.4835GHz	BT-BR(1Mbps)	1	1TX
2.4-2.4835GHz	BT-EDR(2Mbps)	1	1TX
2.4-2.4835GHz	BT-EDR(3Mbps)	1	1TX

Note:

- ◆ Bluetooth BR uses a GFSK (1Mbps).
- ◆ Bluetooth EDR uses a combination of $\pi/4$ -DQPSK (2Mbps) and 8DPSK (3Mbps).
- ◆ Bluetooth BR/EDR uses as a system using FHSS modulation.
- ◆ BWch is the nominal channel bandwidth.

1.1.2 Antenna Information

Ant.	Brand	Model Name	Antenna Type	Connector
1	SmartAnt	USI05-220170	Dipole	Reversed-SMA

Ant.	Port	Gain (dBi)		
		2.4G	BT	5G
1	1	2.5	2.5	5

For 2.4GHz function:

For IEEE 802.11 b/g/n mode (1TX/1RX)

Ant. 1 (port 1) and could transmit/receive simultaneously.

For BT function:

For IEEE 802.15.1 Bluetooth mode (1TX/1RX)

Ant. 1 (port 1) and could transmit/receive simultaneously.

For 5GHz function:

For IEEE 802.11 a/n/ac mode (1TX/1RX)

Ant. 1 (port 1) and could transmit/receive simultaneously.



1.1.3 EUT Information

Operational Condition	
EUT Power Type	For DC Power Supply Mode
EUT Function	<input checked="" type="checkbox"/> Point-to-multipoint <input type="checkbox"/> Point-to-point
Type of EUT	
<input checked="" type="checkbox"/>	Stand-alone
<input type="checkbox"/>	Combined (EUT where the radio part is fully integrated within another device)
	Combined Equipment - Brand Name / Model No.: ...
<input type="checkbox"/>	Plug-in radio (EUT intended for a variety of host systems)
	Host System - Brand Name / Model No.: ...
<input type="checkbox"/>	Other:

1.1.4 Mode Test Duty Cycle

Mode	DC	DCF(dB)	T(s)	VBW(Hz) ≥ 1/T
BT-BR(1Mbps)	0.658	1.818	1.645m	1k
BT-EDR(2Mbps)	0.774	1.113	2.894m	1k
BT-EDR(3Mbps)	0.771	1.129	2.897m	1k

Note. If DC < 0.98, the DCF was added while measuring Output power and PSD.

1.2 Testing Applied Standards

According to the specifications of the manufacturer, the EUT must comply with the requirements of the following standards:

- ◆ 47 CFR FCC Part 15
- ◆ KDB 558074 D01 v05r01
- ◆ ANSI C63.10-2013

1.3 Testing Location Information

Testing Location			
<input checked="" type="checkbox"/>	HWA YA	ADD : No. 52, Huaya 1st Rd., Guishan Dist., Taoyuan City, Taiwan (R.O.C.)	
		TEL : 886-3-327-3456	FAX : 886-3-327-0973
Test site Designation No. TW1190 with FCC.			
<input type="checkbox"/>	JHUBEI	ADD : No.8, Ln. 724, Bo'ai St., Zhubei City, Hsinchu County, Taiwan (R.O.C.)	
		TEL : 886-3-656-9065	FAX : 886-3-656-9085
Test site Designation No. TW0006 with FCC.			

Test Condition	Test Site No.	Test Engineer	Test Environment	Test Date
RF Conducted	TH01-HY	Andy	20.7~23.5°C / 59.1~63.5%	05/Mar/2019~06/Mar/2019
Radiated	03CH03-HY	Edward	21.6~23.5°C / 55~60.6%	28/Feb/2019~05/Mar/2019

1.4 Measurement Uncertainty

ISO/IEC 17025 requires that an estimate of the measurement uncertainties associated with the emissions test results be included in the report. The measurement uncertainties given below are based on a 95% confidence level (based on a coverage factor (k=2))

Test Items	Uncertainty	Remark
Conducted Emission (150kHz ~ 30MHz)	3.54 dB	Confidence levels of 95%
Radiated Emission (9kHz ~ 30MHz)	1.6 dB	Confidence levels of 95%
Radiated Emission (30MHz ~ 1,000MHz)	4.3 dB	Confidence levels of 95%
Radiated Emission (1GHz ~ 18GHz)	3.9 dB	Confidence levels of 95%
Radiated Emission (18GHz ~ 40GHz)	3.5 dB	Confidence levels of 95%
Conducted Emission	1.3 dB	Confidence levels of 95%
Temperature	0.7 °C	Confidence levels of 95%
Humidity	4 %	Confidence levels of 95%



2 Test Configuration of EUT

2.1 Test Condition

RF Conducted	Abbreviation	Remark
TnomVnom	Tnom	20°C
-	Vnom	3.3V

2.2 Test Channel Mode

Test Software	DoS
---------------	-----

Mode	PowerSetting
BT-BR(1Mbps)	-
2402MHz	9
2441MHz	9
2480MHz	9
BT-EDR(2Mbps)	-
2402MHz	9
2441MHz	9
2480MHz	9
BT-EDR(3Mbps)	-
2402MHz	9
2441MHz	9
2480MHz	9

2.3 The Worst Case Measurement Configuration

The Worst Case Mode for Following Conformance Tests	
Tests Item	20dB Bandwidth Carrier Frequency Separation Maximum Conducted Output Power Number of Hopping Frequencies Hopping Bandedge Time of Occupancy (Dwell Time) Emissions in Non-restricted Frequency Bands
Test Condition	Conducted measurement at transmit chains

The Worst Case Mode for Following Conformance Tests	
Tests Item	Emissions in Restricted Frequency Bands
Test Condition	Radiated measurement If EUT consist of multiple antenna assembly (multiple antenna are used in EUT regardless of spatial multiplexing MIMO configuration), the radiated test should be performed with highest antenna gain of each antenna type.
Operating Mode < 1GHz	CTX
1	DC Power Supply Mode
Operating Mode > 1GHz	CTX
Orthogonal Planes of EUT	Z Plane
	

2.4 Support Equipment

Support Equipment – RF Conducted				
No.	Equipment	Brand Name	Model Name	FCC ID
1	Notebook	DELL	E5410	DoC
2	Adapter for NB	DELL	HA65NM130	DoC
3	DC Power Supply	GW	GPS-3030DD	N/A

Support Equipment – Radiated Emission				
No.	Equipment	Brand Name	Model Name	FCC ID
1	DC Power Supply	GW	GPS-3030DD	N/A

2.5 Test Setup Diagram

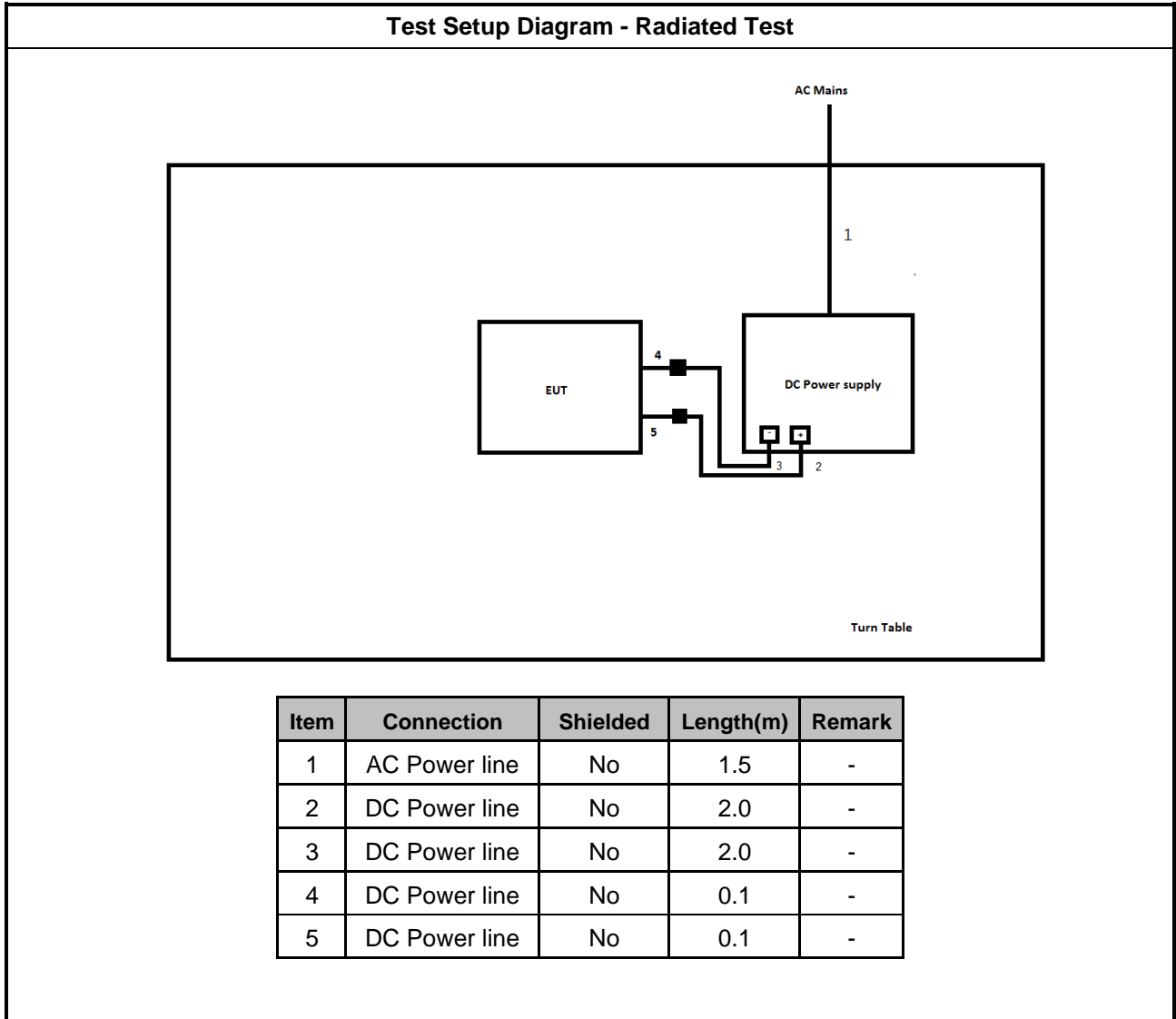

3 Transmitter Test Result

3.1 AC Power-line Conducted Emissions

3.1.1 AC Power-line Conducted Emissions Limit

AC Power-line Conducted Emissions Limit		
Frequency Emission (MHz)	Quasi-Peak	Average
0.15-0.5	66 - 56 *	56 - 46 *
0.5-5	56	46
5-30	60	50

Note 1: * Decreases with the logarithm of the frequency.

3.1.2 Measuring Instruments

Refer a test equipment and calibration data table in this test report.

3.1.3 Test Procedures

Test Method
<ul style="list-style-type: none"> Refer as ANSI C63.10-2013, clause 6.2 foray power-line conducted emissions.

3.1.4 Test Setup

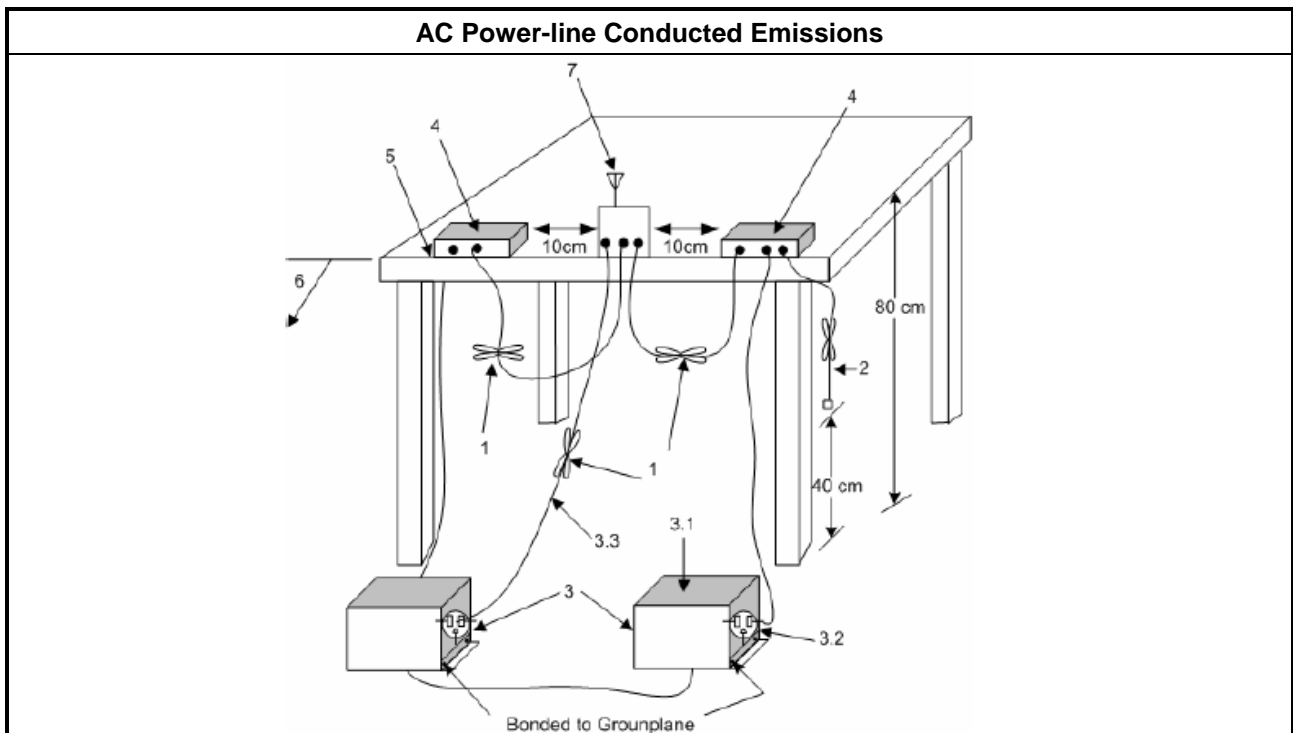



3.1.5 Test Result of AC Power-line Conducted Emissions

Please refer to FCC 15.207 which states, "Measurements to demonstrate compliance with the conducted limits are not required for devices employ DC power source for operation and which do not operate from the AC power lines or contain provisions for operation while connected to the AC power lines".

Therefore, for this device, AC Power Line Conducted Emissions investigation is not required.

3.2 20dB Bandwidth and Carrier Frequency Separation

3.2.1 20dB Bandwidth and Carrier Frequency Separation Limit

20dB Bandwidth and Carrier Frequency Separation Limit for Frequency Hopping Systems	
<ul style="list-style-type: none"> 2400-2483.5 MHz Band: 	
	<ul style="list-style-type: none"> $N \geq 75$ and $ChS \geq MAX$ (20 dB bandwidth, 25 kHz).
	<ul style="list-style-type: none"> $75 > N \geq 15$ and $ChS \geq MAX$ (20 dB bandwidth 2/3,25 kHz).
N: Number of Hopping Frequencies; ChS: Hopping Channel Separation	

3.2.2 Measuring Instruments

Refer a test equipment and calibration data table in this test report.

3.2.3 Test Procedures

Test Method
<ul style="list-style-type: none"> Refer as ANSI C63.10-2013, clause 6.9.2 for 20 dB bandwidth measurement.
<ul style="list-style-type: none"> Refer as ANSI C63.10-2013, clause 7.8.2 for carrier frequency separation measurement.

3.2.4 Test Setup

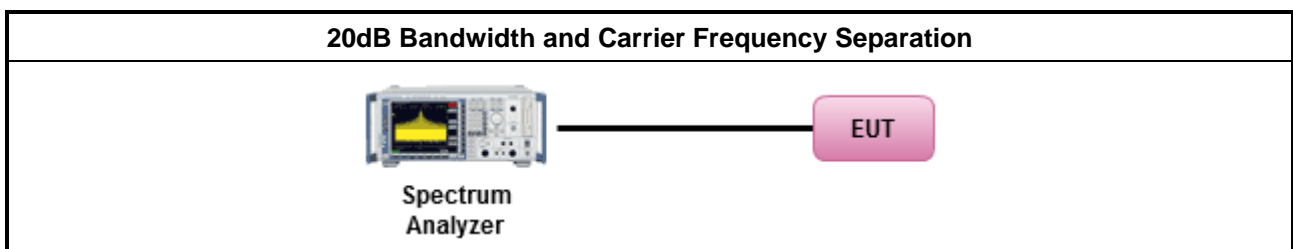

3.2.5 Test Result of 20dB Bandwidth

Refer as Appendix A

3.2.6 Test Result of Carrier Frequency Separation

Refer as Appendix A

3.3 Maximum Conducted Output Power

3.3.1 Maximum Conducted Output Power Limit

Maximum Conducted Output Power Limit	
<ul style="list-style-type: none"> 2400-2483.5 MHz Band: 	
	<ul style="list-style-type: none"> $N \geq 75$; Power 30dBm; EIRP 36dBm
	<ul style="list-style-type: none"> $75 > N \geq 15$; Power 21dBm; EIRP 27dBm
N: Number of Hopping Frequencies	

3.3.2 Measuring Instruments

Refer a test equipment and calibration data table in this test report.

3.3.3 Test Procedures

Test Method
<ul style="list-style-type: none"> Refer as ANSI C63.10-2013, clause 7.8.5 for output power measurement.

3.3.4 Test Setup

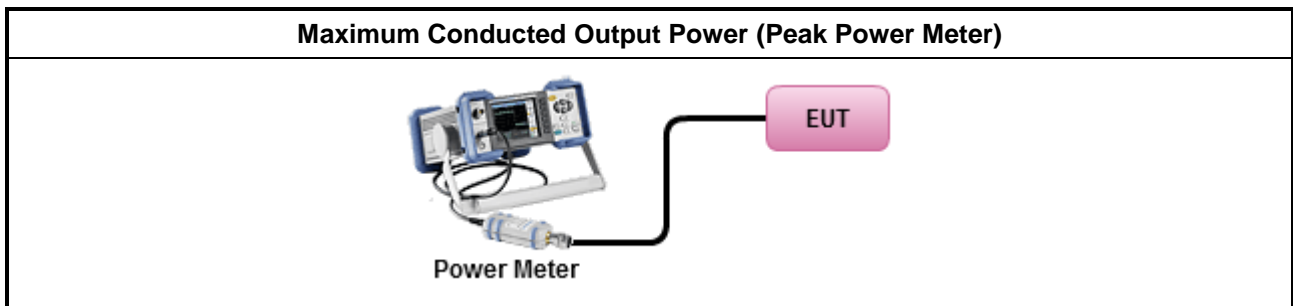

3.3.5 Test Result of Maximum Conducted Output Power

Refer as Appendix B

3.4 Number of Hopping Frequencies and Hopping Bandedge

3.4.1 Number of Hopping Frequencies Limit

Number of Hopping Frequencies Limit	
<ul style="list-style-type: none"> 2400-2483.5 MHz Band: 	
	<ul style="list-style-type: none"> $N \geq 75$ and $ChS \geq MAX$ (20 dB bandwidth, 25 kHz).
	<ul style="list-style-type: none"> $75 > N \geq 15$ and $ChS \geq MAX$ (20 dB bandwidth 2/3,25 kHz).
N: Number of Hopping Frequencies; ChS : Hopping Channel Separation	

3.4.2 Hopping Bandedge Limit

Refer clause 3.6.1 and clause 3.7.1

3.4.3 Measuring Instruments

Refer a test equipment and calibration data table in this test report.

3.4.4 Test Procedures

Test Method
<ul style="list-style-type: none"> Refer as ANSI C63.10-2013, clause 7.8.3 for number of hopping frequencies measurement.
<ul style="list-style-type: none"> Refer as ANSI C63.10-2013, clause 7.8.6 for hopping frequencies Bandedge measurement.

3.4.5 Test Setup

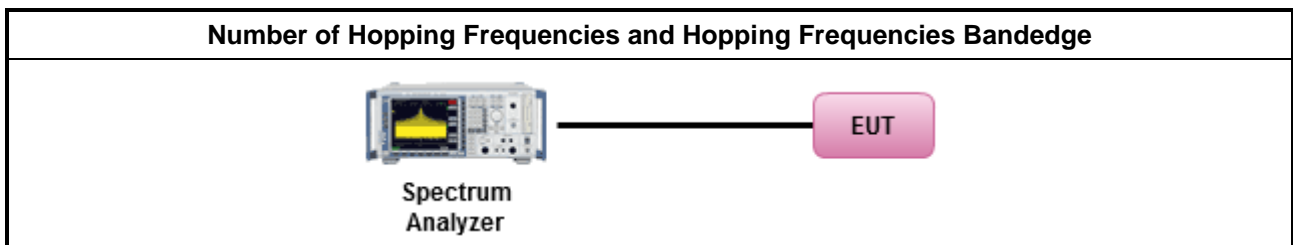

3.4.6 Test Result of Number of Hopping Frequencies

Refer as Appendix C

3.4.7 Test Result of Number of Hopping Frequencies Bandedge

Refer as Appendix C

3.5 Time of Occupancy (Dwell Time)

3.5.1 Time of Occupancy (Dwell Time) Limit

Time of Occupancy (Dwell Time) Limit for Frequency Hopping Systems	
<ul style="list-style-type: none"> 2400-2483.5 MHz Band: 	
	<ul style="list-style-type: none"> $N \geq 75$; 0.4s in $N \times 0.4$ period
	<ul style="list-style-type: none"> $75 > N \geq 15$; 0.4s in $N \times 0.4$ period
N: Number of Hopping Frequencies	

3.5.2 Measuring Instruments

Refer a test equipment and calibration data table in this test report.

3.5.3 Test Procedures

Test Method	
<ul style="list-style-type: none"> Refer as ANSI C63.10-2013, clause 7.8.4 for dwell time measurement. 	
<ul style="list-style-type: none"> Bluetooth ACL packets can be 1, 3, or 5 time slots. Following as dwell time. Operate DH5 at maximum dwell time and maximum duty cycle. 	
	<ul style="list-style-type: none"> The DH5 packet can cover up to 5 time slots. Operate DH5 at maximum dwell time and maximum duty cycle. A maximum length packet has duration of 5 time slots. The hopping rate is 1600 hops/second so the maximum dwell time is $5/1600$ seconds, or 3.125ms. DH5 Packet permit maximum $1600 / 79 / 6 = 3.37$ hops per second in each channel.

3.5.4 Test Setup

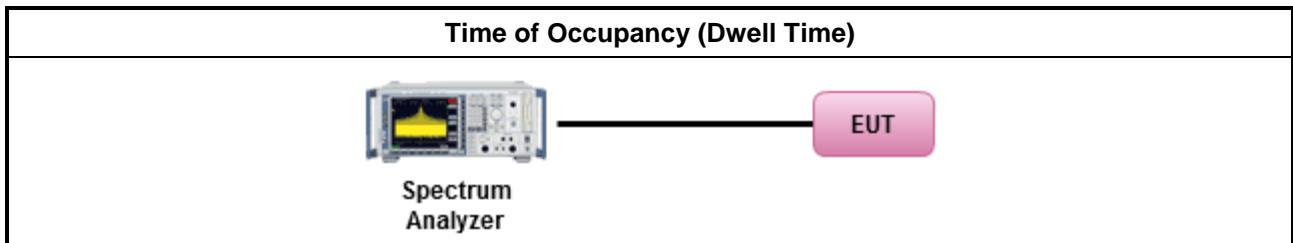

3.5.5 Test Result of Time of Occupancy (Dwell Time)

Refer as Appendix D

3.6 Emissions in Non-restricted Frequency Bands

3.6.1 Emissions in Non-restricted Frequency Bands Limit

Un-restricted Band Emissions Limit	
RF output power procedure	Limit (dB)
Peak output power procedure	20
Note 1: If the peak output power procedure is used to measure the fundamental emission power to demonstrate compliance to requirements, then the peak conducted output power measured within any 100 kHz outside the authorized frequency band shall be attenuated by at least 20 dB relative to the maximum measured in-band peak PSD level.	

3.6.2 Measuring Instruments

Refer a test equipment and calibration data table in this test report.

3.6.3 Test Procedures

Test Method
<ul style="list-style-type: none"> Refer as ANSI C63.10-2013, clause 7.8.8 for unwanted emissions into non-restricted bands.

3.6.4 Test Setup

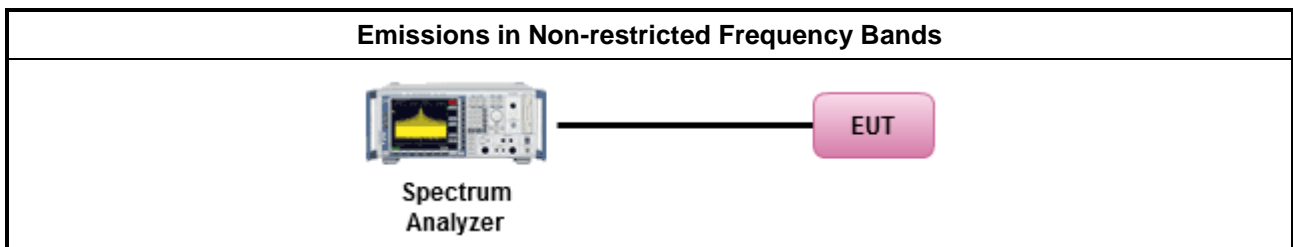

3.6.5 Test Result of Emissions in Non-restricted Frequency Bands

Refer as Appendix E

3.7 Emissions in Restricted Frequency Bands

3.7.1 Emissions in Restricted Frequency Bands Limit

Restricted Band Emissions Limit			
Frequency Range (MHz)	Field Strength (uV/m)	Field Strength (dBuV/m)	Measure Distance (m)
0.009~0.490	2400/F(kHz)	48.5 - 13.8	300
0.490~1.705	24000/F(kHz)	33.8 - 23	30
1.705~30.0	30	29	30
30~88	100	40	3
88~216	150	43.5	3
216~960	200	46	3
Above 960	500	54	3

Note 1: Test distance for frequencies at or above 30 MHz, measurements may be performed at a distance other than the limit distance provided they are not performed in the near field and the emissions to be measured can be detected by the measurement equipment. When performing measurements at a distance other than that specified, the results shall be extrapolated to the specified distance using an extrapolation factor of 20 dB/decade (inverse of linear distance for field-strength measurements, inverse of linear distance-squared for power-density measurements).

Note 2: Test distance for frequencies at below 30 MHz, measurements may be performed at a distance closer than the EUT limit distance; however, an attempt should be made to avoid making measurements in the near field. When performing measurements below 30 MHz at a closer distance than the limit distance, the results shall be extrapolated to the specified distance by either making measurements at a minimum of two or more distances on at least one radial to determine the proper extrapolation factor or by using the square of an inverse linear distance extrapolation factor (40 dB / decade). The test report shall specify the extrapolation method used to determine compliance of the EUT.

Note 3: Using the distance of 1m during the test for above 18 GHz, and the test value to correct for the distance factor at 3m.

3.7.2 Measuring Instruments

Refer a test equipment and calibration data table in this test report.

3.7.3 Test Procedures

Test Method	
	<ul style="list-style-type: none"> ▪ The average emission levels shall be measured in [hopping duty factor].
	<ul style="list-style-type: none"> ▪ Refer as ANSI C63.10; clause 6.10.3 band-edge testing shall be performed at the lowest frequency channel and highest frequency channel within the allowed operating band.
	<ul style="list-style-type: none"> ▪ For the transmitter unwanted emissions shall be measured using following options below: <ul style="list-style-type: none"> ▪ Refer as ANSI C63.10, clause 4.1.4.2.1 QP value. ▪ Refer as ANSI C63.10, clause 4.1.4.2.2 measurement procedure peak. ▪ Refer as ANSI C63.10, clause 4.1.4.2.4 average value of hopping pulsed emissions.

3.7.4 Test Setup

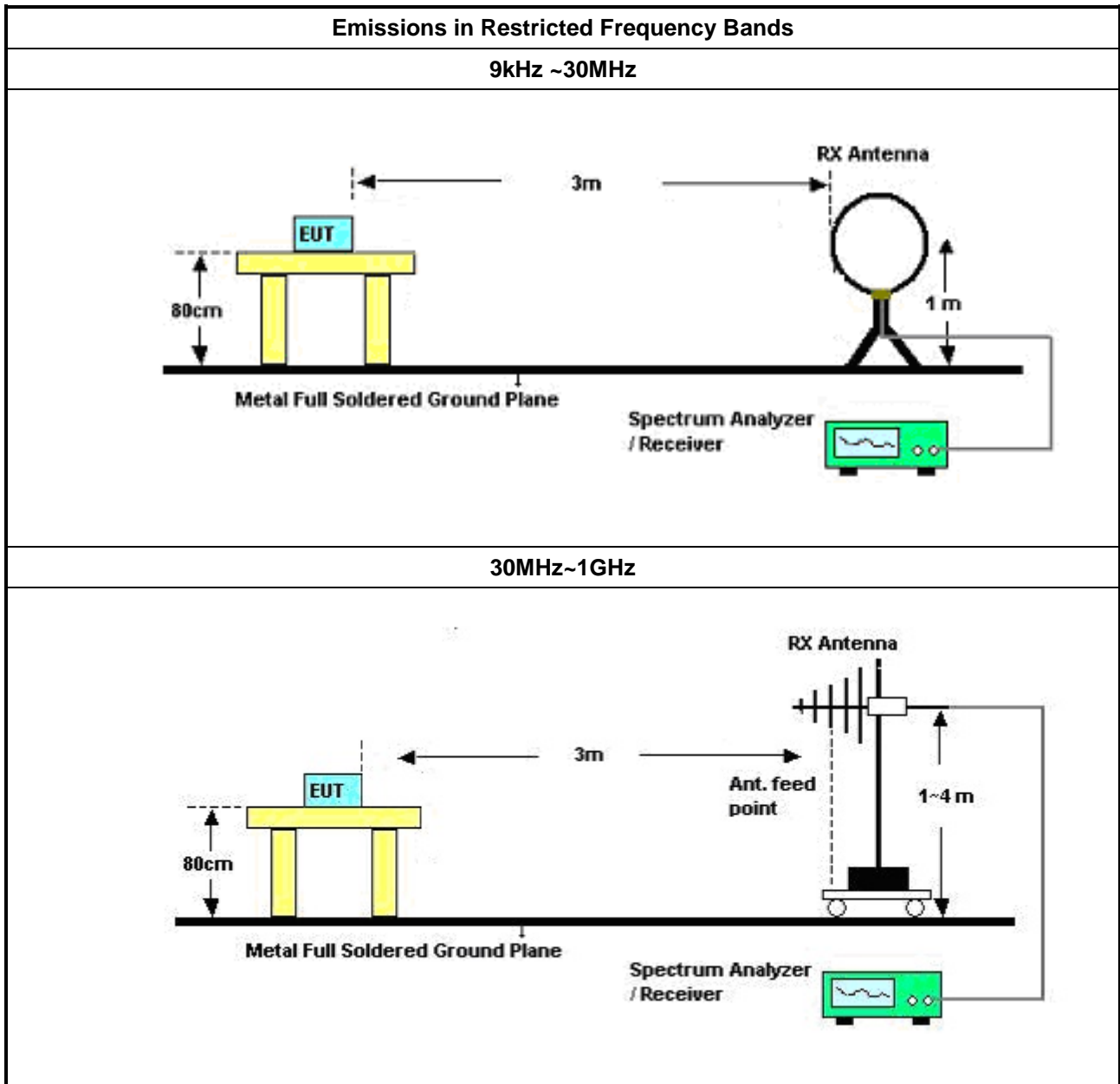

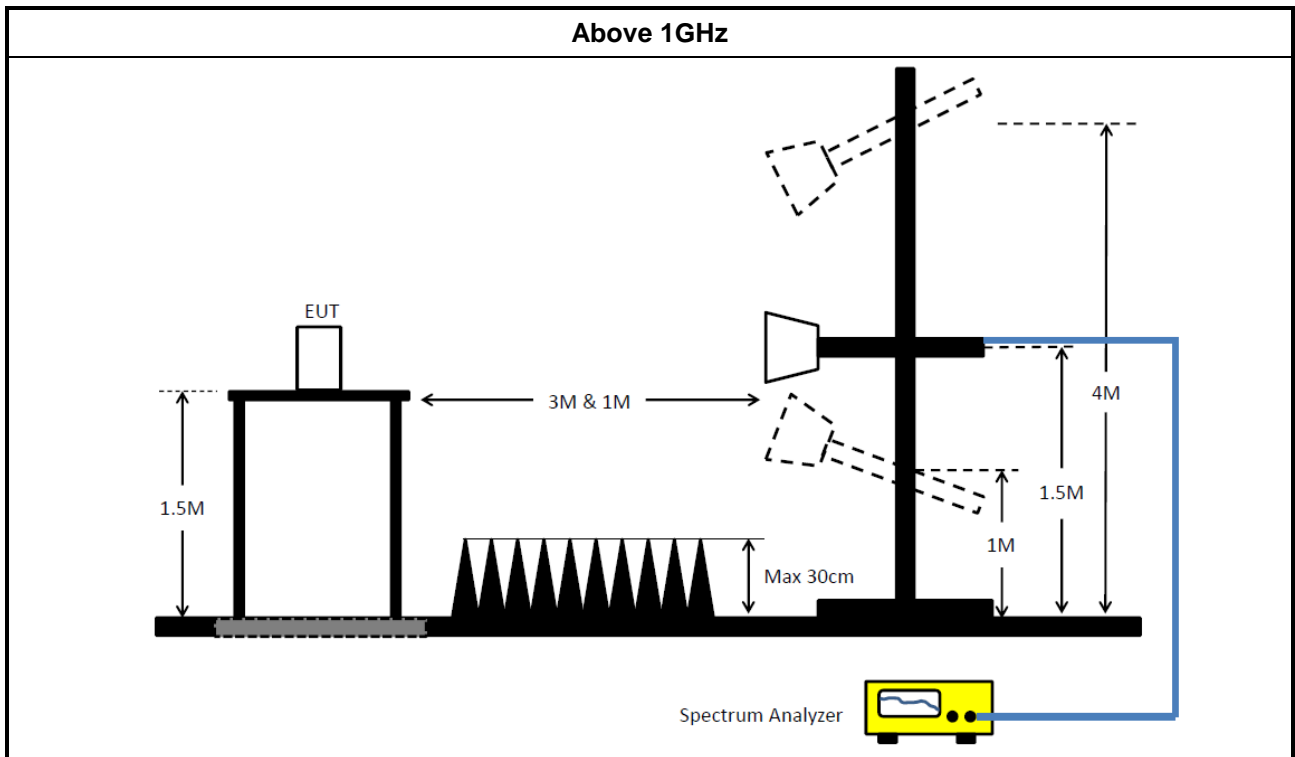

3.7.5 Test Result of Emissions in Restricted Frequency Bands (Below 30MHz)

The amplitude of spurious emissions which are attenuated by more than 20dB below the permissible value has no need to be reported.

3.7.6 Test Result of Emissions in Restricted Frequency Bands

Refer as Appendix F

4 Test Equipment and Calibration Data

Instrument for Radiated Test

Instrument	Manufacturer	Model No.	Serial No.	Spec.	Calibration Date	Calibration Due Date
3m Semi Anechoic Chamber	SIDT FRANKONIA	SAC-3M	03CH03-HY	30MHz ~ 1GHz 3m	30/Oct/2018	29/Oct/2019
3m Semi Anechoic Chamber	SIDT FRANKONIA	SAC-3M	03CH03-HY	1GHz ~ 18GHz 3m	30/Oct/2018	29/Oct/2019
Amplifier	IFI	SCCX150	03CH03-HY	10KHz ~ 100MHz	14/Sep/2017	13/Sep/2019
Amplifier	HP	8447D	2944A08033	10kHz ~ 1.3GHz	23/Apr/2018	19/Apr/2019
EMI Test Receiver	R&S	ESR3	102052	9kHz ~ 3.6GHz	10/Apr/2018	09/Apr/2019
Bilog Antenna with 5dB Pad	ETS	3142B & MTJ6102-05	00022055	26 MHz - 3 GHz	19/Nov/2018	18/Nov/2019
Microwave System Pre-amplifier	KEYSIGHT	83017A	MY53270196	1GHz ~ 26.5GHz	05/Sep/2018	04/Sep/2019
Signal Analyzer	R&S	FSV40	101500	10Hz ~ 40GHz	18/Jul/2018	17/Jul/2019
RF Cable-R03m	Jye Bao	RG142	CB021	9kHz ~ 1GHz	28/Jan/2019	27/Jan/2020
RF Cable-high	SUHNER	SUCOFLEX 106	CB222	1GHz ~ 40GHz	28/Jan/2019	27/Jan/2020
Broadband Horn Antenna	SCHWARZBECK	BBHA 9170	BBHA 9170221	15GHz ~ 40GHz	12/Mar/2018	11/Mar/2019
Double Ridged Guide Horn Antenna	SCHWARZBECK	BBHA 9120 D	BBHA 9120 D 1531	1GHz ~ 18GHz	18/Apr/ 2018	17/Apr/2019
Pre-amplifier	MITEQ	TTA1840-35-HG	1864481	18GHz ~ 40GHz	24/Aug/2018	23/Aug/2019
Loop Antenna	TESEQ	HLA 6120	31244	9kHz ~ 30MHz	28/Mar/2018	27/Mar/2019

Instrument for Conducted Test

Instrument	Manufacturer	Model No.	Serial No.	Spec.	Calibration Date	Calibration Due Date
Spectrum Analyzer	R&S	FSV 40	101500	10Hz~40GHz	18/Jul/2018	17/Jul/2019
Power Sensor	Anritsu	MA2411B	1339407	300MHz ~ 40GHz	17/Nov/2018	16/Nov/2019
Power Meter	Anritsu	ML2495A	1517010	300MHz ~ 40GHz	17/Nov/2018	16/Nov/2019
Cable 0.2m	HUBER	MY10710/4	RF Cable - 01	30MHz ~18G	10/Jan/2019	09/Jan/2020
Cable 0.2m	HUBER	MY10711/4	RF Cable - 02	30MHz ~18G	10/Jan/2019	09/Jan/2020
Cable 0.5m	HUBER	MY39470/4	RF Cable - 29	30MHz ~18G	10/Jan/2019	09/Jan/2020
SMB100A Signal Generator	R&S	SMB100A03	181147	100kHz~40GHz	12/Nov/2018	10/Nov/2020



Summary

Mode	Max-N dB (Hz)	Max-OBW (Hz)	ITU-Code	Min-N dB (Hz)	Min-OBW (Hz)
2.4-2.4835GHz	-	-	-	-	-
BT-BR(1Mbps)	918.75k	903.298k	903KF1D	913.75k	898.301k
BT-EDR(2Mbps)	1.31M	1.192M	1M19G1D	1.305M	1.186M
BT-EDR(3Mbps)	1.256M	1.202M	1M20G1D	1.254M	1.188M

Max-N dB = Maximum 20dB down bandwidth; **Max-OBW** = Maximum 99% occupied bandwidth;
Min-N dB = Minimum 20dB down bandwidth; **Min-OBW** = Minimum 99% occupied bandwidth;

Result

Mode	Result	Limit (Hz)	Port 1-N dB (Hz)	Port 1-OBW (Hz)
BT-BR(1Mbps)	-	-	-	-
2402MHz_TnomVnom	Pass	Inf	917.5k	899.55k
2441MHz_TnomVnom	Pass	Inf	913.75k	898.301k
2480MHz_TnomVnom	Pass	Inf	918.75k	903.298k
BT-EDR(2Mbps)	-	-	-	-
2402MHz_TnomVnom	Pass	Inf	1.31M	1.192M
2441MHz_TnomVnom	Pass	Inf	1.309M	1.186M
2480MHz_TnomVnom	Pass	Inf	1.305M	1.192M
BT-EDR(3Mbps)	-	-	-	-
2402MHz_TnomVnom	Pass	Inf	1.254M	1.202M
2441MHz_TnomVnom	Pass	Inf	1.255M	1.196M
2480MHz_TnomVnom	Pass	Inf	1.256M	1.188M

Port X-N dB = Port X 20dB down bandwidth; **Port X-OBW** = Port X 99% occupied bandwidth;

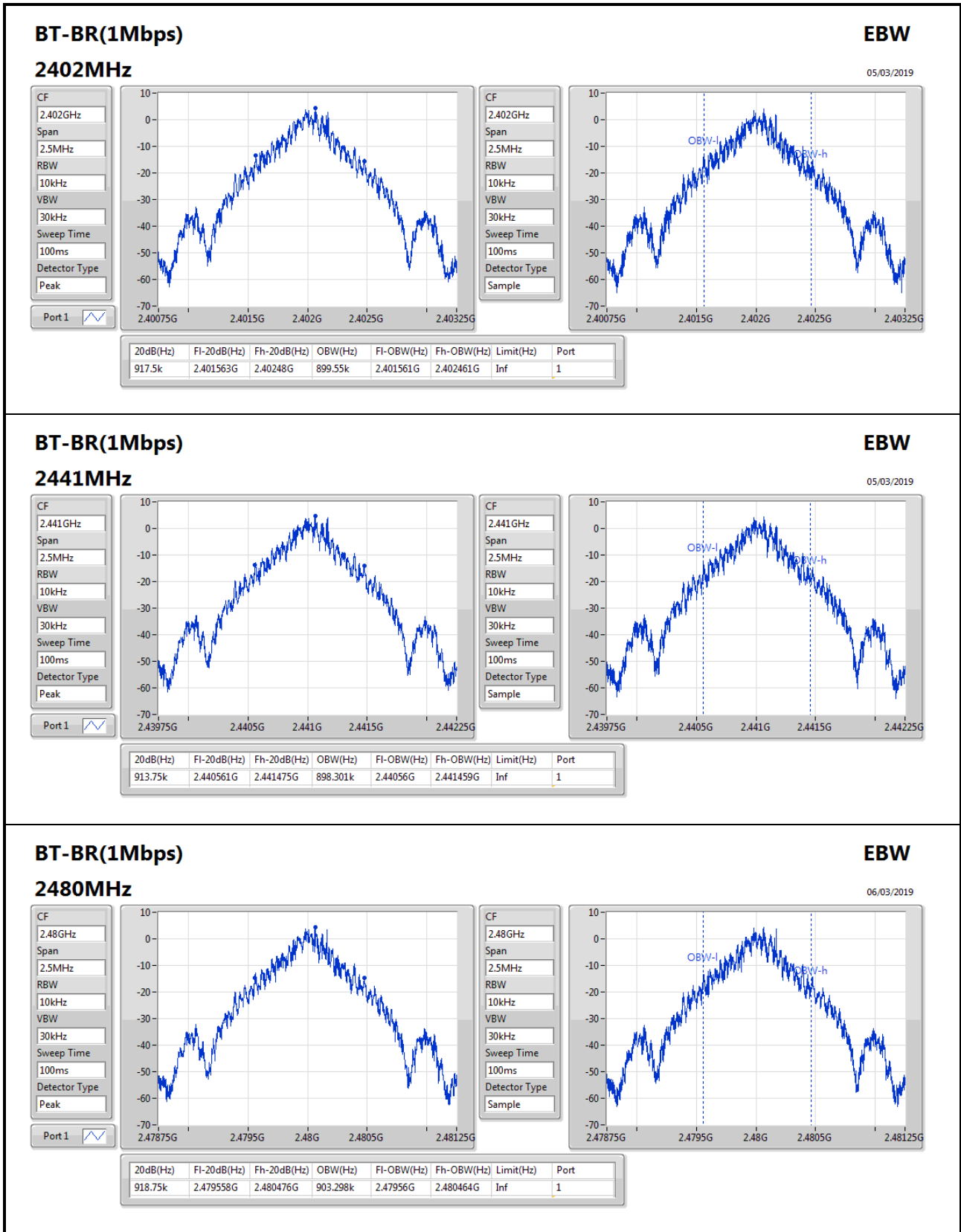

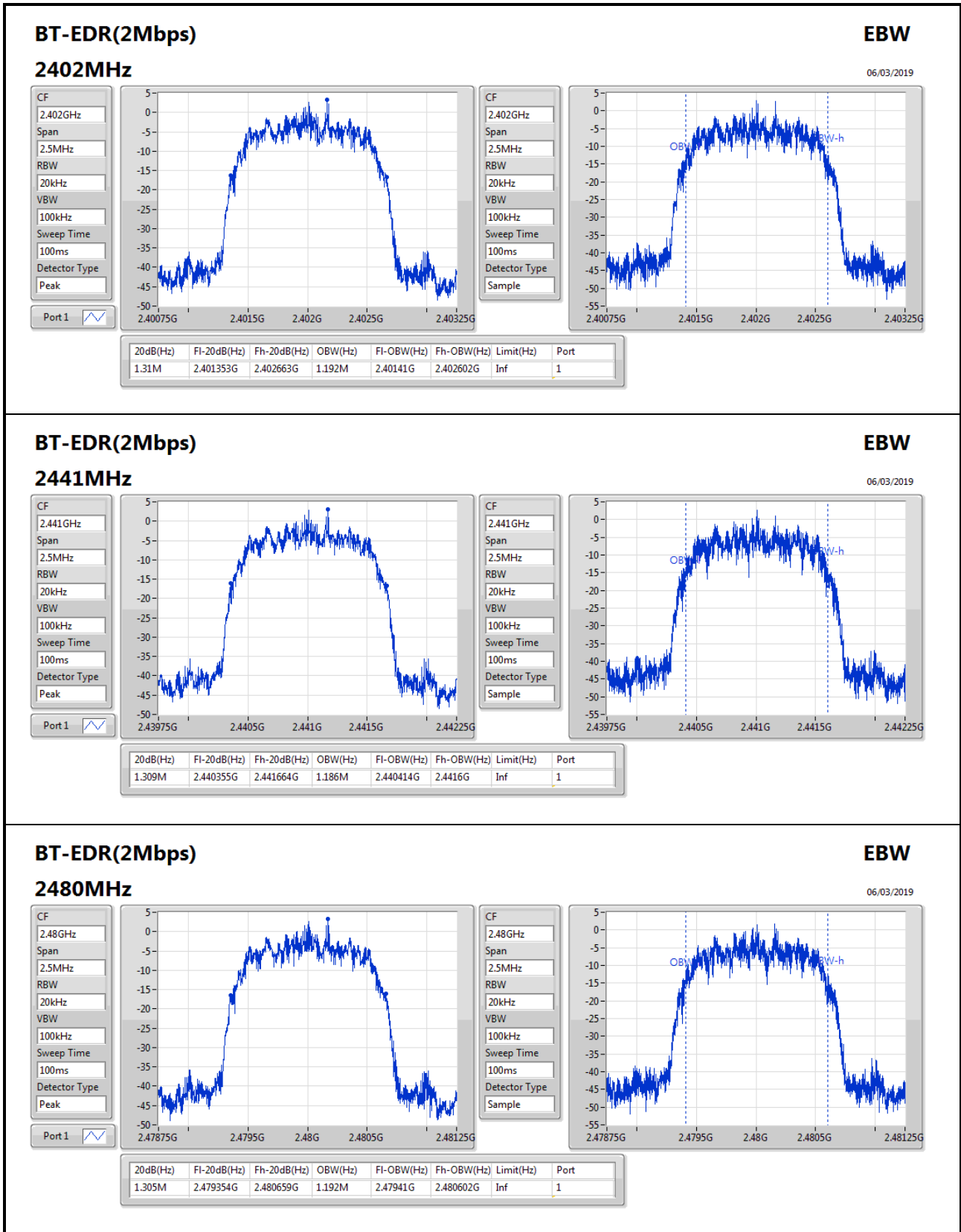

BT-EDR(2Mbps)
EBW

06/03/2019

2480MHz

CF: 2.48GHz
Span: 2.5MHz
RBW: 20kHz
VBW: 100kHz
Sweep Time: 100ms
Detector Type: Peak

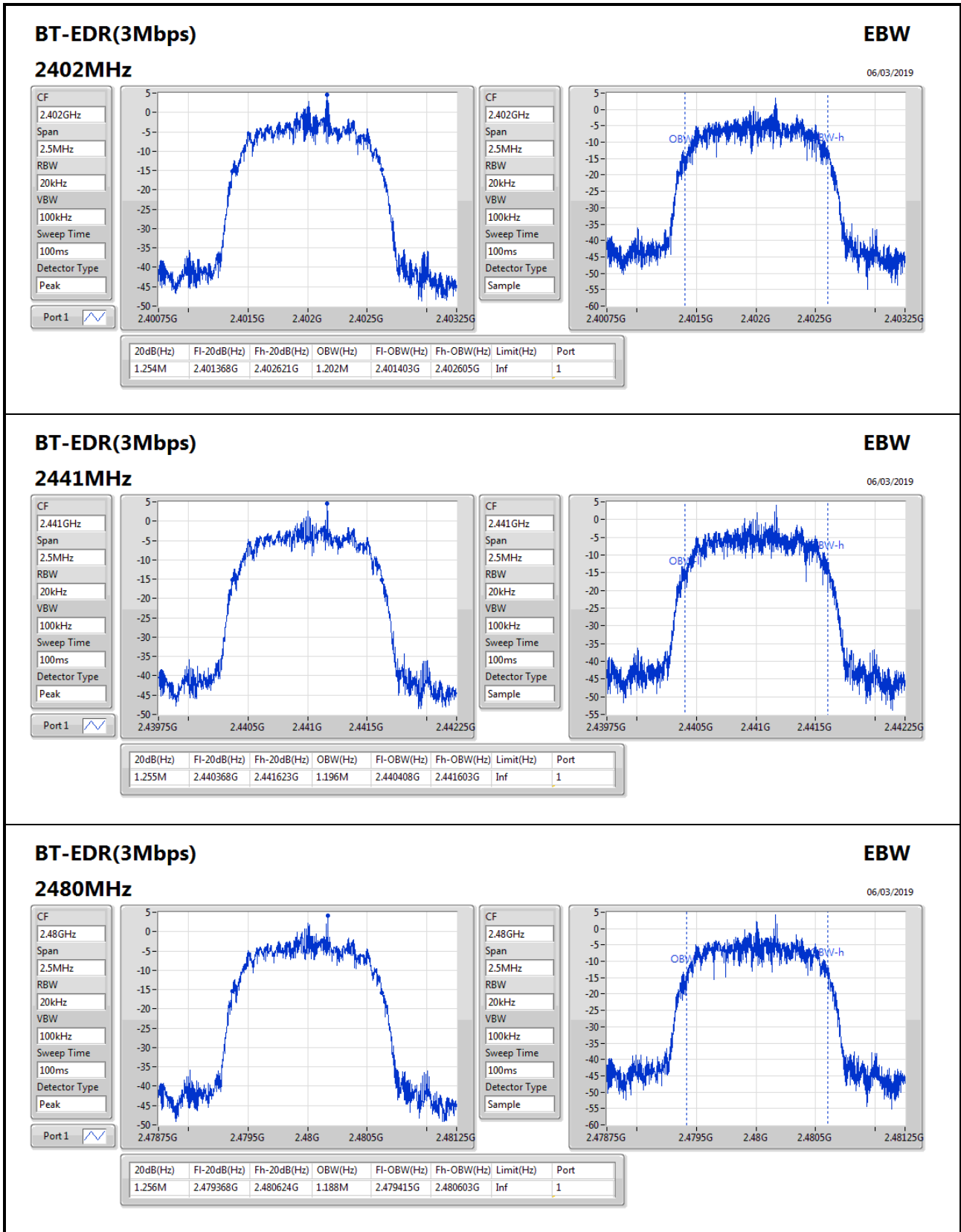
CF: 2.48GHz
Span: 2.5MHz
RBW: 20kHz
VBW: 100kHz
Sweep Time: 100ms
Detector Type: Sample





Summary

Mode	Max-Space (Hz)	Min-Space (Hz)
2.4-2.4835GHz	-	-
BT-BR(1Mbps)	1.005M	1.0005M
BT-EDR(2Mbps)	1.0035M	1.0005M
BT-EDR(3Mbps)	1.0035M	999k

Result

Mode	Result	Fl (Hz)	Fh (Hz)	Ch.Space (Hz)	Limit (Hz)
BT-BR(1Mbps)	-	-	-	-	-
2402MHz_TnomVnom	Pass	2.402167G	2.403168G	1.0005M	611.055k
2441MHz_TnomVnom	Pass	2.441167G	2.442172G	1.005M	608.5575k
2480MHz_TnomVnom	Pass	2.479167G	2.480168G	1.0005M	611.8875k
BT-EDR(2Mbps)	-	-	-	-	-
2402MHz_TnomVnom	Pass	2.402166G	2.403169G	1.0035M	872.46k
2441MHz_TnomVnom	Pass	2.441166G	2.442168G	1.002M	871.794k
2480MHz_TnomVnom	Pass	2.479167G	2.480168G	1.0005M	869.13k
BT-EDR(3Mbps)	-	-	-	-	-
2402MHz_TnomVnom	Pass	2.402166G	2.403168G	1.002M	835.164k
2441MHz_TnomVnom	Pass	2.441164G	2.442168G	1.0035M	835.83k
2480MHz_TnomVnom	Pass	2.479166G	2.480165G	999k	836.496k

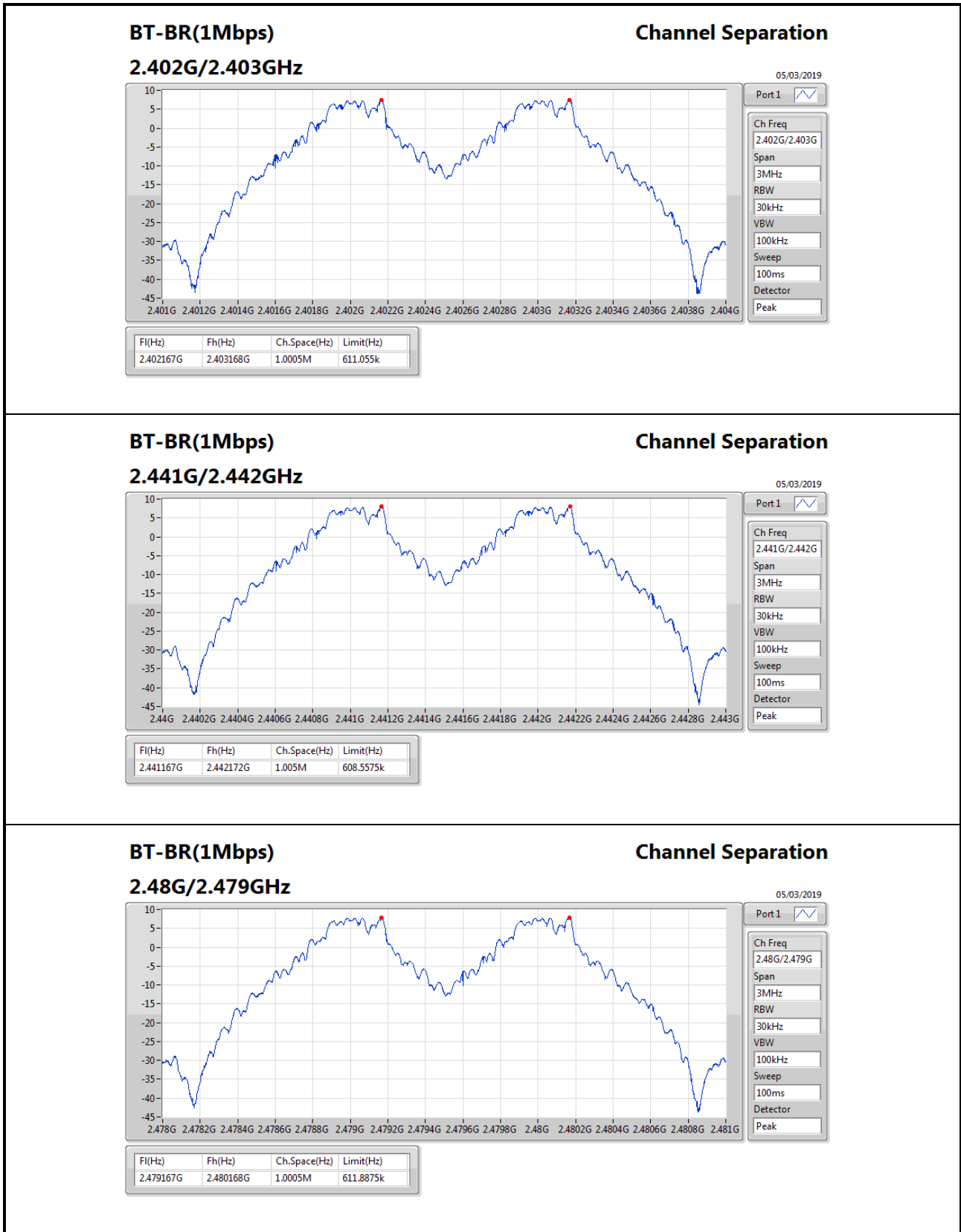

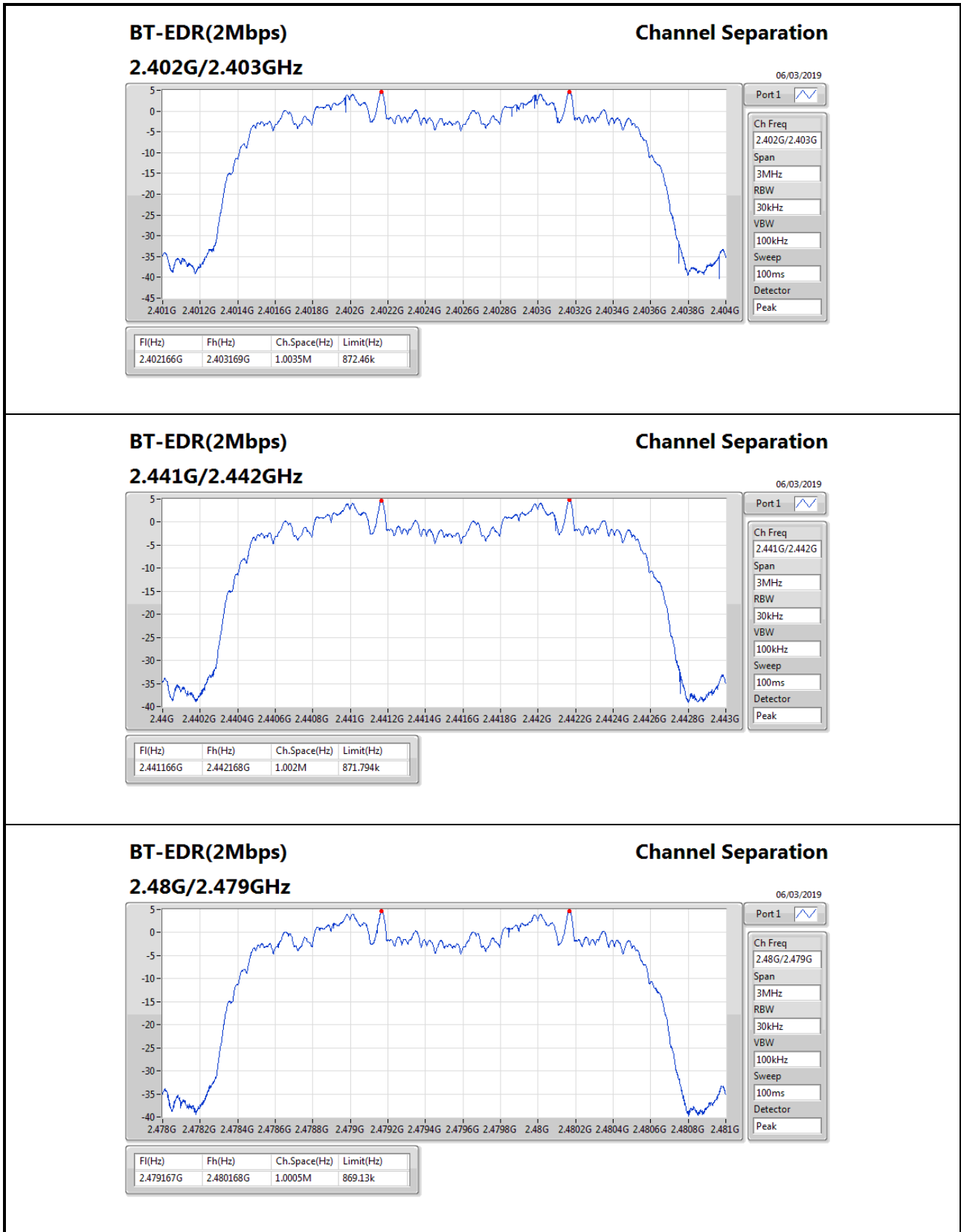

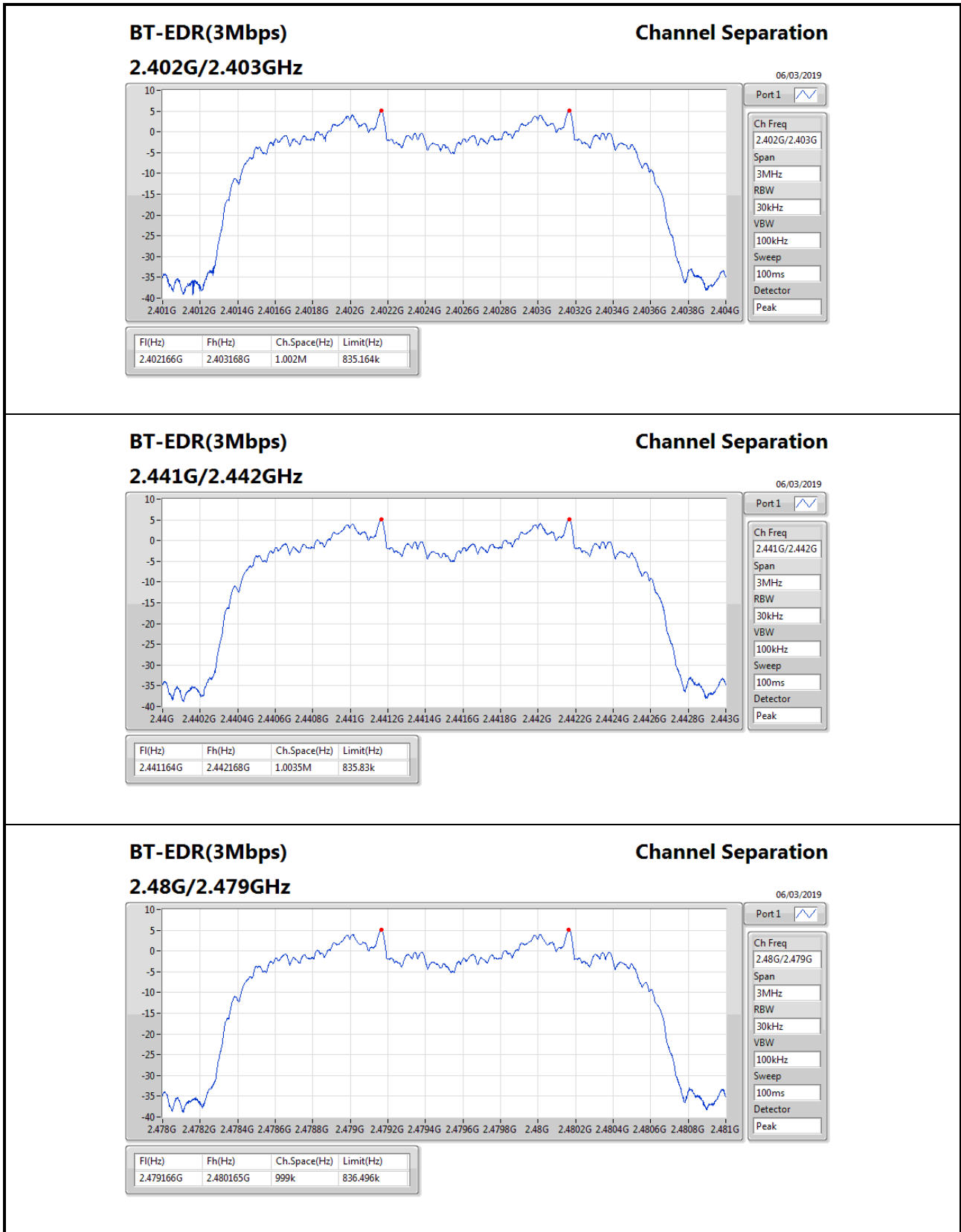



Summary

Mode	Power (dBm)	Power (W)
2.4-2.4835GHz	-	-
BT-BR(1Mbps)	10.79	0.01199
BT-EDR(2Mbps)	9.79	0.00953
BT-EDR(3Mbps)	10.22	0.01052

Result

Mode	Result	Gain (dBi)	Power (dBm)	Power Limit (dBm)
BT-BR(1Mbps)	-	-	-	-
2402MHz_TnomVnom	Pass	2.50	10.69	21.00
2441MHz_TnomVnom	Pass	2.50	10.79	21.00
2480MHz_TnomVnom	Pass	2.50	10.73	21.00
BT-EDR(2Mbps)	-	-	-	-
2402MHz_TnomVnom	Pass	2.50	9.66	21.00
2441MHz_TnomVnom	Pass	2.50	9.79	21.00
2480MHz_TnomVnom	Pass	2.50	9.69	21.00
BT-EDR(3Mbps)	-	-	-	-
2402MHz_TnomVnom	Pass	2.50	10.11	21.00
2441MHz_TnomVnom	Pass	2.50	10.22	21.00
2480MHz_TnomVnom	Pass	2.50	10.17	21.00



Summary

Mode	Power (dBm)	Power (W)
2.4-2.4835GHz	-	-
BT-BR(1Mbps)	10.48	0.01117
BT-EDR(2Mbps)	7.12	0.00515
BT-EDR(3Mbps)	7.06	0.00508

Result

Mode	Result	Gain (dBi)	Power (dBm)	Power Limit (dBm)
BT-BR(1Mbps)	-	-	-	-
2402MHz_TnomVnom	Pass	2.50	10.35	21.00
2441MHz_TnomVnom	Pass	2.50	10.48	21.00
2480MHz_TnomVnom	Pass	2.50	10.41	21.00
BT-EDR(2Mbps)	-	-	-	-
2402MHz_TnomVnom	Pass	2.50	6.98	21.00
2441MHz_TnomVnom	Pass	2.50	7.12	21.00
2480MHz_TnomVnom	Pass	2.50	7.00	21.00
BT-EDR(3Mbps)	-	-	-	-
2402MHz_TnomVnom	Pass	2.50	6.94	21.00
2441MHz_TnomVnom	Pass	2.50	7.06	21.00
2480MHz_TnomVnom	Pass	2.50	6.98	21.00



Summary

Mode	Max-Hop No
2.4-2.4835GHz	-
BT-BR(1Mbps)	79
BT-EDR(2Mbps)	79
BT-EDR(3Mbps)	79

Result

Mode	Result	Hopping No	Limit
BT-BR(1Mbps)	-	-	-
2441MHz_TnomVnom	Pass	79	15
BT-EDR(2Mbps)	-	-	-
2441MHz_TnomVnom	Pass	79	15
BT-EDR(3Mbps)	-	-	-
2441MHz_TnomVnom	Pass	79	15

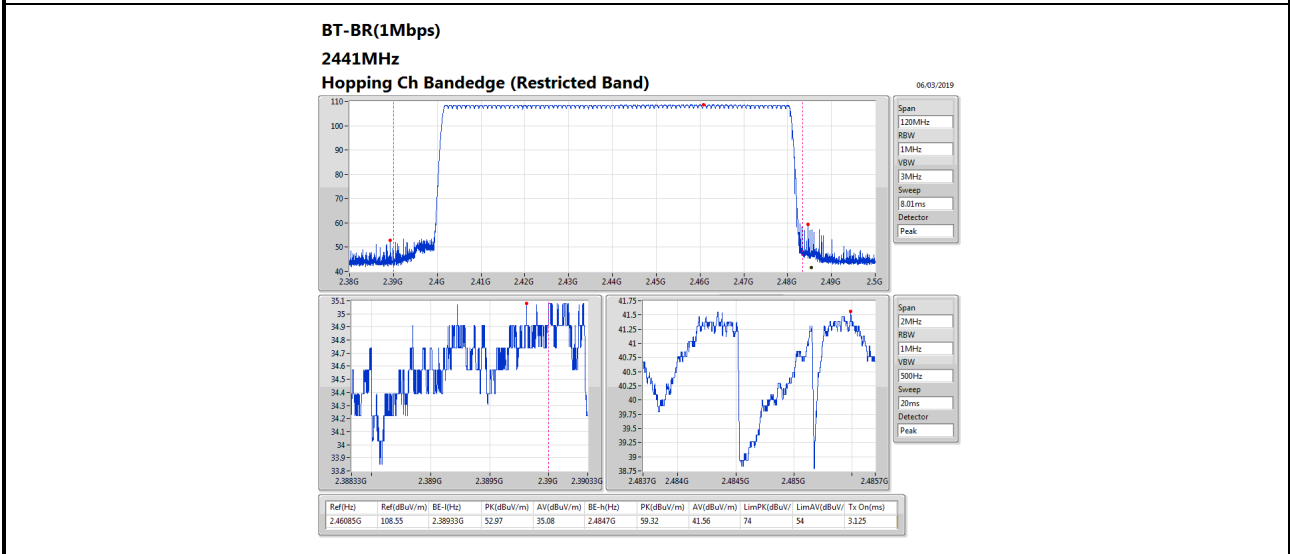
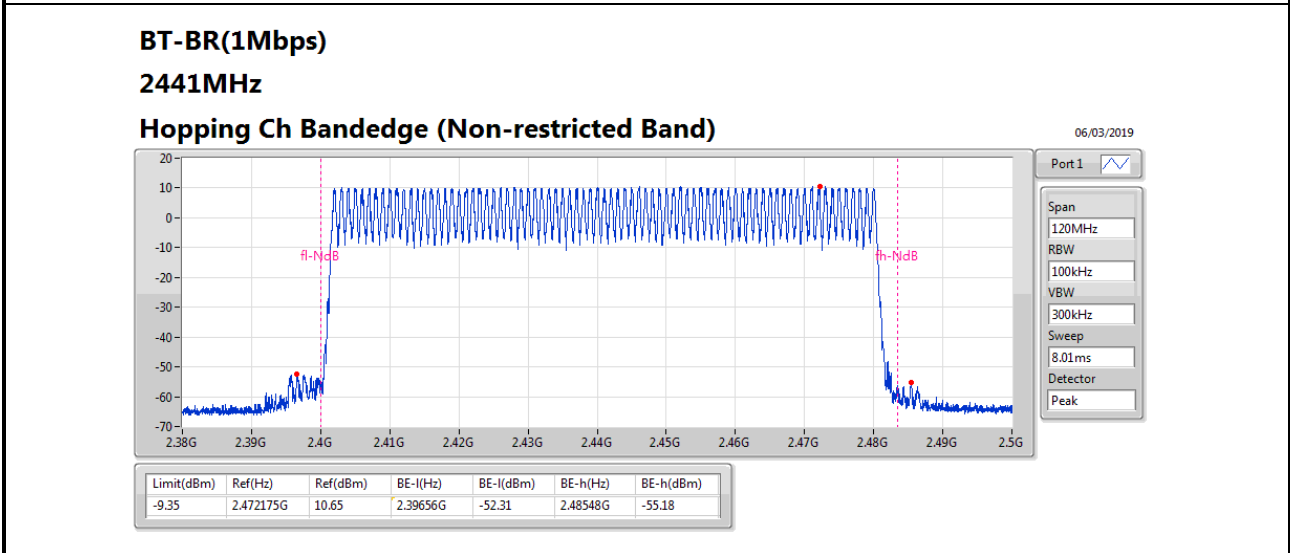
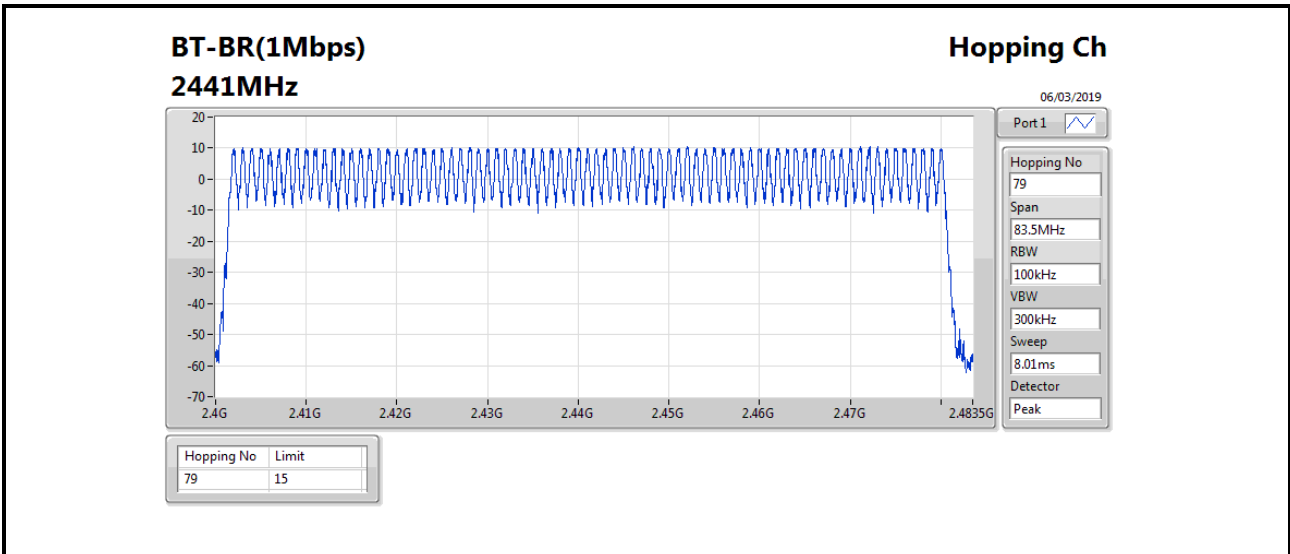

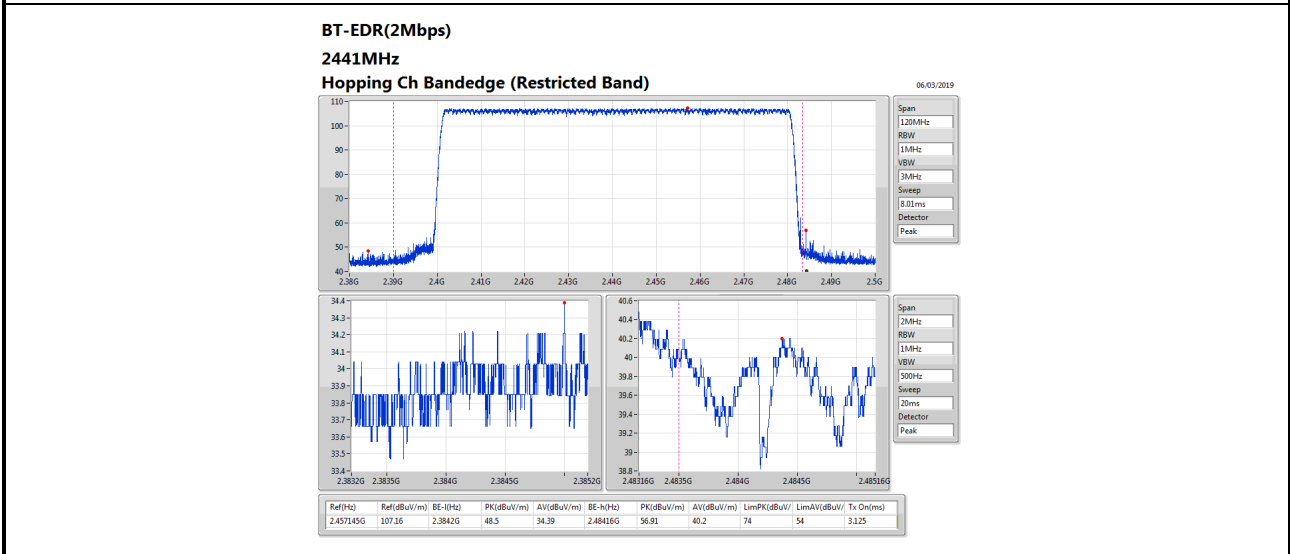
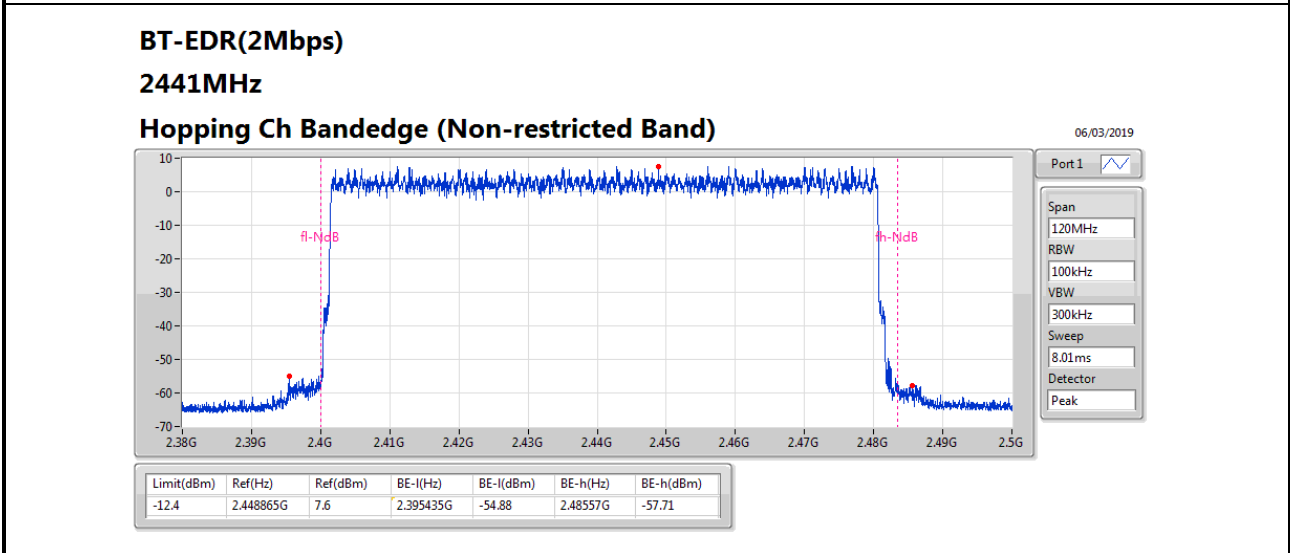
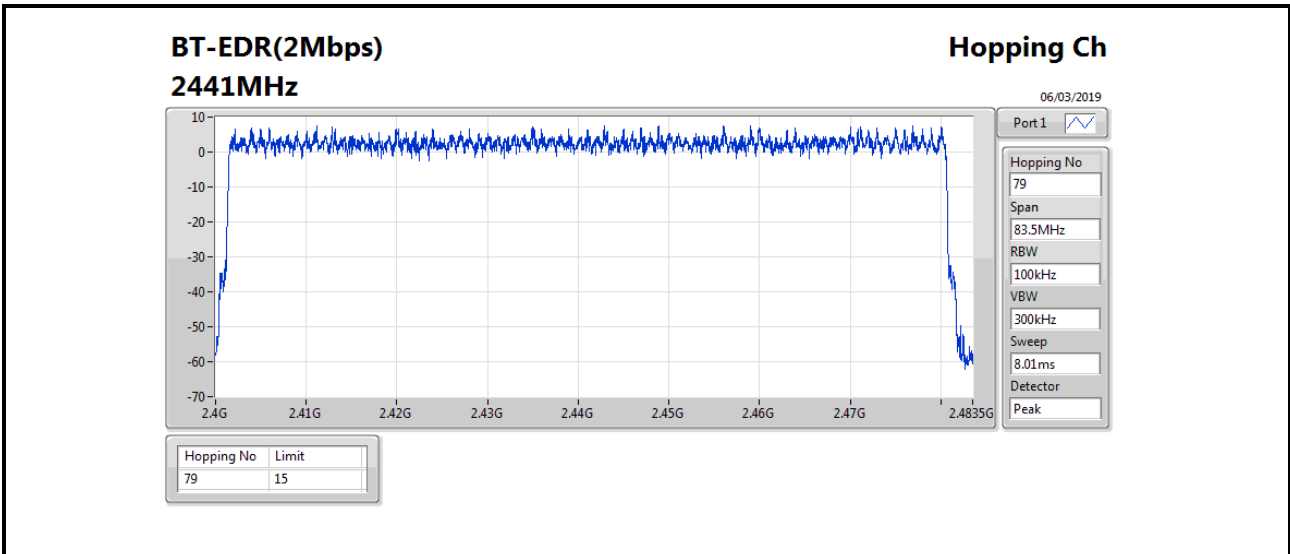

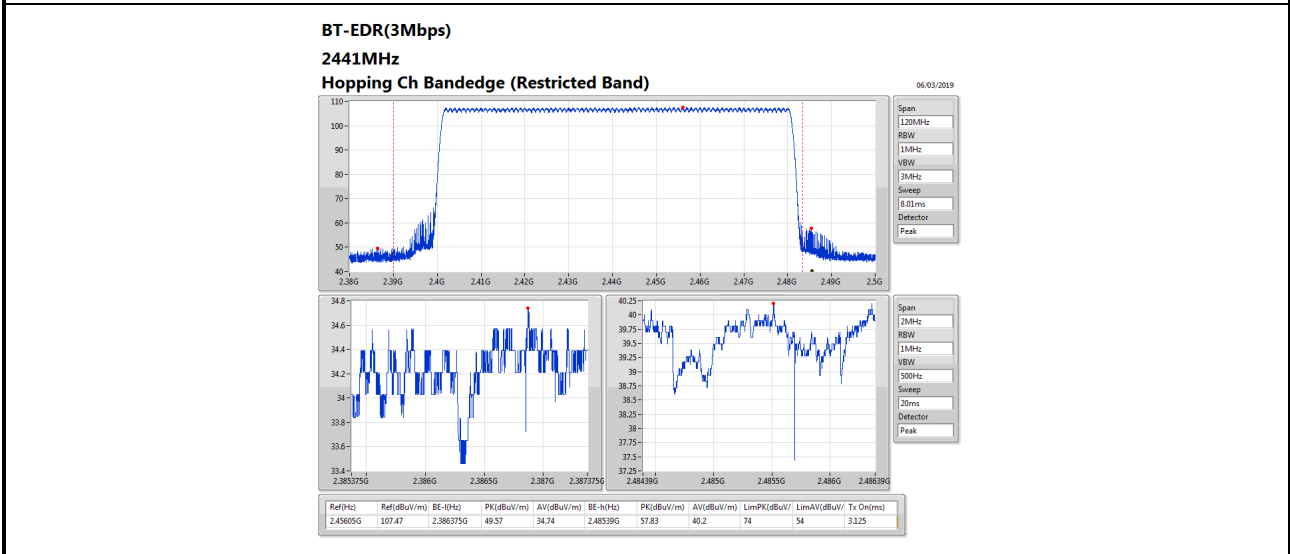
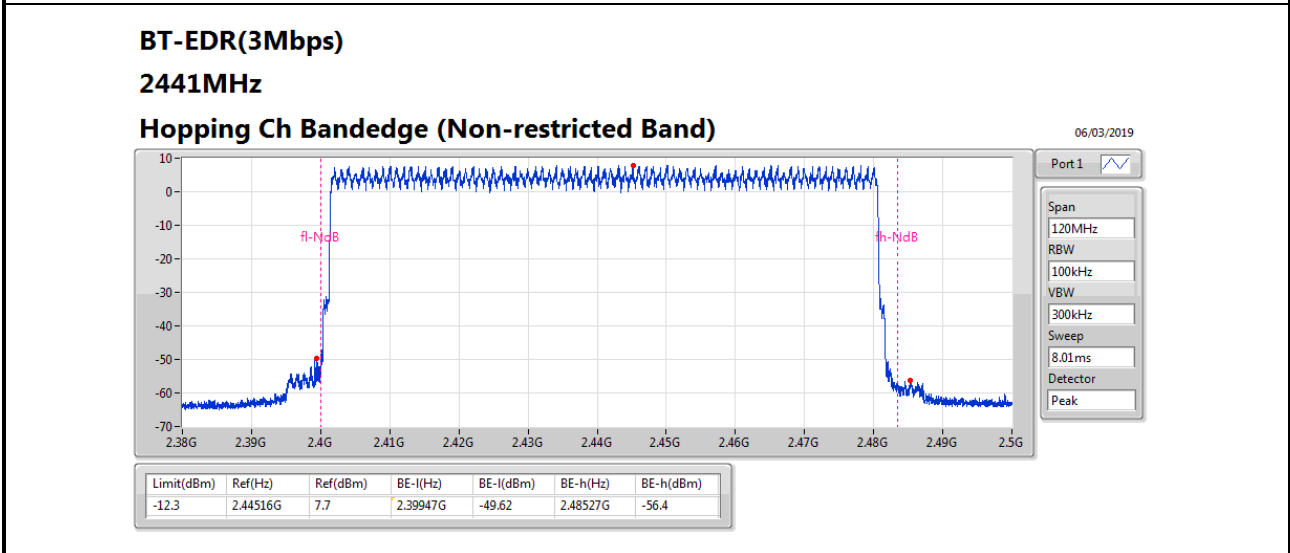
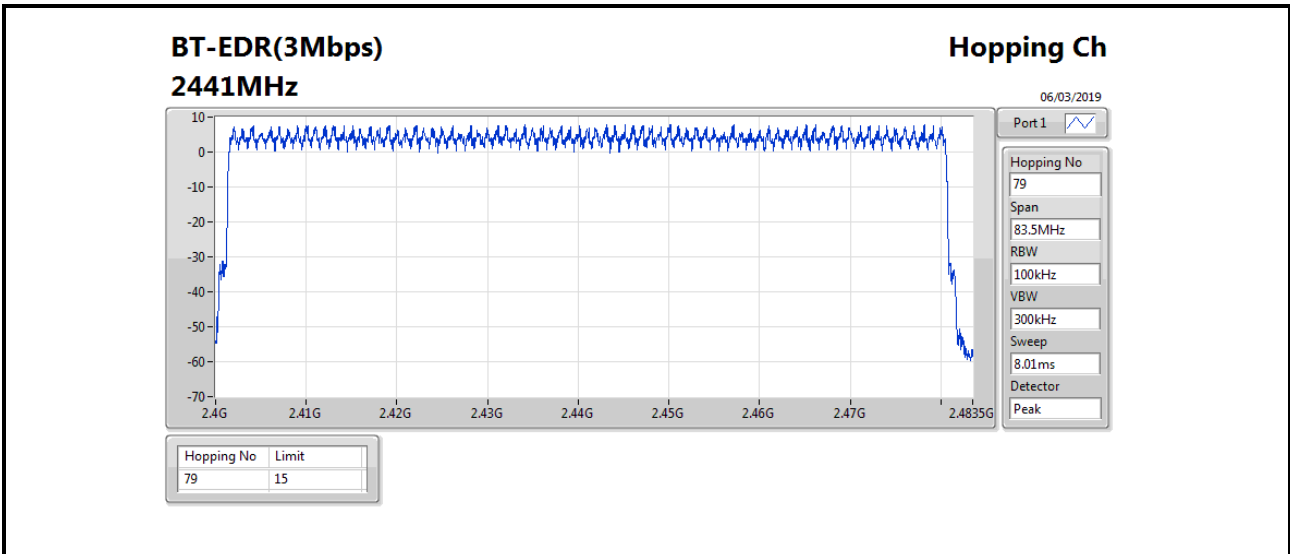



Summary

Mode	Max-Dwell (s)
2.4-2.4835GHz	-
BT-BR(1Mbps)	308.2872m
BT-EDR(2Mbps)	308.7136m
BT-EDR(3Mbps)	308.9268m

Result

Mode	Result	Period (s)	Dwell (s)	Limit (s)	Tx On (s)
BT-BR(1Mbps)	-	-	-	-	-
2441MHz_TnomVnom	Pass	31.6	308.2872m	400m	2.892m
BT-EDR(2Mbps)	-	-	-	-	-
2441MHz_TnomVnom	Pass	31.6	308.7136m	400m	2.896m
BT-EDR(3Mbps)	-	-	-	-	-
2441MHz_TnomVnom	Pass	31.6	308.9268m	400m	2.898m





Summary

Mode	Result	Ref (Hz)	Ref (dBm)	Limit (dBm)	Freq (Hz)	Level (dBm)	Freq (Hz)	Level (dBm)	Freq (Hz)	Level (dBm)	Freq (Hz)	Level (dBm)	Port
2.4-2.4835GHz	-	-	-	-	-	-	-	-	-	-	-	-	-
BT-BR(1Mbps)	Pass	2.40213G	10.57	-9.43	2.39593G	-52.79	2.39987G	-47.91	2.48454G	-62.95	24.10786G	-48.54	1
BT-EDR(2Mbps)	Pass	2.48012G	4.24	-15.76	567.83M	-61.68	2.39973G	-62.97	2.48381G	-53.75	24.09661G	-47.44	1
BT-EDR(3Mbps)	Pass	2.47999G	5.06	-14.94	471.93M	-61.40	2.39958G	-62.57	2.48401G	-56.55	24.42588G	-47.85	1

Result

Mode	Result	Ref (Hz)	Ref (dBm)	Limit (dBm)	Freq (Hz)	Level (dBm)	Freq (Hz)	Level (dBm)	Freq (Hz)	Level (dBm)	Freq (Hz)	Level (dBm)	Port
BT-BR(1Mbps)	-	-	-	-	-	-	-	-	-	-	-	-	-
2402MHz_TnomVnom	Pass	2.40213G	10.57	-9.43	2.39593G	-52.79	2.39987G	-47.91	2.48454G	-62.95	24.10786G	-48.54	1
2441MHz_TnomVnom	Pass	2.441G	9.99	-10.01	567.83M	-62.10	2.39935G	-63.53	2.48511G	-61.94	23.47183G	-48.56	1
2480MHz_TnomVnom	Pass	2.48016G	9.89	-10.11	471.93M	-62.62	2.39996G	-62.57	2.48354G	-53.24	24.47091G	-48.95	1
BT-EDR(2Mbps)	-	-	-	-	-	-	-	-	-	-	-	-	-
2402MHz_TnomVnom	Pass	2.4018G	4.14	-15.86	2.39622G	-58.53	2.39997G	-49.47	2.48376G	-62.81	24.05721G	-48.49	1
2441MHz_TnomVnom	Pass	2.44104G	5.31	-14.69	471.93M	-60.13	2.3985G	-62.61	2.48385G	-62.50	24.05721G	-48.58	1
2480MHz_TnomVnom	Pass	2.48012G	4.24	-15.76	567.83M	-61.68	2.39973G	-62.97	2.48381G	-53.75	24.09661G	-47.44	1
BT-EDR(3Mbps)	-	-	-	-	-	-	-	-	-	-	-	-	-
2402MHz_TnomVnom	Pass	2.40192G	5.00	-15.00	2.39593G	-58.00	2.39979G	-48.03	2.4854G	-62.43	24.54971G	-48.38	1
2441MHz_TnomVnom	Pass	2.44096G	5.04	-14.96	471.93M	-59.84	2.39857G	-63.62	2.48509G	-62.12	24.51875G	-48.98	1
2480MHz_TnomVnom	Pass	2.47999G	5.06	-14.94	471.93M	-61.40	2.39958G	-62.57	2.48401G	-56.55	24.42588G	-47.85	1

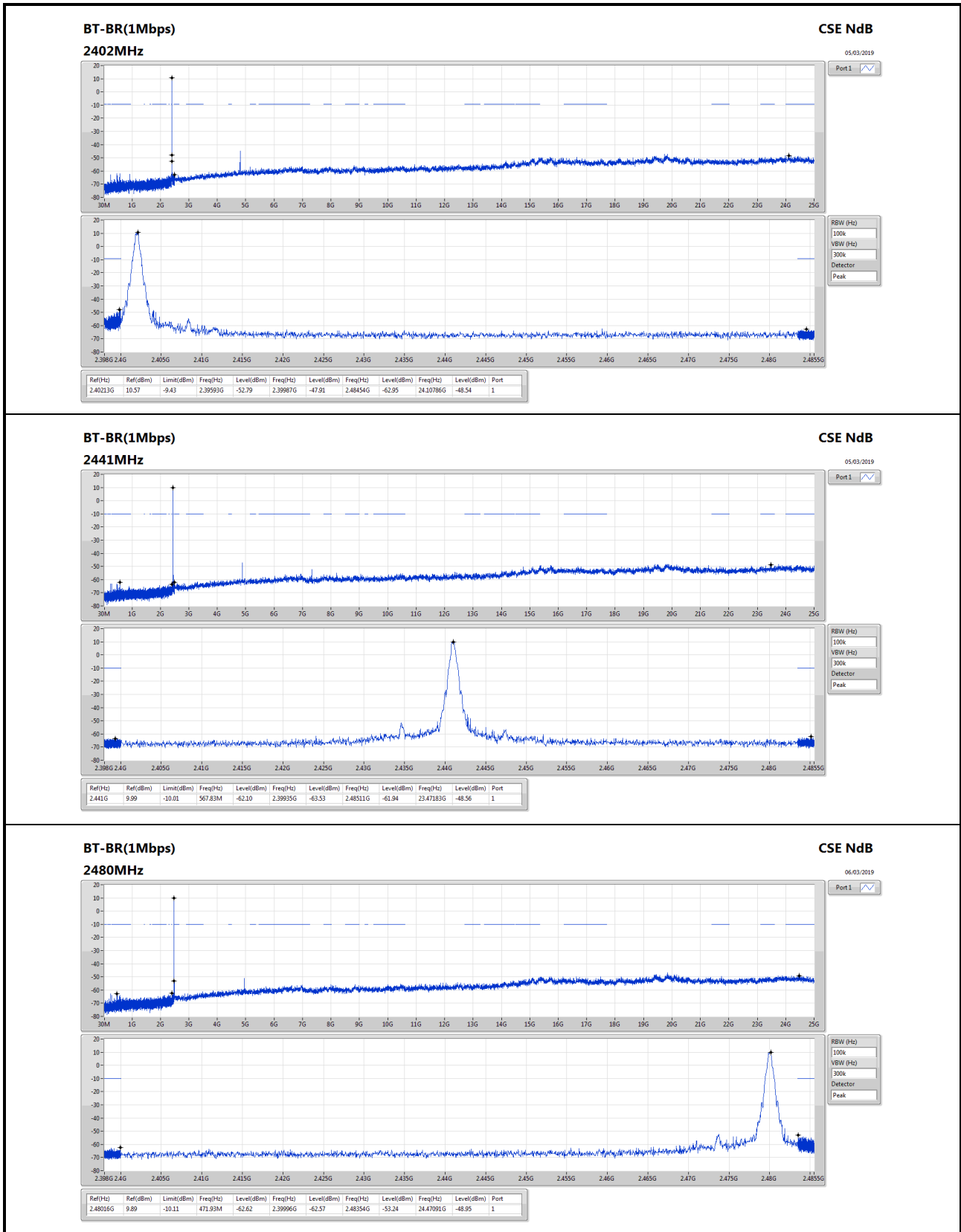

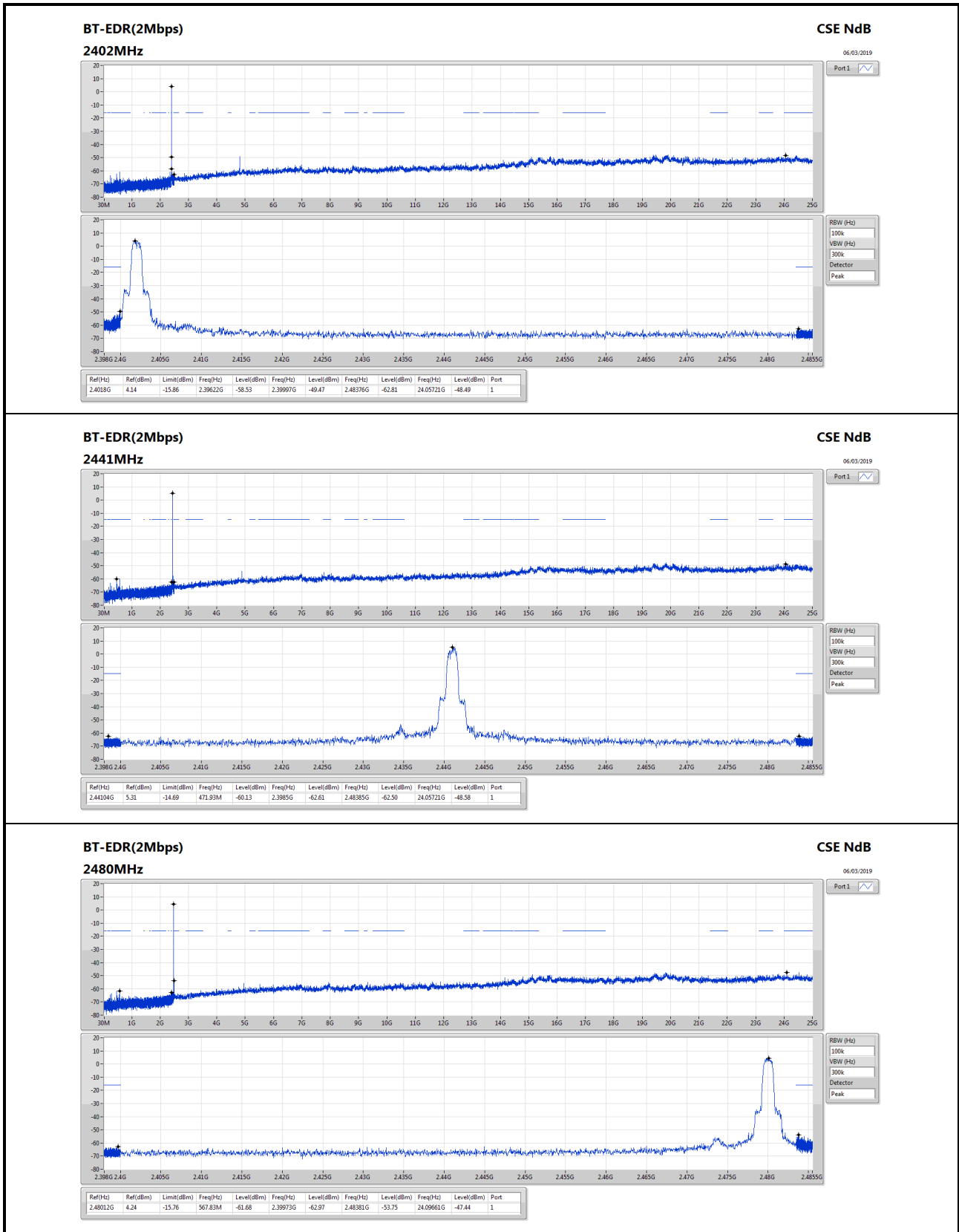

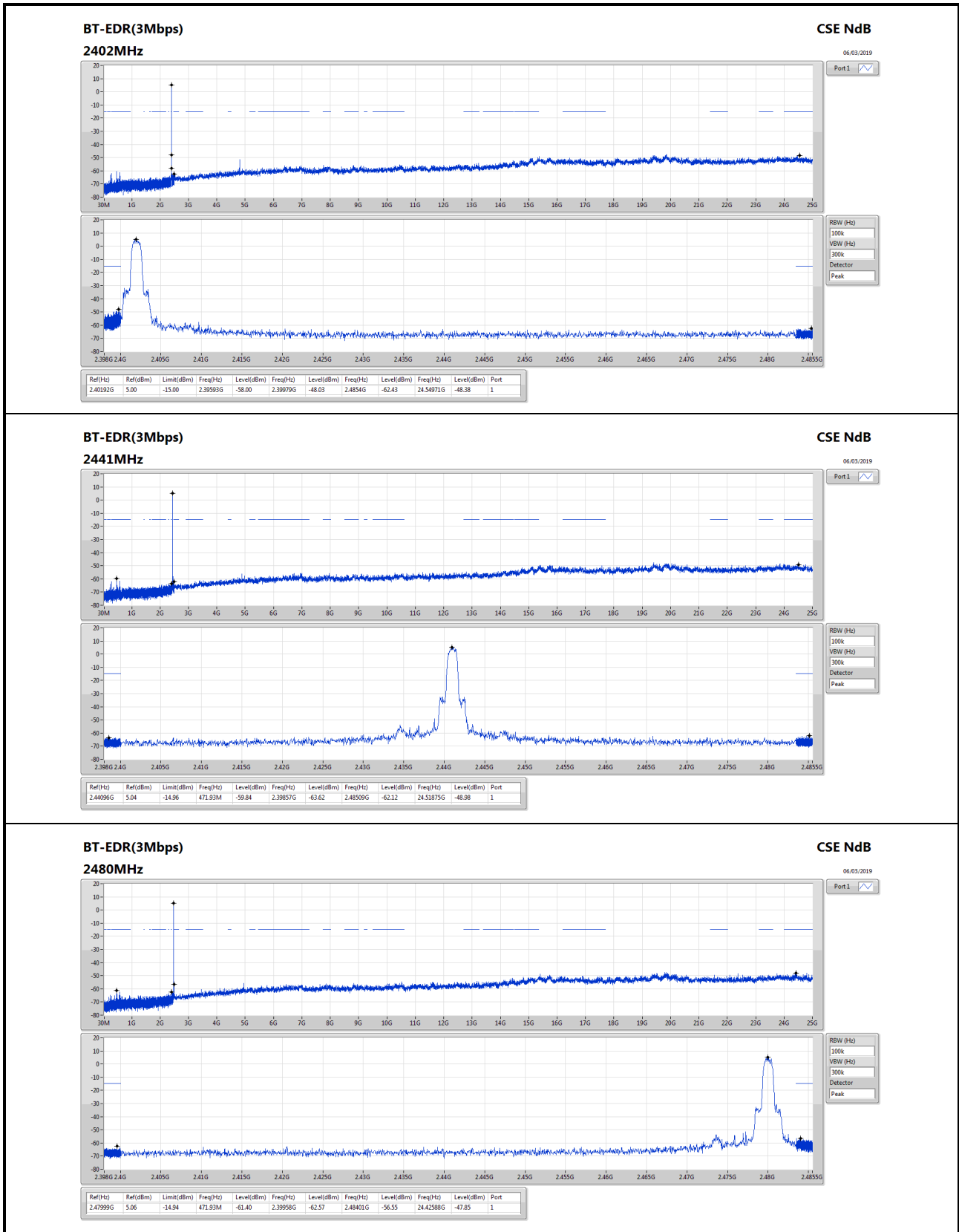



Summary

Mode	Result	Type	Freq (Hz)	Level (dBuV/m)	Limit (dBuV/m)	Margin (dB)	Factor (dB)	Dist (m)	Condition	Azimuth (°)	Height (m)	Comments
2.4-2.4835GHz	-	-	-	-	-	-	-	-	-	-	-	-
BT-BR(1Mbps)	Pass	PK	31.41M	27.50	40.00	-12.50	-3.62	3	Vertical	0	3.00	-



Result

Mode	Result	Type	Freq (Hz)	Level (dBuV/m)	Limit (dBuV/m)	Margin (dB)	Factor (dB)	Dist (m)	Condition	Azimuth (°)	Height (m)	Comments
BT-BR(1Mbps)	-	-	-	-	-	-	-	-	-	-	-	-
2441MHz	Pass	PK	31.41M	27.50	40.00	-12.50	-3.62	3	Vertical	0	3.00	-
2441MHz	Pass	PK	98.88M	30.15	43.50	-13.35	-9.51	3	Vertical	0	3.00	-
2441MHz	Pass	PK	159.33M	25.77	43.50	-17.73	-9.85	3	Vertical	0	3.00	-
2441MHz	Pass	PK	389.88M	23.86	46.00	-22.14	-3.79	3	Vertical	0	3.00	-
2441MHz	Pass	PK	543.12M	27.53	46.00	-18.47	-0.55	3	Vertical	0	3.00	-
2441MHz	Pass	PK	649.96M	28.21	46.00	-17.79	0.48	3	Vertical	0	3.00	-
2441MHz	Pass	PK	30M	22.95	40.00	-17.05	-2.85	3	Horizontal	360	3.00	-
2441MHz	Pass	PK	98.88M	29.23	43.50	-14.27	-9.51	3	Horizontal	360	3.00	-
2441MHz	Pass	PK	164.96M	20.16	43.50	-23.34	-9.81	3	Horizontal	360	3.00	-
2441MHz	Pass	PK	371.61M	23.87	46.00	-22.13	-4.10	3	Horizontal	360	3.00	-
2441MHz	Pass	PK	462.99M	26.05	46.00	-19.95	-1.91	3	Horizontal	360	3.00	-
2441MHz	Pass	PK	551.55M	27.95	46.00	-18.05	-0.25	3	Horizontal	360	3.00	-



BT-BR(1Mbps)

05/03/2019

2441MHz_DC Power Supply

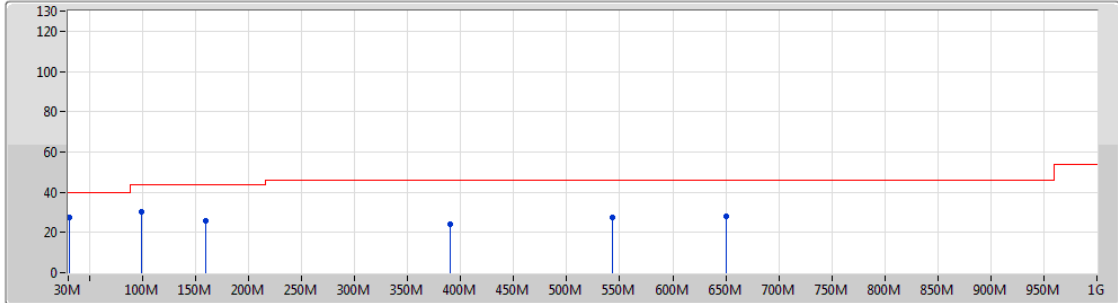

Lim.PK
 PK
 Lim.AV
 AV

Type	Freq (Hz)	Level (dBuV/m)	Limit (dBuV/m)	Margin (dB)	Factor (dB)	Dist (m)	Condition	Azimuth (°)	Height (m)	Comments
PK	31.41M	27.50	40.00	-12.50	-3.62	3	Vertical	0	3.00	-
PK	98.88M	30.15	43.50	-13.35	-9.51	3	Vertical	0	3.00	-
PK	159.33M	25.77	43.50	-17.73	-9.85	3	Vertical	0	3.00	-
PK	389.88M	23.86	46.00	-22.14	-3.79	3	Vertical	0	3.00	-
PK	543.12M	27.53	46.00	-18.47	-0.55	3	Vertical	0	3.00	-
PK	649.96M	28.21	46.00	-17.79	0.48	3	Vertical	0	3.00	-



BT-BR(1Mbps)

05/03/2019

2441MHz_DC Power Supply

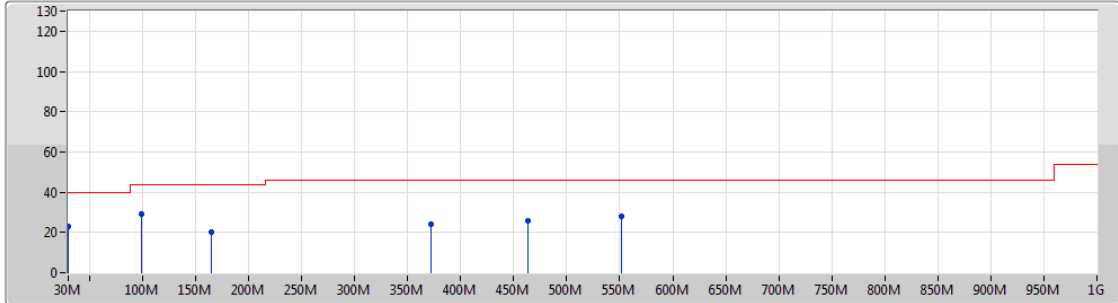

Legend for the graph:

- Lim.PK: Red line with a downward-pointing triangle
- PK: Blue line with a circular marker
- Lim.AV: Red line with an upward-pointing triangle
- AV: Black line with a downward-pointing triangle

Type	Freq (Hz)	Level (dBuV/m)	Limit (dBuV/m)	Margin (dB)	Factor (dB)	Dist (m)	Condition	Azimuth (°)	Height (m)	Comments
PK	30M	22.95	40.00	-17.05	-2.85	3	Horizontal	360	3.00	-
PK	98.88M	29.23	43.50	-14.27	-9.51	3	Horizontal	360	3.00	-
PK	164.96M	20.16	43.50	-23.34	-9.81	3	Horizontal	360	3.00	-
PK	371.61M	23.87	46.00	-22.13	-4.10	3	Horizontal	360	3.00	-
PK	462.99M	26.05	46.00	-19.95	-1.91	3	Horizontal	360	3.00	-
PK	551.55M	27.95	46.00	-18.05	-0.25	3	Horizontal	360	3.00	-



Summary

Mode	Result	Type	Freq (Hz)	Level (dBuV/m)	Limit (dBuV/m)	Margin (dB)	Factor (dB)	Dist (m)	Condition	Azimuth (°)	Height (m)	Comments
2.4-2.4835GHz	-	-	-	-	-	-	-	-	-	-	-	-
BT-BR(1Mbps)	Pass	AV	2.4922G	51.88	54.00	-2.12	35.18	3	Vertical	61	1.40	-
BT-EDR(3Mbps)	Pass	AV	2.4866G	47.21	54.00	-6.79	30.98	3	Vertical	324	2.07	-



Result

Mode	Result	Type	Freq (Hz)	Level (dBuV/m)	Limit (dBuV/m)	Margin (dB)	Factor (dB)	Dist (m)	Condition	Azimuth (°)	Height (m)	Comments
BT-BR(1Mbps)	-	-	-	-	-	-	-	-	-	-	-	-
2402MHz	Pass	AV	2.3884G	50.64	54.00	-3.36	34.70	3	Vertical	61	1.99	-
2402MHz	Pass	AV	2.402G	109.25	Inf	-Inf	34.77	3	Vertical	61	1.99	-
2402MHz	Pass	PK	2.384G	62.21	74.00	-11.79	34.69	3	Vertical	61	1.99	-
2402MHz	Pass	PK	2.4022G	109.35	Inf	-Inf	34.77	3	Vertical	61	1.99	-
2402MHz	Pass	AV	4.8094G	36.95	54.00	-17.05	8.50	3	Vertical	151	1.33	-
2402MHz	Pass	PK	4.79314G	48.83	74.00	-25.17	8.47	3	Vertical	151	1.33	-
2402MHz	Pass	AV	4.81024G	36.94	54.00	-17.06	8.50	3	Horizontal	198	2.41	-
2402MHz	Pass	PK	4.79338G	48.64	74.00	-25.36	8.47	3	Horizontal	198	2.41	-
2441MHz	Pass	AV	2.3854G	50.60	54.00	-3.40	34.69	3	Vertical	61	1.40	-
2441MHz	Pass	AV	2.441G	110.04	Inf	-Inf	34.94	3	Vertical	61	1.40	-
2441MHz	Pass	AV	2.4922G	51.88	54.00	-2.12	35.18	3	Vertical	61	1.40	-
2441MHz	Pass	PK	2.341G	61.52	74.00	-12.48	34.48	3	Vertical	61	1.40	-
2441MHz	Pass	PK	2.441G	110.14	Inf	-Inf	34.94	3	Vertical	61	1.40	-
2441MHz	Pass	PK	2.4835G	63.17	74.00	-10.83	35.14	3	Vertical	61	1.40	-
2441MHz	Pass	AV	4.88206G	39.83	54.00	-14.17	8.67	3	Vertical	17	1.86	-
2441MHz	Pass	PK	4.88194G	48.90	74.00	-25.10	8.67	3	Vertical	17	1.86	-
2441MHz	Pass	AV	4.86898G	36.64	54.00	-17.36	8.65	3	Horizontal	180	2.08	-
2441MHz	Pass	PK	4.88008G	48.49	74.00	-25.51	8.67	3	Horizontal	180	2.08	-
2480MHz	Pass	AV	2.48G	105.07	Inf	-Inf	31.04	3	Vertical	75	1.98	-
2480MHz	Pass	AV	2.4948G	47.80	54.00	-6.20	31.10	3	Vertical	75	1.98	-
2480MHz	Pass	PK	2.4798G	105.17	Inf	-Inf	31.04	3	Vertical	75	1.98	-
2480MHz	Pass	PK	2.4844G	58.82	74.00	-15.18	31.07	3	Vertical	75	1.98	-
2480MHz	Pass	AV	4.94686G	36.48	54.00	-17.52	8.82	3	Vertical	157	2.40	-
2480MHz	Pass	PK	4.9477G	47.92	74.00	-26.08	8.83	3	Vertical	157	2.40	-
2480MHz	Pass	AV	4.95256G	36.45	54.00	-17.55	8.84	3	Horizontal	207	2.21	-
2480MHz	Pass	PK	4.95616G	47.84	74.00	-26.16	8.85	3	Horizontal	207	2.21	-
BT-EDR(3Mbps)	-	-	-	-	-	-	-	-	-	-	-	-
2402MHz	Pass	AV	2.3798G	45.83	54.00	-8.17	30.66	3	Vertical	344	2.54	-
2402MHz	Pass	AV	2.402G	102.01	Inf	-Inf	30.72	3	Vertical	344	2.54	-
2402MHz	Pass	PK	2.3652G	56.63	74.00	-17.37	30.62	3	Vertical	344	2.54	-
2402MHz	Pass	PK	2.402G	105.34	Inf	-Inf	30.72	3	Vertical	344	2.54	-
2402MHz	Pass	AV	4.7893G	36.90	54.00	-17.10	8.47	3	Vertical	262	1.40	-
2402MHz	Pass	PK	4.80736G	48.63	74.00	-25.37	8.50	3	Vertical	262	1.40	-
2402MHz	Pass	AV	4.7974G	36.90	54.00	-17.10	8.48	3	Horizontal	57	2.06	-
2402MHz	Pass	PK	4.79974G	48.44	74.00	-25.56	8.48	3	Horizontal	57	2.06	-
2441MHz	Pass	AV	2.3894G	45.63	54.00	-8.37	30.68	3	Vertical	204	1.53	-
2441MHz	Pass	AV	2.441G	96.71	Inf	-Inf	30.84	3	Vertical	204	1.53	-
2441MHz	Pass	AV	2.499G	46.98	54.00	-7.02	31.01	3	Vertical	204	1.53	-
2441MHz	Pass	PK	2.3882G	56.80	74.00	-17.20	30.68	3	Vertical	204	1.53	-
2441MHz	Pass	PK	2.441G	100.06	Inf	-Inf	30.84	3	Vertical	204	1.53	-
2441MHz	Pass	PK	2.4926G	57.72	74.00	-16.28	30.99	3	Vertical	204	1.53	-
2441MHz	Pass	AV	4.86784G	36.62	54.00	-17.38	8.64	3	Vertical	340	1.97	-
2441MHz	Pass	PK	4.89616G	48.26	74.00	-25.74	8.70	3	Vertical	340	1.97	-
2441MHz	Pass	AV	4.86838G	36.53	54.00	-17.47	8.65	3	Horizontal	225	2.22	-
2441MHz	Pass	PK	4.88248G	48.16	74.00	-25.84	8.68	3	Horizontal	225	2.22	-
2480MHz	Pass	AV	2.48G	102.65	Inf	-Inf	30.95	3	Vertical	324	2.07	-
2480MHz	Pass	AV	2.4866G	47.21	54.00	-6.79	30.98	3	Vertical	324	2.07	-



RSE TX above 1GHz Result

Appendix F.2

Mode	Result	Type	Freq (Hz)	Level (dBuV/m)	Limit (dBuV/m)	Margin (dB)	Factor (dB)	Dist (m)	Condition	Azimuth (°)	Height (m)	Comments
2480MHz	Pass	PK	2.48G	105.97	Inf	-Inf	30.95	3	Vertical	324	2.07	-
2480MHz	Pass	PK	2.4866G	58.07	74.00	-15.93	30.98	3	Vertical	324	2.07	-
2480MHz	Pass	PK	4.95472G	47.91	74.00	-26.09	8.85	3	Vertical	153	2.28	-
2480MHz	Pass	AV	4.95802G	36.41	54.00	-17.59	8.85	3	Vertical	153	2.28	-
2480MHz	Pass	PK	4.94596G	48.39	74.00	-25.61	8.81	3	Horizontal	183	1.69	-
2480MHz	Pass	AV	4.9567G	36.40	54.00	-17.60	8.85	3	Horizontal	183	1.69	-



BT-BR(1Mbps)

2402MHz_TX

05/03/2019

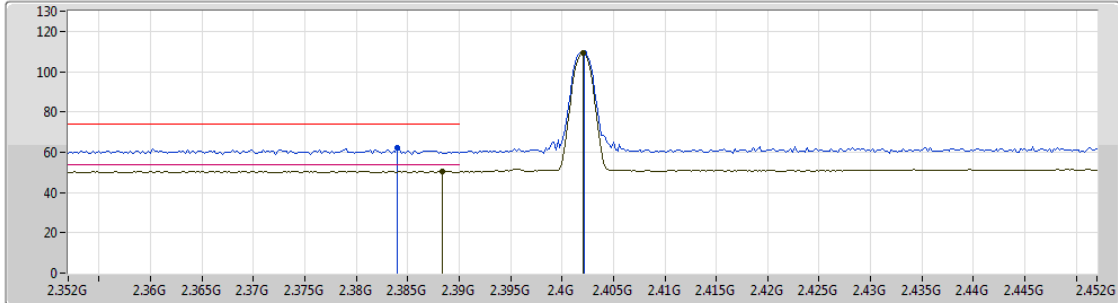

Lim.PK
 PK
 Lim.AV
 AV

Type	Freq (Hz)	Level (dBuV/m)	Limit (dBuV/m)	Margin (dB)	Factor (dB)	Dist (m)	Condition	Azimuth (°)	Height (m)	Comments
AV	2.3884G	50.64	54.00	-3.36	34.70	3	Vertical	61	1.99	-
AV	2.402G	109.25	Inf	-Inf	34.77	3	Vertical	61	1.99	-
PK	2.384G	62.21	74.00	-11.79	34.69	3	Vertical	61	1.99	-
PK	2.4022G	109.35	Inf	-Inf	34.77	3	Vertical	61	1.99	-



BT-BR(1Mbps)

05/03/2019

2402MHz_TX

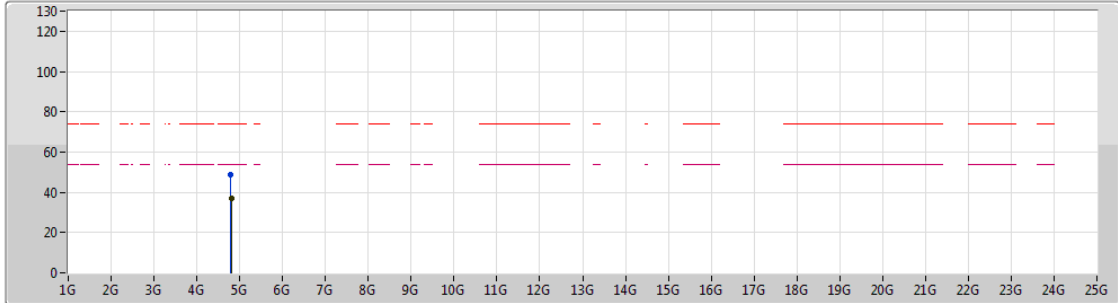

Type	Freq (Hz)	Level (dBuV/m)	Limit (dBuV/m)	Margin (dB)	Factor (dB)	Dist (m)	Condition	Azimuth (°)	Height (m)	Comments
AV	4.8094G	36.95	54.00	-17.05	8.50	3	Vertical	151	1.33	-
PK	4.79314G	48.83	74.00	-25.17	8.47	3	Vertical	151	1.33	-



BT-BR(1Mbps)

05/03/2019

2402MHz_TX

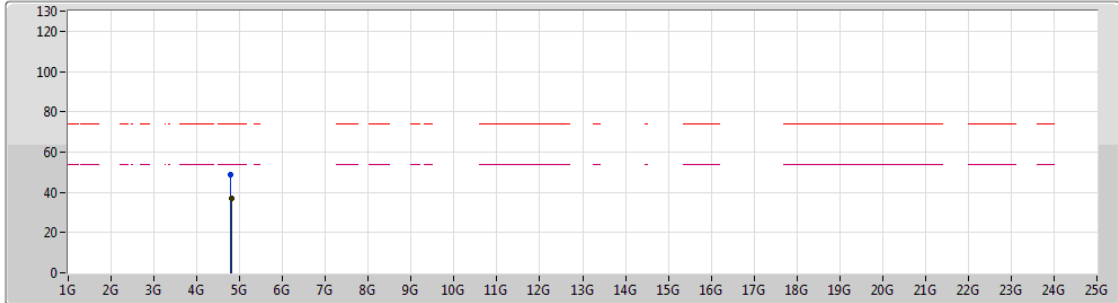

Legend:

- Lim.PK
- PK
- Lim.AV
- AV

Type	Freq (Hz)	Level (dBuV/m)	Limit (dBuV/m)	Margin (dB)	Factor (dB)	Dist (m)	Condition	Azimuth (°)	Height (m)	Comments
AV	4.81024G	36.94	54.00	-17.06	8.50	3	Horizontal	198	2.41	-
PK	4.79338G	48.64	74.00	-25.36	8.47	3	Horizontal	198	2.41	-



BT-BR(1Mbps)

2441MHz_TX

05/03/2019

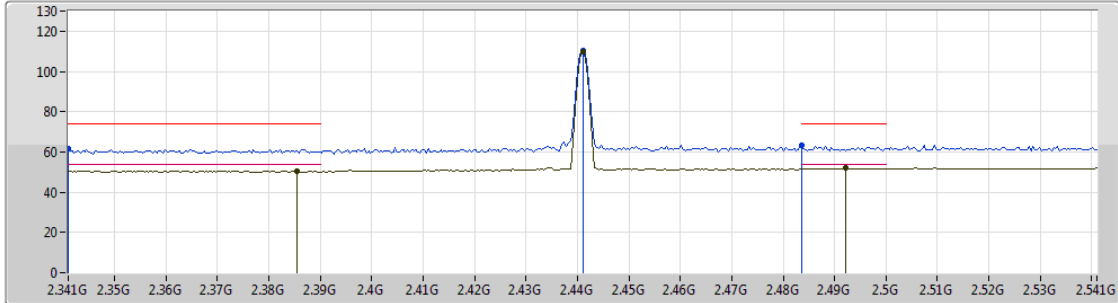

Type	Freq (Hz)	Level (dBuV/m)	Limit (dBuV/m)	Margin (dB)	Factor (dB)	Dist (m)	Condition	Azimuth (°)	Height (m)	Comments
AV	2.3854G	50.60	54.00	-3.40	34.69	3	Vertical	61	1.40	-
AV	2.441G	110.04	Inf	-Inf	34.94	3	Vertical	61	1.40	-
AV	2.4922G	51.88	54.00	-2.12	35.18	3	Vertical	61	1.40	-
PK	2.341G	61.52	74.00	-12.48	34.48	3	Vertical	61	1.40	-
PK	2.441G	110.14	Inf	-Inf	34.94	3	Vertical	61	1.40	-
PK	2.4835G	63.17	74.00	-10.83	35.14	3	Vertical	61	1.40	-



BT-BR(1Mbps)

05/03/2019

2441MHz_TX

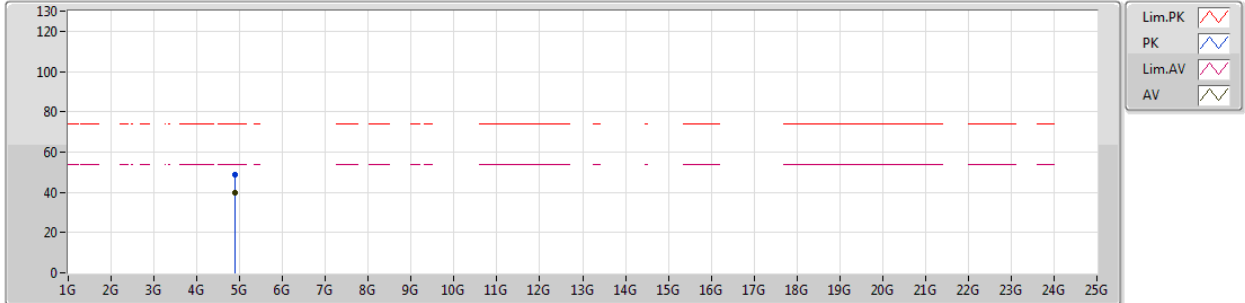

Type	Freq (Hz)	Level (dBuV/m)	Limit (dBuV/m)	Margin (dB)	Factor (dB)	Dist (m)	Condition	Azimuth (°)	Height (m)	Comments
AV	4.88206G	39.83	54.00	-14.17	8.67	3	Vertical	17	1.86	-
PK	4.88194G	48.90	74.00	-25.10	8.67	3	Vertical	17	1.86	-



BT-BR(1Mbps)

05/03/2019

2441MHz_TX

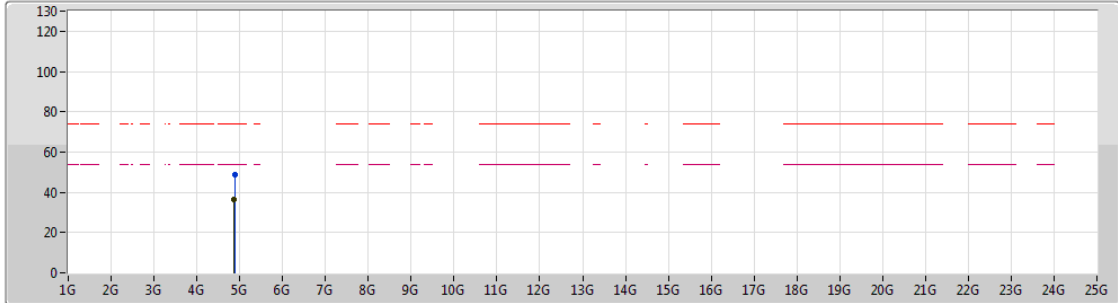

Legend for the plot:

- Lim.PK
- PK
- Lim.AV
- AV

Type	Freq (Hz)	Level (dBuV/m)	Limit (dBuV/m)	Margin (dB)	Factor (dB)	Dist (m)	Condition	Azimuth (°)	Height (m)	Comments
AV	4.86898G	36.64	54.00	-17.36	8.65	3	Horizontal	180	2.08	-
PK	4.88008G	48.49	74.00	-25.51	8.67	3	Horizontal	180	2.08	-



BT-BR(1Mbps)

2480MHz_TX

05/03/2019

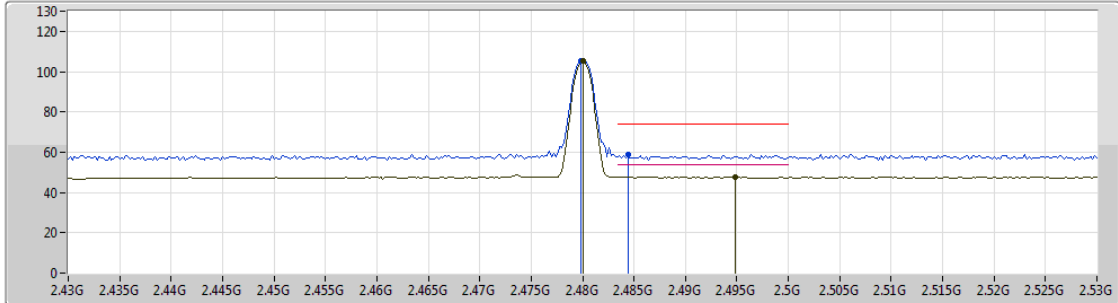

Type	Freq (Hz)	Level (dBuV/m)	Limit (dBuV/m)	Margin (dB)	Factor (dB)	Dist (m)	Condition	Azimuth (°)	Height (m)	Comments
AV	2.48G	105.07	Inf	-Inf	31.04	3	Vertical	75	1.98	-
AV	2.4948G	47.80	54.00	-6.20	31.10	3	Vertical	75	1.98	-
PK	2.4798G	105.17	Inf	-Inf	31.04	3	Vertical	75	1.98	-
PK	2.4844G	58.82	74.00	-15.18	31.07	3	Vertical	75	1.98	-



BT-BR(1Mbps)

2480MHz_TX

05/03/2019

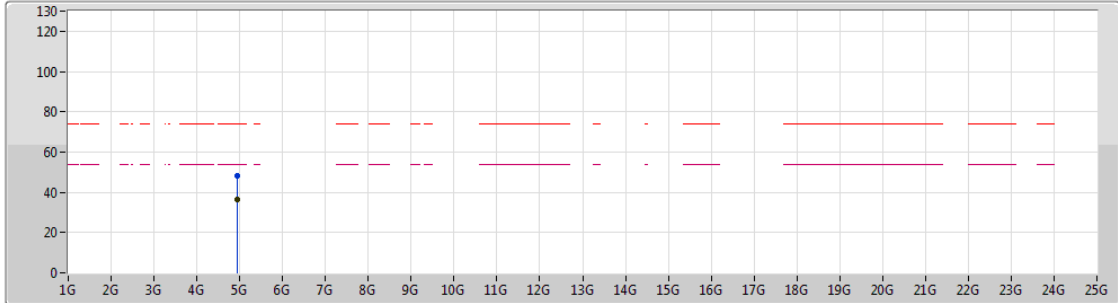

Lim.PK
 PK
 Lim.AV
 AV

Type	Freq (Hz)	Level (dBuV/m)	Limit (dBuV/m)	Margin (dB)	Factor (dB)	Dist (m)	Condition	Azimuth (°)	Height (m)	Comments
AV	4.94686G	36.48	54.00	-17.52	8.82	3	Vertical	157	2.40	-
PK	4.9477G	47.92	74.00	-26.08	8.83	3	Vertical	157	2.40	-



BT-BR(1Mbps)

05/03/2019

2480MHz_TX

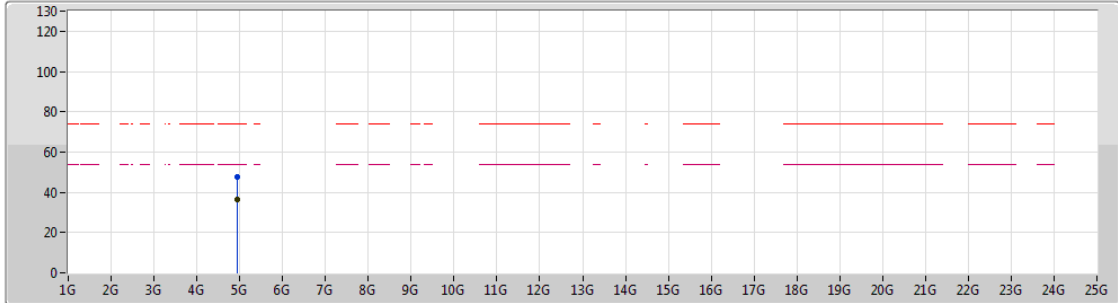

Lim.PK
 PK
 Lim.AV
 AV





Type	Freq (Hz)	Level (dBuV/m)	Limit (dBuV/m)	Margin (dB)	Factor (dB)	Dist (m)	Condition	Azimuth (°)	Height (m)	Comments
AV	4.95256G	36.45	54.00	-17.55	8.84	3	Horizontal	207	2.21	-
PK	4.95616G	47.84	74.00	-26.16	8.85	3	Horizontal	207	2.21	-

BT-EDR(3Mbps)

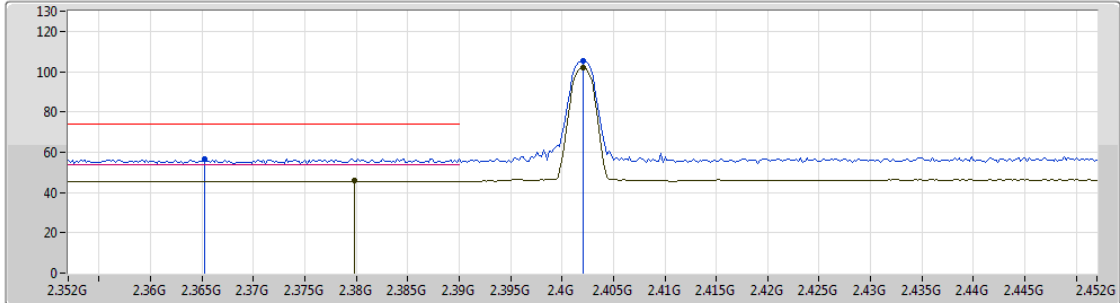
05/03/2019

2402MHz_TX



Lim.PK 
 PK 
 Lim.AV 
 AV 

Type	Freq (Hz)	Level (dBuV/m)	Limit (dBuV/m)	Margin (dB)	Factor (dB)	Dist (m)	Condition	Azimuth (°)	Height (m)	Comments
AV	2.3798G	45.83	54.00	-8.17	30.66	3	Vertical	344	2.54	-
AV	2.402G	102.01	Inf	-Inf	30.72	3	Vertical	344	2.54	-
PK	2.3652G	56.63	74.00	-17.37	30.62	3	Vertical	344	2.54	-
PK	2.402G	105.34	Inf	-Inf	30.72	3	Vertical	344	2.54	-



BT-EDR(3Mbps)

05/03/2019

2402MHz_TX

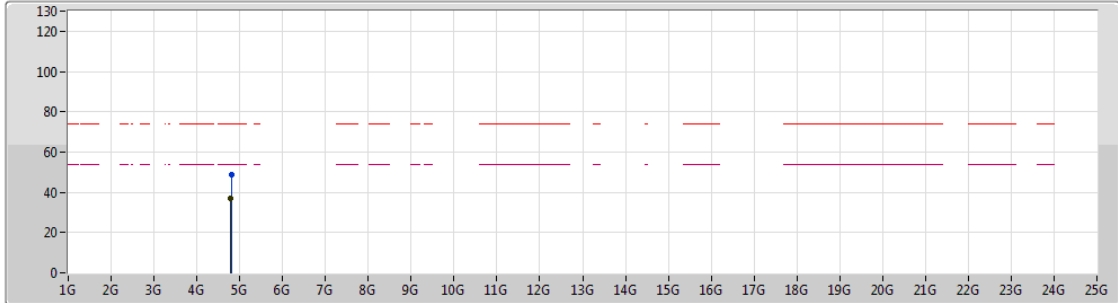

Type	Freq (Hz)	Level (dBuV/m)	Limit (dBuV/m)	Margin (dB)	Factor (dB)	Dist (m)	Condition	Azimuth (°)	Height (m)	Comments
AV	4.7893G	36.90	54.00	-17.10	8.47	3	Vertical	262	1.40	-
PK	4.80736G	48.63	74.00	-25.37	8.50	3	Vertical	262	1.40	-



BT-EDR(3Mbps)

05/03/2019

2402MHz_TX

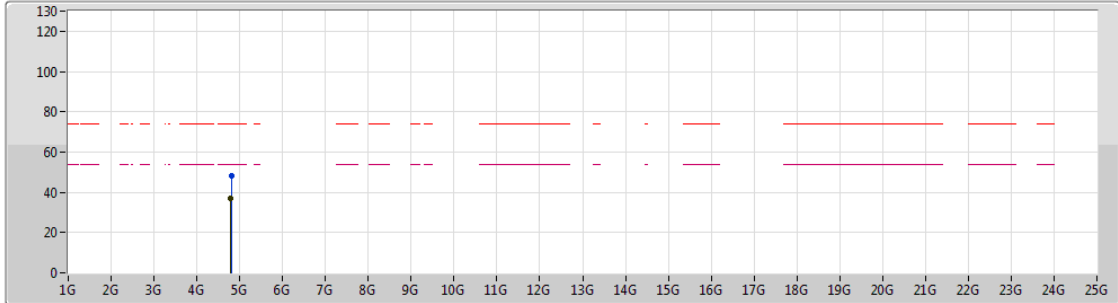

Type	Freq (Hz)	Level (dBuV/m)	Limit (dBuV/m)	Margin (dB)	Factor (dB)	Dist (m)	Condition	Azimuth (°)	Height (m)	Comments
AV	4.7974G	36.90	54.00	-17.10	8.48	3	Horizontal	57	2.06	-
PK	4.79974G	48.44	74.00	-25.56	8.48	3	Horizontal	57	2.06	-



BT-EDR(3Mbps)

2441MHz_TX

05/03/2019

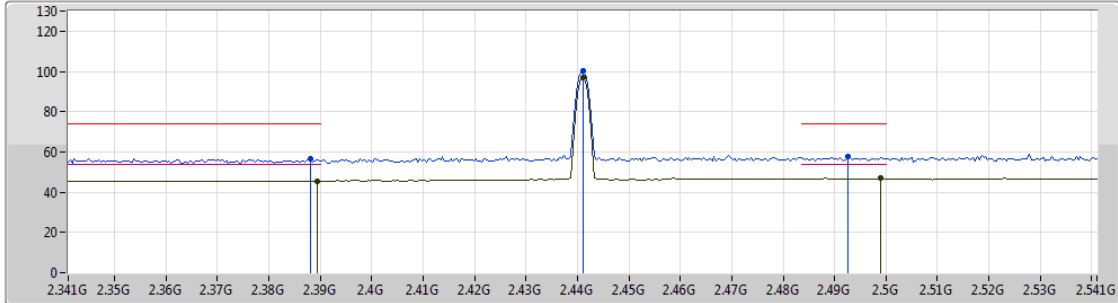

Type	Freq [Hz]	Level [dBuV/m]	Limit [dBuV/m]	Margin [dB]	Factor [dB]	Dist [m]	Condition	Azimuth [°]	Height [m]	Comments
AV	2.3894G	45.63	54.00	-8.37	30.68	3	Vertical	204	1.53	-
AV	2.441G	96.71	Inf	-Inf	30.84	3	Vertical	204	1.53	-
AV	2.499G	46.98	54.00	-7.02	31.01	3	Vertical	204	1.53	-
PK	2.3882G	56.80	74.00	-17.20	30.68	3	Vertical	204	1.53	-
PK	2.441G	100.06	Inf	-Inf	30.84	3	Vertical	204	1.53	-
PK	2.4926G	57.72	74.00	-16.28	30.99	3	Vertical	204	1.53	-



BT-EDR(3Mbps)

05/03/2019

2441MHz_TX

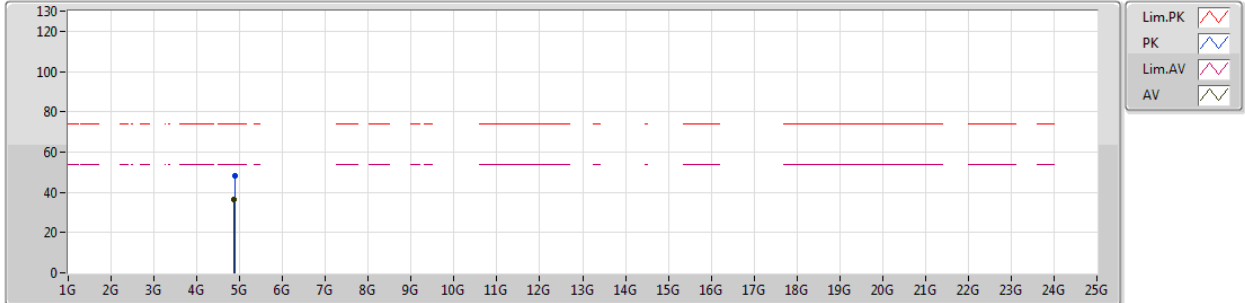

Type	Freq (Hz)	Level (dBuV/m)	Limit (dBuV/m)	Margin (dB)	Factor (dB)	Dist (m)	Condition	Azimuth (°)	Height (m)	Comments
AV	4.86784G	36.62	54.00	-17.38	8.64	3	Vertical	340	1.97	-
PK	4.89616G	48.26	74.00	-25.74	8.70	3	Vertical	340	1.97	-



BT-EDR(3Mbps)

05/03/2019

2441MHz_TX

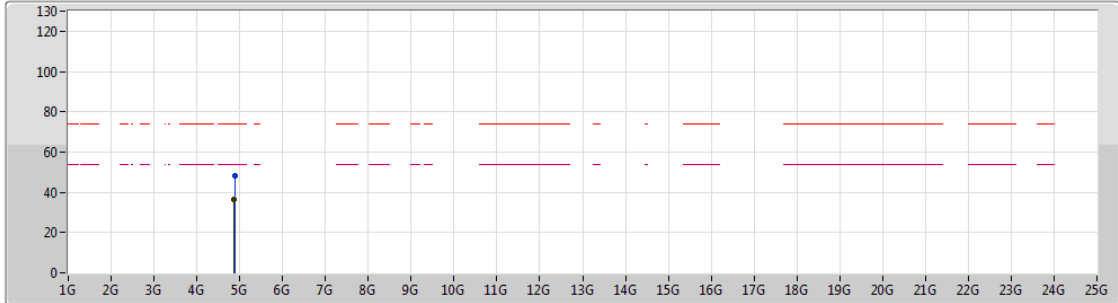

Lim.PK
 PK
 Lim.AV
 AV

Type	Freq (Hz)	Level (dBuV/m)	Limit (dBuV/m)	Margin (dB)	Factor (dB)	Dist (m)	Condition	Azimuth (°)	Height (m)	Comments
AV	4.86838G	36.53	54.00	-17.47	8.65	3	Horizontal	225	2.22	-
PK	4.88248G	48.16	74.00	-25.84	8.68	3	Horizontal	225	2.22	-



BT-EDR(3Mbps)

05/03/2019

2480MHz_TX

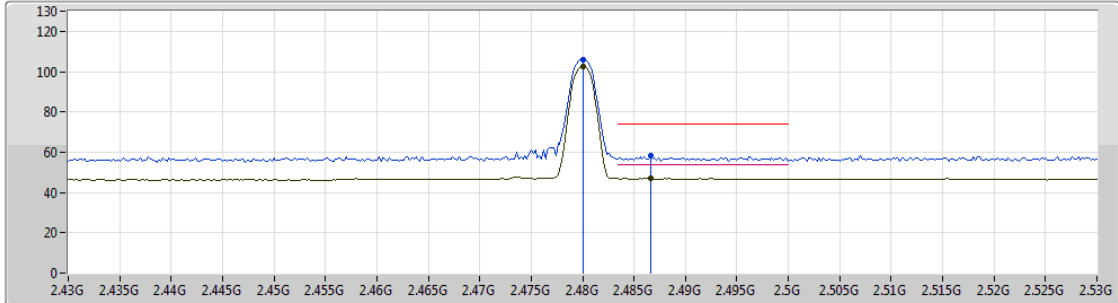

Type	Freq (Hz)	Level (dBuV/m)	Limit (dBuV/m)	Margin (dB)	Factor (dB)	Dist (m)	Condition	Azimuth (°)	Height (m)	Comments
AV	2.48G	102.65	Inf	-Inf	30.95	3	Vertical	324	2.07	-
AV	2.4866G	47.21	54.00	-6.79	30.98	3	Vertical	324	2.07	-
PK	2.48G	105.97	Inf	-Inf	30.95	3	Vertical	324	2.07	-
PK	2.4866G	58.07	74.00	-15.93	30.98	3	Vertical	324	2.07	-



BT-EDR(3Mbps)

05/03/2019

2480MHz_TX

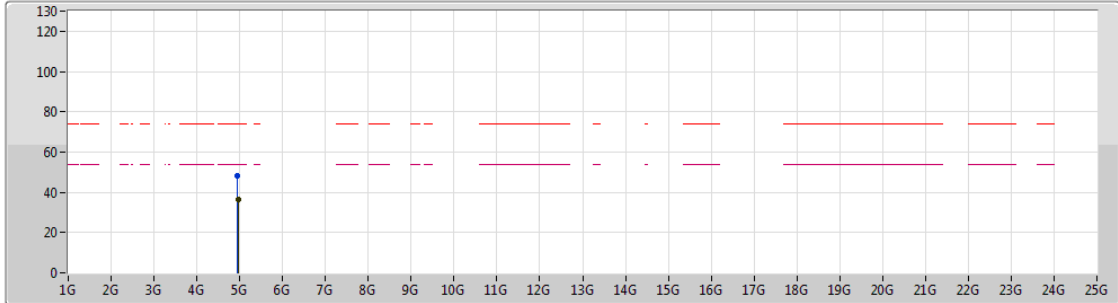

Lim.PK
 PK
 Lim.AV
 AV

Type	Freq (Hz)	Level (dBuV/m)	Limit (dBuV/m)	Margin (dB)	Factor (dB)	Dist (m)	Condition	Azimuth (°)	Height (m)	Comments
PK	4.95472G	47.91	74.00	-26.09	8.85	3	Vertical	153	2.28	-
AV	4.95802G	36.41	54.00	-17.59	8.85	3	Vertical	153	2.28	-



BT-EDR(3Mbps)

05/03/2019

2480MHz_TX

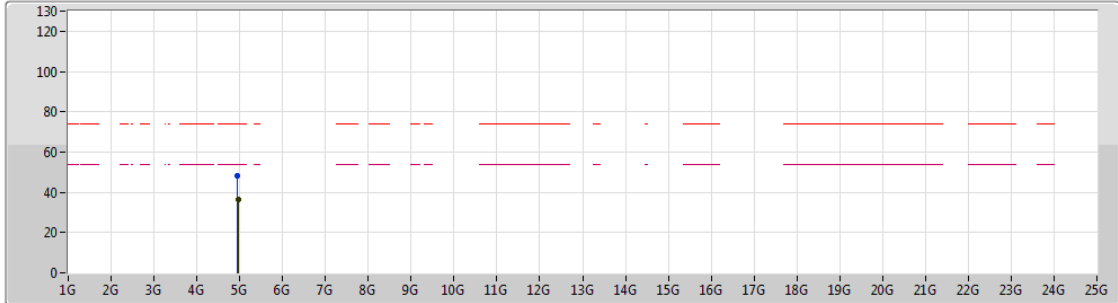

Type	Freq (Hz)	Level (dBuV/m)	Limit (dBuV/m)	Margin (dB)	Factor (dB)	Dist (m)	Condition	Azimuth (°)	Height (m)	Comments
PK	4.94596G	48.39	74.00	-25.61	8.81	3	Horizontal	183	1.69	-
AV	4.9567G	36.40	54.00	-17.60	8.85	3	Horizontal	183	1.69	-