

TEST REPORT

Product Name: Lenovo Legion M600 Wireless Gaming Mouse

Model Number: M600A

FCC ID: A5MM600A

Prepared for : Lenovo (Beijing) limited
Address : 201-H2-6, Floor 2, Building 2, No.6 Shangdi West Road,
Haidian District, Beijing, China 100085

Prepared by : EMTEK (SHENZHEN) CO., LTD.
Address : Bldg 69, Majialong Industry Zone, Nanshan District,
Shenzhen, Guangdong, China

Tel: (0755) 26954280
Fax: (0755) 26954282

Report Number : ES200102045W01
Date(s) of Tests : Jan. 6, 2020 to Mar. 3, 2020
Date of issue : Mar. 5, 2020

Table of Contents

1	TEST RESULT CERTIFICATION	3
2	EUT TECHNICAL DESCRIPTION	5
3	SUMMARY OF TEST RESULT	6
4	TEST METHODOLOGY	7
4.1	GENERAL DESCRIPTION OF APPLIED STANDARDS	7
4.2	MEASUREMENT EQUIPMENT USED	7
4.3	DESCRIPTION OF TEST MODES	8
5	FACILITIES AND ACCREDITATIONS	9
5.1	FACILITIES.....	9
5.2	LABORATORY ACCREDITATIONS AND LISTINGS.....	9
6	TEST SYSTEM UNCERTAINTY	10
7	SETUP OF EQUIPMENT UNDER TEST.....	11
7.1	RADIO FREQUENCY TEST SETUP 1	11
7.2	RADIO FREQUENCY TEST SETUP 2	11
7.3	CONDUCTED EMISSION TEST SETUP	12
7.4	SUPPORT EQUIPMENT	13
8	TEST REQUIREMENTS.....	14
8.1	DTS 6DB BANDWIDTH.....	14
8.2	MAXIMUM PEAK CONDUCTED OUTPUT POWER.....	17
8.3	MAXIMUM POWER SPECTRAL DENSITY	20
8.4	UNWANTED EMISSIONS IN NON-RESTRICTED FREQUENCY BANDS.....	23
8.5	RADIATED SPURIOUS EMISSION	28
8.6	CONDUCTED EMISSIONS TEST.....	40
8.7	ANTENNA APPLICATION	43

1 TEST RESULT CERTIFICATION

Applicant:	Lenovo (Beijing) limited 201-H2-6, Floor 2, Building 2, No.6 Shangdi West Road, Haidian District, Beijing, China 100085
Manufacture:	Lenovo (Beijing) limited 201-H2-6, Floor 2, Building 2, No.6 Shangdi West Road, Haidian District, Beijing, China 100085
EUT Description:	Lenovo Legion M600 Wireless Gaming Mouse
Model Number:	M600A
Trade Mark:	Lenovo

Measurement Procedure Used:

APPLICABLE STANDARDS	
STANDARD	TEST RESULT
FCC 47 CFR Part 2 , Subpart J FCC 47 CFR Part 15 , Subpart C	PASS

The above equipment was tested by EMTEK(SHENZHEN) CO., LTD. The test data, data evaluation, test procedures, and equipment configurations shown in this report were made in accordance with the procedures given in ANSI C63.10 (2013) and the energy emitted by the sample EUT tested as described in this report is in compliance with the requirements of FCC Rules Part 2 and Part 15.247.

The test results of this report relate only to the tested sample identified in this report

Date of Test : Jan. 6, 2020 to Mar. 3, 2020

Prepared by : 
Joe Xia/Editor

Reviewer : 
Lisa Wang/Supervisor

Approve & Authorized Signer : 
David Li/Manager



Modified Information

Version	Report No.	Revision Date	Summary
Ver.1.0	ES200102045W01	/	Original Report



2 EUT TECHNICAL DESCRIPTION

Characteristics	Description
Modulation	GFSK
Operating Frequency Range	2402-2480MHz
Number of Channels	40 channels
Transmit Power Max	-8.269 dBm
Antenna Type	Internal Antenna
Antenna Gain	3.68 dBi
Power supply	DC 3.7V from battery DC 5.0V from external power
Temperature Range	-20°C ~ +55°C

Note: for more details, please refer to the User's manual of the EUT.

3 SUMMARY OF TEST RESULT

FCC Part Clause	Test Parameter	Verdict	Remark
15.247(a)(2)	DTS (6dB) Bandwidth	PASS	
15.247(b)(3)	Maximum Peak Conducted Output Power	PASS	
15.247(e)	Maximum Power Spectral Density Level	PASS	
15.247(d)	Unwanted Emission Into Non-Restricted Frequency Bands	PASS	
15.247(d) 15.209	Unwanted Emission Into Restricted Frequency Bands (conducted)	PASS	
15.247(d) 15.209	Radiated Spurious Emission	PASS	
15.207	Conducted Emission Test	PASS	
15.203	Antenna Application	PASS	
	NOTE1: N/A (Not Applicable) NOTE2: According to FCC OET KDB 558074, the report use radiated measurements in the restricted frequency bands. In addition, the radiated test is also performed to ensure the emissions emanating from the device cabinet also comply with the applicable limits.		

RELATED SUBMITTAL(S) / GRANT(S):

This submittal(s) (test report) is intended for FCC ID: A5MM600A filing to comply with Section 15.247 of the FCC Part 15, Subpart C Rules.

4 TEST METHODOLOGY

4.1 GENERAL DESCRIPTION OF APPLIED STANDARDS

According to its specifications, the EUT must comply with the requirements of the following standards:

FCC 47 CFR Part 2, Subpart J

FCC 47 CFR Part 15, Subpart C

FCC KDB 558074 D01 15.247 Meas Guidance v05r02

4.2 MEASUREMENT EQUIPMENT USED

4.2.1 Conducted Emission Test Equipment

EQUIPMENT TYPE	MFR	MODEL NUMBER	SERIAL NUMBER	LASTCAL.	DUE CAL.
Test Receiver	Rohde & Schwarz	ESCI	26115-010-0027	May 20, 2019	1 Year
L.I.S.N.	Rohde & Schwarz	ENV216	101161	May 20, 2019	1 Year
50ΩCoaxial Switch	Anritsu	MP59B	6100175589	May 21, 2019	1 Year
Voltage Probe	Rohde & Schwarz	ESH2-Z3	100122	May 21, 2019	1 Year
Pulse Limiter	Rohde & Schwarz	ESH3-Z2	100006	May 20, 2019	1 Year
I.S.N	Teseq GmbH	ISN T800	30327	May 21, 2019	1 Year

4.2.2 Radiated Emission Test Equipment

EQUIPMENT TYPE	MFR	MODEL NUMBER	SERIAL NUMBER	LAST CAL.	DUE CAL.
EMI Test Receiver	Rohde & Schwarz	ESU	1302.6005.26	May 21, 2019	1 Year
Pre-Amplifier	HP	8447F	2944A07999	May 20, 2019	1 Year
Bilog Antenna	Schwarzbeck	VULB9163	142	May 20, 2019	1 Year
Loop Antenna	ARA	PLA-1030/B	1029	May 20, 2019	1 Year
Horn Antenna	Schwarzbeck	BBHA 9170	BBHA9170399	May 21, 2019	1 Year
Horn Antenna	Schwarzbeck	BBHA 9120	D143	May 20, 2019	1 Year
Cable	Schwarzbeck	AK9513	ACRX1	May 21, 2019	1 Year
Cable	Rosenberger	N/A	FP2RX2	May 21, 2019	1 Year
Cable	Schwarzbeck	AK9513	CRPX1	May 21, 2019	1 Year
Cable	Schwarzbeck	AK9513	CRRX2	May 21, 2019	1 Year

4.2.3 Radio Frequency Test Equipment

EQUIPMENT TYPE	MFR	MODEL NUMBER	SERIAL NUMBER	LASTCAL.	DUE CAL.
Spectrum Analyzer	Agilent	E4407B	88156318	May 21, 2019	1 Year
EMI Test Receiver	Rohde & Schwarz	ESCI	101045	May 21, 2019	1 Year
Signal Analyzer	Agilent	N9010A	My53470879	May 21, 2019	1 Year
Power meter	Anritsu	ML2495A	0824006	May 21, 2019	1 Year
Power sensor	Anritsu	MA2411B	0738172	May 21, 2019	1 Year

Remark: Each piece of equipment is scheduled for calibration once a year.

4.3 DESCRIPTION OF TEST MODES

The EUT has been tested under its typical operating condition.

The EUT configuration for testing is installed on RF field strength measurement to meet the Commissions requirement and operating in a manner which intends to maximize its emission characteristics in a continuous normal application.

The Transmitter was operated in the normal operating mode. The TX frequency was fixed which was for the purpose of the measurements.

Test of channel included the lowest and middle and highest frequency to perform the test, then record on this report.

Those data rates (Bluetooth 5.0 DTS) were used for all test.

Pre-defined engineering program for regulatory testing used to control the EUT for staying in continuous transmitting and receiving mode is programmed.

Frequency and Channel list for Bluetooth 5.0 DTS:

Channel	Frequency (MHz)	Channel	Frequency (MHz)	Channel	Frequency (MHz)
0	2402	19	2440
1	2404	20	2442	37	2476
2	2406	21	2444	38	2478
...	39	2480

Note: $f_c=2402\text{MHz}+k \times 1\text{MHz}$ $k=1$ to 39

Test Frequency and channel for Bluetooth 5.0 DTS:

Lowest Frequency		Middle Frequency		Highest Frequency	
Channel	Frequency (MHz)	Channel	Frequency (MHz)	Channel	Frequency (MHz)
0	2402	19	2440	39	2480

5 FACILITIES AND ACCREDITATIONS

5.1 FACILITIES

All measurement facilities used to collect the measurement data are located at

Bldg 69, Majialong Industry Zone District, Nanshan District, Shenzhen, China

The sites are constructed in conformance with the requirements of ANSI C63.7, ANSI C63.10 and CISPR Publication 22.

5.2 LABORATORY ACCREDITATIONS AND LISTINGS

Site Description

EMC Lab.

- : Accredited by CNAS, 2018.11.30
The certificate is valid until 2022.10.23
The Laboratory has been assessed and proved to be in compliance with CNAS-CL01: 2006(identical to ISO/IEC17025: 2017)
The Certificate Registration Number is L2291

- : Accredited by FCC, August 06, 2018
The certificate is valid until August 07, 2020
Designation Number: CN1204
Test Firm Registration Number: 882943

- Accredited by A2LA, July 31, 2017
The Certificate Registration Number is 4321.01.

- : Accredited by Industry Canada, November 09, 2018
The Conformity Assessment Body Identifier is CN0008.

6 TEST SYSTEM UNCERTAINTY

The following measurement uncertainty levels have been estimated for tests performed on the apparatus:

Parameter	Uncertainty
Radio Frequency	$\pm 1 \times 10^{-5}$
Maximum Peak Output Power Test	$\pm 1.0\text{dB}$
Conducted Emissions Test	$\pm 2.0\text{dB}$
Radiated Emission Test	$\pm 2.0\text{dB}$
Power Density	$\pm 2.0\text{dB}$
Occupied Bandwidth Test	$\pm 1.0\text{dB}$
Band Edge Test	$\pm 3\text{dB}$
All emission, radiated	$\pm 3\text{dB}$
Antenna Port Emission	$\pm 3\text{dB}$
Temperature	$\pm 0.5^\circ\text{C}$
Humidity	$\pm 3\%$

Measurement Uncertainty for a level of Confidence of 95%



7 SETUP OF EQUIPMENT UNDER TEST

7.1 RADIO FREQUENCY TEST SETUP 1

The Bluetooth 5.0 DTS component's antenna ports(s) of the EUT are connected to the measurement instrument per an appropriate attenuator. The EUT is controlled by PC/software to emit the specified signals for the purpose of measurements.

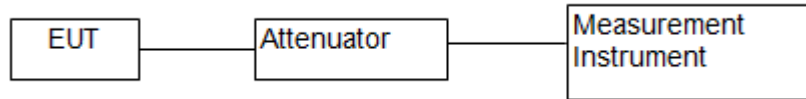

7.2 RADIO FREQUENCY TEST SETUP 2

The test site semi-anechoic chamber has met the requirement of NSA tolerance 4 dB according to the standards: ANSI C63.10. The test distance is 3m. The setup is according to the requirements in Section 13.1.4.1 of ANSI C63.10-2013 and CAN/CSA-CEI/IEC CISPR 22.

Below 30MHz:

The EUT is placed on a turntable 0.8 meters above the ground in the chamber, 3 meter away from the antenna (loop antenna). The Antenna should be positioned with its plane vertical at the specified distance from the EUT and rotated about its vertical axis for maximum response at each azimuth about the EUT. The center of the loop shall be 1 m above the ground. For certain applications, the loop antenna plane may also need to be positioned horizontally at the specified distance from the EUT.

30MHz-1GHz:

The EUT is placed on a turntable 0.8 meters above the ground in the chamber, 3 meter away from the antenna. The maximal emission value is acquired by adjusting the antenna height, polarisation and turntable azimuth. Normally, the height range of antenna is 1 m to 4 m, the azimuth range of turntable is 0° to 360°, and the receive antenna has two polarizations Vertical (V) and Horizontal (H).

Above 1GHz:

The EUT is placed on a turntable 1.5 meters above the ground in the chamber, 3 meter away from the antenna. The maximal emission value is acquired by adjusting the antenna height, polarisation and turntable azimuth. Normally, the height range of antenna is 1 m to 4 m, the azimuth range of turntable is 0° to 360°, and the receive antenna has two polarizations Vertical (V) and Horizontal (H).

(a) Radiated Emission Test Set-Up, Frequency Below 30MHz

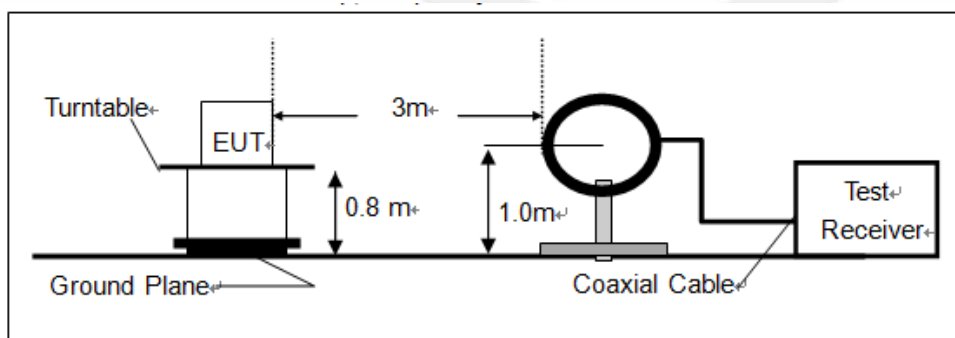

(b) Radiated Emission Test Set-Up, Frequency Below 1000MHz

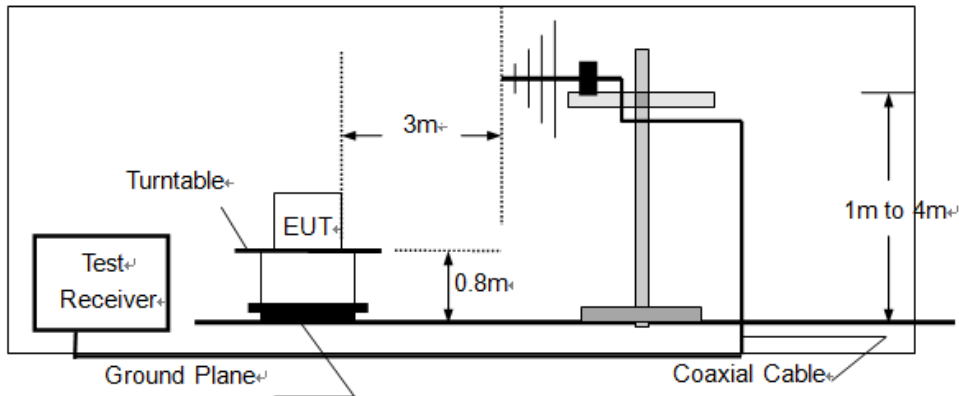

(c) Radiated Emission Test Set-Up, Frequency above 1000MHz

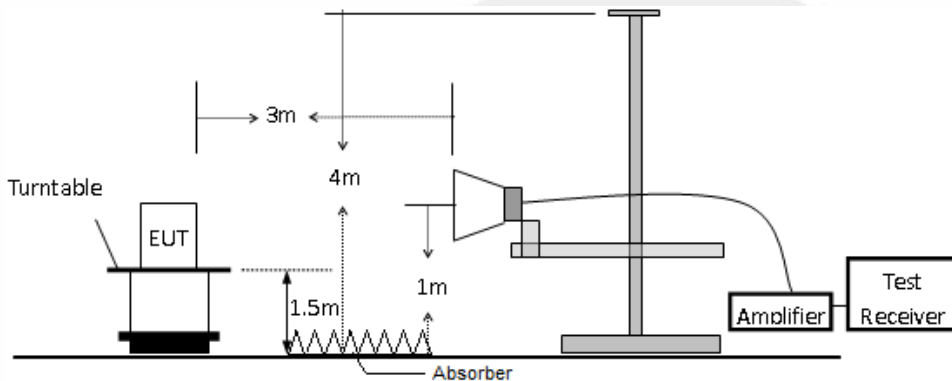

7.3 CONDUCTED EMISSION TEST SETUP

The mains cable of the EUT (maybe per AC/DC Adapter) must be connected to LISN. The LISN shall be placed 0.8 m from the boundary of EUT and bonded to a ground reference plane for LISN mounted on top of the ground reference plane. This distance is between the closest points of the LISN and the EUT. All other units of the EUT and associated equipment shall be at least 0.8m from the LISN.

Ground connections, where required for safety purposes, shall be connected to the reference ground point of the LISN and, where not otherwise provided or specified by the manufacturer, shall be of same length as the mains cable and run parallel to the mains connection at a separation distance of not more than 0.1 m.

According to the requirements in Section 13.1.4.1 of ANSI C63.10-2013 Conducted emissions from the EUT measured in the frequency range between 0.15 MHz and 30 MHz using CISPR Quasi-Peak and average detector mode.

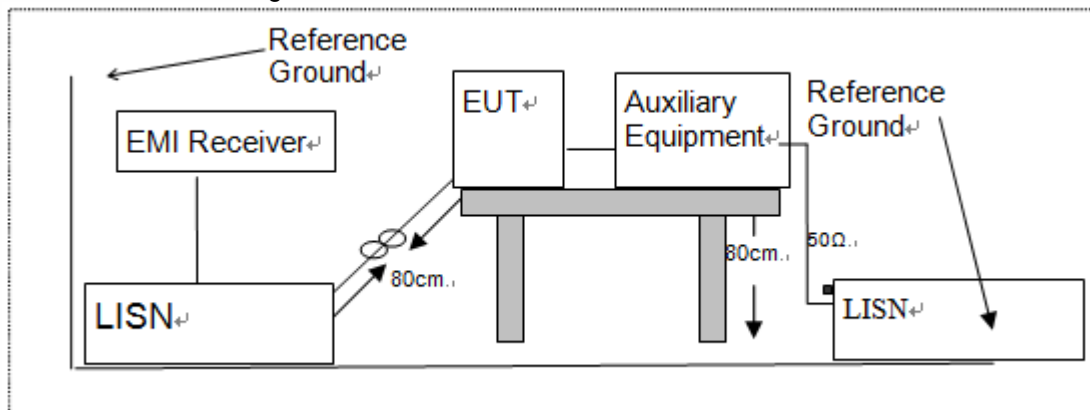

7.4 SUPPORT EQUIPMENT

Item	Equipment	Mfr/Brand	Model/Type No.	Series No.	Note

Notes:

- 1. All the equipment/cables were placed in the worst-case configuration to maximize the emission during the test.*
- 2. Grounding was established in accordance with the manufacturer's requirements and conditions for the intended use.*



8 TEST REQUIREMENTS

8.1 DTS 6DB BANDWIDTH

8.1.1 Applicable Standard

According to FCC Part 15.247(a)(2) and FCC KDB 558074 D01 15.247 Meas Guidance v05r02

8.1.2 Conformance Limit

The minimum -6 dB bandwidth shall be at least 500 kHz.

8.1.3 Test Configuration

Test according to clause 7.1 radio frequency test setup 1

8.1.4 Test Procedure

The EUT was operating in Bluetooth 5.0 DTS mode and controlled its channel. Printed out the test result from the spectrum by hard copy function.

The RF output of EUT was connected to the spectrum analyzer by RF cable and attenuator. The path loss was compensated to the results for each measurement.

Set to the maximum power setting and enable the EUT transmit continuously

Set RBW = 100 kHz.

Set the video bandwidth (VBW) =300 kHz.

Set Span=2 times OBW

Set Detector = Peak.

Set Trace mode = max hold.

Set Sweep = auto couple.

Allow the trace to stabilize.

Measure the maximum width of the emission that is constrained by the frequencies associated with the two outermost amplitude points (upper and lower frequencies) that are attenuated by 6 dB relative to the maximum level measured in the fundamental emission.

Measure and record the results in the test report.

Test Results

Temperature : 24.2°C Test Date : Mar. 3, 2020
Humidity : 53.2 % Test By: XW

Operation Mode	Channel Number	Channel Frequency (MHz)	Measurement Bandwidth (kHz)	Limit (kHz)	Verdict
Bluetooth 5.0 DTS	0	2402	657.5	>500	PASS
	19	2440	664.0	>500	PASS
	39	2480	658.3	>500	PASS

DTS (6dB) Bandwidth
Bluetooth 5.0DTS
Channel 0: 2402MHz

Test Model

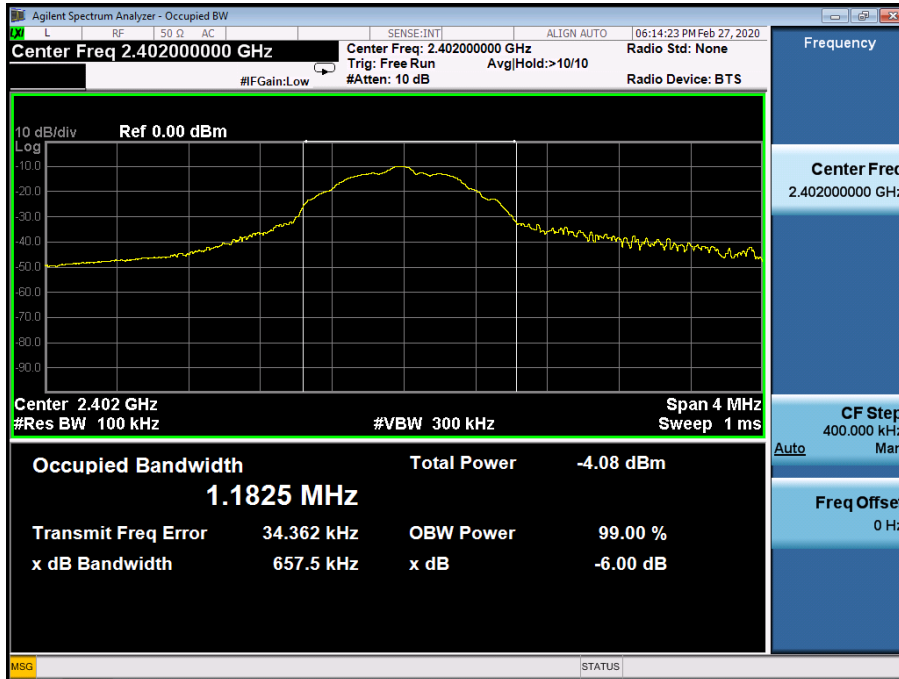

DTS (6dB) Bandwidth
Bluetooth 5.0DTS
Channel 19: 2440MHz

Test Model

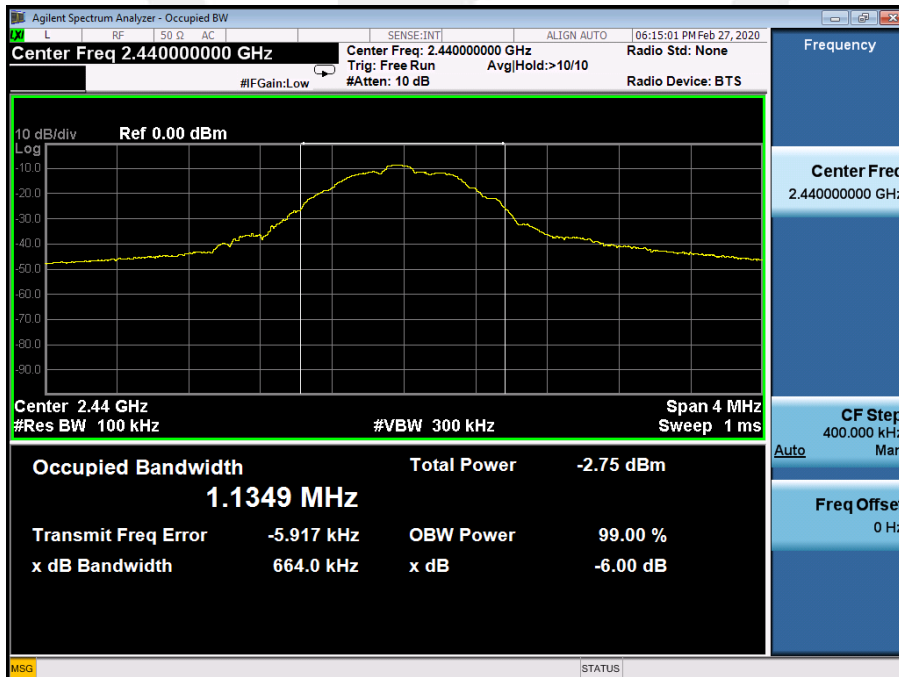

Test Model DTS (6dB) Bandwidth
Bluetooth 5.0DTS
Channel 39: 2480MHz

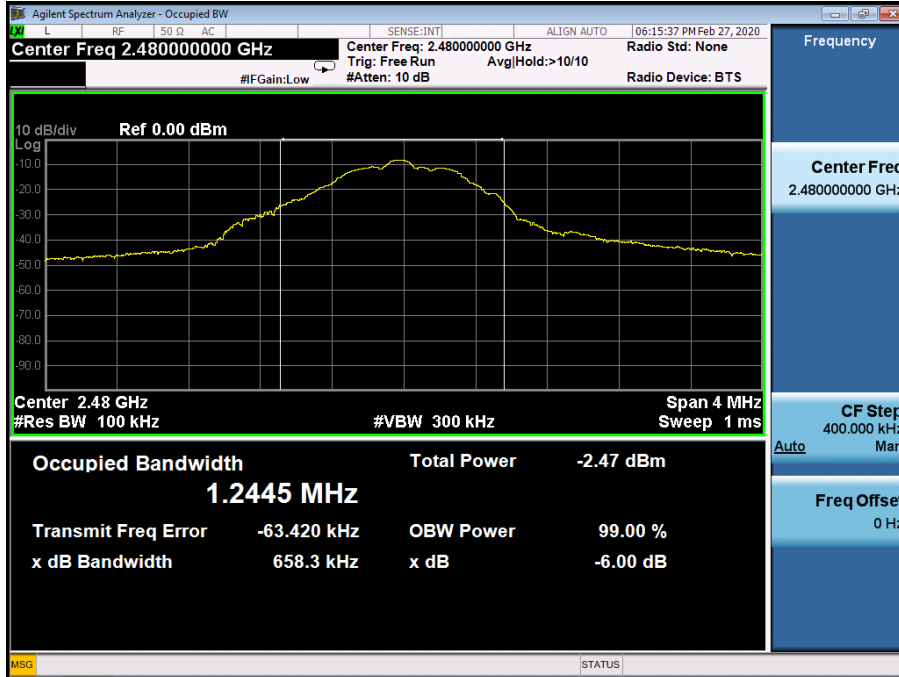

8.2 MAXIMUM PEAK CONDUCTED OUTPUT POWER

8.2.1 Applicable Standard

According to FCC Part 15.247(b)(3) and FCC KDB 558074 D01 15.247 Meas Guidance v05r02

8.2.2 Conformance Limit

The maximum peak conducted output power of the intentional radiator for systems using digital modulation in the 2400 - 2483.5 MHz bands shall not exceed: 1 Watt (30dBm).

8.2.3 Test Configuration

Test according to clause 7.1 radio frequency test setup 1

8.2.4 Test Procedure

■ According to FCC Part 15.247(b)(3)

As an alternative to a peak power measurement, compliance with the one Watt limit can be based on a measurement of the maximum conducted output power. For smart system, Maximum Conducted Output Power is defined as the total transmit power delivered to all antennas and antenna elements averaged across all symbols in the signaling alphabet when the transmitter is operating at its maximum power control level. Power must be summed across all antennas and antenna elements. If multiple modes of operation are possible (e.g., alternative modulation methods), the maximum conducted output power is the highest total transmit power occurring in any mode.

Set the RBW \cong DTS bandwidth (about 1MHz).

Set VBW = 3*RBW (about 3MHz)

Set the span \cong 3*RBW

Set Sweep time = auto couple.

Set Detector = peak.

Set Trace mode = max hold.

Allow trace to fully stabilize. Use peak marker function to determine the peak amplitude level.

■ According to FCC Part 15.247(b)(4):

Conducted output power limit specified in paragraph (b) of this section is based on the use of antennas with directional gains that do not exceed 6 dBi. If transmitting antennas of directional gain greater than 6 dBi are used, the conducted output power from the intentional radiator shall be reduced below the stated values in paragraphs (b)(3) of this section, as appropriate, by the amount in dB that the directional gain of the antenna exceeds 6 dBi.

Test Results

Temperature : 24.2°C Test Date : Mar. 3, 2020
Humidity : 53.2 % Test By: XW

Operation Mode	Channel Number	Channel Frequency (MHz)	Measurement Level (dBm)	Limit (dBm)	Verdict
Bluetooth 5.0DTS	0	2402	-9.951	30	PASS
	19	2440	-8.666	30	PASS
	39	2480	-8.269	30	PASS

Test Model	Maximum Conducted Output Power	
	Bluetooth 5.0 DTS	
	Channel 0: 2402MHz	GFSK modulation

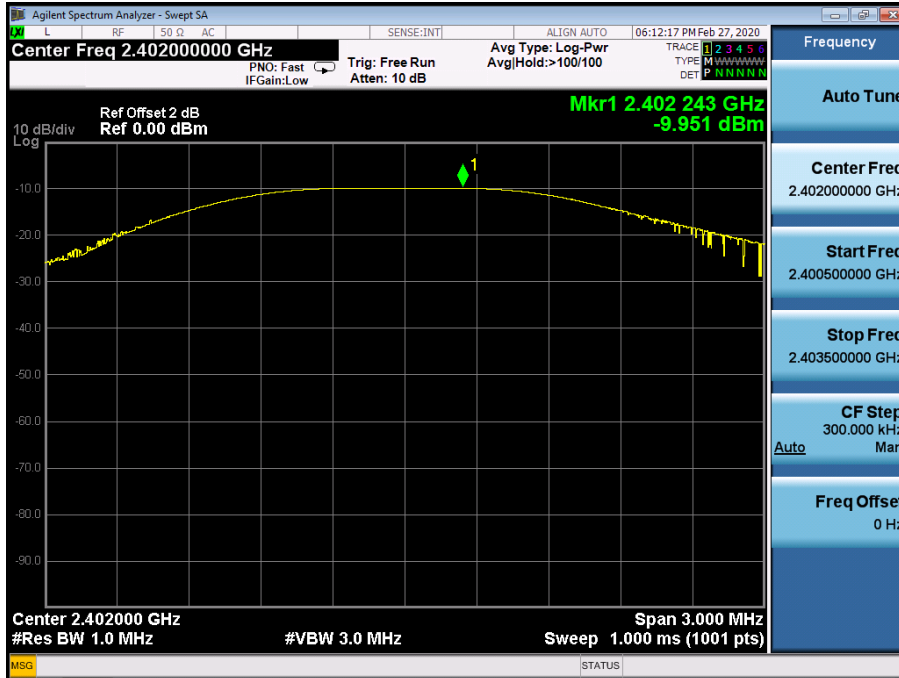

Test Model	Maximum Conducted Output Power	
	Bluetooth 5.0 DTS	
	Channel 19: 2440MHz	GFSK modulation

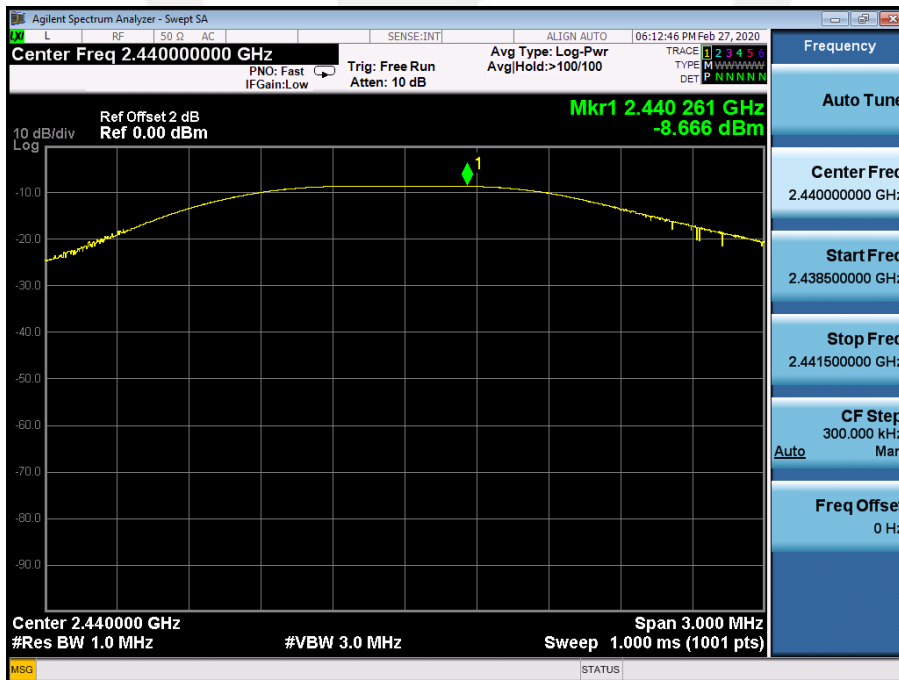

Test Model	Maximum Conducted Output Power	
	Bluetooth 5.0 DTS	
	Channel 39: 2480MHz	GFSK modulation

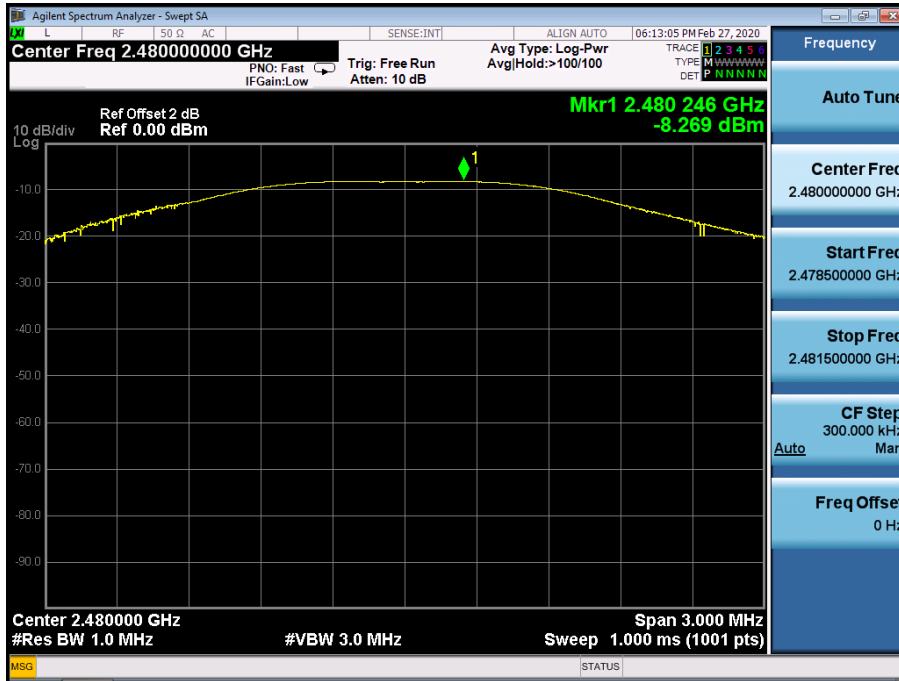

8.3 MAXIMUM POWER SPECTRAL DENSITY

8.3.1 Applicable Standard

According to FCC Part 15.247(e) and FCC KDB 558074 D01 15.247 Meas Guidance v05r02

8.3.2 Conformance Limit

The transmitter power spectral density conducted from the transmitter to the antenna shall not be greater than 8 dBm in any 3 kHz band during any time interval of continuous transmission.

8.3.3 Test Configuration

Test according to clause 7.1 radio frequency test setup 1

8.3.4 Test Procedure

This procedure shall be used if maximum peak conducted output power was used to demonstrate compliance

The transmitter output (antenna port) was connected to the spectrum analyzer

Set analyzer center frequency to DTS channel center frequency.

Set the span to 1.5 times the DTS bandwidth.

Set the RBW to: 3 kHz

Set the VBW to: 10 kHz.

Set Detector = peak.

Set Sweep time = auto couple.

Set Trace mode = max hold.

Allow trace to fully stabilize.

Use the peak marker function to determine the maximum amplitude level within the RBW.

8.3.5 Test Results

Temperature : 24.2°C Test Date : Mar. 3, 2020
Humidity : 53.2 % Test By: XW

Operation Mode	Channel Number	Channel Frequency (MHz)	Measurement Level (dBm/3kHz)	Limit (dBm/3kHz)	Verdict
Bluetooth 5.0 DTS	0	2402	-11.115	<8	PASS
	19	2440	-9.820	<8	PASS
	39	2480	-9.476	<8	PASS
Note: N/A					

Test Model Power Spectral Density
Bluetooth 5.0 DTS
Channel 0: 2402MHz

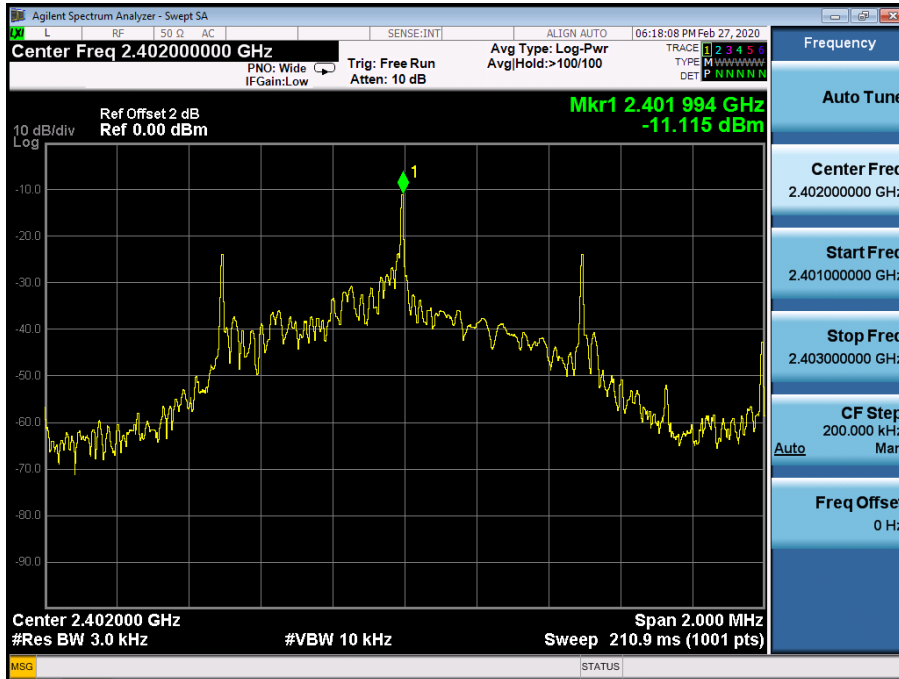

Test Model Power Spectral Density
Bluetooth 5.0 DTS
Channel 19: 2440MHz

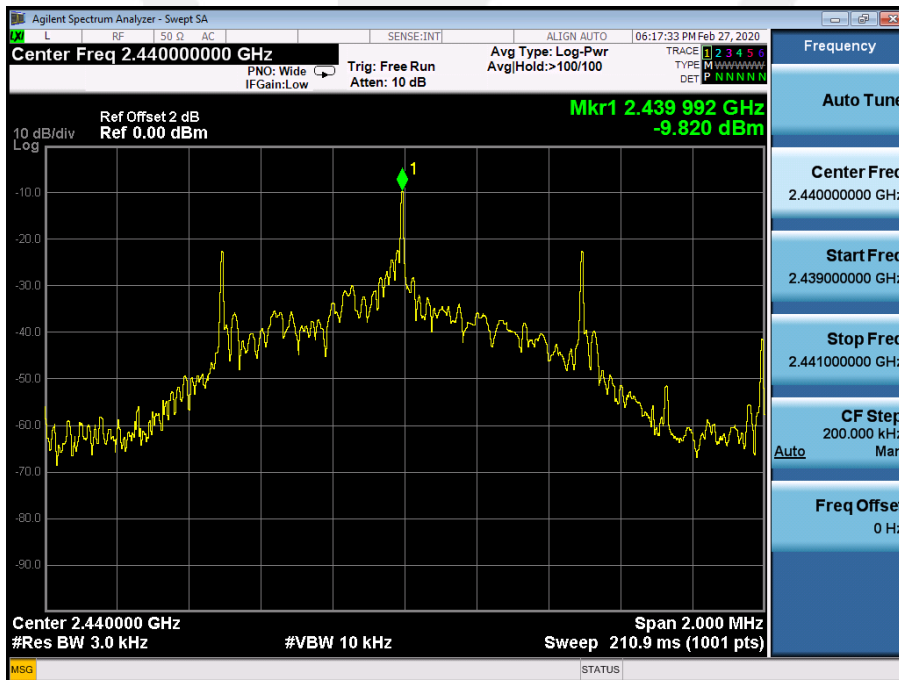

Test Model Power Spectral Density
Bluetooth 5.0 DTS
Channel 39: 2480MHz

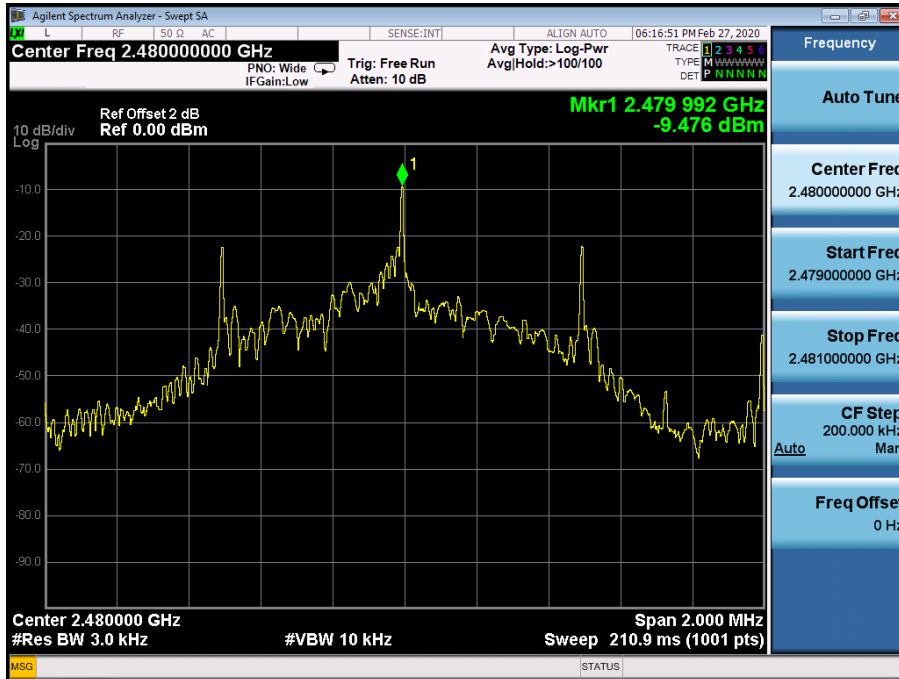

8.4 UNWANTED EMISSIONS IN NON-RESTRICTED FREQUENCY BANDS

8.4.1 Applicable Standard

According to FCC Part 15.247(d) and FCC KDB 558074 D01 15.247 Meas Guidance v05r02

8.4.2 Conformance Limit

According to FCC Part 15.247(d):

In any 100 kHz bandwidth outside the frequency band in which the spread spectrum or digitally modulated intentional radiator is operating, the radio frequency power that is produced by the intentional radiator shall be at least 20 dB below that in the 100 kHz bandwidth within the band that contains the highest level of the desired power, based on either an RF conducted or a radiated measurement, provided the transmitter demonstrates compliance with the peak conducted power limits. If the transmitter complies with the conducted power limits based on the use of RMS averaging over a time interval, as permitted under paragraph (b)(3) of this section, the attenuation required under this paragraph shall be 30 dB instead of 20 dB.

8.4.3 Test Configuration

Test according to clause 7.1 radio frequency test setup 1

8.4.4 Test Procedure

The transmitter output (antenna port) was connected to the spectrum analyzer

■ Reference level measurement

Establish a reference level by using the following procedure:

Set instrument center frequency to DTS channel center frequency.

Set the span to = 1.5 times the DTS bandwidth.

Set the RBW = 100 kHz.

Set the VBW $\geq 3 \times$ RBW.

Set Detector = peak.

Set Sweep time = auto couple.

Set Trace mode = max hold.

Allow trace to fully stabilize.

Use the peak marker function to determine the maximum PSD level.

Note that the channel found to contain the maximum PSD level can be used to establish the reference level.

■ Emission level measurement

Set the center frequency and span to encompass frequency range to be measured.

Set the RBW = 100 kHz.

Set the VBW = 300 kHz.

Set Detector = peak

Sweep time = auto couple.

Trace mode = max hold.

Allow trace to fully stabilize.

Use the peak marker function to determine the maximum amplitude level.

Ensure that the amplitude of all unwanted emissions outside of the authorized frequency band (excluding restricted frequency bands) are attenuated by at least the minimum requirements. Report the three highest emissions relative to the limit.

8.4.5 Test Results

Test Model PSD(Power Spectral Density) RBW=100kHz
Bluetooth 5.0 DTS
Channel 0: 2402MHz

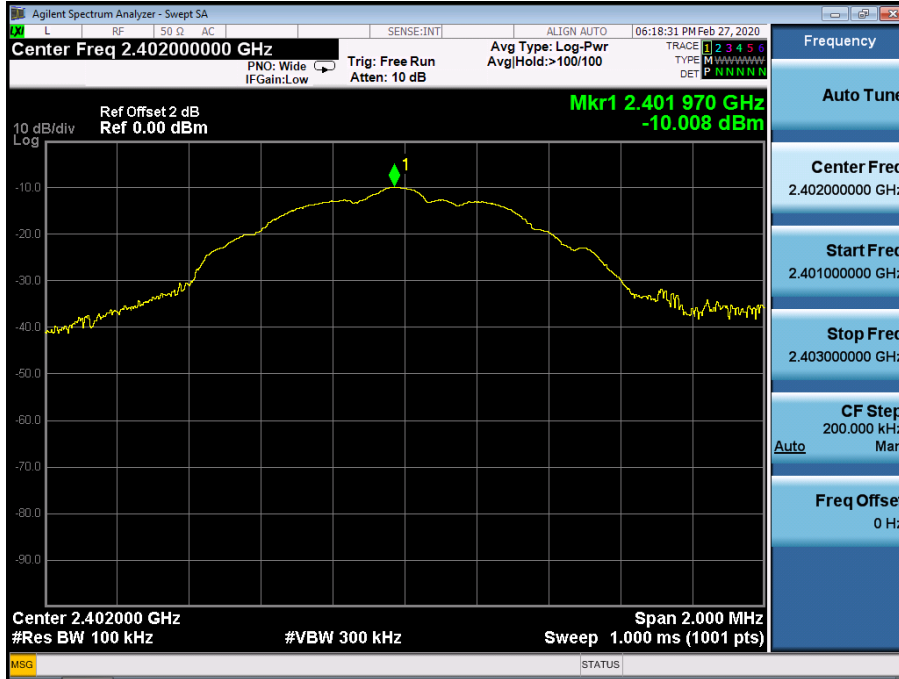

Test Model Unwanted Emissions in non-restricted frequency bands
Bluetooth 5.0 DTS
Channel 0: 2402MHz

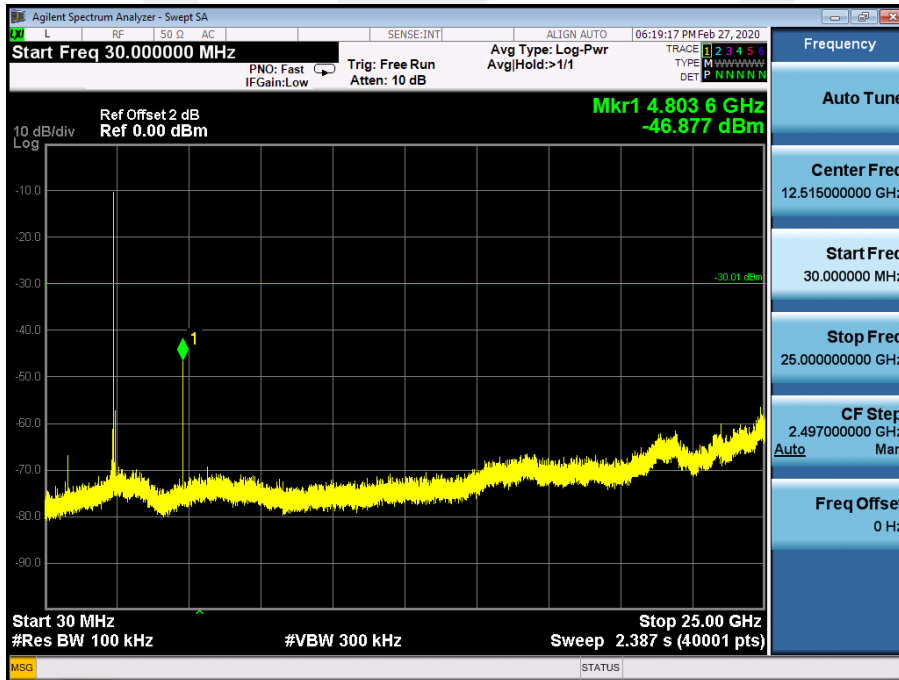

Test Model Band edge
Bluetooth 5.0 DTS
Channel 0: 2402MHz

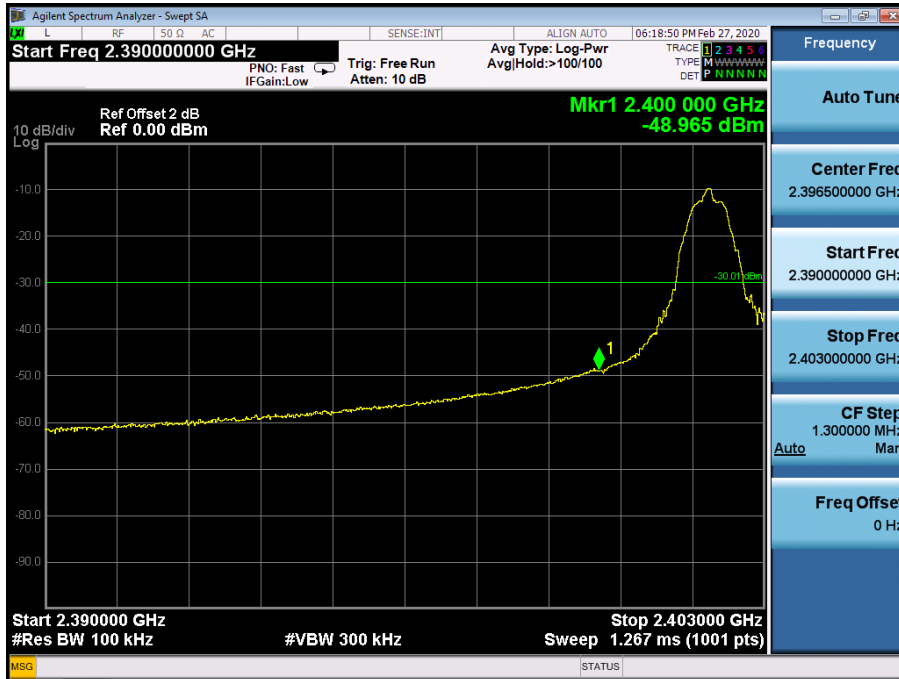

Test Model PSD(Power Spectral Density) RBW=100kHz
Bluetooth 5.0 DTS
Channel 19: 2440MHz

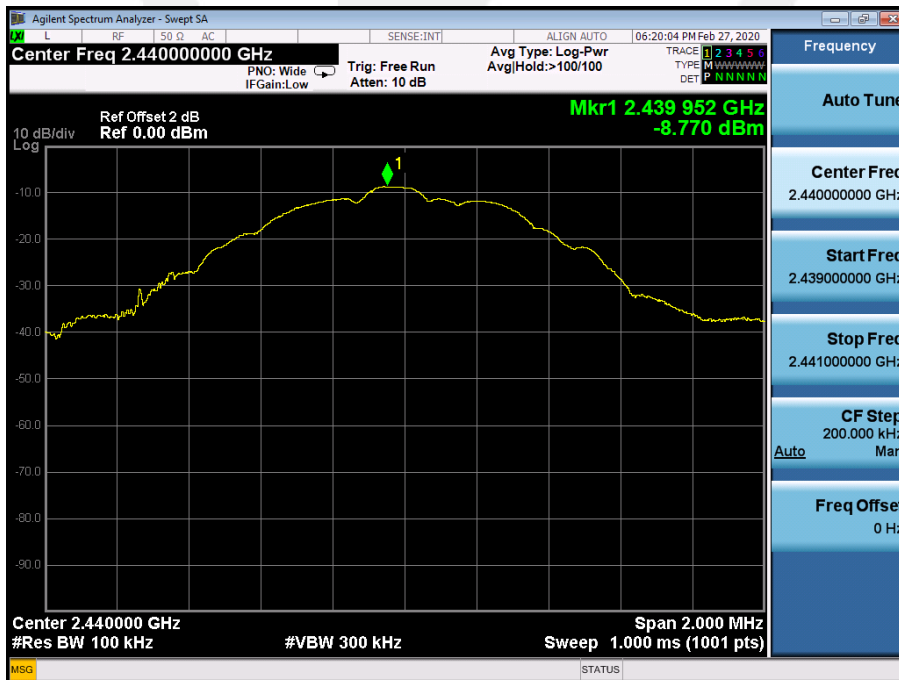

Test Model Unwanted Emissions In Non-Restricted Frequency Bands
Bluetooth 5.0 DTS
Channel 19: 2440MHz

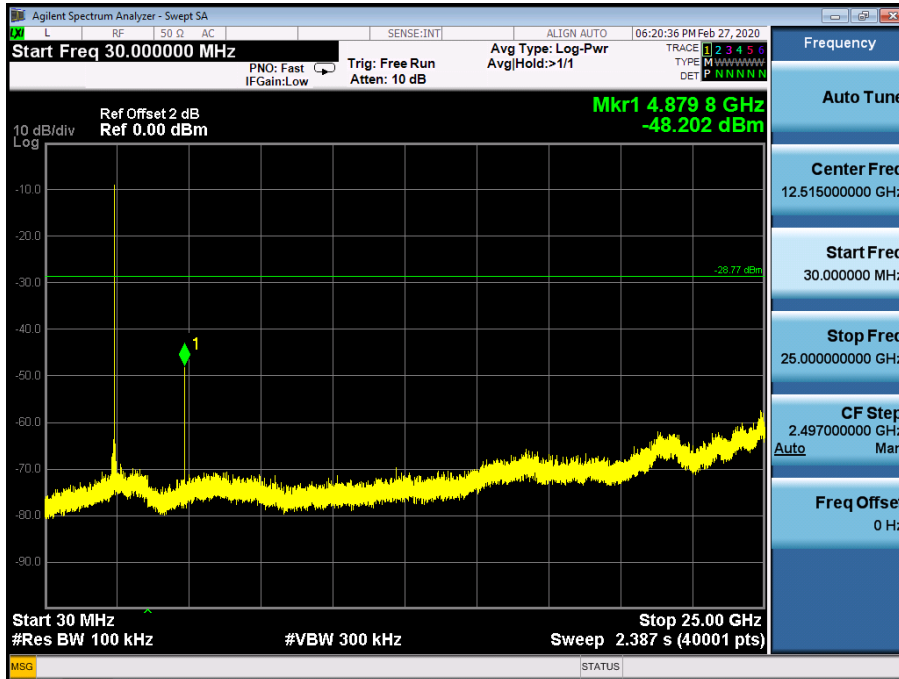

Test Model PSD(Power Spectral Density) RBW=100kHz
Bluetooth 5.0 DTS
Channel 19: 2480MHz

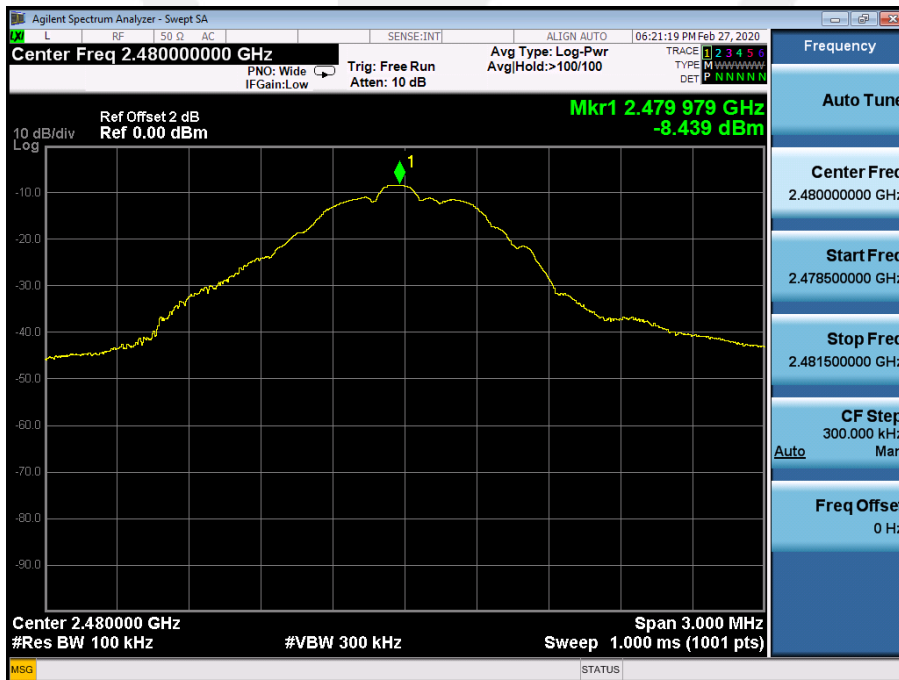

Test Model Unwanted Emissions In Non-Restricted Frequency Bands
Bluetooth 5.0 DTS
Channel 39: 2480MHz

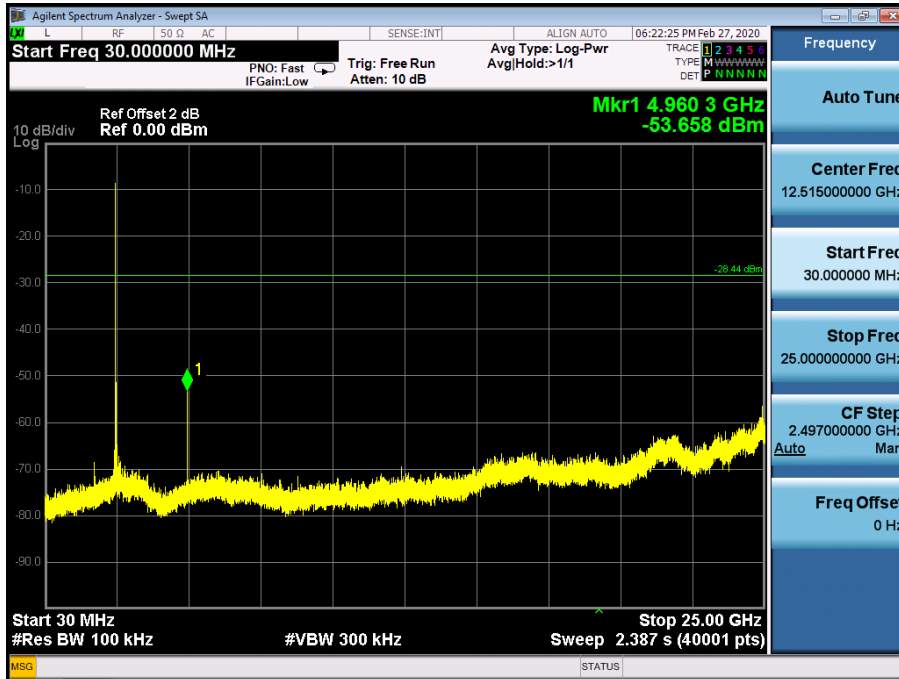

Test Model Band edge
Bluetooth 5.0 DTS
Channel 39: 2480MHz

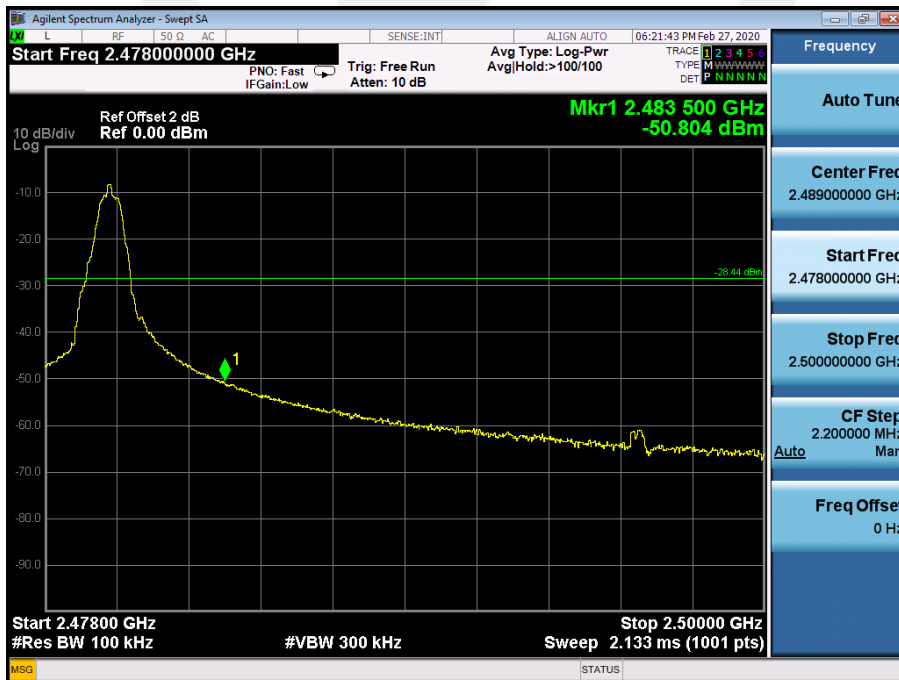

8.5 RADIATED SPURIOUS EMISSION

8.5.1 Applicable Standard

According to FCC Part 15.247(d) and 15.209 and FCC KDB 558074 D01 15.247 Meas Guidance v05r02

8.5.2 Conformance Limit

According to FCC Part 15.247(d): radiated emissions which fall in the restricted bands, as defined in §15.205(a), must also comply with the radiated emission limits specified in §15.209(a) (see §15.205(c)).

According to FCC Part 15.205, Restricted bands

MHz	MHz	MHz	GHz
0.090-0.110	16.42-16.423	399.9-410	4.5-5.15
10.495-0.505	16.69475-16.69525	608-614	5.35-5.46
2.1735-2.1905	16.80425-16.80475	960-1240	7.25-7.75
4.125-4.128	25.5-25.67	1300-1427	8.025-8.5
4.17725-4.17775	37.5-38.25	1435-1626.5	9.0-9.2
4.20725-4.20775	73-74.6	1645.5-1646.5	9.3-9.5
6.215-6.218	74.8-75.2	1660-1710	10.6-12.7
6.26775-6.26825	123-138	2200-2300	14.47-14.5
8.291-8.294	149.9-150.05	2310-2390	15.35-16.2
8.362-8.366	156.52475-156.52525	2483.5-2500	17.7-21.4
8.37625-8.38675	156.7-156.9	2690-2900	22.01-23.12
8.41425-8.41475	162.0125-167.17	3260-3267	23.6-24.0
12.29-12.293	167.72-173.2	3332-3339	31.2-31.8
12.51975-12.52025	240-285	3345.8-3358	36.43-36.5
12.57675-12.57725	322-335.4	3600-4400	(2)
13.36-13.41			

According to FCC Part 15.205, the level of any transmitter spurious emission in Restricted bands shall not exceed the level of the emission specified in the following table

Restricted Frequency(MHz)	Field Strength ($\mu\text{V/m}$)	Field Strength ($\text{dB}\mu\text{V/m}$)	Measurement Distance
0.009-0.490	2400/F(KHz)	20 log (uV/m)	300
0.490-1.705	2400/F(KHz)	20 log (uV/m)	30
1.705-30	30	29.5	30
30-88	100	40	3
88-216	150	43.5	3
216-960	200	46	3
Above 960	500	54	3

8.5.3 Test Configuration

Test according to clause 7.2 radio frequency test setup 2

8.5.4 Test Procedure

This test is required for any spurious emission that falls in a Restricted Band, as defined in Section 15.205. It must be performed with the highest gain of each type of antenna proposed for use with the EUT. Use the following spectrum analyzer settings:

The EUT was placed on a turn table which is 0.8m above ground plane.

Maximum procedure was performed on the highest emissions to ensure EUT compliance.

Span = wide enough to fully capture the emission being measured

RBW = 1 MHz for $f \geq 1$ GHz(1GHz to 25GHz), 100 kHz for $f < 1$ GHz(30MHz to 1GHz)

VBW \geq RBW

Sweep = auto

Detector function = peak

Trace = max hold

Temperature : 24.2°C Test Date : Mar. 3, 2020
 Humidity : 53.2 % Test By: XW
 Test mode: Bluetooth 5.0 DTS Frequency: Channel 19: 2440MHz

Freq. (MHz)	Ant. Pol. H/V	Emission Level(dBuV/m)		Limit 3m(dBuV/m)		Over(dB)	
		PK	AV	PK	AV	PK	AV
4879.40	V	49.24	36.31	74	54	-24.76	-17.69
11948.85	V	58.33	40.08	74	54	-15.67	-13.92
17950.70	V	62.14	41.67	74	54	-11.86	-12.33
4879.40	H	52.46	43.13	74	54	-21.54	-10.87
11901.25	H	58.98	39.64	74	54	-15.02	-14.36
17693.15	H	62.25	41.02	74	54	-11.75	-12.98

Temperature : 24.2°C Test Date : Mar. 3, 2020
 Humidity : 53.2 % Test By: XW
 Test mode: Bluetooth 5.0 DTS Frequency: Channel 39: 2480MHz

Freq. (MHz)	Ant. Pol. H/V	Emission Level(dBuV/m)		Limit 3m(dBuV/m)		Over(dB)	
		PK	AV	PK	AV	PK	AV
4960.15	V	48.19	35.26	74	54	-25.81	-18.74
11746.55	V	58.87	40.27	74	54	-15.13	-13.73
17969.40	V	61.96	41.07	74	54	-12.04	-12.93
4960.15	H	50.79	37.09	74	54	-23.21	-16.91
10342.35	H	56.73	38.67	74	54	-17.27	-15.33
17746.70	H	62.06	40.23	74	54	-11.94	-13.77

- Note:** (1) All Readings are Peak Value (VBW=3MHz) and Peak Value (VBW=10Hz).
 (2) Emission Level= Reading Level+Probe Factor +Cable Loss.
 (3) Data of measurement within this frequency range shown "--" in the table above means the reading of emissions are attenuated more than 20dB below the permissible limits or the field strength is too small to be measured.

■ Spurious Emission in Restricted Band 2310-2390MHz and 2483.5-2500MHz

Temperature : 24.2°C Test Date : Mar. 3, 2020
 Humidity : 53.2 % Test By: XW
 Test mode: Bluetooth 5.0 DTS Frequency: Channel 0: 2402MHz

Frequency (MHz)	Polarity	PK(dBuV/m) (VBW=3MHz)	Limit 3m (dBuV/m)	Margin (dB)	AV(dBuV/m) (VBW=10Hz)	Limit 3m (dBuV/m)	Margin (dB)
2389.804	V	53.58	74	-20.42	38.24	54	-15.76
2389.828	H	56.89	74	-17.11	32.62	54	-21.38

Temperature : 24.2°C Test Date : Mar. 3, 2020
 Humidity : 53.2 % Test By: XW
 Test mode: Bluetooth 5.0 DTS Frequency: Channel 39: 2480MHz

Frequency (MHz)	Polarity	PK(dBuV/m) (VBW=3MHz)	Limit 3m (dBuV/m)	Margin (dB)	AV(dBuV/m) (VBW=10Hz)	Limit 3m (dBuV/m)	Margin (dB)
2483.500	V	52.23	74	-21.77	33.56	54	-20.44
2483.534	H	66.06	74	-7.94	40.62	54	-13.38

- Note:** (1) All Readings are Peak Value (VBW=3MHz) and Peak Value (VBW=10Hz).
 (2) Emission Level= Reading Level+Probe Factor +Cable Loss.
 (3) Data of measurement within this frequency range shown "--" in the table above means the reading of emissions are attenuated more than 20dB below the permissible limits or the field strength is too small to be measured.

All the modulation modes were tested, the data of the worst mode are described in the following table.

Test Model	Spurious Emission in Restricted Band 2310-2390MHz
	Bluetooth 5.0 DTS
	Channel 0: 2402MHz
	V

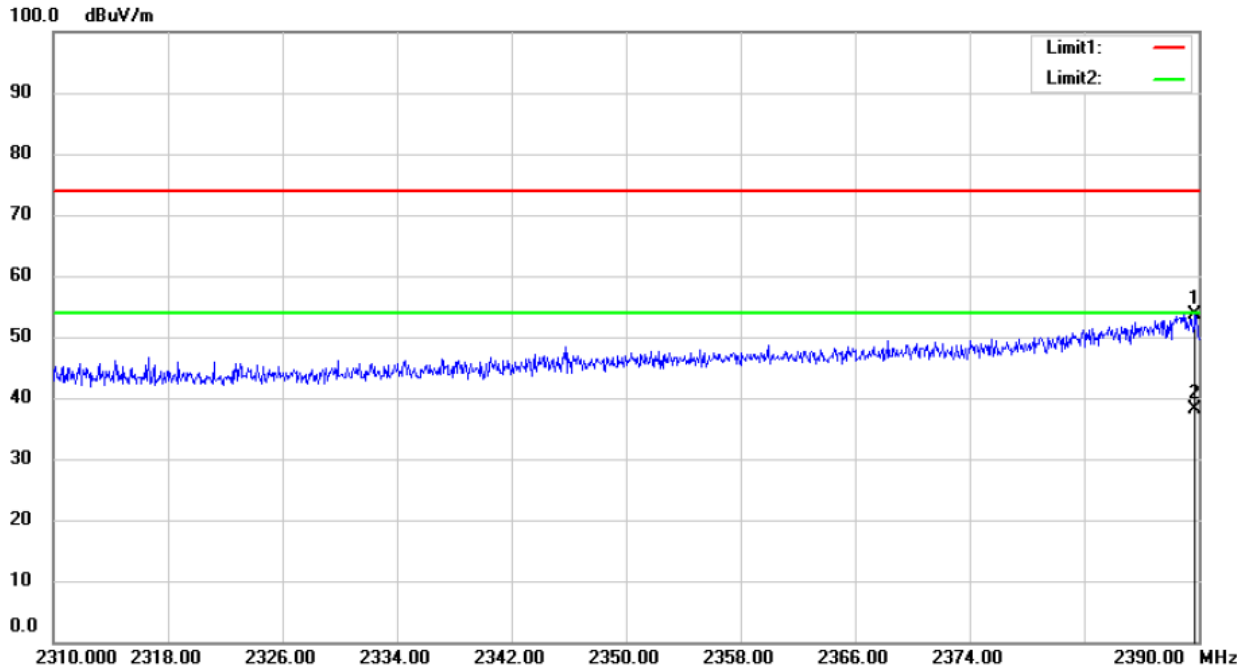

Test Model	Spurious Emission in Restricted Band 2310-2390MHz
	Bluetooth 5.0 DTS
	Channel 0: 2402MHz
	H

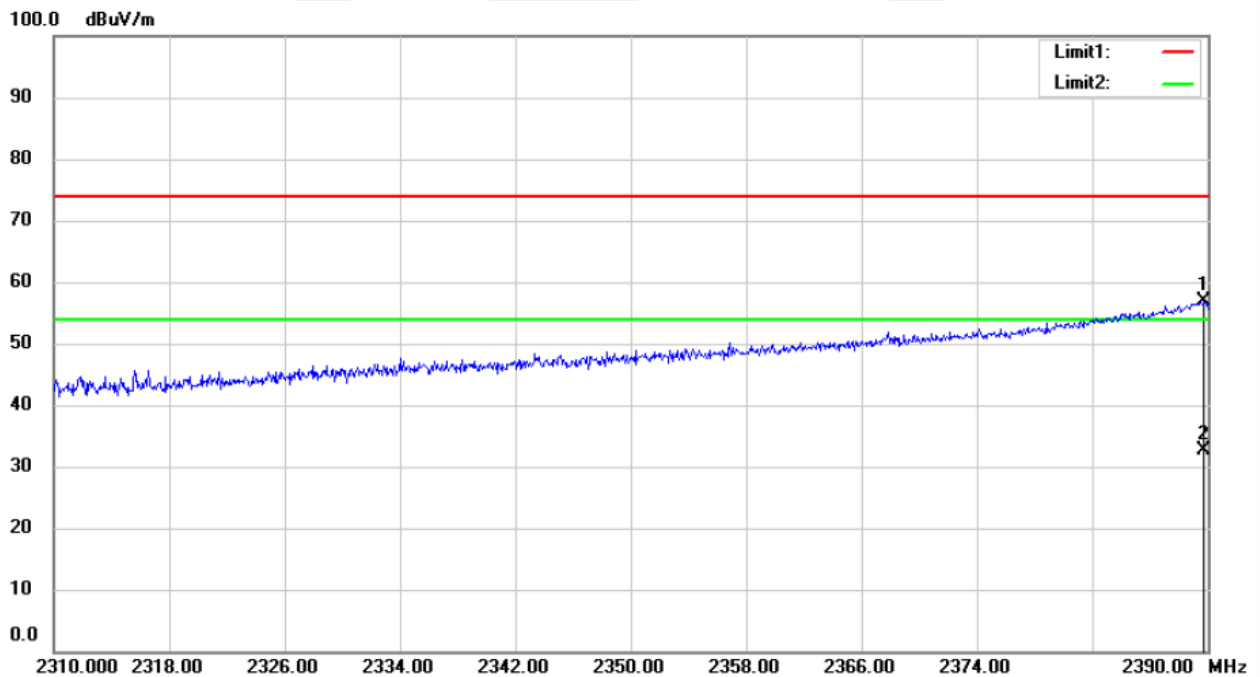

Test Model Spurious Emission in Restricted Band 2483.5-2500MHz
Bluetooth 5.0 DTS
Channel 39: 2480MHz V

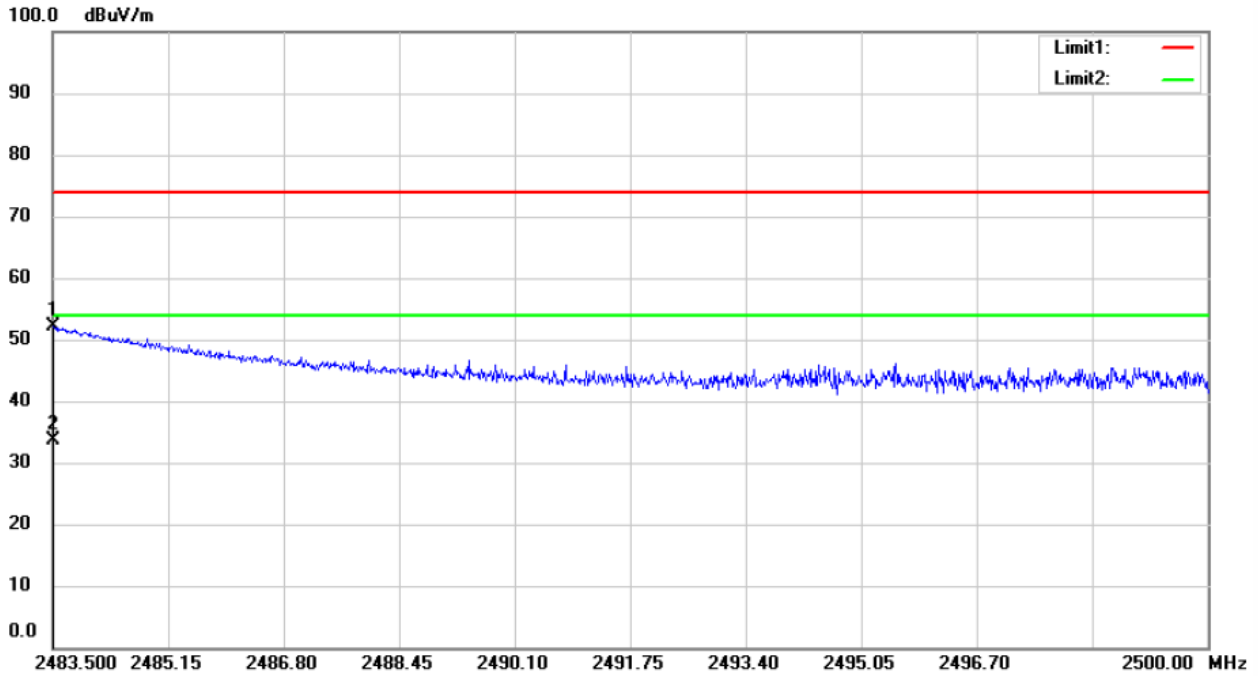

Test Model Spurious Emission in Restricted Band 2483.5-2500MHz
Bluetooth 5.0 DTS
Channel 39: 2480MHz H

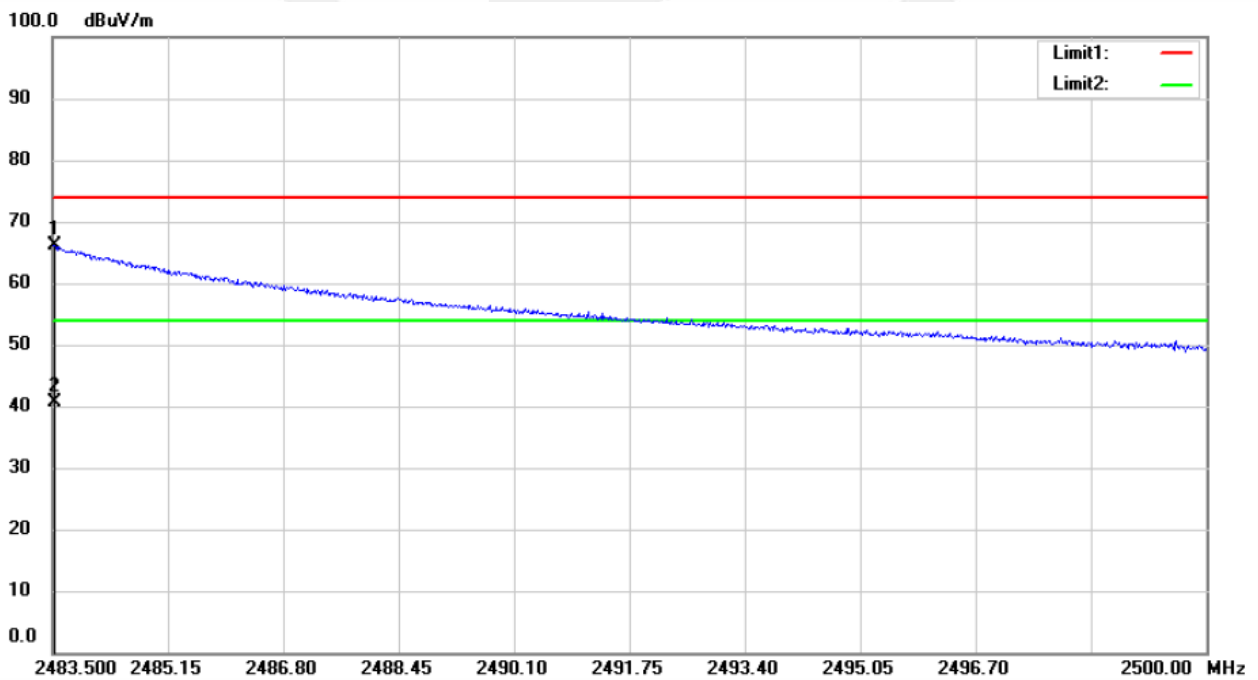

■ Spurious Emission below 1GHz (30MHz to 1GHz)

Radiated Emission Measurement

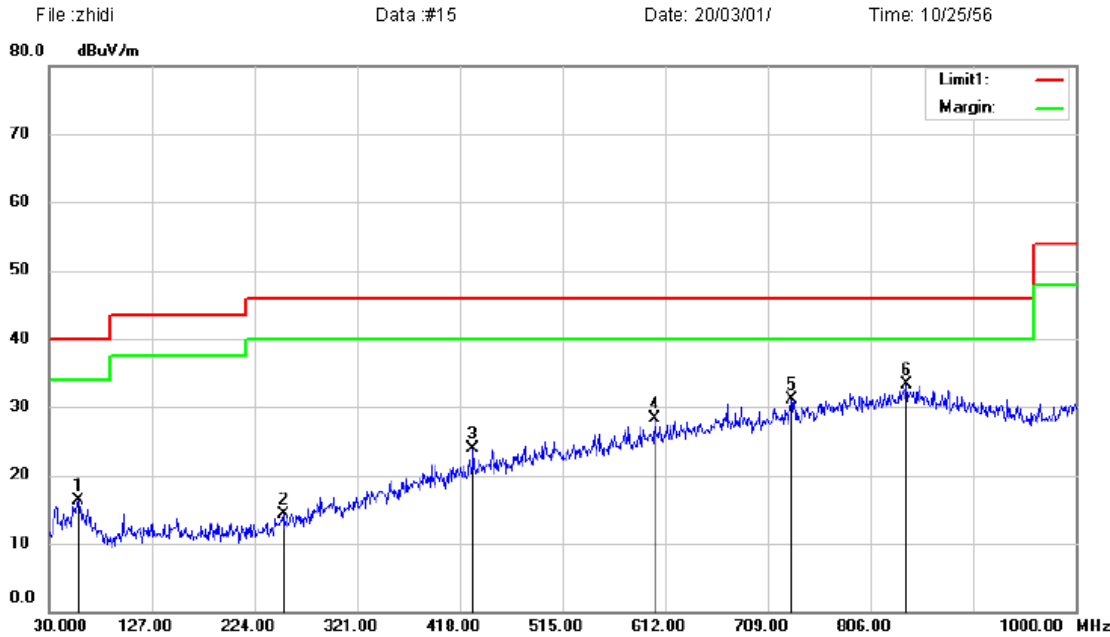

Site: 3m Chamber #1 Polarization: **Vertical** Temperature: 29.5 C
 Limit: (RE)FCC PART 15 C Power: AC 120V/60Hz Humidity: 48 %
 EUT:
 M/N: M600A
 Mode: BLE 2402MHz
 Note: EUT:Lenovo Legion M600 Wireless Gaming Mouse

No.	Mk.	Freq.	Reading Level	Correct Factor	Measurement	Limit	Over	Antenna Height	Table Degree	Comment
		MHz	dBuV	dB	dBuV/m	dBuV/m	dB	cm	degree	
1		58.1300	28.19	-11.83	16.36	40.00	-23.64	QP		
2		251.1600	26.21	-11.99	14.22	46.00	-31.78	QP		
3		430.6100	28.84	-4.88	23.96	46.00	-22.04	QP		
4		602.3000	29.14	-0.82	28.32	46.00	-17.68	QP		
5		731.3100	29.17	2.03	31.20	46.00	-14.80	QP		
6	*	839.9500	28.43	4.92	33.35	46.00	-12.65	QP		

*:Maximum data x:Over limit !:over margin

Operator:

Radiated Emission Measurement

File :zhidi

Data :#16

Date: 20/03/01/

Time: 10/26/43

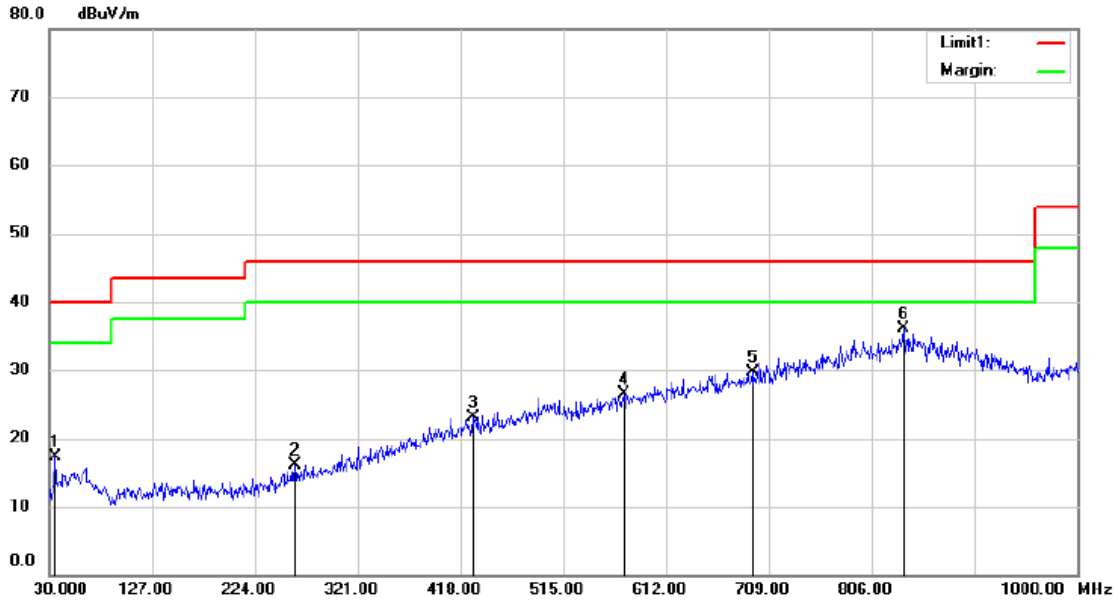

Site 3m Chamber #1

Polarization: *Horizontal*

Temperature: 29.5 C

Limit: (RE)FCC PART 15 C

Power: AC 120V/60Hz

Humidity: 48 %

EUT:

M/N: M600A

Mode: BLE 2402MHz

Note: EUT:Lenovo Legion M600 Wireless Gaming Mouse

No.	Mk.	Freq.	Reading Level	Correct Factor	Measurement	Limit	Over	Antenna Height	Table Degree	Comment
		MHz	dBuV	dB	dBuV/m	dBuV/m	dB	cm	degree	
1		35.8200	30.58	-13.19	17.39	40.00	-22.61	QP		
2		261.8300	27.81	-11.74	16.07	46.00	-29.93	QP		
3		429.6400	27.92	-4.90	23.02	46.00	-22.98	QP		
4		572.2300	28.30	-1.82	26.48	46.00	-19.52	QP		
5		693.4800	28.69	1.06	29.75	46.00	-16.25	QP		
6	*	836.0700	31.26	4.76	36.02	46.00	-9.98	QP		

*:Maximum data x:Over limit !:over margin

Operator:

Radiated Emission Measurement

File :zhidi

Data :#17

Date: 20/03/01/

Time: 10/27/49

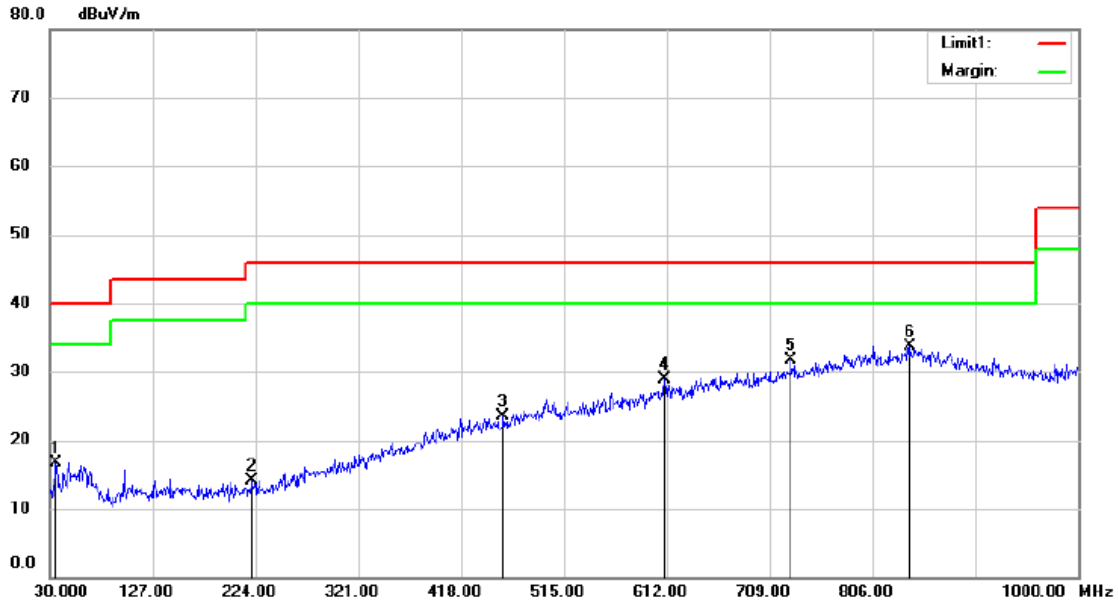

Site: 3m Chamber #1 Polarization: **Vertical** Temperature: 29.5 C

Limit: (RE)FCC PART 15 C Power: AC 120V/60Hz Humidity: 48 %

EUT:

M/N: M600A

Mode: BLE 2440MHz

Note: EUT:Lenovo Legion M600 Wireless Gaming Mouse

No.	Mk.	Freq. MHz	Reading Level dBuV	Correct Factor dB	Measure- ment dBuV/m	Limit dBuV/m	Over dB	Antenna Height cm	Table Degree degree	Detector	Comment
1		35.8200	29.91	-13.19	16.72	40.00	-23.28			QP	
2		221.0900	27.55	-13.48	14.07	46.00	-31.93			QP	
3		457.7700	28.37	-4.79	23.58	46.00	-22.42			QP	
4		610.0600	29.71	-0.71	29.00	46.00	-17.00			QP	
5		729.3700	29.76	1.99	31.75	46.00	-14.25			QP	
6	*	841.8900	28.83	4.93	33.76	46.00	-12.24			QP	

*:Maximum data x:Over limit !:over margin

Operator:

Radiated Emission Measurement

File :zhidi

Data :#18

Date: 20/03/01/

Time: 10/28/54

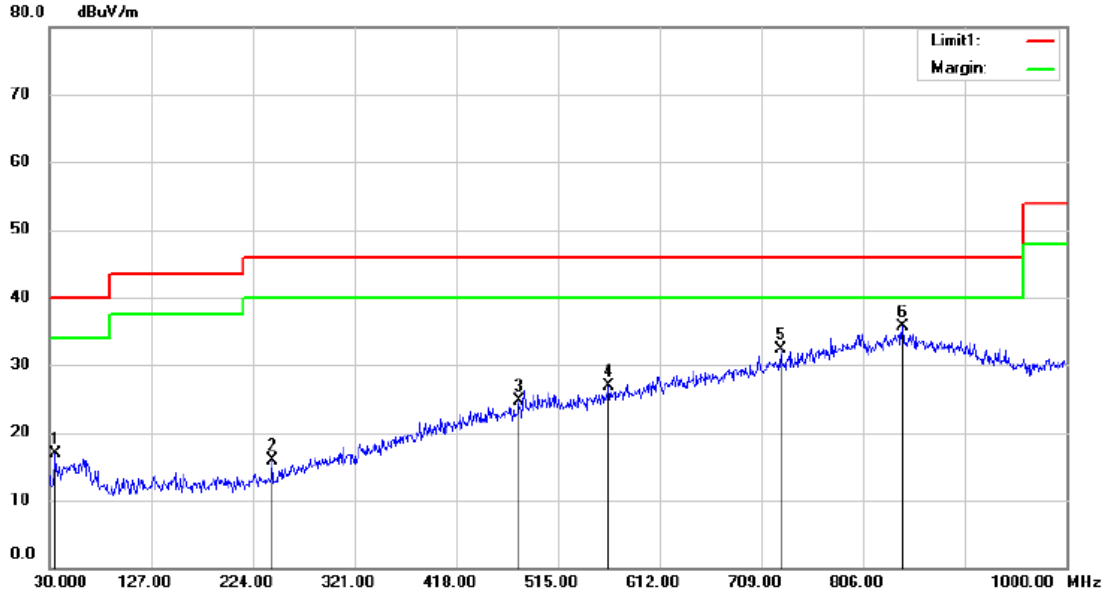

Site: 3m Chamber #1 Polarization: **Horizontal** Temperature: 29.5 C
 Limit: (RE)FCC PART 15 C Power: AC 120V/60Hz Humidity: 48 %
 EUT:
 M/N: M600A
 Mode: BLE 2440MHz
 Note: EUT:Lenovo Legion M600 Wireless Gaming Mouse

No.	Mk.	Freq. MHz	Reading Level dBuV	Correct Factor dB	Measure- ment dBuV/m	Limit dBuV/m	Over dB	Antenna Height cm	Table Degree degree	Comment
1		35.8200	30.06	-13.19	16.87	40.00	-23.13	QP		
2		242.4300	28.67	-12.80	15.87	46.00	-30.13	QP		
3		478.1400	28.97	-4.27	24.70	46.00	-21.30	QP		
4		563.5000	28.93	-2.05	26.88	46.00	-19.12	QP		
5		727.4300	30.34	1.93	32.27	46.00	-13.73	QP		
6	*	843.8300	30.85	4.93	35.78	46.00	-10.22	QP		

*:Maximum data x:Over limit !:over margin

Operator:

Radiated Emission Measurement

File :zhidi

Data #19

Date: 20/03/01/

Time: 10/30/03

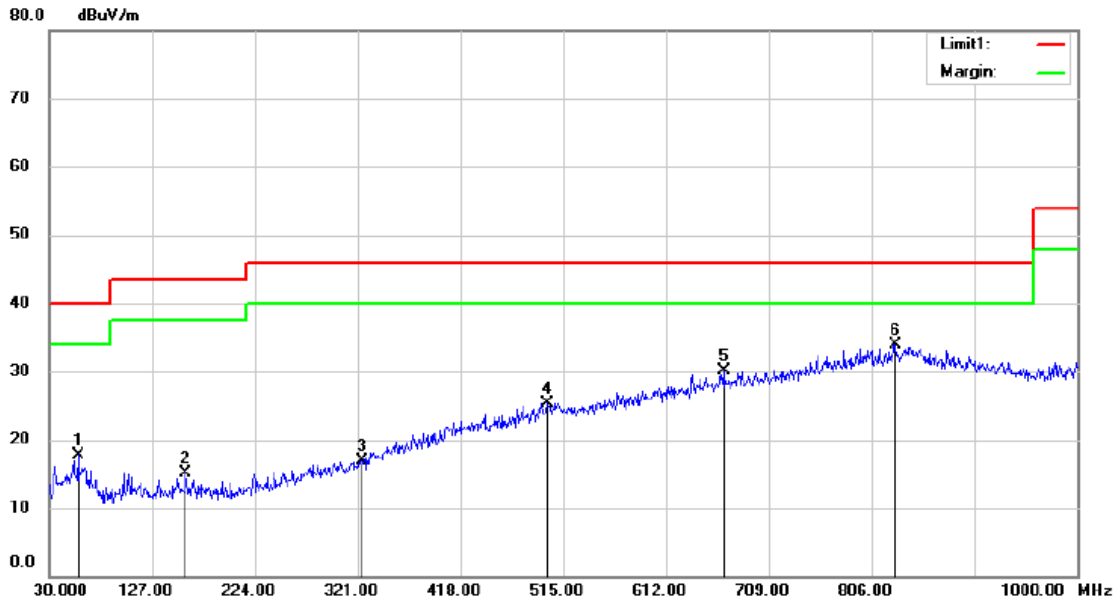

Site 3m Chamber #1

Polarization: **Vertical**

Temperature: 29.5 C

Limit: (RE)FCC PART 15 C

Power: AC 120V/60Hz

Humidity: 48 %

EUT:

M/N: M600A

Mode:BLE 2480MHz

Note: EUT:Lenovo Legion M600 Wireless Gaming Mouse

No.	Mk.	Freq. MHz	Reading Level dBuV	Correct Factor dB	Measure- ment dBuV/m	Limit dBuV/m	Over dB	Antenna Height cm	Table Degree degree	Comment
1		57.1600	29.62	-11.82	17.80	40.00	-22.20	QP		
2		159.0100	28.86	-13.79	15.07	43.50	-28.43	QP		
3		324.8800	26.36	-9.36	17.00	46.00	-29.00	QP		
4		500.4500	28.81	-3.45	25.36	46.00	-20.64	QP		
5		866.3200	29.50	0.56	30.06	46.00	-15.94	QP		
6	*	828.3100	29.47	4.44	33.91	46.00	-12.09	QP		

*:Maximum data x:Over limit !:over margin

Operator:

Radiated Emission Measurement

File :zhidi

Data :#20

Date: 20/03/01/

Time: 10/31/09

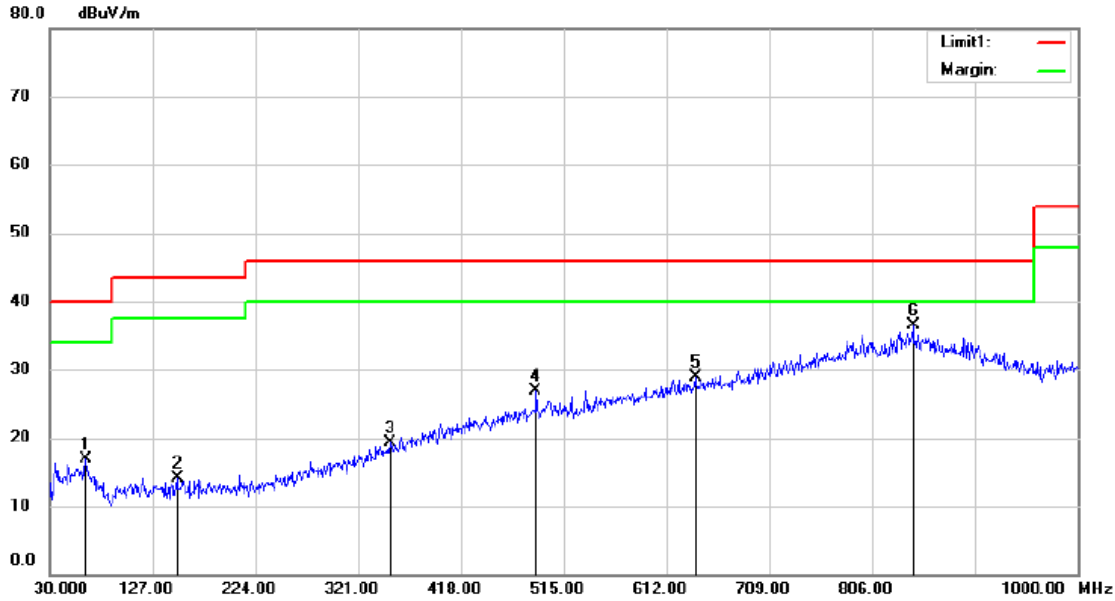

Site: 3m Chamber #1

Polarization: **Horizontal**

Temperature: 29.5 C

Limit: (RE)FCC PART 15 C

Power: AC 120V/60Hz

Humidity: 48 %

EUT:

M/N: M600A

Mode: BLE 2480MHz

Note: EUT:Lenovo Legion M600 Wireless Gaming Mouse

No.	Mk.	Freq.	Reading Level	Correct Factor	Measurement	Limit	Over	Antenna Height	Table Degree	
		MHz	dBuV	dB	dBuV/m	dBuV/m	dB	cm	degree	Comment
1		63.9500	28.71	-11.86	16.85	40.00	-23.15	QP		
2		150.2800	27.71	-13.61	14.10	43.50	-29.40	QP		
3		351.0700	27.37	-8.15	19.22	46.00	-26.78	QP		
4		488.8100	30.96	-4.10	26.86	46.00	-19.14	QP		
5		639.1600	29.02	-0.11	28.91	46.00	-17.09	QP		
6	*	844.8000	31.54	4.93	36.47	46.00	-9.53	QP		

*:Maximum data x:Over limit l:over margin

Operator:

8.6 CONDUCTED EMISSIONS TEST

8.6.1 Applicable Standard

According to FCC Part 15.207(a)

8.6.2 Conformance Limit

Frequency(MHz)	Conducted Emission Limit	
	Quasi-peak	Average
0.15-0.5	66-56	56-46
0.5-5.0	56	46
5.0-30.0	60	50

Note: 1. The lower limit shall apply at the transition frequencies
2. The limit decreases in line with the logarithm of the frequency in the range of 0.15 to 0.50MHz.

8.6.3 Test Configuration

Test according to clause 7.3 conducted emission test setup

8.6.4 Test Procedure

The EUT was placed on a table which is 0.8m above ground plane.
Maximum procedure was performed on the highest emissions to ensure EUT compliance.
Repeat above procedures until all frequency measured were complete.

8.6.5 Test Results

PASS.

Please refer to the following page.

Conducted Emission Measurement

File :zhidi
80.0 dBuV

Data :#10

Date: 20/01/06/

Time: 13/43/01

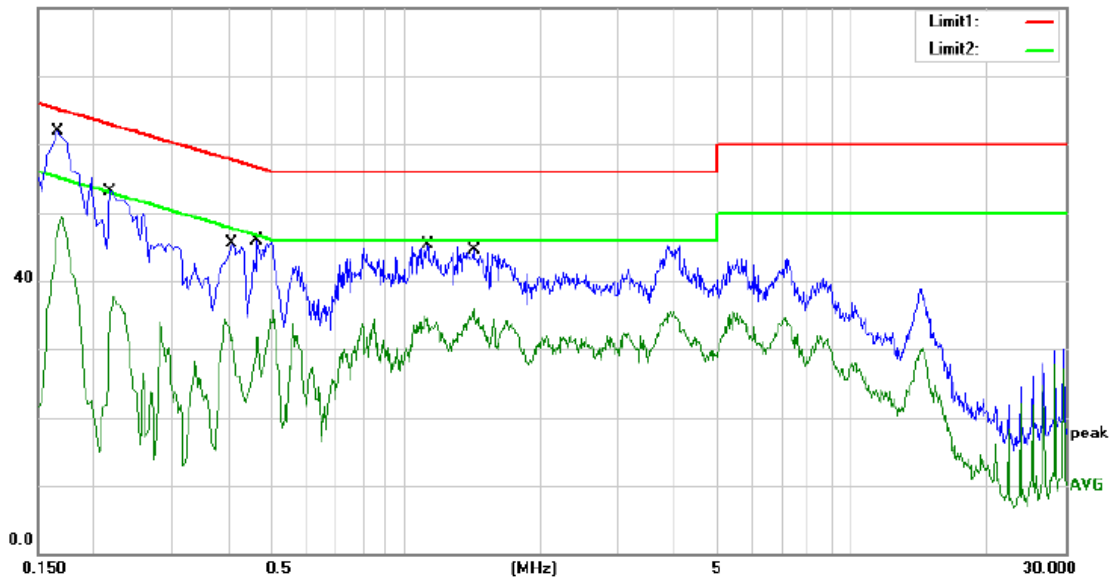

Site: Conduction #2

Phase: **L1**

Temperature: 21

Limit: (CE)FCC PART 15 class B_QP

Power: DC 5V from PC

Humidity: 53 %

EUT:

M/N: M600A

Mode: Charging+ON

Note: Lenovo Legion M600 Wireless Gaming Mouse

No.	Mk.	Freq. MHz	Reading Level dBuV	Correct Factor dB	Measure- ment dBuV	Limit dBuV	Over dB	Detector	Comment
1		0.1660	48.90	9.90	58.80	65.16	-6.36	QP	
2	*	0.1660	39.46	9.90	49.36	55.16	-5.80	AVG	
3		0.2180	43.24	9.90	53.14	62.89	-9.75	QP	
4		0.2180	27.84	9.90	37.74	52.89	-15.15	AVG	
5		0.4100	35.66	9.92	45.58	57.65	-12.07	QP	
6		0.4100	24.30	9.92	34.22	47.65	-13.43	AVG	
7		0.4660	35.90	9.92	45.82	56.58	-10.76	QP	
8		0.4660	25.75	9.92	35.67	46.58	-10.91	AVG	
9		1.1220	35.36	9.93	45.29	56.00	-10.71	QP	
10		1.1220	24.97	9.93	34.90	46.00	-11.10	AVG	
11		1.4220	34.51	9.93	44.44	56.00	-11.56	QP	
12		1.4220	25.94	9.93	35.87	46.00	-10.13	AVG	

*:Maximum data x:Over limit !:over margin Comment: Factor build in receiver. Operator:

Conducted Emission Measurement

File :zhidi

Data :#9

Date: 20/01/06

Time: 13/40/38

80.0 dBuV

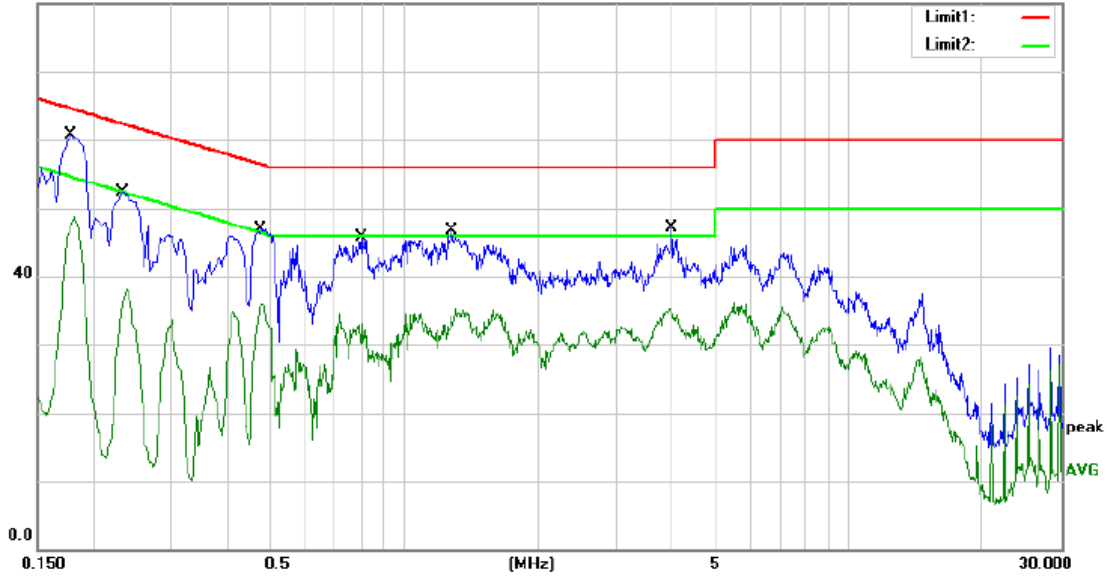

Site: Conduction #2

Phase: **N**

Temperature: 21

Limit: (CE)FCC PART 15 class B_QP

Power: DC 5V from PC

Humidity: 53 %

EUT:

M/N: M600A

Mode: Charging+ON

Note: Lenovo Legion M600 Wireless Gaming Mouse

No.	Mk.	Freq. MHz	Reading Level dBuV	Correct Factor dB	Measure- ment dBuV	Limit dBuV	Over dB	Detector	Comment
1		0.1780	48.60	9.90	58.50	64.58	-6.08	QP	
2	*	0.1780	38.79	9.90	48.69	54.58	-5.89	AVG	
3		0.2340	42.41	9.90	52.31	62.31	-10.00	QP	
4		0.2340	28.25	9.90	38.15	52.31	-14.16	AVG	
5		0.4780	37.03	9.92	46.95	56.37	-9.42	QP	
6		0.4780	26.03	9.92	35.95	46.37	-10.42	AVG	
7		0.8020	35.74	9.92	45.66	56.00	-10.34	QP	
8		0.8020	24.61	9.92	34.53	46.00	-11.47	AVG	
9		1.2860	36.80	9.93	46.73	56.00	-9.27	QP	
10		1.2860	25.44	9.93	35.37	46.00	-10.63	AVG	
11		3.9860	37.22	9.94	47.16	56.00	-8.84	QP	
12		3.9860	25.36	9.94	35.30	46.00	-10.70	AVG	

*:Maximum data x:Over limit !:over margin Comment: Factor build in receiver. Operator:

8.7 ANTENNA APPLICATION

8.7.1 Antenna Requirement

Standard	Requirement
FCC CRF Part 15.203	<p>An intentional radiator shall be designed to ensure that no antenna other than that furnished by the responsible party shall be used with the device. The use of a permanently attached antenna or of an antenna that uses a unique coupling to the intentional radiator shall be considered sufficient to comply with the provisions of this section. The manufacturer may design the unit so that a broken antenna can be replaced by the user, but the use of a standard antenna jack or electrical connector is prohibited. This requirement does not apply to carrier current devices or to devices operated under the provisions of §15.211, §15.213, §15.217, §15.219, or §15.221. Further, this requirement does not apply to intentional radiators that must be professionally installed, such as perimeter protection systems and some field disturbance sensors, or to other intentional radiators which, in accordance with §15.31(d), must be measured at the installation site. However, the installer shall be responsible for ensuring that the proper antenna is employed so that the limits in this part are not exceeded.</p>

For intentional device, according to FCC 47 CFR Section 15.203, an intentional radiator shall be designed to ensure that no antenna other than that furnished by the responsible party shall be used with the device. And according to FCC 47 CFR Section 15.247 (b), if transmitting antennas of directional gain greater than 6dBi are used, the power shall be reduced by the amount in dB that the directional gain of the antenna exceeds 6dBi.

8.7.2 Result

The EUT'S antenna is internal antenna. The antenna's gain is 3.68 dBi, which in accordance to section 15.203, please refer to the internal photos.