



FCC RF Test Report

APPLICANT : LENOVO (BEIJING) LIMITED
EQUIPMENT : Mobile Phone
BRAND NAME : Lenovo
MODEL NAME : Lenovo L19111
FCC ID : A5ML20A11
STANDARD : 47 CFR Part 2, 22(H), 24(E)
CLASSIFICATION : PCS Licensed Transmitter Held to Ear (PCE)

The product was received on Apr. 28, 2020 and completely tested on May 10, 2020. We, Sporton International (Kunshan) Inc., would like to declare that the tested sample has been evaluated in accordance with the procedures given in ANSI C63.26-2015 and shown compliance with the applicable technical standards.

The test results in this report apply exclusively to the tested model / sample. Without written approval of Sporton International (Kunshan) Inc., the test report shall not be reproduced except in full.

Reviewed by: Jason Jia / Supervisor

Approved by: James Huang / Manager



Sporton International (Kunshan) Inc.

**No. 1098, Pengxi North Road, Kunshan Economic Development Zone Jiangsu Province 215300
People's Republic of China**



TABLE OF CONTENTS

REVISION HISTORY..... 3

SUMMARY OF TEST RESULT 4

1 GENERAL DESCRIPTION 5

 1.1 Applicant..... 5

 1.2 Manufacturer 5

 1.3 Product Feature of Equipment Under Test 5

 1.4 Product Specification of Equipment Under Test 6

 1.5 Modification of EUT 6

 1.6 Maximum ERP/EIRP Power, Frequency Tolerance, and Emission Designator 7

 1.7 Testing Location 7

 1.8 Applicable Standards 8

2 TEST CONFIGURATION OF EQUIPMENT UNDER TEST 9

 2.1 Test Mode..... 9

 2.2 Connection Diagram of Test System 10

 2.3 Support Unit used in test configuration 10

 2.4 Measurement Results Explanation Example 10

 2.5 Frequency List of Low/Middle/High Channels..... 11

3 CONDUCTED TEST RESULT..... 12

 3.1 Measuring Instruments..... 12

 3.2 Test Setup 12

 3.3 Test Result of Conducted Test..... 12

 3.4 Conducted Output Power and ERP/EIRP 13

 3.5 Peak-to-Average Ratio 14

 3.6 99% Occupied Bandwidth and 26dB Bandwidth Measurement..... 15

 3.7 Conducted Band Edge 16

 3.8 Conducted Spurious Emission 17

 3.9 Frequency Stability..... 18

4 RADIATED TEST ITEMS 19

 4.1 Measuring Instruments..... 19

 4.2 Test Setup 19

 4.3 Test Result of Radiated Test..... 19

 4.4 Field Strength of Spurious Radiation Measurement 20

5 LIST OF MEASURING EQUIPMENT 21

6 UNCERTAINTY OF EVALUATION 22

APPENDIX A. TEST RESULTS OF CONDUCTED TEST

APPENDIX B. TEST RESULTS OF RADIATED TEST

APPENDIX C. TEST SETUP PHOTOGRAPHS



SUMMARY OF TEST RESULT

Report Section	FCC Rule	Description	Limit	Result	Remark
3.4	§2.1046	Conducted Output Power	Reporting Only	PASS	-
	§22.913(a)(5)	Effective Radiated Power	< 7 Watts	PASS	-
	§24.232(c)	Equivalent Isotropic Radiated Power	< 2 Watts	PASS	-
	§27.50(d)(4)	Equivalent Isotropic Radiated Power	< 1 Watts	PASS	-
3.5	§24.232(d)	Peak-to-Average Ratio	< 13 dB	PASS	-
3.6	§2.1049	Occupied Bandwidth	Reporting Only	PASS	-
3.7	§2.1051 §22.917(a) §24.238(a) §27.53(h)	Band Edge Measurement	< 43+10log10(P[Watts])	PASS	-
3.8	§2.1051 §22.917(a) §24.238(a) §27.53(h)	Conducted Emission	< 43+10log10(P[Watts])	PASS	-
3.9	§2.1055 §22.355	Frequency Stability for Temperature & Voltage	< 2.5 ppm for Part 22H	PASS	-
	§2.1055 §24.235 §27.54		Within Authorized Band		
4.4	§2.1053 §22.917(a) §24.238(a) §27.53(h)	Field Strength of Spurious Radiation	< 43+10log10(P[Watts])	PASS	Under limit 27.96 dB at 9400.000 MHz

Declaration of Conformity:

The test results with all measurement uncertainty excluded are presented in accordance with the regulation limits or requirements declared by manufacturers.

Comments and Explanations:

The declared of product specification for EUT presented in the report are provided by the manufacturer, and the manufacturer takes all the responsibilities for the accuracy of product specification.



1 General Description

1.1 Applicant

LENOVO (BEIJING) LIMITED

201-H2-6, Floor 2, Building 2, No.6 Shangdi West Road, Haidian District, Beijing, China 100085

1.2 Manufacturer

Lenovo PC HK Limited

23/F, Lincoln House, Taikoo Place 979 King's Road, Quarry Bay, Hong Kong P.R.China

1.3 Product Feature of Equipment Under Test

Product Feature	
Equipment	Mobile Phone
Brand Name	Lenovo
Model Name	Lenovo L19111
FCC ID	A5ML20A11
EUT supports Radios application	GSM/WCDMA/LTE WLAN 2.4GHz 802.11b/g/n HT20 Bluetooth BR/EDR/LE FM Receiver and GNSS
IMEI Code	Conducted:N/A Radiation: 359635100000850
HW Version	DVT2-2
SW Version	LENOVO_AK47_V01_20191209
EUT Stage	Identical Prototype

Remark: The above EUT's information was declared by manufacturer. Please refer to the specifications or user's manual for more detailed description.

1.4 Product Specification of Equipment Under Test

Standards-related Product Specification	
Tx Frequency	GSM/GPRS/EDGE: 850: 824.2 MHz ~ 848.8 MHz 1900: 1850.2 MHz ~ 1909.8MHz WCDMA: Band V: 826.4 MHz ~ 846.6 MHz Band II: 1852.4 MHz ~ 1907.6 MHz
Rx Frequency	GSM/GPRS/EDGE: 850: 869.2 MHz ~ 893.8 MHz 1900: 1930.2 MHz ~ 1989.8 MHz WCDMA: Band V: 871.4 MHz ~ 891.6 MHz Band II: 1932.4 MHz ~ 1987.6 MHz
Maximum Output Power to Antenna	GSM/GPRS/EDGE: 850: 32.58 dBm 1900: 29.49 dBm WCDMA: Band V: 23.23 dBm Band II: 23.05 dBm
Antenna Type	PIFA Antenna
Antenna Gain	Cellular Band: -1.80 dBi PCS Band: -0.60 dBi
Type of Modulation	GSM: GMSK GPRS: GMSK EDGE: GMSK / 8PSK WCDMA : BPSK (Uplink) HSDPA/DC-HSDPA : QPSK (Uplink) HSUPA : QPSK (Uplink) HSPA+ : 16QAM DC-HSDPA : 64QAM

1.5 Modification of EUT

No modifications are made to the EUT during all test items.



1.6 Maximum ERP/EIRP Power, Frequency Tolerance, and Emission Designator

FCC Rule	System	Type of Modulation	Maximum ERP/EIRP (W)	Frequency Tolerance (ppm)	Emission Designator
Part 22H	GSM850 GSM	GMSK	0.7295	0.0203 ppm	243KGXW
Part 22H	GSM850 EDGE class 8	8PSK	0.1738	0.0203 ppm	239KG7W
Part 22H	WCDMA Band V RMC 12.2Kbps	BPSK	0.0847	0.0167 ppm	4M15F9W
Part 24E	GSM1900 GSM	GMSK	0.7745	0.0101 ppm	242KGXW
Part 24E	GSM1900 EDGE class 8	8PSK	0.3357	0.0112 ppm	242KG7W
Part 24E	WCDMA Band II RMC 12.2Kbps	BPSK	0.1758	0.0106 ppm	4M15F9W

1.7 Testing Location

Sporton International (Kunshan) Inc. is accredited to ISO/IEC 17025:2017 by American Association for Laboratory Accreditation with Certificate Number 5145.02.

Test Firm	Sporton International (Kunshan) Inc.		
Test Site Location	No. 1098, Pengxi North Road, Kunshan Economic Development Zone Jiangsu Province 215300 People's Republic of China TEL : +86-512-57900158 FAX : +86-512-57900958		
Test Site No.	Sporton Site No.	FCC Designation No.	FCC Test Firm Registration No.
	TH01-KS 03CH04-KS	CN1257	314309



1.8 Applicable Standards

According to the specifications of the manufacturer, the EUT must comply with the requirements of the following standards:

- ♦ 47 CFR Part 2, 22(H), 24(E)
- ♦ ANSI C63.26-2015
- ♦ FCC KDB 971168 D01 Power Meas. License Digital Systems v03r01
- ♦ FCC KDB 412172 D01 Determining ERP and EIRP v01r01

Remark:

1. All test items were verified and recorded according to the standards and without any deviation during the test.
2. This EUT has also been tested and complied with the requirements of FCC Part 15, Subpart B, recorded in a separate test report.



2 Test Configuration of Equipment Under Test

2.1 Test Mode

Antenna port conducted and radiated test items were performed according to KDB 971168 D01 Power Meas. License Digital Systems v03r01 with maximum output power.

Radiated measurements were performed with rotating EUT in different three orthogonal test planes to find the maximum emission.

Radiated emissions were investigated as following frequency range:

1. 30 MHz to 10th harmonic for GSM850 and WCDMA Band V.
2. 30 MHz to 10th harmonic for GSM1900 and WCDMA Band II.

All modes and data rates and positions were investigated.

Test modes are chosen to be reported as the worst case configuration below:

Test Modes		
Band	Radiated TCs	Conducted TCs
GSM 850	<ul style="list-style-type: none"> ■ GSM Link ■ EDGE class 8 Link 	<ul style="list-style-type: none"> ■ GSM Link ■ EDGE class 8 Link
GSM 1900	<ul style="list-style-type: none"> ■ GSM Link ■ EDGE class 8 Link 	<ul style="list-style-type: none"> ■ GSM Link ■ EDGE class 8 Link
WCDMA Band V	<ul style="list-style-type: none"> ■ RMC 12.2Kbps Link 	<ul style="list-style-type: none"> ■ RMC 12.2Kbps Link
WCDMA Band II	<ul style="list-style-type: none"> ■ RMC 12.2Kbps Link 	<ul style="list-style-type: none"> ■ RMC 12.2Kbps Link

2.2 Connection Diagram of Test System

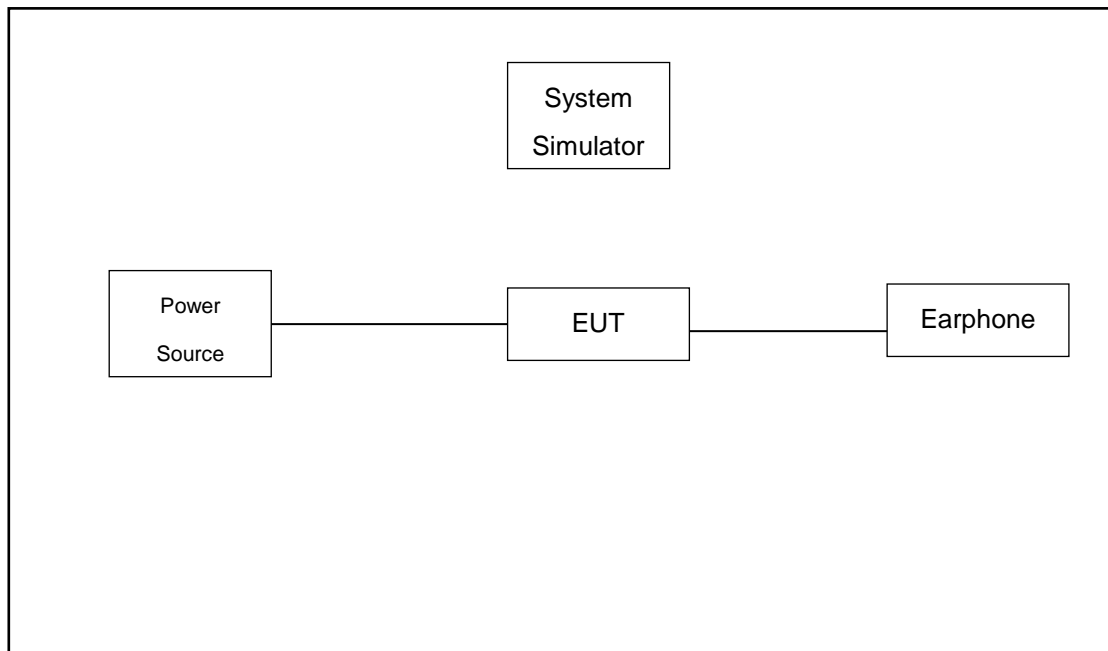

2.3 Support Unit used in test configuration

Item	Equipment	Trade Name	Model No.	FCC ID	Data Cable	Power Cord
1.	System Simulator	Anritsu	MT8820C	N/A	N/A	Unshielded, 1.8 m
2.	DC Power Supply	GW INSTRON	GPS-3030D	N/A	N/A	Unshielded, 1.8 m

2.4 Measurement Results Explanation Example

For all conducted test items:

The offset level is set in the spectrum analyzer to compensate the RF cable loss and attenuator factor between RF conducted output port and spectrum analyzer. With the offset compensation, the spectrum analyzer reading level will be exactly the RF output level.

The spectrum analyzer offset is derived from RF cable loss and attenuator factor.

Offset = RF cable loss + attenuator factor.

The following shows an offset computation example with RF cable loss 2.00 dB and a 10dB attenuator.

Example :

$$\begin{aligned}
 \text{Offset(dB)} &= \text{RF cable loss(dB)} + \text{attenuator factor(dB)} \\
 &= 2.00 + 10 = 12.00 \text{ (dB)}
 \end{aligned}$$



2.5 Frequency List of Low/Middle/High Channels

Frequency List				
Band	Channel/Frequency(MHz)	Lowest	Middle	Highest
GSM850	Channel	128	189	251
	Frequency	824.2	836.4	848.8
WCDMA Band V	Channel	4132	4182	4233
	Frequency	826.4	836.4	846.6
GSM1900	Channel	512	661	810
	Frequency	1850.2	1880.0	1909.8
WCDMA Band II	Channel	9262	9400	9538
	Frequency	1852.4	1880.0	1907.6

3 Conducted Test Result

3.1 Measuring Instruments

See list of measuring instruments of this test report.

3.2 Test Setup

3.2.1 Conducted Output Power

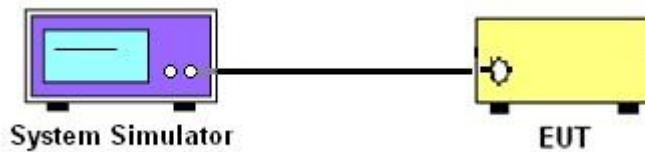

3.2.2 Peak-to-Average Ratio, Occupied Bandwidth, Conducted Band-Edge and Conducted Spurious Emission



3.2.3 Frequency Stability

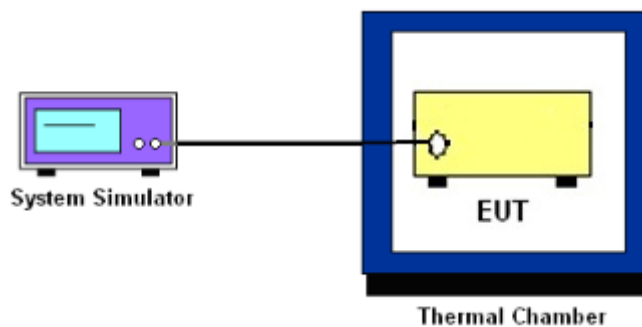

3.3 Test Result of Conducted Test

Please refer to Appendix A.



3.4 Conducted Output Power and ERP/EIRP

3.4.1 Description of the Conducted Output Power and ERP/EIRP

A system simulator was used to establish communication with the EUT. Its parameters were set to enforce EUT transmitting at the maximum power. The measured power in the radio frequency on the transmitter output terminals shall be reported.

The ERP of mobile transmitters must not exceed 7 Watts for GSM850 and WCDMA Band V.

The EIRP of mobile transmitters must not exceed 2 Watts for GSM1900 and WCDMA Band II.

According to KDB 412172 D01 Power Approach,

$EIRP = P_T + G_T - L_C$, $ERP = EIRP - 2.15$, where

P_T = transmitter output power in dBm

G_T = gain of the transmitting antenna in dBi

L_C = signal attenuation in the connecting cable between the transmitter and antenna in dB

3.4.2 Test Procedures

1. The testing follows ANSI C63.26 Section 5.2
2. The transmitter output port was connected to the system simulator.
3. Set EUT at maximum power through the system simulator.
4. Select lowest, middle, and highest channels for each band and different modulation.
5. Measure and record the power level from the system simulator.



3.5 Peak-to-Average Ratio

3.5.1 Description of the PAR Measurement

The peak-to-average ratio (PAR) of the transmission may not exceed 13 dB.

3.5.2 Test Procedures

1. The testing follows ANSI C63.26 Section 5.2.3.4 (CCDF).
2. The EUT was connected to spectrum and system simulator via a power divider.
3. Set the CCDF (Complementary Cumulative Distribution Function) option in spectrum analyzer.
4. The highest RF powers were measured and recorded the maximum PAPR level associated with a probability of 0.1 %.
5. Record the deviation as Peak to Average Ratio.



3.6 99% Occupied Bandwidth and 26dB Bandwidth Measurement

3.6.1 Description of 99% Occupied Bandwidth and 26dB Bandwidth Measurement

The occupied bandwidth is the width of a frequency band such that, below the lower and above the upper frequency limits, the mean powers emitted are each equal to a specified percentage 0.5% of the total mean transmitted power.

The 26 dB emission bandwidth is defined as the frequency range between two points, one above and one below the carrier frequency, at which the spectral density of the emission is attenuated 26 dB below the maximum in-band spectral density of the modulated signal. Spectral density (power per unit bandwidth) is to be measured with a detector of resolution bandwidth equal to approximately 1.0% of the emission bandwidth.

3.6.2 Test Procedures

1. The testing follows ANSI C63.26 Section 5.4
2. The EUT was connected to spectrum analyzer and system simulator via a power divider.
3. The spectrum analyzer center frequency is set to the nominal EUT channel center frequency. The span range for the spectrum analyzer shall be between two and five times the anticipated OBW.
4. The nominal resolution bandwidth (RBW) shall be in the range of 1 to 5 % of the anticipated OBW, and the VBW shall be at least 3 times the RBW.
5. Set the detection mode to peak, and the trace mode to max hold.
6. Determine the reference value: Set the EUT to transmit a modulated signal. Allow the trace to stabilize. Set the spectrum analyzer marker to the highest level of the displayed trace.
(this is the reference value)
7. Determine the “-26 dB down amplitude” as equal to (Reference Value – X).
8. Place two markers, one at the lowest and the other at the highest frequency of the envelope of the spectral display such that each marker is at or slightly below the “-X dB down amplitude” determined in step 6. If a marker is below this “-X dB down amplitude” value it shall be placed as close as possible to this value. The OBW is the positive frequency difference between the two markers.
9. Use the 99 % power bandwidth function of the spectrum analyzer and report the measured bandwidth.



3.7 Conducted Band Edge

3.7.1 Description of Conducted Band Edge Measurement

The power of any emission outside of the authorized operating frequency ranges must be lower than the transmitter power (P) by a factor of at least $43 + 10 \log (P)$ dB.

3.7.2 Test Procedures

1. The testing follows ANSI C63.26 section 5.7
2. The EUT was connected to the spectrum analyzer and system simulator via a power divider.
3. The RF output of EUT was connected to the spectrum analyzer by an RF cable and attenuator. The path loss was compensated to the results for each measurement.
4. The band edges of low and high channels for the highest RF powers were measured.
5. The RF fundamental frequency should be excluded against the limit line in the operating frequency band.
6. The limit line is derived from $43 + 10\log(P)$ dB below the transmitter power P(Watts)



3.8 Conducted Spurious Emission

3.8.1 Description of Conducted Spurious Emission Measurement

The power of any emission outside of the authorized operating frequency ranges must be lower than the transmitter power (P) by a factor of at least $43 + 10 \log (P)$ dB.

It is measured by means of a calibrated spectrum analyzer and scanned from 30 MHz up to a frequency including its 10th harmonic.

3.8.2 Test Procedures

1. The testing follows ANSI C63.26 section 5.7
2. The EUT was connected to the spectrum analyzer and system simulator via a power divider.
3. The RF output of EUT was connected to the spectrum analyzer by an RF cable and attenuator. The path loss was compensated to the results for each measurement.
4. The middle channel for the highest RF power within the transmitting frequency was measured.
5. The conducted spurious emission for the whole frequency range was taken.
6. The RF fundamental frequency should be excluded against the limit line in the operating frequency band.
7. The limit line is derived from $43 + 10\log(P)$ dB below the transmitter power P(Watts)



3.9 Frequency Stability

3.9.1 Description of Frequency Stability Measurement

The frequency stability shall be measured by variation of ambient temperature and variation of primary supply voltage to ensure that the fundamental emission stays within the authorized frequency block. The frequency stability of the transmitter shall be maintained within $\pm 0.00025\%$ ($\pm 2.5\text{ppm}$) of the center frequency.

3.9.2 Test Procedures for Temperature Variation

1. The testing follows ANSI C63.26 section 5.6.4
2. The EUT was set up in the thermal chamber and connected with the system simulator.
3. With power OFF, the temperature was decreased to -30°C and the EUT was stabilized before testing. Power was applied and the maximum change in frequency was recorded within one minute.
4. With power OFF, the temperature was raised in 10°C step up to 50°C . The EUT was stabilized at each step for at least half an hour. Power was applied and the maximum frequency change was recorded within one minute.

3.9.3 Test Procedures for Voltage Variation

1. The testing follows ANSI C63.26 section 5.6.5
2. The EUT was placed in a temperature chamber at $20\pm 5^{\circ}\text{C}$ and connected with the system simulator.
3. The power supply voltage to the EUT was varied from 85% to 115% of the nominal value for other than hand carried battery equipment.
4. For hand carried, battery powered equipment, reduce the primary ac or dc supply voltage to the battery operating end point, which shall be specified by the manufacturer.
5. The variation in frequency was measured for the worst case.

4 Radiated Test Items

4.1 Measuring Instruments

See list of measuring instruments of this test report.

4.2 Test Setup

4.2.1 For radiated test from 30MHz to 1GHz

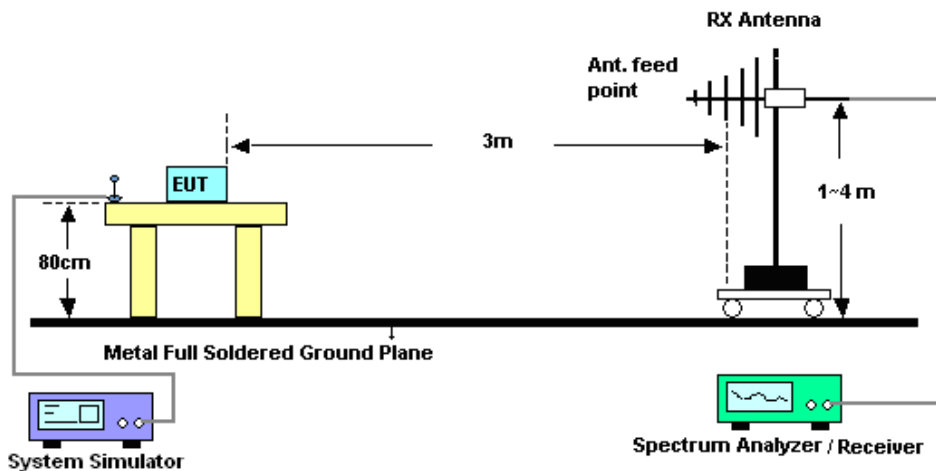

4.2.2 For radiated test above 1GHz

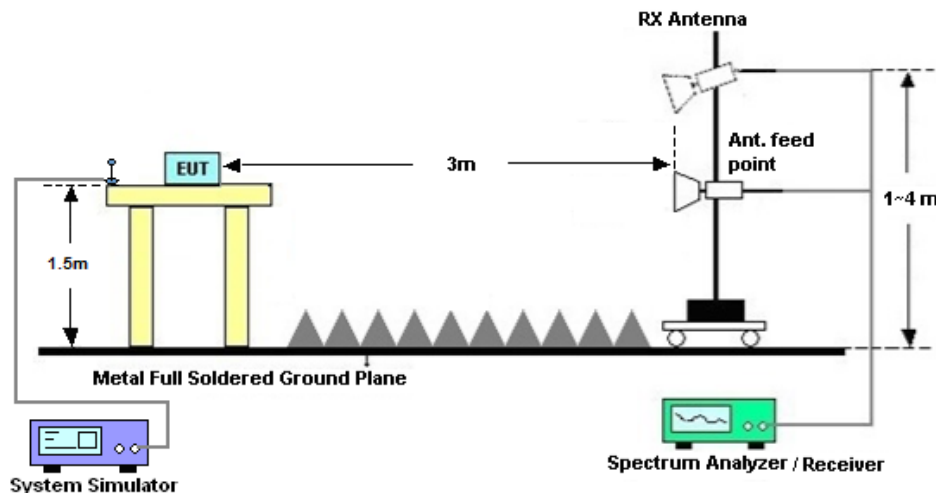

4.3 Test Result of Radiated Test

Please refer to Appendix B.



4.4 Field Strength of Spurious Radiation Measurement

4.4.1 Description of Field Strength of Spurious Radiated Measurement

The power of any emission outside of the authorized operating frequency ranges must be attenuated below the transmitter power (P) by a factor of at least $43 + 10 \log (P)$ dB. The spectrum is scanned from 30 MHz up to a frequency including its 10th harmonic.

4.4.2 Test Procedures

1. The testing follows ANSI C63.26 Section 5.5
2. The EUT was placed on a rotatable wooden table 0.8 meters for frequency below 1GHz and 1.5 meter for frequency above 1GHz above the ground.
3. The EUT was set 3 meters from the receiving antenna, which was mounted on the antenna tower.
4. The table was rotated 360 degrees to determine the position of the highest spurious emission.
5. The height of the receiving antenna is varied between one meter and four meters to search for the maximum spurious emission for both horizontal and vertical polarizations.
6. Make the measurement with the spectrum analyzer's RBW = 1MHz, VBW = 3MHz, taking record of maximum spurious emission.
7. A horn antenna was substituted in place of the EUT and was driven by a signal generator.
8. Tune the output power of signal generator to the same emission level with EUT maximum spurious emission.
9. Taking the record of output power at antenna port.
10. Repeat step 7 to step 8 for another polarization.
11. $EIRP (dBm) = S.G. Power - Tx Cable Loss + Tx Antenna Gain$
12. $ERP (dBm) = EIRP - 2.15$
13. The RF fundamental frequency should be excluded against the limit line in the operating frequency band.
14. The limit line is derived from $43 + 10\log(P)$ dB below the transmitter power P(Watts)



5 List of Measuring Equipment

Instrument	Manufacturer	Model No.	Serial No.	Characteristics	Calibration Date	Test Date	Due Date	Remark
Spectrum Analyzer	R&S	FSV40	101040	10Hz~40GHz	Nov. 02, 2019	May 07, 2020~ May 10, 2020	Nov. 01, 2020	Conducted (TH01-KS)
Thermal Chamber	Ten Billion	TTC-B3S	TBN-960502	-40~+150°C	Nov. 18, 2019	May 07, 2020~ May 10, 2020	Nov. 17, 2020	Conducted (TH01-KS)
EXA Spectrum Analyzer	Keysight	N9010A	MY55150244	10Hz-44G,MAX 30dB	Apr. 15, 2020	May 07, 2020	Apr. 14, 2021	Radiation (03CH04-KS)
Bilog Antenna	TeseQ	CBL6111D	49922	30MHz-1GHz	May 30, 2019	May 07, 2020	May 29, 2020	Radiation (03CH04-KS)
Horn Antenna	Schwarzbeck	BBHA9120D	1356	1GHz~18GHz	Apr. 20, 2020	May 07, 2020	Apr. 19, 2021	Radiation (03CH04-KS)
SHF-EHF Horn	Com-power	AH-840	101115	18GHz~40GHz	Nov. 10, 2019	May 07, 2020	Nov. 09, 2020	Radiation (03CH04-KS)
Amplifier	SONOMA	310N	187289	9KHz-1GHz	Aug. 06, 2019	May 07, 2020	Aug. 05, 2020	Radiation (03CH04-KS)
Amplifier	MITEQ	EM18G40G GA	060728	18~40GHz	Jan. 08, 2020	May 07, 2020	Jan. 07, 2021	Radiation (03CH04-KS)
high gain Amplifier	MITEQ	AMF-7D-00 101800-30-1 0P	2025788	1Ghz-18Ghz	Aug. 16, 2019	May 07, 2020	Aug. 15, 2020	Radiation (03CH04-KS)
Amplifier	Keysight	83017A	MY57280106	500MHz~26.5GHz	Oct.15, 2019	May 07, 2020	Oct.14, 2020	Radiation (03CH04-KS)
AC Power Source	Chroma	61601	F104090004	N/A	NCR	May 07, 2020	NCR	Radiation (03CH04-KS)
Turn Table	ChamPro	EM 1000-T	060762-T	0~360 degree	NCR	May 07, 2020	NCR	Radiation (03CH04-KS)
Antenna Mast	ChamPro	EM 1000-A	060762-A	1 m~4 m	NCR	May 07, 2020	NCR	Radiation (03CH04-KS)

NCR: No Calibration Required



6 Uncertainty of Evaluation

The measurement uncertainties shown below were calculated in accordance with the requirements of ANSI 63.26-2015. All the measurement uncertainty value were shown with a coverage K=2 to indicate 95% level of confidence. The measurement data show herein meets or exceeds the CISPR measurement uncertainty values specified in CISPR 16-4-2 and can be compared directly to specified limit to determine compliance.

Uncertainty of Radiated Emission Measurement (30 MHz ~ 1000 MHz)

Measuring Uncertainty for a Level of Confidence of 95% (U = 2Uc(y))	3.3dB
---	-------

Uncertainty of Radiated Emission Measurement (1 GHz ~ 18 GHz)

Measuring Uncertainty for a Level of Confidence of 95% (U = 2Uc(y))	2.8dB
---	-------

Uncertainty of Radiated Emission Measurement (18 GHz ~ 40 GHz)

Measuring Uncertainty for a Level of Confidence of 95% (U = 2Uc(y))	2.8dB
---	-------



Appendix A. Test Results of Conducted Test

Conducted Output Power(Average power)

Conducted Power (*Unit: dBm)						
Band	GSM850			GSM1900		
Channel	128	189	251	512	661	810
Frequency	824.2	836.4	848.8	1850.2	1880.0	1909.8
GSM	32.51	32.46	32.58	29.27	29.45	29.49
GPRS class 8	32.50	32.45	32.57	29.26	29.43	29.47
GPRS class 10	30.42	30.32	30.33	27.51	27.21	27.05
GPRS class 11	28.57	28.49	28.45	26.03	25.71	25.62
GPRS class 12	26.42	26.36	26.34	24.10	23.75	23.61
EGPRS class 8	26.00	26.35	26.06	25.66	25.86	25.53
EGPRS class 10	24.76	25.17	24.76	24.02	24.49	24.27
EGPRS class 11	22.10	22.56	22.14	21.14	21.31	21.31
EGPRS class 12	19.45	19.74	19.47	18.37	18.75	18.34



Conducted Power (*Unit: dBm)						
Band	WCDMA Band V			WCDMA Band II		
Channel	4132	4182	4233	9262	9400	9538
Frequency	826.4	836.4	846.6	1852.4	1880	1907.6
AMR 12.2K	22.94	23.21	22.99	23.03	23.00	22.95
RMC 12.2K	22.95	23.23	23.01	23.04	23.05	23.00
HSDPA Subtest-1	22.46	22.39	22.30	22.32	22.16	21.96
HSDPA Subtest-2	22.19	22.26	22.03	22.42	22.18	22.02
HSDPA Subtest-3	21.90	21.93	21.74	22.34	22.32	22.17
HSDPA Subtest-4	21.79	21.87	21.63	22.43	22.43	22.32
DC-HSDPA Subtest-1	22.35	22.29	22.20	22.31	22.15	21.95
DC-HSDPA Subtest-2	22.29	22.18	22.16	22.40	22.17	22.01
DC-HSDPA Subtest-3	21.98	21.76	21.77	22.30	22.30	22.15
DC-HSDPA Subtest-4	21.92	21.76	21.79	22.23	22.41	22.31
HSUPA Subtest-1	22.52	22.55	22.59	22.56	22.55	22.54
HSUPA Subtest-2	20.55	20.65	20.51	20.53	20.13	20.19
HSUPA Subtest-3	21.02	21.05	20.97	21.13	21.33	21.43
HSUPA Subtest-4	20.75	20.71	20.60	20.44	20.45	20.41
HSUPA Subtest-5	22.40	22.50	22.40	22.20	22.20	22.10
HSPA+ (16QAM) Subtest-1	22.93	22.91	22.92	21.56	21.32	21.72



ERP/EIRP

GSM850 (G_T - L_C= -1.80 dB)			
Channel	128	189	251
	(Low)	(Mid)	(High)
Frequency	824.2	836.4	848.8
(MHz)			
Conducted Power (dBm)	32.51	32.46	32.58
Conducted Power (Watts)	1.7824	1.7620	1.8113
ERP(dBm)	28.56	28.51	28.63
ERP(Watts)	0.7178	0.7096	0.7295

EDGE850 (G_T - L_C= -1.80 dB)			
Channel	128	189	251
	(Low)	(Mid)	(High)
Frequency	824.2	836.4	848.8
(MHz)			
Conducted Power (dBm)	26.00	26.35	26.06
Conducted Power (Watts)	0.3981	0.4315	0.4036
ERP(dBm)	22.05	22.40	22.11
ERP(Watts)	0.1603	0.1738	0.1626



GSM1900 (G _T - L _C = -0.60 dB)			
Channel	512	661	810
	(Low)	(Mid)	(High)
Frequency	1850.2	1880	1909.8
(MHz)			
Conducted Power (dBm)	29.27	29.45	29.49
Conducted Power (Watts)	0.8453	0.8810	0.8892
EIRP(dBm)	28.67	28.85	28.89
EIRP(Watts)	0.7362	0.7674	0.7745

EDGE1900 (G _T - L _C = -0.60 dB)			
Channel	512	661	810
	(Low)	(Mid)	(High)
Frequency	1850.2	1880	1909.8
(MHz)			
Conducted Power (dBm)	25.66	25.86	25.53
Conducted Power (Watts)	0.3681	0.3855	0.3573
EIRP(dBm)	25.06	25.26	24.93
EIRP(Watts)	0.3206	0.3357	0.3112



WCDMA Band V ($G_T - L_C = -1.80$ dB)			
Channel	4132	4182	4233
	(Low)	(Mid)	(High)
Frequency (MHz)	826.4	836.4	846.6
Conducted Power (dBm)	22.95	23.23	23.01
Conducted Power (Watts)	0.1972	0.2104	0.2000
ERP(dBm)	19.00	19.28	19.06
ERP(Watts)	0.0794	0.0847	0.0805

WCDMA Band II ($G_T - L_C = -0.60$ dB)			
Channel	9262	9400	9538
	(Low)	(Mid)	(High)
Frequency (MHz)	1852.4	1880	1907.6
Conducted Power (dBm)	23.04	23.05	23.00
Conducted Power (Watts)	0.2014	0.2018	0.1995
EIRP(dBm)	22.44	22.45	22.40
EIRP(Watts)	0.1754	0.1758	0.1738



A1. GSM

Peak-to-Average Ratio

Mode	GSM850		Limit: 13dB
Mod.	GSM	EDGE class 8	Result
Lowest CH	0.12	3.13	PASS
Middle CH	0.32	3.28	
Highest CH	0.17	3.19	

Mode	GSM1900		Limit: 13dB
Mod.	GSM	EDGE class 8	Result
Lowest CH	0.17	3.13	PASS
Middle CH	0.12	3.13	
Highest CH	0.14	3.04	

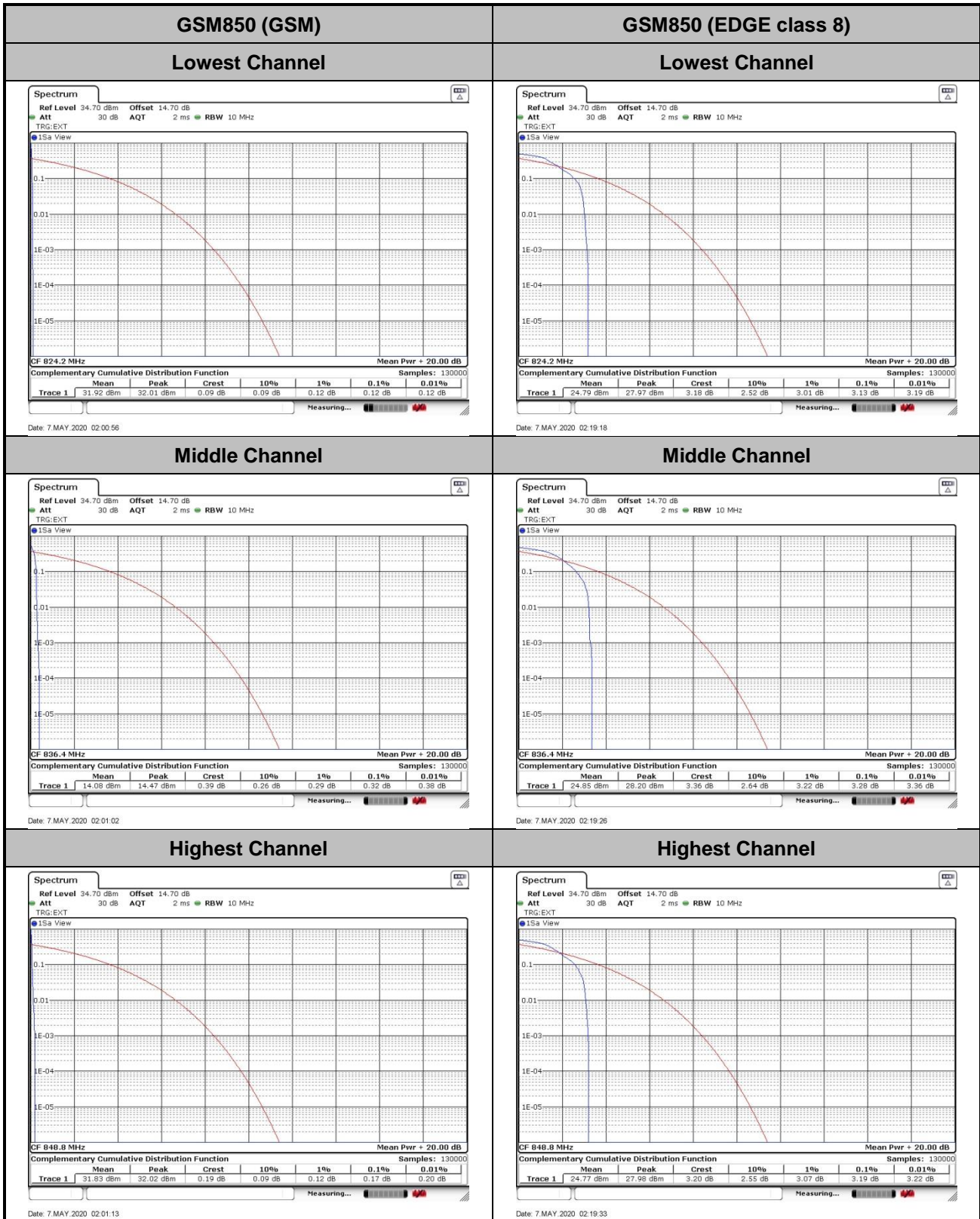

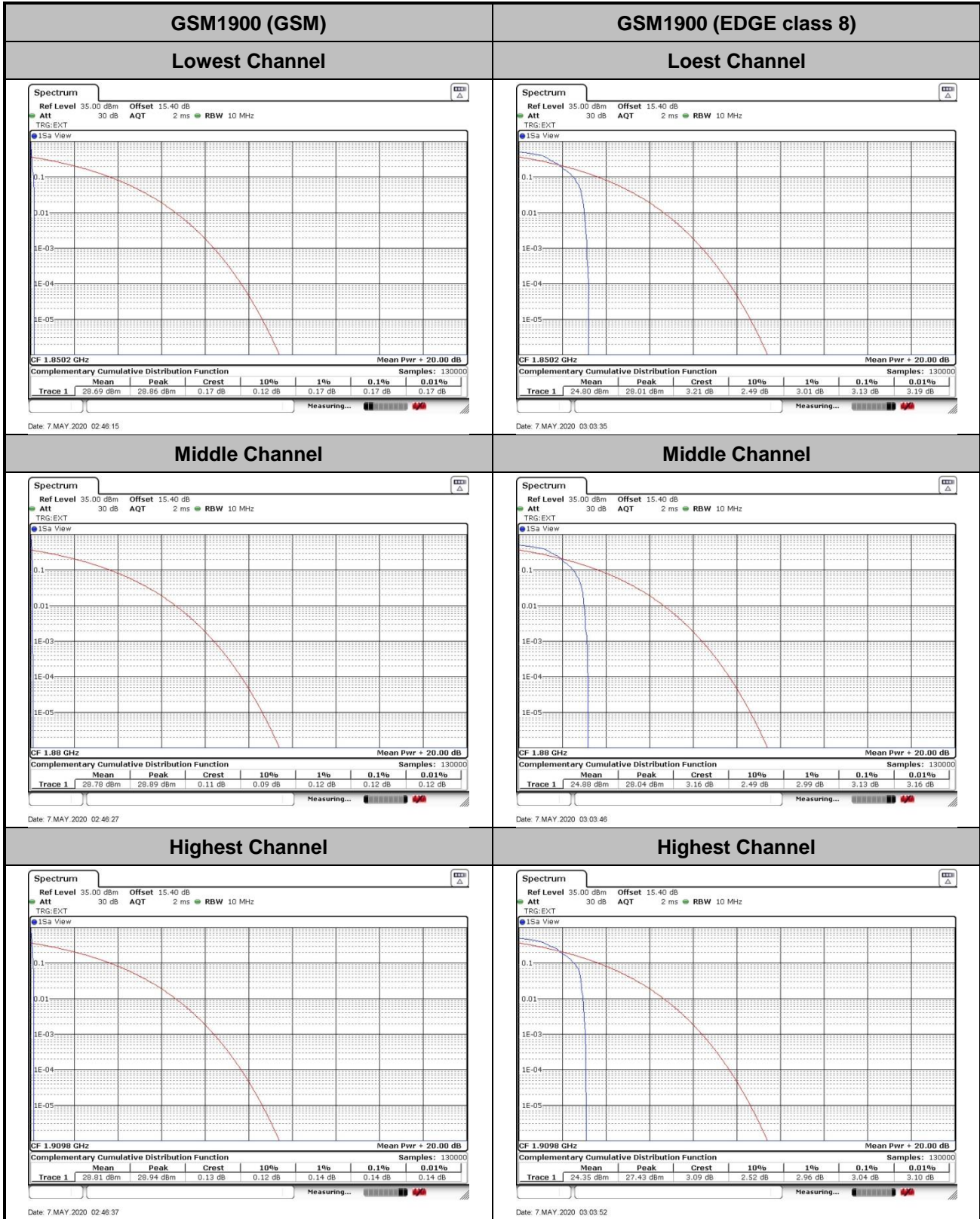



26dB Bandwidth

Mode	GSM850	
Mod.	GSM	EDGE class 8
Lowest CH	0.314	0.314
Middle CH	0.315	0.314
Highest CH	0.314	0.314

Mode	GSM1900	
Mod.	GSM	EDGE class 8
Lowest CH	0.313	0.306
Middle CH	0.315	0.317
Highest CH	0.309	0.313



GSM850 (GSM)

Lowest Channel

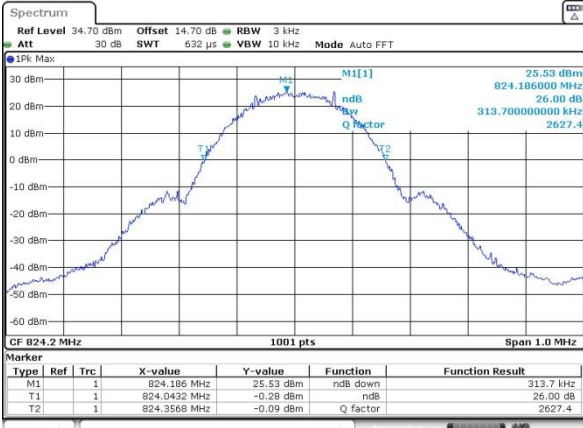

Date: 7 MAY 2020 01:42:40

GSM850 (EDGE class 8)

Lowest Channel

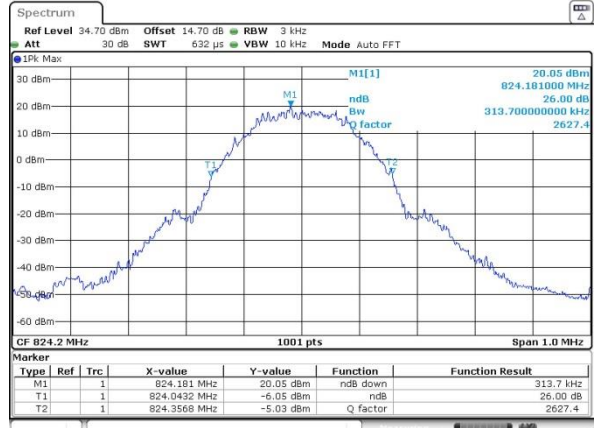

Date: 7 MAY 2020 02:07:24

Middle Channel

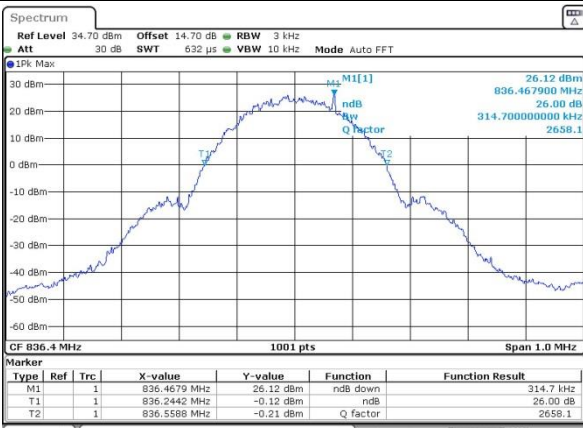

Date: 7 MAY 2020 01:43:01

Middle Channel

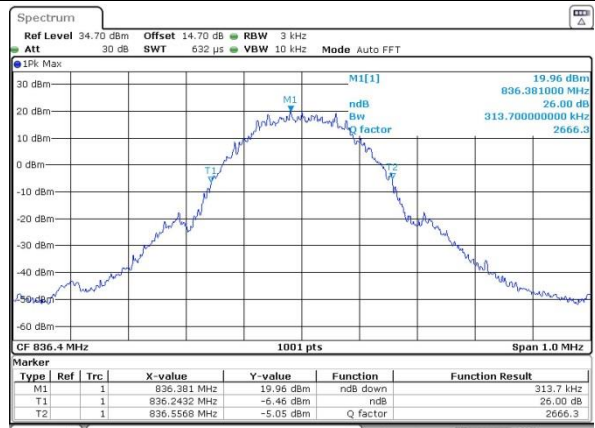

Date: 7 MAY 2020 02:07:46

Highest Channel

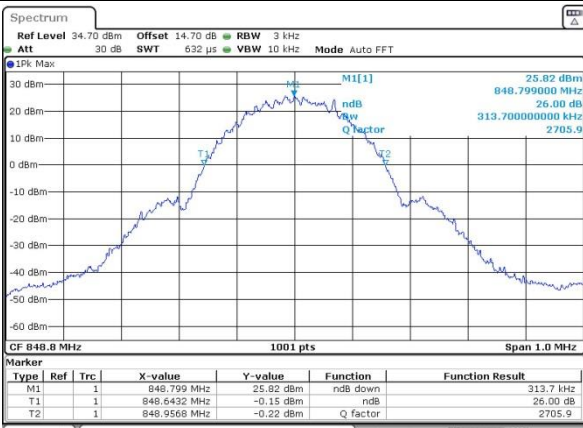

Date: 7 MAY 2020 01:43:22

Highest Channel

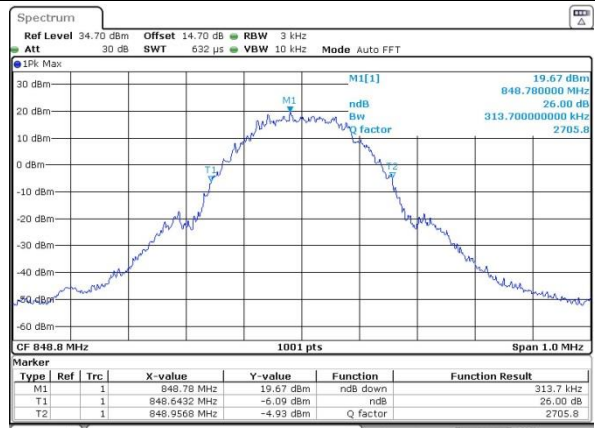

Date: 7 MAY 2020 02:08:11



GSM1900 (GSM)

Lowest Channel

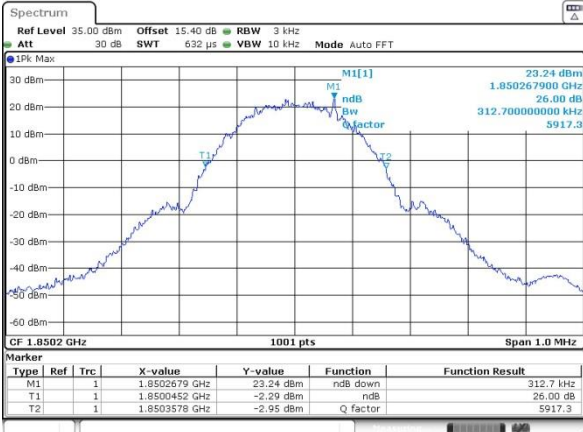

Date: 7 MAY 2020 02:37:10

GSM1900 (EDGE class 8)

Lowest Channel

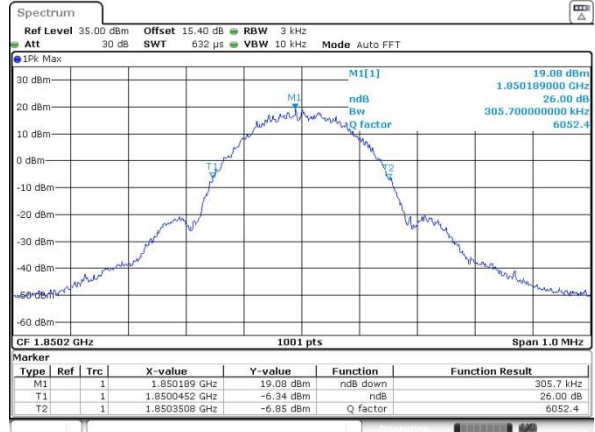

Date: 7 MAY 2020 02:48:39

Middle Channel

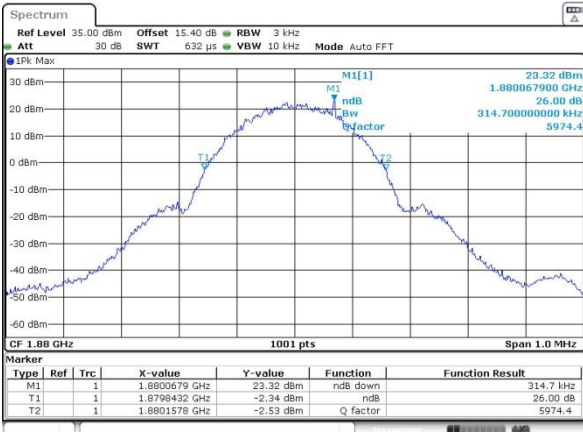

Date: 7 MAY 2020 02:37:32

Middle Channel

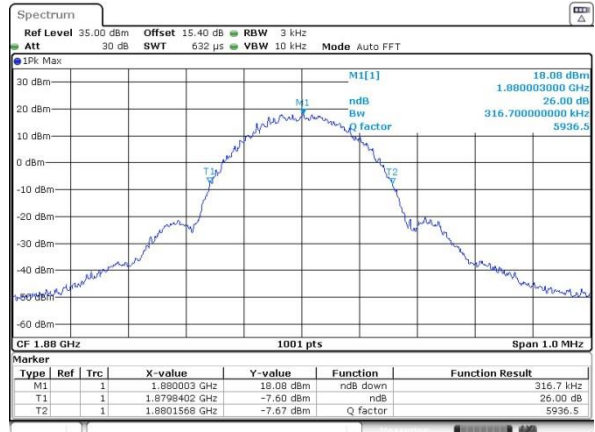

Date: 7 MAY 2020 02:49:06

Highest Channel

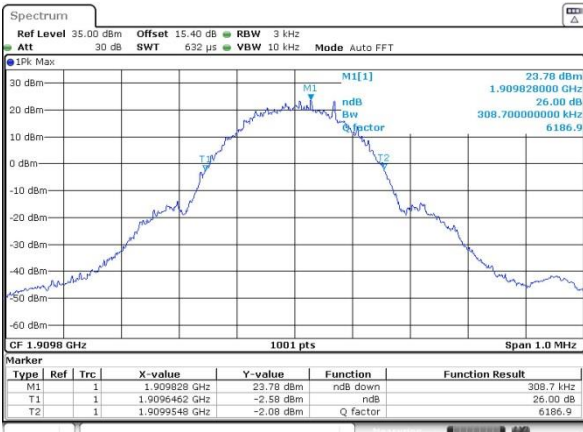

Date: 7 MAY 2020 02:37:55

Highest Channel

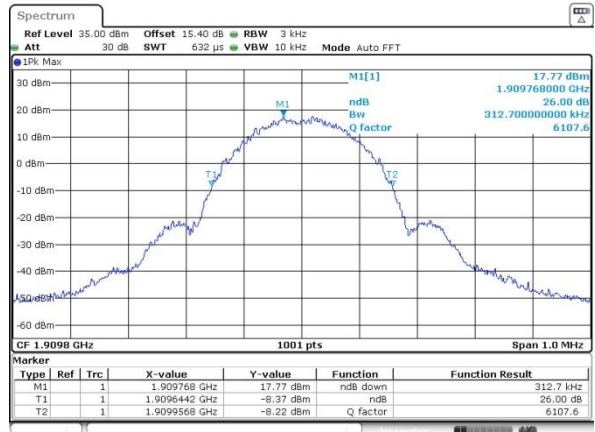

Date: 7 MAY 2020 02:49:27



Occupied Bandwidth

Mode	GSM850	
Mod.	GSM	EDGE class 8
Lowest CH	0.241	0.234
Middle CH	0.243	0.239
Highest CH	0.242	0.239

Mode	GSM1900	
Mod.	GSM	EDGE class 8
Lowest CH	0.242	0.242
Middle CH	0.241	0.242
Highest CH	0.242	0.241



GSM850 (GSM)

Lowest Channel

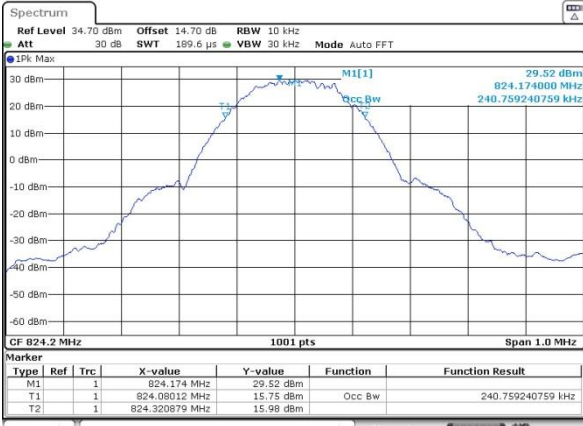

Date: 7 MAY 2020 01:45:30

GSM850 (EDGE class 8)

Lowest Channel

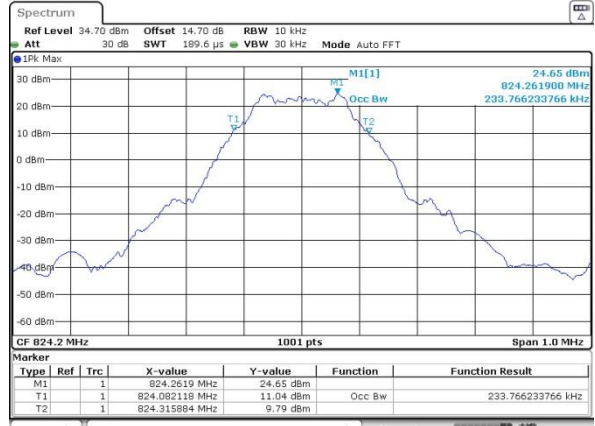

Date: 7 MAY 2020 02:10:11

Middle Channel

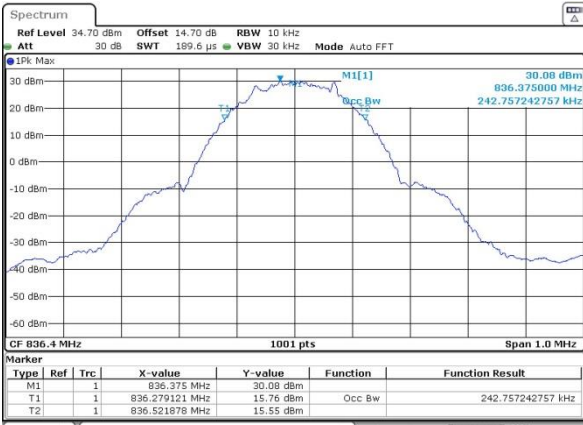

Date: 7 MAY 2020 01:45:49

Middle Channel

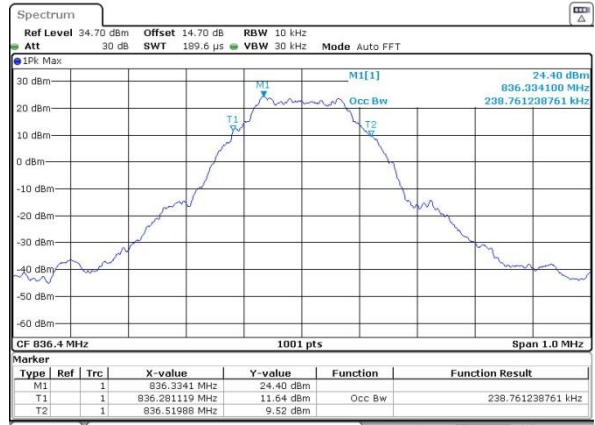

Date: 7 MAY 2020 02:10:36

Highest Channel

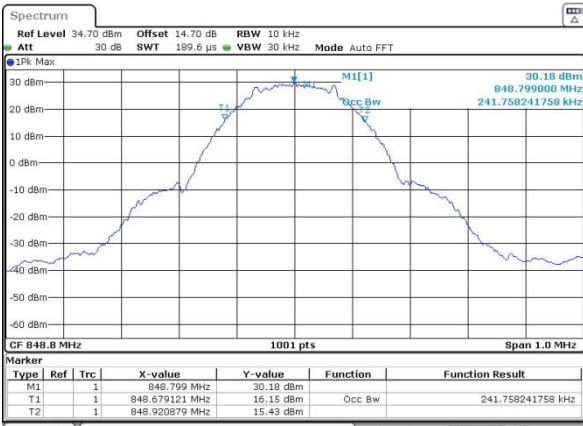

Date: 7 MAY 2020 01:46:11

Highest Channel

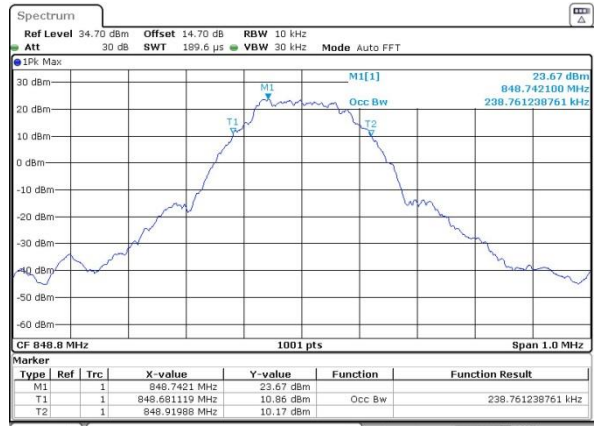

Date: 7 MAY 2020 02:10:58



GSM1900 (GSM)

Lowest Channel

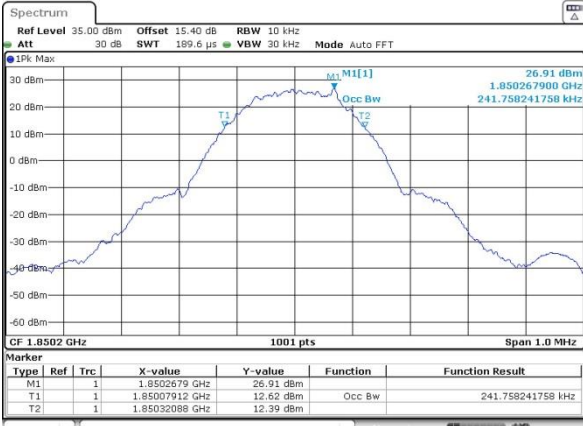

Date: 7 MAY 2020 02:39:46

GSM1900 (EDGE class 8)

Lowest Channel

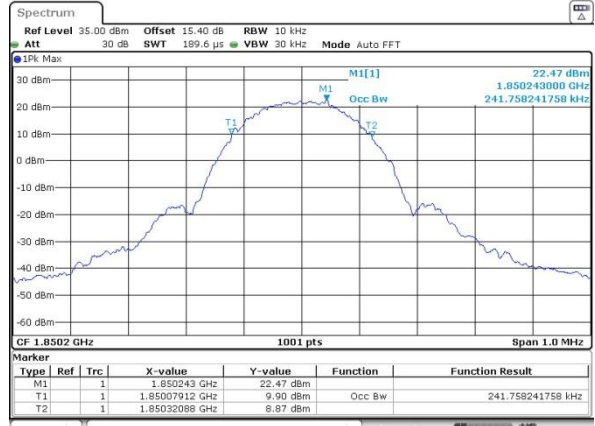

Date: 7 MAY 2020 02:51:22

Middle Channel

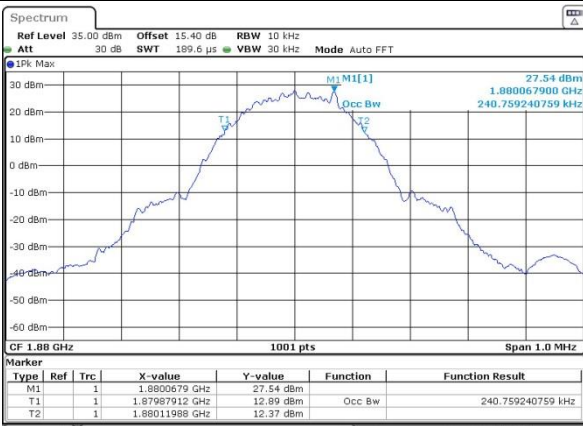

Date: 7 MAY 2020 02:40:08

Middle Channel

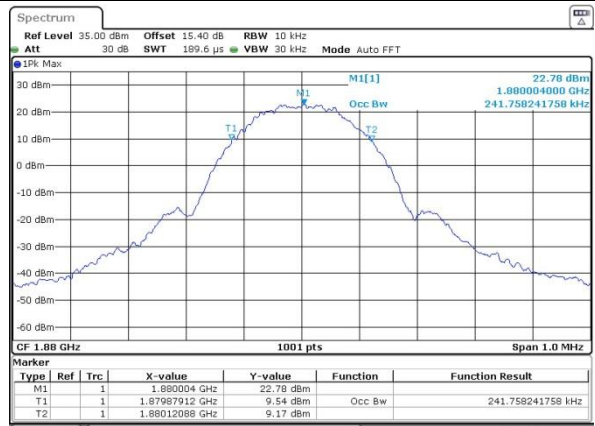

Date: 7 MAY 2020 02:51:44

Highest Channel

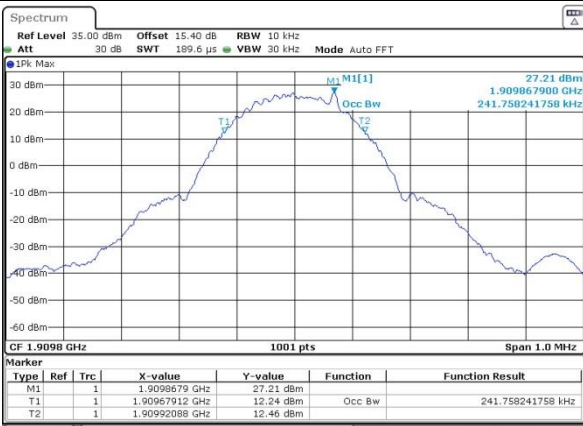

Date: 7 MAY 2020 02:40:28

Highest Channel

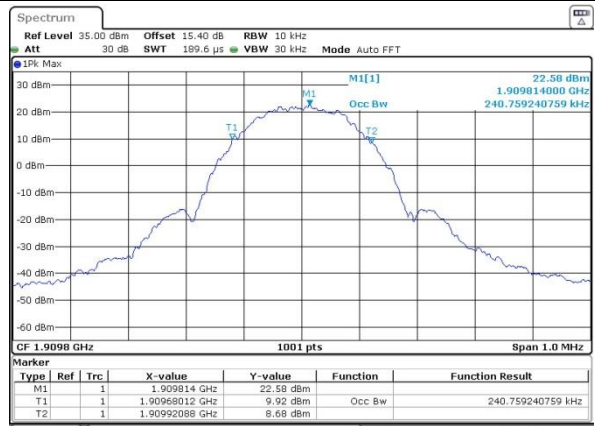

Date: 7 MAY 2020 02:52:08



Conducted Band Edge



GSM850 (GSM)

Lowest Band Edge

Highest Band Edge

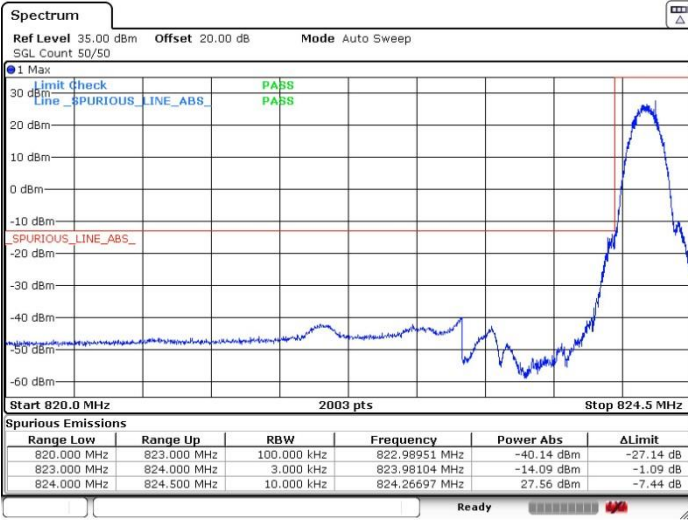

Date: 7 MAY 2020 01:59:03

Date: 7 MAY 2020 01:57:15

GSM850 (EDGE class 8)

Lowest Band Edge

Highest Band Edge

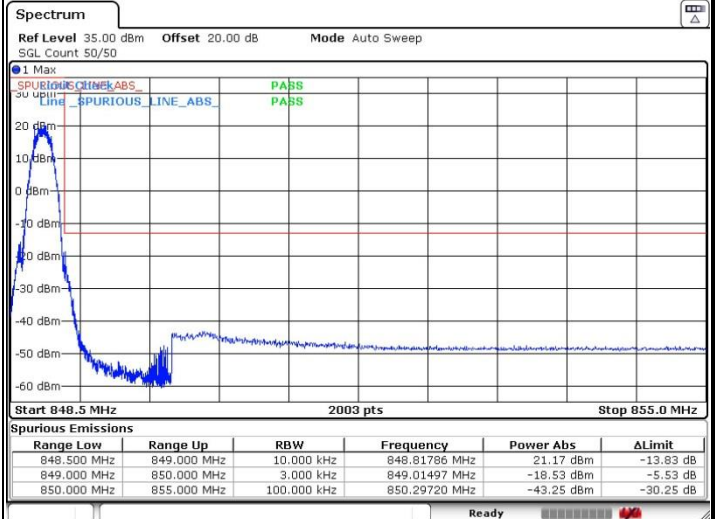
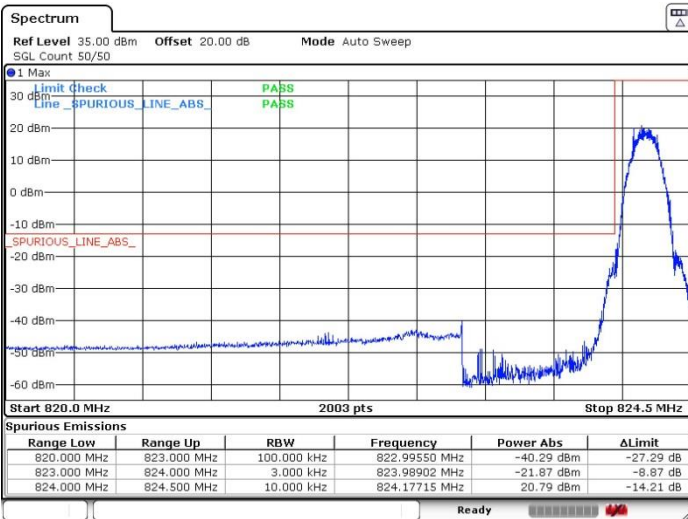

Date: 7 MAY 2020 02:13:07

Date: 7 MAY 2020 02:15:23



GSM1900 (GSM)

Lowest Band Edge

Highest Band Edge



Date: 7.MAY.2020 02:42:17

Date: 7.MAY.2020 02:44:06

GSM1900 (EDGE class 8)

Lowest Band Edge

Highest Band Edge

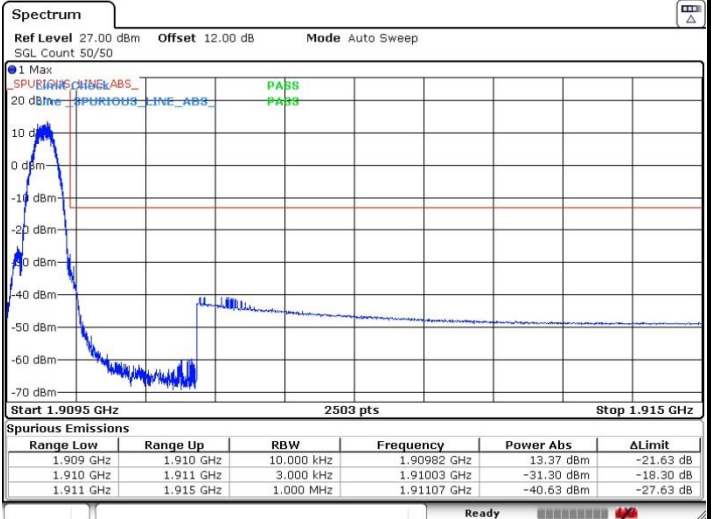
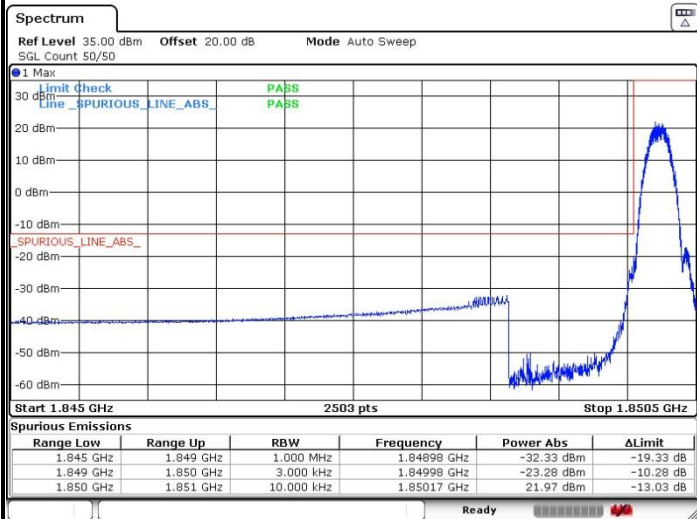

Date: 7.MAY.2020 02:54:51

Date: 7.MAY.2020 02:56:56



Conducted Spurious Emission



GSM850 (GSM)

Lowest Channel

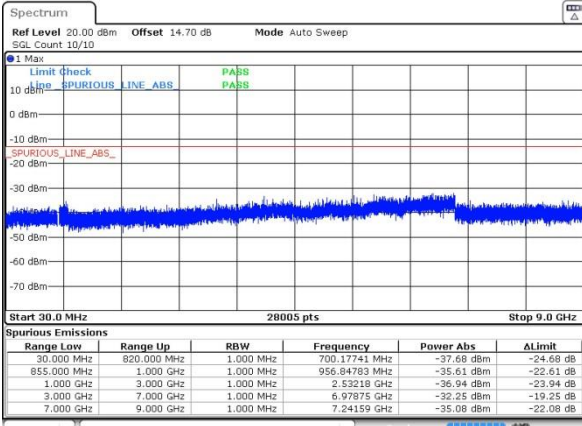

Date: 7.MAY.2020 01:59:20

GSM850 (EDGE class 8)

Lowest Channel

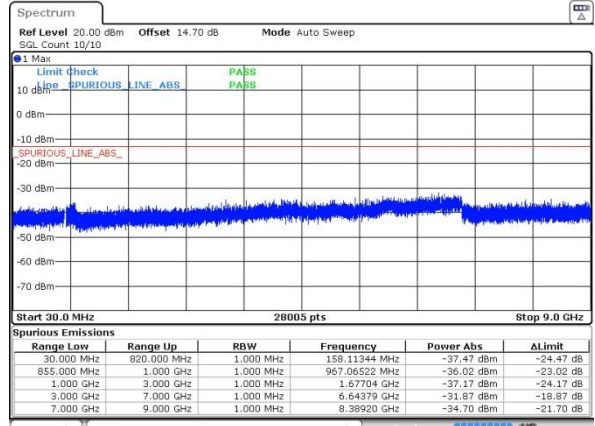

Date: 7.MAY.2020 02:15:49

Middle Channel

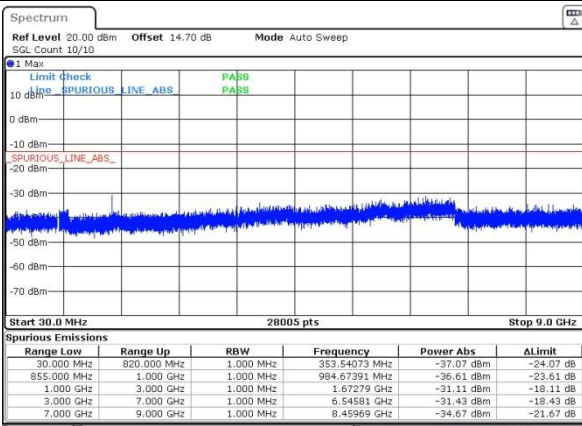

Date: 7.MAY.2020 01:59:30

Middle Channel

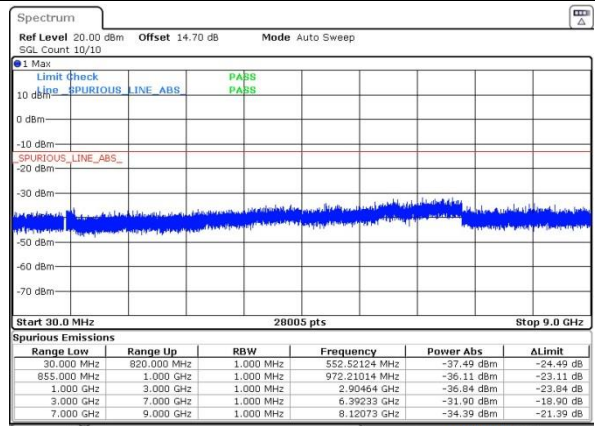

Date: 7.MAY.2020 02:15:55

Highest Channel

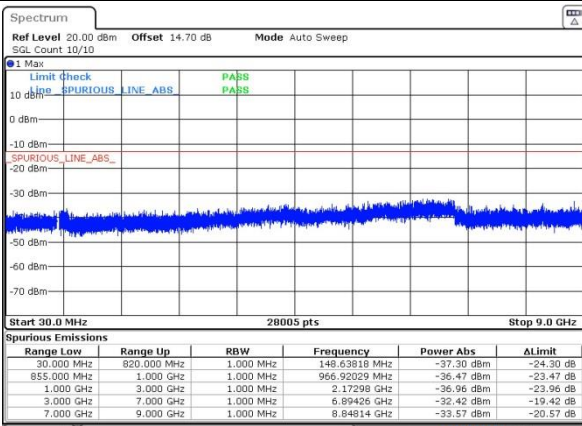

Date: 7.MAY.2020 01:59:40

Highest Channel

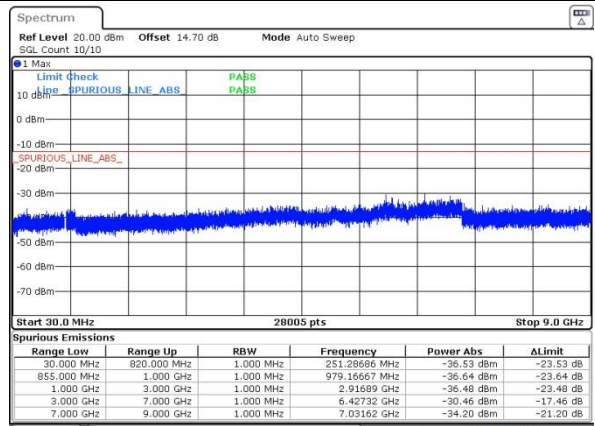

Date: 7.MAY.2020 02:16:01



GSM1900 (GSM)

Lowest Channel

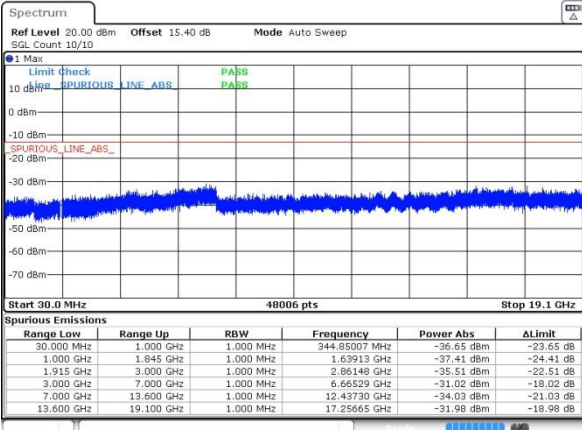

Date: 7 MAY 2020 02:44:38

GSM1900 (EDGE class 8)

Lowest Channel

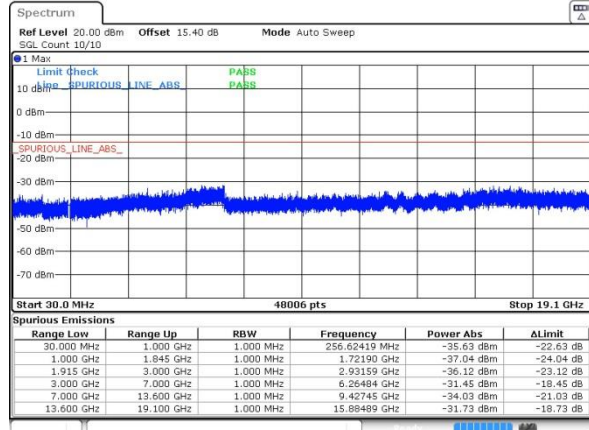

Date: 7 MAY 2020 02:57:41

Middle Channel

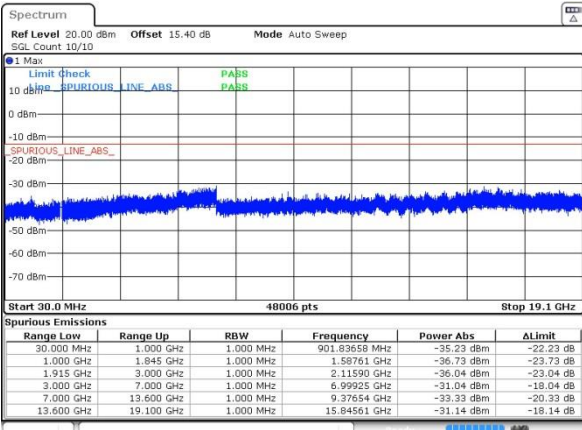

Date: 7 MAY 2020 02:44:52

Middle Channel

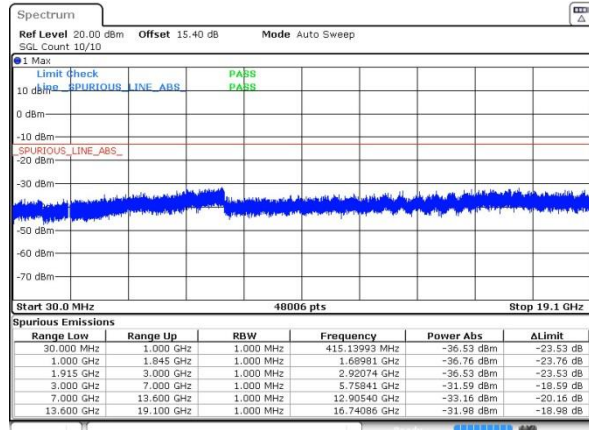

Date: 7 MAY 2020 02:57:52

Highest Channel

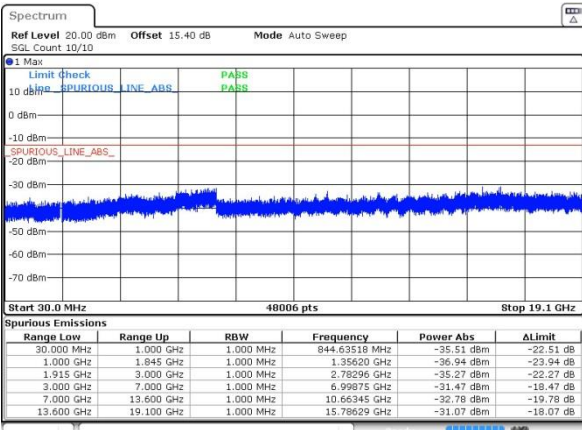

Date: 7 MAY 2020 02:45:04

Highest Channel

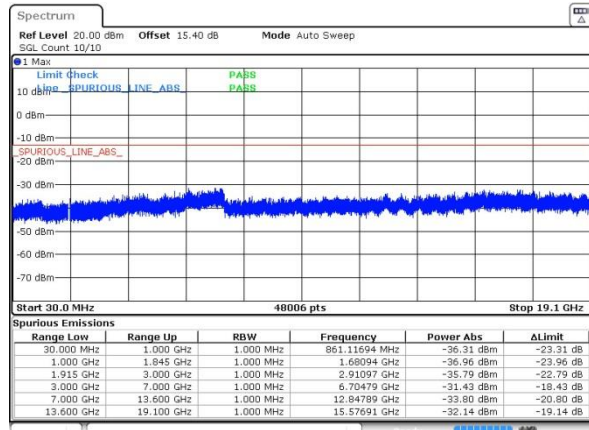

Date: 7 MAY 2020 02:58:02



Frequency Stability

Test Conditions	Middle Channel	GSM850 (GSM)	GSM850 (EDGE class 8)	Limit 2.5ppm
Temperature (°C)	Voltage (Volt)	Deviation (ppm)		Result
50	Normal Voltage	0.0072	0.0108	PASS
40	Normal Voltage	0.0012	0.0132	
30	Normal Voltage	0.0096	0.0072	
20(Ref.)	Normal Voltage	0.0000	0.0000	
10	Normal Voltage	0.0108	0.0132	
0	Normal Voltage	0.0096	0.0143	
-10	Normal Voltage	0.0203	0.0108	
-20	Normal Voltage	0.0096	0.0060	
-30	Normal Voltage	0.0167	0.0084	
20	Maximum Voltage	0.0060	0.0120	
20	Normal Voltage	0.0132	0.0203	
20	Battery End Point	0.0084	0.0120	

Test Conditions	Middle Channel	GSM1900 (GSM)	GSM1900 (EDGE class 8)	Limit Note 2.
Temperature (°C)	Voltage (Volt)	Deviation (ppm)		Result
50	Normal Voltage	0.0069	0.0037	PASS
40	Normal Voltage	0.0005	0.0016	
30	Normal Voltage	0.0101	0.0112	
20(Ref.)	Normal Voltage	0.0000	0.0000	
10	Normal Voltage	0.0074	0.0018	
0	Normal Voltage	0.0085	0.0043	
-10	Normal Voltage	0.0069	0.0005	
-20	Normal Voltage	0.0048	0.0037	
-30	Normal Voltage	0.0021	0.0016	
20	Maximum Voltage	0.0011	0.0048	
20	Normal Voltage	0.0032	0.0037	
20	Battery End Point	0.0043	0.0016	



Note:

1. Normal Voltage = 3.8V ; Battery End Point (BEP) =3.4V. ; Maximum Voltage =4.4V
2. The frequency fundamental emissions stay within the authorized frequency block based on the frequency deviation measured is small.



A2. WCDMA

Peak-to-Average Ratio

Mode	WCDMA Band V	WCDMA Band II	Limit: 13dB
Mod.	RMC 12.2Kbps	RMC 12.2Kbps	Result
Lowest CH	2.90	2.78	PASS
Middle CH	2.99	2.75	
Highest CH	2.90	2.55	

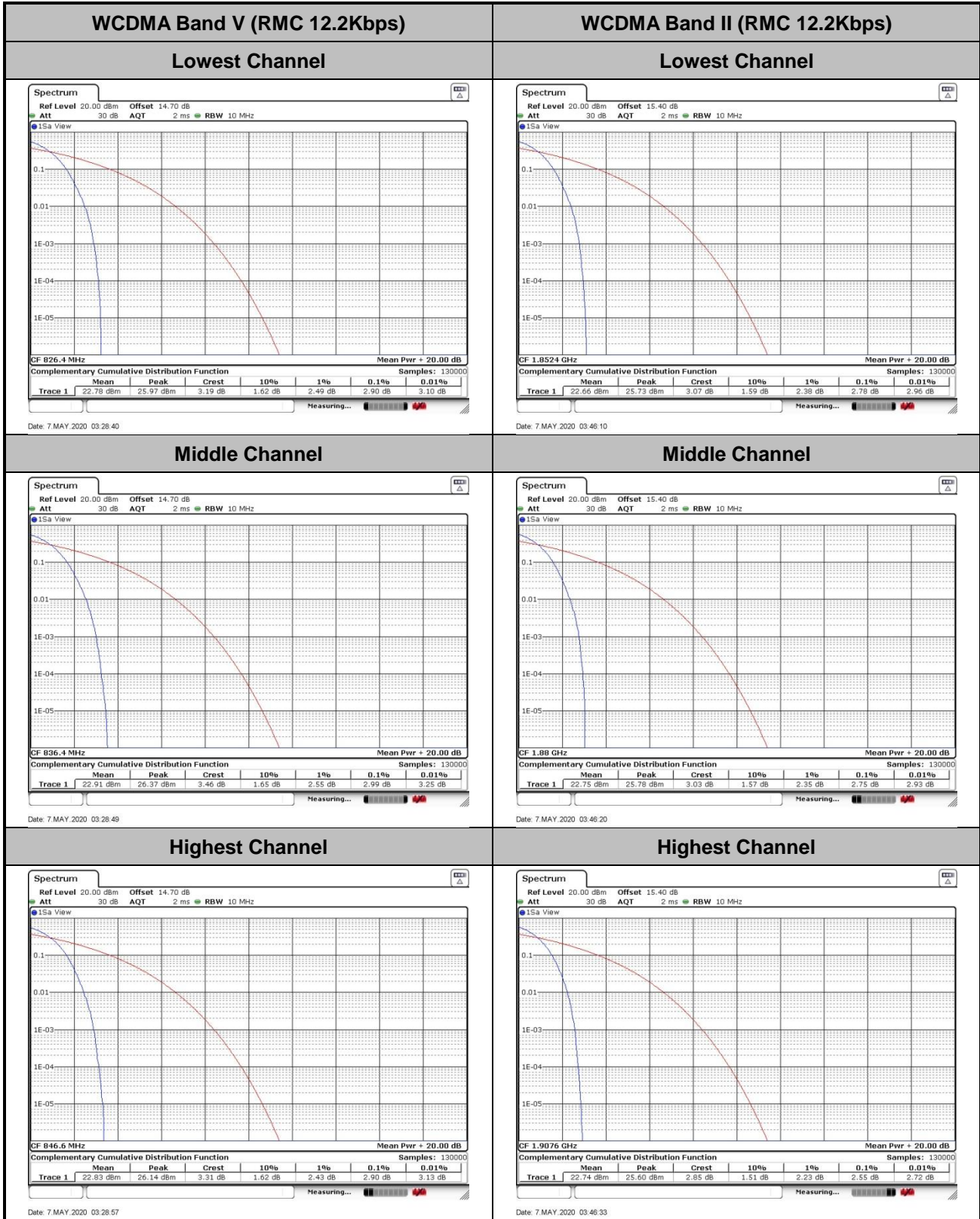



26dB Bandwidth

Mode	WCDMA Band V	WCDMA Band II
Mod.	RMC 12.2Kbps	RMC 12.2Kbps
Lowest CH	4.675	4.675
Middle CH	4.675	4.675
Highest CH	4.675	4.685



WCDMA Band V (RMC 12.2Kbps)

Lowest Channel

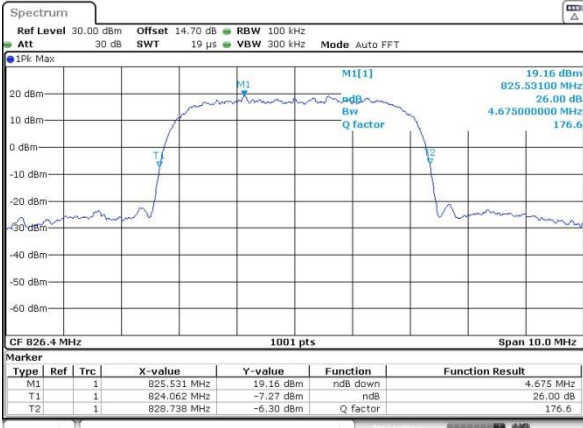

Date: 7 MAY 2020 03:16:15

WCDMA Band II (RMC 12.2Kbps)

Lowest Channel

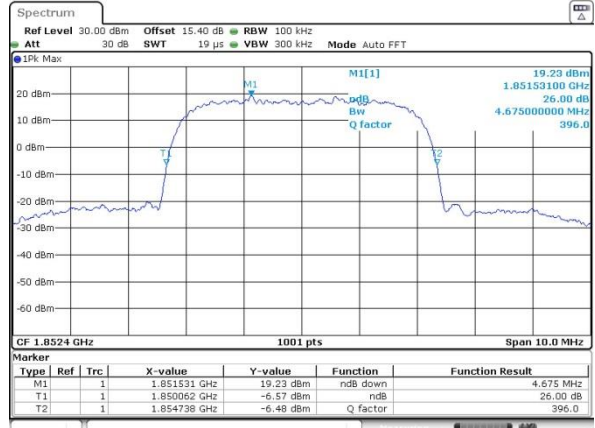

Date: 7 MAY 2020 03:39:04

Middle Channel

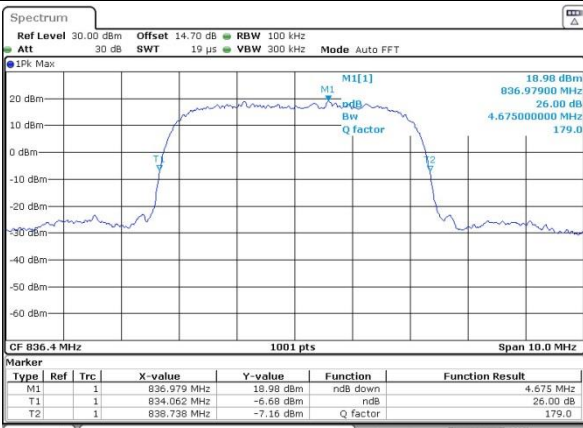

Date: 7 MAY 2020 03:16:37

Middle Channel

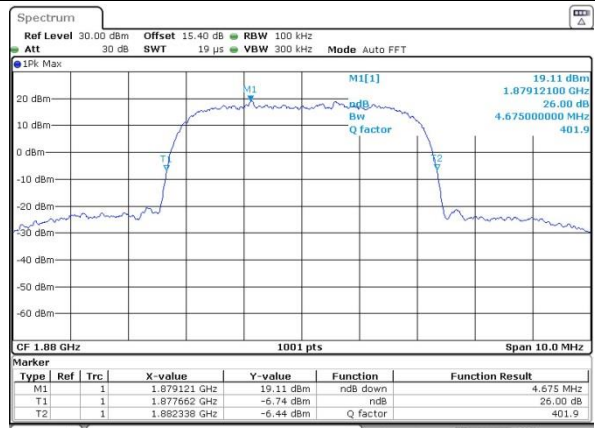

Date: 7 MAY 2020 03:39:25

Highest Channel

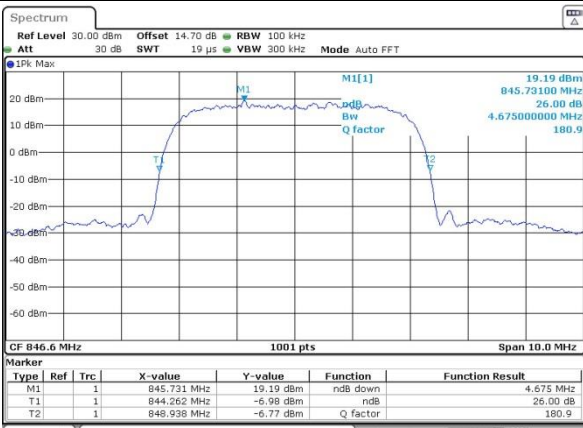

Date: 7 MAY 2020 03:16:56

Highest Channel

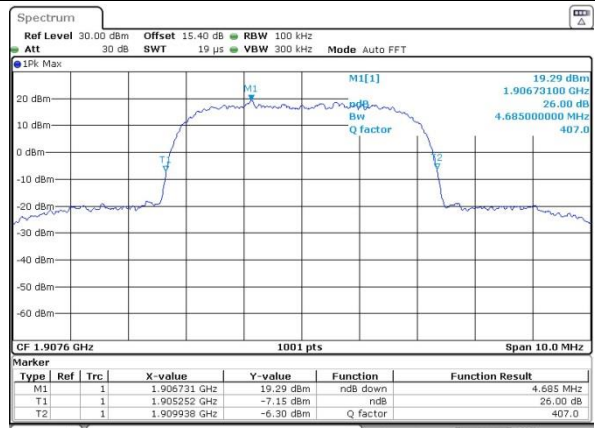

Date: 7 MAY 2020 03:39:48



Occupied Bandwidth

Mode	WCDMA Band V	WCDMA Band II
Mod.	RMC 12.2Kbps	RMC 12.2Kbps
Lowest CH	4.146	4.146
Middle CH	4.146	4.136
Highest CH	4.136	4.146

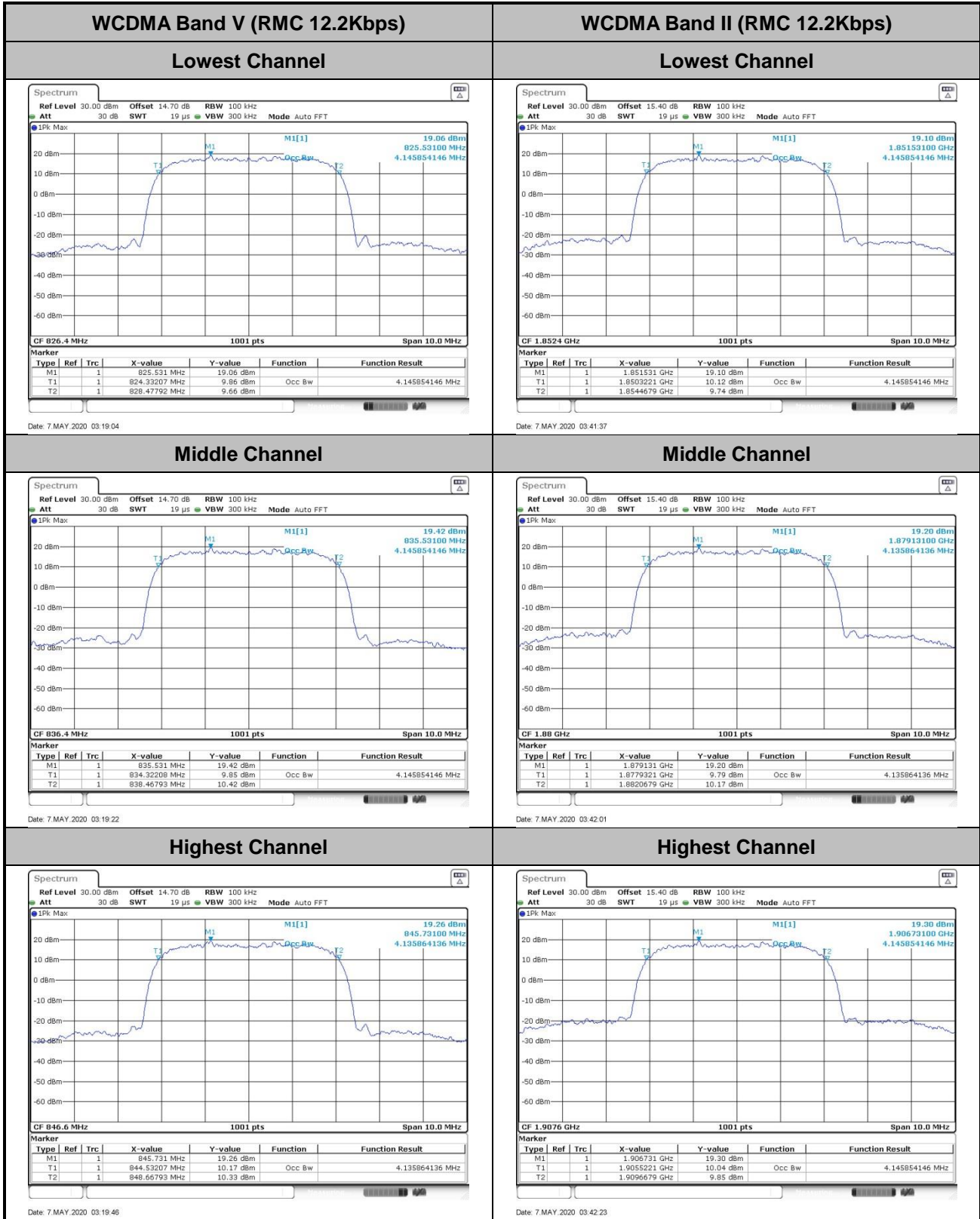



Conducted Band Edge

