

4.6. 6dB Bandwidth

TEST CONFIGURATION

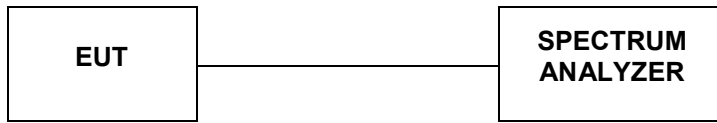

TEST PROCEDURE

According to KDB789033 D02 General U-NII Test Procedures New Rules v02r01 for one of the following procedures may be used for section 15.407(e) specifies the minimum 6 dB emission bandwidth of at least 500 KHz for the band 5.715-5.85 GHz. The following procedure shall be used for measuring this bandwidth:

- a. Set RBW = 100 kHz.
- b. Set the video bandwidth (VBW) $\geq 3 \times$ RBW
- c. Detector = Peak.
- d. Trace mode = max hold.
- e. Sweep = auto couple.
- f. Allow the trace to stabilize
- g. Measure the maximum width of the emission that is constrained by the frequencies associated with the two outermost amplitude points (upper and lower frequencies) that are attenuated by 6 dB relative to the maximum level measured in the fundamental emission.

Note: The automatic bandwidth measurement capability of a spectrum analyzer or EMI receiver may be employed if it implements the functionality described above.

LIMIT

For Section 15.407(e) specifies the minimum 6 dB emission bandwidth of at least 500 KHz for the band 5.715-5.85 GHz

TEST RESULTS

Temperature	23.6°C	Humidity	55.7%
Test Engineer	Oliver Ou	Configurations	IEEE 802.11a/n/ac

Type	Channel	6dB Bandwidth (MHz)	Limit (KHz)	Result
802.11a	149	15.280	>500	Pass
	157	15.240		
	165	15.800		
802.11nHT20	149	17.280	>500	Pass
	157	17.160		
	165	17.240		
802.11n40	151	36.000	>500	Pass
	159	35.600		
802.11ac20	149	15.280	>500	Pass
	157	15.280		
	165	15.280		
802.11ac40	151	35.760	>500	Pass
	159	35.680		
802.11ac80	155	75.520	>500	Pass

6dB Bandwidth

802.11a

802.11n HT20

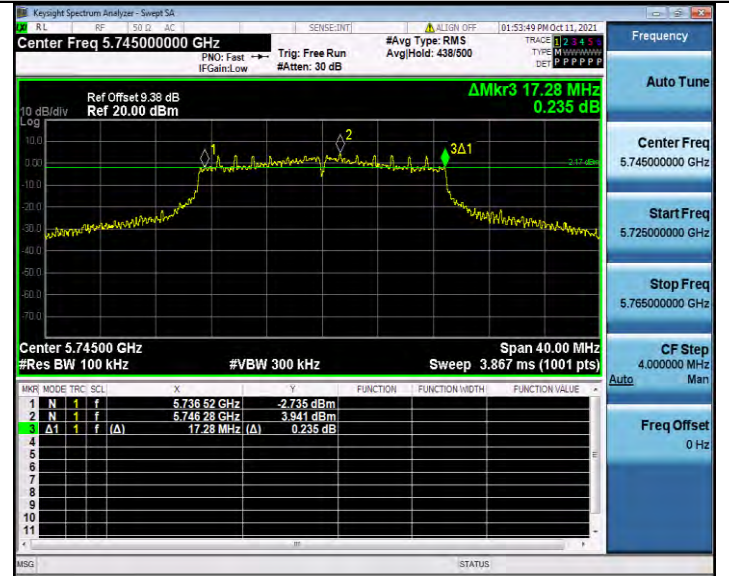
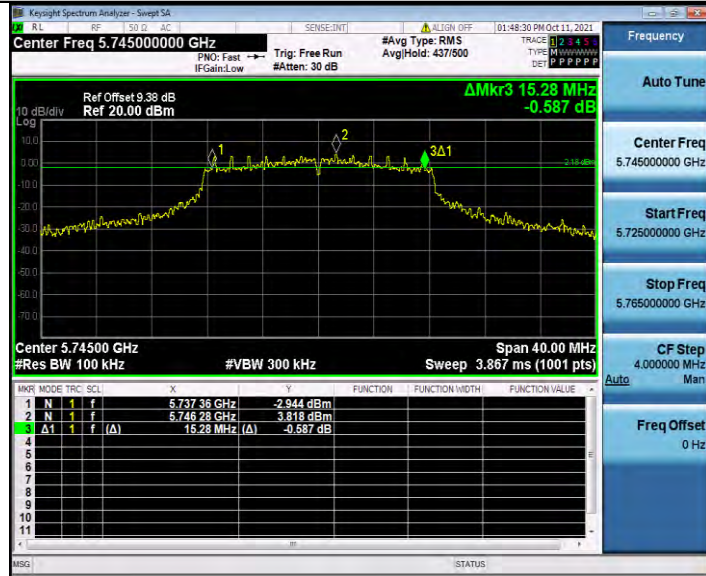

CH149

CH149

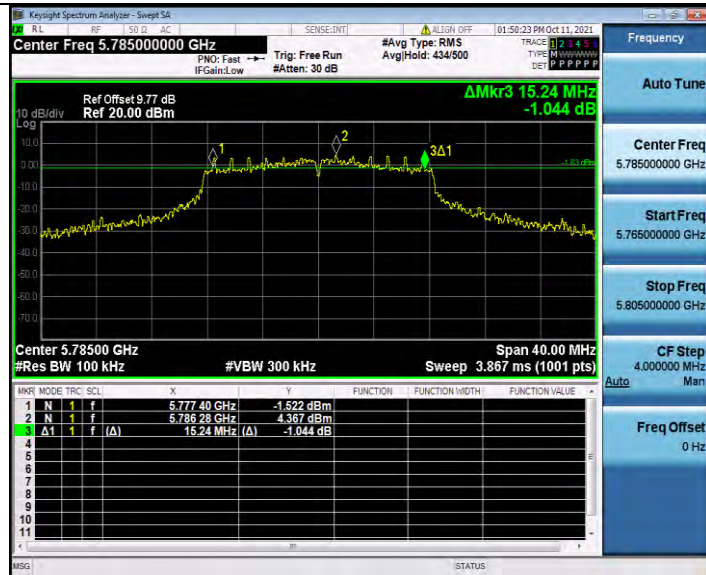

CH157

CH157

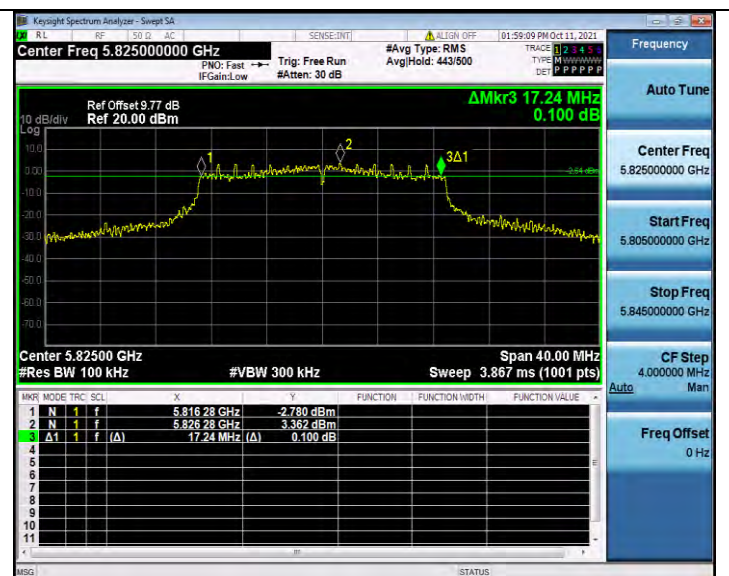

CH165

CH165

6dB Bandwidth

802.11ac20

802.11n HT40

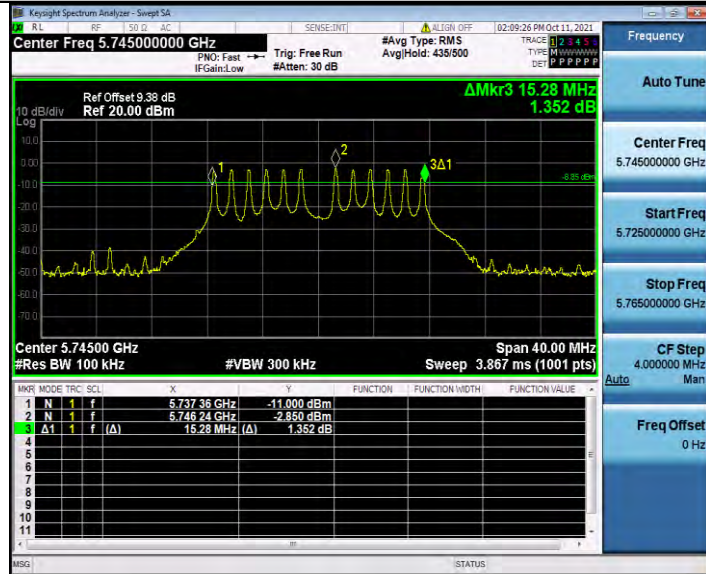

CH149

CH151

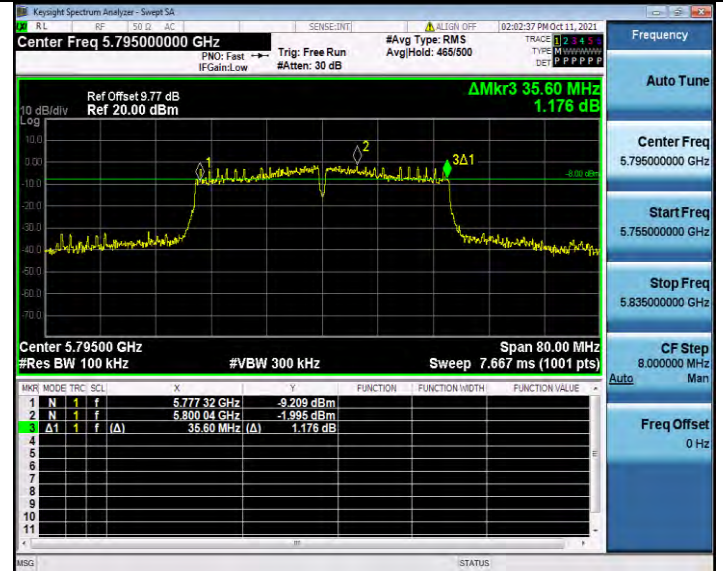
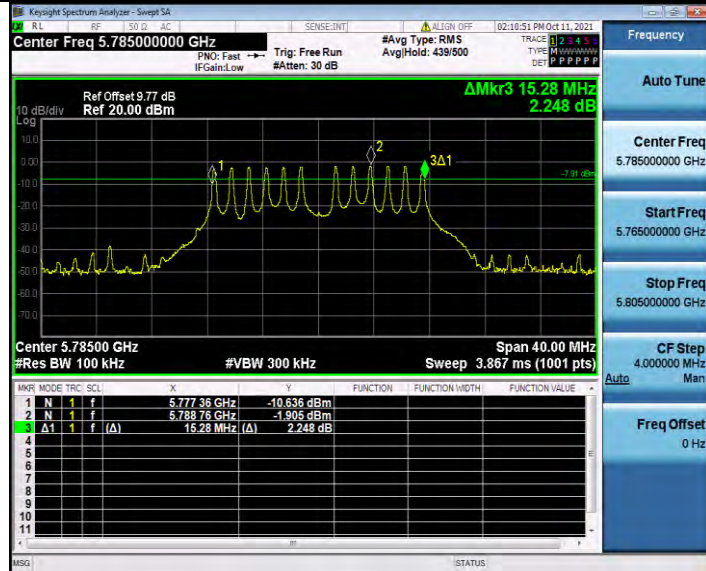

CH157

CH159

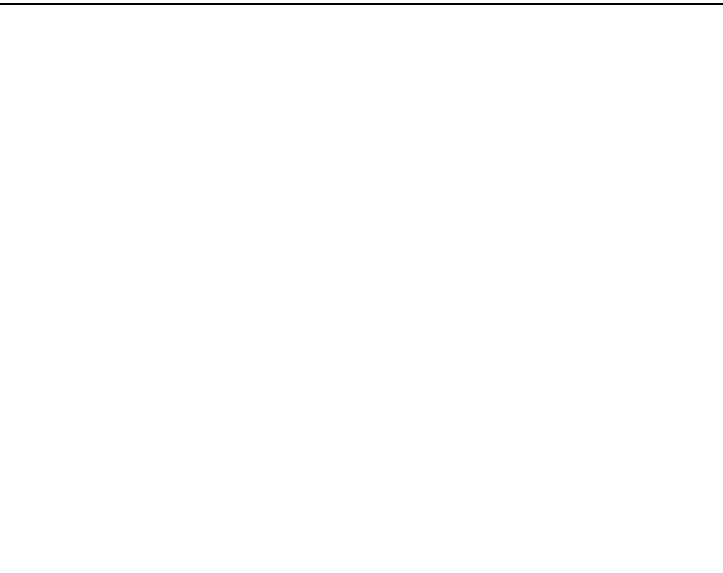
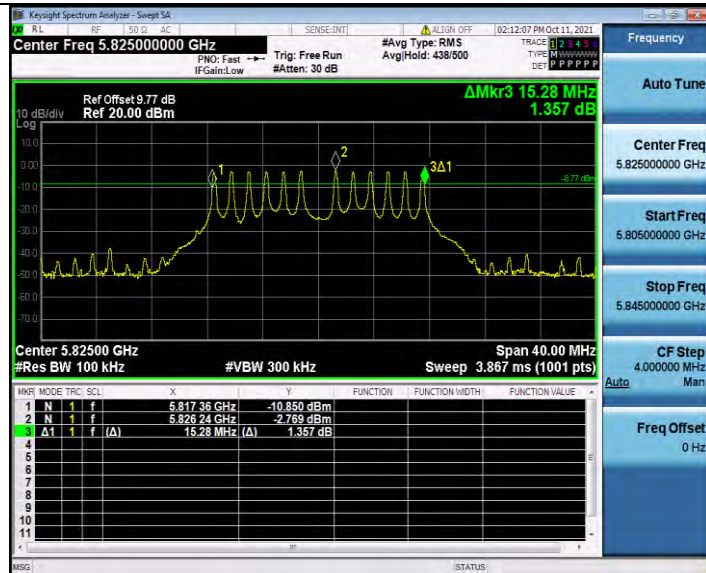

CH165

6dB Bandwidth

802.11ac40

802.11ac80

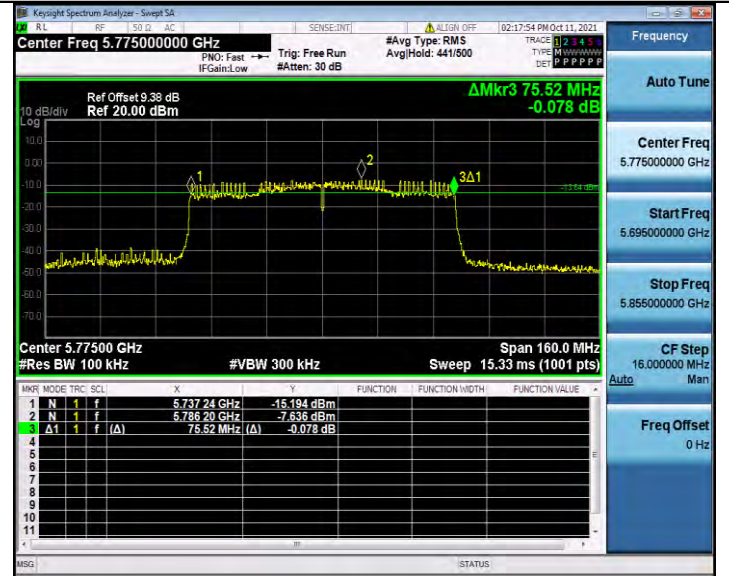
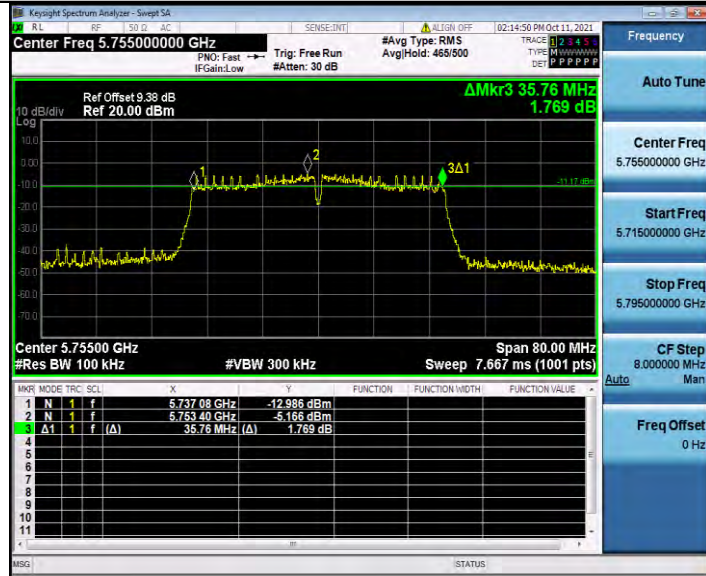

CH151

CH155

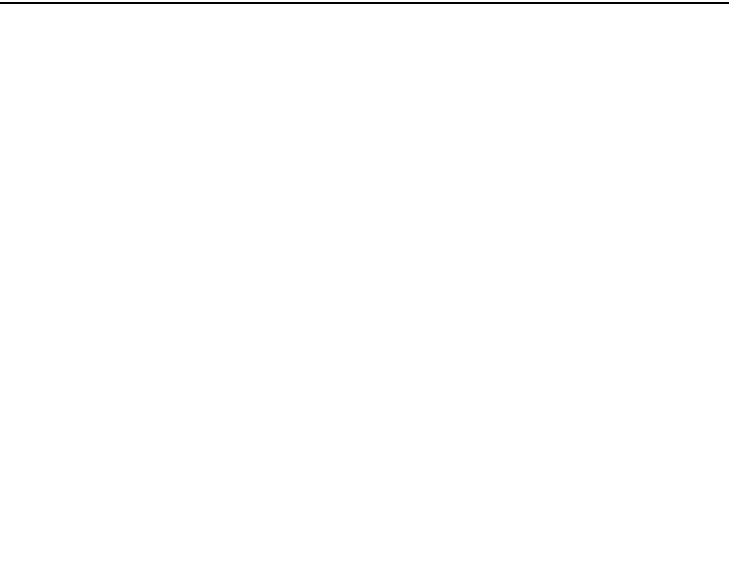
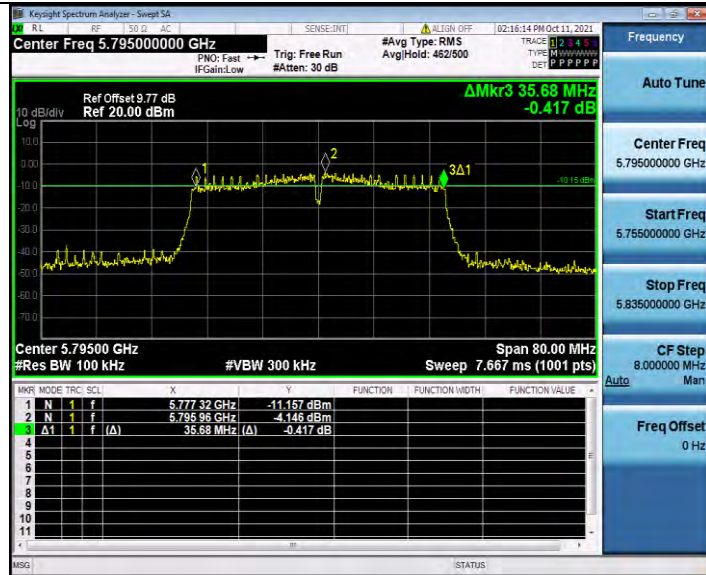

CH159

4.7. 26dBc Bandwidth

TEST CONFIGURATION

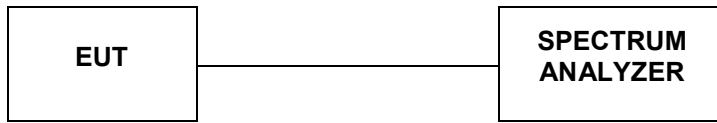

TEST PROCEDURE

According to KDB789033 D02 General U-NII Test Procedures New Rules v02r01 for one of the following procedures may be used for Emission Bandwidth (EBW) measurement:

- a. Set RBW = 220 kHz/430 kHz /820 kHz (approximately 1% of the emission bandwidth).
- b. Set the video bandwidth (VBW) = 3* RBW
- c. Detector = Peak.
- d. Trace mode = max hold.
- e. Sweep = auto couple.
- f. Allow the trace to stabilize
- g. Measure the maximum width of the emission that is 26 dB down from the maximum of the emission. Compare this with the RBW setting of the analyzer. Readjust RBW and repeat measurement as needed until the RBW/EBW ratio is approximately 1%.

Note: The automatic bandwidth measurement capability of a spectrum analyzer or EMI receiver may be employed if it implements the functionality described above.

LIMIT

No Limits for 26dBc Bandwidth

TEST RESULTS

Temperature	23.6°C	Humidity	55.7%
Test Engineer	Oliver Ou	Configurations	IEEE 802.11a/n/ac

Type	Channel	99%Bandwidth (MHz)	26dB Bandwidth (MHz)	Limit (KHz)	Result
802.11a	36	18.061	26.280	-	Pass
	40	17.646	22.880		
	48	17.674	24.240		
802.11nHT20	36	18.851	29.000	-	Pass
	40	18.863	29.520		
	48	18.315	23.280		
802.11n40	38	36.520	49.920	-	Pass
	46	36.395	43.840		
802.11ac20	36	16.064	18.280	-	Pass
	40	16.038	18.200		
	48	16.063	18.240		
802.11ac40	38	36.622	39.760	-	Pass
	46	36.532	39.760		
802.11ac80	42	75.197	80.000	-	Pass

99%Bandwidth

802.11a

802.11n HT20



CH36

CH36



CH40

CH40



CH48

CH48

99%Bandwidth

802.11ac20

802.11n HT40

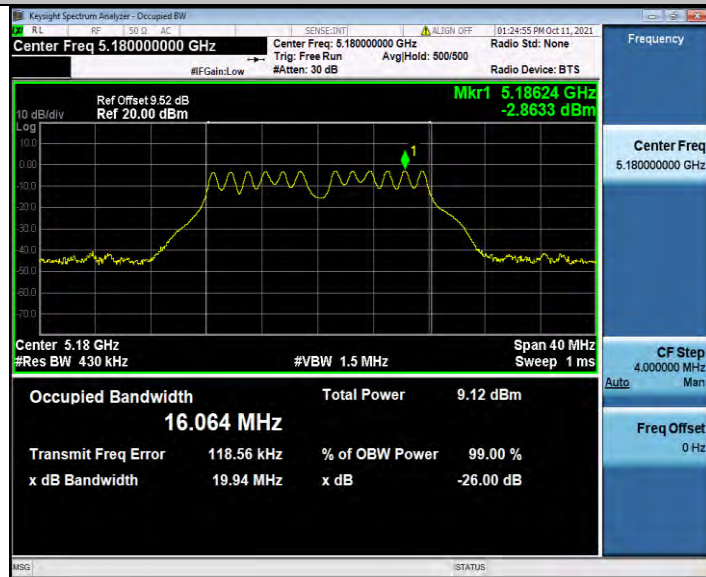

CH36

CH38



CH40

CH46

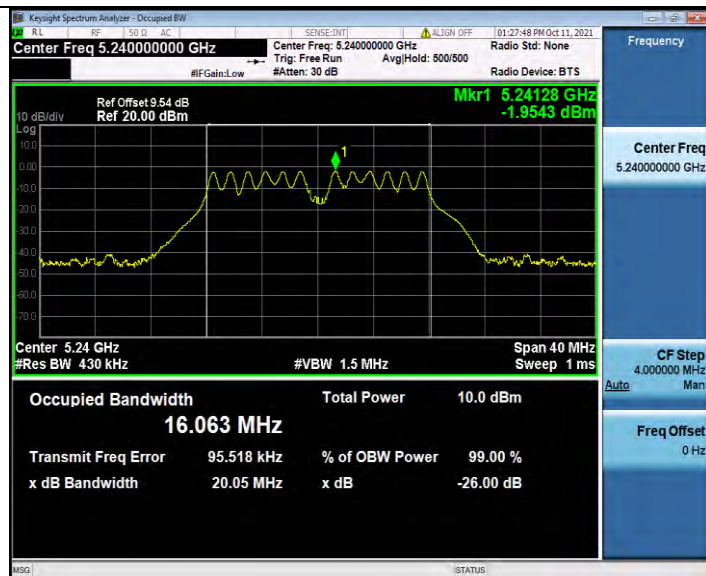

CH48



99%Bandwidth

802.11ac40

802.11ac80

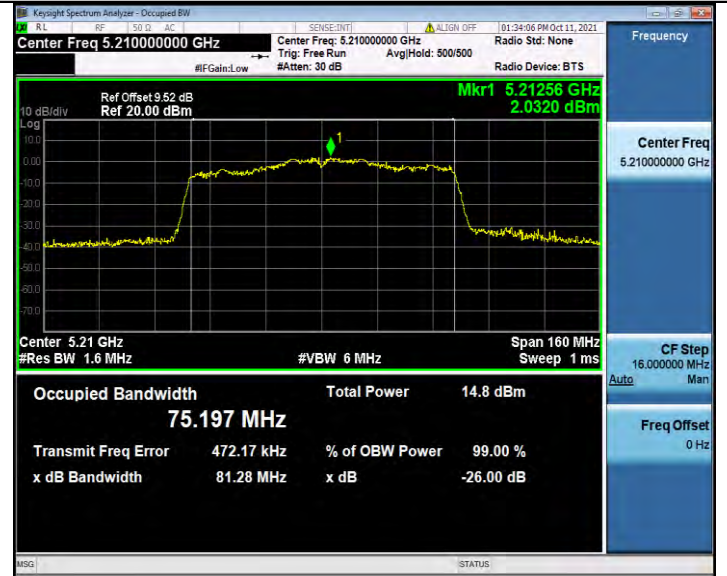

CH38

CH42



CH46



26dB Bandwidth

802.11a

802.11n HT20



CH36

CH36

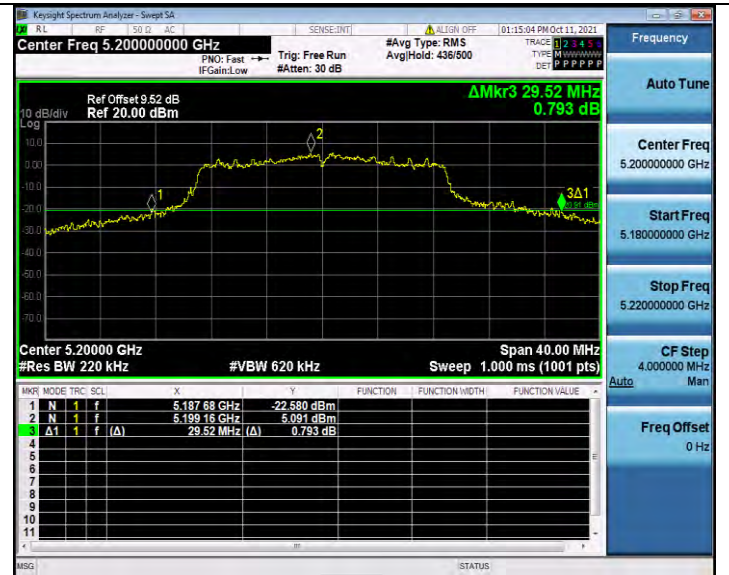

CH40

CH40

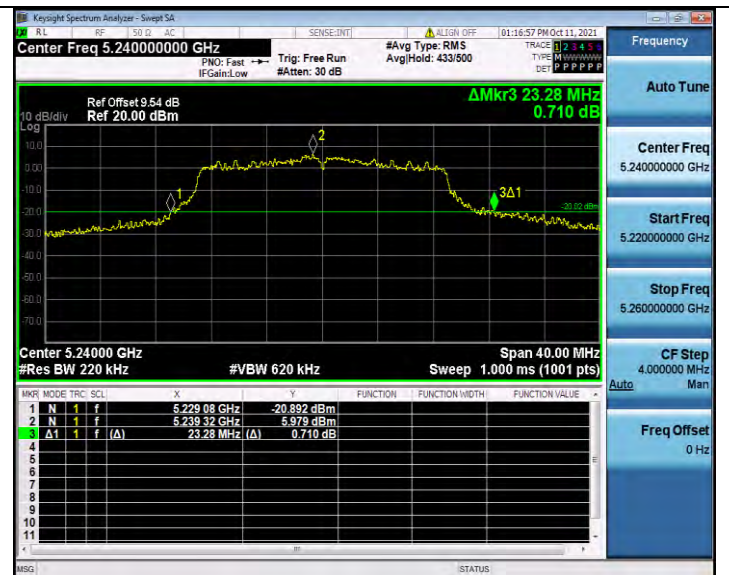

CH48

CH48

26dB Bandwidth

802.11ac20

802.11n HT40

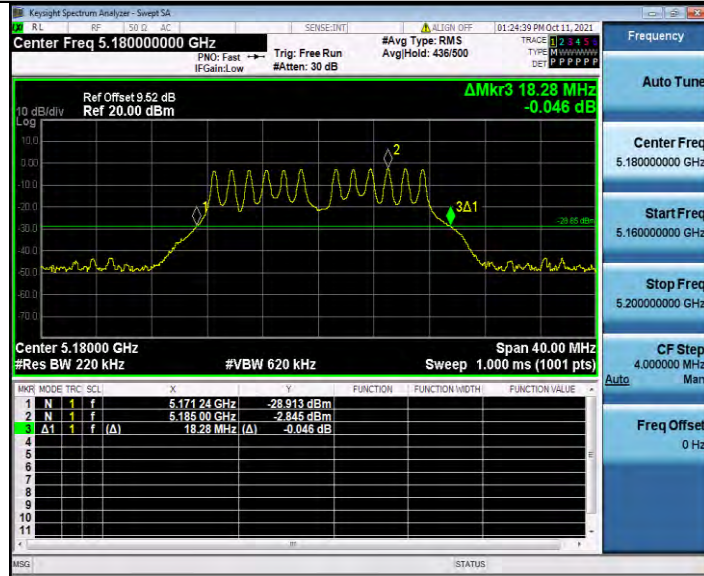

CH36

CH38

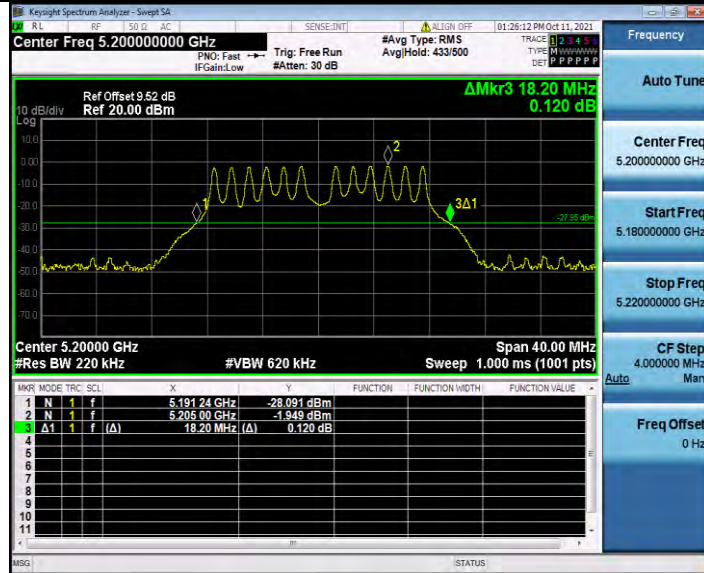

CH40

CH46

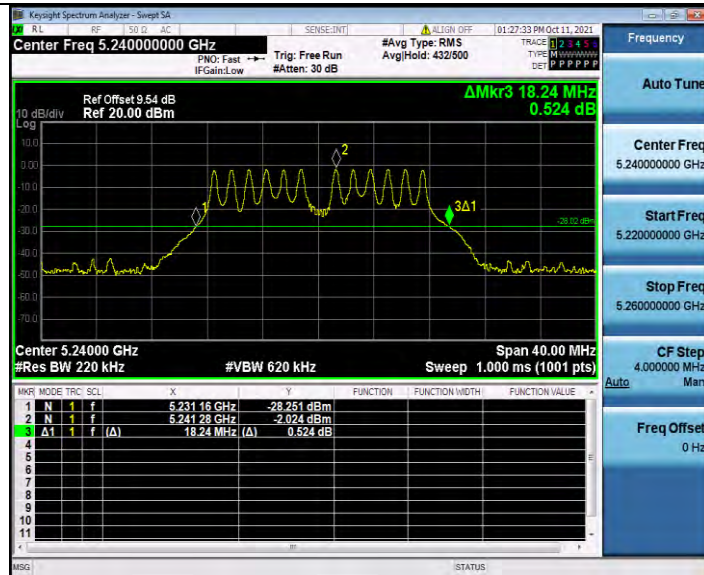

CH48

26dB Bandwidth

802.11ac40

802.11ac80



CH38

CH42

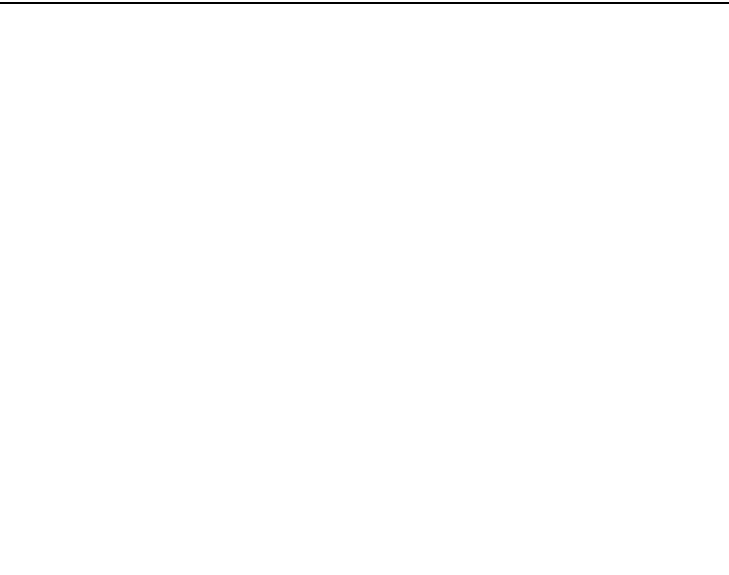

CH46

4.8. Band Edge Compliance

TEST CONFIGURATION

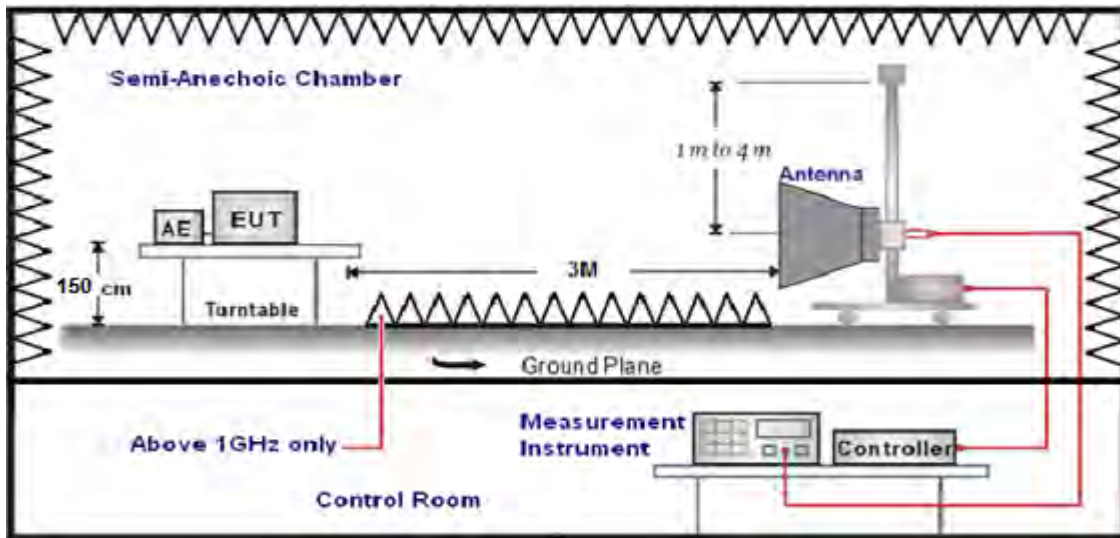

LIMIT

20dBc in any 100 kHz bandwidth outside the operating frequency band. In case the emission fall within the restricted band specified on 15.205(a), then the 15.209(a) limit in the table below has to be followed.

Frequency (MHz)	Distance (Meters)	Radiated (dBµV/m)	Radiated (µV/m)
0.009-0.49	3	$20\log(2400/F(KHz))+40\log(300/3)$	$2400/F(KHz)$
0.49-1.705	3	$20\log(24000/F(KHz))+ 40\log(30/3)$	$24000/F(KHz)$
1.705-30	3	$20\log(30)+ 40\log(30/3)$	30
30-88	3	40.0	100
88-216	3	43.5	150
216-960	3	46.0	200
Above 960	3	54.0	500

According to §15.407 (b): Except as shown in paragraph (b)(7) of this section, the maximum emissions outside of the frequency bands of operation shall be attenuated in accordance with the following limits

Frequency (MHz)	EIRP Limit (dBm)	Equivalent Field Strength at 3m (dBµV/m)
5150-5250	-27	68.2
5250-5350	-27	68.2
5470-5725	-27	68.2
5725-5850	-27 (beyond 10MHz of the bandedge)	68.2
	-17 (within 10 MHz of band edge)	78.2

TEST PROCEDURE

1. The EUT was placed on a turn table which is 1.5m above 1GHz.
2. Maximum procedure was performed by raising the receiving antenna from 1m to 4m and rotating the turn table from 0° to 360° to acquire the highest emissions from EUT.
3. And also, each emission was to be maximized by changing the polarization of receiving antenna both horizontal and vertical.
4. Repeat above procedures until all frequency measurements have been completed..
5. The distance between test antenna and EUT as following table states:

Test Frequency range	Test Antenna Type	Test Distance
1GHz-18GHz	Double Ridged Horn Antenna	3

6. Setting test receiver/spectrum as following table states:

Test Frequency range	Test Receiver/Spectrum Setting	Detector
1GHz-18GHz	Peak Value: RBW=1MHz/VBW=3MHz, Sweep time=Auto Average Value: RBW=1MHz/VBW=10Hz, Sweep time=Auto	Peak

Field Strength Calculation

The field strength is calculated by adding the Antenna Factor and Cable Factor and subtracting the Amplifier Gain and Duty Cycle Correction Factor(if any) from the measured reading. The basic equation with a sample calculation is as follows:

$$FS = RA + AF + CL - AG$$

Where FS = Field Strength	CL = Cable Attenuation Factor (Cable Loss)
RA = Reading Amplitude	AG = Amplifier Gain
AF = Antenna Factor	

TEST RESULTS

Note: All the modes have been tested and recorded worst mode in the report.

For Radiated Bandedge Measurement

Temperature	23.4°C	Humidity	54.5%
Test Engineer	Oliver Ou	Configurations	IEEE 802.11a/n/ac

802.11 ac20/ Channel 36 :5180 MHz									
Freq (MHz)	Read Level (dBµV)	Antenna Factor (dB/m)	PRM Factor (dB)	Cable Loss (dB)	Result Level (dBµV/m)	Limit Line (dBµV/m)	Margin (dB)	Detector	Polarization
4500.0	35.10	35.58	29.04	8.28	49.92	68.20	-18.28	Peak	Horizontal
4500.0	30.04	35.58	29.04	8.28	44.86	54.00	-9.14	AV	Horizontal
5150.0	39.01	35.58	29.04	8.28	53.83	68.20	-14.37	Peak	Horizontal
5150.0	30.68	35.58	29.04	8.28	45.50	54.00	-8.50	AV	Horizontal

802.11 ac20/ Channel 36 :5180 MHz									
Freq (MHz)	Read Level (dBµV)	Antenna Factor (dB/m)	PRM Factor (dB)	Cable Loss (dB)	Result Level (dBµV/m)	Limit Line (dBµV/m)	Margin (dB)	Detector	Polarization
4500.0	35.06	35.58	29.04	8.28	49.88	68.20	-18.32	Peak	Vertical
4500.0	30.23	35.58	29.04	8.28	45.05	54.00	-8.95	AV	Vertical
5150.0	39.27	35.58	29.04	8.28	54.09	68.20	-14.11	Peak	Vertical
5150.0	30.52	35.58	29.04	8.28	45.34	54.00	-8.66	AV	Vertical

802.11 ac20/ Channel 48 :5240 MHz									
Freq (MHz)	Read Level (dBµV)	Antenna Factor (dB/m)	PRM Factor (dB)	Cable Loss (dB)	Result Level (dBµV/m)	Limit Line (dBµV/m)	Margin (dB)	Detector	Polarization
5350.0	35.11	35.42	29.06	8.39	49.86	68.20	-18.34	Peak	Horizontal
5350.0	30.13	35.42	29.06	8.39	44.88	54.00	-9.12	AV	Horizontal
5460.0	39.01	35.42	29.06	8.39	53.76	68.20	-14.44	Peak	Horizontal
5460.0	30.52	35.42	29.06	8.39	45.27	54.00	-8.73	AV	Horizontal

802.11 ac20/ Channel 48 :5240 MHz									
Freq (MHz)	Read Level (dBµV)	Antenna Factor (dB/m)	PRM Factor (dB)	Cable Loss (dB)	Result Level (dBµV/m)	Limit Line (dBµV/m)	Margin (dB)	Detector	Polarization
5350.0	35.03	35.42	29.06	8.39	49.78	68.20	-18.42	Peak	Vertical
5350.0	30.26	35.42	29.06	8.39	45.01	54.00	-8.99	AV	Vertical
5460.0	39.03	35.42	29.06	8.39	53.78	68.20	-14.42	Peak	Vertical
5460.0	30.65	35.42	29.06	8.39	45.40	54.00	-8.60	AV	Vertical

802.11 ac20/ Channel 149 :5745 MHz									
Freq (MHz)	Read Level (dBμV)	Antenna Factor (dB/m)	PRM Factor (dB)	Cable Loss (dB)	Result Level (dBμV/m)	Limit Line (dBμV/m)	Margin (dB)	Detector	Polarization
5650.0	30.27	35.3	29.11	8.51	44.97	68.20	-23.23	Peak	Horizontal
5700.0	30.20	35.3	29.11	8.51	44.90	105.20	-60.30	Peak	Horizontal
5720.0	32.01	35.3	29.11	8.51	46.71	110.80	-64.09	Peak	Horizontal
5725.0	30.65	35.3	29.11	8.51	45.35	122.20	-76.85	Peak	Horizontal

802.11 ac20/ Channel 149 :5745 MHz									
Freq (MHz)	Read Level (dBμV)	Antenna Factor (dB/m)	PRM Factor (dB)	Cable Loss (dB)	Result Level (dBμV/m)	Limit Line (dBμV/m)	Margin (dB)	Detector	Polarization
5650.0	30.10	35.3	29.11	8.51	44.80	68.20	-23.40	Peak	Vertical
5700.0	30.37	35.3	29.11	8.51	45.07	105.20	-60.13	Peak	Vertical
5720.0	32.12	35.3	29.11	8.51	46.82	110.80	-63.98	Peak	Vertical
5725.0	30.51	35.3	29.11	8.51	45.21	122.20	-76.99	Peak	Vertical

802.11 ac20/ Channel 165 :5825 MHz									
Freq (MHz)	Read Level (dBμV)	Antenna Factor (dB/m)	PRM Factor (dB)	Cable Loss (dB)	Result Level (dBμV/m)	Limit Line (dBμV/m)	Margin (dB)	Detector	Polarization
5850.0	45.99	35.29	29.13	8.65	60.80	122.20	-61.40	Peak	Horizontal
5855.0	34.77	35.29	29.13	8.65	49.58	110.80	-61.22	Peak	Horizontal
5875.0	46.99	35.29	29.13	8.65	61.80	105.20	-43.40	Peak	Horizontal
5925.0	35.26	35.29	29.13	8.65	50.07	68.20	-18.13	Peak	Horizontal

802.11 ac20/ Channel 165 :5825 MHz									
Freq (MHz)	Read Level (dBμV)	Antenna Factor (dB/m)	PRM Factor (dB)	Cable Loss (dB)	Result Level (dBμV/m)	Limit Line (dBμV/m)	Margin (dB)	Detector	Polarization
5850.0	45.99	35.29	29.13	8.65	60.80	122.20	-61.40	Peak	Vertical
5855.0	34.91	35.29	29.13	8.65	49.72	110.80	-61.08	Peak	Vertical
5875.0	46.94	35.29	29.13	8.65	61.75	105.20	-43.45	Peak	Vertical
5925.0	35.37	35.29	29.13	8.65	50.18	68.20	-18.02	Peak	Vertical

REMARKS:

1. Result Level = Read Level + Antenna Factor + Cable loss - PRM Factor.
2. Margin value = Result Level-Limit value.
2. The other emission levels were very low against the limit.
3. The average measurement was not performed when the peak measured data under the limit of average detection.
4. Detector AV is setting spectrum/receiver. RBW=1MHz/VBW=10Hz/Sweep time=Auto/Detector=Peak;

For Conducted Band edge Measurement

Temperature	23.6°C	Humidity	55.7%
Test Engineer	Oliver Ou	Configurations	IEEE 802.11a/n/ac

The test results have included the antenna gain

5150-5250MHz:

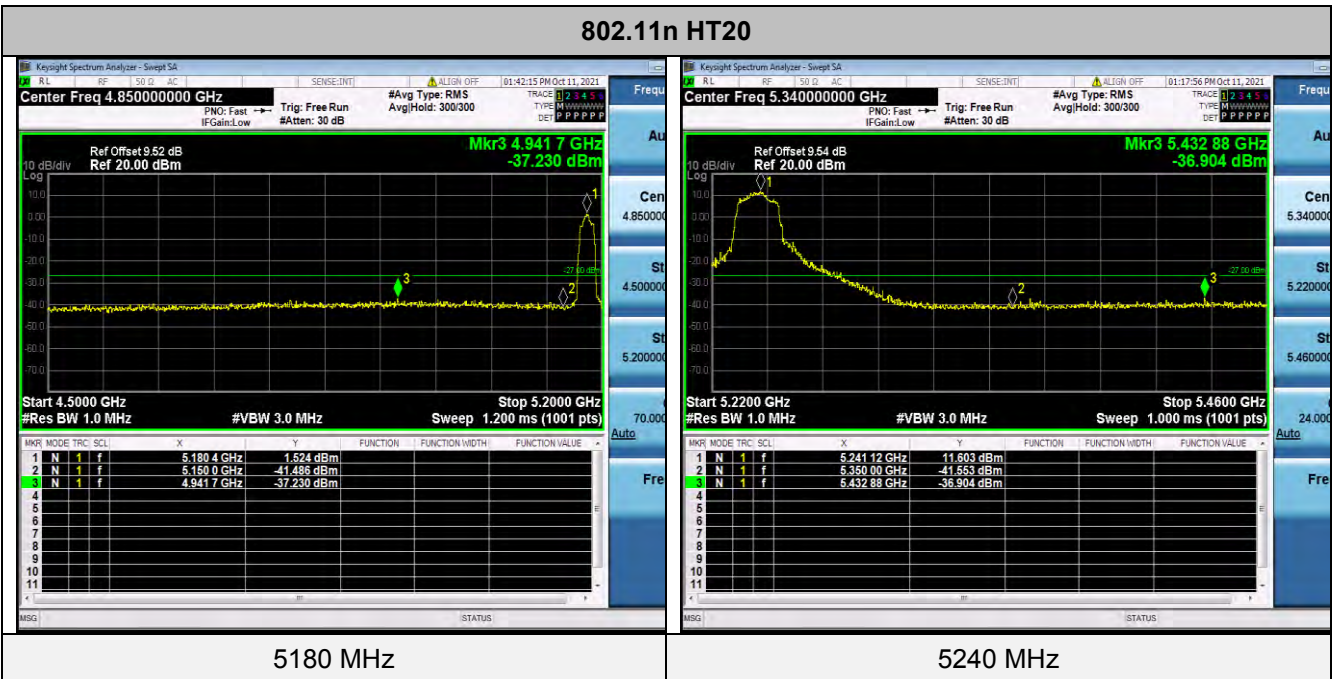
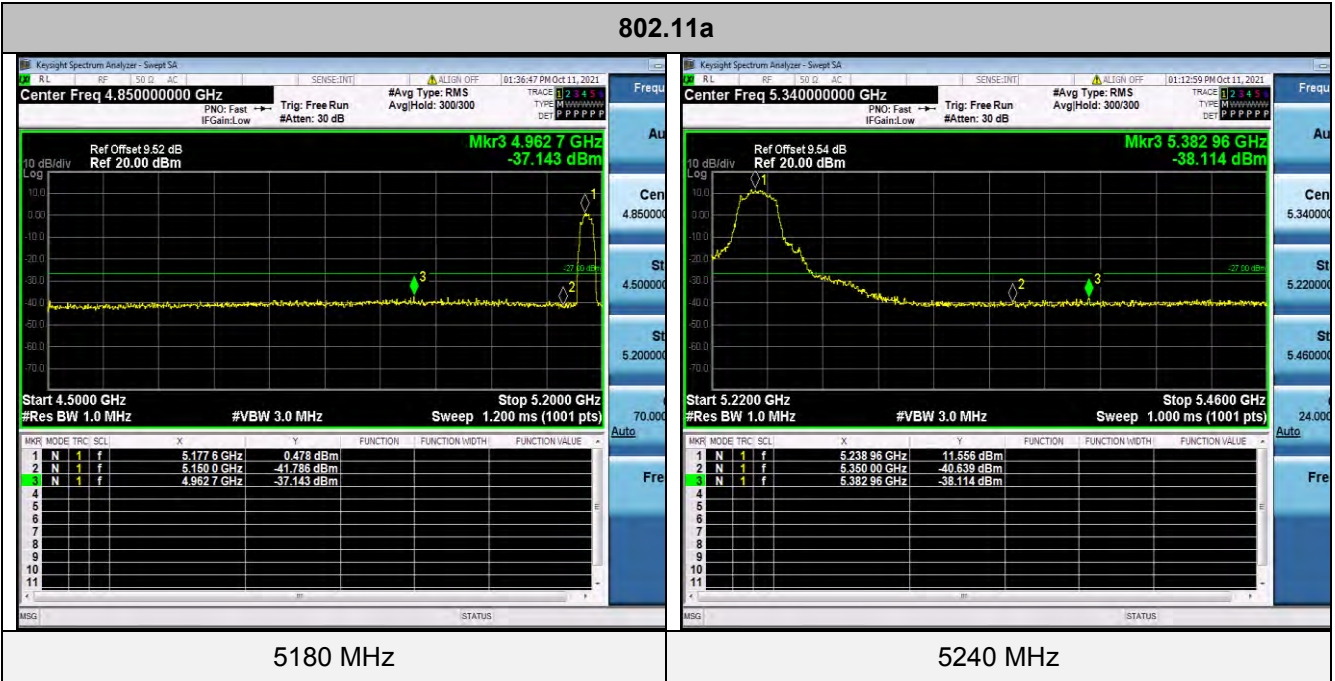

802.11ac20

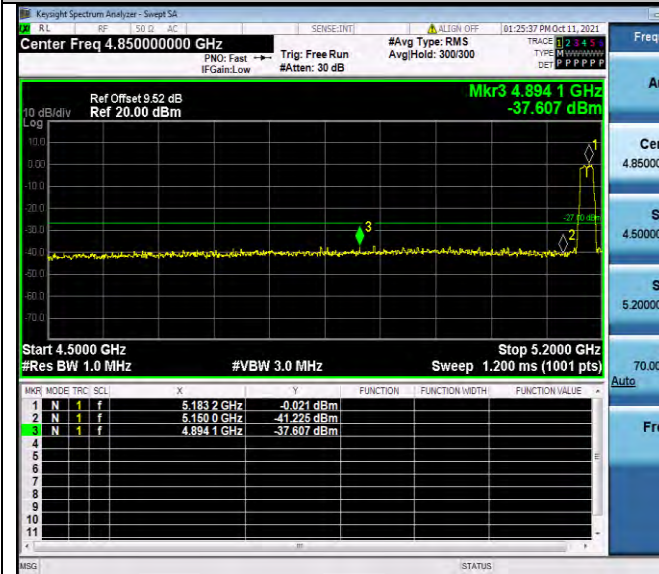

5180 MHz

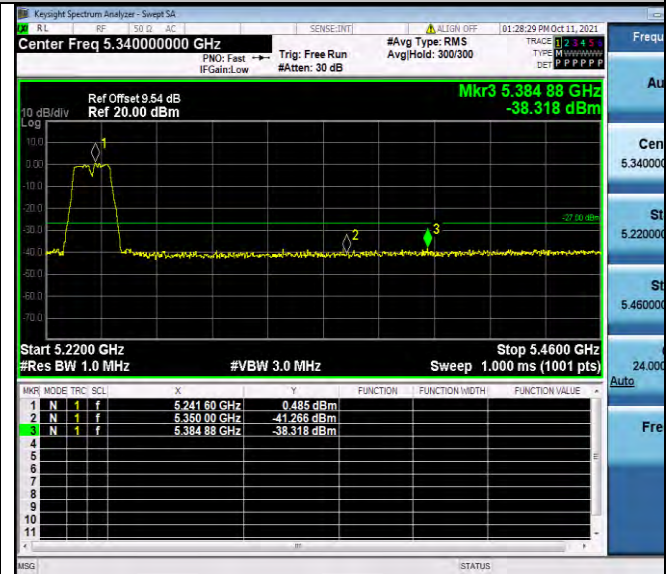

5240 MHz

802.11n HT40

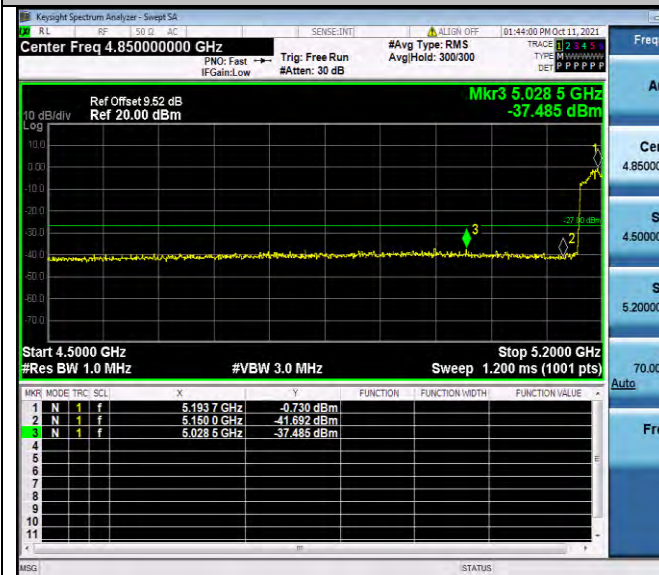

5190 MHz

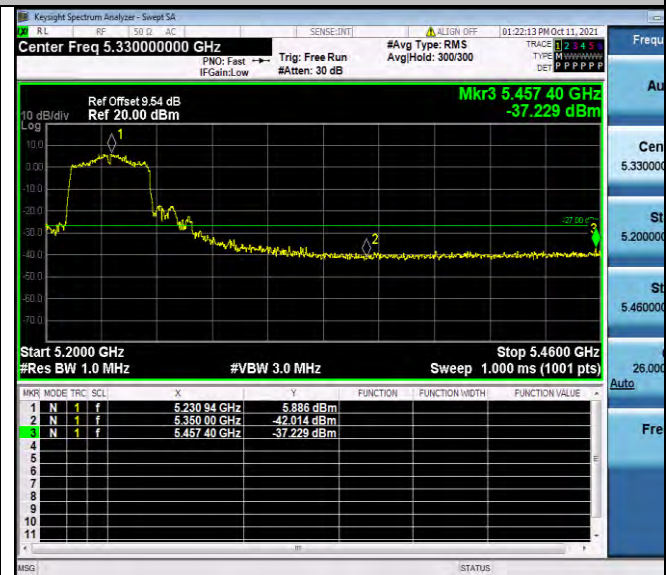

5230 MHz

802.11ac40



5190 MHz

5230 MHz

802.11ac80

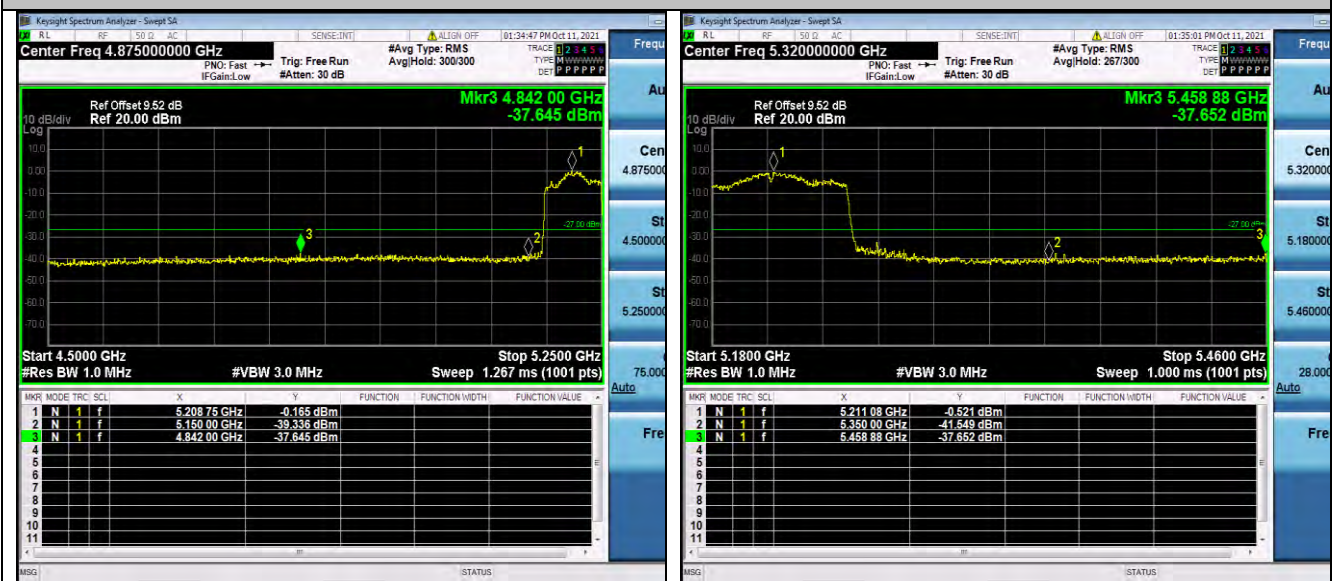

5210 MHz

5725-5850MHz:

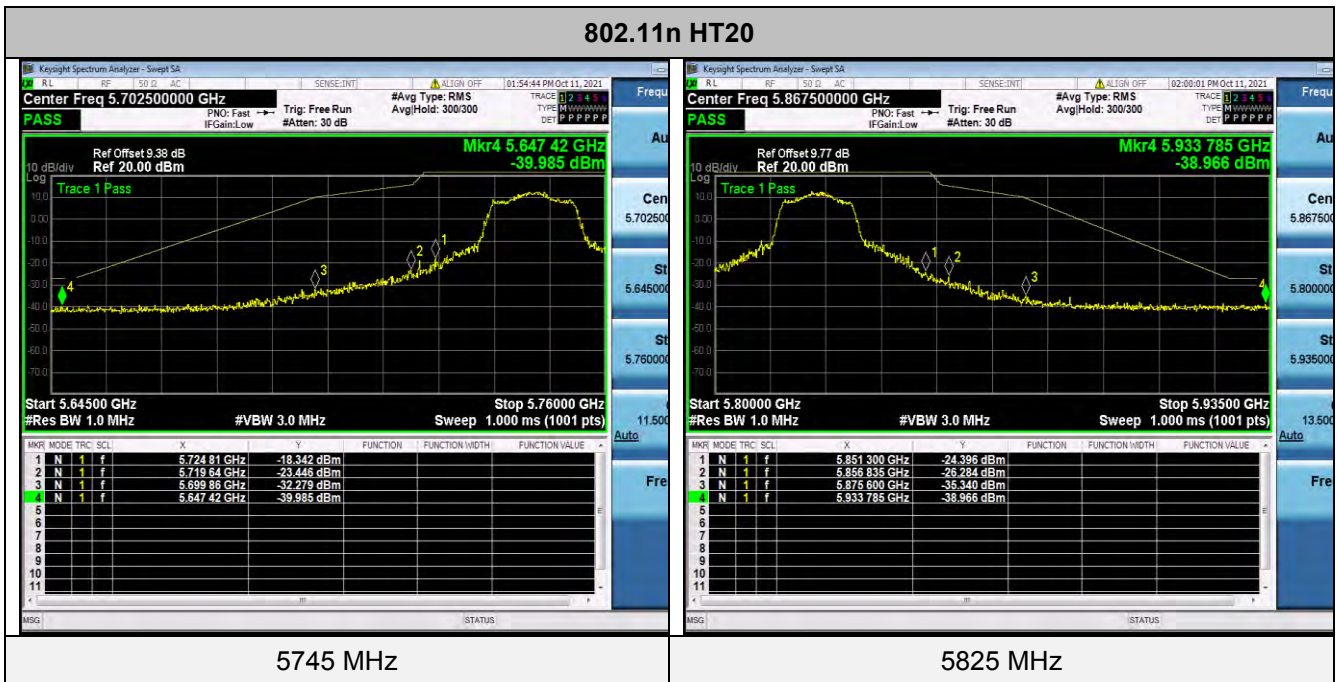
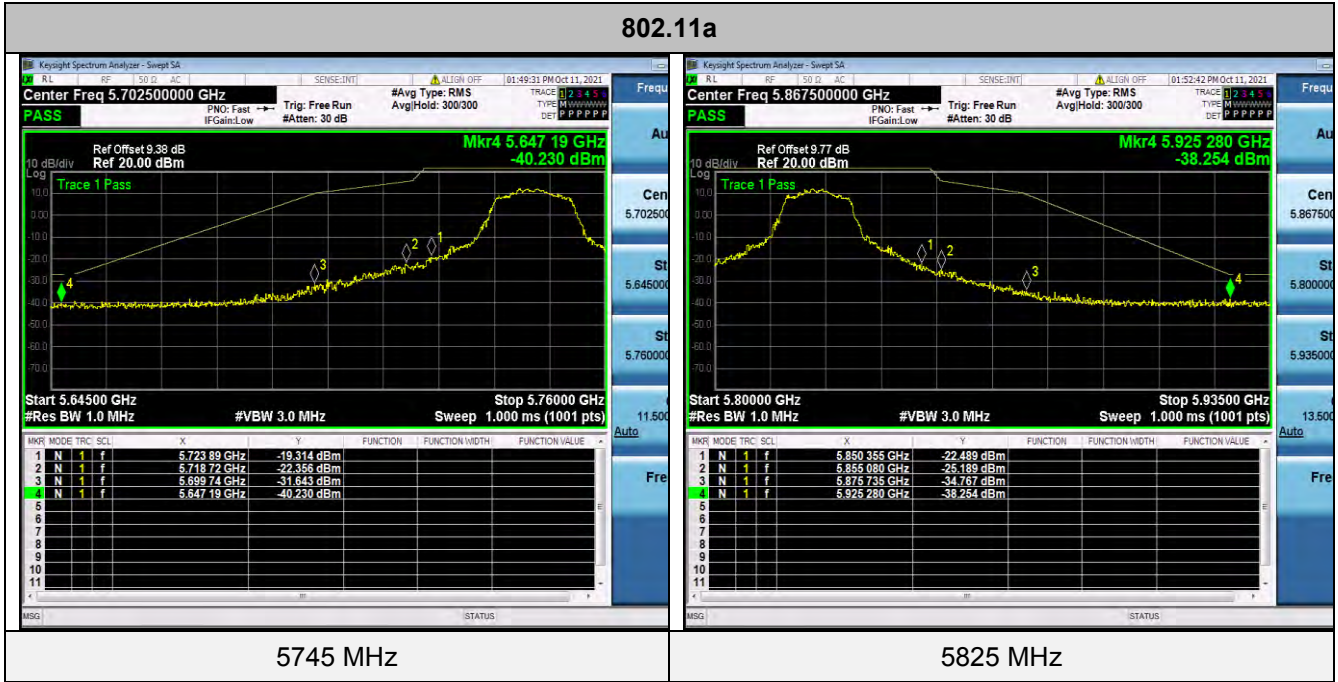

802.11ac20

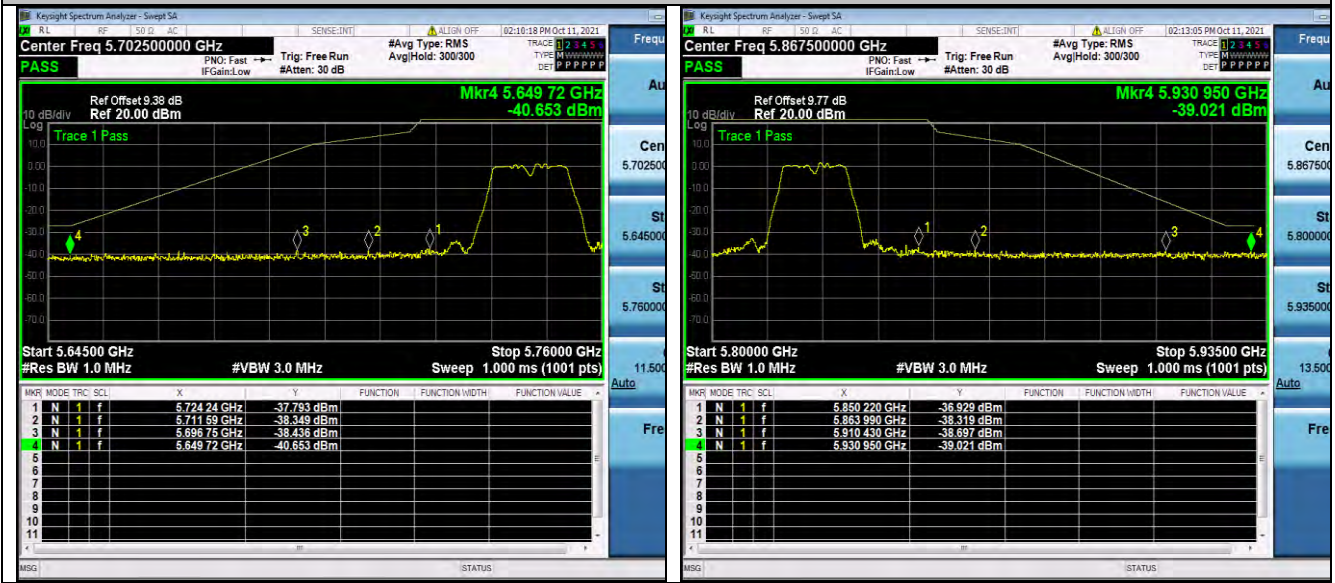

5745 MHz

5825 MHz

802.11n HT40

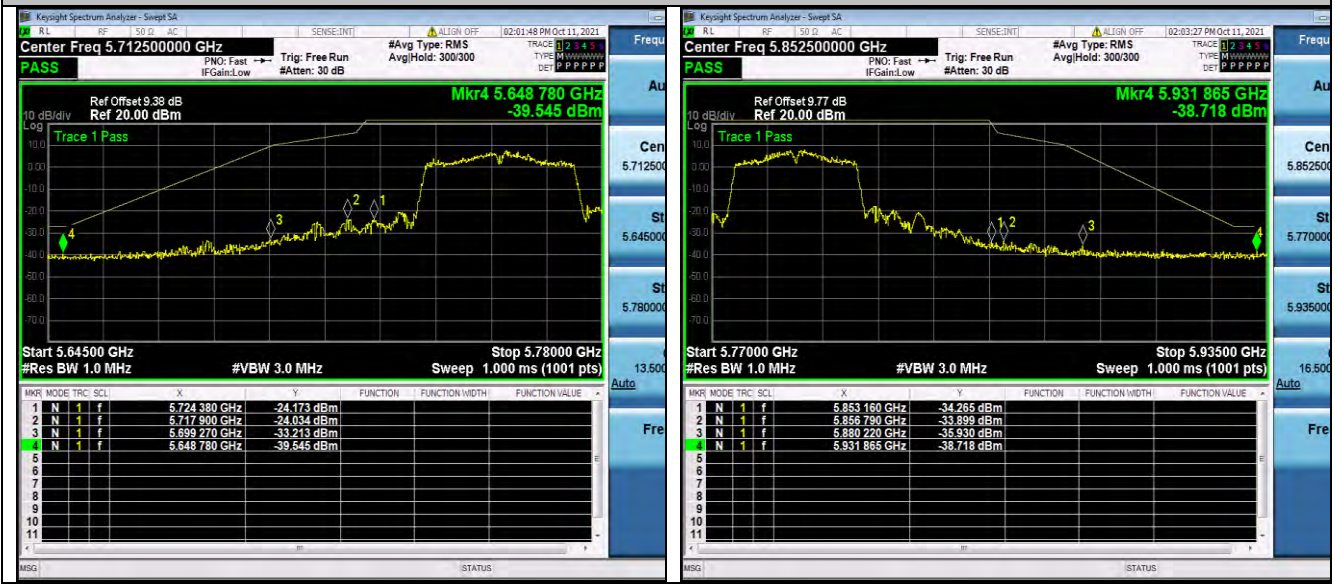

5755 MHz

5795 MHz

802.11ac40

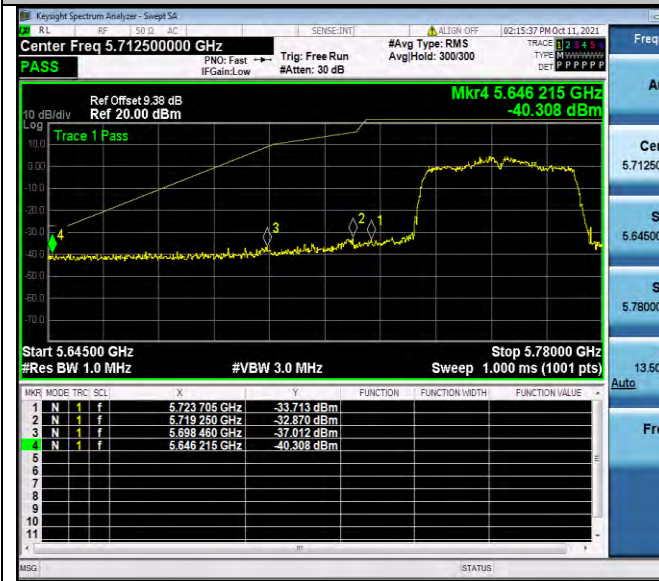

5755 MHz



5795 MHz

802.11ac80

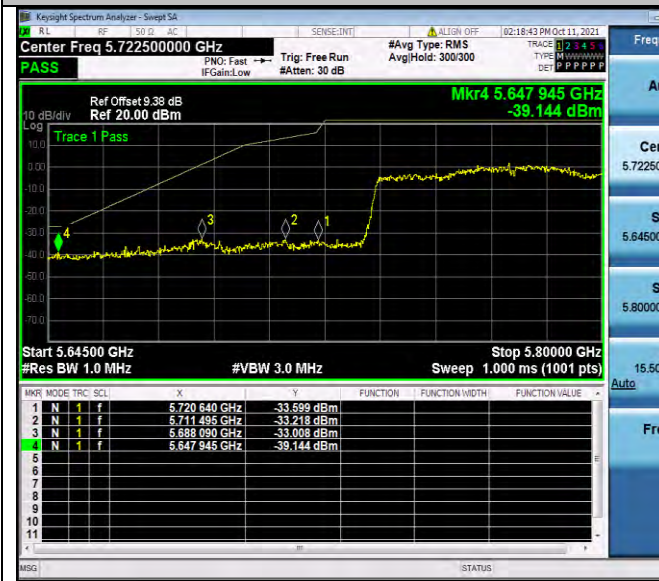

5775 MHz



5795 MHz

4.9. Frequency Stability

Standard Applicable

According to FCC §15.407(g) “Manufacturers of U-NII devices are responsible for ensuring frequency stability such that an emission is maintained within the band of operation under all conditions of normal operation as specified in the user manual.”

According to FCC §2.1055(a) “The frequency stability shall be measured with variation of ambient temperature as follows:”

(1) From -30° to $+50^{\circ}$ centigrade for all equipment except that specified in paragraphs (a) (2) and (3) of this section.

(2) From -20° to $+50^{\circ}$ centigrade for equipment to be licensed for use in the Maritime Services under part 80 of this chapter, except for Class A, B, and S Emergency Position Indicating Radiobeacons (EPIRBS), and equipment to be licensed for use above 952 MHz at operational fixed stations in all services, stations in the Local Television Transmission Service and Point-to-Point Microwave Radio Service under part 21 of this chapter, equipment licensed for use aboard aircraft in the Aviation Services under part 87 of this chapter, and equipment authorized for use in the Family Radio Service under part 95 of this chapter.

(3) From 0° to $+50^{\circ}$ centigrade for equipment to be licensed for use in the Radio Broadcast Services under part 73 of this chapter.

Test Configuration

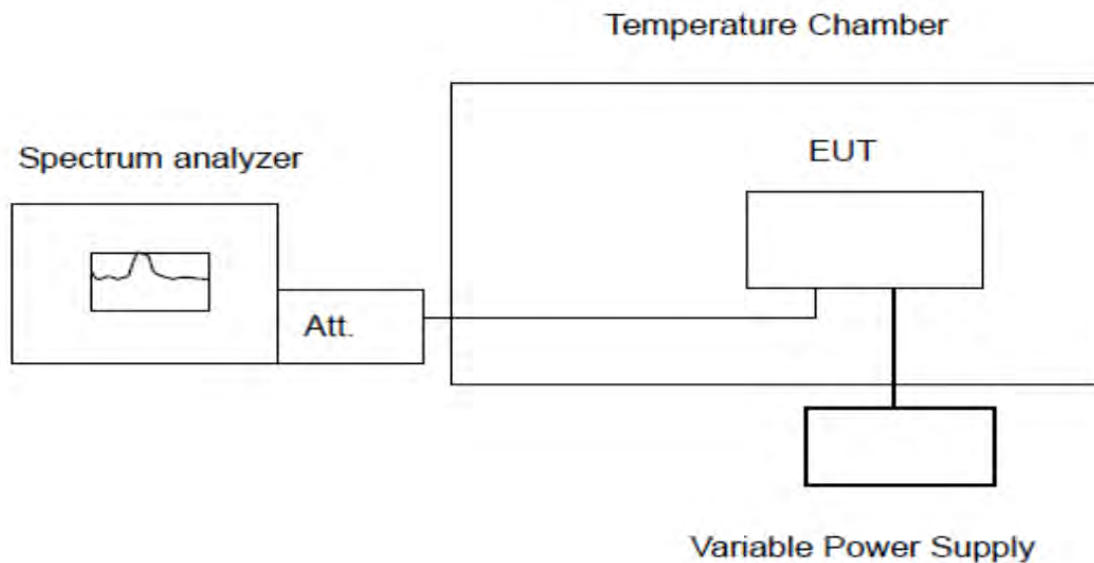

Test Procedure

The equipment under test was connected to an external AC or DC power supply and input rated voltage. RF output was connected to a frequency counter or spectrum analyzer via feed through attenuators. The EUT was placed inside the temperature chamber. Set the spectrum analyzer RBW low enough to obtain the desired frequency resolution and measure EUT 20 degree operating frequency as reference frequency. Turn EUT off and set the chamber temperature to -30 degree. After the temperature stabilized for approximately 30 minutes recorded the frequency. Repeat step measure with 10 degree increased per stage until the highest temperature of $+50$ degree reached.

Test Results

PASS

Remark:

1. Measured all conditions and recorded worst case.

IEEE 802.11a Mode / 5180 – 5240 MHz / 5180 MHz

Environment Temperature (Degree)	Voltage (V)	Measured Frequency (MHz)	Limit Range (MHz)	Test Results
20	DC 5.5V	5180.195693	5150 – 5250	PASS
20	DC 4.5V	5180.530150	5150 – 5250	PASS
50	DC 5.0V	5179.883931	5150 – 5250	PASS
40	DC 5.0V	5179.641408	5150 – 5250	PASS
30	DC 5.0V	5180.134378	5150 – 5250	PASS
20	DC 5.0V	5180.251085	5150 – 5250	PASS
10	DC 5.0V	5180.038418	5150 – 5250	PASS
0	DC 5.0V	5179.696351	5150 – 5250	PASS
-10	DC 5.0V	5179.759218	5150 – 5250	PASS
-20	DC 5.0V	5180.316987	5150 – 5250	PASS
-30	DC 5.0V	5180.298475	5150 – 5250	PASS

IEEE 802.11a Mode / 5180 – 5240 MHz / 5240 MHz

Environment Temperature (Degree)	Voltage (V)	Measured Frequency (MHz)	Limit Range (MHz)	Test Results
20	DC 5.5V	5240.035396	5150 – 5250	PASS
20	DC 4.5V	5240.077458	5150 – 5250	PASS
50	DC 5.0V	5239.668222	5150 – 5250	PASS
40	DC 5.0V	5240.383598	5150 – 5250	PASS
30	DC 5.0V	5240.152240	5150 – 5250	PASS
20	DC 5.0V	5239.654854	5150 – 5250	PASS
10	DC 5.0V	5240.307778	5150 – 5250	PASS
0	DC 5.0V	5240.165186	5150 – 5250	PASS
-10	DC 5.0V	5240.573499	5150 – 5250	PASS
-20	DC 5.0V	5240.229034	5150 – 5250	PASS
-30	DC 5.0V	5240.144267	5150 – 5250	PASS

IEEE 802.11a Mode / 5745 – 5825 MHz / 5745 MHz

Environment Temperature (Degree)	Voltage (V)	Measured Frequency (MHz)	Limit Range (MHz)	Test Results
20	DC 5.5V	5744.908754	5725 – 5850	PASS
20	DC 4.5V	5745.443328	5725 – 5850	PASS
50	DC 5.0V	5745.109912	5725 – 5850	PASS
40	DC 5.0V	5744.739784	5725 – 5850	PASS
30	DC 5.0V	5745.162167	5725 – 5850	PASS
20	DC 5.0V	5744.784359	5725 – 5850	PASS
10	DC 5.0V	5744.610169	5725 – 5850	PASS
0	DC 5.0V	5744.612053	5725 – 5850	PASS
-10	DC 5.0V	5745.125686	5725 – 5850	PASS
-20	DC 5.0V	5744.924334	5725 – 5850	PASS
-30	DC 5.0V	5745.595048	5725 – 5850	PASS

IEEE 802.11a Mode / 5745 – 5825 MHz / 5825 MHz

Environment Temperature (Degree)	Voltage (V)	Measured Frequency (MHz)	Limit Range (MHz)	Test Results
20	DC 5.5V	5825.023902	5725 – 5850	PASS
20	DC 4.5V	5825.331444	5725 – 5850	PASS
50	DC 5.0V	5824.978826	5725 – 5850	PASS
40	DC 5.0V	5825.208745	5725 – 5850	PASS
30	DC 5.0V	5825.212510	5725 – 5850	PASS
20	DC 5.0V	5824.725950	5725 – 5850	PASS
10	DC 5.0V	5824.958198	5725 – 5850	PASS
0	DC 5.0V	5825.043894	5725 – 5850	PASS
-10	DC 5.0V	5824.614831	5725 – 5850	PASS
-20	DC 5.0V	5824.642330	5725 – 5850	PASS
-30	DC 5.0V	5824.825251	5725 – 5850	PASS

4.10. Antenna Requirement

Standard Applicable

For intentional device, according to FCC 47 CFR Section 15.203, an intentional radiator shall be designed to ensure that no antenna other than that furnished by the responsible party shall be used with the device.

And according to FCC 47 CFR Section 15.407 (a), if transmitting antennas of directional gain greater than 6dBi are used, the power shall be reduced by the amount in dB that the directional gain of the antenna exceeds 6dBi.

Antenna Information

The antenna is Internal Aantenna, through the buckle stretched out, The directional gains of antenna used for transmitting is 2.52dBi.

Reference to the Test Report: **GTS20210915006-1-3.**

5. TEST SETUP PHOTOS OF THE EUT

Reference to the test report No. GTS20210915006-1-3.

6. EXTERNAL AND INTERNAL PHOTOS OF THE EUT

Reference to the test report No. GTS20210915006-1-3.

.....**End of Report**.....