

EMC TEST REPORT

Report No.: SET2015-07006

Product: Multifunction Digital Product (Copier/Printer/Scanner)

Model No. : M7208、 M7208W

FCC ID: A5M-MFPM7208W1

Applicant: Lenovo (Beijing) Limited

Issued by: CCIC Southern Electronic Product Testing (Shenzhen) Co., Ltd.

Lab Location: Building 28/29, Shigudong, Xili Industrial Area, Xili Street,
Nanshan District, Shenzhen, Guangdong, China

Tel: 86 755 26627338 **Fax:** 86 755 26627238

This test report consists of **61** pages in total. It may be duplicated completely for legal use with the approval of the applicant. It should not be reproduced except in full, without the written approval of our laboratory. The client should not use it to claim product endorsement by CCIC-SET. The test results in the report only apply to the tested sample. The test report shall be invalid without all the signatures of testing engineers, reviewer and approver. Any objections must be raised to CCIC-SET within 15 days since the date when the report is received. It will not be taken into consideration beyond this limit.

Table of Contents

1 General Information	4
1.1 Description of EUT	4
1.2 EUT Information	4
1.3 Highest Frequency Generated or Used in The Device or on Which the Device Operates	4
2 Test Facilities and Configuration	5
2.1 Environmental Conditions	5
2.2 Measurement Uncertainty	5
2.3 Associated Equipments	5
2.4 Cables Used	5
2.5 Test Configure	6
2.6 Measurement Equipments Used	7
3 Summary of Test Results	8
4 Emission Test	9
4.1 EUT Setup and Operation	9
4.2 Mains Terminal Disturbance Voltage Measurement	10
4.2.1 Limits of Mains Terminal Disturbance Voltage	10
4.2.2 Test Procedure	10
4.2.3 Test Setup	10
4.2.4 Test Result	11
4.3 Radiated Emission Test	24
4.3.1 Limits of Radiated Emission	24
4.3.2 Test Procedure	24
4.3.3 Test Setup	25
4.3.4 Test Results	25
Appendix I: Photographs of the EUT	50
Appendix II: Photographs of EMC Test Configuration	60

1 General Information

1.1 Description of EUT

Product: Multifunction Digital Product(Copier/Printer/Scanner)

Model No.: M7208、M7208W

Brand Name: Lenovo

Serial No.: MF201502077

I/O Ports: USB

Accessories: Power cable ,USB cable

Note:

The EUT is class B information technology equipment according to FCC PART 15. For more detailed features description about the EUT, please refer to User's Manual.

Perform ElectroMagnetic Interference measurement in accordance with FCC 47CFR [Codes of Federal Regulations] Part 15 and ANSI C63.4: 2009 for FCC ID

The EUT have Wifi module, which have finished the FCCID(FCCID code : PPQ-WN4615L).

Short description of the equipment under test (EUT)

The certification machine is a Multifunction Digital Product which has copy, scan and print function.#

Model difference:

The EUT is a Multifunction Digital Product (Copier/Printer/Scanner).

Model/Type : M7208W, M7208

Models difference:

Model Name	Print	Scan	Copy	USB	WiFi
M7208	○	○	○	○	×
M7208W	○	○	○	○	○

Unless otherwise indicated, all tests were conducted on M7208W. Tests performed on M7208W were considered to be representative of M7208.

“×” mean it is not supported and “○” mean it is equipped.

1.2 EUT Information

Kind of equipment	Manufacturer	Model name	Serial number	Remark
Multifunction Digital Product	Lenovo	M7208W	MF201502077	-

1.3 Highest Frequency Generated or Used in The Device or on Which the Device Operates

Kind of equipment	Model name	Operates Frequency	Remark
Multifunction Digital Product	M7208W	480MHz	USB

2 Test Facilities and Configuration

2.1 Environmental Conditions

During the measurement the environmental conditions were within the listed ranges:

- Temperature: 15-35°C
- Humidity: 30-60 %
- Atmospheric pressure: 86-106 kPa

2.2 Measurement Uncertainty

The uncertainty is calculated using the methods suggested in the "Guide to the Expression of Uncertainty in Measurement" (GUM) published by ISO.

- Uncertainty of Conducted Emission, $U_c = \pm 1.8\text{dB}$
- Uncertainty of Radiated Emission, $U_c = \pm 5.0\text{dB}$

2.3 Associated Equipments

Kind of equipment	Manufacturer	Model name	Serial number	Remarks
Notebook	LENOVO	ThinkPad L440	R9-0346Y3 14/07	DoC
Wireless Router	Buffalo	WCR-HP-GN	44061000300952	
Keyboard	DELL	L100	CNORH6566589079K0277	
Mouse	DELL	MOC5UO	H0F02OCQ	

2.4 Cables Used

Item	Cable Name	Length	Shielding	Maker
1	USB Cable	1.2m	YES	Comlink
2	Power Cable	1.5m	No	Voilex

2.5 Test Configure

Operating modes:

No.	Operating modes	Remarks
1	Standby	
2	Copy	
3	USB Print	
4	WiFi Print	
5	USB Scan	
6	WiFi Scan	

EUT Setup

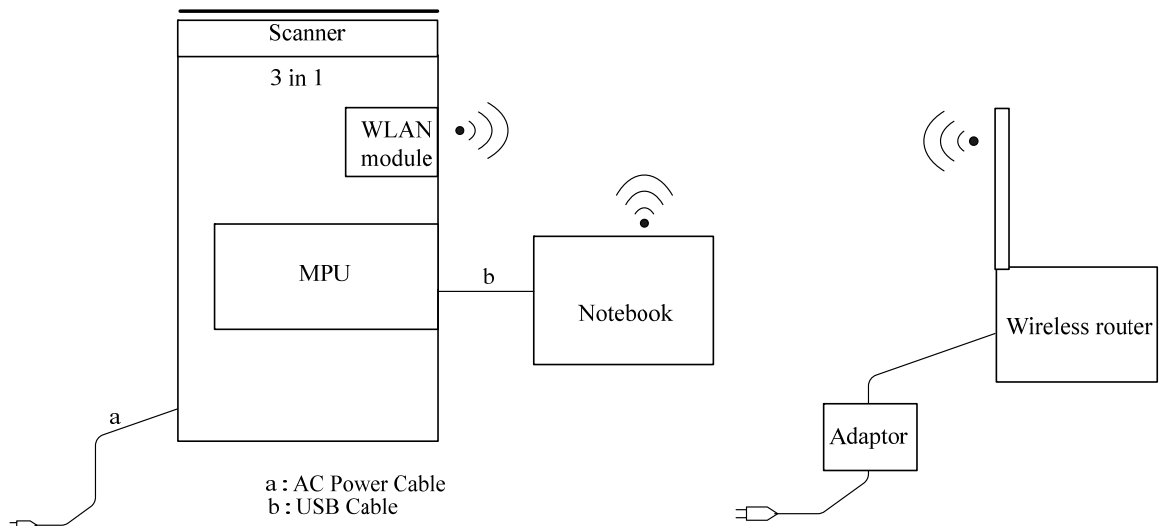

2.6 Measurement Equipments Used

Description	Manufacturer	Model No.	Serial No.	Cal. Date	Cal. Due Date
Test Receiver	ROHDE&SCH WARZ	ESCS30	A0304260	Jun.10, 2014	Jun.10, 2015
LISN	Schwarzbeck	ESH2-Z5	A0304221	Jun.10, 2014	Jun.10, 2015
Shield Room	Nanbo Tech	Site 3	A9901141	Jun.10, 2014	Jun.10, 2015
Horn Ant.	ROHDE&SCH WARZ	HF906	A0304225	Jun.10, 2014	Jun.10, 2015
Anechoic Chamber	Albatross	SAC-10MAC 19.6*11.8*8. 55m	A0802520	Sep.17, 2014	Sep.17, 2015
Test Receiver	ROHDE&SCH WARZ	ESU8	A0805559	Jun.10, 2014	Jun.10, 2015
Ultra-Broadband Ant.	SCHWARZBE CK	VULB 09160	A0805560	Jun.10, 2014	Jun.10, 2015

NOTE: Equipments above have been calibrated and are in the period of validation.

3 Summary of Test Results

The EUT has been tested according to the following specifications:

EMISSION			
Test Condition	Test Requirement	Test Method	Result
Radiated Emissions	FCC 47CFR Part15 SubpartB	ANSI C63.4:2009	PASS
Conducted Emissions on AC, 0.15MHz to 30MHz	FCC 47CFR Part15 SubpartB	ANSI C63.4:2009	PASS

4 Emission Test

4.1 EUT Setup and Operation

The EUT was powered by 120V AC Mains

The EUT continuously operated during the test modes as section 2.5.

The EUT and cables, and operation modes were configured to produce the maximum level of emissions.

4.2 Mains Terminal Disturbance Voltage Measurement

4.2.1 Limits of Mains Terminal Disturbance Voltage

Frequency range (MHz)	Limits (dB μ V), Class B ITE	
	Quasi-peak	Average
0.15-0.5	66 to 56*	56 to 46*
0.5-5.0	56	46
5.0-30.0	60	50

NOTE:

1. The lower limit shall apply at the transition frequencies.
2. The limit decreases linearly with the logarithm of the frequency in the range 0.15MHz to 0.50MHz.

4.2.2 Test Procedure

- a. The EUT was placed 0.4 meters from the conducting wall of shielded room with EUT being connected to the power mains through a line impedance stabilization network (LISN). The LISN provide 50 Ω /50 μ H of coupling impedance for the measuring instrument.
- b. Both lines of the power mains connected to the EUT were checked for maximum conducted interference.
- c. The frequency range from 150 kHz to 30 MHz was searched. Emission levels over 10dB under the prescribed limits are not reported.

4.2.3 Test Setup

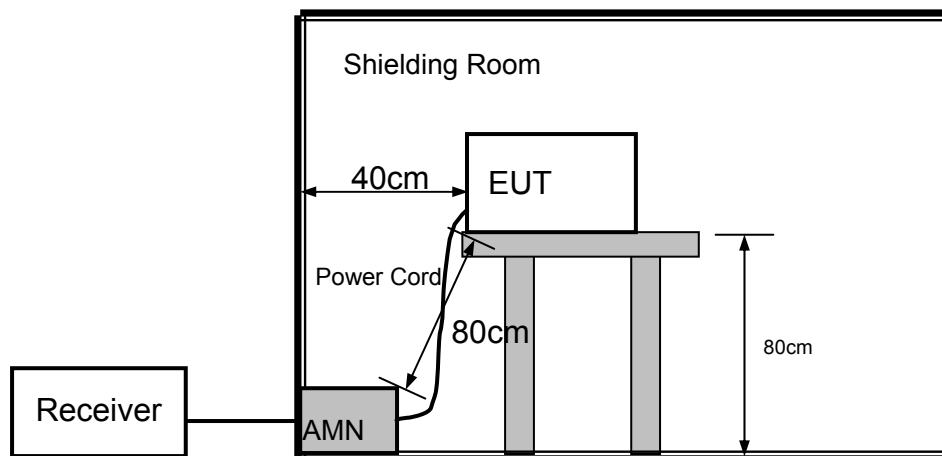

For the actual test configuration, please refer to the related item - Photographs of the Test Configuration.

4.2.4 Test Result

Environment Condition:

Temperature: 23°C; Relative Humidity: 52%; Pressure:101kPa

Test Date: 2015-3-13

Test Engineer: Cheng Weichang

Test Site: Shield Room Site 1

Test Mode: Mode 1-6

1. Conducted Disturbance at Mains Terminals (Standby Mode)

Conducted Disturbance at Mains Terminals (Standby Mode)							
L Test Data							
QP				AV			
Frequency (MHz)	Limits (dB μ V)	Measurement Value(dB μ V)	Margin (dB μ V)	Frequency (MHz)	Limits (dB μ V)	Measurement Value(dB μ V)	Margin (dB μ V)
0.1500	66.0	62.22	3.78	0.1500	56.0	35.46	20.54
0.1860	64.2	55.11	9.09	0.1860	54.2	28.78	25.42
0.8385	56.0	19.30	36.70	0.8385	46.0	13.67	32.33
1.1490	56.0	13.05	42.95	1.1490	46.0	10.48	35.52
1.2615	56.0	17.68	38.32	1.2615	46.0	17.21	28.79
18.2435	60.0	27.67	32.33	18.2435	50.0	21.22	28.78

L Test Curve

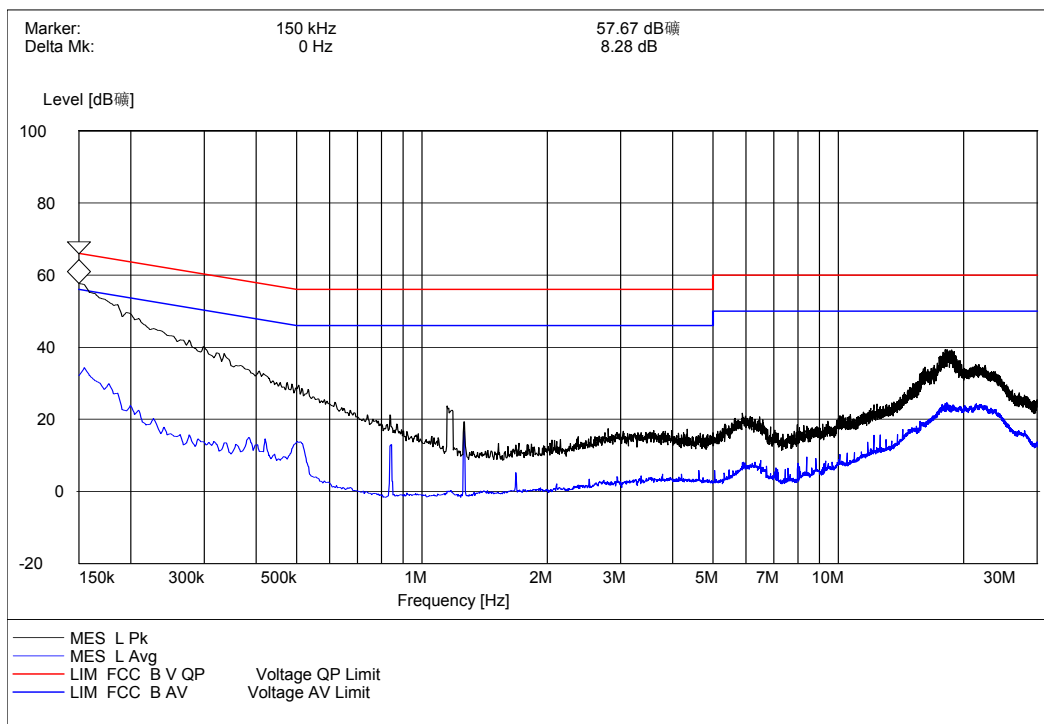

NOTE:

1. The lower limit shall apply at the transition frequencies.
2. The limit decreases linearly with the logarithm of the frequency in the range 0.15MHz to 0.50MHz.
3. The minimum margin value of quasi-peak and average level is over 3dB.

Conducted Disturbance at Mains Terminals (Standby Mode)							
N Test Data							
QP				AV			
Frequency (MHz)	Limits (dBμV)	Measurement Value(dBμV)	Margin (dBμV)	Frequency (MHz)	Limits (dBμV)	Measurement Value(dBμV)	Margin (dBμV)
0.1500	66.0	62.71	3.29	0.1500	56.0	36.46	19.54
0.1815	64.4	56.30	8.10	0.1815	54.4	31.62	22.78
0.2130	63.1	50.80	12.30	0.2130	53.1	24.31	28.79
0.2670	61.2	45.12	16.08	0.2670	51.2	18.24	32.96
13.5174	60.0	19.46	40.54	13.5174	50.0	13.36	36.64
18.4370	60.0	34.49	25.51	18.4370	50.0	25.64	24.36

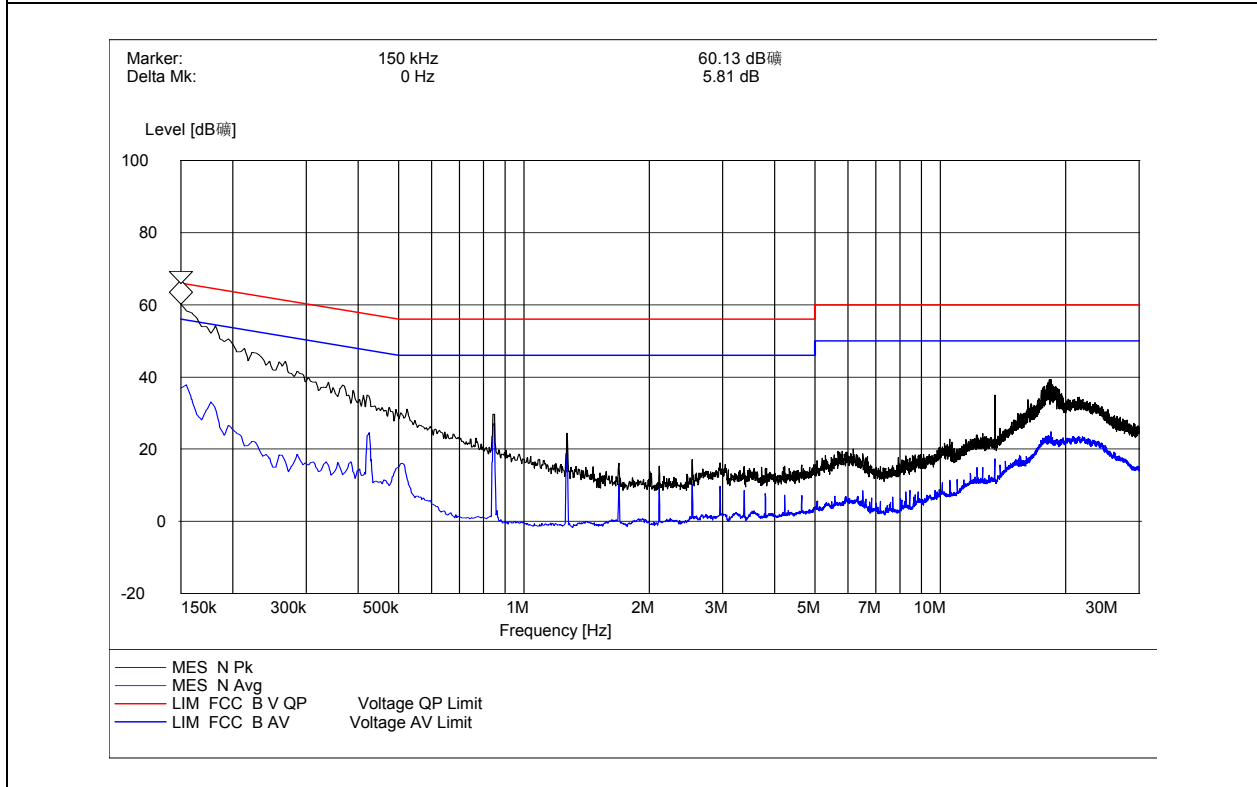

NOTE:

1. The lower limit shall apply at the transition frequencies.
2. The limit decreases linearly with the logarithm of the frequency in the range 0.15MHz to 0.50MHz.
3. The minimum margin value of quasi-peak and average level is over 3dB.

2. Conducted Disturbance at Mains Terminals (Copy Mode)

Conducted Disturbance at Mains Terminals (Copy Mode)							
L Test Data							
QP				AV			
Frequency (MHz)	Limits (dB μ V)	Measurement Value (dB μ V)	Margin (dB μ V)	Frequency (MHz)	Limits (dB μ V)	Measurement Value (dB μ V)	Margin (dB μ V)
0.1500	66.0	61.94	4.06	0.1500	56.0	40.01	15.99
0.1680	65.1	60.60	4.50	0.1680	55.1	38.46	16.64
0.1770	64.6	54.72	9.88	0.1770	54.6	35.76	18.84
0.3075	60.0	39.74	20.26	0.3075	50.0	22.22	27.78
22.1945	60.0	30.32	29.68	22.1945	50.0	24.34	25.66
29.7275	60.0	28.48	31.52	29.7275	50.0	22.72	27.28

L Test Curve

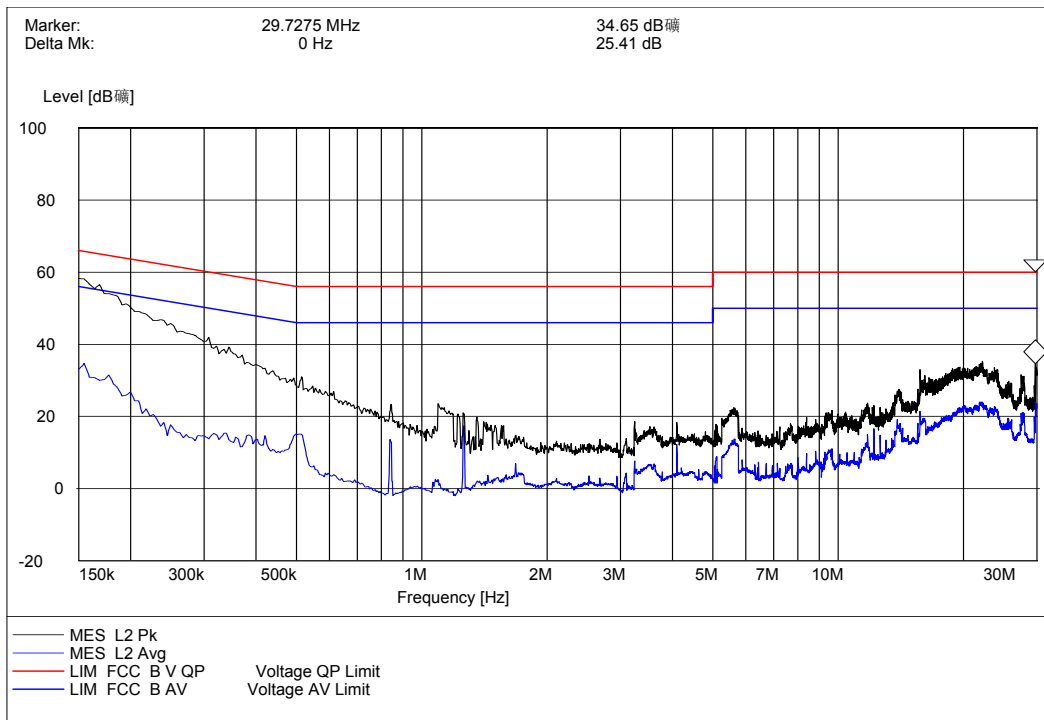

NOTE:

1. The lower limit shall apply at the transition frequencies.
2. The limit decreases linearly with the logarithm of the frequency in the range 0.15MHz to 0.50MHz.
3. The minimum margin value of quasi-peak and average level is over 3dB.

Conducted Disturbance at Mains Terminals (Copy Mode)

N Test Data

QP				AV			
Frequency (MHz)	Limits (dBμV)	Measurement Value(dB μV)	Margin (dBμV)	Frequency (MHz)	Limits (dBμV)	Measurement Value(dB μV)	Margin (dBμV)
0.1500	66.0	61.50	4.50	0.1500	56.0	40.75	15.25
0.1590	65.5	58.65	6.85	0.1590	55.5	36.52	18.98
0.1815	64.4	53.98	10.42	0.1815	54.4	34.09	20.31
0.5010	56.0	31.55	24.45	0.5010	46.0	23.63	22.37
23.2925	60.0	28.76	31.24	23.2925	50.0	23.06	26.94
29.0795	60.0	29.75	30.25	29.0795	50.0	23.84	26.16

N Test Curve

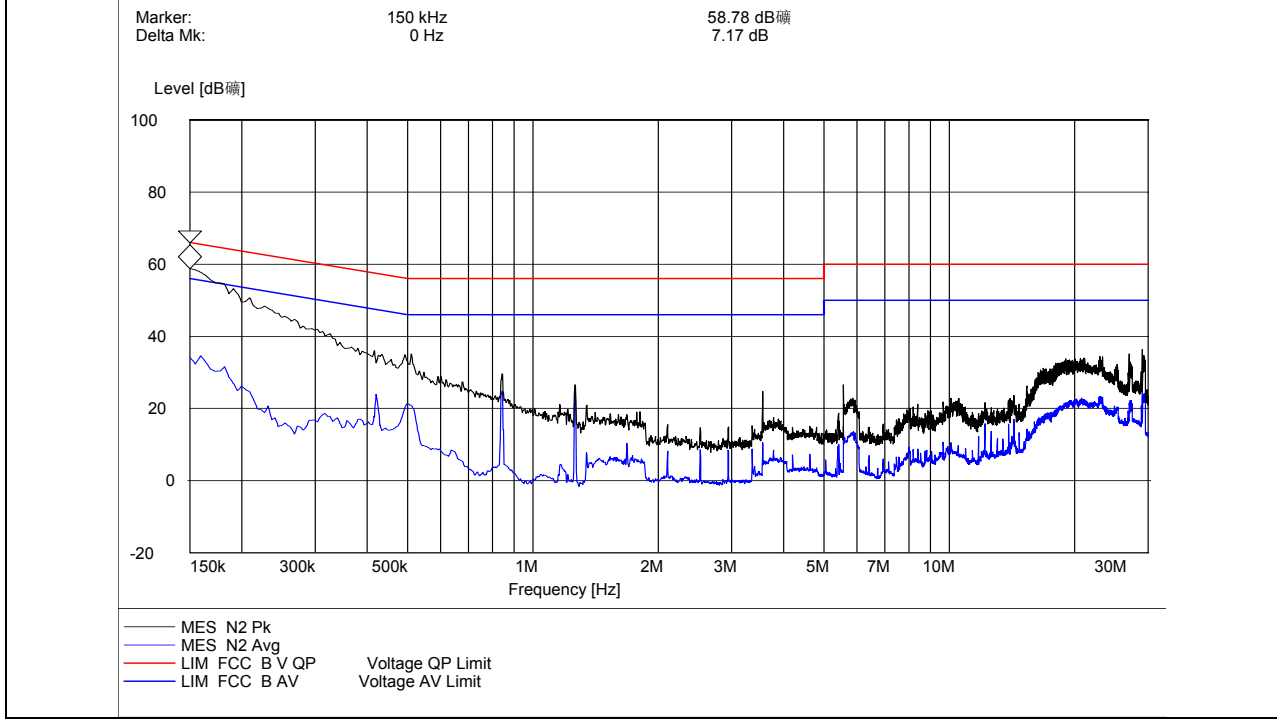

NOTE:

1. The lower limit shall apply at the transition frequencies.
2. The limit decreases linearly with the logarithm of the frequency in the range 0.15MHz to 0.50MHz.
3. The minimum margin value of quasi-peak and average level is over 3dB.

3. Conducted Disturbance at Mains Terminals (USB PRINT Mode)

Conducted Disturbance at Mains Terminals (USB Print Mode)							
L Test Data							
QP				AV			
Frequency (MHz)	Limits (dBμV)	Measurement Value (dBμV)	Margin (dBμV)	Frequency (MHz)	Limits (dBμV)	Measurement Value (dBμV)	Margin (dBμV)
0.1500	66.0	60.12	5.88	0.1500	56.0	38.60	17.40
0.1725	64.8	55.65	9.15	0.1725	54.8	33.19	21.61
0.2040	63.4	50.35	13.05	0.2040	53.4	31.10	22.30
0.2355	62.3	46.30	16.00	0.2355	52.3	30.75	21.55
0.4515	56.8	40.98	15.82	0.4515	46.8	31.63	15.17
22.6220	60.0	30.21	29.79	22.6220	50.0	24.57	25.43

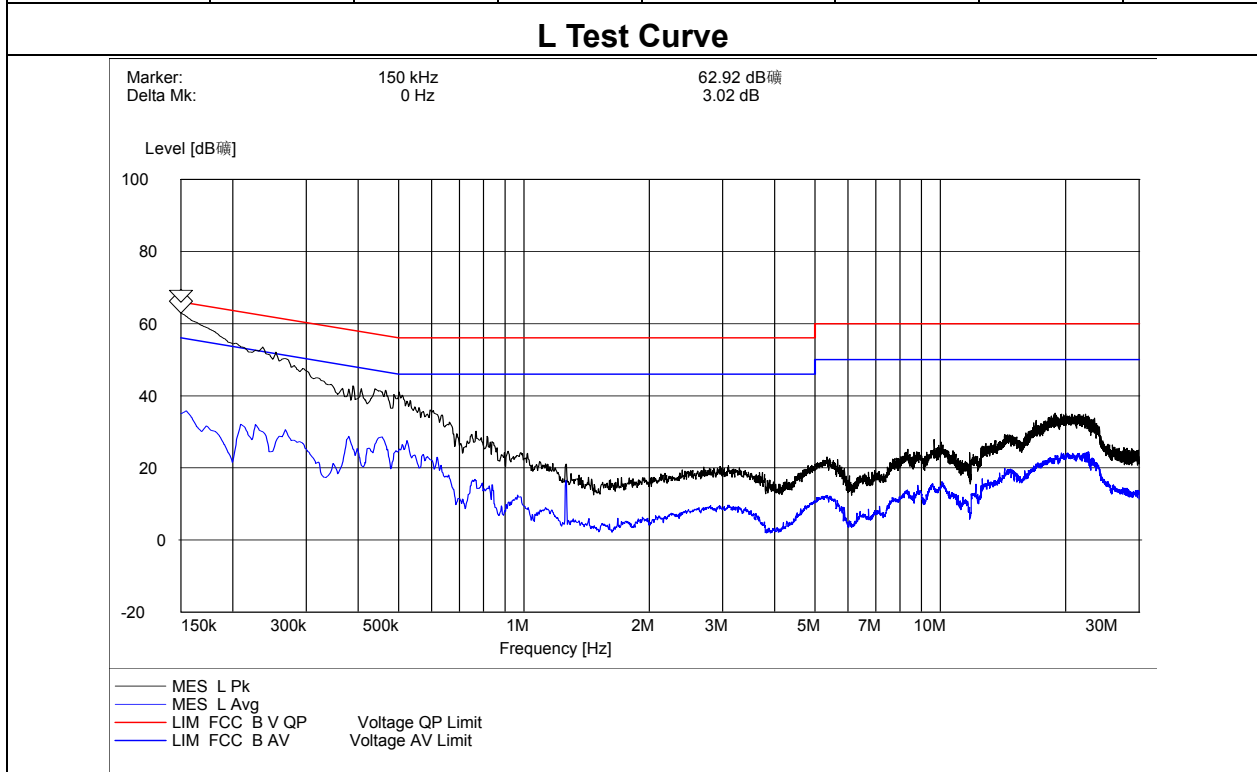

NOTE:

1. The lower limit shall apply at the transition frequencies.
2. The limit decreases linearly with the logarithm of the frequency in the range 0.15MHz to 0.50MHz.
3. The minimum margin value of quasi-peak and average level is over 3dB.

Conducted Disturbance at Mains Terminals (USB Print Mode)

N Test Data

QP				AV			
Frequency (MHz)	Limits (dBμV)	Measurement Value(dBμV)	Margin (dBμV)	Frequency (MHz)	Limits (dBμV)	Measurement Value(dBμV)	Margin (dBμV)
0.1500	66.0	60.19	5.81	0.1500	56.0	37.52	18.48
0.1680	65.1	56.49	8.61	0.1680	55.1	33.91	21.19
0.2265	62.6	47.66	14.94	0.2265	52.6	32.76	19.84
0.2940	60.4	42.50	17.90	0.2940	50.4	30.69	19.71
0.4470	56.9	42.03	14.87	0.4470	46.9	31.58	15.32
0.5055	56.0	39.77	16.23	0.5055	46.0	30.70	15.30

N Test Curve

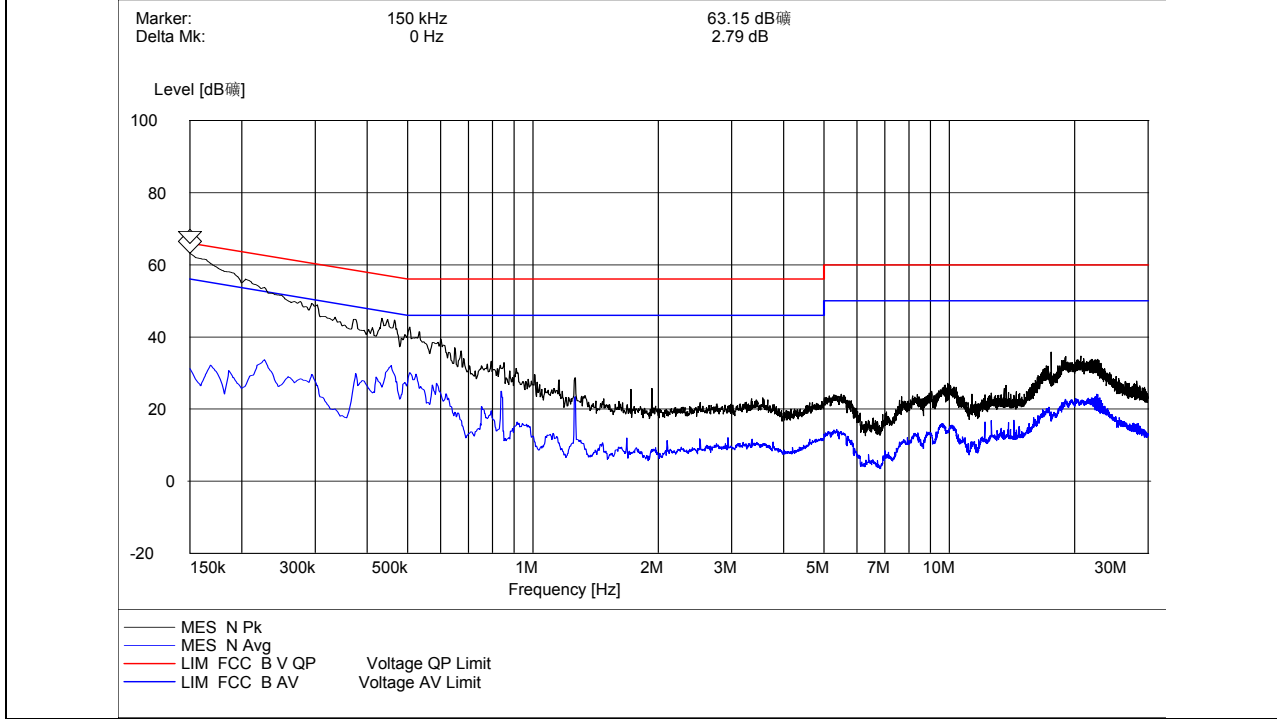

NOTE:

1. The lower limit shall apply at the transition frequencies.
2. The limit decreases linearly with the logarithm of the frequency in the range 0.15MHz to 0.50MHz.
3. The minimum margin value of quasi-peak and average level is over 3dB.

4. Conducted Disturbance at Mains Terminals (Wifi Print Mode)

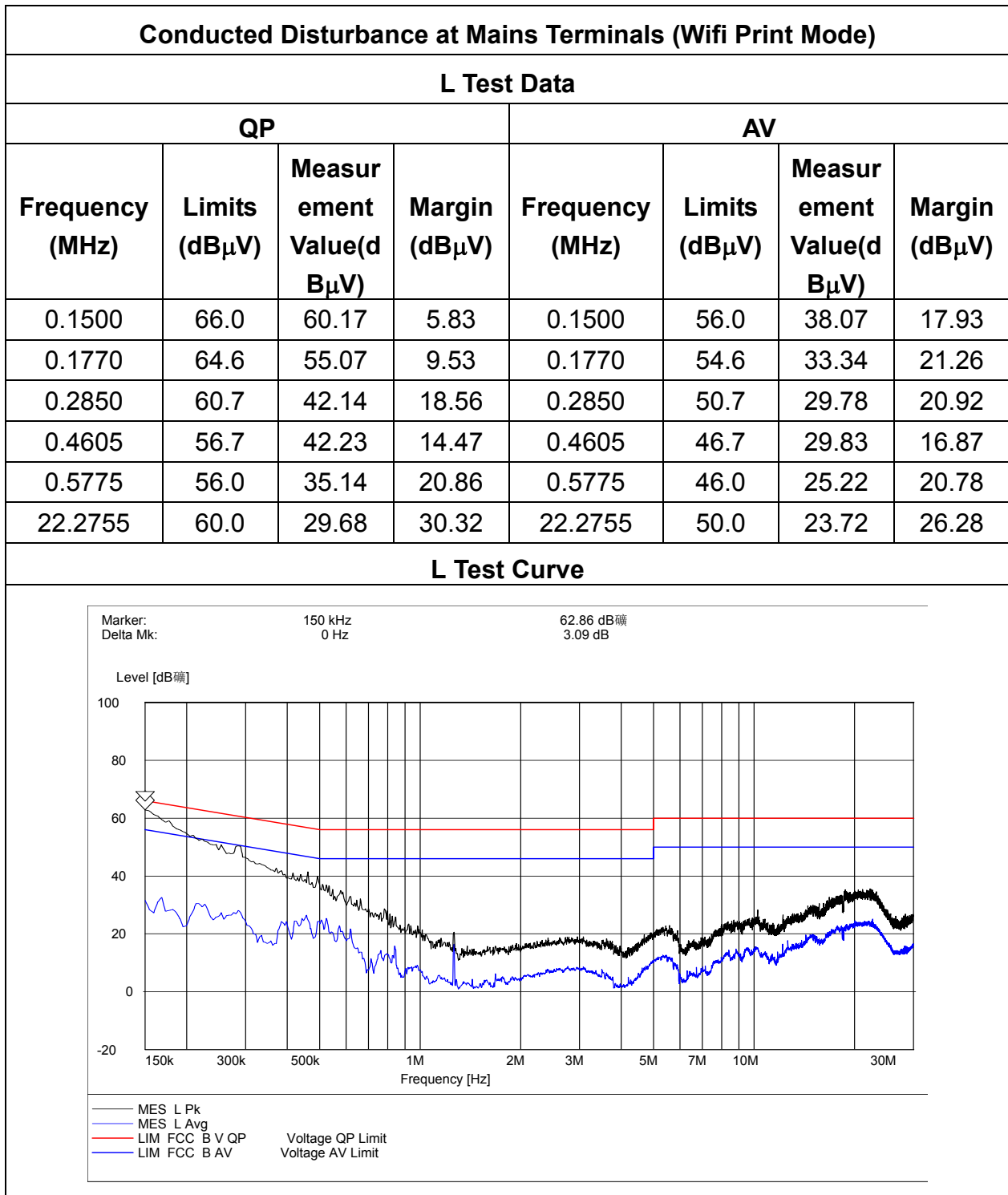

NOTE:

1. The lower limit shall apply at the transition frequencies.
2. The limit decreases linearly with the logarithm of the frequency in the range 0.15MHz to 0.50MHz.
3. The minimum margin value of quasi-peak and average level is over 3dB.

Conducted Disturbance at Mains Terminals (Wifi Print Mode)

N Test Data

QP				AV			
Frequency (MHz)	Limits (dBμV)	Measurement Value (dBμV)	Margin (dBμV)	Frequency (MHz)	Limits (dBμV)	Measurement Value (dBμV)	Margin (dBμV)
0.1500	66.0	60.49	5.51	0.1500	56.0	39.84	16.16
0.1635	65.3	57.47	7.83	0.1635	55.3	33.84	21.46
0.2625	61.4	44.76	16.64	0.2625	51.4	28.16	23.24
0.5235	56.0	35.17	20.83	0.5235	46.0	28.04	17.96
0.8430	56.0	25.80	30.20	0.8430	46.0	23.46	22.54
22.7120	60.0	30.90	29.10	22.7120	50.0	24.91	25.09

N Test Curve

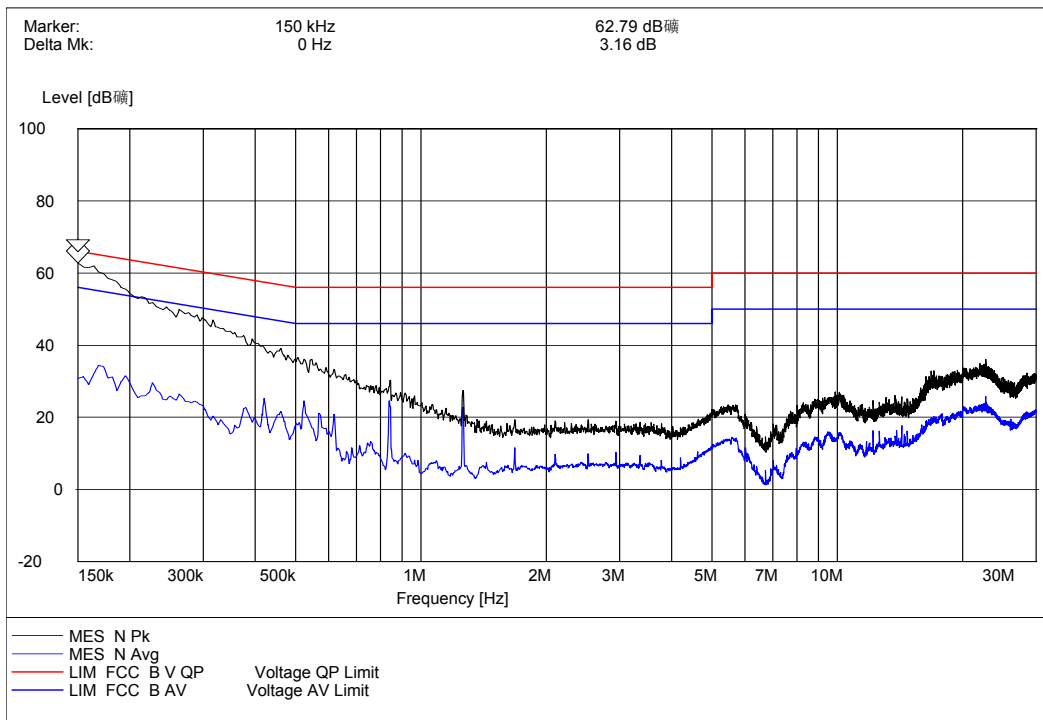

NOTE:

1. The lower limit shall apply at the transition frequencies.
2. The limit decreases linearly with the logarithm of the frequency in the range 0.15MHz to 0.50MHz.
3. The minimum margin value of quasi-peak and average level is over 3dB.

5. Conducted Disturbance at Mains Terminals (USB Scan Mode)

Conducted Disturbance at Mains Terminals (USB Scan Mode)							
L Test Data							
QP				AV			
Frequency (MHz)	Limits (dB μ V)	Measurement Value (dB μ V)	Margin (dB μ V)	Frequency (MHz)	Limits (dB μ V)	Measurement Value (dB μ V)	Margin (dB μ V)
0.1500	66.0	61.67	4.33	0.1500	56.0	34.73	21.27
0.1815	64.4	55.48	8.92	0.1815	54.4	31.92	22.48
0.2085	63.3	47.70	15.60	0.2085	53.3	25.49	27.81
0.5055	56.0	29.42	26.58	0.5055	46.0	20.68	25.32
1.2570	56.0	19.36	36.64	1.2570	46.0	18.68	27.32
19.4900	60.0	30.03	29.97	19.4900	50.0	24.14	25.86

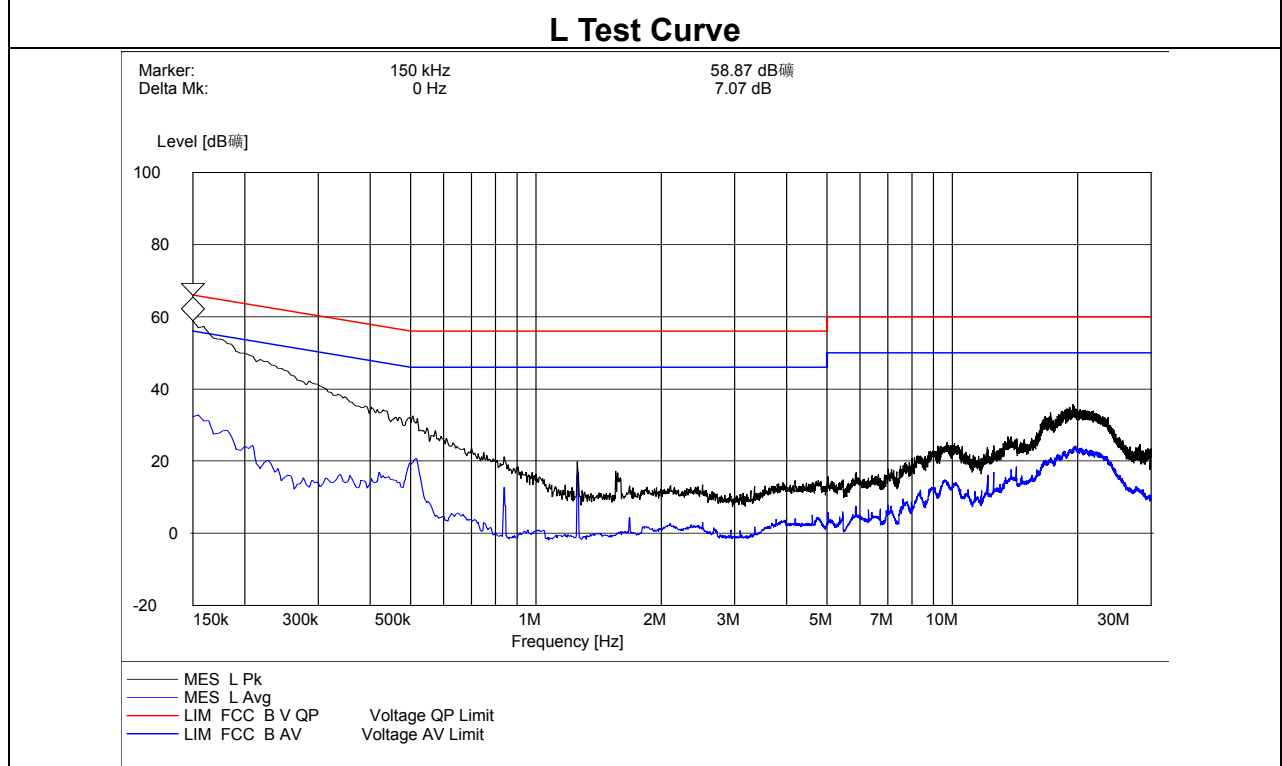

NOTE:

1. The lower limit shall apply at the transition frequencies.
2. The limit decreases linearly with the logarithm of the frequency in the range 0.15MHz to 0.50MHz.
3. The minimum margin value of quasi-peak and average level is over 3dB.

Conducted Disturbance at Mains Terminals (USB Scan Mode)							
N Test Data							
QP				AV			
Frequency (MHz)	Limits (dB μ V)	Measurement Value (dB μ V)	Margin (dB μ V)	Frequency (MHz)	Limits (dB μ V)	Measurement Value (dB μ V)	Margin (dB μ V)
0.1500	66.0	61.56	4.44	0.1500	56.0	35.67	20.33
0.1815	64.4	51.76	12.64	0.1815	54.4	31.70	22.70
0.2085	63.3	47.55	15.75	0.2085	53.3	26.28	27.02
0.4200	57.4	33.16	24.24	0.4200	47.4	25.42	21.98
0.5100	56.0	31.09	24.91	0.5100	46.0	23.50	22.50
19.7195	60.0	29.57	30.43	19.7195	50.0	24.10	25.90

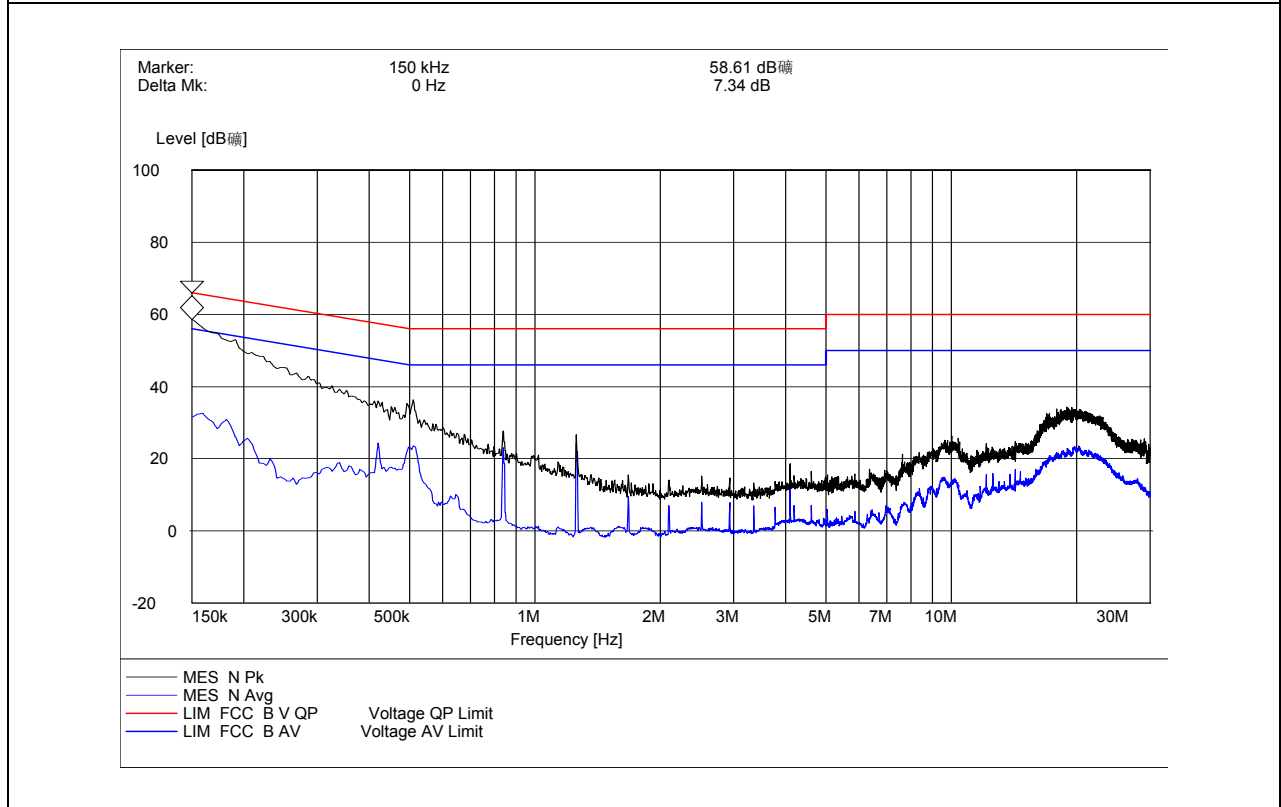

NOTE:

1. The lower limit shall apply at the transition frequencies.
2. The limit decreases linearly with the logarithm of the frequency in the range 0.15MHz to 0.50MHz.
3. The minimum margin value of quasi-peak and average level is over 3dB.

6. Conducted Disturbance at Mains Terminals (Wifi Scan Mode)

Conducted Disturbance at Mains Terminals (Wifi Scan Mode)							
L Test Data							
QP				AV			
Frequency (MHz)	Limits (dB μ V)	Measurement Value (dB μ V)	Margin (dB μ V)	Frequency (MHz)	Limits (dB μ V)	Measurement Value (dB μ V)	Margin (dB μ V)
0.1500	66.0	61.51	4.49	0.1500	56.0	35.91	20.09
0.1815	64.4	45.73	18.67	0.1815	54.4	29.24	25.16
0.2040	63.4	43.26	20.14	0.2040	53.4	24.62	28.78
0.4965	56.1	32.36	23.74	0.4965	46.1	25.32	20.78
0.8385	56.0	26.41	29.59	0.8385	46.0	25.40	20.60
19.7195	60.0	30.80	29.20	19.7195	50.0	24.31	25.69

L Test Curve

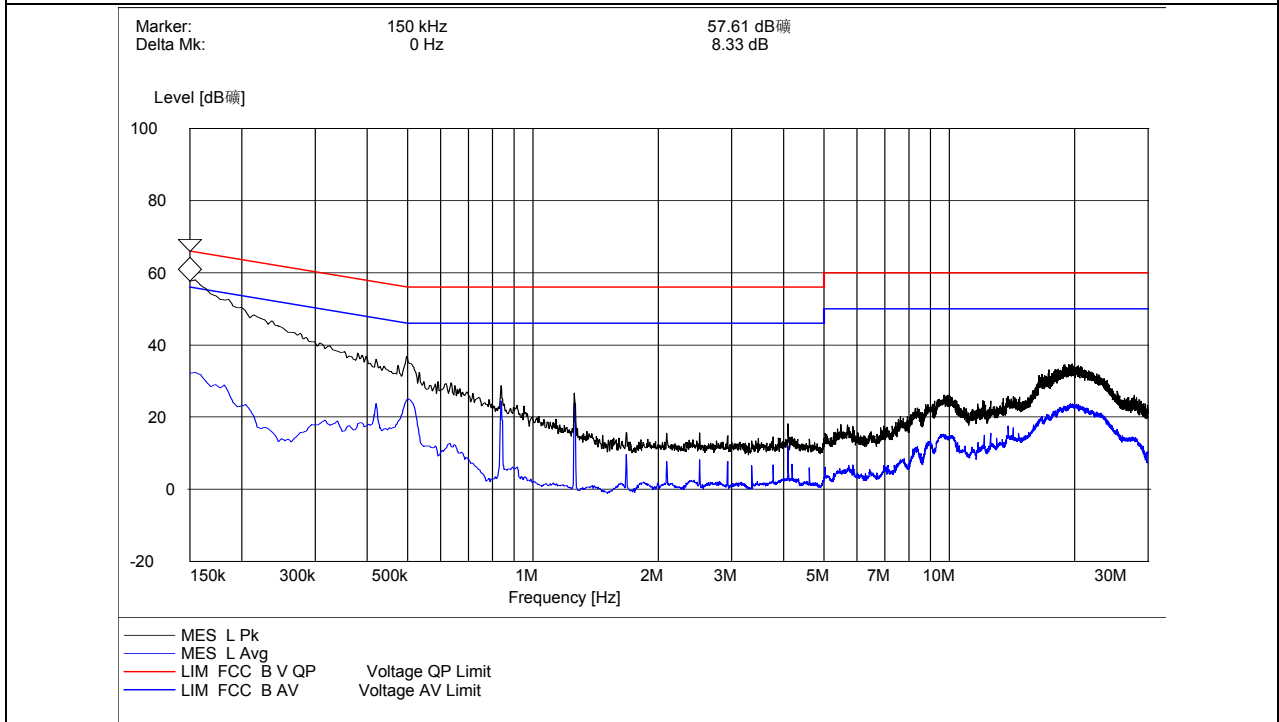

NOTE:

1. The lower limit shall apply at the transition frequencies.
2. The limit decreases linearly with the logarithm of the frequency in the range 0.15MHz to 0.50MHz.
3. The minimum margin value of quasi-peak and average level is over 3dB.

Conducted Disturbance at Mains Terminals (Wifi Scan Mode)							
N Test Data							
QP				AV			
Frequency (MHz)	Limits (dB μ V)	Measurement Value(dB μ V)	Margin (dB μ V)	Frequency (MHz)	Limits (dB μ V)	Measurement Value(dB μ V)	Margin (dB μ V)
0.1500	66.0	58.99	7.01	0.1500	56.0	35.67	20.33
0.1590	65.5	56.57	8.93	0.1590	55.5	35.47	20.03
0.1770	64.6	52.86	11.74	0.1770	54.6	32.83	21.77
0.3390	59.2	35.85	23.35	0.3390	49.2	24.07	25.13
0.4290	57.3	33.30	24.00	0.4290	47.3	24.80	22.50
0.4965	56.1	37.55	18.55	0.4965	46.1	30.57	15.53

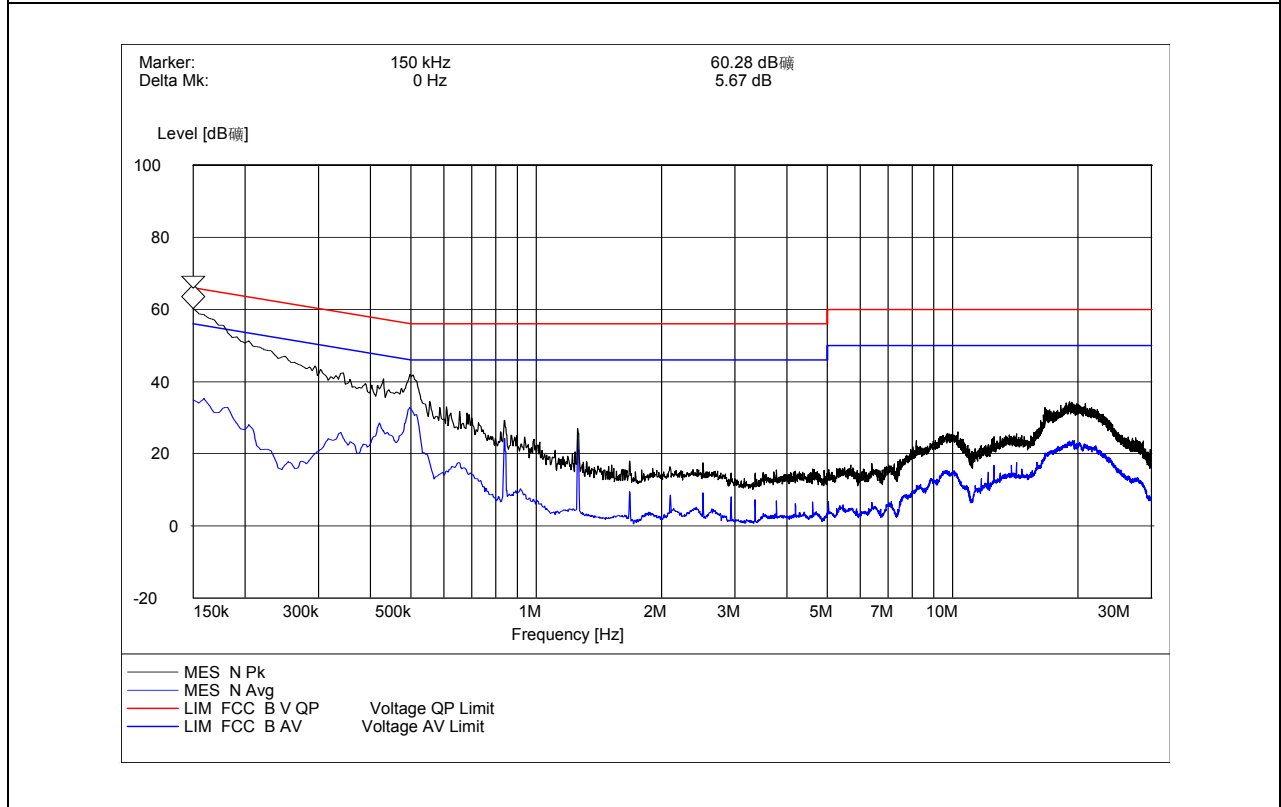

NOTE:

1. The lower limit shall apply at the transition frequencies.
2. The limit decreases linearly with the logarithm of the frequency in the range 0.15MHz to 0.50MHz.
3. The minimum margin value of quasi-peak and average level is over 3dB.

4.3 Radiated Emission Test

4.3.1 Limits of Radiated Emission

The field strength of radiated emissions from unintentional radiators at a distance of 3 meters shall not exceed the following values:

Frequency of Emission (MHz)	Field Strength (dB μ V/m) at 3m
30 - 88	40(QP)
88 -216	43.5(QP)
216 - 960	46.4(QP)
960-1000	54(QP)
Above 1000MHz	54(AV)/74(PK)

NOTE:

1. Field Strength (dB μ V/m)=20log Field Strength (μ V/m).
2. In the emission tables above, the tighter limit applies at the band edges.

4.3.2 Test Procedure

- a. The EUT was set 3 meters away from the interference-receiving antenna, which was mounted on the top of a variable-height antenna tower.
- b. The antenna is a broadband antenna, and its height is varied from one meter to four meter above the ground to determine the maximum value of the field strength. Both horizontal and vertical polarizations of the antenna are set to make the measurement.
- c. For each suspected emission, the EUT was arranged to its worst case and then the antenna was tuned to the heights from 1 to 4 meters and the ratable table was turned from 0 degrees to 360 degrees to find the maximum reading.
- d. The test-receiver system was set to Peak Detector Function and Specified Bandwidth with Maximum Hold Mode.
- e. If the emission level of the EUT in peak mode was 10 dB lower than the limit specified, then testing could be stopped and the peak values of the EUT would be reported. Otherwise the emission that did not have 10 dB margins would be retested one by one using the quasi-peak method.

4.3.3 Test Setup

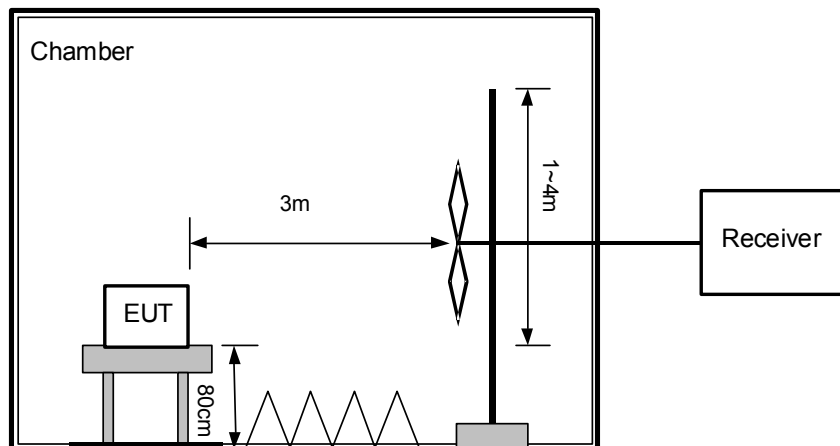
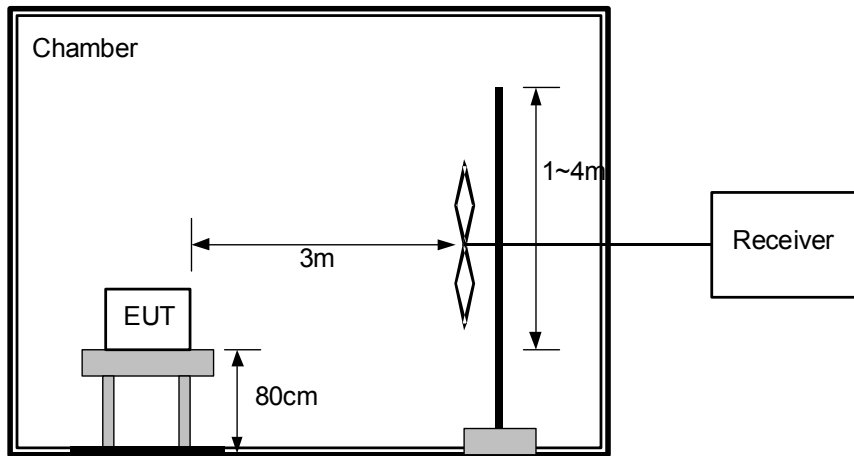

Note: The highest frequency of the internal sources of the EUT is 480 MHz, the measurement was made up to 2 GHz.

4.3.4 Test Results

Environment Condition:

Temperature: 23°C; Relative Humidity: 52%; Pressure:101kPa

Test Date: 2015-03-03, 2015-03-10, 2015-03-18

Test Engineer: Chen Weixiong

Test Site: 10m Anechoic Chamber

Test Mode: Mode 1-6

1. Radiated Emission Test data (Standby Mode)

-Horizontal

Frequency (MHz)	QuasiPeak (dB μ V/m)	Bandwidth (kHz)	Antenna height (cm)	Polarity	Turntable position (deg)	Corr. (dB)	Margin (dB)	Limit (dB μ V/m)
199.640000	32.2	120.000	100.0	H	234.0	-16.0	11.3	43.5
245.320000	31.0	120.000	100.0	H	226.0	-13.7	15.0	46.0
390.640000	22.3	120.000	300.0	H	86.0	-9.9	23.7	46.0
599.640000	26.0	120.000	300.0	H	298.0	-6.1	20.0	46.0
719.640000	29.3	120.000	300.0	H	93.0	-4.2	16.7	46.0
833.400000	19.8	120.000	300.0	H	0.0	-2.2	26.2	46.0

Frequency (MHz)	Peak (dB μ V/m)	Peak limit (dB μ V/m)	Peak Margin (dB)	Turntable position (deg)	Ant. height (cm)	Polarity
1001.6000	41.80	74.0	32.20	0.0	155.0	H
1070.0000	38.30	74.0	35.70	0.0	155.0	H
1184.8000	42.50	74.0	31.50	0.0	155.0	H
1407.2000	44.30	74.0	29.70	0.0	155.0	H
1595.6000	43.60	74.0	30.40	0.0	155.0	H
1939.2000	58.10	74.0	15.90	0.0	155.0	H

Frequency (MHz)	Average dB μ V/m	Average limit (dB μ V/m)	Average Margin (dB)	Turntable position (deg)	Ant. height (cm)	Polarity
1001.6000	27.30	54.0	26.70	0.0	155.0	H
1070.0000	25.00	54.0	29.00	0.0	155.0	H
1184.8000	26.50	54.0	27.50	0.0	155.0	H
1407.2000	28.30	54.0	25.70	0.0	155.0	H
1595.6000	29.10	54.0	24.90	0.0	155.0	H
1939.2000	36.90	54.0	17.10	0.0	155.0	H

NOTE:

The minimum margin value is over 4dB.

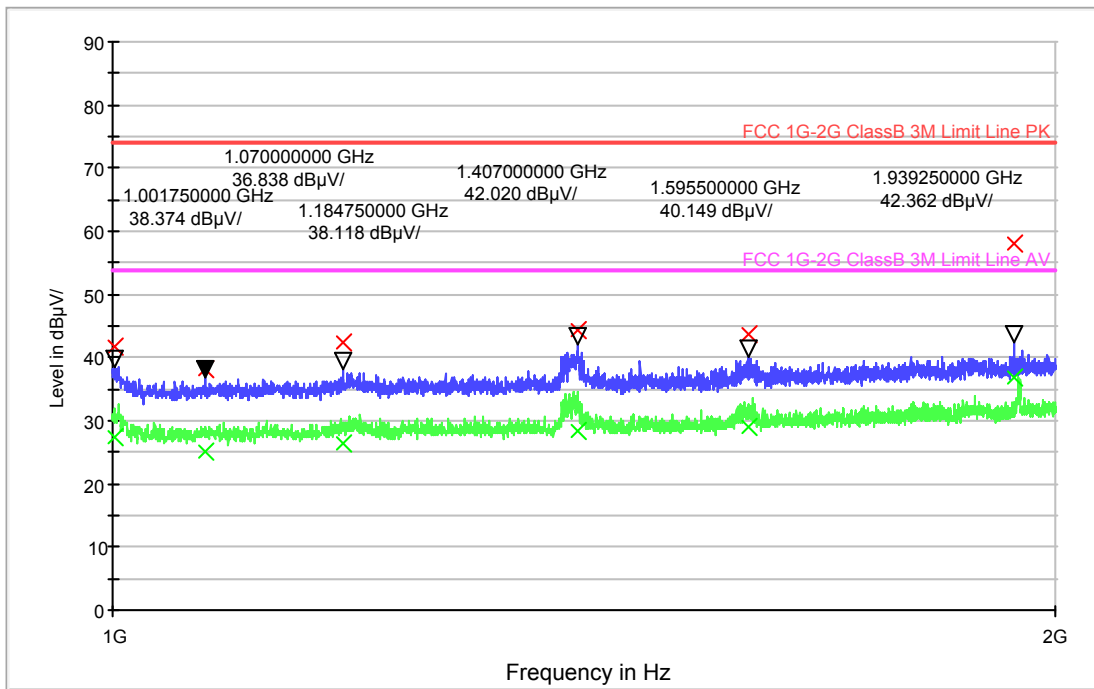
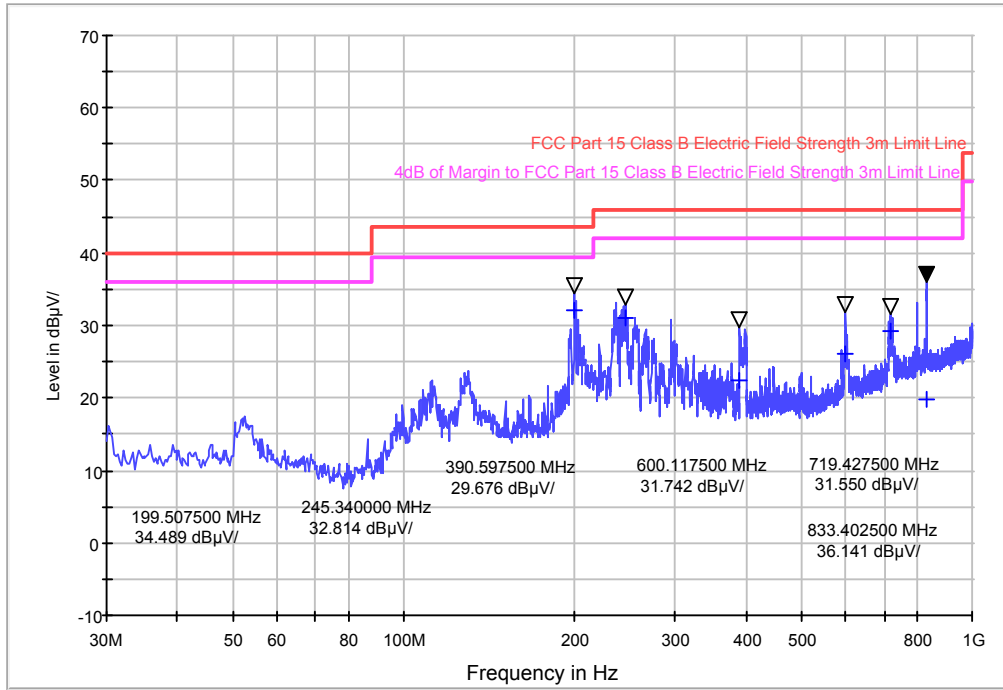

-Vertical

Frequency (MHz)	QuasiPeak (dB μ V/m)	Bandwidth (kHz)	Antenna height (cm)	Polarity	Turntable position (deg)	Corr. (dB)	Margin (dB)	Limit (dB μ V/m)
51.880000	21.1	120.000	100.0	V	158.0	-15.6	18.9	40.0
129.480000	19.8	120.000	100.0	V	300.0	-14.6	23.7	43.5
200.040000	24.6	120.000	100.0	V	204.0	-16.1	18.9	43.5
400.000000	24.0	120.000	100.0	V	0.0	-9.7	22.0	46.0
597.000000	28.3	120.000	100.0	V	13.0	-6.2	17.7	46.0
800.000000	31.5	120.000	100.0	V	0.0	-2.6	14.5	46.0

Frequency (MHz)	Peak (dB μ V/m)	Peak limit (dB μ V/m)	Peak Margin (dB)	Turntable position (deg)	Ant. height (cm)	Polarity
1004.0000	41.90	74.0	32.10	0.0	155.0	V
1199.2000	45.20	74.0	28.80	0.0	155.0	V
1400.4000	43.30	74.0	30.70	0.0	155.0	V
1598.4000	49.00	74.0	25.00	0.0	155.0	V
1804.4000	43.70	74.0	30.30	0.0	155.0	V
1993.2000	45.90	74.0	28.10	0.0	155.0	V

Frequency (MHz)	Average dB μ V/m	Average limit (dB μ V/m)	Average Margin (dB)	Turntable position (deg)	Ant. height (cm)	Polarity
1004.0000	27.50	54.0	26.50	0.0	155.0	V
1199.2000	28.60	54.0	25.40	0.0	155.0	V
1400.4000	29.20	54.0	24.80	0.0	155.0	V
1598.4000	27.70	54.0	26.30	0.0	155.0	V
1804.4000	29.60	54.0	24.40	0.0	155.0	V
1993.2000	28.80	54.0	25.20	0.0	155.0	V

NOTE:

The minimum margin value is over 4dB.

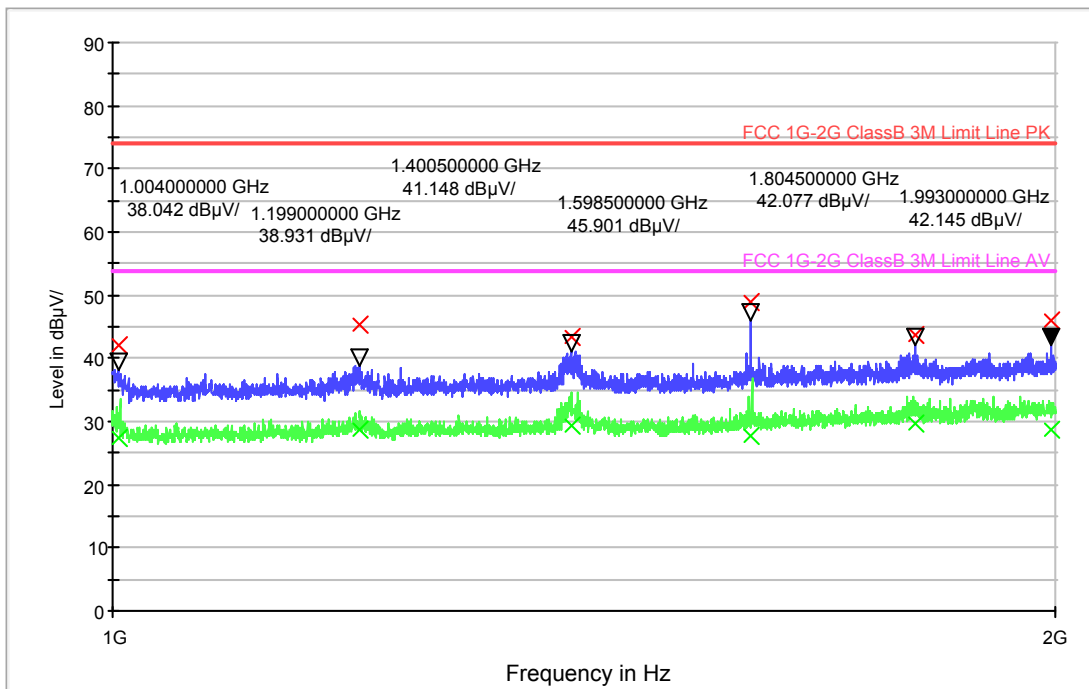
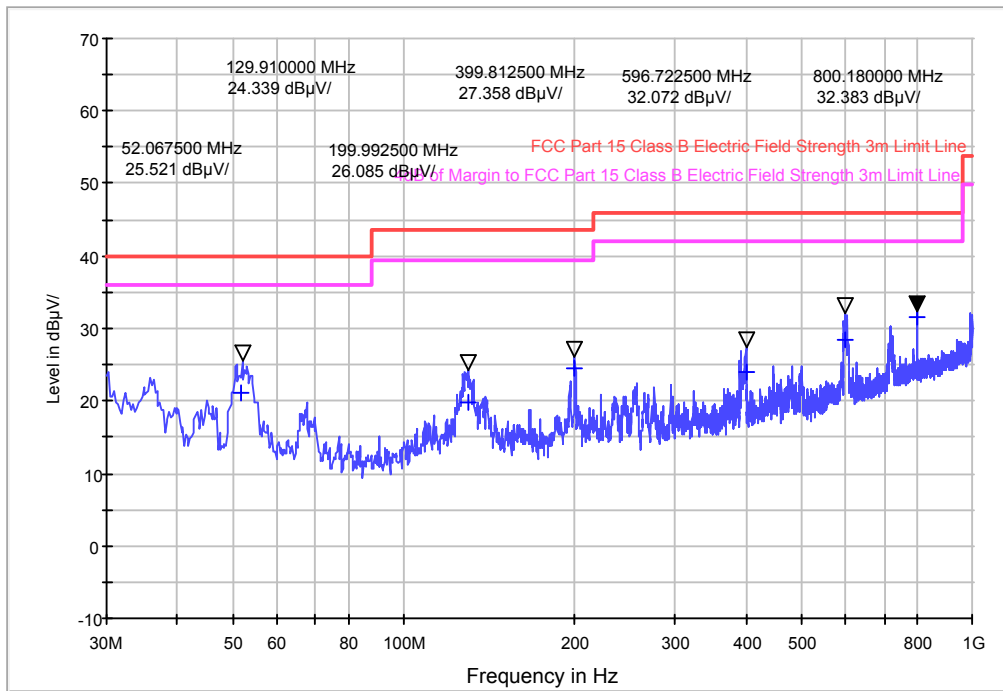

2. Radiated Emission Test data (Copy Mode)

-Horizontal

Frequency (MHz)	QuasiPeak (dB μ V/m)	Bandwidth (kHz)	Antenna height (cm)	Polarity	Turntable position (deg)	Corr. (dB)	Margin (dB)	Limit (dB μ V/m)
53.920000	17.7	120.000	100.0	H	357.0	-15.6	22.3	40.0
199.160000	29.7	120.000	100.0	H	51.0	-16.0	13.8	43.5
236.200000	32.3	120.000	100.0	H	308.0	-14.1	13.7	46.0
298.360000	27.7	120.000	100.0	H	18.0	-11.7	18.3	46.0
399.080000	30.6	120.000	100.0	H	260.0	-9.7	15.4	46.0
800.000000	32.2	120.000	100.0	H	79.0	-2.6	13.8	46.0

Frequency (MHz)	Peak (dB μ V/m)	Peak limit (dB μ V/m)	Peak Margin (dB)	Turntable position (deg)	Ant. height (cm)	Polarity
1001.2000	41.90	74.0	32.10	0.0	155.0	H
1127.6000	38.50	74.0	35.50	0.0	155.0	H
1195.6000	44.00	74.0	30.00	0.0	155.0	H
1412.0000	45.00	74.0	29.00	0.0	155.0	H
1585.6000	43.10	74.0	30.90	0.0	155.0	H
1946.0000	61.00	74.0	13.00	0.0	155.0	H

Frequency (MHz)	Average dB μ V/m	Average limit (dB μ V/m)	Average Margin (dB)	Turntable position (deg)	Ant. height (cm)	Polarity
1001.2000	27.80	54.0	26.20	0.0	155.0	H
1127.6000	25.50	54.0	28.50	0.0	155.0	H
1195.6000	27.70	54.0	26.30	0.0	155.0	H
1412.0000	28.20	54.0	25.80	0.0	155.0	H
1585.6000	28.30	54.0	25.70	0.0	155.0	H
1946.0000	49.60	54.0	4.40	0.0	155.0	H

NOTE:

The minimum margin value is over 4dB.

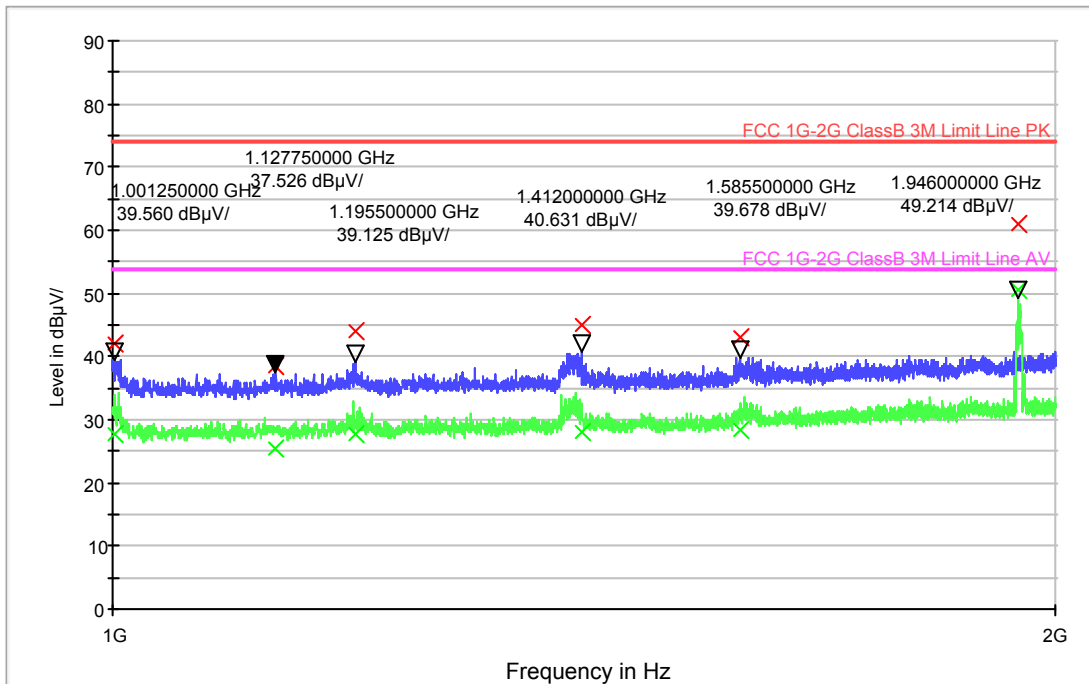
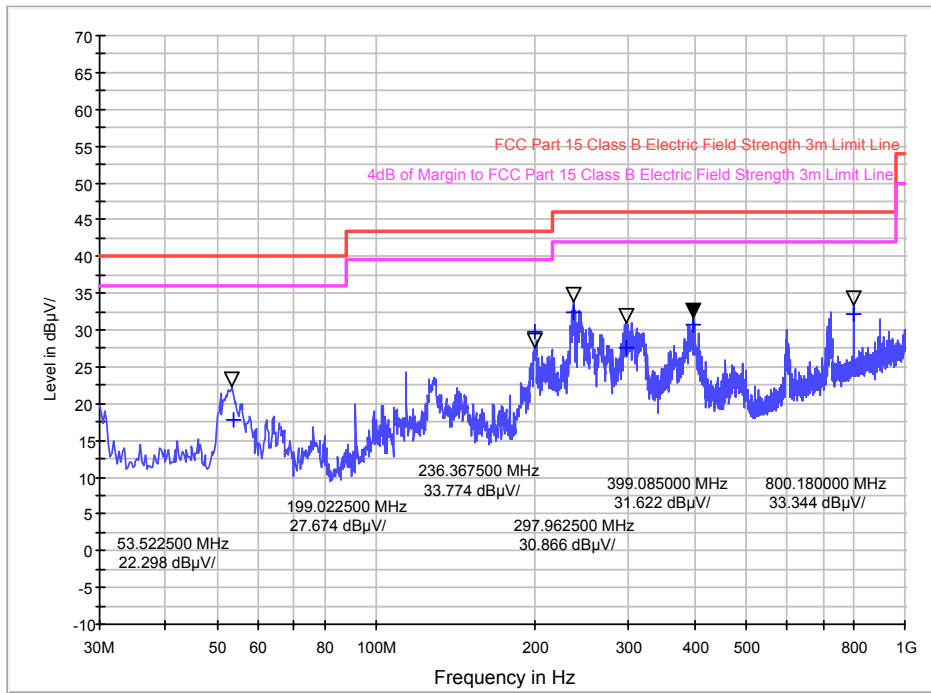

-Vertical

Frequency (MHz)	QuasiPeak (dB μ V/m)	Bandwidth (kHz)	Antenna height (cm)	Polarity	Turntable position (deg)	Corr. (dB)	Margin (dB)	Limit (dB μ V/m)
51.040000	31.1	120.000	100.0	V	359.0	-15.6	8.9	40.0
126.720000	22.2	120.000	100.0	V	0.0	-14.9	21.3	43.5
200.120000	21.1	120.000	100.0	V	0.0	-16.1	22.4	43.5
384.680000	25.1	120.000	100.0	V	10.0	-10.0	20.9	46.0
601.080000	25.8	120.000	100.0	V	0.0	-6.1	20.2	46.0
800.000000	33.1	120.000	100.0	V	1.0	-2.6	12.9	46.0

Frequency (MHz)	Peak (dB μ V/m)	Peak limit (dB μ V/m)	Peak Margin (dB)	Turntable position (deg)	Ant. height (cm)	Polarity
1004.4000	43.60	74.0	30.40	0.0	155.0	V
1197.6000	45.00	74.0	29.00	0.0	155.0	V
1393.6000	44.50	74.0	29.50	0.0	155.0	V
1601.6000	41.60	74.0	32.40	0.0	155.0	V
1791.2000	44.70	74.0	29.30	0.0	155.0	V
1993.6000	46.40	74.0	27.60	0.0	155.0	V

Frequency (MHz)	Average dB μ V/m	Average limit (dB μ V/m)	Average Margin (dB)	Turntable position (deg)	Ant. height (cm)	Polarity
1004.4000	27.30	54.0	26.70	0.0	100.0	V
1197.6000	27.70	54.0	26.30	0.0	100.0	V
1393.6000	29.80	54.0	24.20	0.0	100.0	V
1601.6000	27.90	54.0	26.10	0.0	100.0	V
1791.2000	29.70	54.0	24.30	0.0	100.0	V
1993.6000	28.70	54.0	25.30	0.0	100.0	V

NOTE:

The minimum margin value is over 4dB.

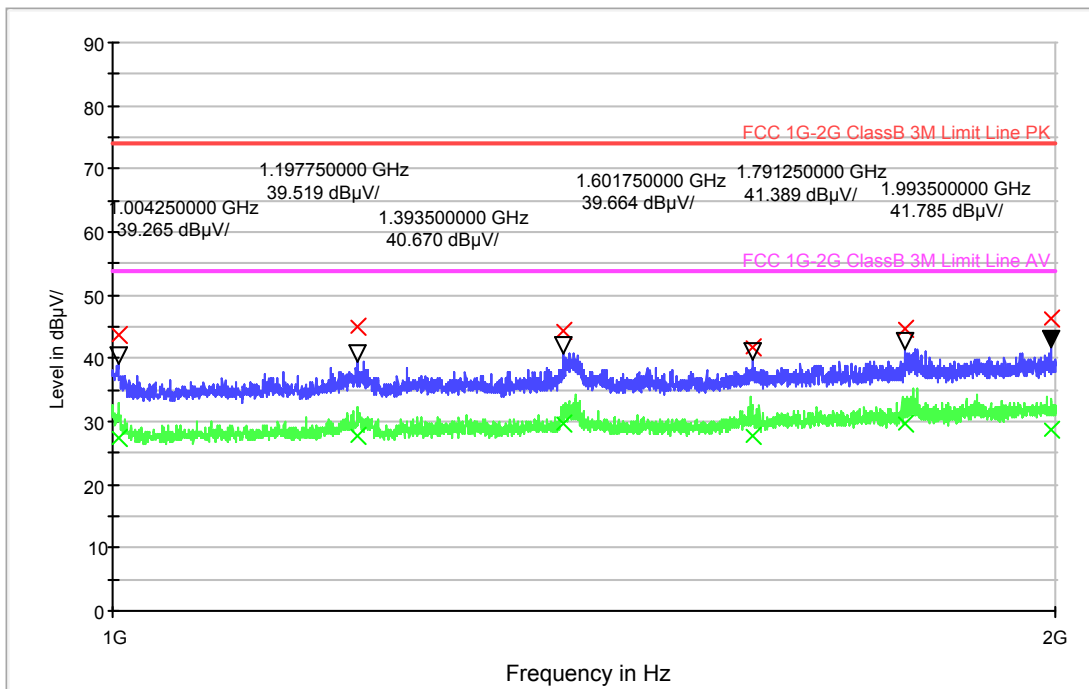
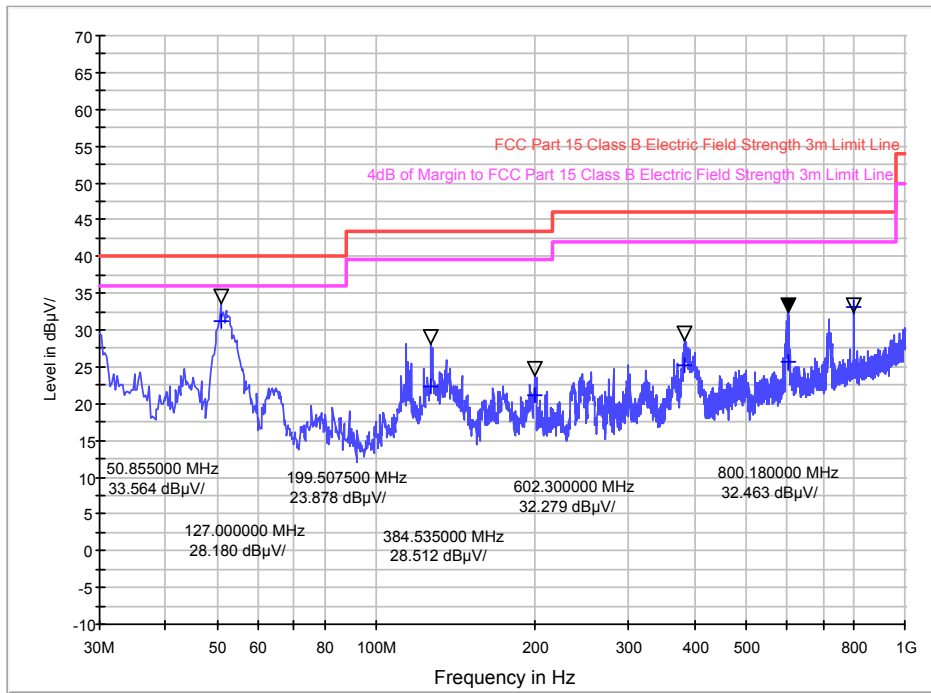

3. Radiated Emission Test data (USB Print Mode)**-Horizontal**

Frequency (MHz)	QuasiPeak (dB μ V/m)	Bandwidth (kHz)	Antenna height (cm)	Polarity	Turntable position (deg)	Corr. (dB)	Margin (dB)	Limit (dB μ V/m)
53.040000	18.7	120.000	300.0	H	0.0	-15.6	21.3	40.0
129.840000	24.6	120.000	300.0	H	0.0	-14.6	18.9	43.5
199.160000	29.7	120.000	100.0	H	0.0	-16.0	13.8	43.5
237.720000	35.7	120.000	100.0	H	198.0	-14.0	10.3	46.0
399.520000	29.0	120.000	100.0	H	0.0	-9.7	17.0	46.0
718.120000	31.2	120.000	100.0	H	168.0	-4.3	14.8	46.0

Frequency (MHz)	Peak (dB μ V/m)	Peak limit (dB μ V/m)	Peak Margin (dB)	Turntable position (deg)	Ant. height (cm)	Polarity
1004.8000	42.10	74.0	31.90	0.0	155.0	H
1167.6000	39.20	74.0	34.80	0.0	155.0	H
1404.4000	39.10	74.0	34.90	0.0	155.0	H
1482.8000	39.80	74.0	34.20	0.0	155.0	H
1597.6000	42.60	74.0	31.40	0.0	155.0	H
1949.2000	52.40	74.0	21.60	0.0	155.0	H

Frequency (MHz)	Average dB μ V/m	Average limit (dB μ V/m)	Average Margin (dB)	Turntable position (deg)	Ant. height (cm)	Polarity
1004.8000	27.20	54.0	26.80	0.0	155.0	H
1167.6000	26.20	54.0	27.80	0.0	155.0	H
1404.4000	26.10	54.0	27.90	0.0	155.0	H
1482.8000	26.50	54.0	27.50	0.0	155.0	H
1597.6000	29.00	54.0	25.00	0.0	155.0	H
1949.2000	44.30	54.0	9.70	0.0	155.0	H

NOTE:

The minimum margin value is over 4dB.

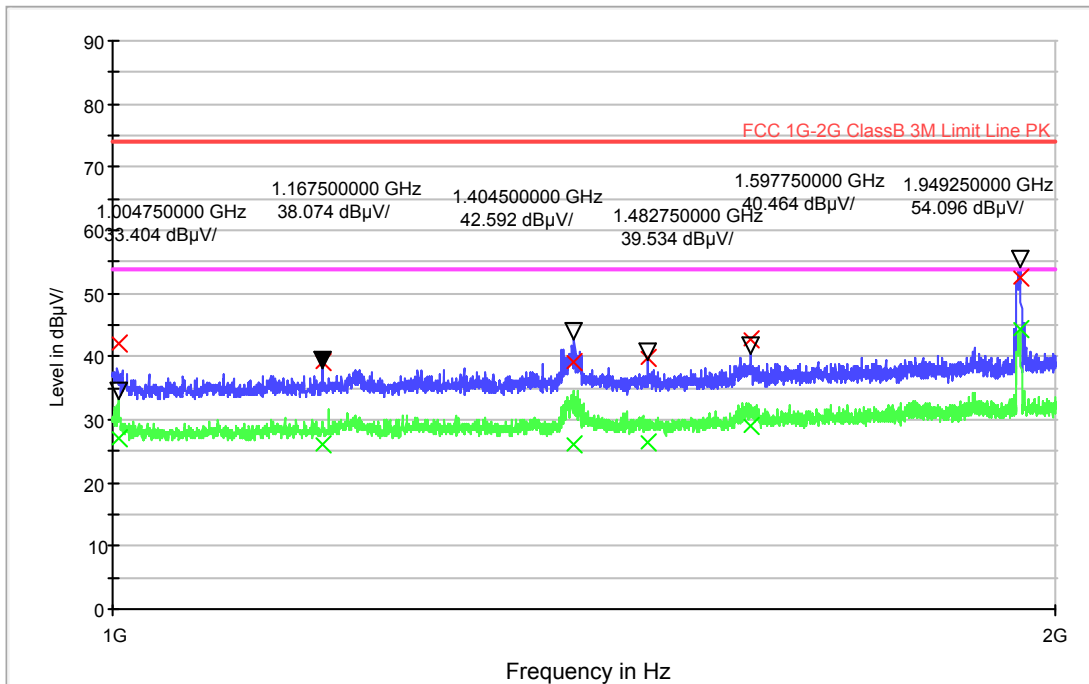
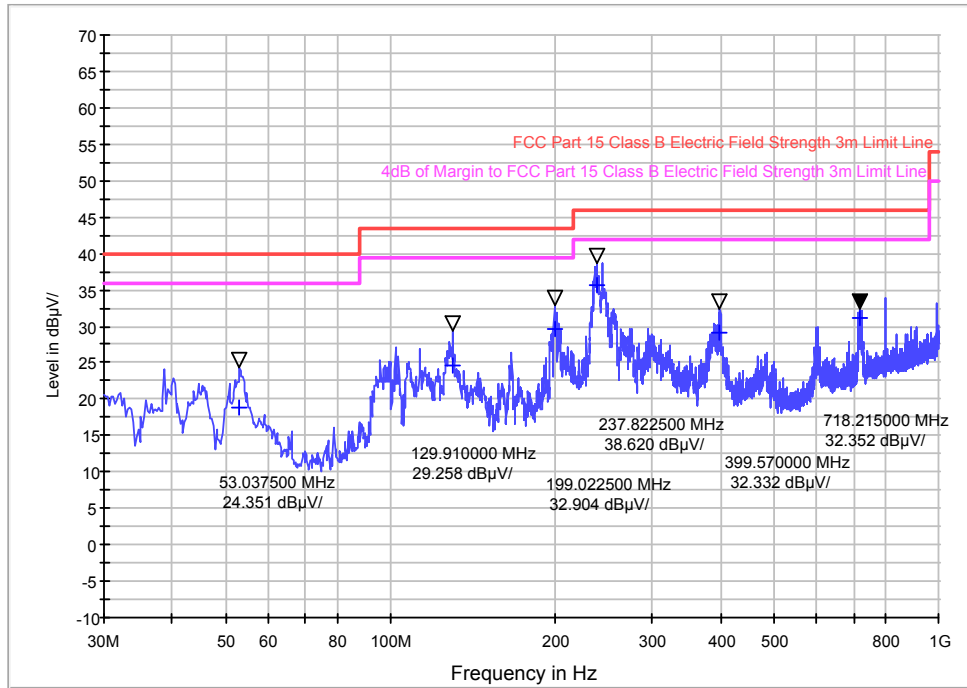

-Vertical

Frequency (MHz)	QuasiPeak (dB μ V/m)	Bandwidth (kHz)	Antenna height (cm)	Polarity	Turntable position (deg)	Corr. (dB)	Margin (dB)	Limit (dB μ V/m)
30.840000	25.3	120.000	100.0	V	344.0	-16.1	14.7	40.0
52.320000	29.9	120.000	100.0	V	255.0	-15.6	10.1	40.0
129.240000	22.2	120.000	100.0	V	46.0	-14.6	21.3	43.5
200.320000	23.2	120.000	100.0	V	0.0	-16.0	20.3	43.5
396.880000	24.2	120.000	100.0	V	359.0	-9.8	21.8	46.0
599.560000	25.8	120.000	100.0	V	0.0	-6.1	20.2	46.0

Frequency (MHz)	Peak (dB μ V/m)	Peak limit (dB μ V/m)	Peak Margin (dB)	Turntable position (deg)	Ant. height (cm)	Polarity
1001.2000	42.00	74.0	32.00	0.0	155.0	V
1199.2000	44.30	74.0	29.70	0.0	155.0	V
1397.6000	44.70	74.0	29.30	0.0	155.0	V
1597.2000	47.90	74.0	26.10	0.0	155.0	V
1793.6000	45.00	74.0	29.00	0.0	155.0	V
1917.2000	41.80	74.0	32.20	0.0	155.0	V

Frequency (MHz)	Average dB μ V/m	Average limit (dB μ V/m)	Average Margin (dB)	Turntable position (deg)	Ant. height (cm)	Polarity
1001.2000	28.20	54.0	25.80	0.0	155.0	V
1199.2000	28.80	54.0	25.20	0.0	155.0	V
1397.6000	29.70	54.0	24.30	0.0	155.0	V
1597.2000	28.70	54.0	25.30	0.0	155.0	V
1793.6000	30.40	54.0	23.60	0.0	155.0	V
1917.2000	28.20	54.0	25.80	0.0	155.0	V

NOTE:

The minimum margin value is over 4dB.

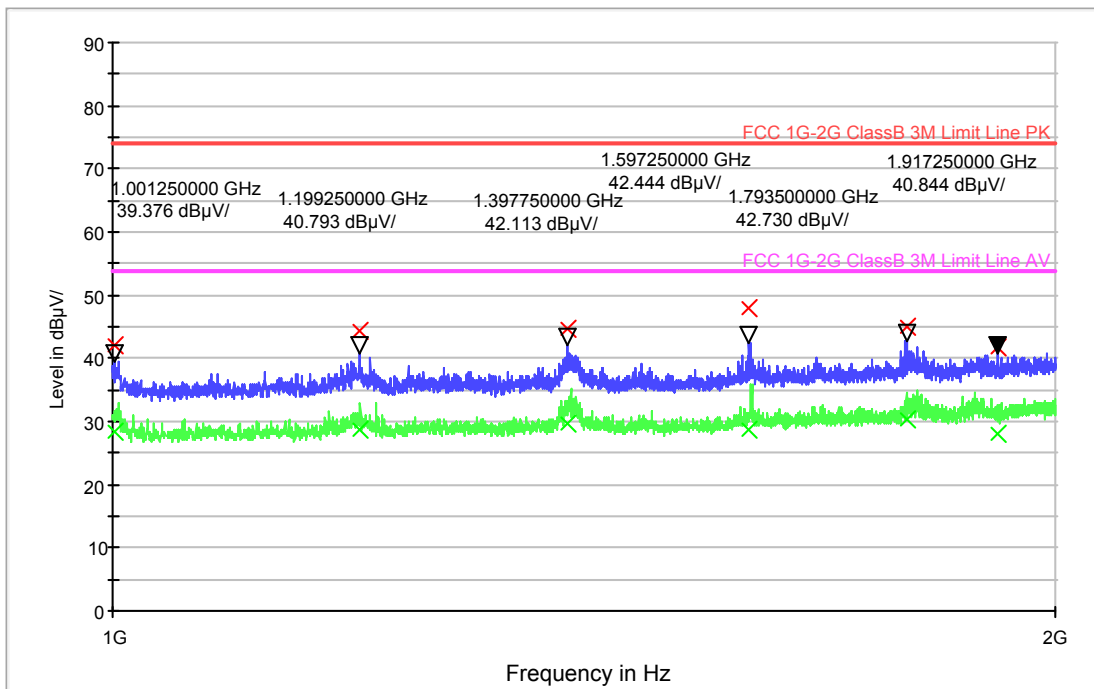
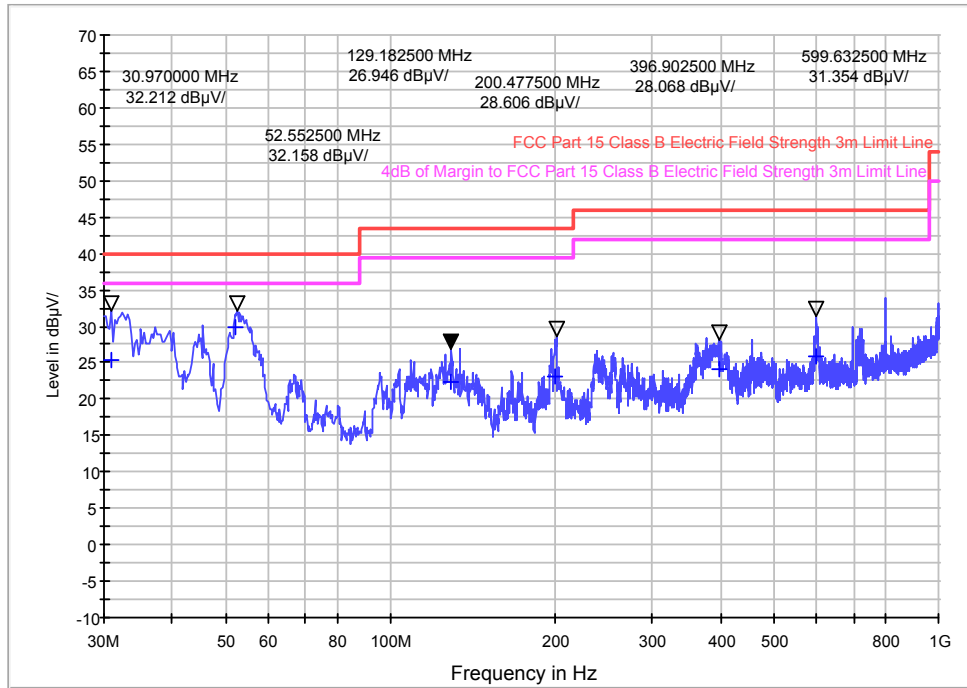

4. Radiated Emission Test data (Wifi Print Mode)

-Horizontal

Frequency (MHz)	QuasiPeak (dB μ V/m)	Bandwidth (kHz)	Antenna height (cm)	Polarity	Turntable position (deg)	Corr. (dB)	Margin (dB)	Limit (dB μ V/m)
129.440000	23.3	120.000	300.0	H	0.0	-14.6	20.2	43.5
200.000000	33.7	120.000	100.0	H	12.0	-16.1	9.8	43.5
244.200000	31.4	120.000	100.0	H	277.0	-13.8	14.6	46.0
294.760000	28.5	120.000	100.0	H	0.0	-11.7	17.5	46.0
400.000000	28.0	120.000	100.0	H	338.0	-9.7	18.0	46.0
720.000000	30.8	120.000	100.0	H	39.0	-4.2	15.2	46.0

Frequency (MHz)	Peak (dB μ V/m)	Peak limit (dB μ V/m)	Peak Margin (dB)	Turntable position (deg)	Ant. height (cm)	Polarity
1002.4000	42.60	74.0	31.40	0.0	155.0	H
1196.4000	42.00	74.0	32.00	0.0	155.0	H
1394.4000	44.60	74.0	29.40	0.0	155.0	H
1599.2000	44.20	74.0	29.80	0.0	155.0	H
1940.4000	65.40	74.0	8.60	0.0	155.0	H
1946.0000	63.20	74.0	10.80	0.0	155.0	H

Frequency (MHz)	Average dB μ V/m	Average limit (dB μ V/m)	Average Margin (dB)	Turntable position (deg)	Ant. height (cm)	Polarity
1002.4000	27.50	54.0	26.50	0.0	155.0	H
1196.4000	27.80	54.0	26.20	0.0	155.0	H
1394.4000	29.30	54.0	24.70	0.0	155.0	H
1599.2000	29.40	54.0	24.60	0.0	155.0	H
1940.4000	41.80	54.0	12.20	0.0	155.0	H
1946.0000	49.50	54.0	4.50	0.0	155.0	H

NOTE:

The minimum margin value is over 4dB.

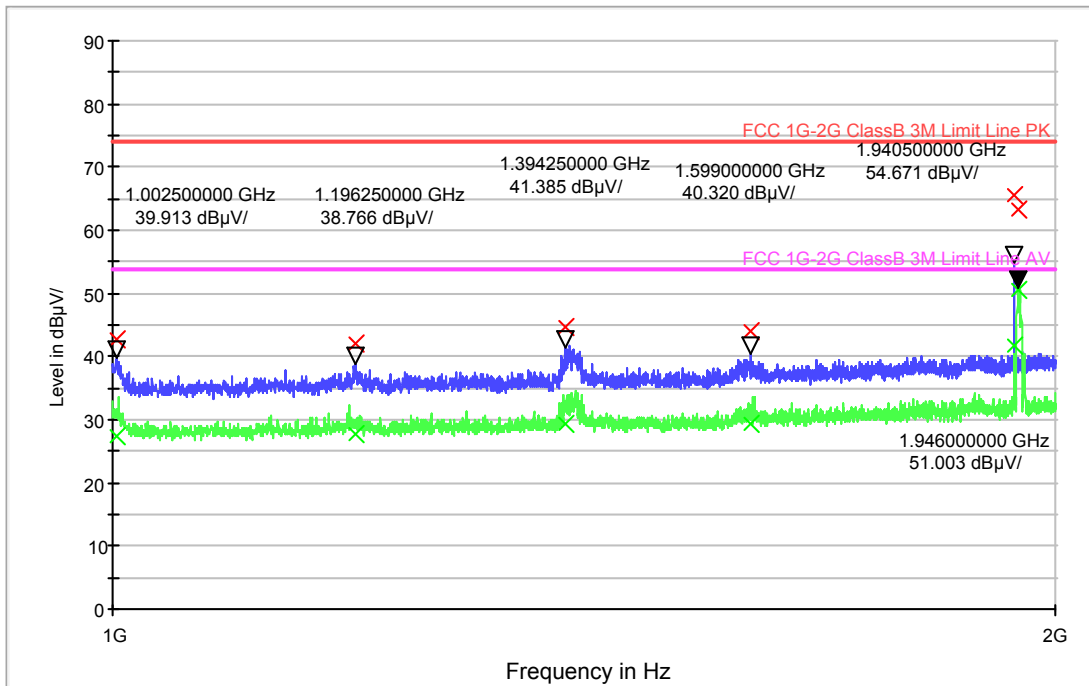
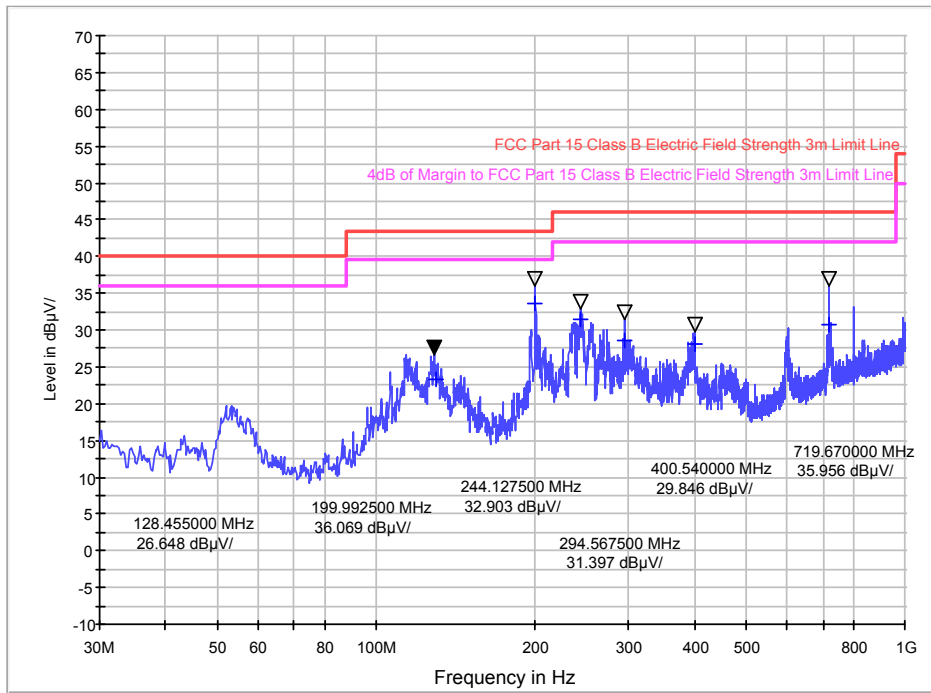

-Vertical

Frequency (MHz)	QuasiPeak (dB μ V/m)	Bandwidth (kHz)	Antenna height (cm)	Polarity	Turntable position (deg)	Corr. (dB)	Margin (dB)	Limit (dB μ V/m)
53.200000	29.0	120.000	100.0	V	179.0	-15.6	11.0	40.0
66.760000	18.7	120.000	100.0	V	226.0	-16.0	21.3	40.0
122.360000	21.2	120.000	100.0	V	1.0	-15.3	22.3	43.5
200.000000	24.3	120.000	100.0	V	0.0	-16.1	19.2	43.5
400.000000	26.1	120.000	100.0	V	0.0	-9.7	19.9	46.0
599.080000	31.3	120.000	100.0	V	345.0	-6.2	14.7	46.0

Frequency (MHz)	Peak (dB μ V/m)	Peak limit (dB μ V/m)	Peak Margin (dB)	Turntable position (deg)	Ant. height (cm)	Polarity
1004.0000	42.70	74.0	31.30	0.0	155.0	V
1199.6000	45.00	74.0	29.00	0.0	155.0	V
1395.2000	46.30	74.0	27.70	0.0	155.0	V
1594.0000	48.50	74.0	25.50	0.0	155.0	V
1791.6000	44.70	74.0	29.30	0.0	155.0	V
1944.8000	48.10	74.0	25.90	0.0	155.0	V

Frequency (MHz)	Average dB μ V/m	Average limit (dB μ V/m)	Average Margin (dB)	Turntable position (deg)	Ant. height (cm)	Polarity
1004.0000	28.00	54.0	26.00	0.0	155.0	V
1199.6000	29.60	54.0	24.40	0.0	155.0	V
1395.2000	29.80	54.0	24.20	0.0	155.0	V
1594.0000	29.80	54.0	24.20	0.0	155.0	V
1791.6000	29.20	54.0	24.80	0.0	155.0	V
1944.8000	30.80	54.0	23.20	0.0	155.0	V

NOTE:

The minimum margin value is over 4dB.

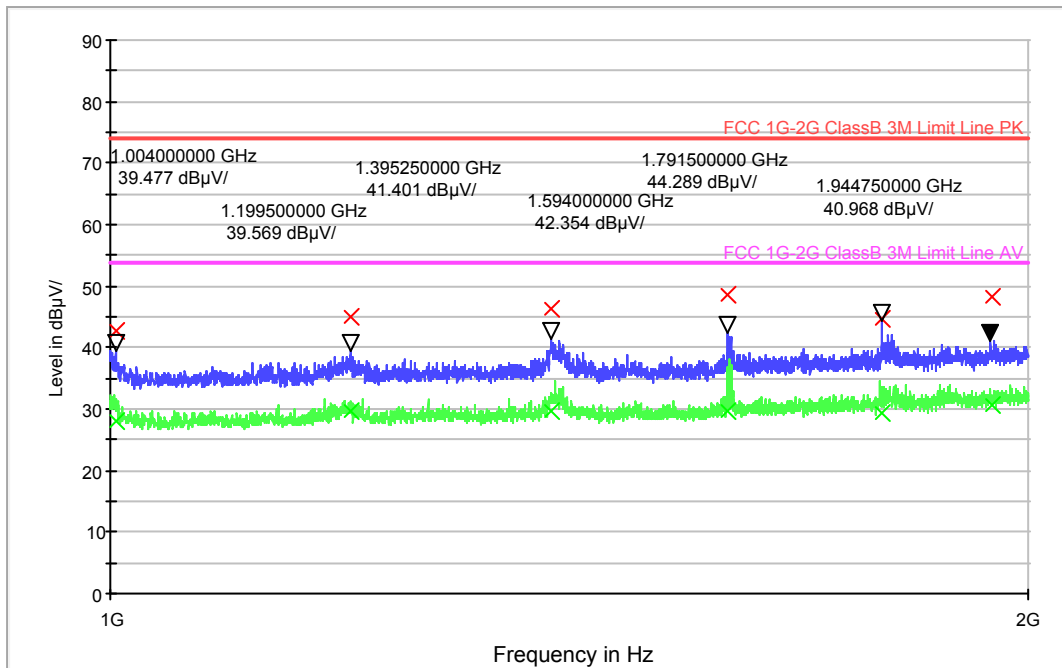
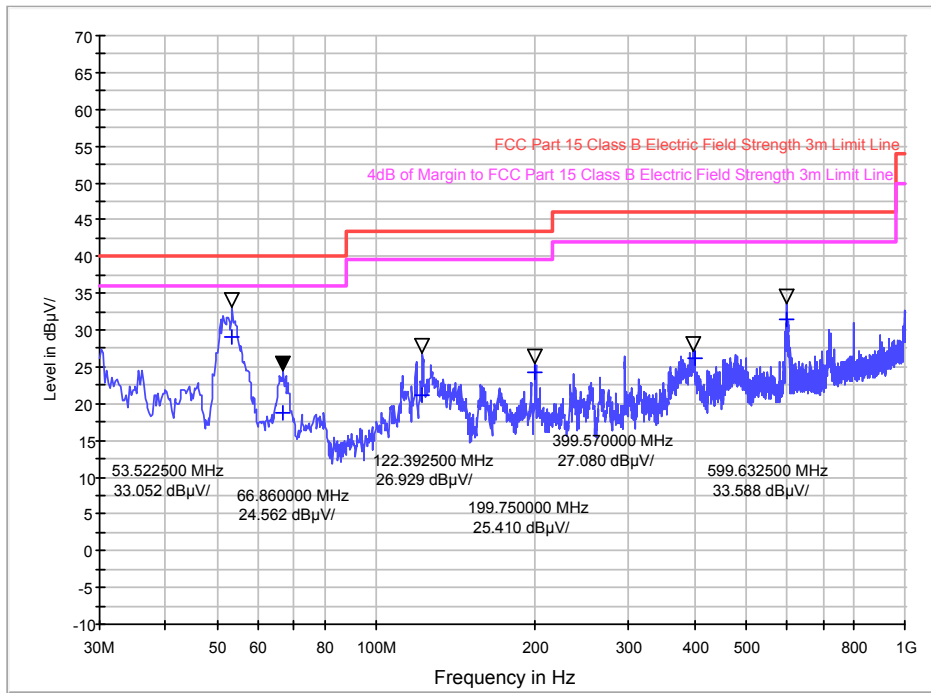

5. Radiated Emission Test data (USB Scan Mode)

-Horizontal

Frequency (MHz)	QuasiPeak (dB μ V/m)	Bandwidth (kHz)	Antenna height (cm)	Polarity	Turntable position (deg)	Corr. (dB)	Margin (dB)	Limit (dB μ V/m)
199.920000	31.0	120.000	100.0	H	343.0	-16.1	12.5	43.5
236.560000	32.2	120.000	100.0	H	0.0	-14.1	13.8	46.0
294.680000	23.7	120.000	100.0	H	0.0	-11.7	22.3	46.0
391.080000	27.8	120.000	100.0	H	341.0	-9.9	18.2	46.0
720.000000	34.4	120.000	100.0	H	52.0	-4.2	11.6	46.0
800.000000	32.5	120.000	100.0	H	138.0	-2.6	13.5	46.0

Frequency (MHz)	Peak (dB μ V/m)	Peak limit (dB μ V/m)	Peak Margin (dB)	Turntable position (deg)	Ant. height (cm)	Polarity
1004.4000	43.80	74.0	30.20	0.0	155.0	H
1087.6000	40.50	74.0	33.50	0.0	155.0	H
1195.2000	43.00	74.0	31.00	0.0	155.0	H
1404.8000	47.60	74.0	26.40	0.0	155.0	H
1584.4000	42.20	74.0	31.80	0.0	155.0	H
1946.8000	55.70	74.0	18.30	0.0	155.0	H

Frequency (MHz)	Average dB μ V/m	Average limit (dB μ V/m)	Average Margin (dB)	Turntable position (deg)	Ant. height (cm)	Polarity
1004.4000	27.10	54.0	26.90	0.0	155.0	H
1087.6000	26.00	54.0	28.00	0.0	155.0	H
1195.2000	28.00	54.0	26.00	0.0	155.0	H
1404.8000	31.50	54.0	22.50	0.0	155.0	H
1584.4000	27.90	54.0	26.10	0.0	155.0	H
1946.8000	49.10	54.0	4.90	0.0	155.0	H

NOTE:

The minimum margin value is over 4dB.

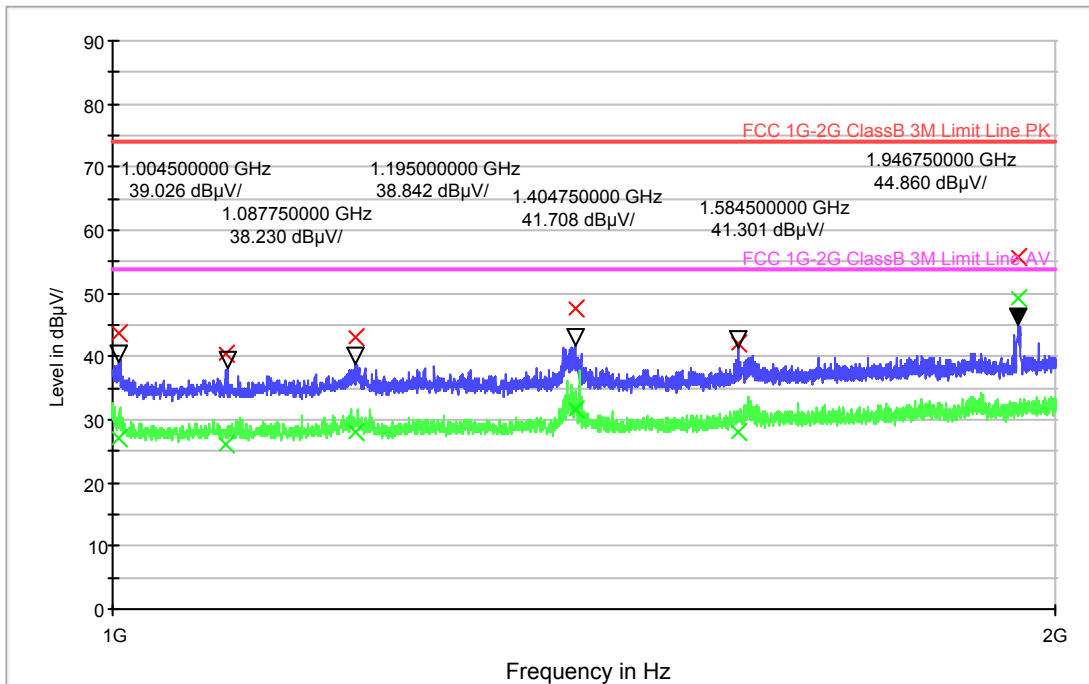
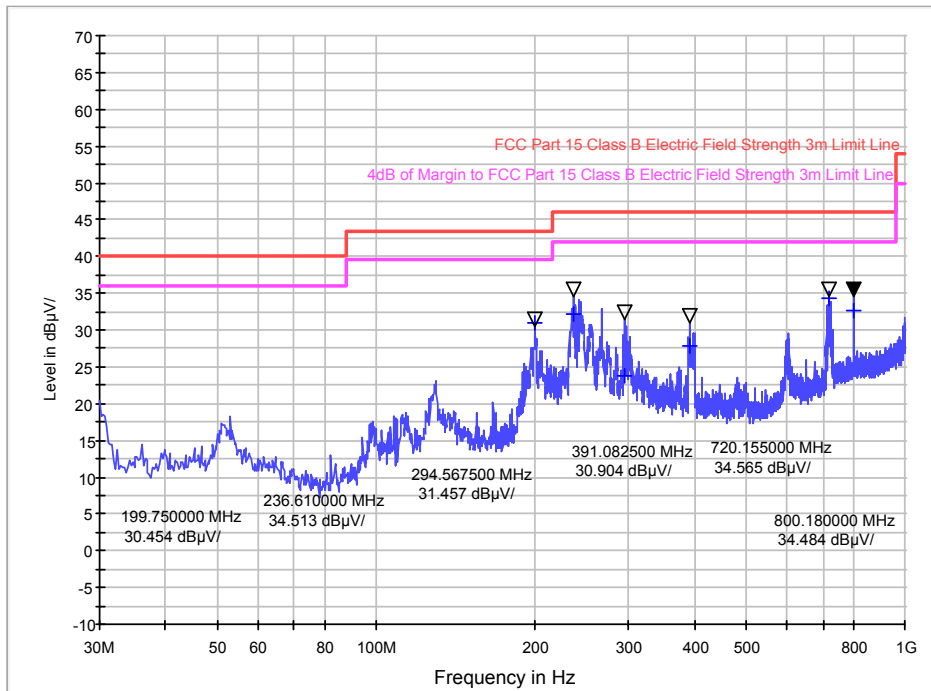

-Vertical

Frequency (MHz)	QuasiPeak (dB μ V/m)	Bandwidth (kHz)	Antenna height (cm)	Polarity	Turntable position (deg)	Corr. (dB)	Margin (dB)	Limit (dB μ V/m)
50.480000	25.0	120.000	100.0	V	0.0	-15.6	15.0	40.0
128.680000	19.1	120.000	100.0	V	3.0	-14.7	24.4	43.5
199.400000	21.1	120.000	100.0	V	251.0	-16.0	22.4	43.5
599.560000	26.7	120.000	100.0	V	0.0	-6.1	19.3	46.0
800.000000	33.1	120.000	100.0	V	0.0	-2.6	12.9	46.0
898.760000	21.7	120.000	100.0	V	359.0	-1.2	24.3	46.0

Frequency (MHz)	Peak (dB μ V/m)	Peak limit (dB μ V/m)	Peak Margin (dB)	Turntable position (deg)	Ant. height (cm)	Polarity
1003.2000	43.30	74.0	30.70	0.0	155.0	V
1084.0000	40.10	74.0	33.90	0.0	155.0	V
1199.2000	44.90	74.0	29.10	0.0	155.0	V
1390.8000	44.40	74.0	29.60	0.0	155.0	V
1596.4000	48.60	74.0	25.40	0.0	155.0	V
1802.0000	44.90	74.0	29.10	0.0	155.0	V

Frequency (MHz)	Average dB μ V/m	Average limit (dB μ V/m)	Average Margin (dB)	Turntable position (deg)	Ant. height (cm)	Polarity
1003.2000	28.50	54.0	25.50	0.0	155.0	V
1084.0000	25.60	54.0	28.40	0.0	155.0	V
1199.2000	29.00	54.0	25.00	0.0	155.0	V
1390.8000	28.20	54.0	25.80	0.0	155.0	V
1596.4000	29.90	54.0	24.10	0.0	155.0	V
1802.0000	30.50	54.0	23.50	0.0	155.0	V

NOTE:

The minimum margin value is over 4dB.

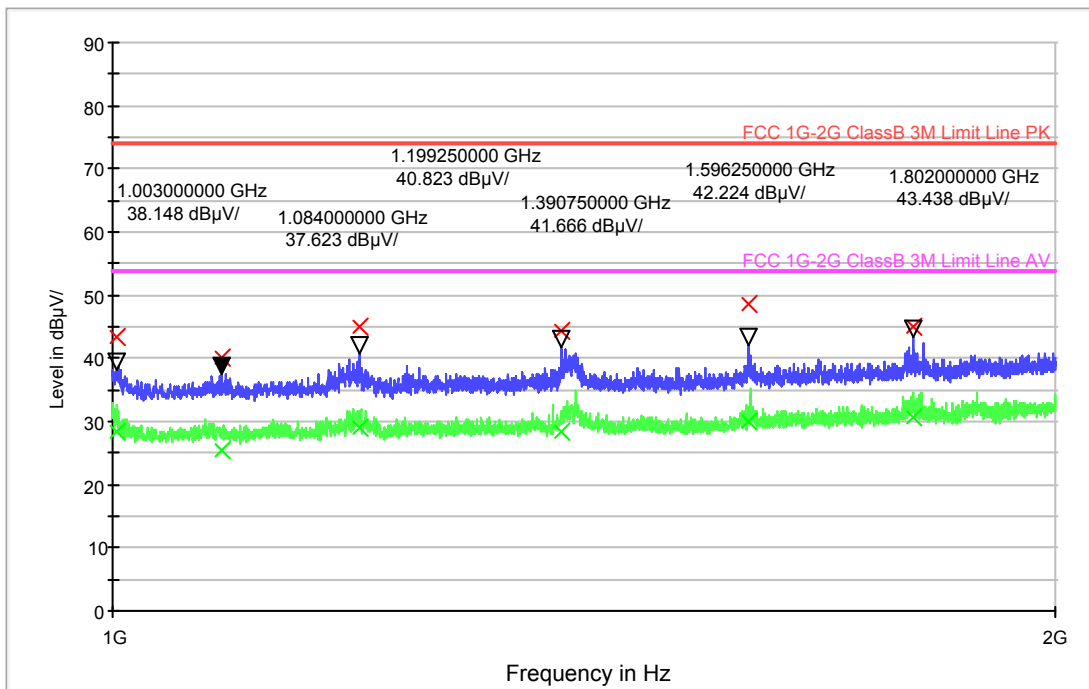
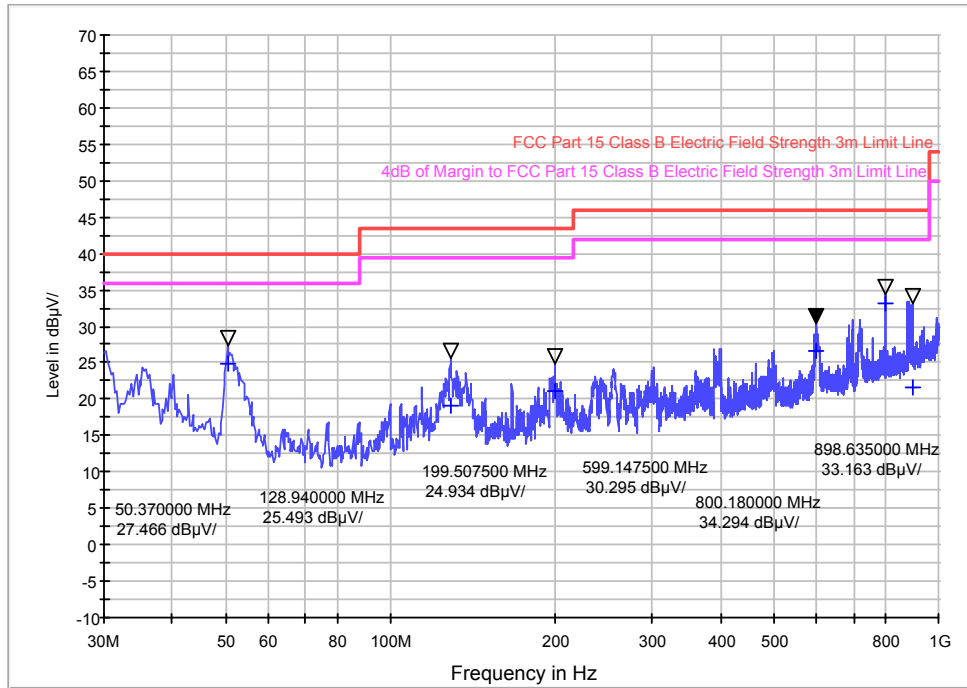

6. Radiated Emission Test data (Wifi Scan Mode)

-Horizontal

Frequency (MHz)	QuasiPeak (dB μ V/m)	Bandwidth (kHz)	Antenna height (cm)	Polarity	Turntable position (deg)	Corr. (dB)	Margin (dB)	Limit (dB μ V/m)
200.520000	26.9	120.000	100.0	H	2.0	-16.0	16.6	43.5
235.520000	29.5	120.000	100.0	H	359.0	-14.1	16.5	46.0
294.840000	30.2	120.000	100.0	H	1.0	-11.7	15.8	46.0
399.560000	29.3	120.000	100.0	H	282.0	-9.7	16.7	46.0
720.000000	29.4	120.000	100.0	H	0.0	-4.2	16.6	46.0
800.000000	32.6	120.000	100.0	H	287.0	-2.6	13.4	46.0

Frequency (MHz)	Peak (dB μ V/m)	Peak limit (dB μ V/m)	Peak Margin (dB)	Turntable position (deg)	Ant. height (cm)	Polarity
1003.2000	42.80	74.0	31.20	0.0	155.0	H
1091.6000	41.10	74.0	32.90	0.0	155.0	H
1195.6000	42.10	74.0	31.90	0.0	155.0	H
1398.8000	43.60	74.0	30.40	0.0	155.0	H
1598.4000	43.60	74.0	30.40	0.0	155.0	H
1948.8000	42.40	74.0	31.60	0.0	155.0	H

Frequency (MHz)	Average dB μ V/m	Average limit (dB μ V/m)	Average Margin (dB)	Turntable position (deg)	Ant. height (cm)	Polarity
1003.2000	28.30	54.0	25.70	0.0	155.0	H
1091.6000	26.10	54.0	27.90	0.0	155.0	H
1195.6000	28.20	54.0	25.80	0.0	155.0	H
1398.8000	29.10	54.0	24.90	0.0	155.0	H
1598.4000	30.00	54.0	24.00	0.0	155.0	H
1948.8000	28.80	54.0	25.20	0.0	155.0	H

NOTE:

The minimum margin value is over 4dB.

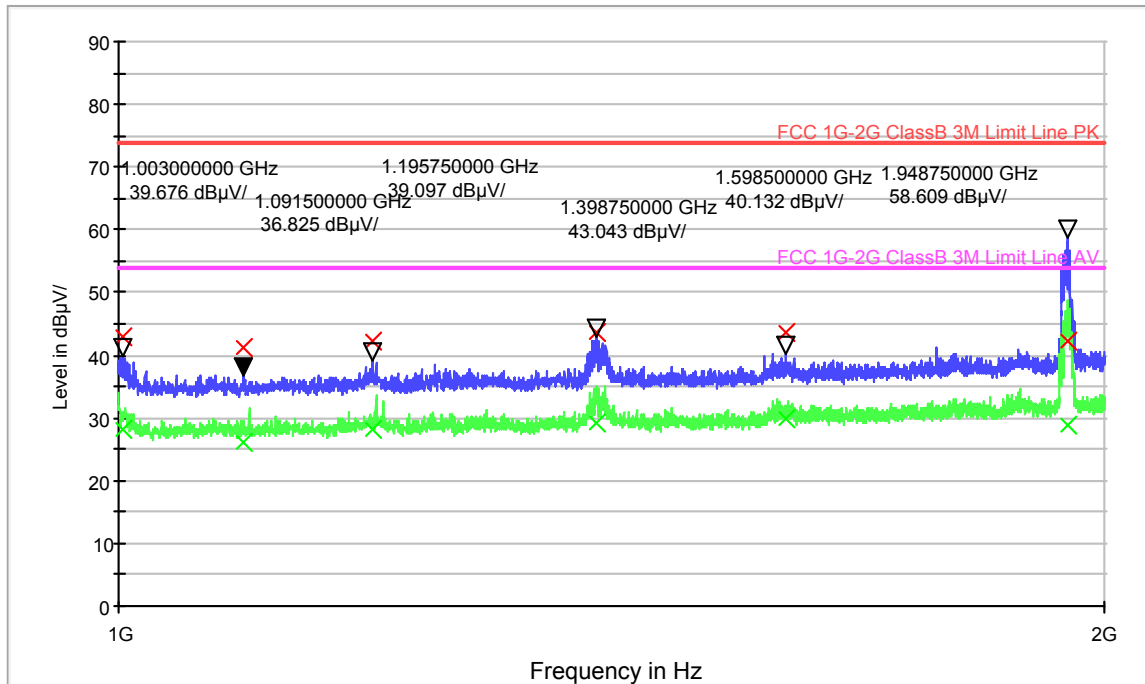
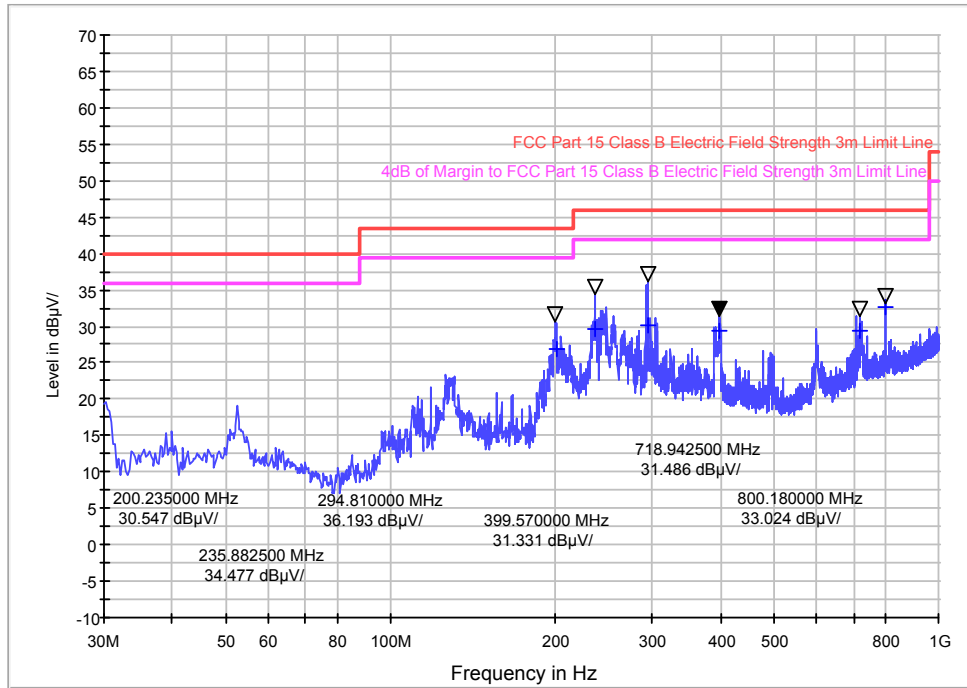

-Vertical

Frequency (MHz)	QuasiPeak (dB μ V/m)	Bandwidth (kHz)	Antenna height (cm)	Polarity	Turntable position (deg)	Corr. (dB)	Margin (dB)	Limit (dB μ V/m)
51.880000	24.0	120.000	100.0	V	0.0	-15.6	16.0	40.0
127.760000	20.4	120.000	100.0	V	0.0	-14.8	23.1	43.5
199.320000	20.3	120.000	100.0	V	164.0	-16.0	23.2	43.5
294.560000	21.9	120.000	100.0	V	0.0	-11.7	24.1	46.0
720.000000	30.4	120.000	100.0	V	0.0	-4.2	15.6	46.0
799.960000	31.2	120.000	100.0	V	1.0	-2.6	14.8	46.0

Frequency (MHz)	Peak (dB μ V/m)	Peak limit (dB μ V/m)	Peak Margin (dB)	Turntable position (deg)	Ant. height (cm)	Polarity
1003.6000	44.00	74.0	30.00	0.0	155.0	V
1198.4000	45.00	74.0	29.00	0.0	155.0	V
1403.2000	44.10	74.0	29.90	0.0	155.0	V
1595.2000	48.10	74.0	25.90	0.0	155.0	V
1797.2000	45.50	74.0	28.50	0.0	155.0	V
1942.4000	52.50	74.0	21.50	0.0	155.0	V

Frequency (MHz)	Average dB μ V/m	Average limit (dB μ V/m)	Average Margin (dB)	Turntable position (deg)	Ant. height (cm)	Polarity
1003.6000	28.50	54.0	25.50	0.0	155.0	V
1198.4000	28.50	54.0	25.50	0.0	155.0	V
1403.2000	29.10	54.0	24.90	0.0	155.0	V
1595.2000	28.40	54.0	25.60	0.0	155.0	V
1797.2000	30.70	54.0	23.30	0.0	155.0	V
1942.4000	31.50	54.0	22.50	0.0	155.0	V

NOTE:

The minimum margin value is over 4dB.

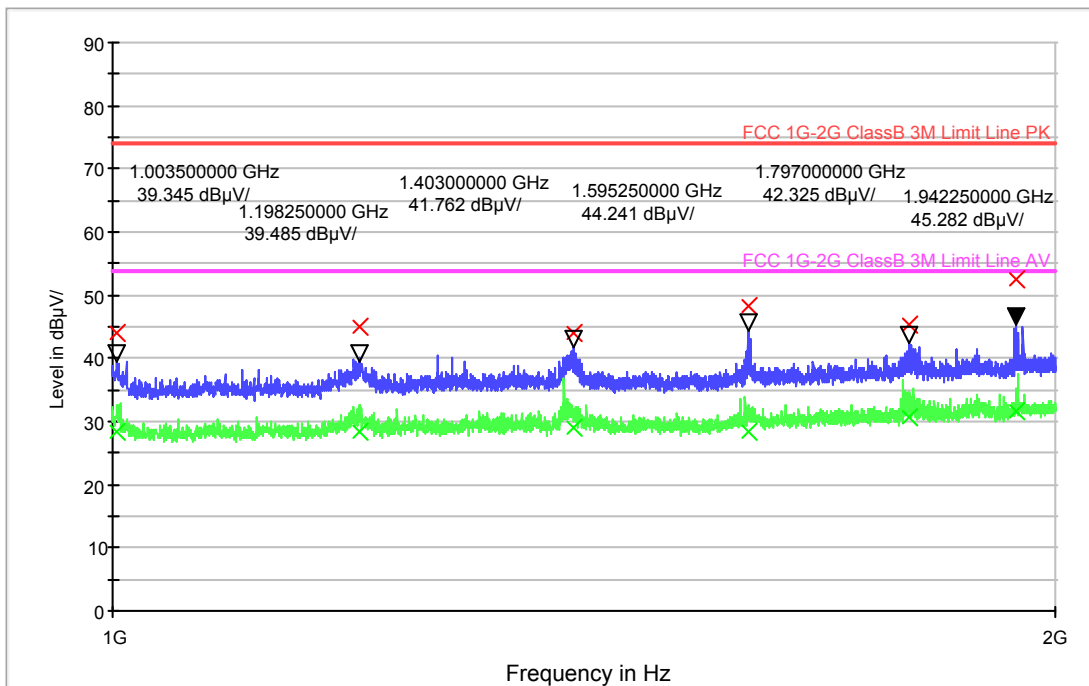
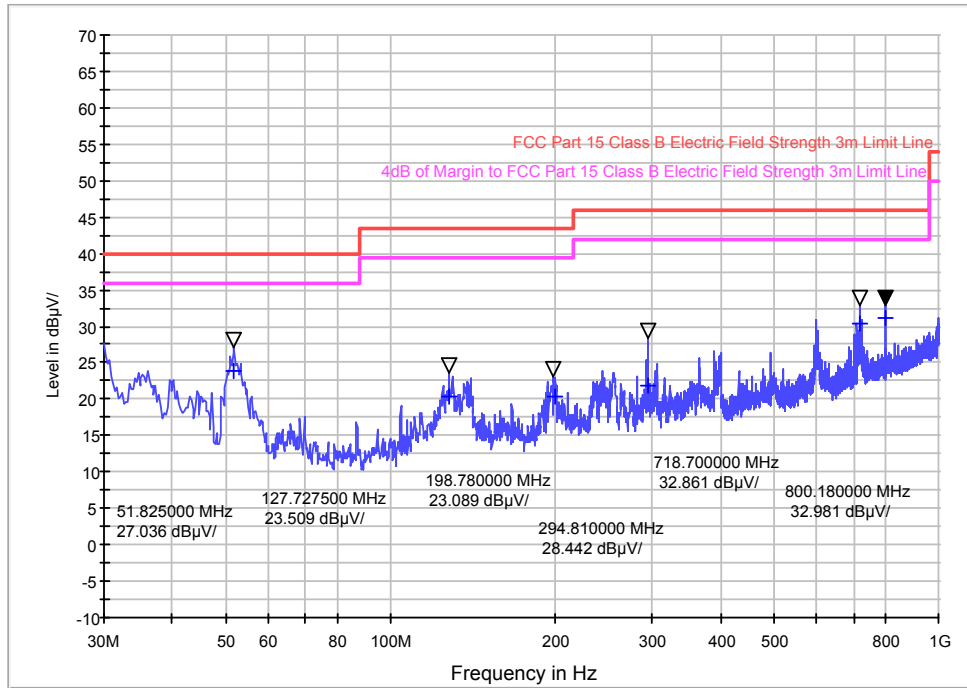

Appendix I: Photographs of the EUT

1. Appearance



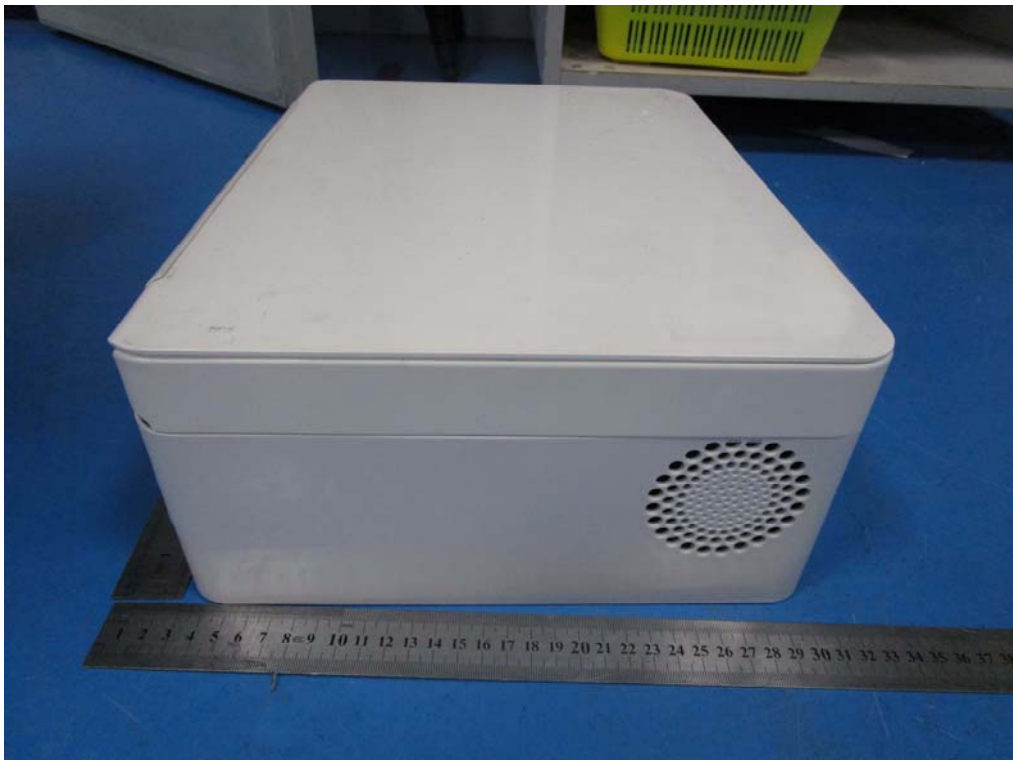
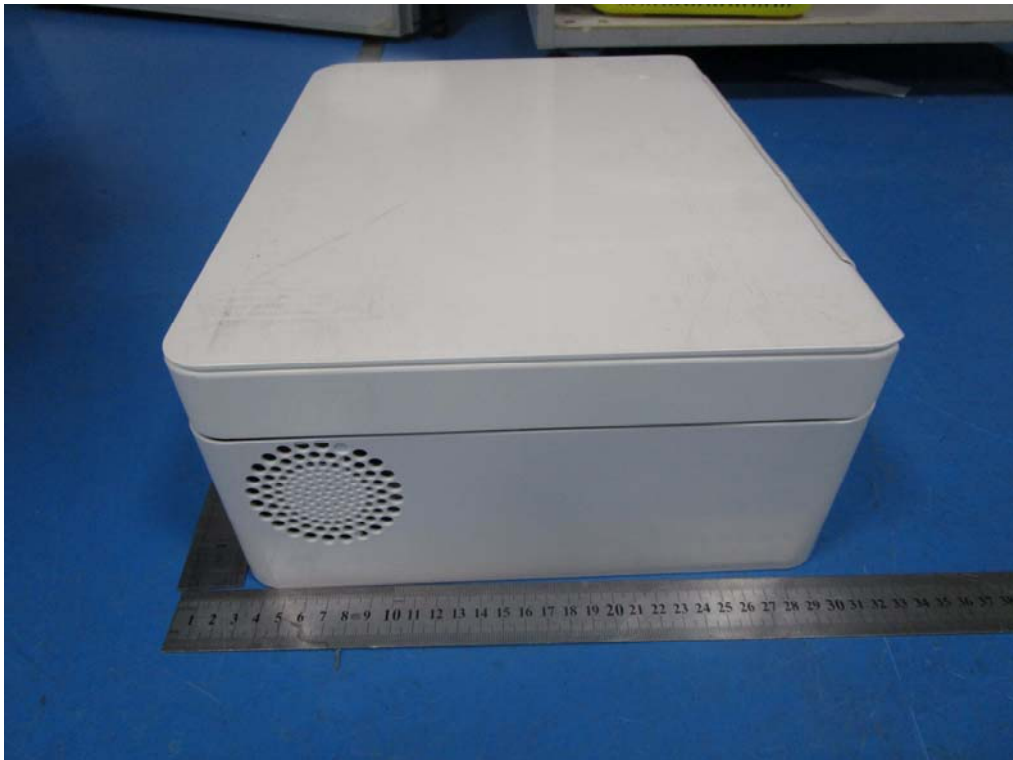

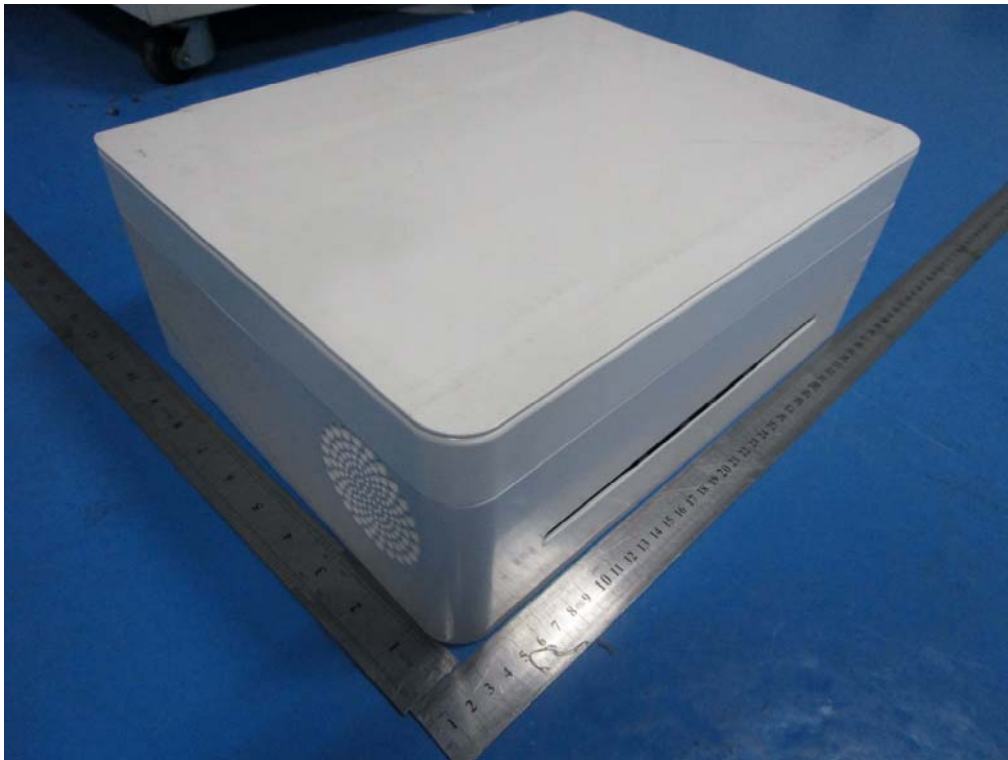

1. Inside



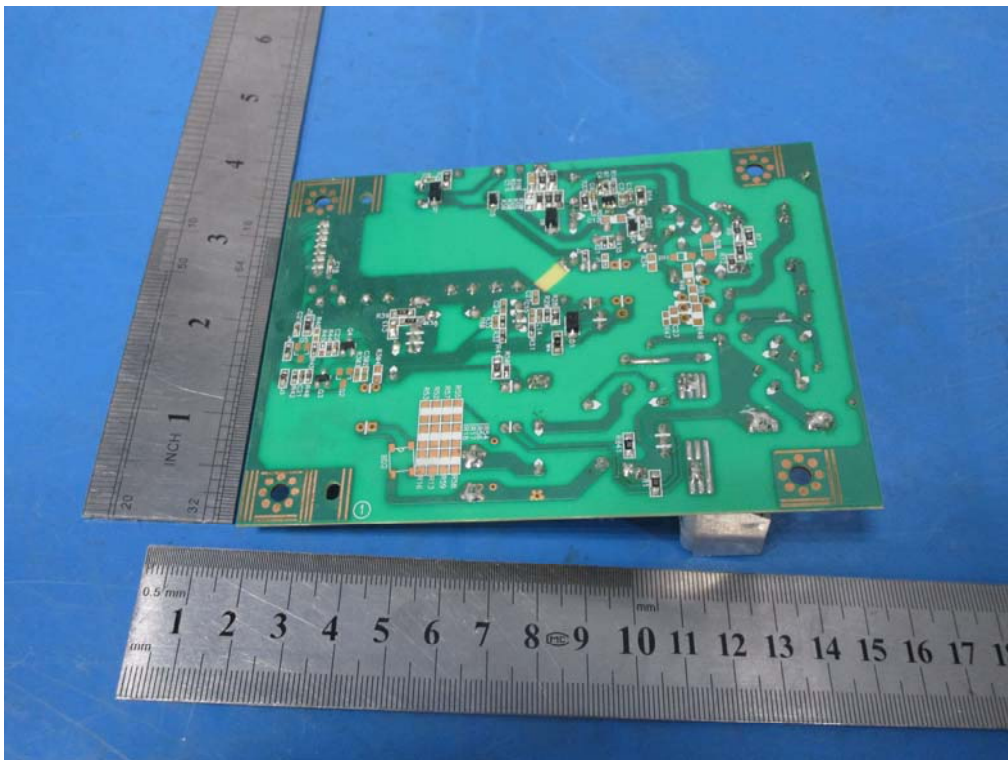



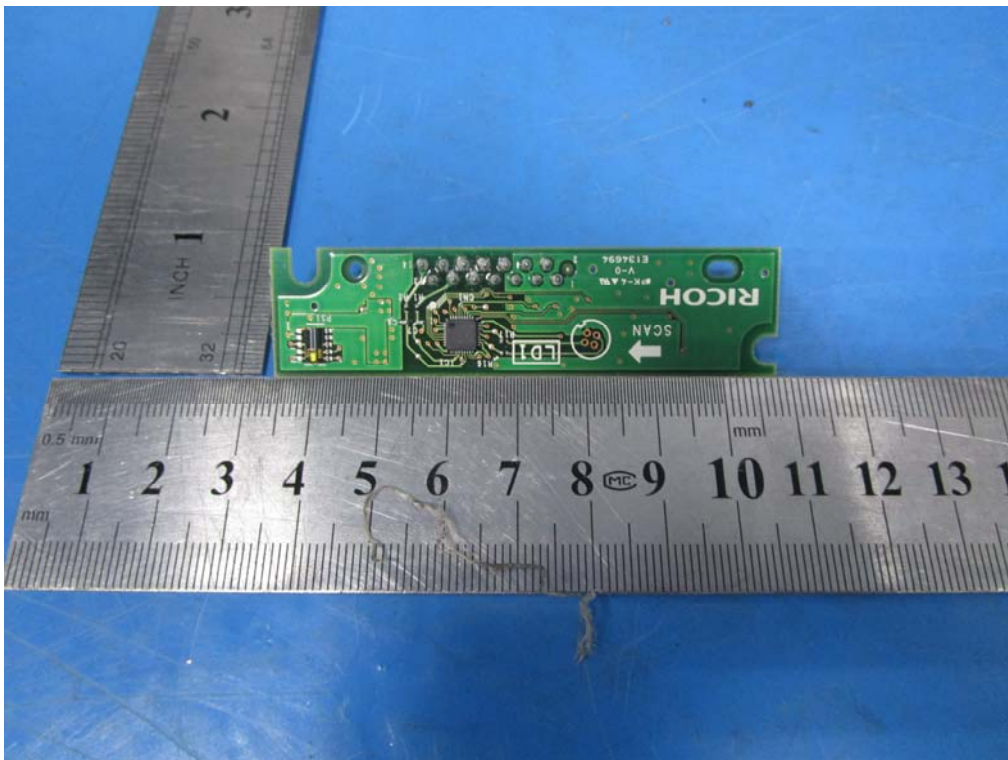
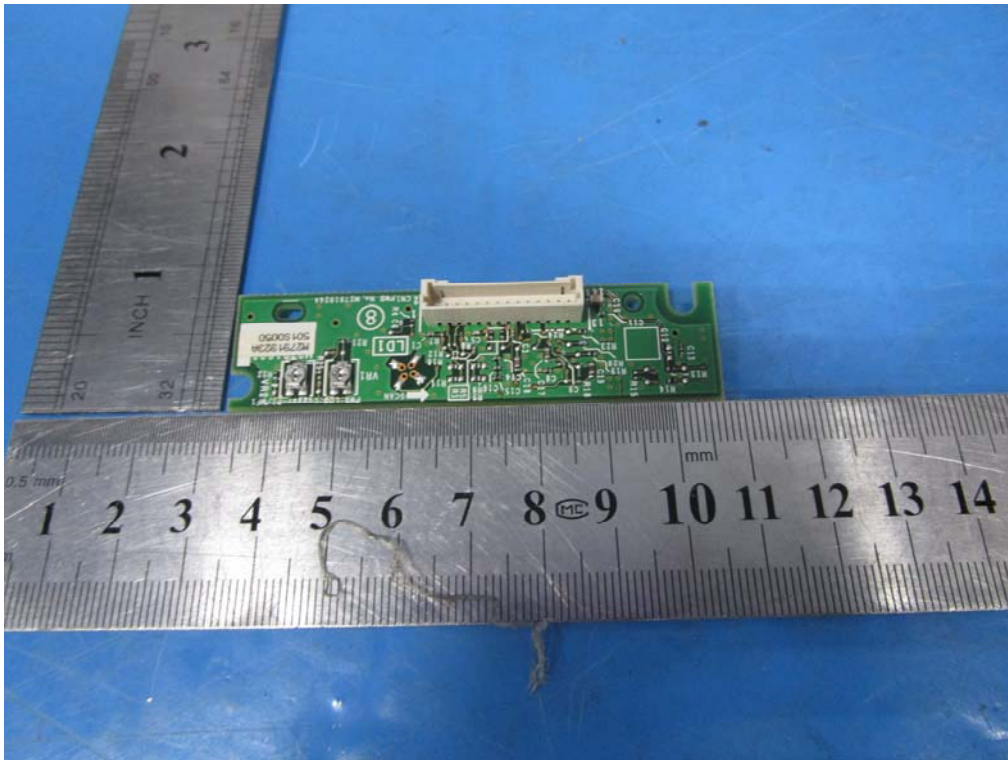

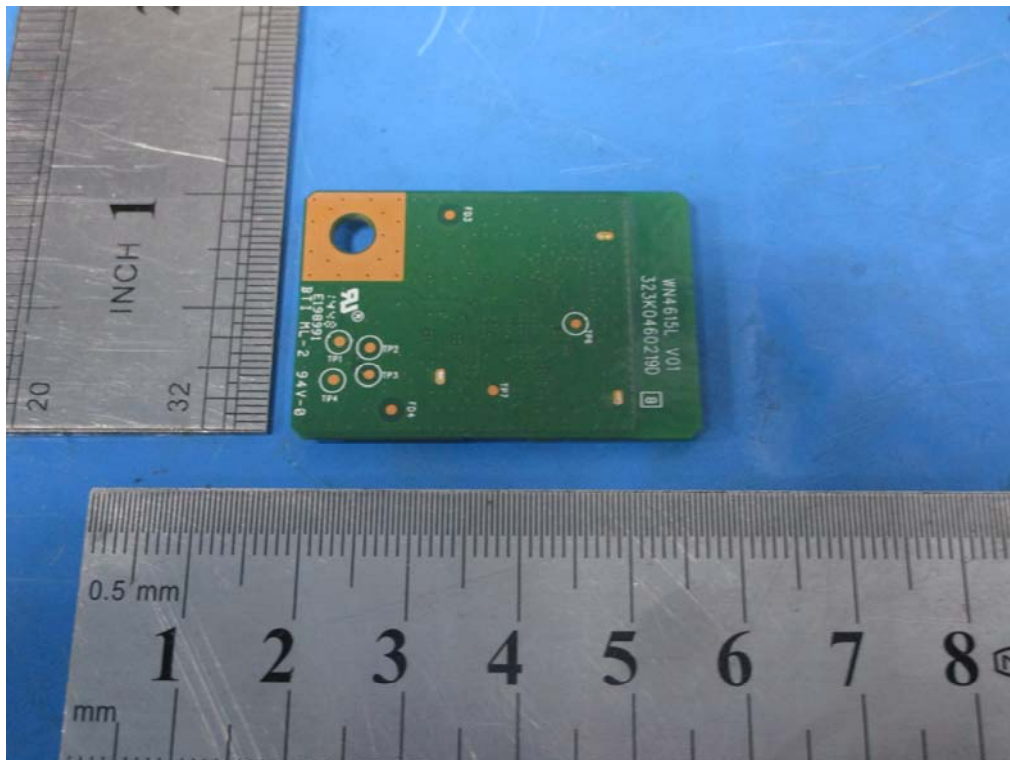

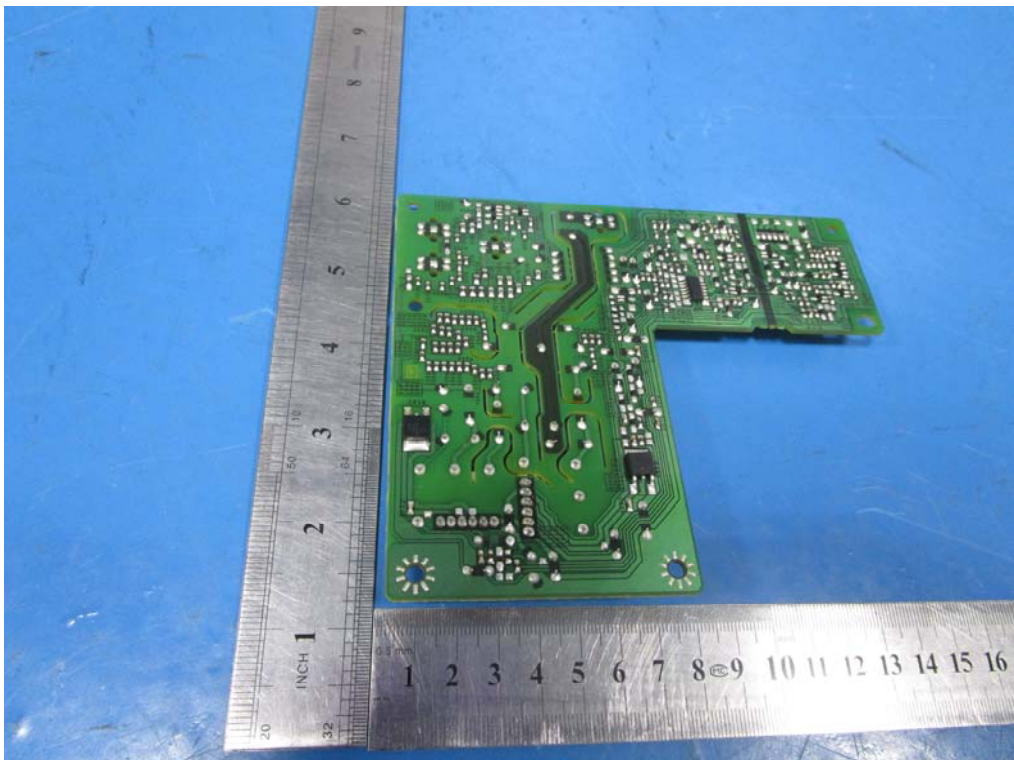
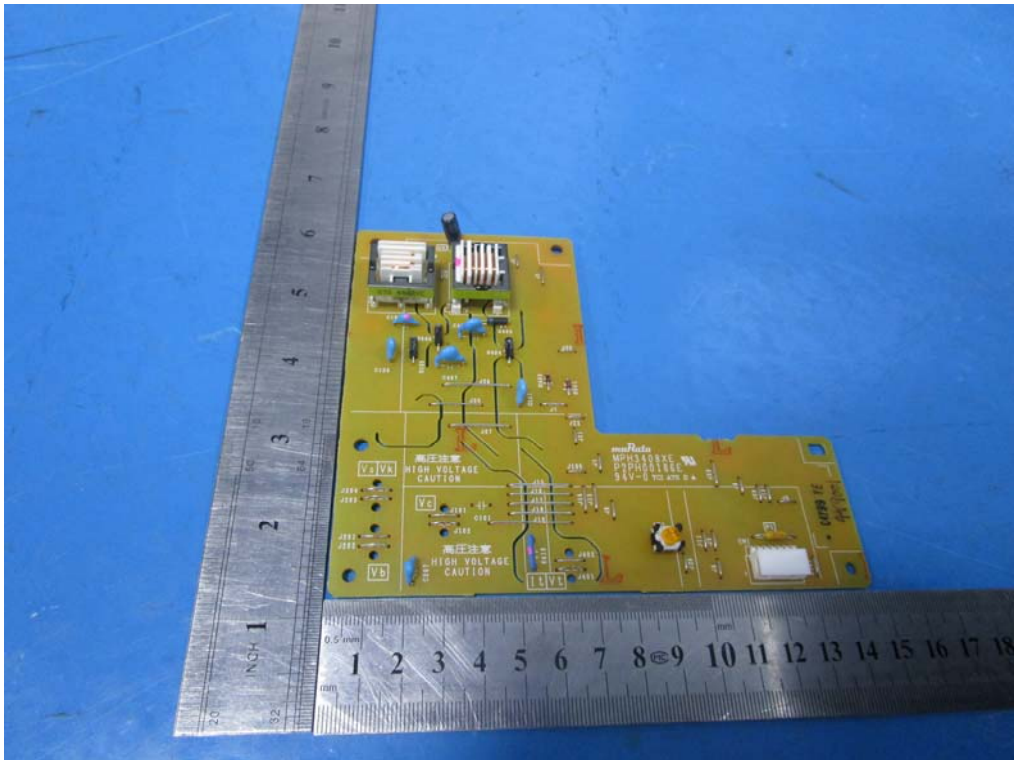

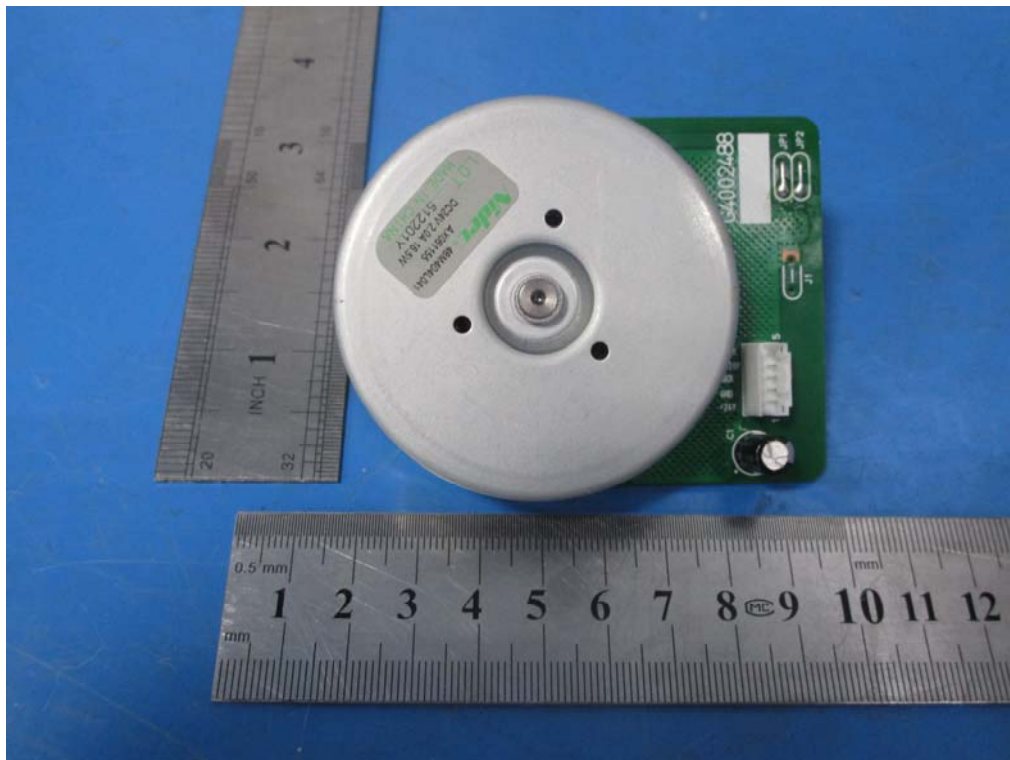

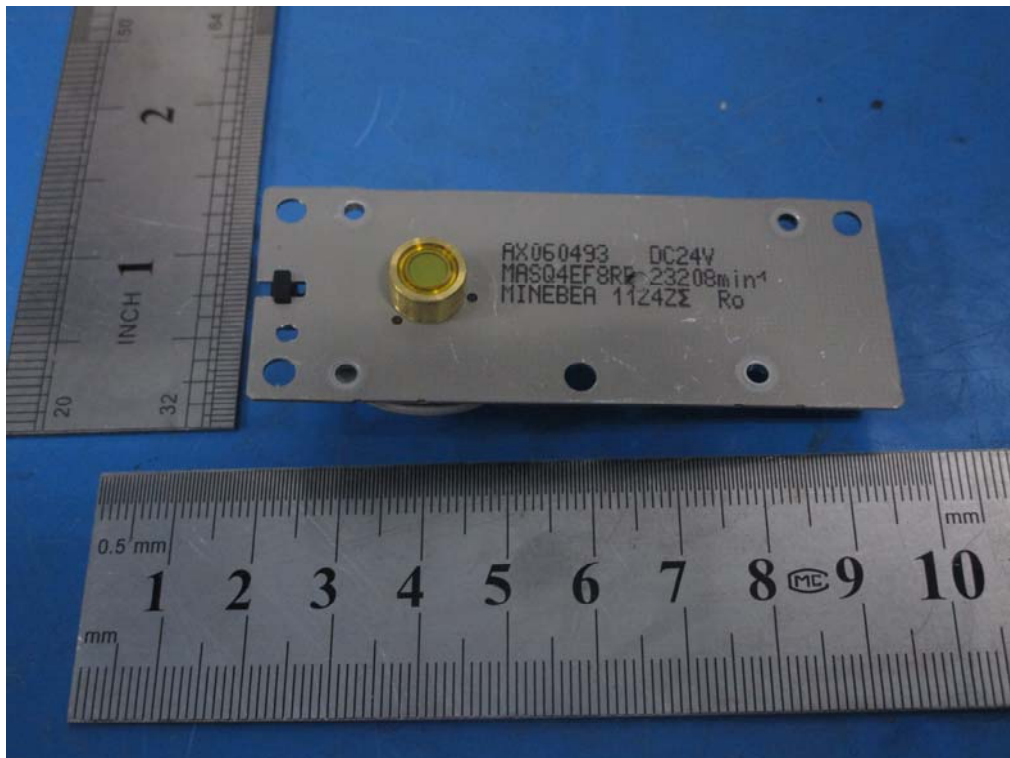
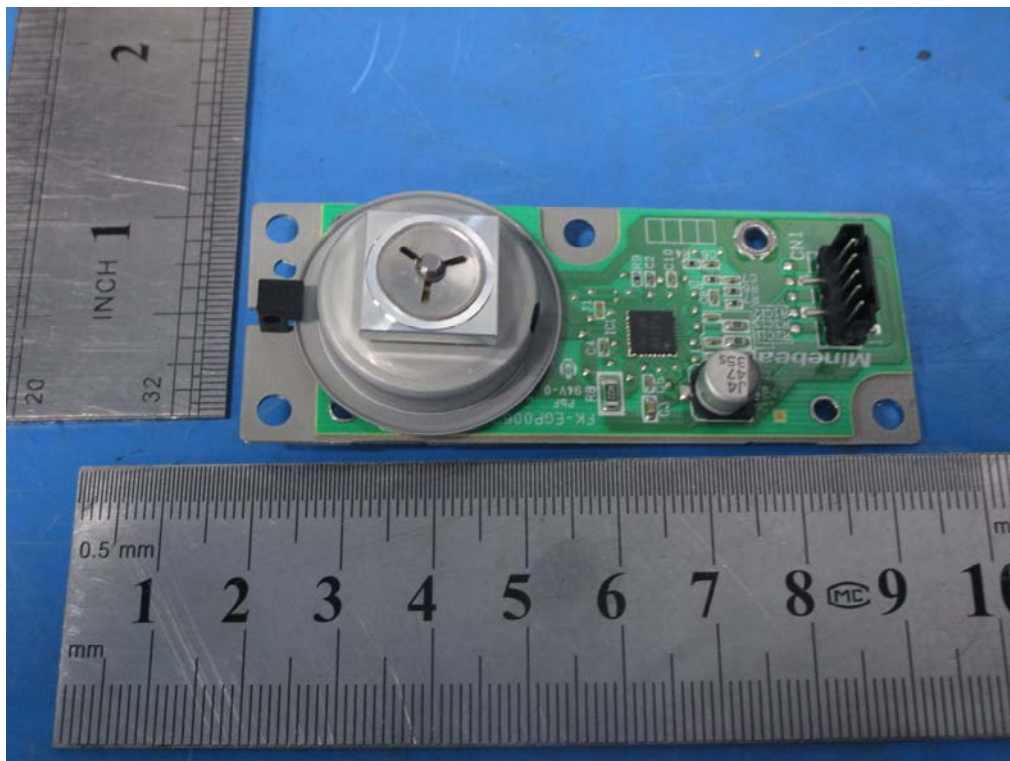

Appendix II: Photographs of EMC Test Configuration

1. Mains Terminal Disturbance Voltage Measurement



2. Radiated Field Strength Measurement

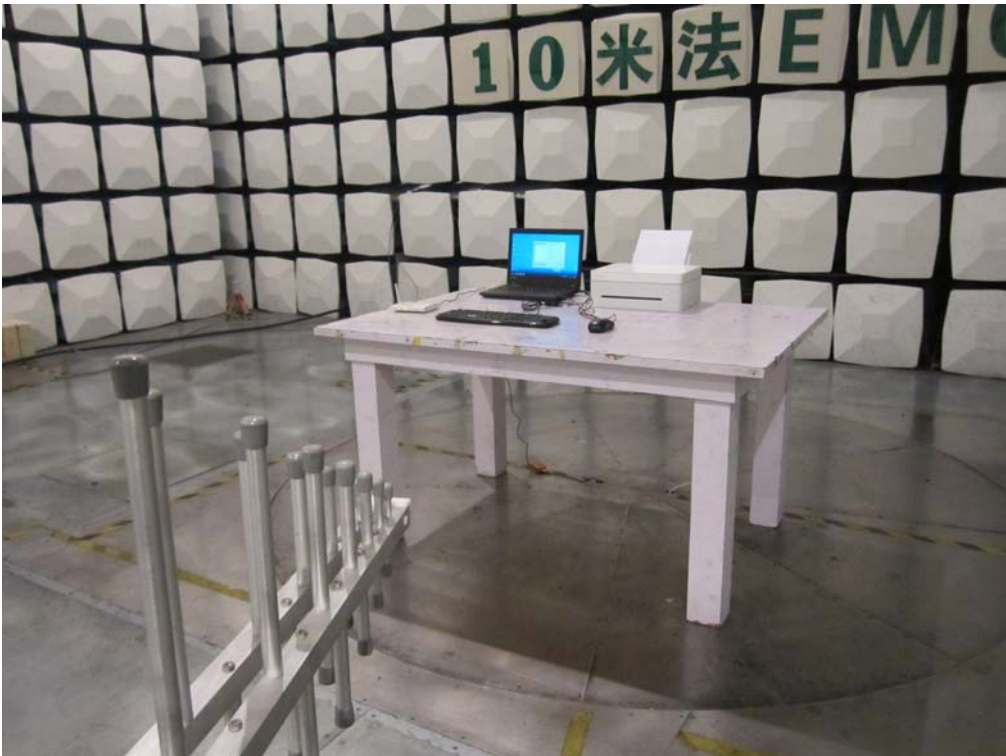

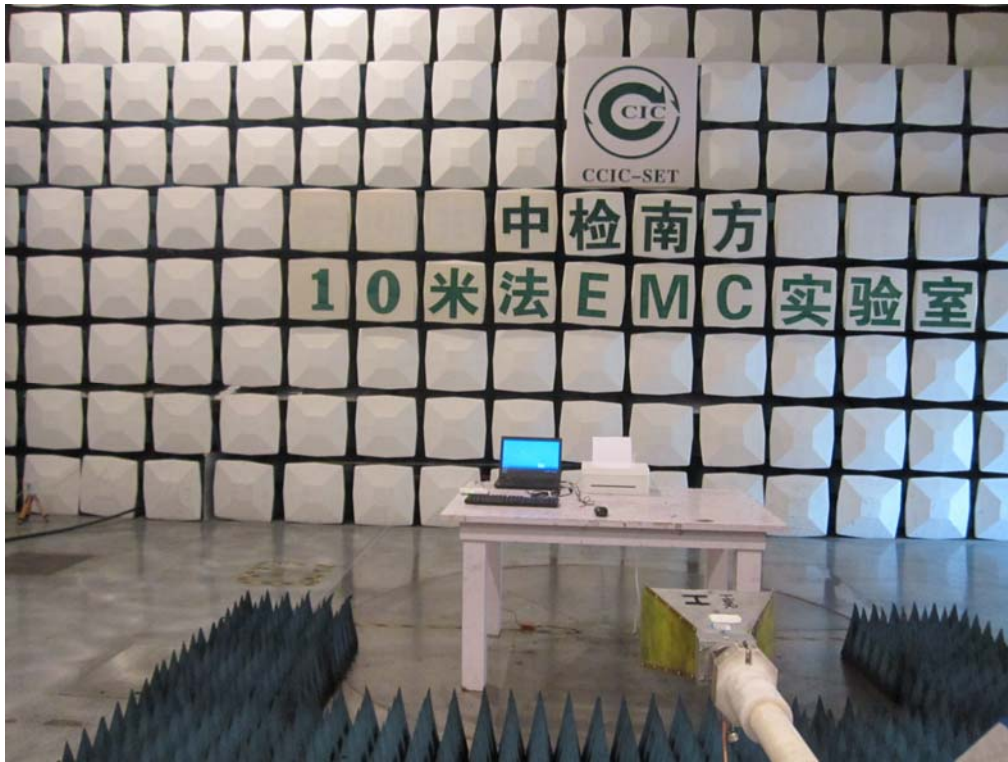

End of Report