



CTC Laboratories, Inc.

2/F., Building 1 and 1-2/F., Building 2, Jiaquan Building, Guanlan High-Tech Park, Longhua District, Shenzhen, Guangdong, China

Tel: +86-755-27521059 Fax: +86-755-27521011 <http://www.sz-ctc.org.cn>

TEST REPORT

Report No. : **CTC20231447E13**

FCC ID..... : **A5M-MD80**

Applicant : **Lenovo (Beijing) Limited**

Address..... : 201-H2-6, Floor 2, Building 2, No.6 Shangdi West Road, Haidian District, Beijing China

Manufacturer..... : Lenovo (Beijing) Limited

Address..... : 201-H2-6, Floor 2, Building 2, No.6 Shangdi West Road, Haidian District, Beijing China

Product Name : **Lenovo Wireless Transmitter**

Trade Mark : Lenovo

Model/Type reference..... : Lenovo MD80

Listed Model(s) : /

Standard : **FCC CFR Title 47 Part 15 Subpart E Section 15.407**

Date of receipt of test sample..... : Jun. 29, 2023

Date of testing..... : Jun. 29, 2023 to Aug. 4, 2023

Date of issue..... : Aug. 5, 2023

Result..... : **PASS**

Compiled by:		
(Printed name+signature)	Jim Jiang	
Supervised by:		
(Printed name+signature)	Eric Zhang	
Approved by:		
(Printed name+signature)	Totti Zhao	

This test report may be duplicated completely for legal use with the approval of the applicant. It should not be reproduced except in full, without the written approval of our laboratory. The client should not use it to claim product endorsement by CTC. The Test Result in the report only apply to the tested sample. The test report shall be invalid without all the signatures of testing engineers, reviewer and approver. Any objections must be raised to CTC within 15 days since the date when the report is received. It will not be taken into consideration beyond this limit. The test report merely corresponds to the test sample.



Table of Contents

Page

1. TEST SUMMARY 3

1.1. TEST STANDARDS..... 3

1.2. REPORT VERSION 3

1.3. TEST DESCRIPTION..... 4

1.4. TEST FACILITY 5

1.5. MEASUREMENT UNCERTAINTY 6

1.6. ENVIRONMENTAL CONDITIONS..... 6

2. GENERAL INFORMATION 7

2.1. CLIENT INFORMATION 7

2.2. GENERAL DESCRIPTION OF EUT 7

2.3. ACCESSORY EQUIPMENT INFORMATION 9

2.4. OPERATION STATE 10

2.5. MEASUREMENT INSTRUMENTS LIST 12

3. TEST ITEM AND RESULTS 13

3.1. CONDUCTED EMISSION..... 13

3.2. RADIATED EMISSION 16

3.3. BAND EDGE EMISSIONS 80

3.4. BANDWIDTH..... 152

3.5. PEAK OUTPUT POWER 220

3.6. POWER SPECTRAL DENSITY 223

3.7. FREQUENCY STABILITY 246

3.8. ANTENNA REQUIREMENT..... 255

3.9. DYNAMIC FREQUENCY SELECTION..... 256



1. TEST SUMMARY

1.1. Test Standards

The tests were performed according to following standards:

[FCC Rules Part 15.407](#): for 802.11a/n/ac/ax, the test procedure follows the FCC KDB 789033 D02 General UNII Test Procedures New Rules V02r01.

[RSS-247 Issue 2](#): Digital Transmission Systems (DTSs), Frequency Hopping Systems (FHSs) and Licence-Exempt Local Area Network (LE-LAN) Devices.

[RSS-Gen Issue 5](#): General Requirements for Compliance of Radio Apparatus.

[ANSI C63.10-2013](#): American National Standard of Procedures for Compliance Testing of Unlicensed Wireless Devices.

1.2. Report Version

Revised No.	Date of issue	Description
01	Aug. 5, 2023	Original



1.3. Test Description

FCC Part 15 Subpart E (15.407) / RSS-247 Issue 2				
Test Item	Standard Section		Result	Test Engineer
	FCC	IC		
Antenna Requirement	15.203	RSS-Gen 6.8	Pass	Jim Jiang
Conducted Emission	15.207	RSS-Gen 8.8	Pass	Jim Jiang
Band Edge Emissions	15.407(b)	RSS-247 6.2	Pass	Jim Jiang
26dB Bandwidth & 99% Bandwidth	15.407(a)	RSS-247 6.2.1.2	Pass	Jim Jiang
6dB Bandwidth (only for UNII-3)	15.407(e)	RSS-247 6.2.4.1	Pass	Jim Jiang
Peak Output Power	15.407(a)	RSS-247 6.2	Pass	Jim Jiang
Power Spectral Density	15.407(a)	RSS-247 6.2	Pass	Jim Jiang
Transmitter Radiated Spurious Emission	15.407(b) & 15.209	RSS-Gen 8.9 RSS-247 6.2	Pass	Jim Jiang
Frequency Stability	15.407(g)	RSS-Gen 6.11	Pass	Jim Jiang
Dynamic Frequency Selection (DFS)	15.407(h)	RSS-247 6.3	Pass	Jim Jiang
Automatically Discontinue Transmission	15.407(c)	RSS-247 6.4(a)	Pass	Note 3

Note:

1. The measurement uncertainty is not included in the test result.
2. N/A: means this test item is not applicable for this device according to the technology characteristic of device.
3. During no any information transmission, the EUT can automatically discontinue transmission and become standby mode for power saving. the EUT can detect the controlling signal of ACK message transmitting from remote device and verify whether it shall resend or discontinue transmission.



1.4. Test Facility

Address of the report laboratory

CTC Laboratories, Inc.

Add: 2/F., Building 1 and 1-2/F., Building 2, Jiaquan Building, Guanlan High-Tech Park, Longhua District, Shenzhen, Guangdong, China

Laboratory accreditation

The test facility is recognized, certified, or accredited by the following organizations:

A2LA-Lab Cert. No.: 4340.01

CTC Laboratories, Inc. EMC Laboratory has been accredited by A2LA for technical competence in the field of electrical testing, and proved to be in compliance with ISO/IEC 17025:2017 General Requirements for the Competence of Testing and Calibration Laboratories and any additional program requirements in the identified field of testing.

Industry Canada (Registration No.: 9783A, CAB Identifier: CN0029)

CTC Laboratories, Inc. EMC Laboratory has been registered by Certification and Engineer Bureau of Industry Canada for the performance of with Registration NO.: 9783A on Jan, 2016.

FCC (Registration No.: 951311, Designation Number CN1208)

CTC Laboratories, Inc. EMC Laboratory has been registered and fully described in a report filed with the (FCC) Federal Communications Commission. The acceptance letter from the FCC is maintained in our files. Registration 951311, Aug 26, 2017.



1.5. Measurement Uncertainty

The data and results referenced in this document are true and accurate. The reader is cautioned that there may be errors within the calibration limits of the equipment and facilities. The measurement uncertainty was calculated for all measurements listed in this test report acc. to TR-100028-01 "Electromagnetic compatibility and Radio spectrum Matters (ERM); Uncertainties in the measurement of mobile radio equipment characteristics; Part 1" and TR-100028-02 "Electromagnetic compatibility and Radio spectrum Matters (ERM); Uncertainties in the measurement of mobile radio equipment characteristics; Part 2" and is documented in the CTC Laboratories, Inc. quality system acc. to DIN EN ISO/IEC 17025. Furthermore, component and process variability of devices similar to that tested may result in additional deviation. The manufacturer has the sole responsibility of continued compliance of the device.

Below is the best measurement capability for CTC Laboratories, Inc.

Test Items	Measurement Uncertainty	Notes
Emission Bandwidth	±0.0196%	(1)
Maximum Conduct Output Power	±0.766dB	(1)
Power Spectral Density	±1.22dB	(1)
Band Edge Measurements	±1.328dB	(1)
Unwanted Emissions Measurement	9kHz-1GHz: ±0.746dB 1GHz-26GHz: ±1.328dB	(1)
Frequency Stability	±2.76%	(1)
Conducted Emissions 9kHz~30MHz	±3.08 dB	(1)
Radiated Emissions 30~1000MHz	±4.51 dB	(1)
Radiated Emissions 1~18GHz	±5.84 dB	(1)
Radiated Emissions 18~40GHz	±6.12 dB	(1)

Note (1): This uncertainty represents an expanded uncertainty expressed at approximately the 95% confidence level using a coverage factor of k=2.

1.6. Environmental Conditions

Normal Condition	Temperature	15 °C to 35 °C
	Relative Humidity	20 % to 75 %
	Air Pressure	101 kPa
	Voltage	The normal test voltage for the equipment shall be the nominal voltage for which the equipment was designed.
Extreme Condition	Temperature	Measurements shall be made over the extremes of the operating temperature range as declared by the manufacturer.
	Voltage	Measurements shall be made over the extremes of the operating temperature range as declared by the manufacturer.

Normal Condition	T _N =Normal Temperature	25 °C
Extreme Condition	T _L =Lower Temperature	0 °C
	T _H =Higher Temperature	40 °C

CTC Laboratories, Inc.

2/F., Building 1 and 1-2/F., Building 2, Jiaquan Building, Guanlan High-Tech Park, Longhua District, Shenzhen, Guangdong, China
Tel.: (86)755-27521059 Fax: (86)755-27521011 Http://www.sz-ctc.org.cn



For anti-fake verification, please visit the official website of Certification and Accreditation Administration of the People's Republic of China : <http://yz.cnca.cn>



2. GENERAL INFORMATION

2.1. Client Information

Applicant:	Lenovo (Beijing) Limited
Address:	201-H2-6, Floor 2, Building 2, No.6 Shangdi West Road, Haidian District, Beijing China
Manufacturer:	Lenovo (Beijing) Limited
Address:	201-H2-6, Floor 2, Building 2, No.6 Shangdi West Road, Haidian District, Beijing China

2.2. General Description of EUT

Product Name:	Lenovo Wireless Transmitter				
Trade Mark:	Lenovo				
Model/Type reference:	Lenovo MD80				
Listed Model(s):	/				
Model Difference:	/				
Power Supply:	DC5V 500mA				
Hardware Version:	20230513-1840-rv1126-md80-8.0.22				
Software Version:	9.VMD80MBV01BSL				
5G Wi-Fi					
Operation Band:	<input checked="" type="checkbox"/> U-NII-1	<input checked="" type="checkbox"/> U-NII-2A	<input checked="" type="checkbox"/> U-NII-2C	<input checked="" type="checkbox"/> U-NII-3	
Operation Frequency:	U-NII-1	5150MHz~5250MHz			
	U-NII-2A	5250MHz~5350MHz			
	U-NII-2C	5470MHz~5725MHz			
	U-NII-3	5725MHz~5850MHz			
Support Bandwidth:	802.11a	<input checked="" type="checkbox"/> 20MHz			
	802.11n	<input checked="" type="checkbox"/> 20MHz	<input checked="" type="checkbox"/> 40MHz		
	802.11ac	<input checked="" type="checkbox"/> 20MHz	<input checked="" type="checkbox"/> 40MHz	<input checked="" type="checkbox"/> 80MHz	<input type="checkbox"/> 160MHz
	802.11ax	<input type="checkbox"/> 20MHz	<input type="checkbox"/> 40MHz	<input type="checkbox"/> 80MHz	<input type="checkbox"/> 160MHz
Modulation:	802.11a: OFDM (BIT/SK, QPSK, BPSK, 16QAM) 802.11n: OFDM (BIT/SK, QPSK, BPSK, 16QAM, 64QAM) 802.11ac: OFDM (BIT/SK, QPSK, BPSK, 16QAM, 64QAM, 256QAM)				
Bit Rate of Transmitter:	802.11a: 6/9/12/18/24/36/48/54Mbps 802.11n: up to 300Mbps 802.11ac: at most 866.7Mbps				
Antenna 1 Type:	Iron Antenna				
Antenna 2 Type:	FPC Antenna				
Antenna 1 Gain:	3.86dBi				



Antenna 2 Gain:	1.57dBi
Directional Gain:	5.80dBi



2.3. Accessory Equipment Information

Equipment Information			
Name	Model	S/N	Manufacturer
Notebook	ThinkPad T460s	/	Lenovo
GPON Terminal	EG8247Q (FCC ID: QISEG8247Q)	/	HUAWEI
Cable Information			
Name	Shielded Type	Ferrite Core	Length
/	/	/	/
Test Software Information			
Name	Version	/	/
SecureCRT	V7.1.1	/	/



2.4. Operation State

Operation Frequency List: The EUT has been tested under typical operating condition. The Applicant provides communication tools software to control the EUT for staying in continuous transmitting.

Operation Frequency List:

Operating Band	20MHz Bandwidth		40MHz Bandwidth		80MHz Bandwidth	
	Channel	Frequency (MHz)	Channel	Frequency (MHz)	Channel	Frequency (MHz)
U-NII-1	36	5180	38	5190	42	5210
	40	5200				
	44	5220	46	5230		
	48	5240				
U-NII-2A	52	5260	54	5270	58	5290
	56	5280				
	60	5300	62	5310		
	64	5320				
U-NII-2C	100	5500	102	5510	106	5530
	104	5520				
	108	5540	110	5550		
	112	5560				
	116	5580	118	5590	122	5610
	120	5600				
	124	5620	126	5630		
	128	5640				
	132	5660	134	5670		
	136	5680				
140	5700					
U-NII-3	149	5745	151	5755	155	5775
	153	5765				
	157	5785	159	5795		
	161	5805				
	165	5825				



Test channel is below:

Operating Band	Test Channel	20MHz Bandwidth		40MHz Bandwidth		80MHz Bandwidth	
		Channel	Frequency (MHz)	Channel	Frequency (MHz)	Channel	Frequency (MHz)
U-NII-1	CH _L	36	5180	38	5190	/	/
	CH _M	40	5200	/	/	42	5210
	CH _H	48	5240	46	5230	/	/
U-NII-2A	CH _L	52	5260	54	5270	/	/
	CH _M	56	5280	/	/	58	5290
	CH _H	64	5320	62	5310	/	/
U-NII-2C	CH _L	100	5500	102	5510	106	5530
	CH _M	116	5580	110	5550	/	/
	CH _H	140	5700	134	5670	122	5610
U-NII-3	CH _L	149	5745	151	5755	/	/
	CH _M	157	5785	/	/	155	5775
	CH _H	165	5825	159	5795	/	/

Data Rated: Preliminary tests were performed in different data rate, and found which the below bit rate is worst case mode, so only show data which it is a worst case mode.

Test Mode	Data Rate (worst mode)
802.11a	6Mbps
802.11n(HT20)/ 802.11n(HT40)	HT-MCS0
802.11ac(VHT20)/ 802.11ac(VHT40)/ 802.11ac(VHT80)	VHT-MCS0

Test Mode:

For RF test items:
The engineering test program was provided and enabled to make EUT continuous transmit.
For AC power line conducted emissions:
The EUT was set to connect with the WLAN AP under large package sizes transmission.
For Radiated spurious emissions test item:
The engineering test program was provided and enabled to make EUT continuous transmit. The EUT in each of three orthogonal axis emissions had been tested, but only the worst case (X axis) data recorded in the report.
For DFS test items:
The EUT has been tested under test mode condition. The Applicant provides software to control the EUT for staying in DFS mode for testing.



2.5. Measurement Instruments List

Tonscend RF Test System					
Item	Test Equipment	Manufacturer	Model No.	Serial No.	Calibrated Until
1	MXA Signal Analyzer	Keysight	N9020A	MY46471737	Dec. 16, 2023
2	Spectrum Analyzer	R&S	FSU26	100105	Dec. 16, 2023
3	Spectrum Analyzer	R&S	FSV40-N	101331	Mar. 14, 2024
4	MXG Vector Signal Generator	Agilent	N5182A	MY47420864	Dec. 16, 2023
5	PSG Analog Signal Generator	Agilent	E8257D	MY46521908	Dec. 16, 2023
6	Power Sensor	Keysight	U2021XA	MY55130004	Mar. 14, 2024
7	Power Sensor	Keysight	U2021XA	MY55130006	Mar. 14, 2024
8	Wideband Radio Communication Tester	R&S	CMW500	102414	Dec. 16, 2023
9	High and low temperature box	ESPEC	MT3035	/	Mar. 24, 2024
10	JS1120 RF Test System	TONSCEND	v2.6	/	/

Radiated Emission (3m chamber 2)					
Item	Test Equipment	Manufacturer	Model No.	Serial No.	Calibrated Until
1	Trilog-Broadband Antenna	Schwarzbeck	VULB 9168	9168-1013	Dec. 07, 2024
2	Horn Antenna	Schwarzbeck	BBHA 9120D	9120D-648	Dec. 07, 2024
3	Spectrum Analyzer	R&S	FSU26	100105	Dec. 16, 2023
4	Spectrum Analyzer	R&S	FSV40-N	101331	Mar. 14, 2024
5	Pre-Amplifier	SONOMA	310	186194	Dec. 16, 2023
6	Low Noise Pre-Amplifier	EMCI	EMC051835	980075	Dec. 16, 2023
7	Test Receiver	R&S	ESC17	100967	Dec. 16, 2023
8	3m chamber 2	Frankonia	EE025	/	Oct. 23, 2024

Conducted Emission					
Item	Test Equipment	Manufacturer	Model No.	Serial No.	Calibrated Until
1	LISN	R&S	ENV216	101112	Dec. 16, 2023
2	LISN	R&S	ENV216	101113	Dec. 16, 2023
3	EMI Test Receiver	R&S	ESCS30	100353	Dec. 16, 2023
4	ISN CAT6	Schwarzbeck	NTFM 8158	CAT6-8158-0046	Dec. 16, 2023
5	ISN CAT5	Schwarzbeck	NTFM 8158	CAT5-8158-0046	Dec. 16, 2023

Note: 1. The Cal. Interval was one year.

2. The Cal. Interval was three years of the antenna.

3. The cable loss has been calculated in test result which connection between each test instruments.

CTC Laboratories, Inc.

2/F., Building 1 and 1-2/F., Building 2, Jiaquan Building, Guanlan High-Tech Park, Longhua District, Shenzhen, Guangdong, China
Tel.: (86)755-27521059 Fax: (86)755-27521011 Http://www.sz-ctc.org.cn



For anti-fake verification, please visit the official website of Certification and Accreditation Administration of the People's Republic of China : <http://yz.cnca.cn>

3. TEST ITEM AND RESULTS

3.1. Conducted Emission

Limit

FCC CFR Title 47 Part 15 Subpart C Section 15.207 / RSS-Gen 8.8

Frequency (MHz)	Conducted Limit (dBμV)	
	Quasi-peak	Average
0.15 - 0.5	66 to 56 *	56 to 46 *
0.5 - 5	56	46
5 - 30	60	50

* Decreases with the logarithm of the frequency.

Test Configuration

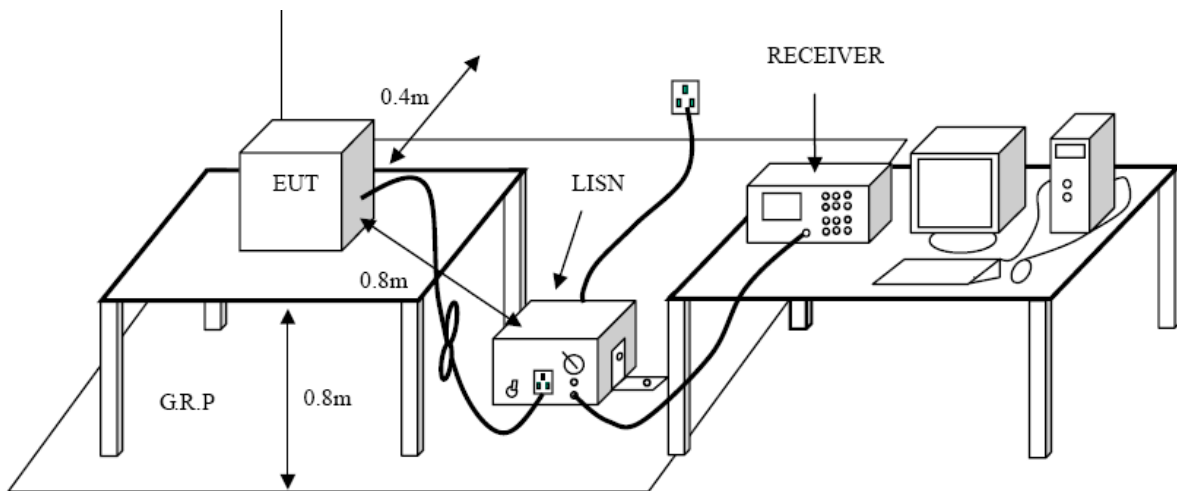

Test Procedure

1. The EUT was setup according to ANSI C63.10:2013 requirements.
2. The EUT was placed on a platform of nominal size, 1 m by 1.5 m, raised 80 cm above the conducting ground plane. The vertical conducting plane was located 40 cm to the rear of the EUT. All other surfaces of EUT were at least 80 cm from any other grounded conducting surface.
3. The EUT and simulators are connected to the main power through a line impedance stabilization network (LISN). The LISN provides a 50 ohm / 50 μH coupling impedance for the measuring equipment.
4. The peripheral devices are also connected to the main power through a LISN. (Please refer to the block diagram of the test setup and photographs)
5. Each current-carrying conductor of the EUT power cord, except the ground (safety) conductor, was individually connected through a LISN to the input power source.
6. The excess length of the power cord between the EUT and the LISN receptacle were folded back and forth at the center of the lead to form a bundle not exceeding 40 cm in length.
7. Conducted emissions were investigated over the frequency range from 0.15MHz to 30MHz using a receiver bandwidth of 9 kHz.
8. During the above scans, the emissions were maximized by cable manipulation.

Test Mode

Please refer to the clause 2.4.



Test Result

Test Voltage:	AC 120V/60Hz
Terminal:	Line
Remark:	Only worse case is reported

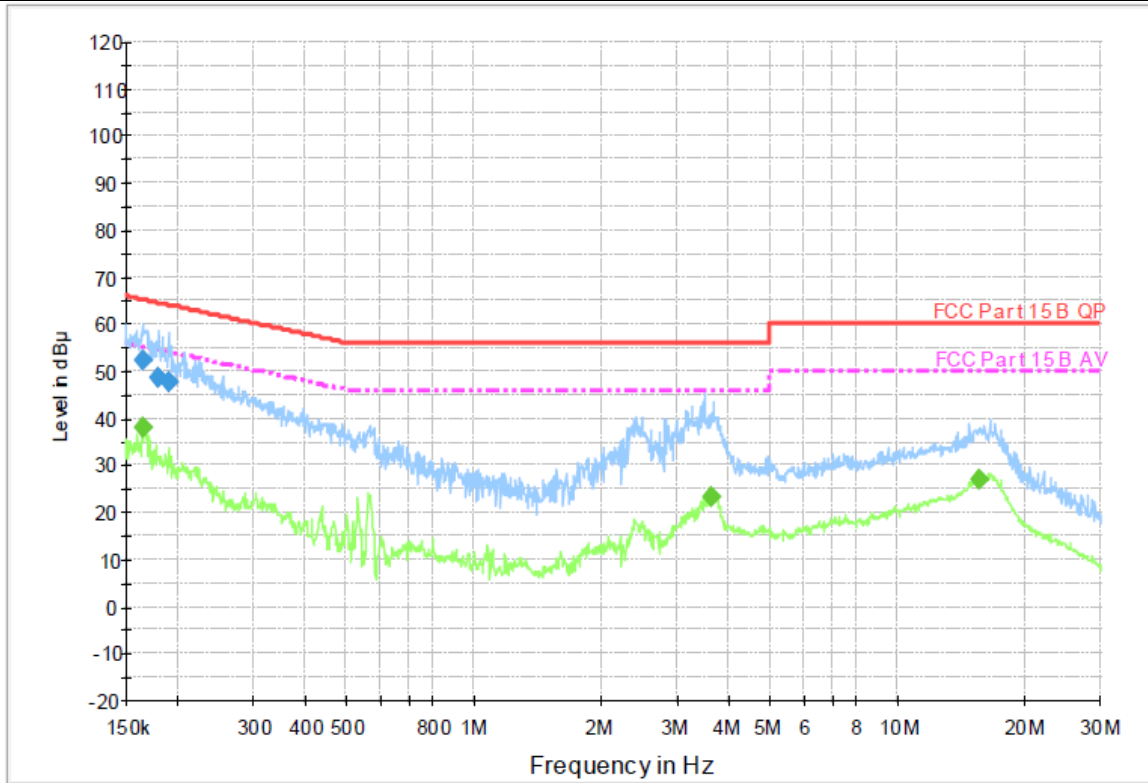

Final Measurement Detector 1

Frequency (MHz)	QuasiPeak (dBμ V)	Meas. Time (ms)	Bandwidth (kHz)	Filter	Line	Corr. (dB)	Margin (dB)	Limit (dBμ V)	Comment
0.164420	52.2	1000.00	9.000	On	L1	9.7	13.0	65.2	
0.179520	48.5	1000.00	9.000	On	L1	9.7	16.0	64.5	
0.189080	47.7	1000.00	9.000	On	L1	9.7	16.4	64.1	

Final Measurement Detector 2

Frequency (MHz)	Average (dBμ V)	Meas. Time (ms)	Bandwidth (kHz)	Filter	Line	Corr. (dB)	Margin (dB)	Limit (dBμ V)	Comment
0.164420	37.9	1000.00	9.000	On	L1	9.7	17.3	55.2	
3.627390	23.4	1000.00	9.000	On	L1	9.7	22.6	46.0	
15.450130	26.9	1000.00	9.000	On	L1	9.8	23.1	50.0	

Emission Level = Read Level + Correct Factor





Test Voltage:	AC 120V/60Hz
Terminal:	Neutral
Remark:	Only worse case is reported

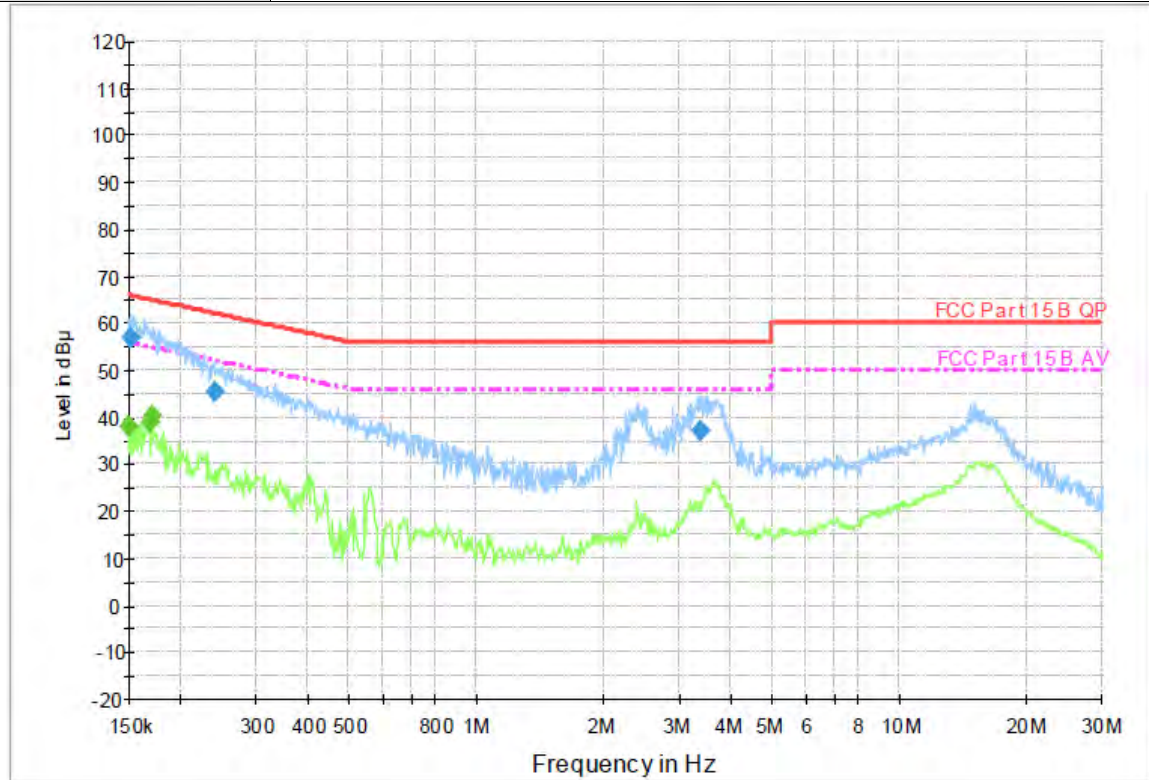

Final Measurement Detector 1

Frequency (MHz)	QuasiPeak (dBµ V)	Meas. Time (ms)	Bandwidth (kHz)	Filter	Line	Corr. (dB)	Margin (dB)	Limit (dBµ V)	Comment
0.151810	56.7	1000.00	9.000	On	N	10.0	9.2	65.9	
0.239300	45.6	1000.00	9.000	On	N	10.0	16.5	62.1	
3.389390	37.2	1000.00	9.000	On	N	10.0	18.8	56.0	

Final Measurement Detector 2

Frequency (MHz)	Average (dBµ V)	Meas. Time (ms)	Bandwidth (kHz)	Filter	Line	Corr. (dB)	Margin (dB)	Limit (dBµ V)	Comment
0.150000	38.1	1000.00	9.000	On	N	10.0	18.0	56.0	
0.168410	39.0	1000.00	9.000	On	N	10.0	16.0	55.0	
0.169760	40.5	1000.00	9.000	On	N	10.0	14.5	55.0	

Emission Level = Read Level + Correct Factor





3.2. Radiated Emission

Limit

FCC CFR Title 47 Part 15 Subpart C Section 15.209 / RSS-Gen 8.9

Frequency (MHz)	Field Strength (microvolts/meter)	Measurement Distance (meters)
0.009~0.490	2400/F (kHz)	300
0.490~1.705	24000/F (kHz)	30
1.705~30.0	30	30
30~88	100	3
88~216	150	3
216~960	200	3
960~1000	500	3

Frequency Range (MHz)	dBµV/m (at 3 meters)	
	Peak	Average
Above 1000	74	54

Note:

- (1) The tighter limit applies at the band edges.
- (2) Emission Level (dBµV/m)=20log Emission Level (µV/m).

Limits of unwanted emission out of the restricted bands

FCC CFR Title 47 Part 15 Subpart E Section 15. 407(b) / RSS-247 6.2

Frequency (MHz)	EIRP Limits (dBm)	Equivalent Field Strength at 3m (dBµV/m)
5150~5250	-27	68.2
5250~5350	-27	68.2
5470~5725	-27	68.2
5725~5825	-27 (Note 2)	68.2
	10 (Note 2)	105.2
	15.6 (Note 2)	110.8
	27 (Note 2)	122.2

Note:

1. The following formula is used to convert the equipment isotropic radiated power (eirp) to field

strength: $E = \frac{1000000\sqrt{30P}}{3}$ µV/m, where P is the eirp (Watts).

2. According to FCC 16-24, all emissions shall be limited to a level of -27 dBm/MHz at 75 MHz or more above or below the band edge increasing linearly to 10 dBm/MHz at 25 MHz above or below the band edge, and from 25MHz above or below the band edge increasing linearly to a level of 15.6 dBm/MHz at 5 MHz above or below the band edge, and from 5 MHz above or below the band edge increasing linearly to a level of 27dBm/MHz at the band edge.

CTC Laboratories, Inc.

2/F., Building 1 and 1-2/F., Building 2, Jiaquan Building, Guanlan High-Tech Park, Longhua District, Shenzhen, Guangdong, China
Tel.: (86)755-27521059 Fax: (86)755-27521011 Http://www.sz-ctc.org.cn



For anti-fake verification, please visit the official website of Certification and Accreditation Administration of the People's Republic of China : <http://yz.cnca.cn>

Test Configuration

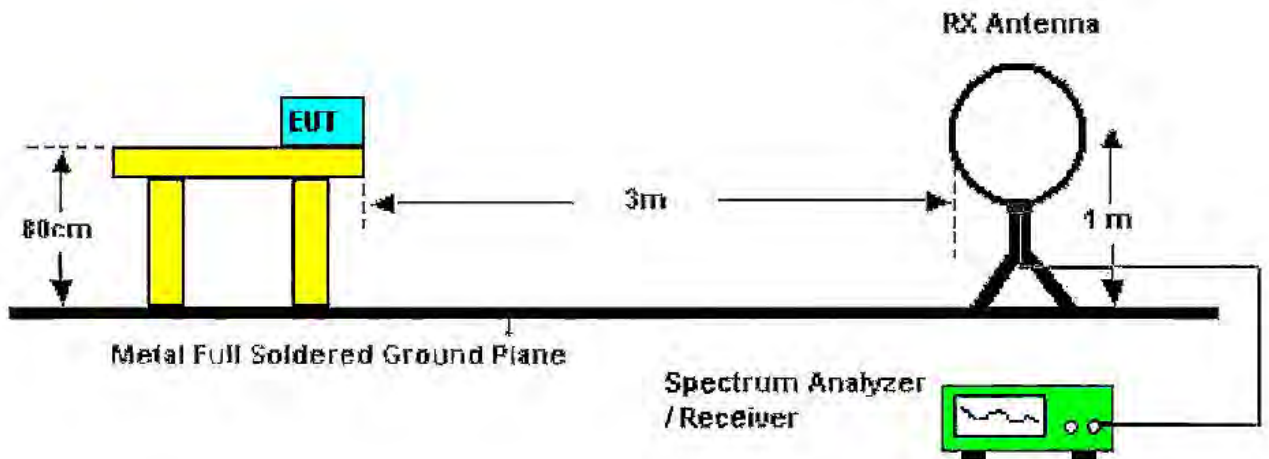

Below 30MHz Test Setup

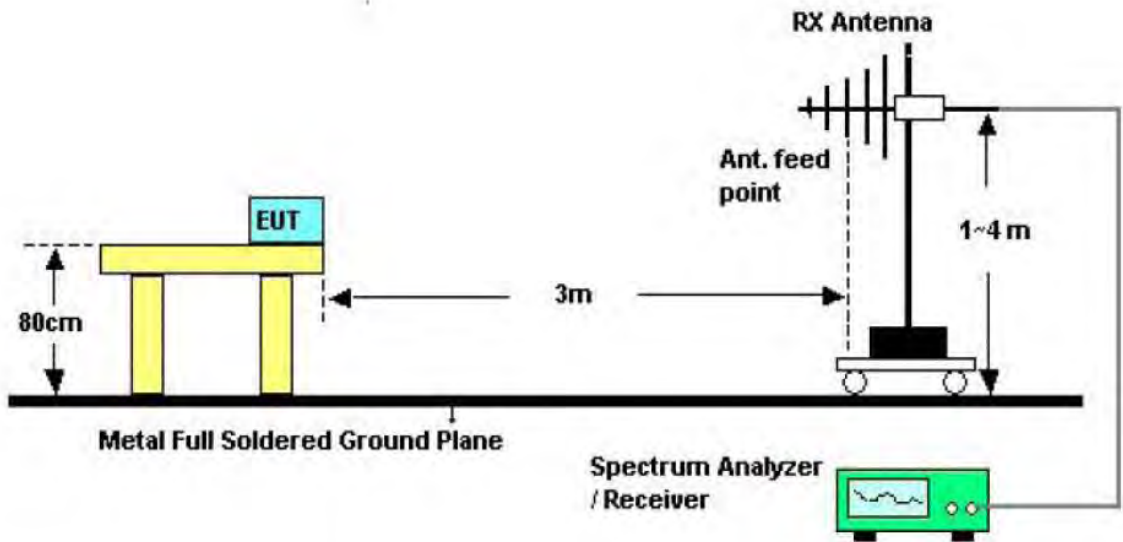

30-1000MHz Test Setup

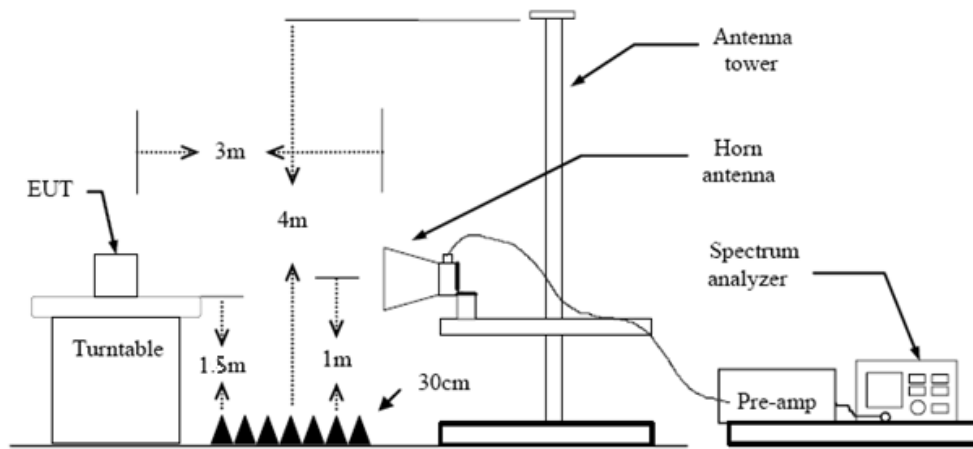

Above 1GHz Test Setup



Test Procedure

1. The EUT was setup and tested according to ANSI C63.10:2013.
 2. The EUT is placed on a turn table which is 0.8 meter above ground for below 1 GHz, and 1.5 m for above 1 GHz. The turn table is rotated 360 degrees to determine the position of the maximum emission level.
 3. The EUT was set 3 meters from the receiving antenna, which was mounted on the top of a variable height antenna tower.
 4. For each suspected emission, the EUT was arranged to its worst case and then tune the Antenna tower (from 1 m to 4 m) and turntable (from 0 degree to 360 degrees) to find the maximum reading. A pre-amp and a high pass filter are used for the test in order to get better signal level to comply with the guidelines.
 5. Set to the maximum power setting and enable the EUT transmit continuously.
 6. Use the following spectrum analyzer settings
 - (1) Span shall wide enough to fully capture the emission being measured;
 - (2) Below 1 GHz:
RBW=120 kHz, VBW=300 kHz, Sweep=auto, Detector function=peak, Trace=max hold;
If the emission level of the EUT measured by the peak detector is 3 dB lower than the applicable limit, the peak emission level will be reported. Otherwise, the emission measurement will be repeated using the quasi-peak detector and reported.
 - (3) From 1 GHz to 10th harmonic:
RBW=1MHz, VBW=3MHz Peak detector for Peak value.
RBW=1MHz, VBW see note 1 with Peak Detector for Average Value.
- Note 1: For measurements above 1 GHz the resolution bandwidth is set to 1 MHz, then the video bandwidth is set to 3 MHz for peak measurements and 1 MHz resolution bandwidth with 1/T video bandwidth with peak detector for average measurements. For the Duty Cycle please refer to clause Duty Cycle.

Test Mode

Please refer to the clause 2.4.

Test Result

9 kHz~30 MHz

From 9 kHz to 30 MHz: The conclusion is PASS.

Note:

1. The amplitude of spurious emissions which are attenuated by more than 20dB below the permissible value has no need to be reported.
2. Pre-scan all antenna, only show the test data for worse case antenna on the test report.



30MHz-1GHz

Ant. No.	Ant 2
Ant. Pol.	Horizontal
Test Mode:	TX 802.11a Mode 5180MHz (U-NII-1)
Remark:	Only worse case is reported.

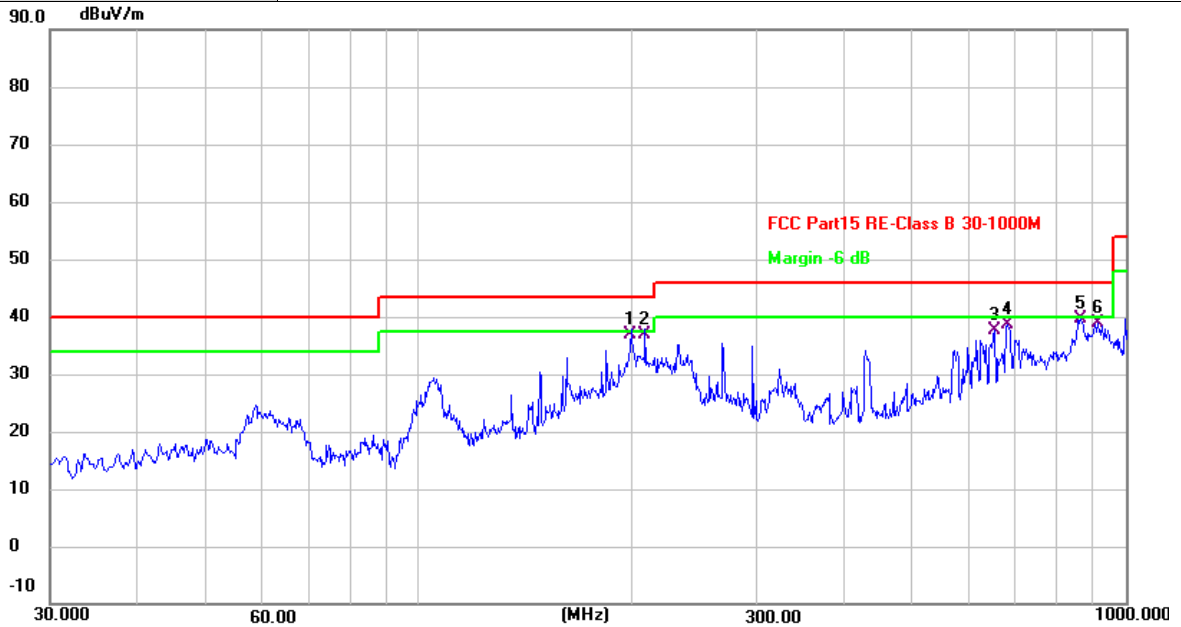

No.	Frequency (MHz)	Reading (dBuV)	Factor (dB/m)	Level (dBuV/m)	Limit (dBuV/m)	Margin (dB)	Detector
1	199.4265	53.01	-16.12	36.89	43.50	-6.61	QP
2	208.8033	52.76	-15.82	36.94	43.50	-6.56	QP
3	652.0932	43.64	-6.09	37.55	46.00	-8.45	QP
4	681.5166	44.33	-5.75	38.58	46.00	-7.42	QP
5 *	863.2300	42.76	-3.15	39.61	46.00	-6.39	QP
6	913.0231	41.47	-2.51	38.96	46.00	-7.04	QP

Remarks:

- 1.Factor (dB/m) = Antenna Factor (dB/m)+Cable Factor (dB)-Pre-amplifier Factor
- 2.Margin value = Level -Limit value



Ant. No.	Ant 2
Ant. Pol.	Vertical
Test Mode:	TX 802.11a Mode 5180MHz (U-NII-1)
Remark:	Only worse case is reported.

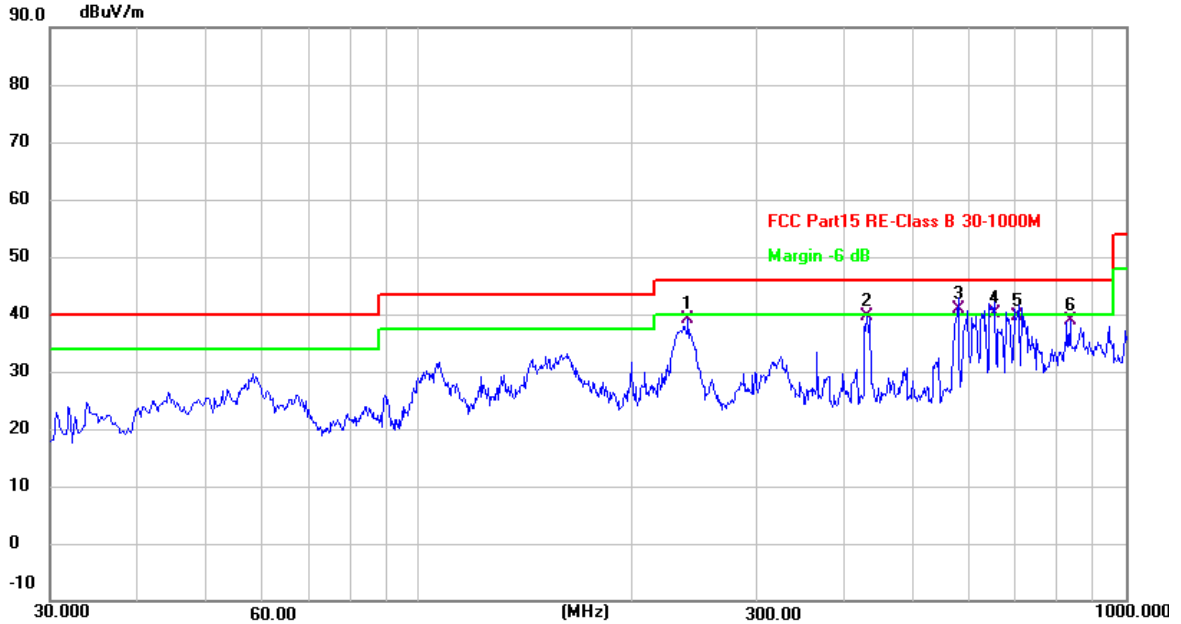

No.	Frequency (MHz)	Reading (dBuV)	Factor (dB/m)	Level (dBuV/m)	Limit (dBuV/m)	Margin (dB)	Detector
1	240.4900	54.00	-14.91	39.09	46.00	-6.91	QP
2	430.6100	50.05	-10.48	39.57	46.00	-6.43	QP
3 *	579.6666	48.09	-7.20	40.89	46.00	-5.11	QP
4 !	652.4166	46.31	-6.08	40.23	46.00	-5.77	QP
5	704.7965	44.98	-5.47	39.51	46.00	-6.49	QP
6	833.4832	42.57	-3.60	38.97	46.00	-7.03	QP

Remarks:

1. Factor (dB/m) = Antenna Factor (dB/m)+Cable Factor (dB)-Pre-amplifier Factor
2. Margin value = Level -Limit value



Above 1GHz

Ant. No.	Ant 2																														
Ant. Pol.	Horizontal																														
Test Mode:	TX 802.11a Mode 5180MHz (U-NII-1)																														
Remark:	No report for the emission which more than 20 dB below the prescribed limit.																														
<table border="1"> <thead> <tr> <th>No.</th> <th>Frequency (MHz)</th> <th>Reading (dBuV)</th> <th>Factor (dB/m)</th> <th>Level (dBuV/m)</th> <th>Limit (dBuV/m)</th> <th>Margin (dB)</th> <th>Detector</th> </tr> </thead> <tbody> <tr> <td>1 *</td> <td>10359.850</td> <td>29.22</td> <td>13.60</td> <td>42.82</td> <td>54.00</td> <td>-11.18</td> <td>AVG</td> </tr> <tr> <td>2</td> <td>10360.102</td> <td>41.02</td> <td>13.60</td> <td>54.62</td> <td>74.00</td> <td>-19.38</td> <td>peak</td> </tr> </tbody> </table>								No.	Frequency (MHz)	Reading (dBuV)	Factor (dB/m)	Level (dBuV/m)	Limit (dBuV/m)	Margin (dB)	Detector	1 *	10359.850	29.22	13.60	42.82	54.00	-11.18	AVG	2	10360.102	41.02	13.60	54.62	74.00	-19.38	peak
No.	Frequency (MHz)	Reading (dBuV)	Factor (dB/m)	Level (dBuV/m)	Limit (dBuV/m)	Margin (dB)	Detector																								
1 *	10359.850	29.22	13.60	42.82	54.00	-11.18	AVG																								
2	10360.102	41.02	13.60	54.62	74.00	-19.38	peak																								
Remarks: 1.Factor (dB/m) = Antenna Factor (dB/m)+Cable Factor (dB)-Pre-amplifier Factor 2.Margin value = Level -Limit value																															

Ant. No.	Ant 2																														
Ant. Pol.	Vertical																														
Test Mode:	TX 802.11a Mode 5180MHz (U-NII-1)																														
Remark:	No report for the emission which more than 20 dB below the prescribed limit.																														
<table border="1"> <thead> <tr> <th>No.</th> <th>Frequency (MHz)</th> <th>Reading (dBuV)</th> <th>Factor (dB/m)</th> <th>Level (dBuV/m)</th> <th>Limit (dBuV/m)</th> <th>Margin (dB)</th> <th>Detector</th> </tr> </thead> <tbody> <tr> <td>1</td> <td>10360.105</td> <td>41.08</td> <td>13.60</td> <td>54.68</td> <td>74.00</td> <td>-19.32</td> <td>peak</td> </tr> <tr> <td>2 *</td> <td>10360.188</td> <td>29.59</td> <td>13.60</td> <td>43.19</td> <td>54.00</td> <td>-10.81</td> <td>AVG</td> </tr> </tbody> </table>								No.	Frequency (MHz)	Reading (dBuV)	Factor (dB/m)	Level (dBuV/m)	Limit (dBuV/m)	Margin (dB)	Detector	1	10360.105	41.08	13.60	54.68	74.00	-19.32	peak	2 *	10360.188	29.59	13.60	43.19	54.00	-10.81	AVG
No.	Frequency (MHz)	Reading (dBuV)	Factor (dB/m)	Level (dBuV/m)	Limit (dBuV/m)	Margin (dB)	Detector																								
1	10360.105	41.08	13.60	54.68	74.00	-19.32	peak																								
2 *	10360.188	29.59	13.60	43.19	54.00	-10.81	AVG																								
Remarks: 1.Factor (dB/m) = Antenna Factor (dB/m)+Cable Factor (dB)-Pre-amplifier Factor 2.Margin value = Level -Limit value																															



Ant. No.	Ant 2																														
Ant. Pol.	Horizontal																														
Test Mode:	TX 802.11a Mode 5200MHz (U-NII-1)																														
Remark:	No report for the emission which more than 20 dB below the prescribed limit.																														
<table border="1"> <thead> <tr> <th>No.</th> <th>Frequency (MHz)</th> <th>Reading (dBuV)</th> <th>Factor (dB/m)</th> <th>Level (dBuV/m)</th> <th>Limit (dBuV/m)</th> <th>Margin (dB)</th> <th>Detector</th> </tr> </thead> <tbody> <tr> <td>1</td> <td>10399.785</td> <td>40.30</td> <td>13.67</td> <td>53.97</td> <td>74.00</td> <td>-20.03</td> <td>peak</td> </tr> <tr> <td>2 *</td> <td>10400.243</td> <td>28.96</td> <td>13.67</td> <td>42.63</td> <td>54.00</td> <td>-11.37</td> <td>AVG</td> </tr> </tbody> </table>								No.	Frequency (MHz)	Reading (dBuV)	Factor (dB/m)	Level (dBuV/m)	Limit (dBuV/m)	Margin (dB)	Detector	1	10399.785	40.30	13.67	53.97	74.00	-20.03	peak	2 *	10400.243	28.96	13.67	42.63	54.00	-11.37	AVG
No.	Frequency (MHz)	Reading (dBuV)	Factor (dB/m)	Level (dBuV/m)	Limit (dBuV/m)	Margin (dB)	Detector																								
1	10399.785	40.30	13.67	53.97	74.00	-20.03	peak																								
2 *	10400.243	28.96	13.67	42.63	54.00	-11.37	AVG																								
Remarks: 1. Factor (dB/m) = Antenna Factor (dB/m)+Cable Factor (dB)-Pre-amplifier Factor 2. Margin value = Level -Limit value																															

Ant. No.	Ant 2																														
Ant. Pol.	Vertical																														
Test Mode:	TX 802.11a Mode 5200MHz (U-NII-1)																														
Remark:	No report for the emission which more than 20 dB below the prescribed limit.																														
<table border="1"> <thead> <tr> <th>No.</th> <th>Frequency (MHz)</th> <th>Reading (dBuV)</th> <th>Factor (dB/m)</th> <th>Level (dBuV/m)</th> <th>Limit (dBuV/m)</th> <th>Margin (dB)</th> <th>Detector</th> </tr> </thead> <tbody> <tr> <td>1 *</td> <td>10400.129</td> <td>30.13</td> <td>13.67</td> <td>43.80</td> <td>54.00</td> <td>-10.20</td> <td>AVG</td> </tr> <tr> <td>2</td> <td>10400.160</td> <td>40.36</td> <td>13.67</td> <td>54.03</td> <td>74.00</td> <td>-19.97</td> <td>peak</td> </tr> </tbody> </table>								No.	Frequency (MHz)	Reading (dBuV)	Factor (dB/m)	Level (dBuV/m)	Limit (dBuV/m)	Margin (dB)	Detector	1 *	10400.129	30.13	13.67	43.80	54.00	-10.20	AVG	2	10400.160	40.36	13.67	54.03	74.00	-19.97	peak
No.	Frequency (MHz)	Reading (dBuV)	Factor (dB/m)	Level (dBuV/m)	Limit (dBuV/m)	Margin (dB)	Detector																								
1 *	10400.129	30.13	13.67	43.80	54.00	-10.20	AVG																								
2	10400.160	40.36	13.67	54.03	74.00	-19.97	peak																								
Remarks: 1. Factor (dB/m) = Antenna Factor (dB/m)+Cable Factor (dB)-Pre-amplifier Factor 2. Margin value = Level -Limit value																															



Ant. No.	Ant 2																														
Ant. Pol.	Horizontal																														
Test Mode:	TX 802.11a Mode 5240MHz (U-NII-1)																														
Remark:	No report for the emission which more than 20 dB below the prescribed limit.																														
<table border="1"> <thead> <tr> <th>No.</th> <th>Frequency (MHz)</th> <th>Reading (dBuV)</th> <th>Factor (dB/m)</th> <th>Level (dBuV/m)</th> <th>Limit (dBuV/m)</th> <th>Margin (dB)</th> <th>Detector</th> </tr> </thead> <tbody> <tr> <td>1 *</td> <td>10479.801</td> <td>29.26</td> <td>13.80</td> <td>43.06</td> <td>54.00</td> <td>-10.94</td> <td>AVG</td> </tr> <tr> <td>2</td> <td>10480.210</td> <td>40.13</td> <td>13.80</td> <td>53.93</td> <td>74.00</td> <td>-20.07</td> <td>peak</td> </tr> </tbody> </table>								No.	Frequency (MHz)	Reading (dBuV)	Factor (dB/m)	Level (dBuV/m)	Limit (dBuV/m)	Margin (dB)	Detector	1 *	10479.801	29.26	13.80	43.06	54.00	-10.94	AVG	2	10480.210	40.13	13.80	53.93	74.00	-20.07	peak
No.	Frequency (MHz)	Reading (dBuV)	Factor (dB/m)	Level (dBuV/m)	Limit (dBuV/m)	Margin (dB)	Detector																								
1 *	10479.801	29.26	13.80	43.06	54.00	-10.94	AVG																								
2	10480.210	40.13	13.80	53.93	74.00	-20.07	peak																								
Remarks: 1.Factor (dB/m) = Antenna Factor (dB/m)+Cable Factor (dB)-Pre-amplifier Factor 2.Margin value = Level -Limit value																															

Ant. No.	Ant 2																														
Ant. Pol.	Vertical																														
Test Mode:	TX 802.11a Mode 5240MHz (U-NII-1)																														
Remark:	No report for the emission which more than 20 dB below the prescribed limit.																														
<table border="1"> <thead> <tr> <th>No.</th> <th>Frequency (MHz)</th> <th>Reading (dBuV)</th> <th>Factor (dB/m)</th> <th>Level (dBuV/m)</th> <th>Limit (dBuV/m)</th> <th>Margin (dB)</th> <th>Detector</th> </tr> </thead> <tbody> <tr> <td>1 *</td> <td>10479.991</td> <td>29.04</td> <td>13.80</td> <td>42.84</td> <td>54.00</td> <td>-11.16</td> <td>AVG</td> </tr> <tr> <td>2</td> <td>10480.007</td> <td>39.97</td> <td>13.80</td> <td>53.77</td> <td>74.00</td> <td>-20.23</td> <td>peak</td> </tr> </tbody> </table>								No.	Frequency (MHz)	Reading (dBuV)	Factor (dB/m)	Level (dBuV/m)	Limit (dBuV/m)	Margin (dB)	Detector	1 *	10479.991	29.04	13.80	42.84	54.00	-11.16	AVG	2	10480.007	39.97	13.80	53.77	74.00	-20.23	peak
No.	Frequency (MHz)	Reading (dBuV)	Factor (dB/m)	Level (dBuV/m)	Limit (dBuV/m)	Margin (dB)	Detector																								
1 *	10479.991	29.04	13.80	42.84	54.00	-11.16	AVG																								
2	10480.007	39.97	13.80	53.77	74.00	-20.23	peak																								
Remarks: 1.Factor (dB/m) = Antenna Factor (dB/m)+Cable Factor (dB)-Pre-amplifier Factor 2.Margin value = Level -Limit value																															



Ant. No.	Ant 1 + Ant 2																														
Ant. Pol.	Horizontal																														
Test Mode:	TX 802.11n(HT20) Mode 5180MHz (U-NII-1)																														
Remark:	No report for the emission which more than 20 dB below the prescribed limit.																														
<table border="1"> <thead> <tr> <th>No.</th> <th>Frequency (MHz)</th> <th>Reading (dBuV)</th> <th>Factor (dB/m)</th> <th>Level (dBuV/m)</th> <th>Limit (dBuV/m)</th> <th>Margin (dB)</th> <th>Detector</th> </tr> </thead> <tbody> <tr> <td>1</td> <td>10359.863</td> <td>40.00</td> <td>13.60</td> <td>53.60</td> <td>74.00</td> <td>-20.40</td> <td>peak</td> </tr> <tr> <td>2 *</td> <td>10360.141</td> <td>28.06</td> <td>13.60</td> <td>41.66</td> <td>54.00</td> <td>-12.34</td> <td>AVG</td> </tr> </tbody> </table>								No.	Frequency (MHz)	Reading (dBuV)	Factor (dB/m)	Level (dBuV/m)	Limit (dBuV/m)	Margin (dB)	Detector	1	10359.863	40.00	13.60	53.60	74.00	-20.40	peak	2 *	10360.141	28.06	13.60	41.66	54.00	-12.34	AVG
No.	Frequency (MHz)	Reading (dBuV)	Factor (dB/m)	Level (dBuV/m)	Limit (dBuV/m)	Margin (dB)	Detector																								
1	10359.863	40.00	13.60	53.60	74.00	-20.40	peak																								
2 *	10360.141	28.06	13.60	41.66	54.00	-12.34	AVG																								
Remarks: 1.Factor (dB/m) = Antenna Factor (dB/m)+Cable Factor (dB)-Pre-amplifier Factor 2.Margin value = Level -Limit value																															

Ant. No.	Ant 1 + Ant 2																														
Ant. Pol.	Vertical																														
Test Mode:	TX 802.11n(HT20) Mode 5180MHz (U-NII-1)																														
Remark:	No report for the emission which more than 20 dB below the prescribed limit.																														
<table border="1"> <thead> <tr> <th>No.</th> <th>Frequency (MHz)</th> <th>Reading (dBuV)</th> <th>Factor (dB/m)</th> <th>Level (dBuV/m)</th> <th>Limit (dBuV/m)</th> <th>Margin (dB)</th> <th>Detector</th> </tr> </thead> <tbody> <tr> <td>1</td> <td>10359.980</td> <td>40.36</td> <td>13.60</td> <td>53.96</td> <td>74.00</td> <td>-20.04</td> <td>peak</td> </tr> <tr> <td>2 *</td> <td>10360.269</td> <td>28.42</td> <td>13.60</td> <td>42.02</td> <td>54.00</td> <td>-11.98</td> <td>AVG</td> </tr> </tbody> </table>								No.	Frequency (MHz)	Reading (dBuV)	Factor (dB/m)	Level (dBuV/m)	Limit (dBuV/m)	Margin (dB)	Detector	1	10359.980	40.36	13.60	53.96	74.00	-20.04	peak	2 *	10360.269	28.42	13.60	42.02	54.00	-11.98	AVG
No.	Frequency (MHz)	Reading (dBuV)	Factor (dB/m)	Level (dBuV/m)	Limit (dBuV/m)	Margin (dB)	Detector																								
1	10359.980	40.36	13.60	53.96	74.00	-20.04	peak																								
2 *	10360.269	28.42	13.60	42.02	54.00	-11.98	AVG																								
Remarks: 1.Factor (dB/m) = Antenna Factor (dB/m)+Cable Factor (dB)-Pre-amplifier Factor 2.Margin value = Level -Limit value																															



Ant. No.	Ant 1 + Ant 2																														
Ant. Pol.	Horizontal																														
Test Mode:	TX 802.11n(HT20) Mode 5200MHz (U-NII-1)																														
Remark:	No report for the emission which more than 20 dB below the prescribed limit.																														
<table border="1"> <thead> <tr> <th>No.</th> <th>Frequency (MHz)</th> <th>Reading (dBuV)</th> <th>Factor (dB/m)</th> <th>Level (dBuV/m)</th> <th>Limit (dBuV/m)</th> <th>Margin (dB)</th> <th>Detector</th> </tr> </thead> <tbody> <tr> <td>1</td> <td>10399.864</td> <td>39.55</td> <td>13.67</td> <td>53.22</td> <td>74.00</td> <td>-20.78</td> <td>peak</td> </tr> <tr> <td>2 *</td> <td>10400.224</td> <td>27.92</td> <td>13.67</td> <td>41.59</td> <td>54.00</td> <td>-12.41</td> <td>AVG</td> </tr> </tbody> </table>								No.	Frequency (MHz)	Reading (dBuV)	Factor (dB/m)	Level (dBuV/m)	Limit (dBuV/m)	Margin (dB)	Detector	1	10399.864	39.55	13.67	53.22	74.00	-20.78	peak	2 *	10400.224	27.92	13.67	41.59	54.00	-12.41	AVG
No.	Frequency (MHz)	Reading (dBuV)	Factor (dB/m)	Level (dBuV/m)	Limit (dBuV/m)	Margin (dB)	Detector																								
1	10399.864	39.55	13.67	53.22	74.00	-20.78	peak																								
2 *	10400.224	27.92	13.67	41.59	54.00	-12.41	AVG																								
Remarks: 1.Factor (dB/m) = Antenna Factor (dB/m)+Cable Factor (dB)-Pre-amplifier Factor 2.Margin value = Level -Limit value																															

Ant. No.	Ant 1 + Ant 2																														
Ant. Pol.	Vertical																														
Test Mode:	TX 802.11n(HT20) Mode 5200MHz (U-NII-1)																														
Remark:	No report for the emission which more than 20 dB below the prescribed limit.																														
<table border="1"> <thead> <tr> <th>No.</th> <th>Frequency (MHz)</th> <th>Reading (dBuV)</th> <th>Factor (dB/m)</th> <th>Level (dBuV/m)</th> <th>Limit (dBuV/m)</th> <th>Margin (dB)</th> <th>Detector</th> </tr> </thead> <tbody> <tr> <td>1</td> <td>10399.880</td> <td>39.73</td> <td>13.67</td> <td>53.40</td> <td>74.00</td> <td>-20.60</td> <td>peak</td> </tr> <tr> <td>2 *</td> <td>10399.954</td> <td>28.56</td> <td>13.67</td> <td>42.23</td> <td>54.00</td> <td>-11.77</td> <td>AVG</td> </tr> </tbody> </table>								No.	Frequency (MHz)	Reading (dBuV)	Factor (dB/m)	Level (dBuV/m)	Limit (dBuV/m)	Margin (dB)	Detector	1	10399.880	39.73	13.67	53.40	74.00	-20.60	peak	2 *	10399.954	28.56	13.67	42.23	54.00	-11.77	AVG
No.	Frequency (MHz)	Reading (dBuV)	Factor (dB/m)	Level (dBuV/m)	Limit (dBuV/m)	Margin (dB)	Detector																								
1	10399.880	39.73	13.67	53.40	74.00	-20.60	peak																								
2 *	10399.954	28.56	13.67	42.23	54.00	-11.77	AVG																								
Remarks: 1.Factor (dB/m) = Antenna Factor (dB/m)+Cable Factor (dB)-Pre-amplifier Factor 2.Margin value = Level -Limit value																															



Ant. No.	Ant 1 + Ant 2																														
Ant. Pol.	Horizontal																														
Test Mode:	TX 802.11n(HT20) Mode 5240MHz (U-NII-1)																														
Remark:	No report for the emission which more than 20 dB below the prescribed limit.																														
<table border="1"> <thead> <tr> <th>No.</th> <th>Frequency (MHz)</th> <th>Reading (dBuV)</th> <th>Factor (dB/m)</th> <th>Level (dBuV/m)</th> <th>Limit (dBuV/m)</th> <th>Margin (dB)</th> <th>Detector</th> </tr> </thead> <tbody> <tr> <td>1</td> <td>10480.602</td> <td>39.36</td> <td>13.80</td> <td>53.16</td> <td>74.00</td> <td>-20.84</td> <td>peak</td> </tr> <tr> <td>2 *</td> <td>10481.221</td> <td>28.01</td> <td>13.80</td> <td>41.81</td> <td>54.00</td> <td>-12.19</td> <td>AVG</td> </tr> </tbody> </table>								No.	Frequency (MHz)	Reading (dBuV)	Factor (dB/m)	Level (dBuV/m)	Limit (dBuV/m)	Margin (dB)	Detector	1	10480.602	39.36	13.80	53.16	74.00	-20.84	peak	2 *	10481.221	28.01	13.80	41.81	54.00	-12.19	AVG
No.	Frequency (MHz)	Reading (dBuV)	Factor (dB/m)	Level (dBuV/m)	Limit (dBuV/m)	Margin (dB)	Detector																								
1	10480.602	39.36	13.80	53.16	74.00	-20.84	peak																								
2 *	10481.221	28.01	13.80	41.81	54.00	-12.19	AVG																								
Remarks: 1.Factor (dB/m) = Antenna Factor (dB/m)+Cable Factor (dB)-Pre-amplifier Factor 2.Margin value = Level -Limit value																															

Ant. No.	Ant 1 + Ant 2																														
Ant. Pol.	Vertical																														
Test Mode:	TX 802.11n(HT20) Mode 5240MHz (U-NII-1)																														
Remark:	No report for the emission which more than 20 dB below the prescribed limit.																														
<table border="1"> <thead> <tr> <th>No.</th> <th>Frequency (MHz)</th> <th>Reading (dBuV)</th> <th>Factor (dB/m)</th> <th>Level (dBuV/m)</th> <th>Limit (dBuV/m)</th> <th>Margin (dB)</th> <th>Detector</th> </tr> </thead> <tbody> <tr> <td>1</td> <td>10479.869</td> <td>39.15</td> <td>13.80</td> <td>52.95</td> <td>74.00</td> <td>-21.05</td> <td>peak</td> </tr> <tr> <td>2 *</td> <td>10480.141</td> <td>28.05</td> <td>13.80</td> <td>41.85</td> <td>54.00</td> <td>-12.15</td> <td>AVG</td> </tr> </tbody> </table>								No.	Frequency (MHz)	Reading (dBuV)	Factor (dB/m)	Level (dBuV/m)	Limit (dBuV/m)	Margin (dB)	Detector	1	10479.869	39.15	13.80	52.95	74.00	-21.05	peak	2 *	10480.141	28.05	13.80	41.85	54.00	-12.15	AVG
No.	Frequency (MHz)	Reading (dBuV)	Factor (dB/m)	Level (dBuV/m)	Limit (dBuV/m)	Margin (dB)	Detector																								
1	10479.869	39.15	13.80	52.95	74.00	-21.05	peak																								
2 *	10480.141	28.05	13.80	41.85	54.00	-12.15	AVG																								
Remarks: 1.Factor (dB/m) = Antenna Factor (dB/m)+Cable Factor (dB)-Pre-amplifier Factor 2.Margin value = Level -Limit value																															



Ant. No.	Ant 1 + Ant 2																														
Ant. Pol.	Horizontal																														
Test Mode:	TX 802.11ac(VHT20) Mode 5180MHz (U-NII-1)																														
Remark:	No report for the emission which more than 20 dB below the prescribed limit.																														
<table border="1"> <thead> <tr> <th>No.</th> <th>Frequency (MHz)</th> <th>Reading (dBuV)</th> <th>Factor (dB/m)</th> <th>Level (dBuV/m)</th> <th>Limit (dBuV/m)</th> <th>Margin (dB)</th> <th>Detector</th> </tr> </thead> <tbody> <tr> <td>1 *</td> <td>10359.908</td> <td>28.42</td> <td>13.60</td> <td>42.02</td> <td>54.00</td> <td>-11.98</td> <td>AVG</td> </tr> <tr> <td>2</td> <td>10360.083</td> <td>39.02</td> <td>13.60</td> <td>52.62</td> <td>74.00</td> <td>-21.38</td> <td>peak</td> </tr> </tbody> </table>								No.	Frequency (MHz)	Reading (dBuV)	Factor (dB/m)	Level (dBuV/m)	Limit (dBuV/m)	Margin (dB)	Detector	1 *	10359.908	28.42	13.60	42.02	54.00	-11.98	AVG	2	10360.083	39.02	13.60	52.62	74.00	-21.38	peak
No.	Frequency (MHz)	Reading (dBuV)	Factor (dB/m)	Level (dBuV/m)	Limit (dBuV/m)	Margin (dB)	Detector																								
1 *	10359.908	28.42	13.60	42.02	54.00	-11.98	AVG																								
2	10360.083	39.02	13.60	52.62	74.00	-21.38	peak																								
Remarks: 1.Factor (dB/m) = Antenna Factor (dB/m)+Cable Factor (dB)-Pre-amplifier Factor 2.Margin value = Level -Limit value																															

Ant. No.	Ant 1 + Ant 2																														
Ant. Pol.	Vertical																														
Test Mode:	TX 802.11ac(VHT20) Mode 5180MHz (U-NII-1)																														
Remark:	No report for the emission which more than 20 dB below the prescribed limit.																														
<table border="1"> <thead> <tr> <th>No.</th> <th>Frequency (MHz)</th> <th>Reading (dBuV)</th> <th>Factor (dB/m)</th> <th>Level (dBuV/m)</th> <th>Limit (dBuV/m)</th> <th>Margin (dB)</th> <th>Detector</th> </tr> </thead> <tbody> <tr> <td>1</td> <td>10359.841</td> <td>39.39</td> <td>13.60</td> <td>52.99</td> <td>74.00</td> <td>-21.01</td> <td>peak</td> </tr> <tr> <td>2 *</td> <td>10359.864</td> <td>27.96</td> <td>13.60</td> <td>41.56</td> <td>54.00</td> <td>-12.44</td> <td>AVG</td> </tr> </tbody> </table>								No.	Frequency (MHz)	Reading (dBuV)	Factor (dB/m)	Level (dBuV/m)	Limit (dBuV/m)	Margin (dB)	Detector	1	10359.841	39.39	13.60	52.99	74.00	-21.01	peak	2 *	10359.864	27.96	13.60	41.56	54.00	-12.44	AVG
No.	Frequency (MHz)	Reading (dBuV)	Factor (dB/m)	Level (dBuV/m)	Limit (dBuV/m)	Margin (dB)	Detector																								
1	10359.841	39.39	13.60	52.99	74.00	-21.01	peak																								
2 *	10359.864	27.96	13.60	41.56	54.00	-12.44	AVG																								
Remarks: 1.Factor (dB/m) = Antenna Factor (dB/m)+Cable Factor (dB)-Pre-amplifier Factor 2.Margin value = Level -Limit value																															



Ant. No.	Ant 1 + Ant 2																														
Ant. Pol.	Horizontal																														
Test Mode:	TX 802.11ac(VHT20) Mode 5200MHz (U-NII-1)																														
Remark:	No report for the emission which more than 20 dB below the prescribed limit.																														
<table border="1"> <thead> <tr> <th>No.</th> <th>Frequency (MHz)</th> <th>Reading (dBuV)</th> <th>Factor (dB/m)</th> <th>Level (dBuV/m)</th> <th>Limit (dBuV/m)</th> <th>Margin (dB)</th> <th>Detector</th> </tr> </thead> <tbody> <tr> <td>1 *</td> <td>10399.924</td> <td>28.86</td> <td>13.67</td> <td>42.53</td> <td>54.00</td> <td>-11.47</td> <td>AVG</td> </tr> <tr> <td>2</td> <td>10400.156</td> <td>39.16</td> <td>13.67</td> <td>52.83</td> <td>74.00</td> <td>-21.17</td> <td>peak</td> </tr> </tbody> </table>								No.	Frequency (MHz)	Reading (dBuV)	Factor (dB/m)	Level (dBuV/m)	Limit (dBuV/m)	Margin (dB)	Detector	1 *	10399.924	28.86	13.67	42.53	54.00	-11.47	AVG	2	10400.156	39.16	13.67	52.83	74.00	-21.17	peak
No.	Frequency (MHz)	Reading (dBuV)	Factor (dB/m)	Level (dBuV/m)	Limit (dBuV/m)	Margin (dB)	Detector																								
1 *	10399.924	28.86	13.67	42.53	54.00	-11.47	AVG																								
2	10400.156	39.16	13.67	52.83	74.00	-21.17	peak																								
Remarks: 1.Factor (dB/m) = Antenna Factor (dB/m)+Cable Factor (dB)-Pre-amplifier Factor 2.Margin value = Level -Limit value																															

Ant. No.	Ant 1 + Ant 2																														
Ant. Pol.	Vertical																														
Test Mode:	TX 802.11ac(VHT20) Mode 5200MHz (U-NII-1)																														
Remark:	No report for the emission which more than 20 dB below the prescribed limit.																														
<table border="1"> <thead> <tr> <th>No.</th> <th>Frequency (MHz)</th> <th>Reading (dBuV)</th> <th>Factor (dB/m)</th> <th>Level (dBuV/m)</th> <th>Limit (dBuV/m)</th> <th>Margin (dB)</th> <th>Detector</th> </tr> </thead> <tbody> <tr> <td>1</td> <td>10399.917</td> <td>39.63</td> <td>13.67</td> <td>53.30</td> <td>74.00</td> <td>-20.70</td> <td>peak</td> </tr> <tr> <td>2 *</td> <td>10400.090</td> <td>27.60</td> <td>13.67</td> <td>41.27</td> <td>54.00</td> <td>-12.73</td> <td>AVG</td> </tr> </tbody> </table>								No.	Frequency (MHz)	Reading (dBuV)	Factor (dB/m)	Level (dBuV/m)	Limit (dBuV/m)	Margin (dB)	Detector	1	10399.917	39.63	13.67	53.30	74.00	-20.70	peak	2 *	10400.090	27.60	13.67	41.27	54.00	-12.73	AVG
No.	Frequency (MHz)	Reading (dBuV)	Factor (dB/m)	Level (dBuV/m)	Limit (dBuV/m)	Margin (dB)	Detector																								
1	10399.917	39.63	13.67	53.30	74.00	-20.70	peak																								
2 *	10400.090	27.60	13.67	41.27	54.00	-12.73	AVG																								
Remarks: 1.Factor (dB/m) = Antenna Factor (dB/m)+Cable Factor (dB)-Pre-amplifier Factor 2.Margin value = Level -Limit value																															



Ant. No.	Ant 1 + Ant 2																														
Ant. Pol.	Horizontal																														
Test Mode:	TX 802.11ac(VHT20) Mode 5240MHz (U-NII-1)																														
Remark:	No report for the emission which more than 20 dB below the prescribed limit.																														
<table border="1"> <thead> <tr> <th>No.</th> <th>Frequency (MHz)</th> <th>Reading (dBuV)</th> <th>Factor (dB/m)</th> <th>Level (dBuV/m)</th> <th>Limit (dBuV/m)</th> <th>Margin (dB)</th> <th>Detector</th> </tr> </thead> <tbody> <tr> <td>1 *</td> <td>10479.990</td> <td>28.45</td> <td>13.80</td> <td>42.25</td> <td>54.00</td> <td>-11.75</td> <td>AVG</td> </tr> <tr> <td>2</td> <td>10480.302</td> <td>39.28</td> <td>13.80</td> <td>53.08</td> <td>74.00</td> <td>-20.92</td> <td>peak</td> </tr> </tbody> </table>								No.	Frequency (MHz)	Reading (dBuV)	Factor (dB/m)	Level (dBuV/m)	Limit (dBuV/m)	Margin (dB)	Detector	1 *	10479.990	28.45	13.80	42.25	54.00	-11.75	AVG	2	10480.302	39.28	13.80	53.08	74.00	-20.92	peak
No.	Frequency (MHz)	Reading (dBuV)	Factor (dB/m)	Level (dBuV/m)	Limit (dBuV/m)	Margin (dB)	Detector																								
1 *	10479.990	28.45	13.80	42.25	54.00	-11.75	AVG																								
2	10480.302	39.28	13.80	53.08	74.00	-20.92	peak																								
Remarks: 1. Factor (dB/m) = Antenna Factor (dB/m)+Cable Factor (dB)-Pre-amplifier Factor 2. Margin value = Level -Limit value																															

Ant. No.	Ant 1 + Ant 2																														
Ant. Pol.	Vertical																														
Test Mode:	TX 802.11ac(VHT20) Mode 5240MHz (U-NII-1)																														
Remark:	No report for the emission which more than 20 dB below the prescribed limit.																														
<table border="1"> <thead> <tr> <th>No.</th> <th>Frequency (MHz)</th> <th>Reading (dBuV)</th> <th>Factor (dB/m)</th> <th>Level (dBuV/m)</th> <th>Limit (dBuV/m)</th> <th>Margin (dB)</th> <th>Detector</th> </tr> </thead> <tbody> <tr> <td>1</td> <td>10479.804</td> <td>39.46</td> <td>13.80</td> <td>53.26</td> <td>74.00</td> <td>-20.74</td> <td>peak</td> </tr> <tr> <td>2 *</td> <td>10480.153</td> <td>27.93</td> <td>13.80</td> <td>41.73</td> <td>54.00</td> <td>-12.27</td> <td>AVG</td> </tr> </tbody> </table>								No.	Frequency (MHz)	Reading (dBuV)	Factor (dB/m)	Level (dBuV/m)	Limit (dBuV/m)	Margin (dB)	Detector	1	10479.804	39.46	13.80	53.26	74.00	-20.74	peak	2 *	10480.153	27.93	13.80	41.73	54.00	-12.27	AVG
No.	Frequency (MHz)	Reading (dBuV)	Factor (dB/m)	Level (dBuV/m)	Limit (dBuV/m)	Margin (dB)	Detector																								
1	10479.804	39.46	13.80	53.26	74.00	-20.74	peak																								
2 *	10480.153	27.93	13.80	41.73	54.00	-12.27	AVG																								
Remarks: 1. Factor (dB/m) = Antenna Factor (dB/m)+Cable Factor (dB)-Pre-amplifier Factor 2. Margin value = Level -Limit value																															



Ant. No.	Ant 1 + Ant 2																														
Ant. Pol.	Horizontal																														
Test Mode:	TX 802.11n(HT40) Mode 5190MHz (U-NII-1)																														
Remark:	No report for the emission which more than 20 dB below the prescribed limit.																														
<table border="1"> <thead> <tr> <th>No.</th> <th>Frequency (MHz)</th> <th>Reading (dBuV)</th> <th>Factor (dB/m)</th> <th>Level (dBuV/m)</th> <th>Limit (dBuV/m)</th> <th>Margin (dB)</th> <th>Detector</th> </tr> </thead> <tbody> <tr> <td>1</td> <td>10379.890</td> <td>40.01</td> <td>13.63</td> <td>53.64</td> <td>74.00</td> <td>-20.36</td> <td>peak</td> </tr> <tr> <td>2 *</td> <td>10380.143</td> <td>28.69</td> <td>13.63</td> <td>42.32</td> <td>54.00</td> <td>-11.68</td> <td>AVG</td> </tr> </tbody> </table>								No.	Frequency (MHz)	Reading (dBuV)	Factor (dB/m)	Level (dBuV/m)	Limit (dBuV/m)	Margin (dB)	Detector	1	10379.890	40.01	13.63	53.64	74.00	-20.36	peak	2 *	10380.143	28.69	13.63	42.32	54.00	-11.68	AVG
No.	Frequency (MHz)	Reading (dBuV)	Factor (dB/m)	Level (dBuV/m)	Limit (dBuV/m)	Margin (dB)	Detector																								
1	10379.890	40.01	13.63	53.64	74.00	-20.36	peak																								
2 *	10380.143	28.69	13.63	42.32	54.00	-11.68	AVG																								
Remarks: 1.Factor (dB/m) = Antenna Factor (dB/m)+Cable Factor (dB)-Pre-amplifier Factor 2.Margin value = Level -Limit value																															

Ant. No.	Ant 1 + Ant 2																														
Ant. Pol.	Vertical																														
Test Mode:	TX 802.11n(HT40) Mode 5190MHz (U-NII-1)																														
Remark:	No report for the emission which more than 20 dB below the prescribed limit.																														
<table border="1"> <thead> <tr> <th>No.</th> <th>Frequency (MHz)</th> <th>Reading (dBuV)</th> <th>Factor (dB/m)</th> <th>Level (dBuV/m)</th> <th>Limit (dBuV/m)</th> <th>Margin (dB)</th> <th>Detector</th> </tr> </thead> <tbody> <tr> <td>1</td> <td>10379.847</td> <td>39.23</td> <td>13.63</td> <td>52.86</td> <td>74.00</td> <td>-21.14</td> <td>peak</td> </tr> <tr> <td>2 *</td> <td>10379.875</td> <td>27.36</td> <td>13.63</td> <td>40.99</td> <td>54.00</td> <td>-13.01</td> <td>AVG</td> </tr> </tbody> </table>								No.	Frequency (MHz)	Reading (dBuV)	Factor (dB/m)	Level (dBuV/m)	Limit (dBuV/m)	Margin (dB)	Detector	1	10379.847	39.23	13.63	52.86	74.00	-21.14	peak	2 *	10379.875	27.36	13.63	40.99	54.00	-13.01	AVG
No.	Frequency (MHz)	Reading (dBuV)	Factor (dB/m)	Level (dBuV/m)	Limit (dBuV/m)	Margin (dB)	Detector																								
1	10379.847	39.23	13.63	52.86	74.00	-21.14	peak																								
2 *	10379.875	27.36	13.63	40.99	54.00	-13.01	AVG																								
Remarks: 1.Factor (dB/m) = Antenna Factor (dB/m)+Cable Factor (dB)-Pre-amplifier Factor 2.Margin value = Level -Limit value																															



Ant. No.	Ant 1 + Ant 2																														
Ant. Pol.	Horizontal																														
Test Mode:	TX 802.11n(HT40) Mode 5230MHz (U-NII-1)																														
Remark:	No report for the emission which more than 20 dB below the prescribed limit.																														
<table border="1"> <thead> <tr> <th>No.</th> <th>Frequency (MHz)</th> <th>Reading (dBuV)</th> <th>Factor (dB/m)</th> <th>Level (dBuV/m)</th> <th>Limit (dBuV/m)</th> <th>Margin (dB)</th> <th>Detector</th> </tr> </thead> <tbody> <tr> <td>1</td> <td>10459.855</td> <td>39.10</td> <td>13.77</td> <td>52.87</td> <td>74.00</td> <td>-21.13</td> <td>peak</td> </tr> <tr> <td>2 *</td> <td>10460.230</td> <td>28.63</td> <td>13.77</td> <td>42.40</td> <td>54.00</td> <td>-11.60</td> <td>AVG</td> </tr> </tbody> </table>								No.	Frequency (MHz)	Reading (dBuV)	Factor (dB/m)	Level (dBuV/m)	Limit (dBuV/m)	Margin (dB)	Detector	1	10459.855	39.10	13.77	52.87	74.00	-21.13	peak	2 *	10460.230	28.63	13.77	42.40	54.00	-11.60	AVG
No.	Frequency (MHz)	Reading (dBuV)	Factor (dB/m)	Level (dBuV/m)	Limit (dBuV/m)	Margin (dB)	Detector																								
1	10459.855	39.10	13.77	52.87	74.00	-21.13	peak																								
2 *	10460.230	28.63	13.77	42.40	54.00	-11.60	AVG																								
Remarks: 1.Factor (dB/m) = Antenna Factor (dB/m)+Cable Factor (dB)-Pre-amplifier Factor 2.Margin value = Level -Limit value																															

Ant. No.	Ant 1 + Ant 2																														
Ant. Pol.	Vertical																														
Test Mode:	TX 802.11n(HT40) Mode 5230MHz (U-NII-1)																														
Remark:	No report for the emission which more than 20 dB below the prescribed limit.																														
<table border="1"> <thead> <tr> <th>No.</th> <th>Frequency (MHz)</th> <th>Reading (dBuV)</th> <th>Factor (dB/m)</th> <th>Level (dBuV/m)</th> <th>Limit (dBuV/m)</th> <th>Margin (dB)</th> <th>Detector</th> </tr> </thead> <tbody> <tr> <td>1</td> <td>10459.918</td> <td>39.85</td> <td>13.77</td> <td>53.62</td> <td>74.00</td> <td>-20.38</td> <td>peak</td> </tr> <tr> <td>2 *</td> <td>10460.138</td> <td>27.41</td> <td>13.77</td> <td>41.18</td> <td>54.00</td> <td>-12.82</td> <td>AVG</td> </tr> </tbody> </table>								No.	Frequency (MHz)	Reading (dBuV)	Factor (dB/m)	Level (dBuV/m)	Limit (dBuV/m)	Margin (dB)	Detector	1	10459.918	39.85	13.77	53.62	74.00	-20.38	peak	2 *	10460.138	27.41	13.77	41.18	54.00	-12.82	AVG
No.	Frequency (MHz)	Reading (dBuV)	Factor (dB/m)	Level (dBuV/m)	Limit (dBuV/m)	Margin (dB)	Detector																								
1	10459.918	39.85	13.77	53.62	74.00	-20.38	peak																								
2 *	10460.138	27.41	13.77	41.18	54.00	-12.82	AVG																								
Remarks: 1.Factor (dB/m) = Antenna Factor (dB/m)+Cable Factor (dB)-Pre-amplifier Factor 2.Margin value = Level -Limit value																															



Ant. No.	Ant 1 + Ant 2																														
Ant. Pol.	Horizontal																														
Test Mode:	TX 802.11ac(VHT40) Mode 5190MHz (U-NII-1)																														
Remark:	No report for the emission which more than 20 dB below the prescribed limit.																														
<table border="1"> <thead> <tr> <th>No.</th> <th>Frequency (MHz)</th> <th>Reading (dBuV)</th> <th>Factor (dB/m)</th> <th>Level (dBuV/m)</th> <th>Limit (dBuV/m)</th> <th>Margin (dB)</th> <th>Detector</th> </tr> </thead> <tbody> <tr> <td>1</td> <td>10379.827</td> <td>39.30</td> <td>13.63</td> <td>52.93</td> <td>74.00</td> <td>-21.07</td> <td>peak</td> </tr> <tr> <td>2 *</td> <td>10380.120</td> <td>28.13</td> <td>13.63</td> <td>41.76</td> <td>54.00</td> <td>-12.24</td> <td>AVG</td> </tr> </tbody> </table>								No.	Frequency (MHz)	Reading (dBuV)	Factor (dB/m)	Level (dBuV/m)	Limit (dBuV/m)	Margin (dB)	Detector	1	10379.827	39.30	13.63	52.93	74.00	-21.07	peak	2 *	10380.120	28.13	13.63	41.76	54.00	-12.24	AVG
No.	Frequency (MHz)	Reading (dBuV)	Factor (dB/m)	Level (dBuV/m)	Limit (dBuV/m)	Margin (dB)	Detector																								
1	10379.827	39.30	13.63	52.93	74.00	-21.07	peak																								
2 *	10380.120	28.13	13.63	41.76	54.00	-12.24	AVG																								
Remarks: 1.Factor (dB/m) = Antenna Factor (dB/m)+Cable Factor (dB)-Pre-amplifier Factor 2.Margin value = Level -Limit value																															

Ant. No.	Ant 1 + Ant 2																														
Ant. Pol.	Vertical																														
Test Mode:	TX 802.11ac(VHT40) Mode 5190MHz (U-NII-1)																														
Remark:	No report for the emission which more than 20 dB below the prescribed limit.																														
<table border="1"> <thead> <tr> <th>No.</th> <th>Frequency (MHz)</th> <th>Reading (dBuV)</th> <th>Factor (dB/m)</th> <th>Level (dBuV/m)</th> <th>Limit (dBuV/m)</th> <th>Margin (dB)</th> <th>Detector</th> </tr> </thead> <tbody> <tr> <td>1 *</td> <td>10380.126</td> <td>27.72</td> <td>13.63</td> <td>41.35</td> <td>54.00</td> <td>-12.65</td> <td>AVG</td> </tr> <tr> <td>2</td> <td>10380.127</td> <td>38.87</td> <td>13.63</td> <td>52.50</td> <td>74.00</td> <td>-21.50</td> <td>peak</td> </tr> </tbody> </table>								No.	Frequency (MHz)	Reading (dBuV)	Factor (dB/m)	Level (dBuV/m)	Limit (dBuV/m)	Margin (dB)	Detector	1 *	10380.126	27.72	13.63	41.35	54.00	-12.65	AVG	2	10380.127	38.87	13.63	52.50	74.00	-21.50	peak
No.	Frequency (MHz)	Reading (dBuV)	Factor (dB/m)	Level (dBuV/m)	Limit (dBuV/m)	Margin (dB)	Detector																								
1 *	10380.126	27.72	13.63	41.35	54.00	-12.65	AVG																								
2	10380.127	38.87	13.63	52.50	74.00	-21.50	peak																								
Remarks: 1.Factor (dB/m) = Antenna Factor (dB/m)+Cable Factor (dB)-Pre-amplifier Factor 2.Margin value = Level -Limit value																															



Ant. No.	Ant 1 + Ant 2																														
Ant. Pol.	Horizontal																														
Test Mode:	TX 802.11ac(VHT40) Mode 5230MHz (U-NII-1)																														
Remark:	No report for the emission which more than 20 dB below the prescribed limit.																														
<table border="1"> <thead> <tr> <th>No.</th> <th>Frequency (MHz)</th> <th>Reading (dBuV)</th> <th>Factor (dB/m)</th> <th>Level (dBuV/m)</th> <th>Limit (dBuV/m)</th> <th>Margin (dB)</th> <th>Detector</th> </tr> </thead> <tbody> <tr> <td>1 *</td> <td>10460.127</td> <td>28.19</td> <td>13.77</td> <td>41.96</td> <td>54.00</td> <td>-12.04</td> <td>AVG</td> </tr> <tr> <td>2</td> <td>10460.515</td> <td>39.28</td> <td>13.77</td> <td>53.05</td> <td>74.00</td> <td>-20.95</td> <td>peak</td> </tr> </tbody> </table>								No.	Frequency (MHz)	Reading (dBuV)	Factor (dB/m)	Level (dBuV/m)	Limit (dBuV/m)	Margin (dB)	Detector	1 *	10460.127	28.19	13.77	41.96	54.00	-12.04	AVG	2	10460.515	39.28	13.77	53.05	74.00	-20.95	peak
No.	Frequency (MHz)	Reading (dBuV)	Factor (dB/m)	Level (dBuV/m)	Limit (dBuV/m)	Margin (dB)	Detector																								
1 *	10460.127	28.19	13.77	41.96	54.00	-12.04	AVG																								
2	10460.515	39.28	13.77	53.05	74.00	-20.95	peak																								
Remarks: 1. Factor (dB/m) = Antenna Factor (dB/m)+Cable Factor (dB)-Pre-amplifier Factor 2. Margin value = Level -Limit value																															

Ant. No.	Ant 1 + Ant 2																														
Ant. Pol.	Vertical																														
Test Mode:	TX 802.11ac(VHT40) Mode 5230MHz (U-NII-1)																														
Remark:	No report for the emission which more than 20 dB below the prescribed limit.																														
<table border="1"> <thead> <tr> <th>No.</th> <th>Frequency (MHz)</th> <th>Reading (dBuV)</th> <th>Factor (dB/m)</th> <th>Level (dBuV/m)</th> <th>Limit (dBuV/m)</th> <th>Margin (dB)</th> <th>Detector</th> </tr> </thead> <tbody> <tr> <td>1</td> <td>10459.880</td> <td>38.75</td> <td>13.77</td> <td>52.52</td> <td>74.00</td> <td>-21.48</td> <td>peak</td> </tr> <tr> <td>2 *</td> <td>10460.055</td> <td>27.42</td> <td>13.77</td> <td>41.19</td> <td>54.00</td> <td>-12.81</td> <td>AVG</td> </tr> </tbody> </table>								No.	Frequency (MHz)	Reading (dBuV)	Factor (dB/m)	Level (dBuV/m)	Limit (dBuV/m)	Margin (dB)	Detector	1	10459.880	38.75	13.77	52.52	74.00	-21.48	peak	2 *	10460.055	27.42	13.77	41.19	54.00	-12.81	AVG
No.	Frequency (MHz)	Reading (dBuV)	Factor (dB/m)	Level (dBuV/m)	Limit (dBuV/m)	Margin (dB)	Detector																								
1	10459.880	38.75	13.77	52.52	74.00	-21.48	peak																								
2 *	10460.055	27.42	13.77	41.19	54.00	-12.81	AVG																								
Remarks: 1. Factor (dB/m) = Antenna Factor (dB/m)+Cable Factor (dB)-Pre-amplifier Factor 2. Margin value = Level -Limit value																															



Ant. No.	Ant 1 + Ant 2																														
Ant. Pol.	Horizontal																														
Test Mode:	TX 802.11ac(VHT80) Mode 5210MHz (U-NII-1)																														
Remark:	No report for the emission which more than 20 dB below the prescribed limit.																														
<table border="1"> <thead> <tr> <th>No.</th> <th>Frequency (MHz)</th> <th>Reading (dBuV)</th> <th>Factor (dB/m)</th> <th>Level (dBuV/m)</th> <th>Limit (dBuV/m)</th> <th>Margin (dB)</th> <th>Detector</th> </tr> </thead> <tbody> <tr> <td>1</td> <td>10419.872</td> <td>39.21</td> <td>13.70</td> <td>52.91</td> <td>74.00</td> <td>-21.09</td> <td>peak</td> </tr> <tr> <td>2 *</td> <td>10420.230</td> <td>27.85</td> <td>13.70</td> <td>41.55</td> <td>54.00</td> <td>-12.45</td> <td>AVG</td> </tr> </tbody> </table>								No.	Frequency (MHz)	Reading (dBuV)	Factor (dB/m)	Level (dBuV/m)	Limit (dBuV/m)	Margin (dB)	Detector	1	10419.872	39.21	13.70	52.91	74.00	-21.09	peak	2 *	10420.230	27.85	13.70	41.55	54.00	-12.45	AVG
No.	Frequency (MHz)	Reading (dBuV)	Factor (dB/m)	Level (dBuV/m)	Limit (dBuV/m)	Margin (dB)	Detector																								
1	10419.872	39.21	13.70	52.91	74.00	-21.09	peak																								
2 *	10420.230	27.85	13.70	41.55	54.00	-12.45	AVG																								
Remarks: 1.Factor (dB/m) = Antenna Factor (dB/m)+Cable Factor (dB)-Pre-amplifier Factor 2.Margin value = Level -Limit value																															

Ant. No.	Ant 1 + Ant 2																														
Ant. Pol.	Vertical																														
Test Mode:	TX 802.11ac(VHT80) Mode 5210MHz (U-NII-1)																														
Remark:	No report for the emission which more than 20 dB below the prescribed limit.																														
<table border="1"> <thead> <tr> <th>No.</th> <th>Frequency (MHz)</th> <th>Reading (dBuV)</th> <th>Factor (dB/m)</th> <th>Level (dBuV/m)</th> <th>Limit (dBuV/m)</th> <th>Margin (dB)</th> <th>Detector</th> </tr> </thead> <tbody> <tr> <td>1 *</td> <td>10419.721</td> <td>28.40</td> <td>13.70</td> <td>42.10</td> <td>54.00</td> <td>-11.90</td> <td>AVG</td> </tr> <tr> <td>2</td> <td>10419.753</td> <td>39.49</td> <td>13.70</td> <td>53.19</td> <td>74.00</td> <td>-20.81</td> <td>peak</td> </tr> </tbody> </table>								No.	Frequency (MHz)	Reading (dBuV)	Factor (dB/m)	Level (dBuV/m)	Limit (dBuV/m)	Margin (dB)	Detector	1 *	10419.721	28.40	13.70	42.10	54.00	-11.90	AVG	2	10419.753	39.49	13.70	53.19	74.00	-20.81	peak
No.	Frequency (MHz)	Reading (dBuV)	Factor (dB/m)	Level (dBuV/m)	Limit (dBuV/m)	Margin (dB)	Detector																								
1 *	10419.721	28.40	13.70	42.10	54.00	-11.90	AVG																								
2	10419.753	39.49	13.70	53.19	74.00	-20.81	peak																								
Remarks: 1.Factor (dB/m) = Antenna Factor (dB/m)+Cable Factor (dB)-Pre-amplifier Factor 2.Margin value = Level -Limit value																															



Ant. No.	Ant 2																														
Ant. Pol.	Horizontal																														
Test Mode:	TX 802.11a Mode 5260MHz (U-NII-2A)																														
Remark:	No report for the emission which more than 20 dB below the prescribed limit.																														
<table border="1"> <thead> <tr> <th>No.</th> <th>Frequency (MHz)</th> <th>Reading (dBuV)</th> <th>Factor (dB/m)</th> <th>Level (dBuV/m)</th> <th>Limit (dBuV/m)</th> <th>Margin (dB)</th> <th>Detector</th> </tr> </thead> <tbody> <tr> <td>1</td> <td>10519.793</td> <td>40.47</td> <td>13.89</td> <td>54.36</td> <td>74.00</td> <td>-19.64</td> <td>peak</td> </tr> <tr> <td>2 *</td> <td>10519.863</td> <td>27.96</td> <td>13.89</td> <td>41.85</td> <td>54.00</td> <td>-12.15</td> <td>AVG</td> </tr> </tbody> </table>								No.	Frequency (MHz)	Reading (dBuV)	Factor (dB/m)	Level (dBuV/m)	Limit (dBuV/m)	Margin (dB)	Detector	1	10519.793	40.47	13.89	54.36	74.00	-19.64	peak	2 *	10519.863	27.96	13.89	41.85	54.00	-12.15	AVG
No.	Frequency (MHz)	Reading (dBuV)	Factor (dB/m)	Level (dBuV/m)	Limit (dBuV/m)	Margin (dB)	Detector																								
1	10519.793	40.47	13.89	54.36	74.00	-19.64	peak																								
2 *	10519.863	27.96	13.89	41.85	54.00	-12.15	AVG																								
Remarks: 1.Factor (dB/m) = Antenna Factor (dB/m)+Cable Factor (dB)-Pre-amplifier Factor 2.Margin value = Level -Limit value																															

Ant. No.	Ant 2																														
Ant. Pol.	Vertical																														
Test Mode:	TX 802.11a Mode 5260MHz (U-NII-2A)																														
Remark:	No report for the emission which more than 20 dB below the prescribed limit.																														
<table border="1"> <thead> <tr> <th>No.</th> <th>Frequency (MHz)</th> <th>Reading (dBuV)</th> <th>Factor (dB/m)</th> <th>Level (dBuV/m)</th> <th>Limit (dBuV/m)</th> <th>Margin (dB)</th> <th>Detector</th> </tr> </thead> <tbody> <tr> <td>1</td> <td>10519.815</td> <td>39.97</td> <td>13.89</td> <td>53.86</td> <td>74.00</td> <td>-20.14</td> <td>peak</td> </tr> <tr> <td>2 *</td> <td>10520.069</td> <td>27.82</td> <td>13.89</td> <td>41.71</td> <td>54.00</td> <td>-12.29</td> <td>AVG</td> </tr> </tbody> </table>								No.	Frequency (MHz)	Reading (dBuV)	Factor (dB/m)	Level (dBuV/m)	Limit (dBuV/m)	Margin (dB)	Detector	1	10519.815	39.97	13.89	53.86	74.00	-20.14	peak	2 *	10520.069	27.82	13.89	41.71	54.00	-12.29	AVG
No.	Frequency (MHz)	Reading (dBuV)	Factor (dB/m)	Level (dBuV/m)	Limit (dBuV/m)	Margin (dB)	Detector																								
1	10519.815	39.97	13.89	53.86	74.00	-20.14	peak																								
2 *	10520.069	27.82	13.89	41.71	54.00	-12.29	AVG																								
Remarks: 1.Factor (dB/m) = Antenna Factor (dB/m)+Cable Factor (dB)-Pre-amplifier Factor 2.Margin value = Level -Limit value																															



Ant. No.	Ant 2																														
Ant. Pol.	Horizontal																														
Test Mode:	TX 802.11a Mode 5280MHz (U-NII-2A)																														
Remark:	No report for the emission which more than 20 dB below the prescribed limit.																														
<table border="1"> <thead> <tr> <th>No.</th> <th>Frequency (MHz)</th> <th>Reading (dBuV)</th> <th>Factor (dB/m)</th> <th>Level (dBuV/m)</th> <th>Limit (dBuV/m)</th> <th>Margin (dB)</th> <th>Detector</th> </tr> </thead> <tbody> <tr> <td>1</td> <td>10559.839</td> <td>40.17</td> <td>13.97</td> <td>54.14</td> <td>74.00</td> <td>-19.86</td> <td>peak</td> </tr> <tr> <td>2 *</td> <td>10560.131</td> <td>28.34</td> <td>13.97</td> <td>42.31</td> <td>54.00</td> <td>-11.69</td> <td>AVG</td> </tr> </tbody> </table>								No.	Frequency (MHz)	Reading (dBuV)	Factor (dB/m)	Level (dBuV/m)	Limit (dBuV/m)	Margin (dB)	Detector	1	10559.839	40.17	13.97	54.14	74.00	-19.86	peak	2 *	10560.131	28.34	13.97	42.31	54.00	-11.69	AVG
No.	Frequency (MHz)	Reading (dBuV)	Factor (dB/m)	Level (dBuV/m)	Limit (dBuV/m)	Margin (dB)	Detector																								
1	10559.839	40.17	13.97	54.14	74.00	-19.86	peak																								
2 *	10560.131	28.34	13.97	42.31	54.00	-11.69	AVG																								
Remarks: 1.Factor (dB/m) = Antenna Factor (dB/m)+Cable Factor (dB)-Pre-amplifier Factor 2.Margin value = Level -Limit value																															

Ant. No.	Ant 2																														
Ant. Pol.	Vertical																														
Test Mode:	TX 802.11a Mode 5280MHz (U-NII-2A)																														
Remark:	No report for the emission which more than 20 dB below the prescribed limit.																														
<table border="1"> <thead> <tr> <th>No.</th> <th>Frequency (MHz)</th> <th>Reading (dBuV)</th> <th>Factor (dB/m)</th> <th>Level (dBuV/m)</th> <th>Limit (dBuV/m)</th> <th>Margin (dB)</th> <th>Detector</th> </tr> </thead> <tbody> <tr> <td>1 *</td> <td>10559.766</td> <td>28.04</td> <td>13.97</td> <td>42.01</td> <td>54.00</td> <td>-11.99</td> <td>AVG</td> </tr> <tr> <td>2</td> <td>10560.044</td> <td>39.87</td> <td>13.97</td> <td>53.84</td> <td>74.00</td> <td>-20.16</td> <td>peak</td> </tr> </tbody> </table>								No.	Frequency (MHz)	Reading (dBuV)	Factor (dB/m)	Level (dBuV/m)	Limit (dBuV/m)	Margin (dB)	Detector	1 *	10559.766	28.04	13.97	42.01	54.00	-11.99	AVG	2	10560.044	39.87	13.97	53.84	74.00	-20.16	peak
No.	Frequency (MHz)	Reading (dBuV)	Factor (dB/m)	Level (dBuV/m)	Limit (dBuV/m)	Margin (dB)	Detector																								
1 *	10559.766	28.04	13.97	42.01	54.00	-11.99	AVG																								
2	10560.044	39.87	13.97	53.84	74.00	-20.16	peak																								
Remarks: 1.Factor (dB/m) = Antenna Factor (dB/m)+Cable Factor (dB)-Pre-amplifier Factor 2.Margin value = Level -Limit value																															



Ant. No.	Ant 2																														
Ant. Pol.	Horizontal																														
Test Mode:	TX 802.11a Mode 5320MHz (U-NII-2A)																														
Remark:	No report for the emission which more than 20 dB below the prescribed limit.																														
<table border="1"> <thead> <tr> <th>No.</th> <th>Frequency (MHz)</th> <th>Reading (dBuV)</th> <th>Factor (dB/m)</th> <th>Level (dBuV/m)</th> <th>Limit (dBuV/m)</th> <th>Margin (dB)</th> <th>Detector</th> </tr> </thead> <tbody> <tr> <td>1</td> <td>10639.920</td> <td>39.48</td> <td>14.16</td> <td>53.64</td> <td>74.00</td> <td>-20.36</td> <td>peak</td> </tr> <tr> <td>2 *</td> <td>10640.021</td> <td>27.84</td> <td>14.16</td> <td>42.00</td> <td>54.00</td> <td>-12.00</td> <td>AVG</td> </tr> </tbody> </table>								No.	Frequency (MHz)	Reading (dBuV)	Factor (dB/m)	Level (dBuV/m)	Limit (dBuV/m)	Margin (dB)	Detector	1	10639.920	39.48	14.16	53.64	74.00	-20.36	peak	2 *	10640.021	27.84	14.16	42.00	54.00	-12.00	AVG
No.	Frequency (MHz)	Reading (dBuV)	Factor (dB/m)	Level (dBuV/m)	Limit (dBuV/m)	Margin (dB)	Detector																								
1	10639.920	39.48	14.16	53.64	74.00	-20.36	peak																								
2 *	10640.021	27.84	14.16	42.00	54.00	-12.00	AVG																								
Remarks: 1.Factor (dB/m) = Antenna Factor (dB/m)+Cable Factor (dB)-Pre-amplifier Factor 2.Margin value = Level -Limit value																															

Ant. No.	Ant 2																														
Ant. Pol.	Vertical																														
Test Mode:	TX 802.11a Mode 5320MHz (U-NII-2A)																														
Remark:	No report for the emission which more than 20 dB below the prescribed limit.																														
<table border="1"> <thead> <tr> <th>No.</th> <th>Frequency (MHz)</th> <th>Reading (dBuV)</th> <th>Factor (dB/m)</th> <th>Level (dBuV/m)</th> <th>Limit (dBuV/m)</th> <th>Margin (dB)</th> <th>Detector</th> </tr> </thead> <tbody> <tr> <td>1 *</td> <td>10639.827</td> <td>27.70</td> <td>14.16</td> <td>41.86</td> <td>54.00</td> <td>-12.14</td> <td>AVG</td> </tr> <tr> <td>2</td> <td>10639.838</td> <td>40.06</td> <td>14.16</td> <td>54.22</td> <td>74.00</td> <td>-19.78</td> <td>peak</td> </tr> </tbody> </table>								No.	Frequency (MHz)	Reading (dBuV)	Factor (dB/m)	Level (dBuV/m)	Limit (dBuV/m)	Margin (dB)	Detector	1 *	10639.827	27.70	14.16	41.86	54.00	-12.14	AVG	2	10639.838	40.06	14.16	54.22	74.00	-19.78	peak
No.	Frequency (MHz)	Reading (dBuV)	Factor (dB/m)	Level (dBuV/m)	Limit (dBuV/m)	Margin (dB)	Detector																								
1 *	10639.827	27.70	14.16	41.86	54.00	-12.14	AVG																								
2	10639.838	40.06	14.16	54.22	74.00	-19.78	peak																								
Remarks: 1.Factor (dB/m) = Antenna Factor (dB/m)+Cable Factor (dB)-Pre-amplifier Factor 2.Margin value = Level -Limit value																															



Ant. No.	Ant 1 + Ant 2																														
Ant. Pol.	Horizontal																														
Test Mode:	TX 802.11n(HT20) Mode 5260MHz (U-NII-2A)																														
Remark:	No report for the emission which more than 20 dB below the prescribed limit.																														
<table border="1"> <thead> <tr> <th>No.</th> <th>Frequency (MHz)</th> <th>Reading (dBUV)</th> <th>Factor (dB/m)</th> <th>Level (dBUV/m)</th> <th>Limit (dBUV/m)</th> <th>Margin (dB)</th> <th>Detector</th> </tr> </thead> <tbody> <tr> <td>1 *</td> <td>10519.749</td> <td>28.21</td> <td>13.89</td> <td>42.10</td> <td>54.00</td> <td>-11.90</td> <td>AVG</td> </tr> <tr> <td>2</td> <td>10520.105</td> <td>38.79</td> <td>13.89</td> <td>52.68</td> <td>74.00</td> <td>-21.32</td> <td>peak</td> </tr> </tbody> </table>								No.	Frequency (MHz)	Reading (dBUV)	Factor (dB/m)	Level (dBUV/m)	Limit (dBUV/m)	Margin (dB)	Detector	1 *	10519.749	28.21	13.89	42.10	54.00	-11.90	AVG	2	10520.105	38.79	13.89	52.68	74.00	-21.32	peak
No.	Frequency (MHz)	Reading (dBUV)	Factor (dB/m)	Level (dBUV/m)	Limit (dBUV/m)	Margin (dB)	Detector																								
1 *	10519.749	28.21	13.89	42.10	54.00	-11.90	AVG																								
2	10520.105	38.79	13.89	52.68	74.00	-21.32	peak																								
Remarks: 1.Factor (dB/m) = Antenna Factor (dB/m)+Cable Factor (dB)-Pre-amplifier Factor 2.Margin value = Level -Limit value																															

Ant. No.	Ant 1 + Ant 2																														
Ant. Pol.	Vertical																														
Test Mode:	TX 802.11n(HT20) Mode 5260MHz (U-NII-2A)																														
Remark:	No report for the emission which more than 20 dB below the prescribed limit.																														
<table border="1"> <thead> <tr> <th>No.</th> <th>Frequency (MHz)</th> <th>Reading (dBUV)</th> <th>Factor (dB/m)</th> <th>Level (dBUV/m)</th> <th>Limit (dBUV/m)</th> <th>Margin (dB)</th> <th>Detector</th> </tr> </thead> <tbody> <tr> <td>1</td> <td>10519.959</td> <td>40.04</td> <td>13.89</td> <td>53.93</td> <td>74.00</td> <td>-20.07</td> <td>peak</td> </tr> <tr> <td>2 *</td> <td>10520.079</td> <td>27.56</td> <td>13.89</td> <td>41.45</td> <td>54.00</td> <td>-12.55</td> <td>AVG</td> </tr> </tbody> </table>								No.	Frequency (MHz)	Reading (dBUV)	Factor (dB/m)	Level (dBUV/m)	Limit (dBUV/m)	Margin (dB)	Detector	1	10519.959	40.04	13.89	53.93	74.00	-20.07	peak	2 *	10520.079	27.56	13.89	41.45	54.00	-12.55	AVG
No.	Frequency (MHz)	Reading (dBUV)	Factor (dB/m)	Level (dBUV/m)	Limit (dBUV/m)	Margin (dB)	Detector																								
1	10519.959	40.04	13.89	53.93	74.00	-20.07	peak																								
2 *	10520.079	27.56	13.89	41.45	54.00	-12.55	AVG																								
Remarks: 1.Factor (dB/m) = Antenna Factor (dB/m)+Cable Factor (dB)-Pre-amplifier Factor 2.Margin value = Level -Limit value																															



Ant. No.	Ant 1 + Ant 2																														
Ant. Pol.	Horizontal																														
Test Mode:	TX 802.11n(HT20) Mode 5280MHz (U-NII-2A)																														
Remark:	No report for the emission which more than 20 dB below the prescribed limit.																														
<table border="1"> <thead> <tr> <th>No.</th> <th>Frequency (MHz)</th> <th>Reading (dBuV)</th> <th>Factor (dB/m)</th> <th>Level (dBuV/m)</th> <th>Limit (dBuV/m)</th> <th>Margin (dB)</th> <th>Detector</th> </tr> </thead> <tbody> <tr> <td>1 *</td> <td>10559.955</td> <td>27.56</td> <td>13.97</td> <td>41.53</td> <td>54.00</td> <td>-12.47</td> <td>AVG</td> </tr> <tr> <td>2</td> <td>10560.131</td> <td>39.09</td> <td>13.97</td> <td>53.06</td> <td>74.00</td> <td>-20.94</td> <td>peak</td> </tr> </tbody> </table>								No.	Frequency (MHz)	Reading (dBuV)	Factor (dB/m)	Level (dBuV/m)	Limit (dBuV/m)	Margin (dB)	Detector	1 *	10559.955	27.56	13.97	41.53	54.00	-12.47	AVG	2	10560.131	39.09	13.97	53.06	74.00	-20.94	peak
No.	Frequency (MHz)	Reading (dBuV)	Factor (dB/m)	Level (dBuV/m)	Limit (dBuV/m)	Margin (dB)	Detector																								
1 *	10559.955	27.56	13.97	41.53	54.00	-12.47	AVG																								
2	10560.131	39.09	13.97	53.06	74.00	-20.94	peak																								
Remarks: 1.Factor (dB/m) = Antenna Factor (dB/m)+Cable Factor (dB)-Pre-amplifier Factor 2.Margin value = Level -Limit value																															

Ant. No.	Ant 1 + Ant 2																														
Ant. Pol.	Vertical																														
Test Mode:	TX 802.11n(HT20) Mode 5280MHz (U-NII-2A)																														
Remark:	No report for the emission which more than 20 dB below the prescribed limit.																														
<table border="1"> <thead> <tr> <th>No.</th> <th>Frequency (MHz)</th> <th>Reading (dBuV)</th> <th>Factor (dB/m)</th> <th>Level (dBuV/m)</th> <th>Limit (dBuV/m)</th> <th>Margin (dB)</th> <th>Detector</th> </tr> </thead> <tbody> <tr> <td>1 *</td> <td>10559.852</td> <td>27.65</td> <td>13.97</td> <td>41.62</td> <td>54.00</td> <td>-12.38</td> <td>AVG</td> </tr> <tr> <td>2</td> <td>10560.173</td> <td>40.02</td> <td>13.97</td> <td>53.99</td> <td>74.00</td> <td>-20.01</td> <td>peak</td> </tr> </tbody> </table>								No.	Frequency (MHz)	Reading (dBuV)	Factor (dB/m)	Level (dBuV/m)	Limit (dBuV/m)	Margin (dB)	Detector	1 *	10559.852	27.65	13.97	41.62	54.00	-12.38	AVG	2	10560.173	40.02	13.97	53.99	74.00	-20.01	peak
No.	Frequency (MHz)	Reading (dBuV)	Factor (dB/m)	Level (dBuV/m)	Limit (dBuV/m)	Margin (dB)	Detector																								
1 *	10559.852	27.65	13.97	41.62	54.00	-12.38	AVG																								
2	10560.173	40.02	13.97	53.99	74.00	-20.01	peak																								
Remarks: 1.Factor (dB/m) = Antenna Factor (dB/m)+Cable Factor (dB)-Pre-amplifier Factor 2.Margin value = Level -Limit value																															



Ant. No.	Ant 1 + Ant 2																														
Ant. Pol.	Horizontal																														
Test Mode:	TX 802.11n(HT20) Mode 5320MHz (U-NII-2A)																														
Remark:	No report for the emission which more than 20 dB below the prescribed limit.																														
<table border="1"> <thead> <tr> <th>No.</th> <th>Frequency (MHz)</th> <th>Reading (dBuV)</th> <th>Factor (dB/m)</th> <th>Level (dBuV/m)</th> <th>Limit (dBuV/m)</th> <th>Margin (dB)</th> <th>Detector</th> </tr> </thead> <tbody> <tr> <td>1</td> <td>10639.768</td> <td>38.99</td> <td>14.16</td> <td>53.15</td> <td>74.00</td> <td>-20.85</td> <td>peak</td> </tr> <tr> <td>2 *</td> <td>10640.421</td> <td>27.77</td> <td>14.16</td> <td>41.93</td> <td>54.00</td> <td>-12.07</td> <td>AVG</td> </tr> </tbody> </table>								No.	Frequency (MHz)	Reading (dBuV)	Factor (dB/m)	Level (dBuV/m)	Limit (dBuV/m)	Margin (dB)	Detector	1	10639.768	38.99	14.16	53.15	74.00	-20.85	peak	2 *	10640.421	27.77	14.16	41.93	54.00	-12.07	AVG
No.	Frequency (MHz)	Reading (dBuV)	Factor (dB/m)	Level (dBuV/m)	Limit (dBuV/m)	Margin (dB)	Detector																								
1	10639.768	38.99	14.16	53.15	74.00	-20.85	peak																								
2 *	10640.421	27.77	14.16	41.93	54.00	-12.07	AVG																								
Remarks: 1.Factor (dB/m) = Antenna Factor (dB/m)+Cable Factor (dB)-Pre-amplifier Factor 2.Margin value = Level -Limit value																															

Ant. No.	Ant 1 + Ant 2																														
Ant. Pol.	Vertical																														
Test Mode:	TX 802.11n(HT20) Mode 5320MHz (U-NII-2A)																														
Remark:	No report for the emission which more than 20 dB below the prescribed limit.																														
<table border="1"> <thead> <tr> <th>No.</th> <th>Frequency (MHz)</th> <th>Reading (dBuV)</th> <th>Factor (dB/m)</th> <th>Level (dBuV/m)</th> <th>Limit (dBuV/m)</th> <th>Margin (dB)</th> <th>Detector</th> </tr> </thead> <tbody> <tr> <td>1 *</td> <td>10640.606</td> <td>27.08</td> <td>14.16</td> <td>41.24</td> <td>54.00</td> <td>-12.76</td> <td>AVG</td> </tr> <tr> <td>2</td> <td>10641.034</td> <td>39.44</td> <td>14.16</td> <td>53.60</td> <td>74.00</td> <td>-20.40</td> <td>peak</td> </tr> </tbody> </table>								No.	Frequency (MHz)	Reading (dBuV)	Factor (dB/m)	Level (dBuV/m)	Limit (dBuV/m)	Margin (dB)	Detector	1 *	10640.606	27.08	14.16	41.24	54.00	-12.76	AVG	2	10641.034	39.44	14.16	53.60	74.00	-20.40	peak
No.	Frequency (MHz)	Reading (dBuV)	Factor (dB/m)	Level (dBuV/m)	Limit (dBuV/m)	Margin (dB)	Detector																								
1 *	10640.606	27.08	14.16	41.24	54.00	-12.76	AVG																								
2	10641.034	39.44	14.16	53.60	74.00	-20.40	peak																								
Remarks: 1.Factor (dB/m) = Antenna Factor (dB/m)+Cable Factor (dB)-Pre-amplifier Factor 2.Margin value = Level -Limit value																															



Ant. No.	Ant 1 + Ant 2																														
Ant. Pol.	Horizontal																														
Test Mode:	TX 802.11ac(VHT20) Mode 5260MHz (U-NII-2A)																														
Remark:	No report for the emission which more than 20 dB below the prescribed limit.																														
<table border="1"> <thead> <tr> <th>No.</th> <th>Frequency (MHz)</th> <th>Reading (dBuV)</th> <th>Factor (dB/m)</th> <th>Level (dBuV/m)</th> <th>Limit (dBuV/m)</th> <th>Margin (dB)</th> <th>Detector</th> </tr> </thead> <tbody> <tr> <td>1</td> <td>10519.861</td> <td>39.07</td> <td>13.89</td> <td>52.96</td> <td>74.00</td> <td>-21.04</td> <td>peak</td> </tr> <tr> <td>2 *</td> <td>10520.371</td> <td>28.31</td> <td>13.89</td> <td>42.20</td> <td>54.00</td> <td>-11.80</td> <td>AVG</td> </tr> </tbody> </table>								No.	Frequency (MHz)	Reading (dBuV)	Factor (dB/m)	Level (dBuV/m)	Limit (dBuV/m)	Margin (dB)	Detector	1	10519.861	39.07	13.89	52.96	74.00	-21.04	peak	2 *	10520.371	28.31	13.89	42.20	54.00	-11.80	AVG
No.	Frequency (MHz)	Reading (dBuV)	Factor (dB/m)	Level (dBuV/m)	Limit (dBuV/m)	Margin (dB)	Detector																								
1	10519.861	39.07	13.89	52.96	74.00	-21.04	peak																								
2 *	10520.371	28.31	13.89	42.20	54.00	-11.80	AVG																								
Remarks: 1.Factor (dB/m) = Antenna Factor (dB/m)+Cable Factor (dB)-Pre-amplifier Factor 2.Margin value = Level -Limit value																															

Ant. No.	Ant 1 + Ant 2																														
Ant. Pol.	Vertical																														
Test Mode:	TX 802.11ac(VHT20) Mode 5260MHz (U-NII-2A)																														
Remark:	No report for the emission which more than 20 dB below the prescribed limit.																														
<table border="1"> <thead> <tr> <th>No.</th> <th>Frequency (MHz)</th> <th>Reading (dBuV)</th> <th>Factor (dB/m)</th> <th>Level (dBuV/m)</th> <th>Limit (dBuV/m)</th> <th>Margin (dB)</th> <th>Detector</th> </tr> </thead> <tbody> <tr> <td>1 *</td> <td>10519.859</td> <td>27.52</td> <td>13.89</td> <td>41.41</td> <td>54.00</td> <td>-12.59</td> <td>AVG</td> </tr> <tr> <td>2</td> <td>10520.583</td> <td>38.87</td> <td>13.89</td> <td>52.76</td> <td>74.00</td> <td>-21.24</td> <td>peak</td> </tr> </tbody> </table>								No.	Frequency (MHz)	Reading (dBuV)	Factor (dB/m)	Level (dBuV/m)	Limit (dBuV/m)	Margin (dB)	Detector	1 *	10519.859	27.52	13.89	41.41	54.00	-12.59	AVG	2	10520.583	38.87	13.89	52.76	74.00	-21.24	peak
No.	Frequency (MHz)	Reading (dBuV)	Factor (dB/m)	Level (dBuV/m)	Limit (dBuV/m)	Margin (dB)	Detector																								
1 *	10519.859	27.52	13.89	41.41	54.00	-12.59	AVG																								
2	10520.583	38.87	13.89	52.76	74.00	-21.24	peak																								
Remarks: 1.Factor (dB/m) = Antenna Factor (dB/m)+Cable Factor (dB)-Pre-amplifier Factor 2.Margin value = Level -Limit value																															



Ant. No.	Ant 1 + Ant 2																														
Ant. Pol.	Horizontal																														
Test Mode:	TX 802.11ac(VHT20) Mode 5280MHz (U-NII-2A)																														
Remark:	No report for the emission which more than 20 dB below the prescribed limit.																														
<table border="1"> <thead> <tr> <th>No.</th> <th>Frequency (MHz)</th> <th>Reading (dBuV)</th> <th>Factor (dB/m)</th> <th>Level (dBuV/m)</th> <th>Limit (dBuV/m)</th> <th>Margin (dB)</th> <th>Detector</th> </tr> </thead> <tbody> <tr> <td>1 *</td> <td>10560.235</td> <td>28.40</td> <td>13.97</td> <td>42.37</td> <td>54.00</td> <td>-11.63</td> <td>AVG</td> </tr> <tr> <td>2</td> <td>10560.274</td> <td>39.09</td> <td>13.97</td> <td>53.06</td> <td>74.00</td> <td>-20.94</td> <td>peak</td> </tr> </tbody> </table>								No.	Frequency (MHz)	Reading (dBuV)	Factor (dB/m)	Level (dBuV/m)	Limit (dBuV/m)	Margin (dB)	Detector	1 *	10560.235	28.40	13.97	42.37	54.00	-11.63	AVG	2	10560.274	39.09	13.97	53.06	74.00	-20.94	peak
No.	Frequency (MHz)	Reading (dBuV)	Factor (dB/m)	Level (dBuV/m)	Limit (dBuV/m)	Margin (dB)	Detector																								
1 *	10560.235	28.40	13.97	42.37	54.00	-11.63	AVG																								
2	10560.274	39.09	13.97	53.06	74.00	-20.94	peak																								
Remarks: 1.Factor (dB/m) = Antenna Factor (dB/m)+Cable Factor (dB)-Pre-amplifier Factor 2.Margin value = Level -Limit value																															

Ant. No.	Ant 1 + Ant 2																														
Ant. Pol.	Vertical																														
Test Mode:	TX 802.11ac(VHT20) Mode 5280MHz (U-NII-2A)																														
Remark:	No report for the emission which more than 20 dB below the prescribed limit.																														
<table border="1"> <thead> <tr> <th>No.</th> <th>Frequency (MHz)</th> <th>Reading (dBuV)</th> <th>Factor (dB/m)</th> <th>Level (dBuV/m)</th> <th>Limit (dBuV/m)</th> <th>Margin (dB)</th> <th>Detector</th> </tr> </thead> <tbody> <tr> <td>1</td> <td>10560.028</td> <td>38.89</td> <td>13.97</td> <td>52.86</td> <td>74.00</td> <td>-21.14</td> <td>peak</td> </tr> <tr> <td>2 *</td> <td>10561.103</td> <td>26.78</td> <td>13.98</td> <td>40.76</td> <td>54.00</td> <td>-13.24</td> <td>AVG</td> </tr> </tbody> </table>								No.	Frequency (MHz)	Reading (dBuV)	Factor (dB/m)	Level (dBuV/m)	Limit (dBuV/m)	Margin (dB)	Detector	1	10560.028	38.89	13.97	52.86	74.00	-21.14	peak	2 *	10561.103	26.78	13.98	40.76	54.00	-13.24	AVG
No.	Frequency (MHz)	Reading (dBuV)	Factor (dB/m)	Level (dBuV/m)	Limit (dBuV/m)	Margin (dB)	Detector																								
1	10560.028	38.89	13.97	52.86	74.00	-21.14	peak																								
2 *	10561.103	26.78	13.98	40.76	54.00	-13.24	AVG																								
Remarks: 1.Factor (dB/m) = Antenna Factor (dB/m)+Cable Factor (dB)-Pre-amplifier Factor 2.Margin value = Level -Limit value																															



Ant. No.	Ant 1 + Ant 2																														
Ant. Pol.	Horizontal																														
Test Mode:	TX 802.11ac(VHT20) Mode 5320MHz (U-NII-2A)																														
Remark:	No report for the emission which more than 20 dB below the prescribed limit.																														
<table border="1"> <thead> <tr> <th>No.</th> <th>Frequency (MHz)</th> <th>Reading (dBuV)</th> <th>Factor (dB/m)</th> <th>Level (dBuV/m)</th> <th>Limit (dBuV/m)</th> <th>Margin (dB)</th> <th>Detector</th> </tr> </thead> <tbody> <tr> <td>1</td> <td>10639.869</td> <td>38.36</td> <td>14.16</td> <td>52.52</td> <td>74.00</td> <td>-21.48</td> <td>peak</td> </tr> <tr> <td>2 *</td> <td>10640.117</td> <td>28.07</td> <td>14.16</td> <td>42.23</td> <td>54.00</td> <td>-11.77</td> <td>AVG</td> </tr> </tbody> </table>								No.	Frequency (MHz)	Reading (dBuV)	Factor (dB/m)	Level (dBuV/m)	Limit (dBuV/m)	Margin (dB)	Detector	1	10639.869	38.36	14.16	52.52	74.00	-21.48	peak	2 *	10640.117	28.07	14.16	42.23	54.00	-11.77	AVG
No.	Frequency (MHz)	Reading (dBuV)	Factor (dB/m)	Level (dBuV/m)	Limit (dBuV/m)	Margin (dB)	Detector																								
1	10639.869	38.36	14.16	52.52	74.00	-21.48	peak																								
2 *	10640.117	28.07	14.16	42.23	54.00	-11.77	AVG																								
Remarks: 1.Factor (dB/m) = Antenna Factor (dB/m)+Cable Factor (dB)-Pre-amplifier Factor 2.Margin value = Level -Limit value																															

Ant. No.	Ant 1 + Ant 2																														
Ant. Pol.	Vertical																														
Test Mode:	TX 802.11ac(VHT20) Mode 5320MHz (U-NII-2A)																														
Remark:	No report for the emission which more than 20 dB below the prescribed limit.																														
<table border="1"> <thead> <tr> <th>No.</th> <th>Frequency (MHz)</th> <th>Reading (dBuV)</th> <th>Factor (dB/m)</th> <th>Level (dBuV/m)</th> <th>Limit (dBuV/m)</th> <th>Margin (dB)</th> <th>Detector</th> </tr> </thead> <tbody> <tr> <td>1</td> <td>10639.776</td> <td>38.70</td> <td>14.16</td> <td>52.86</td> <td>74.00</td> <td>-21.14</td> <td>peak</td> </tr> <tr> <td>2 *</td> <td>10639.880</td> <td>26.76</td> <td>14.16</td> <td>40.92</td> <td>54.00</td> <td>-13.08</td> <td>AVG</td> </tr> </tbody> </table>								No.	Frequency (MHz)	Reading (dBuV)	Factor (dB/m)	Level (dBuV/m)	Limit (dBuV/m)	Margin (dB)	Detector	1	10639.776	38.70	14.16	52.86	74.00	-21.14	peak	2 *	10639.880	26.76	14.16	40.92	54.00	-13.08	AVG
No.	Frequency (MHz)	Reading (dBuV)	Factor (dB/m)	Level (dBuV/m)	Limit (dBuV/m)	Margin (dB)	Detector																								
1	10639.776	38.70	14.16	52.86	74.00	-21.14	peak																								
2 *	10639.880	26.76	14.16	40.92	54.00	-13.08	AVG																								
Remarks: 1.Factor (dB/m) = Antenna Factor (dB/m)+Cable Factor (dB)-Pre-amplifier Factor 2.Margin value = Level -Limit value																															



Ant. No.	Ant 1 + Ant 2																														
Ant. Pol.	Horizontal																														
Test Mode:	TX 802.11n(HT40) Mode 5270MHz (U-NII-2A)																														
Remark:	No report for the emission which more than 20 dB below the prescribed limit.																														
<table border="1"> <thead> <tr> <th>No.</th> <th>Frequency (MHz)</th> <th>Reading (dBUV)</th> <th>Factor (dB/m)</th> <th>Level (dBUV/m)</th> <th>Limit (dBUV/m)</th> <th>Margin (dB)</th> <th>Detector</th> </tr> </thead> <tbody> <tr> <td>1</td> <td>10539.852</td> <td>38.75</td> <td>13.93</td> <td>52.68</td> <td>74.00</td> <td>-21.32</td> <td>peak</td> </tr> <tr> <td>2 *</td> <td>10539.875</td> <td>28.01</td> <td>13.93</td> <td>41.94</td> <td>54.00</td> <td>-12.06</td> <td>AVG</td> </tr> </tbody> </table>								No.	Frequency (MHz)	Reading (dBUV)	Factor (dB/m)	Level (dBUV/m)	Limit (dBUV/m)	Margin (dB)	Detector	1	10539.852	38.75	13.93	52.68	74.00	-21.32	peak	2 *	10539.875	28.01	13.93	41.94	54.00	-12.06	AVG
No.	Frequency (MHz)	Reading (dBUV)	Factor (dB/m)	Level (dBUV/m)	Limit (dBUV/m)	Margin (dB)	Detector																								
1	10539.852	38.75	13.93	52.68	74.00	-21.32	peak																								
2 *	10539.875	28.01	13.93	41.94	54.00	-12.06	AVG																								
Remarks: 1.Factor (dB/m) = Antenna Factor (dB/m)+Cable Factor (dB)-Pre-amplifier Factor 2.Margin value = Level -Limit value																															

Ant. No.	Ant 1 + Ant 2																														
Ant. Pol.	Vertical																														
Test Mode:	TX 802.11n(HT40) Mode 5270MHz (U-NII-2A)																														
Remark:	No report for the emission which more than 20 dB below the prescribed limit.																														
<table border="1"> <thead> <tr> <th>No.</th> <th>Frequency (MHz)</th> <th>Reading (dBUV)</th> <th>Factor (dB/m)</th> <th>Level (dBUV/m)</th> <th>Limit (dBUV/m)</th> <th>Margin (dB)</th> <th>Detector</th> </tr> </thead> <tbody> <tr> <td>1</td> <td>10539.864</td> <td>39.93</td> <td>13.93</td> <td>53.86</td> <td>74.00</td> <td>-20.14</td> <td>peak</td> </tr> <tr> <td>2 *</td> <td>10540.083</td> <td>26.59</td> <td>13.93</td> <td>40.52</td> <td>54.00</td> <td>-13.48</td> <td>AVG</td> </tr> </tbody> </table>								No.	Frequency (MHz)	Reading (dBUV)	Factor (dB/m)	Level (dBUV/m)	Limit (dBUV/m)	Margin (dB)	Detector	1	10539.864	39.93	13.93	53.86	74.00	-20.14	peak	2 *	10540.083	26.59	13.93	40.52	54.00	-13.48	AVG
No.	Frequency (MHz)	Reading (dBUV)	Factor (dB/m)	Level (dBUV/m)	Limit (dBUV/m)	Margin (dB)	Detector																								
1	10539.864	39.93	13.93	53.86	74.00	-20.14	peak																								
2 *	10540.083	26.59	13.93	40.52	54.00	-13.48	AVG																								
Remarks: 1.Factor (dB/m) = Antenna Factor (dB/m)+Cable Factor (dB)-Pre-amplifier Factor 2.Margin value = Level -Limit value																															



Ant. No.	Ant 1 + Ant 2																														
Ant. Pol.	Horizontal																														
Test Mode:	TX 802.11n(HT40) Mode 5310MHz (U-NII-2A)																														
Remark:	No report for the emission which more than 20 dB below the prescribed limit.																														
<table border="1"> <thead> <tr> <th>No.</th> <th>Frequency (MHz)</th> <th>Reading (dBuV)</th> <th>Factor (dB/m)</th> <th>Level (dBuV/m)</th> <th>Limit (dBuV/m)</th> <th>Margin (dB)</th> <th>Detector</th> </tr> </thead> <tbody> <tr> <td>1 *</td> <td>10619.834</td> <td>28.08</td> <td>14.11</td> <td>42.19</td> <td>54.00</td> <td>-11.81</td> <td>AVG</td> </tr> <tr> <td>2</td> <td>10619.858</td> <td>38.92</td> <td>14.11</td> <td>53.03</td> <td>74.00</td> <td>-20.97</td> <td>peak</td> </tr> </tbody> </table>								No.	Frequency (MHz)	Reading (dBuV)	Factor (dB/m)	Level (dBuV/m)	Limit (dBuV/m)	Margin (dB)	Detector	1 *	10619.834	28.08	14.11	42.19	54.00	-11.81	AVG	2	10619.858	38.92	14.11	53.03	74.00	-20.97	peak
No.	Frequency (MHz)	Reading (dBuV)	Factor (dB/m)	Level (dBuV/m)	Limit (dBuV/m)	Margin (dB)	Detector																								
1 *	10619.834	28.08	14.11	42.19	54.00	-11.81	AVG																								
2	10619.858	38.92	14.11	53.03	74.00	-20.97	peak																								
Remarks: 1.Factor (dB/m) = Antenna Factor (dB/m)+Cable Factor (dB)-Pre-amplifier Factor 2.Margin value = Level -Limit value																															

Ant. No.	Ant 1 + Ant 2																														
Ant. Pol.	Vertical																														
Test Mode:	TX 802.11n(HT40) Mode 5310MHz (U-NII-2A)																														
Remark:	No report for the emission which more than 20 dB below the prescribed limit.																														
<table border="1"> <thead> <tr> <th>No.</th> <th>Frequency (MHz)</th> <th>Reading (dBuV)</th> <th>Factor (dB/m)</th> <th>Level (dBuV/m)</th> <th>Limit (dBuV/m)</th> <th>Margin (dB)</th> <th>Detector</th> </tr> </thead> <tbody> <tr> <td>1 *</td> <td>10619.132</td> <td>27.25</td> <td>14.11</td> <td>41.36</td> <td>54.00</td> <td>-12.64</td> <td>AVG</td> </tr> <tr> <td>2</td> <td>10620.863</td> <td>38.64</td> <td>14.11</td> <td>52.75</td> <td>74.00</td> <td>-21.25</td> <td>peak</td> </tr> </tbody> </table>								No.	Frequency (MHz)	Reading (dBuV)	Factor (dB/m)	Level (dBuV/m)	Limit (dBuV/m)	Margin (dB)	Detector	1 *	10619.132	27.25	14.11	41.36	54.00	-12.64	AVG	2	10620.863	38.64	14.11	52.75	74.00	-21.25	peak
No.	Frequency (MHz)	Reading (dBuV)	Factor (dB/m)	Level (dBuV/m)	Limit (dBuV/m)	Margin (dB)	Detector																								
1 *	10619.132	27.25	14.11	41.36	54.00	-12.64	AVG																								
2	10620.863	38.64	14.11	52.75	74.00	-21.25	peak																								
Remarks: 1.Factor (dB/m) = Antenna Factor (dB/m)+Cable Factor (dB)-Pre-amplifier Factor 2.Margin value = Level -Limit value																															



Ant. No.	Ant 1 + Ant 2																														
Ant. Pol.	Horizontal																														
Test Mode:	TX 802.11ac(VHT40) Mode 5270MHz (U-NII-2A)																														
Remark:	No report for the emission which more than 20 dB below the prescribed limit.																														
<table border="1"> <thead> <tr> <th>No.</th> <th>Frequency (MHz)</th> <th>Reading (dBuV)</th> <th>Factor (dB/m)</th> <th>Level (dBuV/m)</th> <th>Limit (dBuV/m)</th> <th>Margin (dB)</th> <th>Detector</th> </tr> </thead> <tbody> <tr> <td>1</td> <td>10539.959</td> <td>39.19</td> <td>13.93</td> <td>53.12</td> <td>74.00</td> <td>-20.88</td> <td>peak</td> </tr> <tr> <td>2 *</td> <td>10540.420</td> <td>28.26</td> <td>13.93</td> <td>42.19</td> <td>54.00</td> <td>-11.81</td> <td>AVG</td> </tr> </tbody> </table>								No.	Frequency (MHz)	Reading (dBuV)	Factor (dB/m)	Level (dBuV/m)	Limit (dBuV/m)	Margin (dB)	Detector	1	10539.959	39.19	13.93	53.12	74.00	-20.88	peak	2 *	10540.420	28.26	13.93	42.19	54.00	-11.81	AVG
No.	Frequency (MHz)	Reading (dBuV)	Factor (dB/m)	Level (dBuV/m)	Limit (dBuV/m)	Margin (dB)	Detector																								
1	10539.959	39.19	13.93	53.12	74.00	-20.88	peak																								
2 *	10540.420	28.26	13.93	42.19	54.00	-11.81	AVG																								
Remarks: 1.Factor (dB/m) = Antenna Factor (dB/m)+Cable Factor (dB)-Pre-amplifier Factor 2.Margin value = Level -Limit value																															

Ant. No.	Ant 1 + Ant 2																														
Ant. Pol.	Vertical																														
Test Mode:	TX 802.11ac(VHT40) Mode 5270MHz (U-NII-2A)																														
Remark:	No report for the emission which more than 20 dB below the prescribed limit.																														
<table border="1"> <thead> <tr> <th>No.</th> <th>Frequency (MHz)</th> <th>Reading (dBuV)</th> <th>Factor (dB/m)</th> <th>Level (dBuV/m)</th> <th>Limit (dBuV/m)</th> <th>Margin (dB)</th> <th>Detector</th> </tr> </thead> <tbody> <tr> <td>1</td> <td>10539.921</td> <td>39.36</td> <td>13.93</td> <td>53.29</td> <td>74.00</td> <td>-20.71</td> <td>peak</td> </tr> <tr> <td>2 *</td> <td>10540.051</td> <td>27.41</td> <td>13.93</td> <td>41.34</td> <td>54.00</td> <td>-12.66</td> <td>AVG</td> </tr> </tbody> </table>								No.	Frequency (MHz)	Reading (dBuV)	Factor (dB/m)	Level (dBuV/m)	Limit (dBuV/m)	Margin (dB)	Detector	1	10539.921	39.36	13.93	53.29	74.00	-20.71	peak	2 *	10540.051	27.41	13.93	41.34	54.00	-12.66	AVG
No.	Frequency (MHz)	Reading (dBuV)	Factor (dB/m)	Level (dBuV/m)	Limit (dBuV/m)	Margin (dB)	Detector																								
1	10539.921	39.36	13.93	53.29	74.00	-20.71	peak																								
2 *	10540.051	27.41	13.93	41.34	54.00	-12.66	AVG																								
Remarks: 1.Factor (dB/m) = Antenna Factor (dB/m)+Cable Factor (dB)-Pre-amplifier Factor 2.Margin value = Level -Limit value																															



Ant. No.	Ant 1 + Ant 2																														
Ant. Pol.	Horizontal																														
Test Mode:	TX 802.11ac(VHT40) Mode 5310MHz (U-NII-2A)																														
Remark:	No report for the emission which more than 20 dB below the prescribed limit.																														
<table border="1"> <thead> <tr> <th>No.</th> <th>Frequency (MHz)</th> <th>Reading (dBuV)</th> <th>Factor (dB/m)</th> <th>Level (dBuV/m)</th> <th>Limit (dBuV/m)</th> <th>Margin (dB)</th> <th>Detector</th> </tr> </thead> <tbody> <tr> <td>1</td> <td>10619.760</td> <td>38.72</td> <td>14.11</td> <td>52.83</td> <td>74.00</td> <td>-21.17</td> <td>peak</td> </tr> <tr> <td>2 *</td> <td>10619.921</td> <td>27.24</td> <td>14.11</td> <td>41.35</td> <td>54.00</td> <td>-12.65</td> <td>AVG</td> </tr> </tbody> </table>								No.	Frequency (MHz)	Reading (dBuV)	Factor (dB/m)	Level (dBuV/m)	Limit (dBuV/m)	Margin (dB)	Detector	1	10619.760	38.72	14.11	52.83	74.00	-21.17	peak	2 *	10619.921	27.24	14.11	41.35	54.00	-12.65	AVG
No.	Frequency (MHz)	Reading (dBuV)	Factor (dB/m)	Level (dBuV/m)	Limit (dBuV/m)	Margin (dB)	Detector																								
1	10619.760	38.72	14.11	52.83	74.00	-21.17	peak																								
2 *	10619.921	27.24	14.11	41.35	54.00	-12.65	AVG																								
Remarks: 1.Factor (dB/m) = Antenna Factor (dB/m)+Cable Factor (dB)-Pre-amplifier Factor 2.Margin value = Level -Limit value																															

Ant. No.	Ant 1 + Ant 2																														
Ant. Pol.	Vertical																														
Test Mode:	TX 802.11ac(VHT40) Mode 5310MHz (U-NII-2A)																														
Remark:	No report for the emission which more than 20 dB below the prescribed limit.																														
<table border="1"> <thead> <tr> <th>No.</th> <th>Frequency (MHz)</th> <th>Reading (dBuV)</th> <th>Factor (dB/m)</th> <th>Level (dBuV/m)</th> <th>Limit (dBuV/m)</th> <th>Margin (dB)</th> <th>Detector</th> </tr> </thead> <tbody> <tr> <td>1</td> <td>10619.864</td> <td>38.92</td> <td>14.11</td> <td>53.03</td> <td>74.00</td> <td>-20.97</td> <td>peak</td> </tr> <tr> <td>2 *</td> <td>10619.886</td> <td>26.43</td> <td>14.11</td> <td>40.54</td> <td>54.00</td> <td>-13.46</td> <td>AVG</td> </tr> </tbody> </table>								No.	Frequency (MHz)	Reading (dBuV)	Factor (dB/m)	Level (dBuV/m)	Limit (dBuV/m)	Margin (dB)	Detector	1	10619.864	38.92	14.11	53.03	74.00	-20.97	peak	2 *	10619.886	26.43	14.11	40.54	54.00	-13.46	AVG
No.	Frequency (MHz)	Reading (dBuV)	Factor (dB/m)	Level (dBuV/m)	Limit (dBuV/m)	Margin (dB)	Detector																								
1	10619.864	38.92	14.11	53.03	74.00	-20.97	peak																								
2 *	10619.886	26.43	14.11	40.54	54.00	-13.46	AVG																								
Remarks: 1.Factor (dB/m) = Antenna Factor (dB/m)+Cable Factor (dB)-Pre-amplifier Factor 2.Margin value = Level -Limit value																															



Ant. No.	Ant 1 + Ant 2																														
Ant. Pol.	Horizontal																														
Test Mode:	TX 802.11ac(VHT80) Mode 5290MHz (U-NII-2A)																														
Remark:	No report for the emission which more than 20 dB below the prescribed limit.																														
<table border="1"> <thead> <tr> <th>No.</th> <th>Frequency (MHz)</th> <th>Reading (dBuV)</th> <th>Factor (dB/m)</th> <th>Level (dBuV/m)</th> <th>Limit (dBuV/m)</th> <th>Margin (dB)</th> <th>Detector</th> </tr> </thead> <tbody> <tr> <td>1 *</td> <td>10579.855</td> <td>27.97</td> <td>14.02</td> <td>41.99</td> <td>54.00</td> <td>-12.01</td> <td>AVG</td> </tr> <tr> <td>2</td> <td>10580.051</td> <td>38.86</td> <td>14.02</td> <td>52.88</td> <td>74.00</td> <td>-21.12</td> <td>peak</td> </tr> </tbody> </table>								No.	Frequency (MHz)	Reading (dBuV)	Factor (dB/m)	Level (dBuV/m)	Limit (dBuV/m)	Margin (dB)	Detector	1 *	10579.855	27.97	14.02	41.99	54.00	-12.01	AVG	2	10580.051	38.86	14.02	52.88	74.00	-21.12	peak
No.	Frequency (MHz)	Reading (dBuV)	Factor (dB/m)	Level (dBuV/m)	Limit (dBuV/m)	Margin (dB)	Detector																								
1 *	10579.855	27.97	14.02	41.99	54.00	-12.01	AVG																								
2	10580.051	38.86	14.02	52.88	74.00	-21.12	peak																								
Remarks: 1.Factor (dB/m) = Antenna Factor (dB/m)+Cable Factor (dB)-Pre-amplifier Factor 2.Margin value = Level -Limit value																															

Ant. No.	Ant 1 + Ant 2																														
Ant. Pol.	Vertical																														
Test Mode:	TX 802.11ac(VHT80) Mode 5290MHz (U-NII-2A)																														
Remark:	No report for the emission which more than 20 dB below the prescribed limit.																														
<table border="1"> <thead> <tr> <th>No.</th> <th>Frequency (MHz)</th> <th>Reading (dBuV)</th> <th>Factor (dB/m)</th> <th>Level (dBuV/m)</th> <th>Limit (dBuV/m)</th> <th>Margin (dB)</th> <th>Detector</th> </tr> </thead> <tbody> <tr> <td>1 *</td> <td>10579.863</td> <td>26.77</td> <td>14.02</td> <td>40.79</td> <td>54.00</td> <td>-13.21</td> <td>AVG</td> </tr> <tr> <td>2</td> <td>10579.874</td> <td>39.91</td> <td>14.02</td> <td>53.93</td> <td>74.00</td> <td>-20.07</td> <td>peak</td> </tr> </tbody> </table>								No.	Frequency (MHz)	Reading (dBuV)	Factor (dB/m)	Level (dBuV/m)	Limit (dBuV/m)	Margin (dB)	Detector	1 *	10579.863	26.77	14.02	40.79	54.00	-13.21	AVG	2	10579.874	39.91	14.02	53.93	74.00	-20.07	peak
No.	Frequency (MHz)	Reading (dBuV)	Factor (dB/m)	Level (dBuV/m)	Limit (dBuV/m)	Margin (dB)	Detector																								
1 *	10579.863	26.77	14.02	40.79	54.00	-13.21	AVG																								
2	10579.874	39.91	14.02	53.93	74.00	-20.07	peak																								
Remarks: 1.Factor (dB/m) = Antenna Factor (dB/m)+Cable Factor (dB)-Pre-amplifier Factor 2.Margin value = Level -Limit value																															



Ant. No.	Ant 2																														
Ant. Pol.	Horizontal																														
Test Mode:	TX 802.11a Mode 5500MHz (U-NII-2C)																														
Remark:	No report for the emission which more than 20 dB below the prescribed limit.																														
<table border="1"> <thead> <tr> <th>No.</th> <th>Frequency (MHz)</th> <th>Reading (dBuV)</th> <th>Factor (dB/m)</th> <th>Level (dBuV/m)</th> <th>Limit (dBuV/m)</th> <th>Margin (dB)</th> <th>Detector</th> </tr> </thead> <tbody> <tr> <td>1 *</td> <td>10999.899</td> <td>26.79</td> <td>14.97</td> <td>41.76</td> <td>54.00</td> <td>-12.24</td> <td>AVG</td> </tr> <tr> <td>2</td> <td>11000.126</td> <td>37.66</td> <td>14.97</td> <td>52.63</td> <td>74.00</td> <td>-21.37</td> <td>peak</td> </tr> </tbody> </table>								No.	Frequency (MHz)	Reading (dBuV)	Factor (dB/m)	Level (dBuV/m)	Limit (dBuV/m)	Margin (dB)	Detector	1 *	10999.899	26.79	14.97	41.76	54.00	-12.24	AVG	2	11000.126	37.66	14.97	52.63	74.00	-21.37	peak
No.	Frequency (MHz)	Reading (dBuV)	Factor (dB/m)	Level (dBuV/m)	Limit (dBuV/m)	Margin (dB)	Detector																								
1 *	10999.899	26.79	14.97	41.76	54.00	-12.24	AVG																								
2	11000.126	37.66	14.97	52.63	74.00	-21.37	peak																								
Remarks: 1.Factor (dB/m) = Antenna Factor (dB/m)+Cable Factor (dB)-Pre-amplifier Factor 2.Margin value = Level -Limit value																															

Ant. No.	Ant 2																														
Ant. Pol.	Vertical																														
Test Mode:	TX 802.11a Mode 5500MHz (U-NII-2C)																														
Remark:	No report for the emission which more than 20 dB below the prescribed limit.																														
<table border="1"> <thead> <tr> <th>No.</th> <th>Frequency (MHz)</th> <th>Reading (dBuV)</th> <th>Factor (dB/m)</th> <th>Level (dBuV/m)</th> <th>Limit (dBuV/m)</th> <th>Margin (dB)</th> <th>Detector</th> </tr> </thead> <tbody> <tr> <td>1</td> <td>10999.952</td> <td>38.70</td> <td>14.97</td> <td>53.67</td> <td>74.00</td> <td>-20.33</td> <td>peak</td> </tr> <tr> <td>2 *</td> <td>11000.155</td> <td>25.92</td> <td>14.97</td> <td>40.89</td> <td>54.00</td> <td>-13.11</td> <td>AVG</td> </tr> </tbody> </table>								No.	Frequency (MHz)	Reading (dBuV)	Factor (dB/m)	Level (dBuV/m)	Limit (dBuV/m)	Margin (dB)	Detector	1	10999.952	38.70	14.97	53.67	74.00	-20.33	peak	2 *	11000.155	25.92	14.97	40.89	54.00	-13.11	AVG
No.	Frequency (MHz)	Reading (dBuV)	Factor (dB/m)	Level (dBuV/m)	Limit (dBuV/m)	Margin (dB)	Detector																								
1	10999.952	38.70	14.97	53.67	74.00	-20.33	peak																								
2 *	11000.155	25.92	14.97	40.89	54.00	-13.11	AVG																								
Remarks: 1.Factor (dB/m) = Antenna Factor (dB/m)+Cable Factor (dB)-Pre-amplifier Factor 2.Margin value = Level -Limit value																															



Ant. No.	Ant 2																														
Ant. Pol.	Horizontal																														
Test Mode:	TX 802.11a Mode 5580MHz (U-NII-2C)																														
Remark:	No report for the emission which more than 20 dB below the prescribed limit.																														
<table border="1"> <thead> <tr> <th>No.</th> <th>Frequency (MHz)</th> <th>Reading (dBuV)</th> <th>Factor (dB/m)</th> <th>Level (dBuV/m)</th> <th>Limit (dBuV/m)</th> <th>Margin (dB)</th> <th>Detector</th> </tr> </thead> <tbody> <tr> <td>1 *</td> <td>11160.028</td> <td>26.81</td> <td>14.98</td> <td>41.79</td> <td>54.00</td> <td>-12.21</td> <td>AVG</td> </tr> <tr> <td>2</td> <td>11160.306</td> <td>37.93</td> <td>14.98</td> <td>52.91</td> <td>74.00</td> <td>-21.09</td> <td>peak</td> </tr> </tbody> </table>								No.	Frequency (MHz)	Reading (dBuV)	Factor (dB/m)	Level (dBuV/m)	Limit (dBuV/m)	Margin (dB)	Detector	1 *	11160.028	26.81	14.98	41.79	54.00	-12.21	AVG	2	11160.306	37.93	14.98	52.91	74.00	-21.09	peak
No.	Frequency (MHz)	Reading (dBuV)	Factor (dB/m)	Level (dBuV/m)	Limit (dBuV/m)	Margin (dB)	Detector																								
1 *	11160.028	26.81	14.98	41.79	54.00	-12.21	AVG																								
2	11160.306	37.93	14.98	52.91	74.00	-21.09	peak																								
Remarks: 1.Factor (dB/m) = Antenna Factor (dB/m)+Cable Factor (dB)-Pre-amplifier Factor 2.Margin value = Level -Limit value																															

Ant. No.	Ant 2																														
Ant. Pol.	Vertical																														
Test Mode:	TX 802.11a Mode 5580MHz (U-NII-2C)																														
Remark:	No report for the emission which more than 20 dB below the prescribed limit.																														
<table border="1"> <thead> <tr> <th>No.</th> <th>Frequency (MHz)</th> <th>Reading (dBuV)</th> <th>Factor (dB/m)</th> <th>Level (dBuV/m)</th> <th>Limit (dBuV/m)</th> <th>Margin (dB)</th> <th>Detector</th> </tr> </thead> <tbody> <tr> <td>1 *</td> <td>11160.044</td> <td>25.81</td> <td>14.98</td> <td>40.79</td> <td>54.00</td> <td>-13.21</td> <td>AVG</td> </tr> <tr> <td>2</td> <td>11161.123</td> <td>38.45</td> <td>14.97</td> <td>53.42</td> <td>74.00</td> <td>-20.58</td> <td>peak</td> </tr> </tbody> </table>								No.	Frequency (MHz)	Reading (dBuV)	Factor (dB/m)	Level (dBuV/m)	Limit (dBuV/m)	Margin (dB)	Detector	1 *	11160.044	25.81	14.98	40.79	54.00	-13.21	AVG	2	11161.123	38.45	14.97	53.42	74.00	-20.58	peak
No.	Frequency (MHz)	Reading (dBuV)	Factor (dB/m)	Level (dBuV/m)	Limit (dBuV/m)	Margin (dB)	Detector																								
1 *	11160.044	25.81	14.98	40.79	54.00	-13.21	AVG																								
2	11161.123	38.45	14.97	53.42	74.00	-20.58	peak																								
Remarks: 1.Factor (dB/m) = Antenna Factor (dB/m)+Cable Factor (dB)-Pre-amplifier Factor 2.Margin value = Level -Limit value																															



Ant. No.	Ant 2																														
Ant. Pol.	Horizontal																														
Test Mode:	TX 802.11a Mode 5700MHz (U-NII-2C)																														
Remark:	No report for the emission which more than 20 dB below the prescribed limit.																														
<table border="1"> <thead> <tr> <th>No.</th> <th>Frequency (MHz)</th> <th>Reading (dBuV)</th> <th>Factor (dB/m)</th> <th>Level (dBuV/m)</th> <th>Limit (dBuV/m)</th> <th>Margin (dB)</th> <th>Detector</th> </tr> </thead> <tbody> <tr> <td>1 *</td> <td>11399.962</td> <td>27.10</td> <td>14.99</td> <td>42.09</td> <td>54.00</td> <td>-11.91</td> <td>AVG</td> </tr> <tr> <td>2</td> <td>11400.043</td> <td>38.84</td> <td>14.99</td> <td>53.83</td> <td>74.00</td> <td>-20.17</td> <td>peak</td> </tr> </tbody> </table>								No.	Frequency (MHz)	Reading (dBuV)	Factor (dB/m)	Level (dBuV/m)	Limit (dBuV/m)	Margin (dB)	Detector	1 *	11399.962	27.10	14.99	42.09	54.00	-11.91	AVG	2	11400.043	38.84	14.99	53.83	74.00	-20.17	peak
No.	Frequency (MHz)	Reading (dBuV)	Factor (dB/m)	Level (dBuV/m)	Limit (dBuV/m)	Margin (dB)	Detector																								
1 *	11399.962	27.10	14.99	42.09	54.00	-11.91	AVG																								
2	11400.043	38.84	14.99	53.83	74.00	-20.17	peak																								
Remarks: 1.Factor (dB/m) = Antenna Factor (dB/m)+Cable Factor (dB)-Pre-amplifier Factor 2.Margin value = Level -Limit value																															

Ant. No.	Ant 2																														
Ant. Pol.	Vertical																														
Test Mode:	TX 802.11a Mode 5700MHz (U-NII-2C)																														
Remark:	No report for the emission which more than 20 dB below the prescribed limit.																														
<table border="1"> <thead> <tr> <th>No.</th> <th>Frequency (MHz)</th> <th>Reading (dBuV)</th> <th>Factor (dB/m)</th> <th>Level (dBuV/m)</th> <th>Limit (dBuV/m)</th> <th>Margin (dB)</th> <th>Detector</th> </tr> </thead> <tbody> <tr> <td>1</td> <td>11399.878</td> <td>38.06</td> <td>14.99</td> <td>53.05</td> <td>74.00</td> <td>-20.95</td> <td>peak</td> </tr> <tr> <td>2 *</td> <td>11400.480</td> <td>25.39</td> <td>14.99</td> <td>40.38</td> <td>54.00</td> <td>-13.62</td> <td>AVG</td> </tr> </tbody> </table>								No.	Frequency (MHz)	Reading (dBuV)	Factor (dB/m)	Level (dBuV/m)	Limit (dBuV/m)	Margin (dB)	Detector	1	11399.878	38.06	14.99	53.05	74.00	-20.95	peak	2 *	11400.480	25.39	14.99	40.38	54.00	-13.62	AVG
No.	Frequency (MHz)	Reading (dBuV)	Factor (dB/m)	Level (dBuV/m)	Limit (dBuV/m)	Margin (dB)	Detector																								
1	11399.878	38.06	14.99	53.05	74.00	-20.95	peak																								
2 *	11400.480	25.39	14.99	40.38	54.00	-13.62	AVG																								
Remarks: 1.Factor (dB/m) = Antenna Factor (dB/m)+Cable Factor (dB)-Pre-amplifier Factor 2.Margin value = Level -Limit value																															



Ant. No.	Ant 1 + Ant 2																														
Ant. Pol.	Horizontal																														
Test Mode:	TX 802.11n(HT20) Mode 5500MHz (U-NII-2C)																														
Remark:	No report for the emission which more than 20 dB below the prescribed limit.																														
<table border="1"> <thead> <tr> <th>No.</th> <th>Frequency (MHz)</th> <th>Reading (dBuV)</th> <th>Factor (dB/m)</th> <th>Level (dBuV/m)</th> <th>Limit (dBuV/m)</th> <th>Margin (dB)</th> <th>Detector</th> </tr> </thead> <tbody> <tr> <td>1</td> <td>11000.033</td> <td>37.98</td> <td>14.97</td> <td>52.95</td> <td>74.00</td> <td>-21.05</td> <td>peak</td> </tr> <tr> <td>2 *</td> <td>11000.107</td> <td>27.32</td> <td>14.97</td> <td>42.29</td> <td>54.00</td> <td>-11.71</td> <td>AVG</td> </tr> </tbody> </table>								No.	Frequency (MHz)	Reading (dBuV)	Factor (dB/m)	Level (dBuV/m)	Limit (dBuV/m)	Margin (dB)	Detector	1	11000.033	37.98	14.97	52.95	74.00	-21.05	peak	2 *	11000.107	27.32	14.97	42.29	54.00	-11.71	AVG
No.	Frequency (MHz)	Reading (dBuV)	Factor (dB/m)	Level (dBuV/m)	Limit (dBuV/m)	Margin (dB)	Detector																								
1	11000.033	37.98	14.97	52.95	74.00	-21.05	peak																								
2 *	11000.107	27.32	14.97	42.29	54.00	-11.71	AVG																								
Remarks: 1.Factor (dB/m) = Antenna Factor (dB/m)+Cable Factor (dB)-Pre-amplifier Factor 2.Margin value = Level -Limit value																															

Ant. No.	Ant 1 + Ant 2																														
Ant. Pol.	Vertical																														
Test Mode:	TX 802.11n(HT20) Mode 5500MHz (U-NII-2C)																														
Remark:	No report for the emission which more than 20 dB below the prescribed limit.																														
<table border="1"> <thead> <tr> <th>No.</th> <th>Frequency (MHz)</th> <th>Reading (dBuV)</th> <th>Factor (dB/m)</th> <th>Level (dBuV/m)</th> <th>Limit (dBuV/m)</th> <th>Margin (dB)</th> <th>Detector</th> </tr> </thead> <tbody> <tr> <td>1 *</td> <td>10999.947</td> <td>25.62</td> <td>14.97</td> <td>40.59</td> <td>54.00</td> <td>-13.41</td> <td>AVG</td> </tr> <tr> <td>2</td> <td>11000.523</td> <td>37.79</td> <td>14.97</td> <td>52.76</td> <td>74.00</td> <td>-21.24</td> <td>peak</td> </tr> </tbody> </table>								No.	Frequency (MHz)	Reading (dBuV)	Factor (dB/m)	Level (dBuV/m)	Limit (dBuV/m)	Margin (dB)	Detector	1 *	10999.947	25.62	14.97	40.59	54.00	-13.41	AVG	2	11000.523	37.79	14.97	52.76	74.00	-21.24	peak
No.	Frequency (MHz)	Reading (dBuV)	Factor (dB/m)	Level (dBuV/m)	Limit (dBuV/m)	Margin (dB)	Detector																								
1 *	10999.947	25.62	14.97	40.59	54.00	-13.41	AVG																								
2	11000.523	37.79	14.97	52.76	74.00	-21.24	peak																								
Remarks: 1.Factor (dB/m) = Antenna Factor (dB/m)+Cable Factor (dB)-Pre-amplifier Factor 2.Margin value = Level -Limit value																															



Ant. No.	Ant 1 + Ant 2																														
Ant. Pol.	Horizontal																														
Test Mode:	TX 802.11n(HT20) Mode 5580MHz (U-NII-2C)																														
Remark:	No report for the emission which more than 20 dB below the prescribed limit.																														
<table border="1"> <thead> <tr> <th>No.</th> <th>Frequency (MHz)</th> <th>Reading (dBuV)</th> <th>Factor (dB/m)</th> <th>Level (dBuV/m)</th> <th>Limit (dBuV/m)</th> <th>Margin (dB)</th> <th>Detector</th> </tr> </thead> <tbody> <tr> <td>1</td> <td>11159.809</td> <td>38.32</td> <td>14.98</td> <td>53.30</td> <td>74.00</td> <td>-20.70</td> <td>peak</td> </tr> <tr> <td>2 *</td> <td>11160.166</td> <td>27.39</td> <td>14.98</td> <td>42.37</td> <td>54.00</td> <td>-11.63</td> <td>AVG</td> </tr> </tbody> </table>								No.	Frequency (MHz)	Reading (dBuV)	Factor (dB/m)	Level (dBuV/m)	Limit (dBuV/m)	Margin (dB)	Detector	1	11159.809	38.32	14.98	53.30	74.00	-20.70	peak	2 *	11160.166	27.39	14.98	42.37	54.00	-11.63	AVG
No.	Frequency (MHz)	Reading (dBuV)	Factor (dB/m)	Level (dBuV/m)	Limit (dBuV/m)	Margin (dB)	Detector																								
1	11159.809	38.32	14.98	53.30	74.00	-20.70	peak																								
2 *	11160.166	27.39	14.98	42.37	54.00	-11.63	AVG																								
Remarks: 1.Factor (dB/m) = Antenna Factor (dB/m)+Cable Factor (dB)-Pre-amplifier Factor 2.Margin value = Level -Limit value																															

Ant. No.	Ant 1 + Ant 2																														
Ant. Pol.	Vertical																														
Test Mode:	TX 802.11n(HT20) Mode 5580MHz (U-NII-2C)																														
Remark:	No report for the emission which more than 20 dB below the prescribed limit.																														
<table border="1"> <thead> <tr> <th>No.</th> <th>Frequency (MHz)</th> <th>Reading (dBuV)</th> <th>Factor (dB/m)</th> <th>Level (dBuV/m)</th> <th>Limit (dBuV/m)</th> <th>Margin (dB)</th> <th>Detector</th> </tr> </thead> <tbody> <tr> <td>1 *</td> <td>11159.843</td> <td>26.18</td> <td>14.98</td> <td>41.16</td> <td>54.00</td> <td>-12.84</td> <td>AVG</td> </tr> <tr> <td>2</td> <td>11159.875</td> <td>39.04</td> <td>14.98</td> <td>54.02</td> <td>74.00</td> <td>-19.98</td> <td>peak</td> </tr> </tbody> </table>								No.	Frequency (MHz)	Reading (dBuV)	Factor (dB/m)	Level (dBuV/m)	Limit (dBuV/m)	Margin (dB)	Detector	1 *	11159.843	26.18	14.98	41.16	54.00	-12.84	AVG	2	11159.875	39.04	14.98	54.02	74.00	-19.98	peak
No.	Frequency (MHz)	Reading (dBuV)	Factor (dB/m)	Level (dBuV/m)	Limit (dBuV/m)	Margin (dB)	Detector																								
1 *	11159.843	26.18	14.98	41.16	54.00	-12.84	AVG																								
2	11159.875	39.04	14.98	54.02	74.00	-19.98	peak																								
Remarks: 1.Factor (dB/m) = Antenna Factor (dB/m)+Cable Factor (dB)-Pre-amplifier Factor 2.Margin value = Level -Limit value																															



Ant. No.	Ant 1 + Ant 2																														
Ant. Pol.	Horizontal																														
Test Mode:	TX 802.11n(HT20) Mode 5700MHz (U-NII-2C)																														
Remark:	No report for the emission which more than 20 dB below the prescribed limit.																														
<table border="1"> <thead> <tr> <th>No.</th> <th>Frequency (MHz)</th> <th>Reading (dBuV)</th> <th>Factor (dB/m)</th> <th>Level (dBuV/m)</th> <th>Limit (dBuV/m)</th> <th>Margin (dB)</th> <th>Detector</th> </tr> </thead> <tbody> <tr> <td>1 *</td> <td>11399.798</td> <td>27.88</td> <td>14.99</td> <td>42.87</td> <td>54.00</td> <td>-11.13</td> <td>AVG</td> </tr> <tr> <td>2</td> <td>11400.036</td> <td>38.55</td> <td>14.99</td> <td>53.54</td> <td>74.00</td> <td>-20.46</td> <td>peak</td> </tr> </tbody> </table>								No.	Frequency (MHz)	Reading (dBuV)	Factor (dB/m)	Level (dBuV/m)	Limit (dBuV/m)	Margin (dB)	Detector	1 *	11399.798	27.88	14.99	42.87	54.00	-11.13	AVG	2	11400.036	38.55	14.99	53.54	74.00	-20.46	peak
No.	Frequency (MHz)	Reading (dBuV)	Factor (dB/m)	Level (dBuV/m)	Limit (dBuV/m)	Margin (dB)	Detector																								
1 *	11399.798	27.88	14.99	42.87	54.00	-11.13	AVG																								
2	11400.036	38.55	14.99	53.54	74.00	-20.46	peak																								
Remarks: 1.Factor (dB/m) = Antenna Factor (dB/m)+Cable Factor (dB)-Pre-amplifier Factor 2.Margin value = Level -Limit value																															

Ant. No.	Ant 1 + Ant 2																														
Ant. Pol.	Vertical																														
Test Mode:	TX 802.11n(HT20) Mode 5700MHz (U-NII-2C)																														
Remark:	No report for the emission which more than 20 dB below the prescribed limit.																														
<table border="1"> <thead> <tr> <th>No.</th> <th>Frequency (MHz)</th> <th>Reading (dBuV)</th> <th>Factor (dB/m)</th> <th>Level (dBuV/m)</th> <th>Limit (dBuV/m)</th> <th>Margin (dB)</th> <th>Detector</th> </tr> </thead> <tbody> <tr> <td>1 *</td> <td>11400.345</td> <td>25.98</td> <td>14.99</td> <td>40.97</td> <td>54.00</td> <td>-13.03</td> <td>AVG</td> </tr> <tr> <td>2</td> <td>11400.384</td> <td>38.02</td> <td>14.99</td> <td>53.01</td> <td>74.00</td> <td>-20.99</td> <td>peak</td> </tr> </tbody> </table>								No.	Frequency (MHz)	Reading (dBuV)	Factor (dB/m)	Level (dBuV/m)	Limit (dBuV/m)	Margin (dB)	Detector	1 *	11400.345	25.98	14.99	40.97	54.00	-13.03	AVG	2	11400.384	38.02	14.99	53.01	74.00	-20.99	peak
No.	Frequency (MHz)	Reading (dBuV)	Factor (dB/m)	Level (dBuV/m)	Limit (dBuV/m)	Margin (dB)	Detector																								
1 *	11400.345	25.98	14.99	40.97	54.00	-13.03	AVG																								
2	11400.384	38.02	14.99	53.01	74.00	-20.99	peak																								
Remarks: 1.Factor (dB/m) = Antenna Factor (dB/m)+Cable Factor (dB)-Pre-amplifier Factor 2.Margin value = Level -Limit value																															



Ant. No.	Ant 1 + Ant 2																														
Ant. Pol.	Horizontal																														
Test Mode:	TX 802.11ac(VHT20) Mode 5500MHz (U-NII-2C)																														
Remark:	No report for the emission which more than 20 dB below the prescribed limit.																														
<table border="1"> <thead> <tr> <th>No.</th> <th>Frequency (MHz)</th> <th>Reading (dBuV)</th> <th>Factor (dB/m)</th> <th>Level (dBuV/m)</th> <th>Limit (dBuV/m)</th> <th>Margin (dB)</th> <th>Detector</th> </tr> </thead> <tbody> <tr> <td>1 *</td> <td>10999.930</td> <td>27.88</td> <td>14.97</td> <td>42.85</td> <td>54.00</td> <td>-11.15</td> <td>AVG</td> </tr> <tr> <td>2</td> <td>11000.155</td> <td>38.56</td> <td>14.97</td> <td>53.53</td> <td>74.00</td> <td>-20.47</td> <td>peak</td> </tr> </tbody> </table>								No.	Frequency (MHz)	Reading (dBuV)	Factor (dB/m)	Level (dBuV/m)	Limit (dBuV/m)	Margin (dB)	Detector	1 *	10999.930	27.88	14.97	42.85	54.00	-11.15	AVG	2	11000.155	38.56	14.97	53.53	74.00	-20.47	peak
No.	Frequency (MHz)	Reading (dBuV)	Factor (dB/m)	Level (dBuV/m)	Limit (dBuV/m)	Margin (dB)	Detector																								
1 *	10999.930	27.88	14.97	42.85	54.00	-11.15	AVG																								
2	11000.155	38.56	14.97	53.53	74.00	-20.47	peak																								
Remarks: 1.Factor (dB/m) = Antenna Factor (dB/m)+Cable Factor (dB)-Pre-amplifier Factor 2.Margin value = Level -Limit value																															

Ant. No.	Ant 1 + Ant 2																														
Ant. Pol.	Vertical																														
Test Mode:	TX 802.11ac(VHT20) Mode 5500MHz (U-NII-2C)																														
Remark:	No report for the emission which more than 20 dB below the prescribed limit.																														
<table border="1"> <thead> <tr> <th>No.</th> <th>Frequency (MHz)</th> <th>Reading (dBuV)</th> <th>Factor (dB/m)</th> <th>Level (dBuV/m)</th> <th>Limit (dBuV/m)</th> <th>Margin (dB)</th> <th>Detector</th> </tr> </thead> <tbody> <tr> <td>1</td> <td>11000.162</td> <td>38.23</td> <td>14.97</td> <td>53.20</td> <td>74.00</td> <td>-20.80</td> <td>peak</td> </tr> <tr> <td>2 *</td> <td>11000.184</td> <td>25.92</td> <td>14.97</td> <td>40.89</td> <td>54.00</td> <td>-13.11</td> <td>AVG</td> </tr> </tbody> </table>								No.	Frequency (MHz)	Reading (dBuV)	Factor (dB/m)	Level (dBuV/m)	Limit (dBuV/m)	Margin (dB)	Detector	1	11000.162	38.23	14.97	53.20	74.00	-20.80	peak	2 *	11000.184	25.92	14.97	40.89	54.00	-13.11	AVG
No.	Frequency (MHz)	Reading (dBuV)	Factor (dB/m)	Level (dBuV/m)	Limit (dBuV/m)	Margin (dB)	Detector																								
1	11000.162	38.23	14.97	53.20	74.00	-20.80	peak																								
2 *	11000.184	25.92	14.97	40.89	54.00	-13.11	AVG																								
Remarks: 1.Factor (dB/m) = Antenna Factor (dB/m)+Cable Factor (dB)-Pre-amplifier Factor 2.Margin value = Level -Limit value																															



Ant. No.	Ant 1 + Ant 2																														
Ant. Pol.	Horizontal																														
Test Mode:	TX 802.11ac(VHT20) Mode 5580MHz (U-NII-2C)																														
Remark:	No report for the emission which more than 20 dB below the prescribed limit.																														
<table border="1"> <thead> <tr> <th>No.</th> <th>Frequency (MHz)</th> <th>Reading (dBuV)</th> <th>Factor (dB/m)</th> <th>Level (dBuV/m)</th> <th>Limit (dBuV/m)</th> <th>Margin (dB)</th> <th>Detector</th> </tr> </thead> <tbody> <tr> <td>1</td> <td>11159.821</td> <td>37.67</td> <td>14.98</td> <td>52.65</td> <td>74.00</td> <td>-21.35</td> <td>peak</td> </tr> <tr> <td>2 *</td> <td>11160.156</td> <td>26.68</td> <td>14.98</td> <td>41.66</td> <td>54.00</td> <td>-12.34</td> <td>AVG</td> </tr> </tbody> </table>								No.	Frequency (MHz)	Reading (dBuV)	Factor (dB/m)	Level (dBuV/m)	Limit (dBuV/m)	Margin (dB)	Detector	1	11159.821	37.67	14.98	52.65	74.00	-21.35	peak	2 *	11160.156	26.68	14.98	41.66	54.00	-12.34	AVG
No.	Frequency (MHz)	Reading (dBuV)	Factor (dB/m)	Level (dBuV/m)	Limit (dBuV/m)	Margin (dB)	Detector																								
1	11159.821	37.67	14.98	52.65	74.00	-21.35	peak																								
2 *	11160.156	26.68	14.98	41.66	54.00	-12.34	AVG																								
Remarks: 1.Factor (dB/m) = Antenna Factor (dB/m)+Cable Factor (dB)-Pre-amplifier Factor 2.Margin value = Level -Limit value																															

Ant. No.	Ant 1 + Ant 2																														
Ant. Pol.	Vertical																														
Test Mode:	TX 802.11ac(VHT20) Mode 5580MHz (U-NII-2C)																														
Remark:	No report for the emission which more than 20 dB below the prescribed limit.																														
<table border="1"> <thead> <tr> <th>No.</th> <th>Frequency (MHz)</th> <th>Reading (dBuV)</th> <th>Factor (dB/m)</th> <th>Level (dBuV/m)</th> <th>Limit (dBuV/m)</th> <th>Margin (dB)</th> <th>Detector</th> </tr> </thead> <tbody> <tr> <td>1</td> <td>11159.822</td> <td>38.40</td> <td>14.98</td> <td>53.38</td> <td>74.00</td> <td>-20.62</td> <td>peak</td> </tr> <tr> <td>2 *</td> <td>11160.244</td> <td>26.23</td> <td>14.98</td> <td>41.21</td> <td>54.00</td> <td>-12.79</td> <td>AVG</td> </tr> </tbody> </table>								No.	Frequency (MHz)	Reading (dBuV)	Factor (dB/m)	Level (dBuV/m)	Limit (dBuV/m)	Margin (dB)	Detector	1	11159.822	38.40	14.98	53.38	74.00	-20.62	peak	2 *	11160.244	26.23	14.98	41.21	54.00	-12.79	AVG
No.	Frequency (MHz)	Reading (dBuV)	Factor (dB/m)	Level (dBuV/m)	Limit (dBuV/m)	Margin (dB)	Detector																								
1	11159.822	38.40	14.98	53.38	74.00	-20.62	peak																								
2 *	11160.244	26.23	14.98	41.21	54.00	-12.79	AVG																								
Remarks: 1.Factor (dB/m) = Antenna Factor (dB/m)+Cable Factor (dB)-Pre-amplifier Factor 2.Margin value = Level -Limit value																															



Ant. No.	Ant 1 + Ant 2																														
Ant. Pol.	Horizontal																														
Test Mode:	TX 802.11ac(VHT20) Mode 5700MHz (U-NII-2C)																														
Remark:	No report for the emission which more than 20 dB below the prescribed limit.																														
<table border="1"> <thead> <tr> <th>No.</th> <th>Frequency (MHz)</th> <th>Reading (dBuV)</th> <th>Factor (dB/m)</th> <th>Level (dBuV/m)</th> <th>Limit (dBuV/m)</th> <th>Margin (dB)</th> <th>Detector</th> </tr> </thead> <tbody> <tr> <td>1</td> <td>11419.862</td> <td>37.88</td> <td>14.99</td> <td>52.87</td> <td>74.00</td> <td>-21.13</td> <td>peak</td> </tr> <tr> <td>2 *</td> <td>11420.094</td> <td>26.94</td> <td>14.99</td> <td>41.93</td> <td>54.00</td> <td>-12.07</td> <td>AVG</td> </tr> </tbody> </table>								No.	Frequency (MHz)	Reading (dBuV)	Factor (dB/m)	Level (dBuV/m)	Limit (dBuV/m)	Margin (dB)	Detector	1	11419.862	37.88	14.99	52.87	74.00	-21.13	peak	2 *	11420.094	26.94	14.99	41.93	54.00	-12.07	AVG
No.	Frequency (MHz)	Reading (dBuV)	Factor (dB/m)	Level (dBuV/m)	Limit (dBuV/m)	Margin (dB)	Detector																								
1	11419.862	37.88	14.99	52.87	74.00	-21.13	peak																								
2 *	11420.094	26.94	14.99	41.93	54.00	-12.07	AVG																								
Remarks: 1.Factor (dB/m) = Antenna Factor (dB/m)+Cable Factor (dB)-Pre-amplifier Factor 2.Margin value = Level -Limit value																															

Ant. No.	Ant 1 + Ant 2																														
Ant. Pol.	Vertical																														
Test Mode:	TX 802.11ac(VHT20) Mode 5700MHz (U-NII-2C)																														
Remark:	No report for the emission which more than 20 dB below the prescribed limit.																														
<table border="1"> <thead> <tr> <th>No.</th> <th>Frequency (MHz)</th> <th>Reading (dBuV)</th> <th>Factor (dB/m)</th> <th>Level (dBuV/m)</th> <th>Limit (dBuV/m)</th> <th>Margin (dB)</th> <th>Detector</th> </tr> </thead> <tbody> <tr> <td>1 *</td> <td>11399.951</td> <td>25.33</td> <td>14.99</td> <td>40.32</td> <td>54.00</td> <td>-13.68</td> <td>AVG</td> </tr> <tr> <td>2</td> <td>11400.060</td> <td>38.59</td> <td>14.99</td> <td>53.58</td> <td>74.00</td> <td>-20.42</td> <td>peak</td> </tr> </tbody> </table>								No.	Frequency (MHz)	Reading (dBuV)	Factor (dB/m)	Level (dBuV/m)	Limit (dBuV/m)	Margin (dB)	Detector	1 *	11399.951	25.33	14.99	40.32	54.00	-13.68	AVG	2	11400.060	38.59	14.99	53.58	74.00	-20.42	peak
No.	Frequency (MHz)	Reading (dBuV)	Factor (dB/m)	Level (dBuV/m)	Limit (dBuV/m)	Margin (dB)	Detector																								
1 *	11399.951	25.33	14.99	40.32	54.00	-13.68	AVG																								
2	11400.060	38.59	14.99	53.58	74.00	-20.42	peak																								
Remarks: 1.Factor (dB/m) = Antenna Factor (dB/m)+Cable Factor (dB)-Pre-amplifier Factor 2.Margin value = Level -Limit value																															



Ant. No.	Ant 1 + Ant 2																														
Ant. Pol.	Horizontal																														
Test Mode:	TX 802.11n(HT40) Mode 5510MHz (U-NII-2C)																														
Remark:	No report for the emission which more than 20 dB below the prescribed limit.																														
<table border="1"> <thead> <tr> <th>No.</th> <th>Frequency (MHz)</th> <th>Reading (dBuV)</th> <th>Factor (dB/m)</th> <th>Level (dBuV/m)</th> <th>Limit (dBuV/m)</th> <th>Margin (dB)</th> <th>Detector</th> </tr> </thead> <tbody> <tr> <td>1</td> <td>11019.965</td> <td>38.04</td> <td>14.97</td> <td>53.01</td> <td>74.00</td> <td>-20.99</td> <td>peak</td> </tr> <tr> <td>2 *</td> <td>11020.238</td> <td>26.99</td> <td>14.97</td> <td>41.96</td> <td>54.00</td> <td>-12.04</td> <td>AVG</td> </tr> </tbody> </table>								No.	Frequency (MHz)	Reading (dBuV)	Factor (dB/m)	Level (dBuV/m)	Limit (dBuV/m)	Margin (dB)	Detector	1	11019.965	38.04	14.97	53.01	74.00	-20.99	peak	2 *	11020.238	26.99	14.97	41.96	54.00	-12.04	AVG
No.	Frequency (MHz)	Reading (dBuV)	Factor (dB/m)	Level (dBuV/m)	Limit (dBuV/m)	Margin (dB)	Detector																								
1	11019.965	38.04	14.97	53.01	74.00	-20.99	peak																								
2 *	11020.238	26.99	14.97	41.96	54.00	-12.04	AVG																								
Remarks: 1.Factor (dB/m) = Antenna Factor (dB/m)+Cable Factor (dB)-Pre-amplifier Factor 2.Margin value = Level -Limit value																															

Ant. No.	Ant 1 + Ant 2																														
Ant. Pol.	Vertical																														
Test Mode:	TX 802.11n(HT40) Mode 5510MHz (U-NII-2C)																														
Remark:	No report for the emission which more than 20 dB below the prescribed limit.																														
<table border="1"> <thead> <tr> <th>No.</th> <th>Frequency (MHz)</th> <th>Reading (dBuV)</th> <th>Factor (dB/m)</th> <th>Level (dBuV/m)</th> <th>Limit (dBuV/m)</th> <th>Margin (dB)</th> <th>Detector</th> </tr> </thead> <tbody> <tr> <td>1</td> <td>11020.075</td> <td>38.80</td> <td>14.97</td> <td>53.77</td> <td>74.00</td> <td>-20.23</td> <td>peak</td> </tr> <tr> <td>2 *</td> <td>11021.250</td> <td>26.13</td> <td>14.97</td> <td>41.10</td> <td>54.00</td> <td>-12.90</td> <td>AVG</td> </tr> </tbody> </table>								No.	Frequency (MHz)	Reading (dBuV)	Factor (dB/m)	Level (dBuV/m)	Limit (dBuV/m)	Margin (dB)	Detector	1	11020.075	38.80	14.97	53.77	74.00	-20.23	peak	2 *	11021.250	26.13	14.97	41.10	54.00	-12.90	AVG
No.	Frequency (MHz)	Reading (dBuV)	Factor (dB/m)	Level (dBuV/m)	Limit (dBuV/m)	Margin (dB)	Detector																								
1	11020.075	38.80	14.97	53.77	74.00	-20.23	peak																								
2 *	11021.250	26.13	14.97	41.10	54.00	-12.90	AVG																								
Remarks: 1.Factor (dB/m) = Antenna Factor (dB/m)+Cable Factor (dB)-Pre-amplifier Factor 2.Margin value = Level -Limit value																															



Ant. No.	Ant 1 + Ant 2																														
Ant. Pol.	Horizontal																														
Test Mode:	TX 802.11n(HT40) Mode 5550MHz (U-NII-2C)																														
Remark:	No report for the emission which more than 20 dB below the prescribed limit.																														
<table border="1"> <thead> <tr> <th>No.</th> <th>Frequency (MHz)</th> <th>Reading (dBuV)</th> <th>Factor (dB/m)</th> <th>Level (dBuV/m)</th> <th>Limit (dBuV/m)</th> <th>Margin (dB)</th> <th>Detector</th> </tr> </thead> <tbody> <tr> <td>1 *</td> <td>11099.926</td> <td>27.42</td> <td>14.98</td> <td>42.40</td> <td>54.00</td> <td>-11.60</td> <td>AVG</td> </tr> <tr> <td>2</td> <td>11100.145</td> <td>37.90</td> <td>14.98</td> <td>52.88</td> <td>74.00</td> <td>-21.12</td> <td>peak</td> </tr> </tbody> </table>								No.	Frequency (MHz)	Reading (dBuV)	Factor (dB/m)	Level (dBuV/m)	Limit (dBuV/m)	Margin (dB)	Detector	1 *	11099.926	27.42	14.98	42.40	54.00	-11.60	AVG	2	11100.145	37.90	14.98	52.88	74.00	-21.12	peak
No.	Frequency (MHz)	Reading (dBuV)	Factor (dB/m)	Level (dBuV/m)	Limit (dBuV/m)	Margin (dB)	Detector																								
1 *	11099.926	27.42	14.98	42.40	54.00	-11.60	AVG																								
2	11100.145	37.90	14.98	52.88	74.00	-21.12	peak																								
Remarks: 1.Factor (dB/m) = Antenna Factor (dB/m)+Cable Factor (dB)-Pre-amplifier Factor 2.Margin value = Level -Limit value																															

Ant. No.	Ant 1 + Ant 2																														
Ant. Pol.	Vertical																														
Test Mode:	TX 802.11n(HT40) Mode 5550MHz (U-NII-2C)																														
Remark:	No report for the emission which more than 20 dB below the prescribed limit.																														
<table border="1"> <thead> <tr> <th>No.</th> <th>Frequency (MHz)</th> <th>Reading (dBuV)</th> <th>Factor (dB/m)</th> <th>Level (dBuV/m)</th> <th>Limit (dBuV/m)</th> <th>Margin (dB)</th> <th>Detector</th> </tr> </thead> <tbody> <tr> <td>1</td> <td>11100.082</td> <td>38.12</td> <td>14.98</td> <td>53.10</td> <td>74.00</td> <td>-20.90</td> <td>peak</td> </tr> <tr> <td>2 *</td> <td>11100.093</td> <td>26.00</td> <td>14.98</td> <td>40.98</td> <td>54.00</td> <td>-13.02</td> <td>AVG</td> </tr> </tbody> </table>								No.	Frequency (MHz)	Reading (dBuV)	Factor (dB/m)	Level (dBuV/m)	Limit (dBuV/m)	Margin (dB)	Detector	1	11100.082	38.12	14.98	53.10	74.00	-20.90	peak	2 *	11100.093	26.00	14.98	40.98	54.00	-13.02	AVG
No.	Frequency (MHz)	Reading (dBuV)	Factor (dB/m)	Level (dBuV/m)	Limit (dBuV/m)	Margin (dB)	Detector																								
1	11100.082	38.12	14.98	53.10	74.00	-20.90	peak																								
2 *	11100.093	26.00	14.98	40.98	54.00	-13.02	AVG																								
Remarks: 1.Factor (dB/m) = Antenna Factor (dB/m)+Cable Factor (dB)-Pre-amplifier Factor 2.Margin value = Level -Limit value																															



Ant. No.	Ant 1 + Ant 2																														
Ant. Pol.	Horizontal																														
Test Mode:	TX 802.11n(HT40) Mode 5670MHz (U-NII-2C)																														
Remark:	No report for the emission which more than 20 dB below the prescribed limit.																														
<table border="1"> <thead> <tr> <th>No.</th> <th>Frequency (MHz)</th> <th>Reading (dBuV)</th> <th>Factor (dB/m)</th> <th>Level (dBuV/m)</th> <th>Limit (dBuV/m)</th> <th>Margin (dB)</th> <th>Detector</th> </tr> </thead> <tbody> <tr> <td>1</td> <td>11340.151</td> <td>37.88</td> <td>14.99</td> <td>52.87</td> <td>74.00</td> <td>-21.13</td> <td>peak</td> </tr> <tr> <td>2 *</td> <td>11340.210</td> <td>27.15</td> <td>14.99</td> <td>42.14</td> <td>54.00</td> <td>-11.86</td> <td>AVG</td> </tr> </tbody> </table>								No.	Frequency (MHz)	Reading (dBuV)	Factor (dB/m)	Level (dBuV/m)	Limit (dBuV/m)	Margin (dB)	Detector	1	11340.151	37.88	14.99	52.87	74.00	-21.13	peak	2 *	11340.210	27.15	14.99	42.14	54.00	-11.86	AVG
No.	Frequency (MHz)	Reading (dBuV)	Factor (dB/m)	Level (dBuV/m)	Limit (dBuV/m)	Margin (dB)	Detector																								
1	11340.151	37.88	14.99	52.87	74.00	-21.13	peak																								
2 *	11340.210	27.15	14.99	42.14	54.00	-11.86	AVG																								
Remarks: 1.Factor (dB/m) = Antenna Factor (dB/m)+Cable Factor (dB)-Pre-amplifier Factor 2.Margin value = Level -Limit value																															

Ant. No.	Ant 1 + Ant 2																														
Ant. Pol.	Vertical																														
Test Mode:	TX 802.11n(HT40) Mode 5670MHz (U-NII-2C)																														
Remark:	No report for the emission which more than 20 dB below the prescribed limit.																														
<table border="1"> <thead> <tr> <th>No.</th> <th>Frequency (MHz)</th> <th>Reading (dBuV)</th> <th>Factor (dB/m)</th> <th>Level (dBuV/m)</th> <th>Limit (dBuV/m)</th> <th>Margin (dB)</th> <th>Detector</th> </tr> </thead> <tbody> <tr> <td>1 *</td> <td>11339.855</td> <td>26.18</td> <td>14.99</td> <td>41.17</td> <td>54.00</td> <td>-12.83</td> <td>AVG</td> </tr> <tr> <td>2</td> <td>11340.152</td> <td>38.10</td> <td>14.99</td> <td>53.09</td> <td>74.00</td> <td>-20.91</td> <td>peak</td> </tr> </tbody> </table>								No.	Frequency (MHz)	Reading (dBuV)	Factor (dB/m)	Level (dBuV/m)	Limit (dBuV/m)	Margin (dB)	Detector	1 *	11339.855	26.18	14.99	41.17	54.00	-12.83	AVG	2	11340.152	38.10	14.99	53.09	74.00	-20.91	peak
No.	Frequency (MHz)	Reading (dBuV)	Factor (dB/m)	Level (dBuV/m)	Limit (dBuV/m)	Margin (dB)	Detector																								
1 *	11339.855	26.18	14.99	41.17	54.00	-12.83	AVG																								
2	11340.152	38.10	14.99	53.09	74.00	-20.91	peak																								
Remarks: 1.Factor (dB/m) = Antenna Factor (dB/m)+Cable Factor (dB)-Pre-amplifier Factor 2.Margin value = Level -Limit value																															



Ant. No.	Ant 1 + Ant 2																														
Ant. Pol.	Horizontal																														
Test Mode:	TX 802.11ac(VHT40) Mode 5510MHz (U-NII-2C)																														
Remark:	No report for the emission which more than 20 dB below the prescribed limit.																														
<table border="1"> <thead> <tr> <th>No.</th> <th>Frequency (MHz)</th> <th>Reading (dBuV)</th> <th>Factor (dB/m)</th> <th>Level (dBuV/m)</th> <th>Limit (dBuV/m)</th> <th>Margin (dB)</th> <th>Detector</th> </tr> </thead> <tbody> <tr> <td>1</td> <td>11019.936</td> <td>38.60</td> <td>14.97</td> <td>53.57</td> <td>74.00</td> <td>-20.43</td> <td>peak</td> </tr> <tr> <td>2 *</td> <td>11020.144</td> <td>27.30</td> <td>14.97</td> <td>42.27</td> <td>54.00</td> <td>-11.73</td> <td>AVG</td> </tr> </tbody> </table>								No.	Frequency (MHz)	Reading (dBuV)	Factor (dB/m)	Level (dBuV/m)	Limit (dBuV/m)	Margin (dB)	Detector	1	11019.936	38.60	14.97	53.57	74.00	-20.43	peak	2 *	11020.144	27.30	14.97	42.27	54.00	-11.73	AVG
No.	Frequency (MHz)	Reading (dBuV)	Factor (dB/m)	Level (dBuV/m)	Limit (dBuV/m)	Margin (dB)	Detector																								
1	11019.936	38.60	14.97	53.57	74.00	-20.43	peak																								
2 *	11020.144	27.30	14.97	42.27	54.00	-11.73	AVG																								
Remarks: 1.Factor (dB/m) = Antenna Factor (dB/m)+Cable Factor (dB)-Pre-amplifier Factor 2.Margin value = Level -Limit value																															

Ant. No.	Ant 1 + Ant 2																														
Ant. Pol.	Vertical																														
Test Mode:	TX 802.11ac(VHT40) Mode 5510MHz (U-NII-2C)																														
Remark:	No report for the emission which more than 20 dB below the prescribed limit.																														
<table border="1"> <thead> <tr> <th>No.</th> <th>Frequency (MHz)</th> <th>Reading (dBuV)</th> <th>Factor (dB/m)</th> <th>Level (dBuV/m)</th> <th>Limit (dBuV/m)</th> <th>Margin (dB)</th> <th>Detector</th> </tr> </thead> <tbody> <tr> <td>1</td> <td>11020.150</td> <td>38.33</td> <td>14.97</td> <td>53.30</td> <td>74.00</td> <td>-20.70</td> <td>peak</td> </tr> <tr> <td>2 *</td> <td>11020.618</td> <td>26.30</td> <td>14.97</td> <td>41.27</td> <td>54.00</td> <td>-12.73</td> <td>AVG</td> </tr> </tbody> </table>								No.	Frequency (MHz)	Reading (dBuV)	Factor (dB/m)	Level (dBuV/m)	Limit (dBuV/m)	Margin (dB)	Detector	1	11020.150	38.33	14.97	53.30	74.00	-20.70	peak	2 *	11020.618	26.30	14.97	41.27	54.00	-12.73	AVG
No.	Frequency (MHz)	Reading (dBuV)	Factor (dB/m)	Level (dBuV/m)	Limit (dBuV/m)	Margin (dB)	Detector																								
1	11020.150	38.33	14.97	53.30	74.00	-20.70	peak																								
2 *	11020.618	26.30	14.97	41.27	54.00	-12.73	AVG																								
Remarks: 1.Factor (dB/m) = Antenna Factor (dB/m)+Cable Factor (dB)-Pre-amplifier Factor 2.Margin value = Level -Limit value																															



Ant. No.	Ant 1 + Ant 2																														
Ant. Pol.	Horizontal																														
Test Mode:	TX 802.11ac(VHT40) Mode 5550MHz (U-NII-2C)																														
Remark:	No report for the emission which more than 20 dB below the prescribed limit.																														
<table border="1"> <thead> <tr> <th>No.</th> <th>Frequency (MHz)</th> <th>Reading (dBUV)</th> <th>Factor (dB/m)</th> <th>Level (dBUV/m)</th> <th>Limit (dBUV/m)</th> <th>Margin (dB)</th> <th>Detector</th> </tr> </thead> <tbody> <tr> <td>1 *</td> <td>11099.951</td> <td>26.82</td> <td>14.98</td> <td>41.80</td> <td>54.00</td> <td>-12.20</td> <td>AVG</td> </tr> <tr> <td>2</td> <td>11100.011</td> <td>38.01</td> <td>14.98</td> <td>52.99</td> <td>74.00</td> <td>-21.01</td> <td>peak</td> </tr> </tbody> </table>								No.	Frequency (MHz)	Reading (dBUV)	Factor (dB/m)	Level (dBUV/m)	Limit (dBUV/m)	Margin (dB)	Detector	1 *	11099.951	26.82	14.98	41.80	54.00	-12.20	AVG	2	11100.011	38.01	14.98	52.99	74.00	-21.01	peak
No.	Frequency (MHz)	Reading (dBUV)	Factor (dB/m)	Level (dBUV/m)	Limit (dBUV/m)	Margin (dB)	Detector																								
1 *	11099.951	26.82	14.98	41.80	54.00	-12.20	AVG																								
2	11100.011	38.01	14.98	52.99	74.00	-21.01	peak																								
Remarks: 1.Factor (dB/m) = Antenna Factor (dB/m)+Cable Factor (dB)-Pre-amplifier Factor 2.Margin value = Level -Limit value																															

Ant. No.	Ant 1 + Ant 2																														
Ant. Pol.	Vertical																														
Test Mode:	TX 802.11ac(VHT40) Mode 5550MHz (U-NII-2C)																														
Remark:	No report for the emission which more than 20 dB below the prescribed limit.																														
<table border="1"> <thead> <tr> <th>No.</th> <th>Frequency (MHz)</th> <th>Reading (dBUV)</th> <th>Factor (dB/m)</th> <th>Level (dBUV/m)</th> <th>Limit (dBUV/m)</th> <th>Margin (dB)</th> <th>Detector</th> </tr> </thead> <tbody> <tr> <td>1 *</td> <td>11099.940</td> <td>25.80</td> <td>14.98</td> <td>40.78</td> <td>54.00</td> <td>-13.22</td> <td>AVG</td> </tr> <tr> <td>2</td> <td>11099.952</td> <td>38.22</td> <td>14.98</td> <td>53.20</td> <td>74.00</td> <td>-20.80</td> <td>peak</td> </tr> </tbody> </table>								No.	Frequency (MHz)	Reading (dBUV)	Factor (dB/m)	Level (dBUV/m)	Limit (dBUV/m)	Margin (dB)	Detector	1 *	11099.940	25.80	14.98	40.78	54.00	-13.22	AVG	2	11099.952	38.22	14.98	53.20	74.00	-20.80	peak
No.	Frequency (MHz)	Reading (dBUV)	Factor (dB/m)	Level (dBUV/m)	Limit (dBUV/m)	Margin (dB)	Detector																								
1 *	11099.940	25.80	14.98	40.78	54.00	-13.22	AVG																								
2	11099.952	38.22	14.98	53.20	74.00	-20.80	peak																								
Remarks: 1.Factor (dB/m) = Antenna Factor (dB/m)+Cable Factor (dB)-Pre-amplifier Factor 2.Margin value = Level -Limit value																															



Ant. No.	Ant 1 + Ant 2																														
Ant. Pol.	Horizontal																														
Test Mode:	TX 802.11ac(VHT40) Mode 5670MHz (U-NII-2C)																														
Remark:	No report for the emission which more than 20 dB below the prescribed limit.																														
<table border="1"> <thead> <tr> <th>No.</th> <th>Frequency (MHz)</th> <th>Reading (dBuV)</th> <th>Factor (dB/m)</th> <th>Level (dBuV/m)</th> <th>Limit (dBuV/m)</th> <th>Margin (dB)</th> <th>Detector</th> </tr> </thead> <tbody> <tr> <td>1</td> <td>11339.856</td> <td>37.55</td> <td>14.99</td> <td>52.54</td> <td>74.00</td> <td>-21.46</td> <td>peak</td> </tr> <tr> <td>2 *</td> <td>11340.240</td> <td>26.98</td> <td>14.99</td> <td>41.97</td> <td>54.00</td> <td>-12.03</td> <td>AVG</td> </tr> </tbody> </table>								No.	Frequency (MHz)	Reading (dBuV)	Factor (dB/m)	Level (dBuV/m)	Limit (dBuV/m)	Margin (dB)	Detector	1	11339.856	37.55	14.99	52.54	74.00	-21.46	peak	2 *	11340.240	26.98	14.99	41.97	54.00	-12.03	AVG
No.	Frequency (MHz)	Reading (dBuV)	Factor (dB/m)	Level (dBuV/m)	Limit (dBuV/m)	Margin (dB)	Detector																								
1	11339.856	37.55	14.99	52.54	74.00	-21.46	peak																								
2 *	11340.240	26.98	14.99	41.97	54.00	-12.03	AVG																								
Remarks: 1.Factor (dB/m) = Antenna Factor (dB/m)+Cable Factor (dB)-Pre-amplifier Factor 2.Margin value = Level -Limit value																															

Ant. No.	Ant 1 + Ant 2																														
Ant. Pol.	Vertical																														
Test Mode:	TX 802.11ac(VHT40) Mode 5670MHz (U-NII-2C)																														
Remark:	No report for the emission which more than 20 dB below the prescribed limit.																														
<table border="1"> <thead> <tr> <th>No.</th> <th>Frequency (MHz)</th> <th>Reading (dBuV)</th> <th>Factor (dB/m)</th> <th>Level (dBuV/m)</th> <th>Limit (dBuV/m)</th> <th>Margin (dB)</th> <th>Detector</th> </tr> </thead> <tbody> <tr> <td>1 *</td> <td>11339.943</td> <td>25.93</td> <td>14.99</td> <td>40.92</td> <td>54.00</td> <td>-13.08</td> <td>AVG</td> </tr> <tr> <td>2</td> <td>11340.147</td> <td>37.66</td> <td>14.99</td> <td>52.65</td> <td>74.00</td> <td>-21.35</td> <td>peak</td> </tr> </tbody> </table>								No.	Frequency (MHz)	Reading (dBuV)	Factor (dB/m)	Level (dBuV/m)	Limit (dBuV/m)	Margin (dB)	Detector	1 *	11339.943	25.93	14.99	40.92	54.00	-13.08	AVG	2	11340.147	37.66	14.99	52.65	74.00	-21.35	peak
No.	Frequency (MHz)	Reading (dBuV)	Factor (dB/m)	Level (dBuV/m)	Limit (dBuV/m)	Margin (dB)	Detector																								
1 *	11339.943	25.93	14.99	40.92	54.00	-13.08	AVG																								
2	11340.147	37.66	14.99	52.65	74.00	-21.35	peak																								
Remarks: 1.Factor (dB/m) = Antenna Factor (dB/m)+Cable Factor (dB)-Pre-amplifier Factor 2.Margin value = Level -Limit value																															



Ant. No.	Ant 1 + Ant 2																														
Ant. Pol.	Horizontal																														
Test Mode:	TX 802.11ac(VHT80) Mode 5530MHz (U-NII-2C)																														
Remark:	No report for the emission which more than 20 dB below the prescribed limit.																														
<table border="1"> <thead> <tr> <th>No.</th> <th>Frequency (MHz)</th> <th>Reading (dBuV)</th> <th>Factor (dB/m)</th> <th>Level (dBuV/m)</th> <th>Limit (dBuV/m)</th> <th>Margin (dB)</th> <th>Detector</th> </tr> </thead> <tbody> <tr> <td>1</td> <td>11060.256</td> <td>38.44</td> <td>14.98</td> <td>53.42</td> <td>74.00</td> <td>-20.58</td> <td>peak</td> </tr> <tr> <td>2 *</td> <td>11060.421</td> <td>27.22</td> <td>14.98</td> <td>42.20</td> <td>54.00</td> <td>-11.80</td> <td>AVG</td> </tr> </tbody> </table>								No.	Frequency (MHz)	Reading (dBuV)	Factor (dB/m)	Level (dBuV/m)	Limit (dBuV/m)	Margin (dB)	Detector	1	11060.256	38.44	14.98	53.42	74.00	-20.58	peak	2 *	11060.421	27.22	14.98	42.20	54.00	-11.80	AVG
No.	Frequency (MHz)	Reading (dBuV)	Factor (dB/m)	Level (dBuV/m)	Limit (dBuV/m)	Margin (dB)	Detector																								
1	11060.256	38.44	14.98	53.42	74.00	-20.58	peak																								
2 *	11060.421	27.22	14.98	42.20	54.00	-11.80	AVG																								
Remarks: 1.Factor (dB/m) = Antenna Factor (dB/m)+Cable Factor (dB)-Pre-amplifier Factor 2.Margin value = Level -Limit value																															

Ant. No.	Ant 1 + Ant 2																														
Ant. Pol.	Vertical																														
Test Mode:	TX 802.11ac(VHT80) Mode 5530MHz (U-NII-2C)																														
Remark:	No report for the emission which more than 20 dB below the prescribed limit.																														
<table border="1"> <thead> <tr> <th>No.</th> <th>Frequency (MHz)</th> <th>Reading (dBuV)</th> <th>Factor (dB/m)</th> <th>Level (dBuV/m)</th> <th>Limit (dBuV/m)</th> <th>Margin (dB)</th> <th>Detector</th> </tr> </thead> <tbody> <tr> <td>1 *</td> <td>11059.889</td> <td>25.68</td> <td>14.98</td> <td>40.66</td> <td>54.00</td> <td>-13.34</td> <td>AVG</td> </tr> <tr> <td>2</td> <td>11060.123</td> <td>38.55</td> <td>14.98</td> <td>53.53</td> <td>74.00</td> <td>-20.47</td> <td>peak</td> </tr> </tbody> </table>								No.	Frequency (MHz)	Reading (dBuV)	Factor (dB/m)	Level (dBuV/m)	Limit (dBuV/m)	Margin (dB)	Detector	1 *	11059.889	25.68	14.98	40.66	54.00	-13.34	AVG	2	11060.123	38.55	14.98	53.53	74.00	-20.47	peak
No.	Frequency (MHz)	Reading (dBuV)	Factor (dB/m)	Level (dBuV/m)	Limit (dBuV/m)	Margin (dB)	Detector																								
1 *	11059.889	25.68	14.98	40.66	54.00	-13.34	AVG																								
2	11060.123	38.55	14.98	53.53	74.00	-20.47	peak																								
Remarks: 1.Factor (dB/m) = Antenna Factor (dB/m)+Cable Factor (dB)-Pre-amplifier Factor 2.Margin value = Level -Limit value																															



Ant. No.	Ant 1 + Ant 2																														
Ant. Pol.	Horizontal																														
Test Mode:	TX 802.11ac(VHT80) Mode 5610MHz (U-NII-2C)																														
Remark:	No report for the emission which more than 20 dB below the prescribed limit.																														
<table border="1"> <thead> <tr> <th>No.</th> <th>Frequency (MHz)</th> <th>Reading (dBuV)</th> <th>Factor (dB/m)</th> <th>Level (dBuV/m)</th> <th>Limit (dBuV/m)</th> <th>Margin (dB)</th> <th>Detector</th> </tr> </thead> <tbody> <tr> <td>1</td> <td>11220.907</td> <td>38.59</td> <td>14.98</td> <td>53.57</td> <td>74.00</td> <td>-20.43</td> <td>peak</td> </tr> <tr> <td>2 *</td> <td>11221.568</td> <td>27.77</td> <td>14.98</td> <td>42.75</td> <td>54.00</td> <td>-11.25</td> <td>AVG</td> </tr> </tbody> </table>								No.	Frequency (MHz)	Reading (dBuV)	Factor (dB/m)	Level (dBuV/m)	Limit (dBuV/m)	Margin (dB)	Detector	1	11220.907	38.59	14.98	53.57	74.00	-20.43	peak	2 *	11221.568	27.77	14.98	42.75	54.00	-11.25	AVG
No.	Frequency (MHz)	Reading (dBuV)	Factor (dB/m)	Level (dBuV/m)	Limit (dBuV/m)	Margin (dB)	Detector																								
1	11220.907	38.59	14.98	53.57	74.00	-20.43	peak																								
2 *	11221.568	27.77	14.98	42.75	54.00	-11.25	AVG																								
Remarks: 1.Factor (dB/m) = Antenna Factor (dB/m)+Cable Factor (dB)-Pre-amplifier Factor 2.Margin value = Level -Limit value																															

Ant. No.	Ant 1 + Ant 2																														
Ant. Pol.	Vertical																														
Test Mode:	TX 802.11ac(VHT80) Mode 5610MHz (U-NII-2C)																														
Remark:	No report for the emission which more than 20 dB below the prescribed limit.																														
<table border="1"> <thead> <tr> <th>No.</th> <th>Frequency (MHz)</th> <th>Reading (dBuV)</th> <th>Factor (dB/m)</th> <th>Level (dBuV/m)</th> <th>Limit (dBuV/m)</th> <th>Margin (dB)</th> <th>Detector</th> </tr> </thead> <tbody> <tr> <td>1 *</td> <td>11220.748</td> <td>27.72</td> <td>14.98</td> <td>42.70</td> <td>54.00</td> <td>-11.30</td> <td>AVG</td> </tr> <tr> <td>2</td> <td>11221.032</td> <td>38.99</td> <td>14.98</td> <td>53.97</td> <td>74.00</td> <td>-20.03</td> <td>peak</td> </tr> </tbody> </table>								No.	Frequency (MHz)	Reading (dBuV)	Factor (dB/m)	Level (dBuV/m)	Limit (dBuV/m)	Margin (dB)	Detector	1 *	11220.748	27.72	14.98	42.70	54.00	-11.30	AVG	2	11221.032	38.99	14.98	53.97	74.00	-20.03	peak
No.	Frequency (MHz)	Reading (dBuV)	Factor (dB/m)	Level (dBuV/m)	Limit (dBuV/m)	Margin (dB)	Detector																								
1 *	11220.748	27.72	14.98	42.70	54.00	-11.30	AVG																								
2	11221.032	38.99	14.98	53.97	74.00	-20.03	peak																								
Remarks: 1.Factor (dB/m) = Antenna Factor (dB/m)+Cable Factor (dB)-Pre-amplifier Factor 2.Margin value = Level -Limit value																															



Ant. No.	Ant 2																														
Ant. Pol.	Horizontal																														
Test Mode:	TX 802.11a Mode 5745MHz (U-NII-3)																														
Remark:	No report for the emission which more than 20 dB below the prescribed limit.																														
<table border="1"> <thead> <tr> <th>No.</th> <th>Frequency (MHz)</th> <th>Reading (dBuV)</th> <th>Factor (dB/m)</th> <th>Level (dBuV/m)</th> <th>Limit (dBuV/m)</th> <th>Margin (dB)</th> <th>Detector</th> </tr> </thead> <tbody> <tr> <td>1</td> <td>11489.772</td> <td>37.84</td> <td>15.00</td> <td>52.84</td> <td>74.00</td> <td>-21.16</td> <td>peak</td> </tr> <tr> <td>2 *</td> <td>11489.949</td> <td>26.83</td> <td>15.00</td> <td>41.83</td> <td>54.00</td> <td>-12.17</td> <td>AVG</td> </tr> </tbody> </table>								No.	Frequency (MHz)	Reading (dBuV)	Factor (dB/m)	Level (dBuV/m)	Limit (dBuV/m)	Margin (dB)	Detector	1	11489.772	37.84	15.00	52.84	74.00	-21.16	peak	2 *	11489.949	26.83	15.00	41.83	54.00	-12.17	AVG
No.	Frequency (MHz)	Reading (dBuV)	Factor (dB/m)	Level (dBuV/m)	Limit (dBuV/m)	Margin (dB)	Detector																								
1	11489.772	37.84	15.00	52.84	74.00	-21.16	peak																								
2 *	11489.949	26.83	15.00	41.83	54.00	-12.17	AVG																								
Remarks: 1. Factor (dB/m) = Antenna Factor (dB/m)+Cable Factor (dB)-Pre-amplifier Factor 2. Margin value = Level -Limit value																															

Ant. No.	Ant 2																														
Ant. Pol.	Vertical																														
Test Mode:	TX 802.11a Mode 5745MHz (U-NII-3)																														
Remark:	No report for the emission which more than 20 dB below the prescribed limit.																														
<table border="1"> <thead> <tr> <th>No.</th> <th>Frequency (MHz)</th> <th>Reading (dBuV)</th> <th>Factor (dB/m)</th> <th>Level (dBuV/m)</th> <th>Limit (dBuV/m)</th> <th>Margin (dB)</th> <th>Detector</th> </tr> </thead> <tbody> <tr> <td>1</td> <td>11489.980</td> <td>38.16</td> <td>15.00</td> <td>53.16</td> <td>74.00</td> <td>-20.84</td> <td>peak</td> </tr> <tr> <td>2 *</td> <td>11490.005</td> <td>26.20</td> <td>15.01</td> <td>41.21</td> <td>54.00</td> <td>-12.79</td> <td>AVG</td> </tr> </tbody> </table>								No.	Frequency (MHz)	Reading (dBuV)	Factor (dB/m)	Level (dBuV/m)	Limit (dBuV/m)	Margin (dB)	Detector	1	11489.980	38.16	15.00	53.16	74.00	-20.84	peak	2 *	11490.005	26.20	15.01	41.21	54.00	-12.79	AVG
No.	Frequency (MHz)	Reading (dBuV)	Factor (dB/m)	Level (dBuV/m)	Limit (dBuV/m)	Margin (dB)	Detector																								
1	11489.980	38.16	15.00	53.16	74.00	-20.84	peak																								
2 *	11490.005	26.20	15.01	41.21	54.00	-12.79	AVG																								
Remarks: 1. Factor (dB/m) = Antenna Factor (dB/m)+Cable Factor (dB)-Pre-amplifier Factor 2. Margin value = Level -Limit value																															



Ant. No.	Ant 2																														
Ant. Pol.	Horizontal																														
Test Mode:	TX 802.11a Mode 5785MHz (U-NII-3)																														
Remark:	No report for the emission which more than 20 dB below the prescribed limit.																														
<table border="1"> <thead> <tr> <th>No.</th> <th>Frequency (MHz)</th> <th>Reading (dBuV)</th> <th>Factor (dB/m)</th> <th>Level (dBuV/m)</th> <th>Limit (dBuV/m)</th> <th>Margin (dB)</th> <th>Detector</th> </tr> </thead> <tbody> <tr> <td>1 *</td> <td>11569.937</td> <td>27.03</td> <td>15.06</td> <td>42.09</td> <td>54.00</td> <td>-11.91</td> <td>AVG</td> </tr> <tr> <td>2</td> <td>11570.075</td> <td>37.36</td> <td>15.07</td> <td>52.43</td> <td>74.00</td> <td>-21.57</td> <td>peak</td> </tr> </tbody> </table>								No.	Frequency (MHz)	Reading (dBuV)	Factor (dB/m)	Level (dBuV/m)	Limit (dBuV/m)	Margin (dB)	Detector	1 *	11569.937	27.03	15.06	42.09	54.00	-11.91	AVG	2	11570.075	37.36	15.07	52.43	74.00	-21.57	peak
No.	Frequency (MHz)	Reading (dBuV)	Factor (dB/m)	Level (dBuV/m)	Limit (dBuV/m)	Margin (dB)	Detector																								
1 *	11569.937	27.03	15.06	42.09	54.00	-11.91	AVG																								
2	11570.075	37.36	15.07	52.43	74.00	-21.57	peak																								
Remarks: 1.Factor (dB/m) = Antenna Factor (dB/m)+Cable Factor (dB)-Pre-amplifier Factor 2.Margin value = Level -Limit value																															

Ant. No.	Ant 2																														
Ant. Pol.	Vertical																														
Test Mode:	TX 802.11a Mode 5785MHz (U-NII-3)																														
Remark:	No report for the emission which more than 20 dB below the prescribed limit.																														
<table border="1"> <thead> <tr> <th>No.</th> <th>Frequency (MHz)</th> <th>Reading (dBuV)</th> <th>Factor (dB/m)</th> <th>Level (dBuV/m)</th> <th>Limit (dBuV/m)</th> <th>Margin (dB)</th> <th>Detector</th> </tr> </thead> <tbody> <tr> <td>1 *</td> <td>11570.031</td> <td>25.87</td> <td>15.07</td> <td>40.94</td> <td>54.00</td> <td>-13.06</td> <td>AVG</td> </tr> <tr> <td>2</td> <td>11570.207</td> <td>37.72</td> <td>15.07</td> <td>52.79</td> <td>74.00</td> <td>-21.21</td> <td>peak</td> </tr> </tbody> </table>								No.	Frequency (MHz)	Reading (dBuV)	Factor (dB/m)	Level (dBuV/m)	Limit (dBuV/m)	Margin (dB)	Detector	1 *	11570.031	25.87	15.07	40.94	54.00	-13.06	AVG	2	11570.207	37.72	15.07	52.79	74.00	-21.21	peak
No.	Frequency (MHz)	Reading (dBuV)	Factor (dB/m)	Level (dBuV/m)	Limit (dBuV/m)	Margin (dB)	Detector																								
1 *	11570.031	25.87	15.07	40.94	54.00	-13.06	AVG																								
2	11570.207	37.72	15.07	52.79	74.00	-21.21	peak																								
Remarks: 1.Factor (dB/m) = Antenna Factor (dB/m)+Cable Factor (dB)-Pre-amplifier Factor 2.Margin value = Level -Limit value																															



Ant. No.	Ant 2																														
Ant. Pol.	Horizontal																														
Test Mode:	TX 802.11a Mode 5825MHz (U-NII-3)																														
Remark:	No report for the emission which more than 20 dB below the prescribed limit.																														
<table border="1"> <thead> <tr> <th>No.</th> <th>Frequency (MHz)</th> <th>Reading (dBuV)</th> <th>Factor (dB/m)</th> <th>Level (dBuV/m)</th> <th>Limit (dBuV/m)</th> <th>Margin (dB)</th> <th>Detector</th> </tr> </thead> <tbody> <tr> <td>1 *</td> <td>11649.876</td> <td>27.44</td> <td>15.13</td> <td>42.57</td> <td>54.00</td> <td>-11.43</td> <td>AVG</td> </tr> <tr> <td>2</td> <td>11649.909</td> <td>38.10</td> <td>15.13</td> <td>53.23</td> <td>74.00</td> <td>-20.77</td> <td>peak</td> </tr> </tbody> </table>								No.	Frequency (MHz)	Reading (dBuV)	Factor (dB/m)	Level (dBuV/m)	Limit (dBuV/m)	Margin (dB)	Detector	1 *	11649.876	27.44	15.13	42.57	54.00	-11.43	AVG	2	11649.909	38.10	15.13	53.23	74.00	-20.77	peak
No.	Frequency (MHz)	Reading (dBuV)	Factor (dB/m)	Level (dBuV/m)	Limit (dBuV/m)	Margin (dB)	Detector																								
1 *	11649.876	27.44	15.13	42.57	54.00	-11.43	AVG																								
2	11649.909	38.10	15.13	53.23	74.00	-20.77	peak																								
Remarks: 1.Factor (dB/m) = Antenna Factor (dB/m)+Cable Factor (dB)-Pre-amplifier Factor 2.Margin value = Level -Limit value																															

Ant. No.	Ant 2																														
Ant. Pol.	Vertical																														
Test Mode:	TX 802.11a Mode 5825MHz (U-NII-3)																														
Remark:	No report for the emission which more than 20 dB below the prescribed limit.																														
<table border="1"> <thead> <tr> <th>No.</th> <th>Frequency (MHz)</th> <th>Reading (dBuV)</th> <th>Factor (dB/m)</th> <th>Level (dBuV/m)</th> <th>Limit (dBuV/m)</th> <th>Margin (dB)</th> <th>Detector</th> </tr> </thead> <tbody> <tr> <td>1</td> <td>11649.865</td> <td>38.57</td> <td>15.13</td> <td>53.70</td> <td>74.00</td> <td>-20.30</td> <td>peak</td> </tr> <tr> <td>2 *</td> <td>11650.242</td> <td>25.38</td> <td>15.14</td> <td>40.52</td> <td>54.00</td> <td>-13.48</td> <td>AVG</td> </tr> </tbody> </table>								No.	Frequency (MHz)	Reading (dBuV)	Factor (dB/m)	Level (dBuV/m)	Limit (dBuV/m)	Margin (dB)	Detector	1	11649.865	38.57	15.13	53.70	74.00	-20.30	peak	2 *	11650.242	25.38	15.14	40.52	54.00	-13.48	AVG
No.	Frequency (MHz)	Reading (dBuV)	Factor (dB/m)	Level (dBuV/m)	Limit (dBuV/m)	Margin (dB)	Detector																								
1	11649.865	38.57	15.13	53.70	74.00	-20.30	peak																								
2 *	11650.242	25.38	15.14	40.52	54.00	-13.48	AVG																								
Remarks: 1.Factor (dB/m) = Antenna Factor (dB/m)+Cable Factor (dB)-Pre-amplifier Factor 2.Margin value = Level -Limit value																															



Ant. No.	Ant 1 + Ant 2																														
Ant. Pol.	Horizontal																														
Test Mode:	TX 802.11n(HT20) Mode 5745MHz (U-NII-3)																														
Remark:	No report for the emission which more than 20 dB below the prescribed limit.																														
<table border="1"> <thead> <tr> <th>No.</th> <th>Frequency (MHz)</th> <th>Reading (dBuV)</th> <th>Factor (dB/m)</th> <th>Level (dBuV/m)</th> <th>Limit (dBuV/m)</th> <th>Margin (dB)</th> <th>Detector</th> </tr> </thead> <tbody> <tr> <td>1</td> <td>11490.231</td> <td>37.50</td> <td>15.01</td> <td>52.51</td> <td>74.00</td> <td>-21.49</td> <td>peak</td> </tr> <tr> <td>2 *</td> <td>11490.878</td> <td>27.46</td> <td>15.01</td> <td>42.47</td> <td>54.00</td> <td>-11.53</td> <td>AVG</td> </tr> </tbody> </table>								No.	Frequency (MHz)	Reading (dBuV)	Factor (dB/m)	Level (dBuV/m)	Limit (dBuV/m)	Margin (dB)	Detector	1	11490.231	37.50	15.01	52.51	74.00	-21.49	peak	2 *	11490.878	27.46	15.01	42.47	54.00	-11.53	AVG
No.	Frequency (MHz)	Reading (dBuV)	Factor (dB/m)	Level (dBuV/m)	Limit (dBuV/m)	Margin (dB)	Detector																								
1	11490.231	37.50	15.01	52.51	74.00	-21.49	peak																								
2 *	11490.878	27.46	15.01	42.47	54.00	-11.53	AVG																								
Remarks: 1.Factor (dB/m) = Antenna Factor (dB/m)+Cable Factor (dB)-Pre-amplifier Factor 2.Margin value = Level -Limit value																															

Ant. No.	Ant 1 + Ant 2																														
Ant. Pol.	Vertical																														
Test Mode:	TX 802.11n(HT20) Mode 5745MHz (U-NII-3)																														
Remark:	No report for the emission which more than 20 dB below the prescribed limit.																														
<table border="1"> <thead> <tr> <th>No.</th> <th>Frequency (MHz)</th> <th>Reading (dBuV)</th> <th>Factor (dB/m)</th> <th>Level (dBuV/m)</th> <th>Limit (dBuV/m)</th> <th>Margin (dB)</th> <th>Detector</th> </tr> </thead> <tbody> <tr> <td>1</td> <td>11489.832</td> <td>38.26</td> <td>15.00</td> <td>53.26</td> <td>74.00</td> <td>-20.74</td> <td>peak</td> </tr> <tr> <td>2 *</td> <td>11490.200</td> <td>25.46</td> <td>15.01</td> <td>40.47</td> <td>54.00</td> <td>-13.53</td> <td>AVG</td> </tr> </tbody> </table>								No.	Frequency (MHz)	Reading (dBuV)	Factor (dB/m)	Level (dBuV/m)	Limit (dBuV/m)	Margin (dB)	Detector	1	11489.832	38.26	15.00	53.26	74.00	-20.74	peak	2 *	11490.200	25.46	15.01	40.47	54.00	-13.53	AVG
No.	Frequency (MHz)	Reading (dBuV)	Factor (dB/m)	Level (dBuV/m)	Limit (dBuV/m)	Margin (dB)	Detector																								
1	11489.832	38.26	15.00	53.26	74.00	-20.74	peak																								
2 *	11490.200	25.46	15.01	40.47	54.00	-13.53	AVG																								
Remarks: 1.Factor (dB/m) = Antenna Factor (dB/m)+Cable Factor (dB)-Pre-amplifier Factor 2.Margin value = Level -Limit value																															



Ant. No.	Ant 1 + Ant 2																														
Ant. Pol.	Horizontal																														
Test Mode:	TX 802.11n(HT20) Mode 5785MHz (U-NII-3)																														
Remark:	No report for the emission which more than 20 dB below the prescribed limit.																														
<table border="1"> <thead> <tr> <th>No.</th> <th>Frequency (MHz)</th> <th>Reading (dBuV)</th> <th>Factor (dB/m)</th> <th>Level (dBuV/m)</th> <th>Limit (dBuV/m)</th> <th>Margin (dB)</th> <th>Detector</th> </tr> </thead> <tbody> <tr> <td>1 *</td> <td>11569.935</td> <td>27.23</td> <td>15.06</td> <td>42.29</td> <td>54.00</td> <td>-11.71</td> <td>AVG</td> </tr> <tr> <td>2</td> <td>11570.069</td> <td>38.30</td> <td>15.07</td> <td>53.37</td> <td>74.00</td> <td>-20.63</td> <td>peak</td> </tr> </tbody> </table>								No.	Frequency (MHz)	Reading (dBuV)	Factor (dB/m)	Level (dBuV/m)	Limit (dBuV/m)	Margin (dB)	Detector	1 *	11569.935	27.23	15.06	42.29	54.00	-11.71	AVG	2	11570.069	38.30	15.07	53.37	74.00	-20.63	peak
No.	Frequency (MHz)	Reading (dBuV)	Factor (dB/m)	Level (dBuV/m)	Limit (dBuV/m)	Margin (dB)	Detector																								
1 *	11569.935	27.23	15.06	42.29	54.00	-11.71	AVG																								
2	11570.069	38.30	15.07	53.37	74.00	-20.63	peak																								
Remarks: 1.Factor (dB/m) = Antenna Factor (dB/m)+Cable Factor (dB)-Pre-amplifier Factor 2.Margin value = Level -Limit value																															

Ant. No.	Ant 1 + Ant 2																														
Ant. Pol.	Vertical																														
Test Mode:	TX 802.11n(HT20) Mode 5785MHz (U-NII-3)																														
Remark:	No report for the emission which more than 20 dB below the prescribed limit.																														
<table border="1"> <thead> <tr> <th>No.</th> <th>Frequency (MHz)</th> <th>Reading (dBuV)</th> <th>Factor (dB/m)</th> <th>Level (dBuV/m)</th> <th>Limit (dBuV/m)</th> <th>Margin (dB)</th> <th>Detector</th> </tr> </thead> <tbody> <tr> <td>1 *</td> <td>11570.061</td> <td>25.23</td> <td>15.07</td> <td>40.30</td> <td>54.00</td> <td>-13.70</td> <td>AVG</td> </tr> <tr> <td>2</td> <td>11570.321</td> <td>37.91</td> <td>15.07</td> <td>52.98</td> <td>74.00</td> <td>-21.02</td> <td>peak</td> </tr> </tbody> </table>								No.	Frequency (MHz)	Reading (dBuV)	Factor (dB/m)	Level (dBuV/m)	Limit (dBuV/m)	Margin (dB)	Detector	1 *	11570.061	25.23	15.07	40.30	54.00	-13.70	AVG	2	11570.321	37.91	15.07	52.98	74.00	-21.02	peak
No.	Frequency (MHz)	Reading (dBuV)	Factor (dB/m)	Level (dBuV/m)	Limit (dBuV/m)	Margin (dB)	Detector																								
1 *	11570.061	25.23	15.07	40.30	54.00	-13.70	AVG																								
2	11570.321	37.91	15.07	52.98	74.00	-21.02	peak																								
Remarks: 1.Factor (dB/m) = Antenna Factor (dB/m)+Cable Factor (dB)-Pre-amplifier Factor 2.Margin value = Level -Limit value																															



Ant. No.	Ant 1 + Ant 2																														
Ant. Pol.	Horizontal																														
Test Mode:	TX 802.11n(HT20) Mode 5825MHz (U-NII-3)																														
Remark:	No report for the emission which more than 20 dB below the prescribed limit.																														
<table border="1"> <thead> <tr> <th>No.</th> <th>Frequency (MHz)</th> <th>Reading (dBuV)</th> <th>Factor (dB/m)</th> <th>Level (dBuV/m)</th> <th>Limit (dBuV/m)</th> <th>Margin (dB)</th> <th>Detector</th> </tr> </thead> <tbody> <tr> <td>1 *</td> <td>11650.038</td> <td>26.27</td> <td>15.13</td> <td>41.40</td> <td>54.00</td> <td>-12.60</td> <td>AVG</td> </tr> <tr> <td>2</td> <td>11650.104</td> <td>37.84</td> <td>15.14</td> <td>52.98</td> <td>74.00</td> <td>-21.02</td> <td>peak</td> </tr> </tbody> </table>								No.	Frequency (MHz)	Reading (dBuV)	Factor (dB/m)	Level (dBuV/m)	Limit (dBuV/m)	Margin (dB)	Detector	1 *	11650.038	26.27	15.13	41.40	54.00	-12.60	AVG	2	11650.104	37.84	15.14	52.98	74.00	-21.02	peak
No.	Frequency (MHz)	Reading (dBuV)	Factor (dB/m)	Level (dBuV/m)	Limit (dBuV/m)	Margin (dB)	Detector																								
1 *	11650.038	26.27	15.13	41.40	54.00	-12.60	AVG																								
2	11650.104	37.84	15.14	52.98	74.00	-21.02	peak																								
Remarks: 1.Factor (dB/m) = Antenna Factor (dB/m)+Cable Factor (dB)-Pre-amplifier Factor 2.Margin value = Level -Limit value																															

Ant. No.	Ant 1 + Ant 2																														
Ant. Pol.	Vertical																														
Test Mode:	TX 802.11n(HT20) Mode 5825MHz (U-NII-3)																														
Remark:	No report for the emission which more than 20 dB below the prescribed limit.																														
<table border="1"> <thead> <tr> <th>No.</th> <th>Frequency (MHz)</th> <th>Reading (dBuV)</th> <th>Factor (dB/m)</th> <th>Level (dBuV/m)</th> <th>Limit (dBuV/m)</th> <th>Margin (dB)</th> <th>Detector</th> </tr> </thead> <tbody> <tr> <td>1 *</td> <td>11649.960</td> <td>26.09</td> <td>15.13</td> <td>41.22</td> <td>54.00</td> <td>-12.78</td> <td>AVG</td> </tr> <tr> <td>2</td> <td>11650.182</td> <td>38.51</td> <td>15.14</td> <td>53.65</td> <td>74.00</td> <td>-20.35</td> <td>peak</td> </tr> </tbody> </table>								No.	Frequency (MHz)	Reading (dBuV)	Factor (dB/m)	Level (dBuV/m)	Limit (dBuV/m)	Margin (dB)	Detector	1 *	11649.960	26.09	15.13	41.22	54.00	-12.78	AVG	2	11650.182	38.51	15.14	53.65	74.00	-20.35	peak
No.	Frequency (MHz)	Reading (dBuV)	Factor (dB/m)	Level (dBuV/m)	Limit (dBuV/m)	Margin (dB)	Detector																								
1 *	11649.960	26.09	15.13	41.22	54.00	-12.78	AVG																								
2	11650.182	38.51	15.14	53.65	74.00	-20.35	peak																								
Remarks: 1.Factor (dB/m) = Antenna Factor (dB/m)+Cable Factor (dB)-Pre-amplifier Factor 2.Margin value = Level -Limit value																															



Ant. No.	Ant 1 + Ant 2																														
Ant. Pol.	Horizontal																														
Test Mode:	TX 802.11ac(VHT20) Mode 5745MHz (U-NII-3)																														
Remark:	No report for the emission which more than 20 dB below the prescribed limit.																														
<table border="1"> <thead> <tr> <th>No.</th> <th>Frequency (MHz)</th> <th>Reading (dBuV)</th> <th>Factor (dB/m)</th> <th>Level (dBuV/m)</th> <th>Limit (dBuV/m)</th> <th>Margin (dB)</th> <th>Detector</th> </tr> </thead> <tbody> <tr> <td>1 *</td> <td>11490.146</td> <td>26.99</td> <td>15.01</td> <td>42.00</td> <td>54.00</td> <td>-12.00</td> <td>AVG</td> </tr> <tr> <td>2</td> <td>11490.316</td> <td>38.12</td> <td>15.01</td> <td>53.13</td> <td>74.00</td> <td>-20.87</td> <td>peak</td> </tr> </tbody> </table>								No.	Frequency (MHz)	Reading (dBuV)	Factor (dB/m)	Level (dBuV/m)	Limit (dBuV/m)	Margin (dB)	Detector	1 *	11490.146	26.99	15.01	42.00	54.00	-12.00	AVG	2	11490.316	38.12	15.01	53.13	74.00	-20.87	peak
No.	Frequency (MHz)	Reading (dBuV)	Factor (dB/m)	Level (dBuV/m)	Limit (dBuV/m)	Margin (dB)	Detector																								
1 *	11490.146	26.99	15.01	42.00	54.00	-12.00	AVG																								
2	11490.316	38.12	15.01	53.13	74.00	-20.87	peak																								
Remarks: 1.Factor (dB/m) = Antenna Factor (dB/m)+Cable Factor (dB)-Pre-amplifier Factor 2.Margin value = Level -Limit value																															

Ant. No.	Ant 1 + Ant 2																														
Ant. Pol.	Vertical																														
Test Mode:	TX 802.11ac(VHT20) Mode 5745MHz (U-NII-3)																														
Remark:	No report for the emission which more than 20 dB below the prescribed limit.																														
<table border="1"> <thead> <tr> <th>No.</th> <th>Frequency (MHz)</th> <th>Reading (dBuV)</th> <th>Factor (dB/m)</th> <th>Level (dBuV/m)</th> <th>Limit (dBuV/m)</th> <th>Margin (dB)</th> <th>Detector</th> </tr> </thead> <tbody> <tr> <td>1</td> <td>11489.985</td> <td>38.79</td> <td>15.00</td> <td>53.79</td> <td>74.00</td> <td>-20.21</td> <td>peak</td> </tr> <tr> <td>2 *</td> <td>11489.990</td> <td>25.97</td> <td>15.00</td> <td>40.97</td> <td>54.00</td> <td>-13.03</td> <td>AVG</td> </tr> </tbody> </table>								No.	Frequency (MHz)	Reading (dBuV)	Factor (dB/m)	Level (dBuV/m)	Limit (dBuV/m)	Margin (dB)	Detector	1	11489.985	38.79	15.00	53.79	74.00	-20.21	peak	2 *	11489.990	25.97	15.00	40.97	54.00	-13.03	AVG
No.	Frequency (MHz)	Reading (dBuV)	Factor (dB/m)	Level (dBuV/m)	Limit (dBuV/m)	Margin (dB)	Detector																								
1	11489.985	38.79	15.00	53.79	74.00	-20.21	peak																								
2 *	11489.990	25.97	15.00	40.97	54.00	-13.03	AVG																								
Remarks: 1.Factor (dB/m) = Antenna Factor (dB/m)+Cable Factor (dB)-Pre-amplifier Factor 2.Margin value = Level -Limit value																															



Ant. No.	Ant 1 + Ant 2																														
Ant. Pol.	Horizontal																														
Test Mode:	TX 802.11ac(VHT20) Mode 5785MHz (U-NII-3)																														
Remark:	No report for the emission which more than 20 dB below the prescribed limit.																														
<table border="1"> <thead> <tr> <th>No.</th> <th>Frequency (MHz)</th> <th>Reading (dBuV)</th> <th>Factor (dB/m)</th> <th>Level (dBuV/m)</th> <th>Limit (dBuV/m)</th> <th>Margin (dB)</th> <th>Detector</th> </tr> </thead> <tbody> <tr> <td>1</td> <td>11570.137</td> <td>37.94</td> <td>15.07</td> <td>53.01</td> <td>74.00</td> <td>-20.99</td> <td>peak</td> </tr> <tr> <td>2 *</td> <td>11570.264</td> <td>27.28</td> <td>15.07</td> <td>42.35</td> <td>54.00</td> <td>-11.65</td> <td>AVG</td> </tr> </tbody> </table>								No.	Frequency (MHz)	Reading (dBuV)	Factor (dB/m)	Level (dBuV/m)	Limit (dBuV/m)	Margin (dB)	Detector	1	11570.137	37.94	15.07	53.01	74.00	-20.99	peak	2 *	11570.264	27.28	15.07	42.35	54.00	-11.65	AVG
No.	Frequency (MHz)	Reading (dBuV)	Factor (dB/m)	Level (dBuV/m)	Limit (dBuV/m)	Margin (dB)	Detector																								
1	11570.137	37.94	15.07	53.01	74.00	-20.99	peak																								
2 *	11570.264	27.28	15.07	42.35	54.00	-11.65	AVG																								
Remarks: 1.Factor (dB/m) = Antenna Factor (dB/m)+Cable Factor (dB)-Pre-amplifier Factor 2.Margin value = Level -Limit value																															

Ant. No.	Ant 1 + Ant 2																														
Ant. Pol.	Vertical																														
Test Mode:	TX 802.11ac(VHT20) Mode 5785MHz (U-NII-3)																														
Remark:	No report for the emission which more than 20 dB below the prescribed limit.																														
<table border="1"> <thead> <tr> <th>No.</th> <th>Frequency (MHz)</th> <th>Reading (dBuV)</th> <th>Factor (dB/m)</th> <th>Level (dBuV/m)</th> <th>Limit (dBuV/m)</th> <th>Margin (dB)</th> <th>Detector</th> </tr> </thead> <tbody> <tr> <td>1 *</td> <td>11569.807</td> <td>25.75</td> <td>15.06</td> <td>40.81</td> <td>54.00</td> <td>-13.19</td> <td>AVG</td> </tr> <tr> <td>2</td> <td>11569.925</td> <td>38.10</td> <td>15.06</td> <td>53.16</td> <td>74.00</td> <td>-20.84</td> <td>peak</td> </tr> </tbody> </table>								No.	Frequency (MHz)	Reading (dBuV)	Factor (dB/m)	Level (dBuV/m)	Limit (dBuV/m)	Margin (dB)	Detector	1 *	11569.807	25.75	15.06	40.81	54.00	-13.19	AVG	2	11569.925	38.10	15.06	53.16	74.00	-20.84	peak
No.	Frequency (MHz)	Reading (dBuV)	Factor (dB/m)	Level (dBuV/m)	Limit (dBuV/m)	Margin (dB)	Detector																								
1 *	11569.807	25.75	15.06	40.81	54.00	-13.19	AVG																								
2	11569.925	38.10	15.06	53.16	74.00	-20.84	peak																								
Remarks: 1.Factor (dB/m) = Antenna Factor (dB/m)+Cable Factor (dB)-Pre-amplifier Factor 2.Margin value = Level -Limit value																															



Ant. No.	Ant 1 + Ant 2																														
Ant. Pol.	Horizontal																														
Test Mode:	TX 802.11ac(VHT20) Mode 5825MHz (U-NII-3)																														
Remark:	No report for the emission which more than 20 dB below the prescribed limit.																														
<table border="1"> <thead> <tr> <th>No.</th> <th>Frequency (MHz)</th> <th>Reading (dBUV)</th> <th>Factor (dB/m)</th> <th>Level (dBUV/m)</th> <th>Limit (dBUV/m)</th> <th>Margin (dB)</th> <th>Detector</th> </tr> </thead> <tbody> <tr> <td>1</td> <td>11649.855</td> <td>38.31</td> <td>15.13</td> <td>53.44</td> <td>74.00</td> <td>-20.56</td> <td>peak</td> </tr> <tr> <td>2 *</td> <td>11650.231</td> <td>26.92</td> <td>15.14</td> <td>42.06</td> <td>54.00</td> <td>-11.94</td> <td>AVG</td> </tr> </tbody> </table>								No.	Frequency (MHz)	Reading (dBUV)	Factor (dB/m)	Level (dBUV/m)	Limit (dBUV/m)	Margin (dB)	Detector	1	11649.855	38.31	15.13	53.44	74.00	-20.56	peak	2 *	11650.231	26.92	15.14	42.06	54.00	-11.94	AVG
No.	Frequency (MHz)	Reading (dBUV)	Factor (dB/m)	Level (dBUV/m)	Limit (dBUV/m)	Margin (dB)	Detector																								
1	11649.855	38.31	15.13	53.44	74.00	-20.56	peak																								
2 *	11650.231	26.92	15.14	42.06	54.00	-11.94	AVG																								
Remarks: 1.Factor (dB/m) = Antenna Factor (dB/m)+Cable Factor (dB)-Pre-amplifier Factor 2.Margin value = Level -Limit value																															

Ant. No.	Ant 1 + Ant 2																														
Ant. Pol.	Vertical																														
Test Mode:	TX 802.11ac(VHT20) Mode 5825MHz (U-NII-3)																														
Remark:	No report for the emission which more than 20 dB below the prescribed limit.																														
<table border="1"> <thead> <tr> <th>No.</th> <th>Frequency (MHz)</th> <th>Reading (dBUV)</th> <th>Factor (dB/m)</th> <th>Level (dBUV/m)</th> <th>Limit (dBUV/m)</th> <th>Margin (dB)</th> <th>Detector</th> </tr> </thead> <tbody> <tr> <td>1</td> <td>11650.179</td> <td>38.69</td> <td>15.14</td> <td>53.83</td> <td>74.00</td> <td>-20.17</td> <td>peak</td> </tr> <tr> <td>2 *</td> <td>11650.404</td> <td>25.48</td> <td>15.14</td> <td>40.62</td> <td>54.00</td> <td>-13.38</td> <td>AVG</td> </tr> </tbody> </table>								No.	Frequency (MHz)	Reading (dBUV)	Factor (dB/m)	Level (dBUV/m)	Limit (dBUV/m)	Margin (dB)	Detector	1	11650.179	38.69	15.14	53.83	74.00	-20.17	peak	2 *	11650.404	25.48	15.14	40.62	54.00	-13.38	AVG
No.	Frequency (MHz)	Reading (dBUV)	Factor (dB/m)	Level (dBUV/m)	Limit (dBUV/m)	Margin (dB)	Detector																								
1	11650.179	38.69	15.14	53.83	74.00	-20.17	peak																								
2 *	11650.404	25.48	15.14	40.62	54.00	-13.38	AVG																								
Remarks: 1.Factor (dB/m) = Antenna Factor (dB/m)+Cable Factor (dB)-Pre-amplifier Factor 2.Margin value = Level -Limit value																															



Ant. No.	Ant 1 + Ant 2																														
Ant. Pol.	Horizontal																														
Test Mode:	TX 802.11n(HT40) Mode 5755MHz (U-NII-3)																														
Remark:	No report for the emission which more than 20 dB below the prescribed limit.																														
<table border="1"> <thead> <tr> <th>No.</th> <th>Frequency (MHz)</th> <th>Reading (dBuV)</th> <th>Factor (dB/m)</th> <th>Level (dBuV/m)</th> <th>Limit (dBuV/m)</th> <th>Margin (dB)</th> <th>Detector</th> </tr> </thead> <tbody> <tr> <td>1</td> <td>11510.205</td> <td>37.79</td> <td>15.01</td> <td>52.80</td> <td>74.00</td> <td>-21.20</td> <td>peak</td> </tr> <tr> <td>2 *</td> <td>11510.225</td> <td>26.62</td> <td>15.01</td> <td>41.63</td> <td>54.00</td> <td>-12.37</td> <td>AVG</td> </tr> </tbody> </table>								No.	Frequency (MHz)	Reading (dBuV)	Factor (dB/m)	Level (dBuV/m)	Limit (dBuV/m)	Margin (dB)	Detector	1	11510.205	37.79	15.01	52.80	74.00	-21.20	peak	2 *	11510.225	26.62	15.01	41.63	54.00	-12.37	AVG
No.	Frequency (MHz)	Reading (dBuV)	Factor (dB/m)	Level (dBuV/m)	Limit (dBuV/m)	Margin (dB)	Detector																								
1	11510.205	37.79	15.01	52.80	74.00	-21.20	peak																								
2 *	11510.225	26.62	15.01	41.63	54.00	-12.37	AVG																								
Remarks: 1.Factor (dB/m) = Antenna Factor (dB/m)+Cable Factor (dB)-Pre-amplifier Factor 2.Margin value = Level -Limit value																															

Ant. No.	Ant 1 + Ant 2																														
Ant. Pol.	Vertical																														
Test Mode:	TX 802.11n(HT40) Mode 5755MHz (U-NII-3)																														
Remark:	No report for the emission which more than 20 dB below the prescribed limit.																														
<table border="1"> <thead> <tr> <th>No.</th> <th>Frequency (MHz)</th> <th>Reading (dBuV)</th> <th>Factor (dB/m)</th> <th>Level (dBuV/m)</th> <th>Limit (dBuV/m)</th> <th>Margin (dB)</th> <th>Detector</th> </tr> </thead> <tbody> <tr> <td>1</td> <td>11510.127</td> <td>39.11</td> <td>15.01</td> <td>54.12</td> <td>74.00</td> <td>-19.88</td> <td>peak</td> </tr> <tr> <td>2 *</td> <td>11510.314</td> <td>26.12</td> <td>15.01</td> <td>41.13</td> <td>54.00</td> <td>-12.87</td> <td>AVG</td> </tr> </tbody> </table>								No.	Frequency (MHz)	Reading (dBuV)	Factor (dB/m)	Level (dBuV/m)	Limit (dBuV/m)	Margin (dB)	Detector	1	11510.127	39.11	15.01	54.12	74.00	-19.88	peak	2 *	11510.314	26.12	15.01	41.13	54.00	-12.87	AVG
No.	Frequency (MHz)	Reading (dBuV)	Factor (dB/m)	Level (dBuV/m)	Limit (dBuV/m)	Margin (dB)	Detector																								
1	11510.127	39.11	15.01	54.12	74.00	-19.88	peak																								
2 *	11510.314	26.12	15.01	41.13	54.00	-12.87	AVG																								
Remarks: 1.Factor (dB/m) = Antenna Factor (dB/m)+Cable Factor (dB)-Pre-amplifier Factor 2.Margin value = Level -Limit value																															



Ant. No.	Ant 1 + Ant 2																														
Ant. Pol.	Horizontal																														
Test Mode:	TX 802.11n(HT40) Mode 5795MHz (U-NII-3)																														
Remark:	No report for the emission which more than 20 dB below the prescribed limit.																														
<table border="1"> <thead> <tr> <th>No.</th> <th>Frequency (MHz)</th> <th>Reading (dBuV)</th> <th>Factor (dB/m)</th> <th>Level (dBuV/m)</th> <th>Limit (dBuV/m)</th> <th>Margin (dB)</th> <th>Detector</th> </tr> </thead> <tbody> <tr> <td>1</td> <td>11589.868</td> <td>37.72</td> <td>15.08</td> <td>52.80</td> <td>74.00</td> <td>-21.20</td> <td>peak</td> </tr> <tr> <td>2 *</td> <td>11590.086</td> <td>27.10</td> <td>15.09</td> <td>42.19</td> <td>54.00</td> <td>-11.81</td> <td>AVG</td> </tr> </tbody> </table>								No.	Frequency (MHz)	Reading (dBuV)	Factor (dB/m)	Level (dBuV/m)	Limit (dBuV/m)	Margin (dB)	Detector	1	11589.868	37.72	15.08	52.80	74.00	-21.20	peak	2 *	11590.086	27.10	15.09	42.19	54.00	-11.81	AVG
No.	Frequency (MHz)	Reading (dBuV)	Factor (dB/m)	Level (dBuV/m)	Limit (dBuV/m)	Margin (dB)	Detector																								
1	11589.868	37.72	15.08	52.80	74.00	-21.20	peak																								
2 *	11590.086	27.10	15.09	42.19	54.00	-11.81	AVG																								
Remarks: 1.Factor (dB/m) = Antenna Factor (dB/m)+Cable Factor (dB)-Pre-amplifier Factor 2.Margin value = Level -Limit value																															

Ant. No.	Ant 1 + Ant 2																														
Ant. Pol.	Vertical																														
Test Mode:	TX 802.11n(HT40) Mode 5795MHz (U-NII-3)																														
Remark:	No report for the emission which more than 20 dB below the prescribed limit.																														
<table border="1"> <thead> <tr> <th>No.</th> <th>Frequency (MHz)</th> <th>Reading (dBuV)</th> <th>Factor (dB/m)</th> <th>Level (dBuV/m)</th> <th>Limit (dBuV/m)</th> <th>Margin (dB)</th> <th>Detector</th> </tr> </thead> <tbody> <tr> <td>1</td> <td>11589.972</td> <td>38.57</td> <td>15.08</td> <td>53.65</td> <td>74.00</td> <td>-20.35</td> <td>peak</td> </tr> <tr> <td>2 *</td> <td>11590.028</td> <td>26.27</td> <td>15.09</td> <td>41.36</td> <td>54.00</td> <td>-12.64</td> <td>AVG</td> </tr> </tbody> </table>								No.	Frequency (MHz)	Reading (dBuV)	Factor (dB/m)	Level (dBuV/m)	Limit (dBuV/m)	Margin (dB)	Detector	1	11589.972	38.57	15.08	53.65	74.00	-20.35	peak	2 *	11590.028	26.27	15.09	41.36	54.00	-12.64	AVG
No.	Frequency (MHz)	Reading (dBuV)	Factor (dB/m)	Level (dBuV/m)	Limit (dBuV/m)	Margin (dB)	Detector																								
1	11589.972	38.57	15.08	53.65	74.00	-20.35	peak																								
2 *	11590.028	26.27	15.09	41.36	54.00	-12.64	AVG																								
Remarks: 1.Factor (dB/m) = Antenna Factor (dB/m)+Cable Factor (dB)-Pre-amplifier Factor 2.Margin value = Level -Limit value																															



Ant. No.	Ant 1 + Ant 2																														
Ant. Pol.	Horizontal																														
Test Mode:	TX 802.11ac(VHT40) Mode 5755MHz (U-NII-3)																														
Remark:	No report for the emission which more than 20 dB below the prescribed limit.																														
<table border="1"> <thead> <tr> <th>No.</th> <th>Frequency (MHz)</th> <th>Reading (dBuV)</th> <th>Factor (dB/m)</th> <th>Level (dBuV/m)</th> <th>Limit (dBuV/m)</th> <th>Margin (dB)</th> <th>Detector</th> </tr> </thead> <tbody> <tr> <td>1 *</td> <td>11510.214</td> <td>27.45</td> <td>15.01</td> <td>42.46</td> <td>54.00</td> <td>-11.54</td> <td>AVG</td> </tr> <tr> <td>2</td> <td>11510.239</td> <td>38.19</td> <td>15.01</td> <td>53.20</td> <td>74.00</td> <td>-20.80</td> <td>peak</td> </tr> </tbody> </table>								No.	Frequency (MHz)	Reading (dBuV)	Factor (dB/m)	Level (dBuV/m)	Limit (dBuV/m)	Margin (dB)	Detector	1 *	11510.214	27.45	15.01	42.46	54.00	-11.54	AVG	2	11510.239	38.19	15.01	53.20	74.00	-20.80	peak
No.	Frequency (MHz)	Reading (dBuV)	Factor (dB/m)	Level (dBuV/m)	Limit (dBuV/m)	Margin (dB)	Detector																								
1 *	11510.214	27.45	15.01	42.46	54.00	-11.54	AVG																								
2	11510.239	38.19	15.01	53.20	74.00	-20.80	peak																								
Remarks: 1.Factor (dB/m) = Antenna Factor (dB/m)+Cable Factor (dB)-Pre-amplifier Factor 2.Margin value = Level -Limit value																															

Ant. No.	Ant 1 + Ant 2																														
Ant. Pol.	Vertical																														
Test Mode:	TX 802.11ac(VHT40) Mode 5755MHz (U-NII-3)																														
Remark:	No report for the emission which more than 20 dB below the prescribed limit.																														
<table border="1"> <thead> <tr> <th>No.</th> <th>Frequency (MHz)</th> <th>Reading (dBuV)</th> <th>Factor (dB/m)</th> <th>Level (dBuV/m)</th> <th>Limit (dBuV/m)</th> <th>Margin (dB)</th> <th>Detector</th> </tr> </thead> <tbody> <tr> <td>1</td> <td>11510.180</td> <td>38.71</td> <td>15.01</td> <td>53.72</td> <td>74.00</td> <td>-20.28</td> <td>peak</td> </tr> <tr> <td>2 *</td> <td>11510.318</td> <td>25.59</td> <td>15.01</td> <td>40.60</td> <td>54.00</td> <td>-13.40</td> <td>AVG</td> </tr> </tbody> </table>								No.	Frequency (MHz)	Reading (dBuV)	Factor (dB/m)	Level (dBuV/m)	Limit (dBuV/m)	Margin (dB)	Detector	1	11510.180	38.71	15.01	53.72	74.00	-20.28	peak	2 *	11510.318	25.59	15.01	40.60	54.00	-13.40	AVG
No.	Frequency (MHz)	Reading (dBuV)	Factor (dB/m)	Level (dBuV/m)	Limit (dBuV/m)	Margin (dB)	Detector																								
1	11510.180	38.71	15.01	53.72	74.00	-20.28	peak																								
2 *	11510.318	25.59	15.01	40.60	54.00	-13.40	AVG																								
Remarks: 1.Factor (dB/m) = Antenna Factor (dB/m)+Cable Factor (dB)-Pre-amplifier Factor 2.Margin value = Level -Limit value																															



Ant. No.	Ant 1 + Ant 2																														
Ant. Pol.	Horizontal																														
Test Mode:	TX 802.11ac(VHT40) Mode 5795MHz (U-NII-3)																														
Remark:	No report for the emission which more than 20 dB below the prescribed limit.																														
<table border="1"> <thead> <tr> <th>No.</th> <th>Frequency (MHz)</th> <th>Reading (dBuV)</th> <th>Factor (dB/m)</th> <th>Level (dBuV/m)</th> <th>Limit (dBuV/m)</th> <th>Margin (dB)</th> <th>Detector</th> </tr> </thead> <tbody> <tr> <td>1</td> <td>11589.862</td> <td>37.90</td> <td>15.08</td> <td>52.98</td> <td>74.00</td> <td>-21.02</td> <td>peak</td> </tr> <tr> <td>2 *</td> <td>11590.030</td> <td>26.95</td> <td>15.09</td> <td>42.04</td> <td>54.00</td> <td>-11.96</td> <td>AVG</td> </tr> </tbody> </table>								No.	Frequency (MHz)	Reading (dBuV)	Factor (dB/m)	Level (dBuV/m)	Limit (dBuV/m)	Margin (dB)	Detector	1	11589.862	37.90	15.08	52.98	74.00	-21.02	peak	2 *	11590.030	26.95	15.09	42.04	54.00	-11.96	AVG
No.	Frequency (MHz)	Reading (dBuV)	Factor (dB/m)	Level (dBuV/m)	Limit (dBuV/m)	Margin (dB)	Detector																								
1	11589.862	37.90	15.08	52.98	74.00	-21.02	peak																								
2 *	11590.030	26.95	15.09	42.04	54.00	-11.96	AVG																								
Remarks: 1.Factor (dB/m) = Antenna Factor (dB/m)+Cable Factor (dB)-Pre-amplifier Factor 2.Margin value = Level -Limit value																															

Ant. No.	Ant 1 + Ant 2																														
Ant. Pol.	Vertical																														
Test Mode:	TX 802.11ac(VHT40) Mode 5795MHz (U-NII-3)																														
Remark:	No report for the emission which more than 20 dB below the prescribed limit.																														
<table border="1"> <thead> <tr> <th>No.</th> <th>Frequency (MHz)</th> <th>Reading (dBuV)</th> <th>Factor (dB/m)</th> <th>Level (dBuV/m)</th> <th>Limit (dBuV/m)</th> <th>Margin (dB)</th> <th>Detector</th> </tr> </thead> <tbody> <tr> <td>1</td> <td>11590.115</td> <td>38.44</td> <td>15.09</td> <td>53.53</td> <td>74.00</td> <td>-20.47</td> <td>peak</td> </tr> <tr> <td>2 *</td> <td>11590.412</td> <td>25.33</td> <td>15.09</td> <td>40.42</td> <td>54.00</td> <td>-13.58</td> <td>AVG</td> </tr> </tbody> </table>								No.	Frequency (MHz)	Reading (dBuV)	Factor (dB/m)	Level (dBuV/m)	Limit (dBuV/m)	Margin (dB)	Detector	1	11590.115	38.44	15.09	53.53	74.00	-20.47	peak	2 *	11590.412	25.33	15.09	40.42	54.00	-13.58	AVG
No.	Frequency (MHz)	Reading (dBuV)	Factor (dB/m)	Level (dBuV/m)	Limit (dBuV/m)	Margin (dB)	Detector																								
1	11590.115	38.44	15.09	53.53	74.00	-20.47	peak																								
2 *	11590.412	25.33	15.09	40.42	54.00	-13.58	AVG																								
Remarks: 1.Factor (dB/m) = Antenna Factor (dB/m)+Cable Factor (dB)-Pre-amplifier Factor 2.Margin value = Level -Limit value																															



Ant. No.	Ant 1 + Ant 2																														
Ant. Pol.	Horizontal																														
Test Mode:	TX 802.11ac(VHT80) Mode 5775MHz (U-NII-3)																														
Remark:	No report for the emission which more than 20 dB below the prescribed limit.																														
<table border="1"> <thead> <tr> <th>No.</th> <th>Frequency (MHz)</th> <th>Reading (dBuV)</th> <th>Factor (dB/m)</th> <th>Level (dBuV/m)</th> <th>Limit (dBuV/m)</th> <th>Margin (dB)</th> <th>Detector</th> </tr> </thead> <tbody> <tr> <td>1 *</td> <td>11549.822</td> <td>27.84</td> <td>15.04</td> <td>42.88</td> <td>54.00</td> <td>-11.12</td> <td>AVG</td> </tr> <tr> <td>2</td> <td>11550.173</td> <td>38.46</td> <td>15.05</td> <td>53.51</td> <td>74.00</td> <td>-20.49</td> <td>peak</td> </tr> </tbody> </table>								No.	Frequency (MHz)	Reading (dBuV)	Factor (dB/m)	Level (dBuV/m)	Limit (dBuV/m)	Margin (dB)	Detector	1 *	11549.822	27.84	15.04	42.88	54.00	-11.12	AVG	2	11550.173	38.46	15.05	53.51	74.00	-20.49	peak
No.	Frequency (MHz)	Reading (dBuV)	Factor (dB/m)	Level (dBuV/m)	Limit (dBuV/m)	Margin (dB)	Detector																								
1 *	11549.822	27.84	15.04	42.88	54.00	-11.12	AVG																								
2	11550.173	38.46	15.05	53.51	74.00	-20.49	peak																								
Remarks: 1.Factor (dB/m) = Antenna Factor (dB/m)+Cable Factor (dB)-Pre-amplifier Factor 2.Margin value = Level -Limit value																															

Ant. No.	Ant 1 + Ant 2																														
Ant. Pol.	Vertical																														
Test Mode:	TX 802.11ac(VHT80) Mode 5775MHz (U-NII-3)																														
Remark:	No report for the emission which more than 20 dB below the prescribed limit.																														
<table border="1"> <thead> <tr> <th>No.</th> <th>Frequency (MHz)</th> <th>Reading (dBuV)</th> <th>Factor (dB/m)</th> <th>Level (dBuV/m)</th> <th>Limit (dBuV/m)</th> <th>Margin (dB)</th> <th>Detector</th> </tr> </thead> <tbody> <tr> <td>1</td> <td>11550.031</td> <td>38.66</td> <td>15.05</td> <td>53.71</td> <td>74.00</td> <td>-20.29</td> <td>peak</td> </tr> <tr> <td>2 *</td> <td>11550.304</td> <td>26.15</td> <td>15.05</td> <td>41.20</td> <td>54.00</td> <td>-12.80</td> <td>AVG</td> </tr> </tbody> </table>								No.	Frequency (MHz)	Reading (dBuV)	Factor (dB/m)	Level (dBuV/m)	Limit (dBuV/m)	Margin (dB)	Detector	1	11550.031	38.66	15.05	53.71	74.00	-20.29	peak	2 *	11550.304	26.15	15.05	41.20	54.00	-12.80	AVG
No.	Frequency (MHz)	Reading (dBuV)	Factor (dB/m)	Level (dBuV/m)	Limit (dBuV/m)	Margin (dB)	Detector																								
1	11550.031	38.66	15.05	53.71	74.00	-20.29	peak																								
2 *	11550.304	26.15	15.05	41.20	54.00	-12.80	AVG																								
Remarks: 1.Factor (dB/m) = Antenna Factor (dB/m)+Cable Factor (dB)-Pre-amplifier Factor 2.Margin value = Level -Limit value																															

3.3. Band Edge Emissions

Limit

Limits of unwanted emission out of the restricted bands

FCC CFR Title 47 Part 15 Subpart E Section 15. 407(b) / RSS-247 6.2

Frequency (MHz)	EIRP Limits (dBm)	Equivalent Field Strength at 3m (dBμV/m)
5150~5250	-27	68.2
5250~5350	-27	68.2
5470~5725	-27	68.2
5725~5825	-27 (Note 2)	68.2
	10 (Note 2)	105.2
	15.6 (Note 2)	110.8
	27 (Note 2)	122.2

Note:

1. The following formula is used to convert the equipment isotropic radiated power (eirp) to field strength:

$$E = \frac{1000000\sqrt{30P}}{3} \mu\text{V/m, where P is the eirp (Watts).$$

2. According to FCC 16-24, all emissions shall be limited to a level of -27 dBm/MHz at 75 MHz or more above or below the band edge increasing linearly to 10 dBm/MHz at 25 MHz above or below the band edge, and from 25MHz above or below the band edge increasing linearly to a level of 15.6 dBm/MHz at 5 MHz above or below the band edge, and from 5 MHz above or below the band edge increasing linearly to a level of 27dBm/MHz at the band edge.

Test Configuration

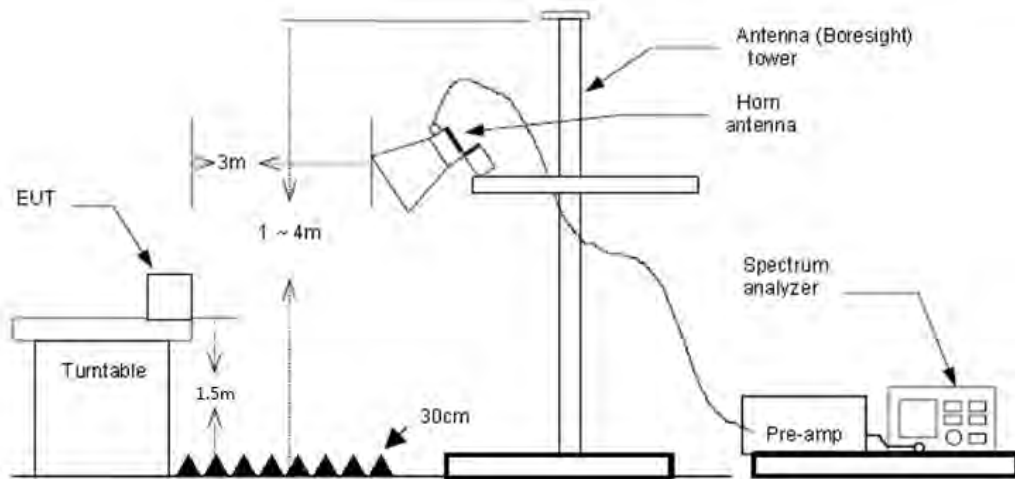



Test Procedure

1. The EUT was setup and tested according to ANSI C63.10:2013 requirements.
2. The EUT is placed on a turn table which is 1.5 meter above ground. The turn table is rotated 360 degrees to determine the position of the maximum emission level.
3. The EUT was positioned such that the distance from antenna to the EUT was 3 meters.
4. The antenna is scanned from 1 meter to 4 meters to find out the maximum emission level. This is repeated for both horizontal and vertical polarization of the antenna. In order to find the maximum emission, all of the interface cables were manipulated according to ANSI C63.10:2013 on radiated measurement.
5. The receiver set as follow:
RBW=1MHz, VBW=3MHz Peak detector for Peak value.
RBW=1MHz, VBW see note 1 with Peak Detector for Average Value.

Note 1: For measurements above 1 GHz the resolution bandwidth is set to 1 MHz, then the video bandwidth is set to 3 MHz for peak measurements and 1 MHz resolution bandwidth with 1/T video bandwidth with peak detector for average measurements. For the Duty Cycle please refer to clause Duty Cycle.

Test Mode

Please refer to the clause 2.4.



Test Result

Note:

- 1. Pre-scan both 4500-5150MHz, 5350-5460MHz were investigated, report only shows the test data for worst case.
- 2. Pre-scan all antenna, only show the test data for worse case antenna on the test report.

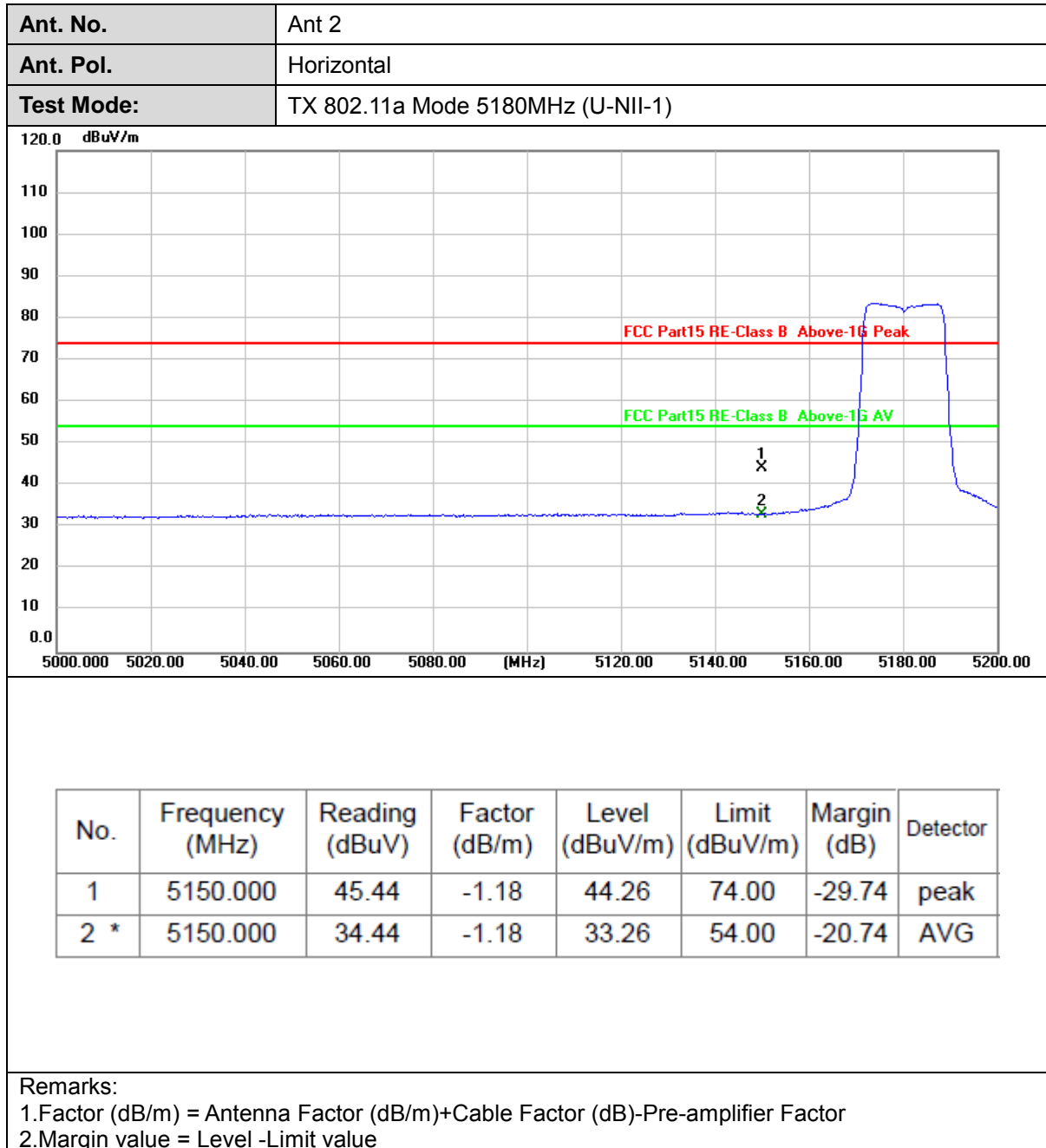



Ant. No.	Ant 2
Ant. Pol.	Vertical
Test Mode:	TX 802.11a Mode 5180MHz (U-NII-1)

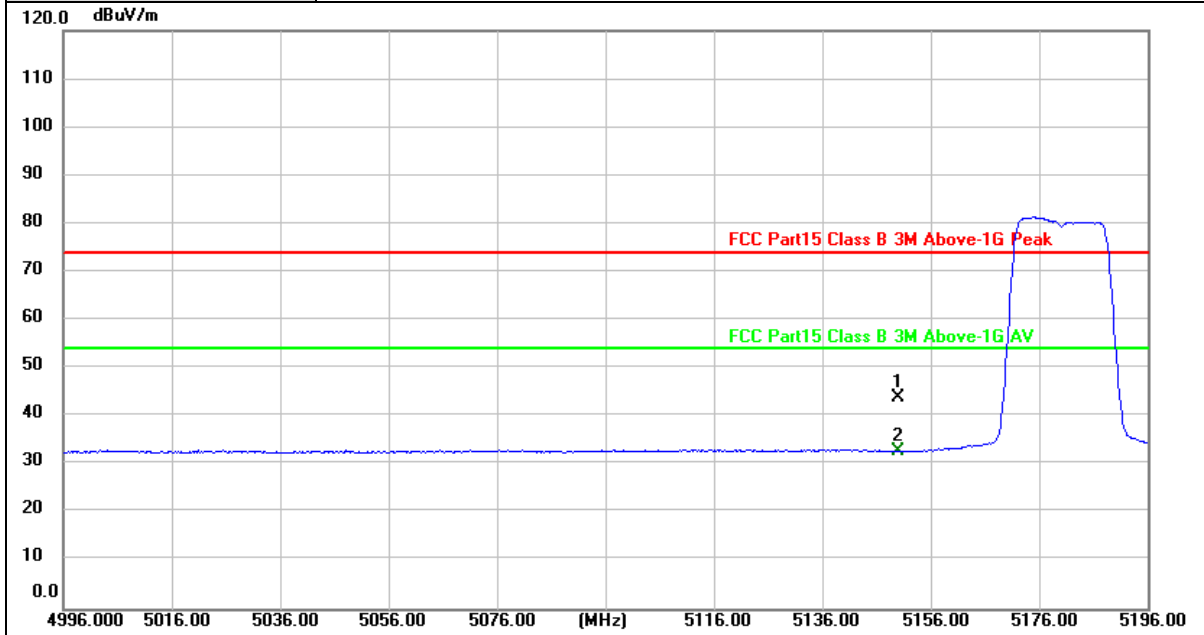

No.	Frequency (MHz)	Reading (dBuV)	Factor (dB/m)	Level (dBuV/m)	Limit (dBuV/m)	Margin (dB)	Detector
1	5150.000	45.16	-1.18	43.98	74.00	-30.02	peak
2 *	5150.000	33.96	-1.18	32.78	54.00	-21.22	AVG

Remarks:

- Factor (dB/m) = Antenna Factor (dB/m)+Cable Factor (dB)-Pre-amplifier Factor
- Margin value = Level -Limit value





Ant. No.	Ant 2
Ant. Pol.	Horizontal
Test Mode:	TX 802.11a Mode 5320MHz (U-NII-2A)

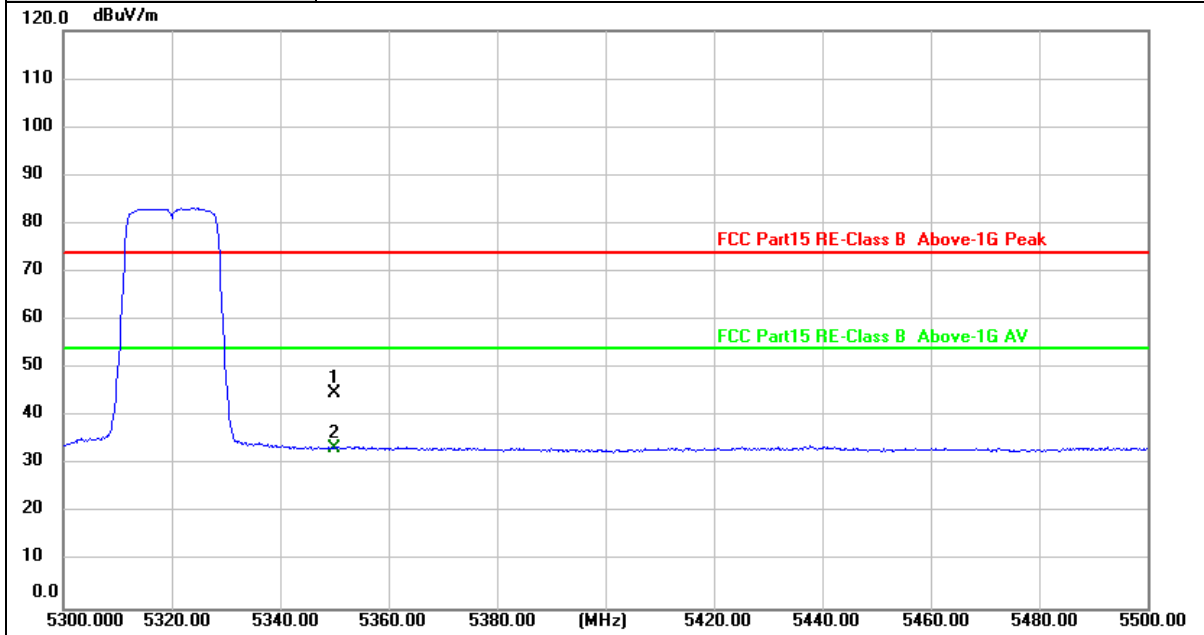

No.	Frequency (MHz)	Reading (dBuV)	Factor (dB/m)	Level (dBuV/m)	Limit (dBuV/m)	Margin (dB)	Detector
1	5350.000	45.39	-0.62	44.77	74.00	-29.23	peak
2 *	5350.000	34.09	-0.62	33.47	54.00	-20.53	AVG

Remarks:

- 1. Factor (dB/m) = Antenna Factor (dB/m)+Cable Factor (dB)-Pre-amplifier Factor
- 2. Margin value = Level -Limit value



Ant. No.	Ant 2
Ant. Pol.	Vertical
Test Mode:	TX 802.11a Mode 5320MHz (U-NII-2A)

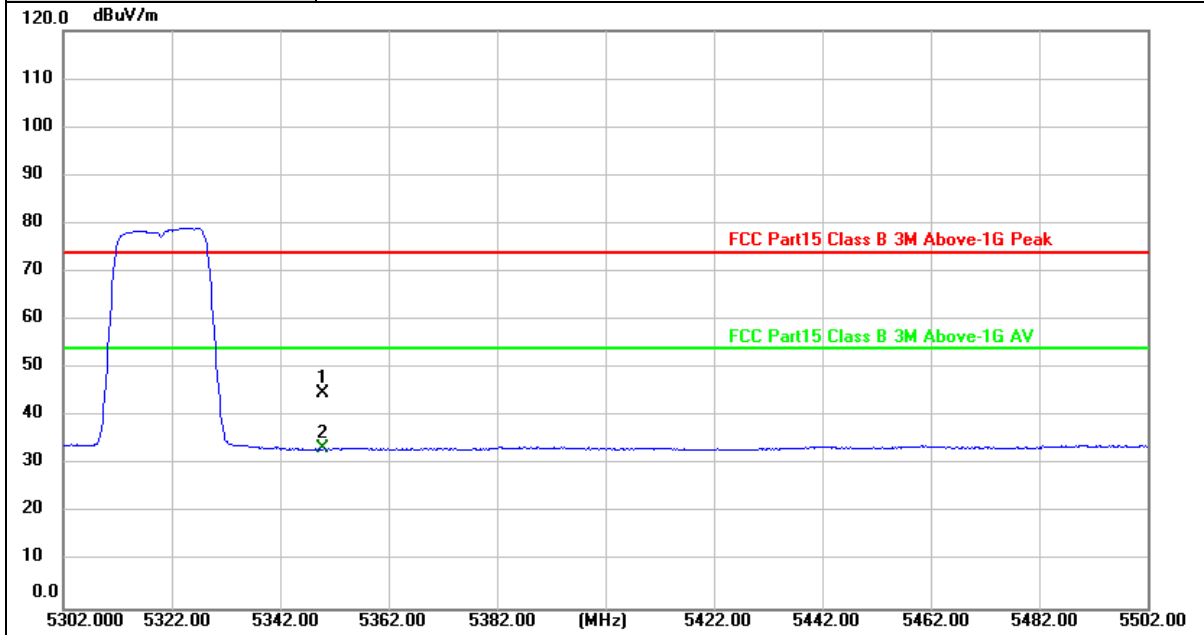

No.	Frequency (MHz)	Reading (dBuV)	Factor (dB/m)	Level (dBuV/m)	Limit (dBuV/m)	Margin (dB)	Detector
1	5350.000	45.33	-0.62	44.71	74.00	-29.29	peak
2 *	5350.000	33.98	-0.62	33.36	54.00	-20.64	AVG

Remarks:

- 1.Factor (dB/m) = Antenna Factor (dB/m)+Cable Factor (dB)-Pre-amplifier Factor
- 2.Margin value = Level -Limit value





Ant. No.	Ant 1 + Ant 2
Ant. Pol.	Horizontal
Test Mode:	TX 802.11n(HT20) Mode 5180MHz (U-NII-1)

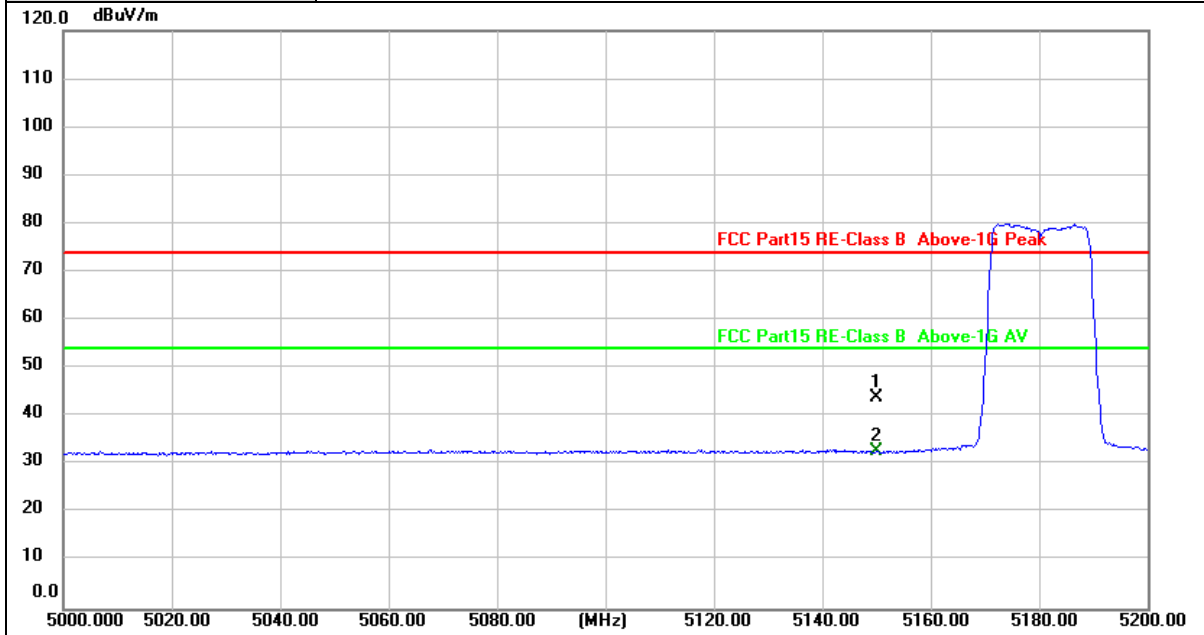

No.	Frequency (MHz)	Reading (dBuV)	Factor (dB/m)	Level (dBuV/m)	Limit (dBuV/m)	Margin (dB)	Detector
1	5150.000	45.26	-1.18	44.08	74.00	-29.92	peak
2 *	5150.000	34.05	-1.18	32.87	54.00	-21.13	AVG

Remarks:

- 1. Factor (dB/m) = Antenna Factor (dB/m)+Cable Factor (dB)-Pre-amplifier Factor
- 2. Margin value = Level -Limit value



Ant. No.	Ant 1 + Ant 2
Ant. Pol.	Vertical
Test Mode:	TX 802.11n(HT20) Mode 5180MHz (U-NII-1)

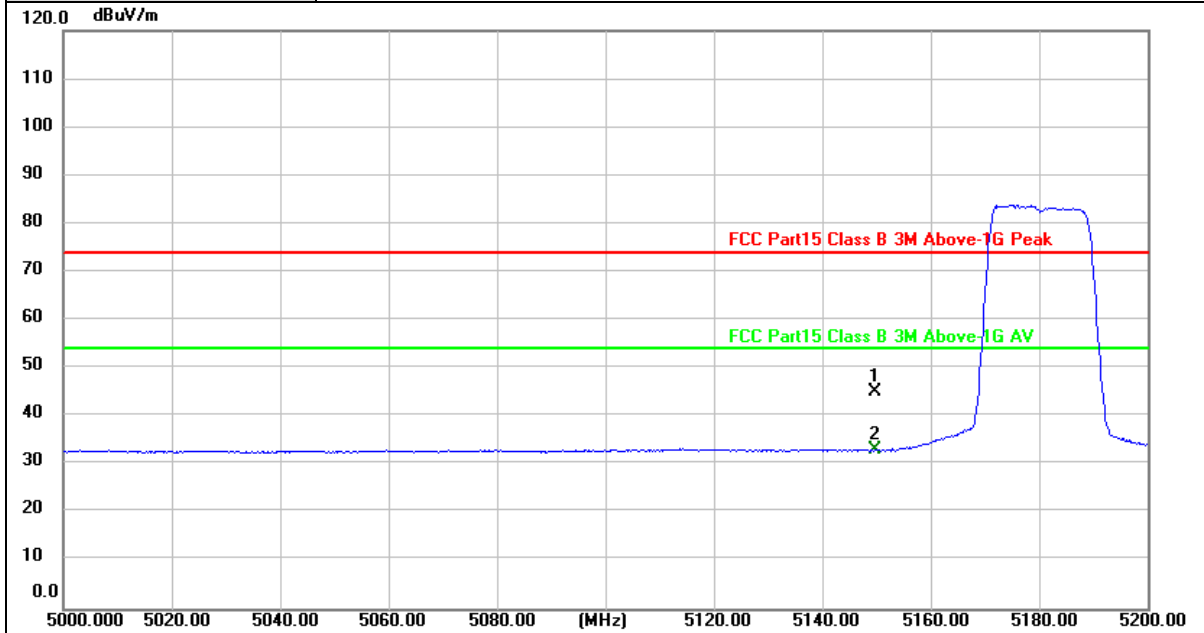

No.	Frequency (MHz)	Reading (dBuV)	Factor (dB/m)	Level (dBuV/m)	Limit (dBuV/m)	Margin (dB)	Detector
1	5150.000	46.22	-1.18	45.04	74.00	-28.96	peak
2 *	5150.000	34.32	-1.18	33.14	54.00	-20.86	AVG

Remarks:

1. Factor (dB/m) = Antenna Factor (dB/m)+Cable Factor (dB)-Pre-amplifier Factor
2. Margin value = Level -Limit value





Ant. No.	Ant 1 + Ant 2
Ant. Pol.	Horizontal
Test Mode:	TX 802.11n(HT20) Mode 5320MHz (U-NII-2A)

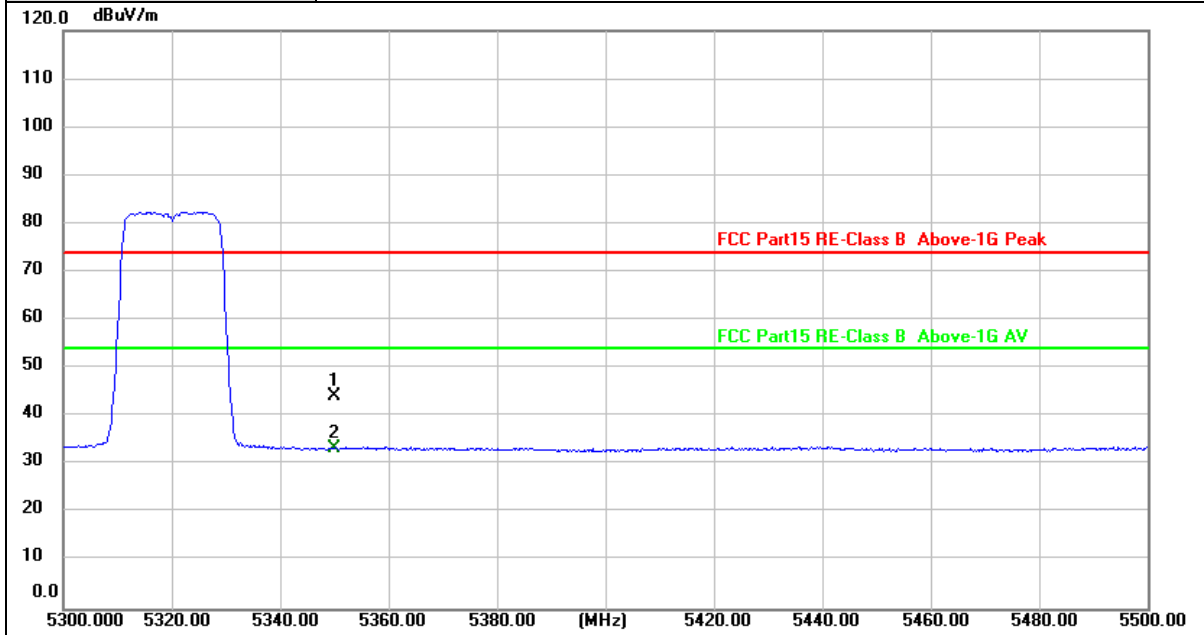

No.	Frequency (MHz)	Reading (dBuV)	Factor (dB/m)	Level (dBuV/m)	Limit (dBuV/m)	Margin (dB)	Detector
1	5350.000	44.93	-0.62	44.31	74.00	-29.69	peak
2 *	5350.000	34.03	-0.62	33.41	54.00	-20.59	AVG

Remarks:

1. Factor (dB/m) = Antenna Factor (dB/m)+Cable Factor (dB)-Pre-amplifier Factor
2. Margin value = Level -Limit value



Ant. No.	Ant 1 + Ant 2
Ant. Pol.	Vertical
Test Mode:	TX 802.11n(HT20) Mode 5320MHz (U-NII-2A)

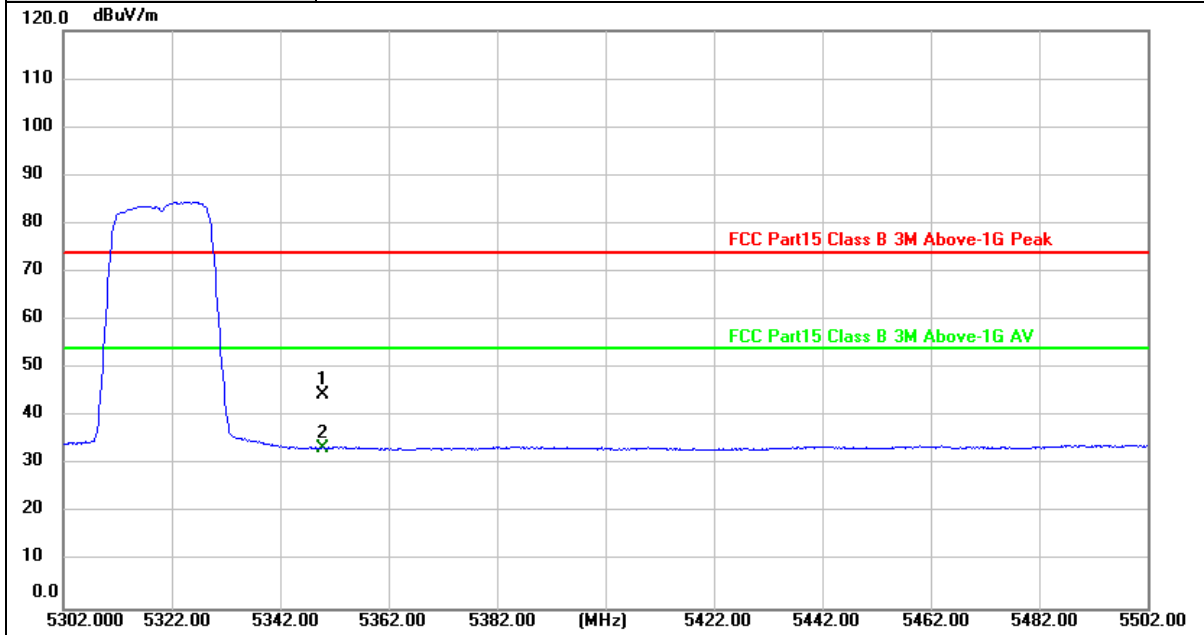

No.	Frequency (MHz)	Reading (dBuV)	Factor (dB/m)	Level (dBuV/m)	Limit (dBuV/m)	Margin (dB)	Detector
1	5350.000	45.22	-0.62	44.60	74.00	-29.40	peak
2 *	5350.000	34.10	-0.62	33.48	54.00	-20.52	AVG

Remarks:

- 1.Factor (dB/m) = Antenna Factor (dB/m)+Cable Factor (dB)-Pre-amplifier Factor
- 2.Margin value = Level -Limit value





Ant. No.	Ant 1 + Ant 2
Ant. Pol.	Horizontal
Test Mode:	TX 802.11ac(VHT20) Mode 5180MHz (U-NII-1)

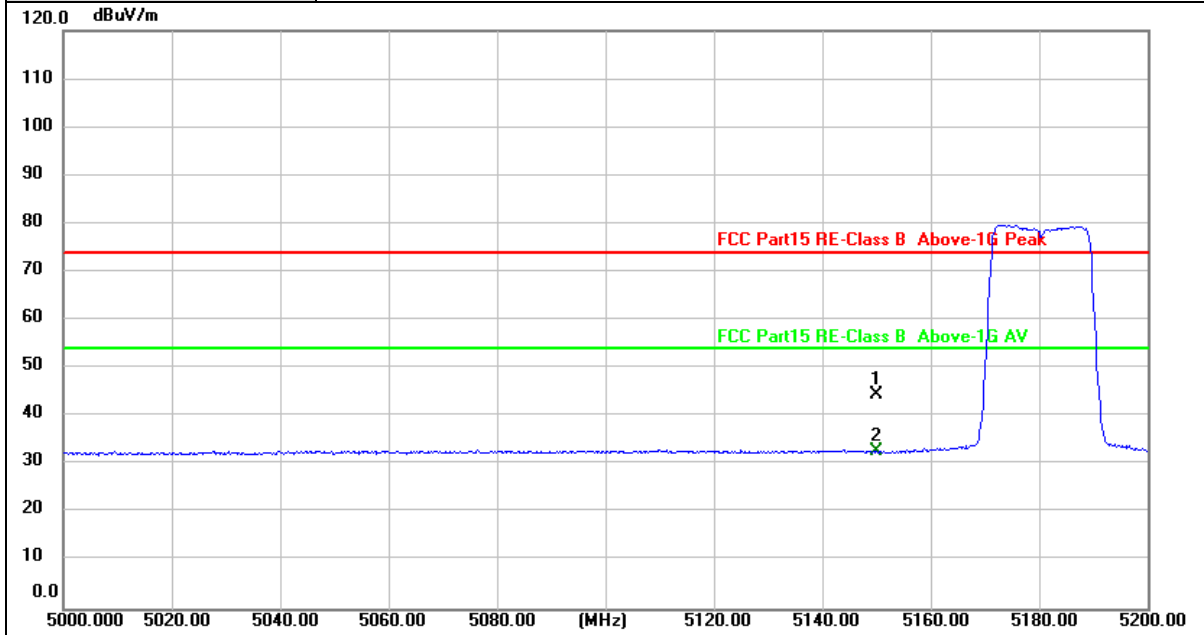

No.	Frequency (MHz)	Reading (dBuV)	Factor (dB/m)	Level (dBuV/m)	Limit (dBuV/m)	Margin (dB)	Detector
1	5150.000	45.66	-1.18	44.48	74.00	-29.52	peak
2 *	5150.000	33.99	-1.18	32.81	54.00	-21.19	AVG

Remarks:

- Factor (dB/m) = Antenna Factor (dB/m)+Cable Factor (dB)-Pre-amplifier Factor
- Margin value = Level -Limit value



Ant. No.	Ant 1 + Ant 2
Ant. Pol.	Vertical
Test Mode:	TX 802.11ac(VHT20) Mode 5180MHz (U-NII-1)

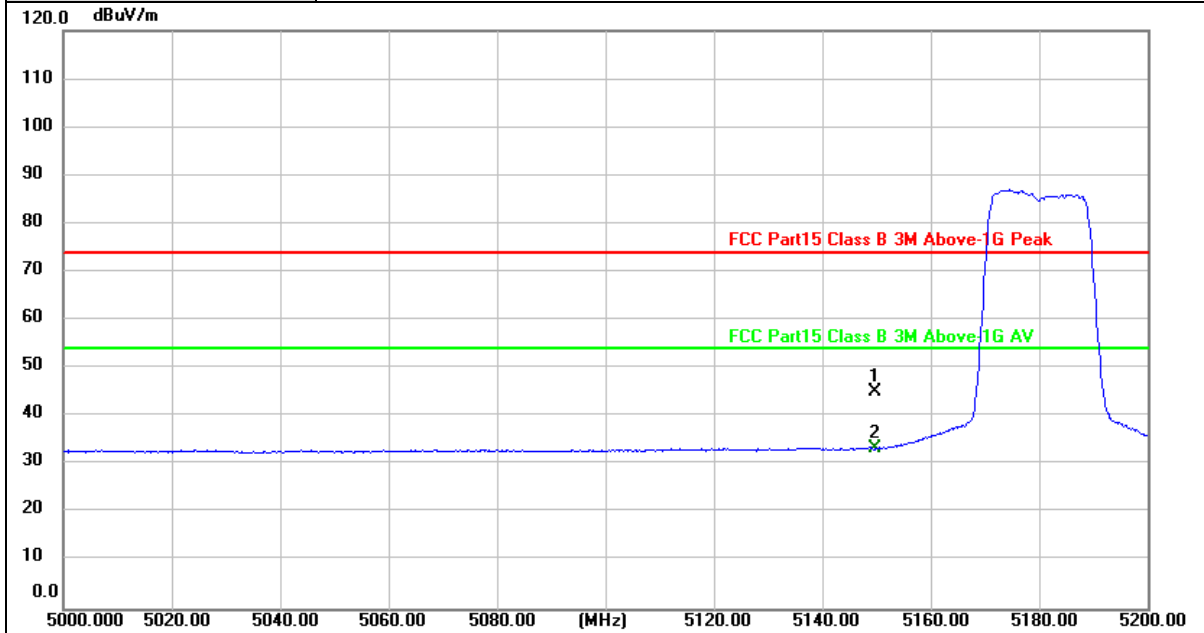

No.	Frequency (MHz)	Reading (dBuV)	Factor (dB/m)	Level (dBuV/m)	Limit (dBuV/m)	Margin (dB)	Detector
1	5150.000	46.36	-1.18	45.18	74.00	-28.82	peak
2 *	5150.000	34.75	-1.18	33.57	54.00	-20.43	AVG

Remarks:

- Factor (dB/m) = Antenna Factor (dB/m)+Cable Factor (dB)-Pre-amplifier Factor
- Margin value = Level -Limit value





Ant. No.	Ant 1 + Ant 2
Ant. Pol.	Horizontal
Test Mode:	TX 802.11ac(VHT20) Mode 5320MHz (U-NII-2A)

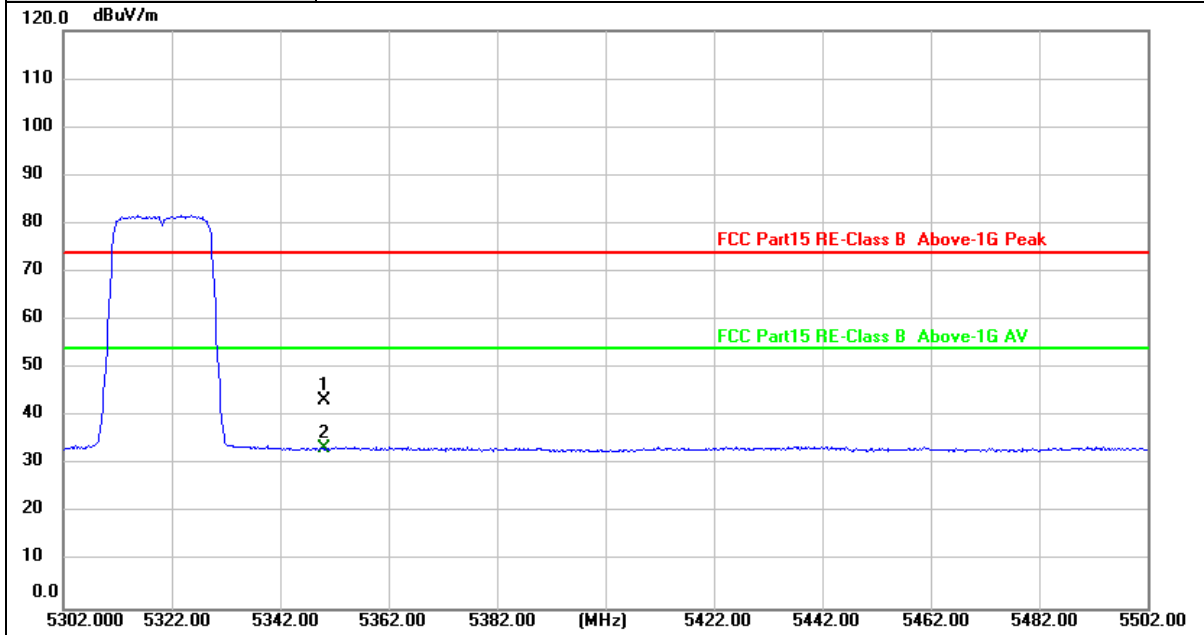

No.	Frequency (MHz)	Reading (dBuV)	Factor (dB/m)	Level (dBuV/m)	Limit (dBuV/m)	Margin (dB)	Detector
1	5350.000	43.98	-0.62	43.36	74.00	-30.64	peak
2 *	5350.000	34.16	-0.62	33.54	54.00	-20.46	AVG

Remarks:

1. Factor (dB/m) = Antenna Factor (dB/m)+Cable Factor (dB)-Pre-amplifier Factor
2. Margin value = Level -Limit value



Ant. No.	Ant 1 + Ant 2
Ant. Pol.	Vertical
Test Mode:	TX 802.11ac(VHT20) Mode 5320MHz (U-NII-2A)

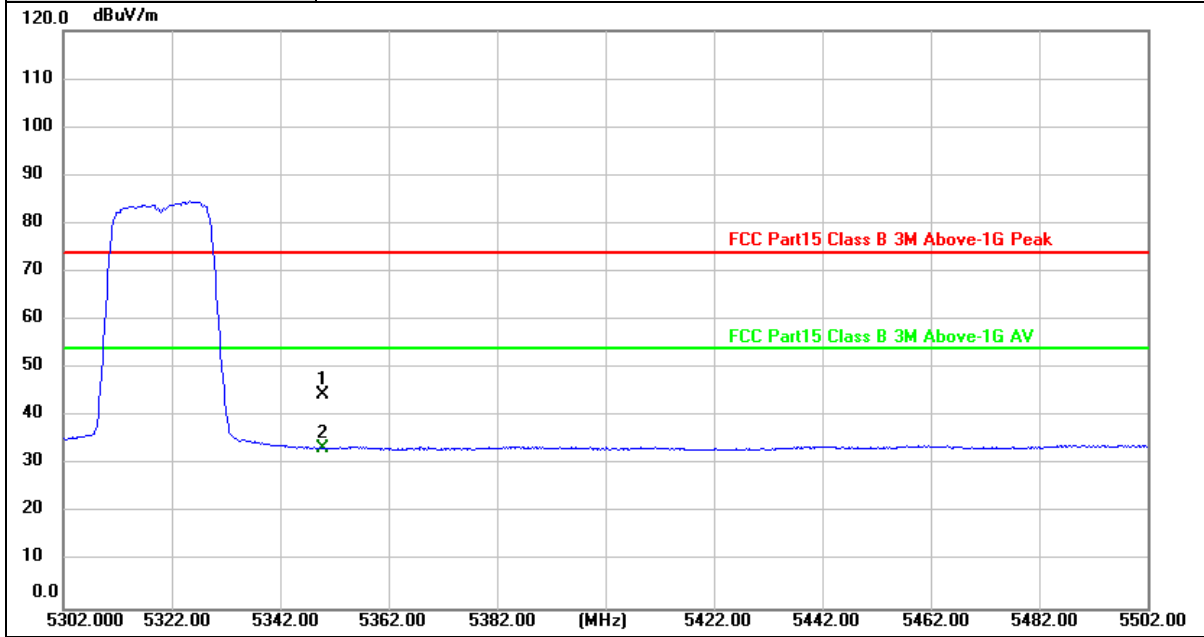

No.	Frequency (MHz)	Reading (dBuV)	Factor (dB/m)	Level (dBuV/m)	Limit (dBuV/m)	Margin (dB)	Detector
1	5350.000	45.10	-0.62	44.48	74.00	-29.52	peak
2 *	5350.000	33.97	-0.62	33.35	54.00	-20.65	AVG

Remarks:

- 1.Factor (dB/m) = Antenna Factor (dB/m)+Cable Factor (dB)-Pre-amplifier Factor
- 2.Margin value = Level -Limit value





Ant. No.	Ant 1 + Ant 2
Ant. Pol.	Horizontal
Test Mode:	TX 802.11n(HT40) Mode 5190MHz (U-NII-1)

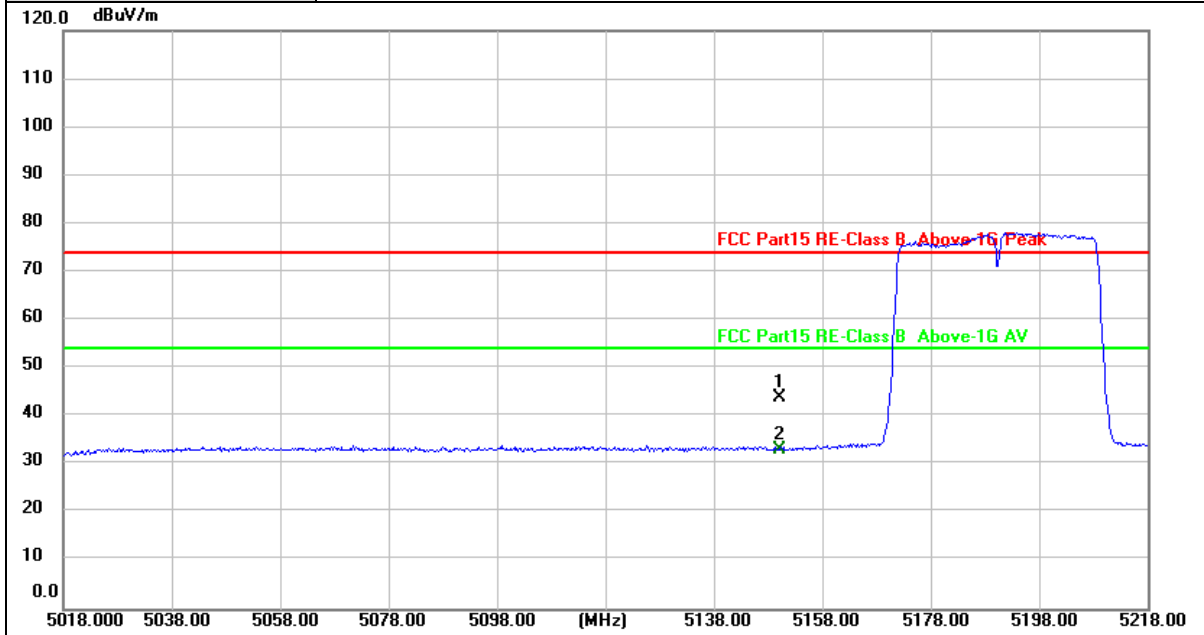

No.	Frequency (MHz)	Reading (dBuV)	Factor (dB/m)	Level (dBuV/m)	Limit (dBuV/m)	Margin (dB)	Detector
1	5150.000	45.11	-1.18	43.93	74.00	-30.07	peak
2 *	5150.000	34.31	-1.18	33.13	54.00	-20.87	AVG

Remarks:

- 1. Factor (dB/m) = Antenna Factor (dB/m)+Cable Factor (dB)-Pre-amplifier Factor
- 2. Margin value = Level -Limit value





Ant. No.	Ant 1 + Ant 2
Ant. Pol.	Vertical
Test Mode:	TX 802.11n(HT40) Mode 5190MHz (U-NII-1)

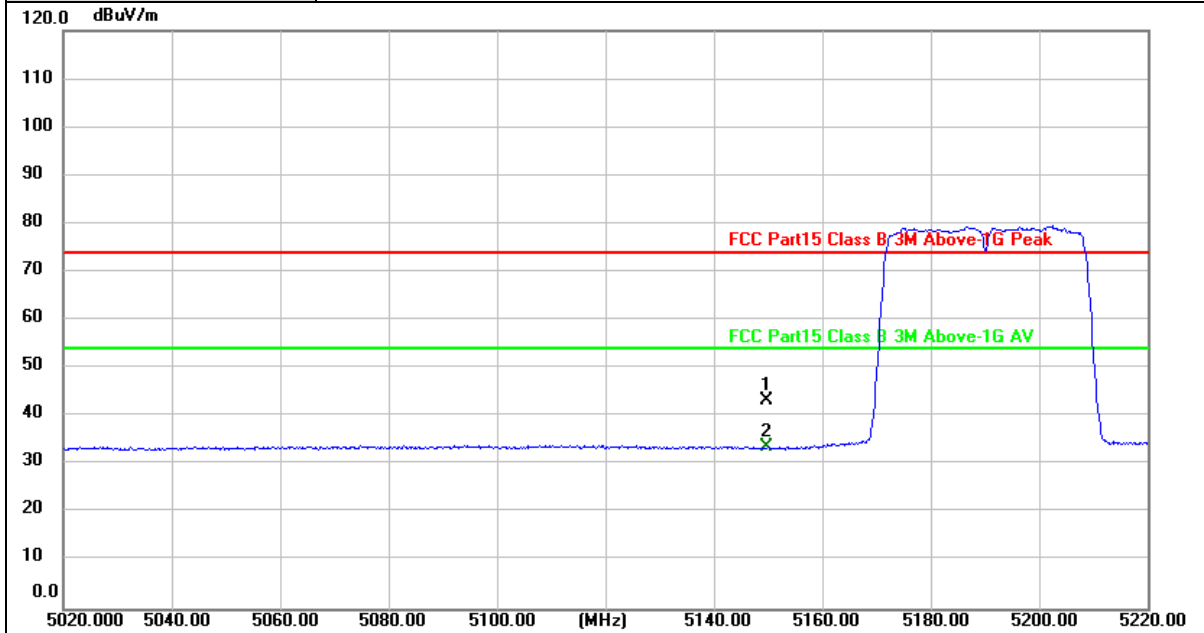

No.	Frequency (MHz)	Reading (dBuV)	Factor (dB/m)	Level (dBuV/m)	Limit (dBuV/m)	Margin (dB)	Detector
1	5150.000	44.61	-1.18	43.43	74.00	-30.57	peak
2 *	5150.000	34.95	-1.18	33.77	54.00	-20.23	AVG

Remarks:

- Factor (dB/m) = Antenna Factor (dB/m)+Cable Factor (dB)-Pre-amplifier Factor
- Margin value = Level -Limit value





Ant. No.	Ant 1 + Ant 2
Ant. Pol.	Horizontal
Test Mode:	TX 802.11n(HT40) Mode 5310MHz (U-NII-2A)

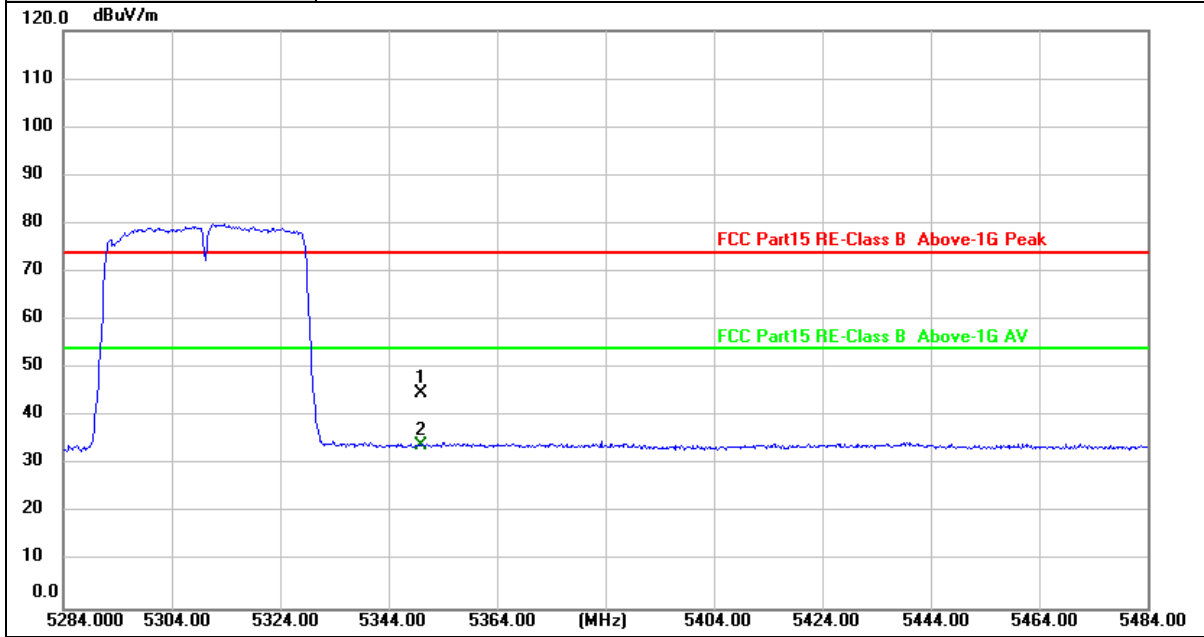

No.	Frequency (MHz)	Reading (dBuV)	Factor (dB/m)	Level (dBuV/m)	Limit (dBuV/m)	Margin (dB)	Detector
1	5350.000	45.34	-0.62	44.72	74.00	-29.28	peak
2 *	5350.000	34.78	-0.62	34.16	54.00	-19.84	AVG

Remarks:

- 1. Factor (dB/m) = Antenna Factor (dB/m)+Cable Factor (dB)-Pre-amplifier Factor
- 2. Margin value = Level -Limit value



Ant. No.	Ant 1 + Ant 2
Ant. Pol.	Vertical
Test Mode:	TX 802.11n(HT40) Mode 5310MHz (U-NII-2A)

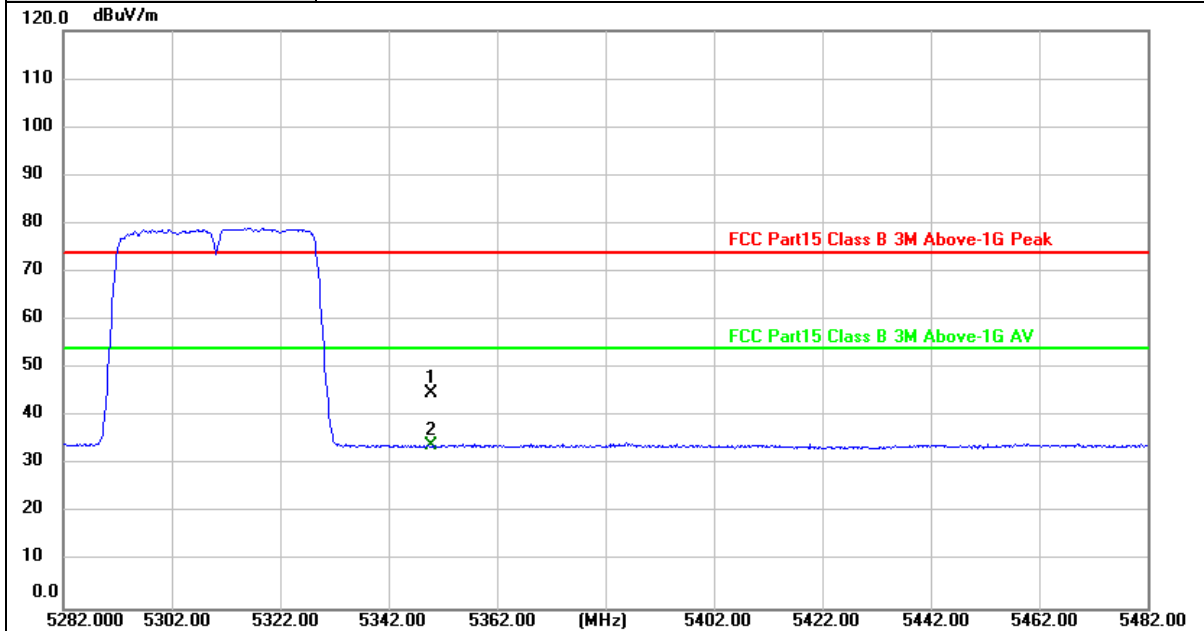

No.	Frequency (MHz)	Reading (dBuV)	Factor (dB/m)	Level (dBuV/m)	Limit (dBuV/m)	Margin (dB)	Detector
1	5350.000	45.35	-0.62	44.73	74.00	-29.27	peak
2 *	5350.000	34.55	-0.62	33.93	54.00	-20.07	AVG

Remarks:

1. Factor (dB/m) = Antenna Factor (dB/m)+Cable Factor (dB)-Pre-amplifier Factor
2. Margin value = Level -Limit value



Ant. No.	Ant 1 + Ant 2
Ant. Pol.	Horizontal
Test Mode:	TX 802.11ac(VHT40) Mode 5190MHz (U-NII-1)

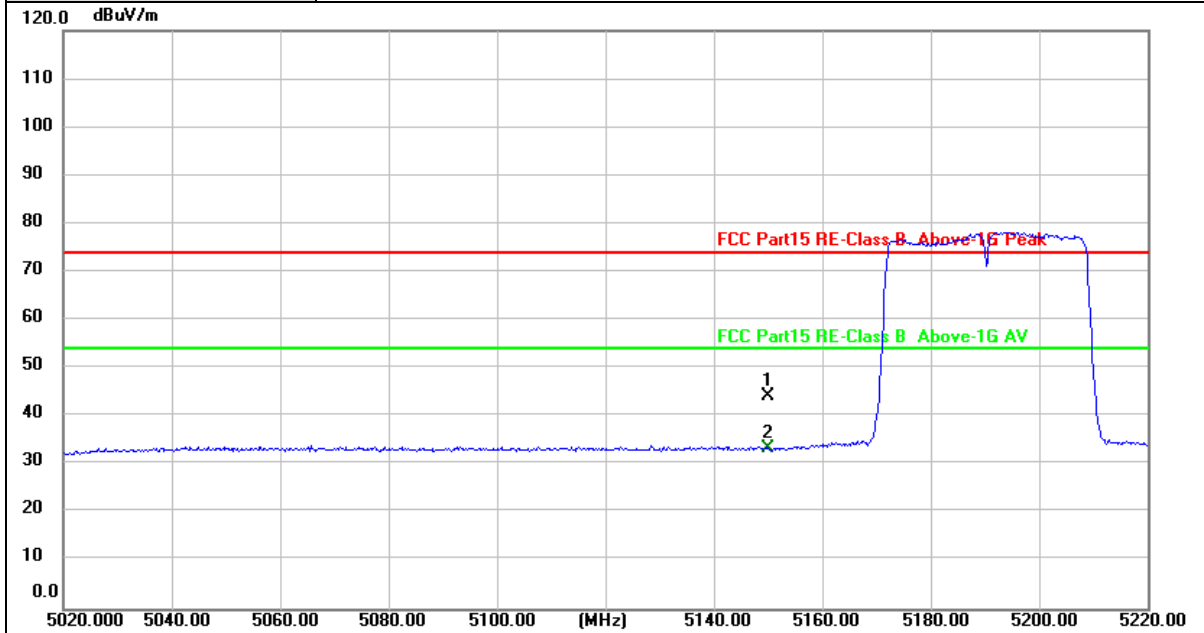

No.	Frequency (MHz)	Reading (dBuV)	Factor (dB/m)	Level (dBuV/m)	Limit (dBuV/m)	Margin (dB)	Detector
1	5150.000	45.33	-1.18	44.15	74.00	-29.85	peak
2 *	5150.000	34.60	-1.18	33.42	54.00	-20.58	AVG

Remarks:

- 1. Factor (dB/m) = Antenna Factor (dB/m)+Cable Factor (dB)-Pre-amplifier Factor
- 2. Margin value = Level -Limit value



Ant. No.	Ant 1 + Ant 2
Ant. Pol.	Vertical
Test Mode:	TX 802.11ac(VHT40) Mode 5190MHz (U-NII-1)

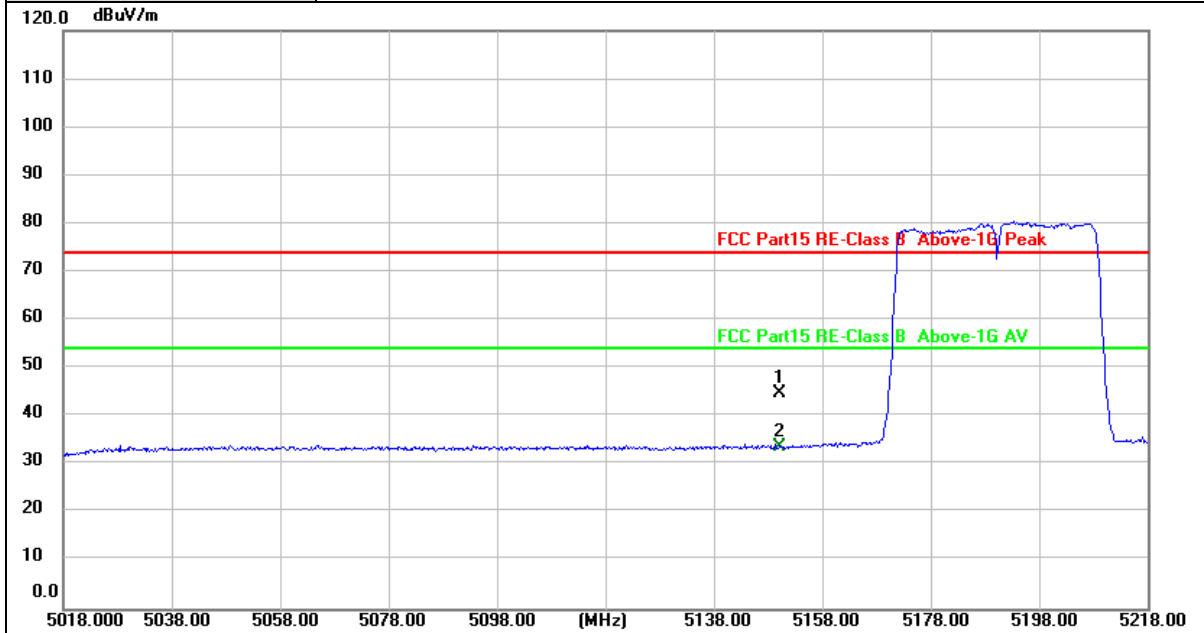

No.	Frequency (MHz)	Reading (dBuV)	Factor (dB/m)	Level (dBuV/m)	Limit (dBuV/m)	Margin (dB)	Detector
1	5150.000	46.18	-1.18	45.00	74.00	-29.00	peak
2 *	5150.000	34.83	-1.18	33.65	54.00	-20.35	AVG

Remarks:

- Factor (dB/m) = Antenna Factor (dB/m)+Cable Factor (dB)-Pre-amplifier Factor
- Margin value = Level -Limit value





Ant. No.	Ant 1 + Ant 2
Ant. Pol.	Horizontal
Test Mode:	TX 802.11ac(VHT40) Mode 5310MHz (U-NII-2A)

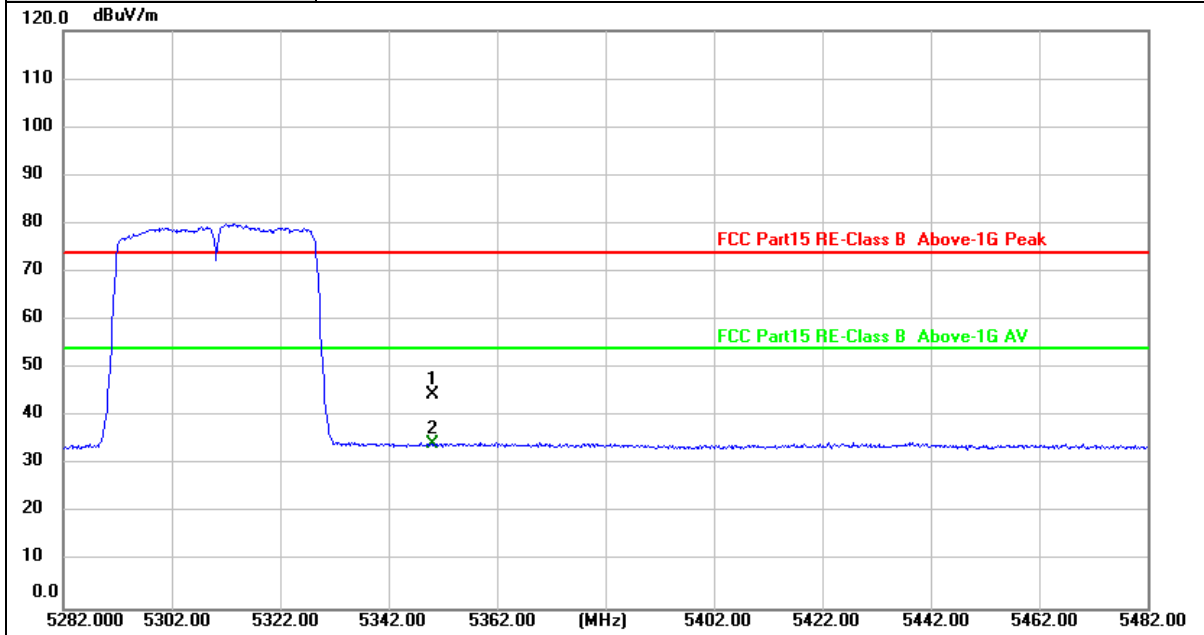

No.	Frequency (MHz)	Reading (dBuV)	Factor (dB/m)	Level (dBuV/m)	Limit (dBuV/m)	Margin (dB)	Detector
1	5350.000	45.20	-0.62	44.58	74.00	-29.42	peak
2 *	5350.000	34.87	-0.62	34.25	54.00	-19.75	AVG

Remarks:

1. Factor (dB/m) = Antenna Factor (dB/m)+Cable Factor (dB)-Pre-amplifier Factor
2. Margin value = Level -Limit value



Ant. No.	Ant 1 + Ant 2
Ant. Pol.	Vertical
Test Mode:	TX 802.11ac(VHT40) Mode 5310MHz (U-NII-2A)

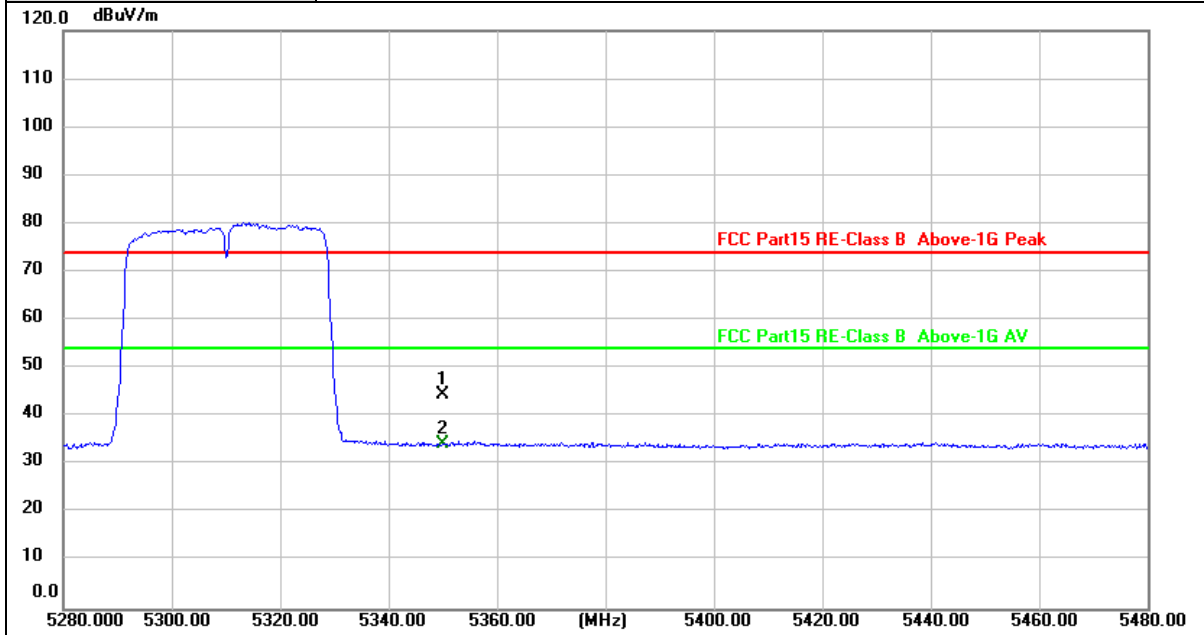

No.	Frequency (MHz)	Reading (dBuV)	Factor (dB/m)	Level (dBuV/m)	Limit (dBuV/m)	Margin (dB)	Detector
1	5350.000	45.10	-0.62	44.48	74.00	-29.52	peak
2 *	5350.000	34.97	-0.62	34.35	54.00	-19.65	AVG

Remarks:

- Factor (dB/m) = Antenna Factor (dB/m)+Cable Factor (dB)-Pre-amplifier Factor
- Margin value = Level -Limit value



Ant. No.	Ant 1 + Ant 2
Ant. Pol.	Horizontal
Test Mode:	TX 802.11ac(VHT80) Mode 5210MHz (U-NII-1)

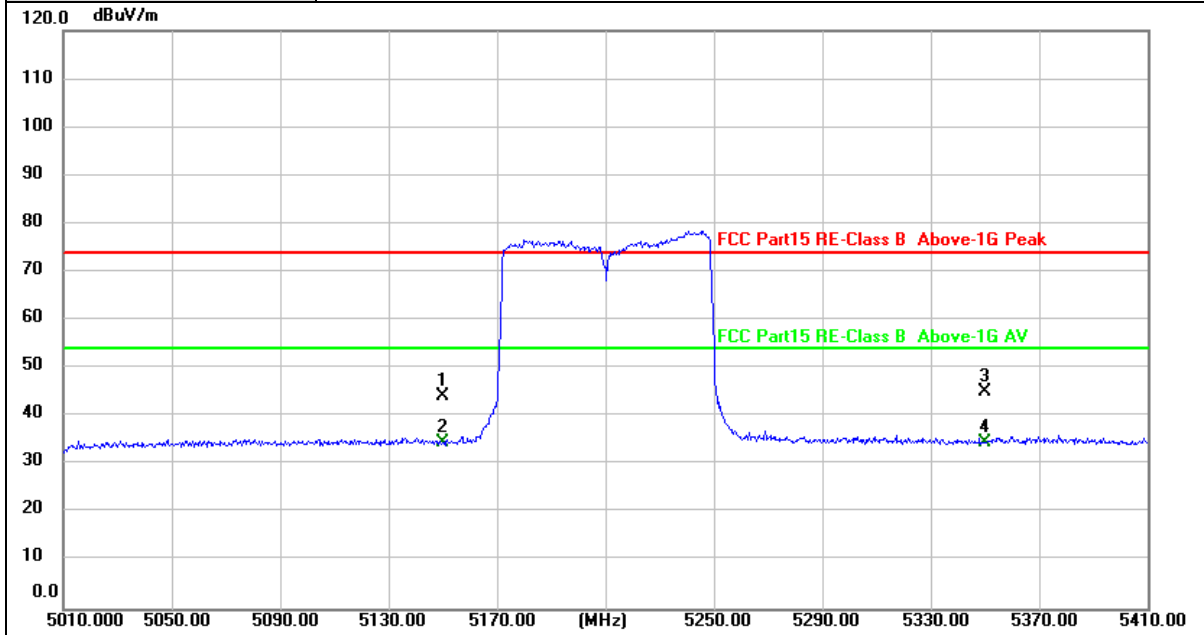

No.	Frequency (MHz)	Reading (dBuV)	Factor (dB/m)	Level (dBuV/m)	Limit (dBuV/m)	Margin (dB)	Detector
1	5150.000	45.40	-1.18	44.22	74.00	-29.78	peak
2 *	5150.000	35.96	-1.18	34.78	54.00	-19.22	AVG
3	5350.000	45.75	-0.62	45.13	74.00	-28.87	peak
4	5350.000	35.30	-0.62	34.68	54.00	-19.32	AVG

Remarks:

- 1. Factor (dB/m) = Antenna Factor (dB/m)+Cable Factor (dB)-Pre-amplifier Factor
- 2. Margin value = Level -Limit value





Ant. No.	Ant 1 + Ant 2
Ant. Pol.	Vertical
Test Mode:	TX 802.11ac(VHT80) Mode 5210MHz (U-NII-1)

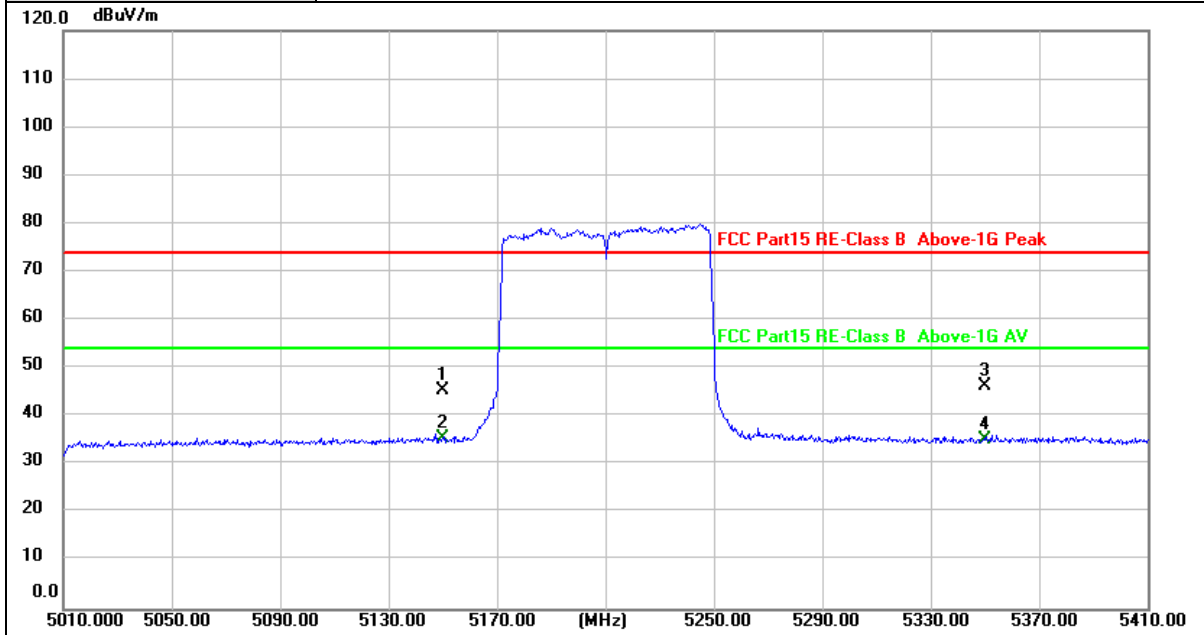

No.	Frequency (MHz)	Reading (dBuV)	Factor (dB/m)	Level (dBuV/m)	Limit (dBuV/m)	Margin (dB)	Detector
1	5150.000	46.72	-1.18	45.54	74.00	-28.46	peak
2 *	5150.000	36.83	-1.18	35.65	54.00	-18.35	AVG
3	5350.000	46.83	-0.62	46.21	74.00	-27.79	peak
4	5350.000	35.77	-0.62	35.15	54.00	-18.85	AVG

Remarks:

1. Factor (dB/m) = Antenna Factor (dB/m)+Cable Factor (dB)-Pre-amplifier Factor
2. Margin value = Level -Limit value



Ant. No.	Ant 1 + Ant 2
Ant. Pol.	Horizontal
Test Mode:	TX 802.11ac(VHT80) Mode 5290MHz (U-NII-2A)

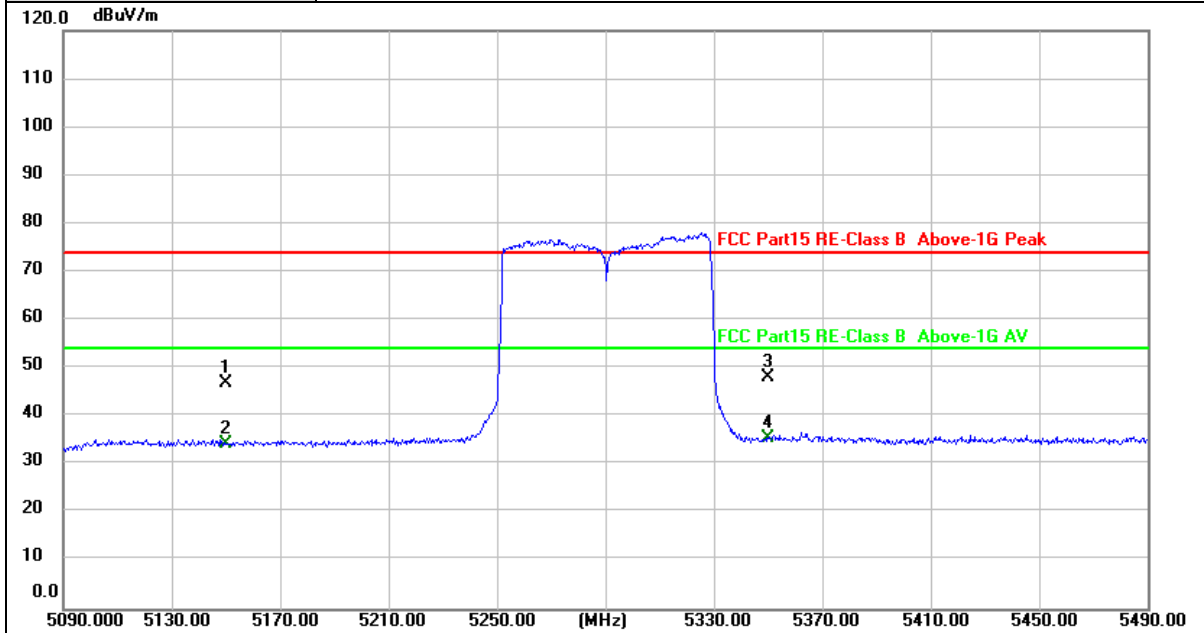

No.	Frequency (MHz)	Reading (dBuV)	Factor (dB/m)	Level (dBuV/m)	Limit (dBuV/m)	Margin (dB)	Detector
1	5150.000	48.04	-1.18	46.86	74.00	-27.14	peak
2	5150.000	35.65	-1.18	34.47	54.00	-19.53	AVG
3	5350.000	48.73	-0.62	48.11	74.00	-25.89	peak
4 *	5350.000	36.20	-0.62	35.58	54.00	-18.42	AVG

Remarks:

- 1. Factor (dB/m) = Antenna Factor (dB/m)+Cable Factor (dB)-Pre-amplifier Factor
- 2. Margin value = Level -Limit value



Ant. No.	Ant 1 + Ant 2
Ant. Pol.	Vertical
Test Mode:	TX 802.11ac(VHT80) Mode 5290MHz (U-NII-2A)

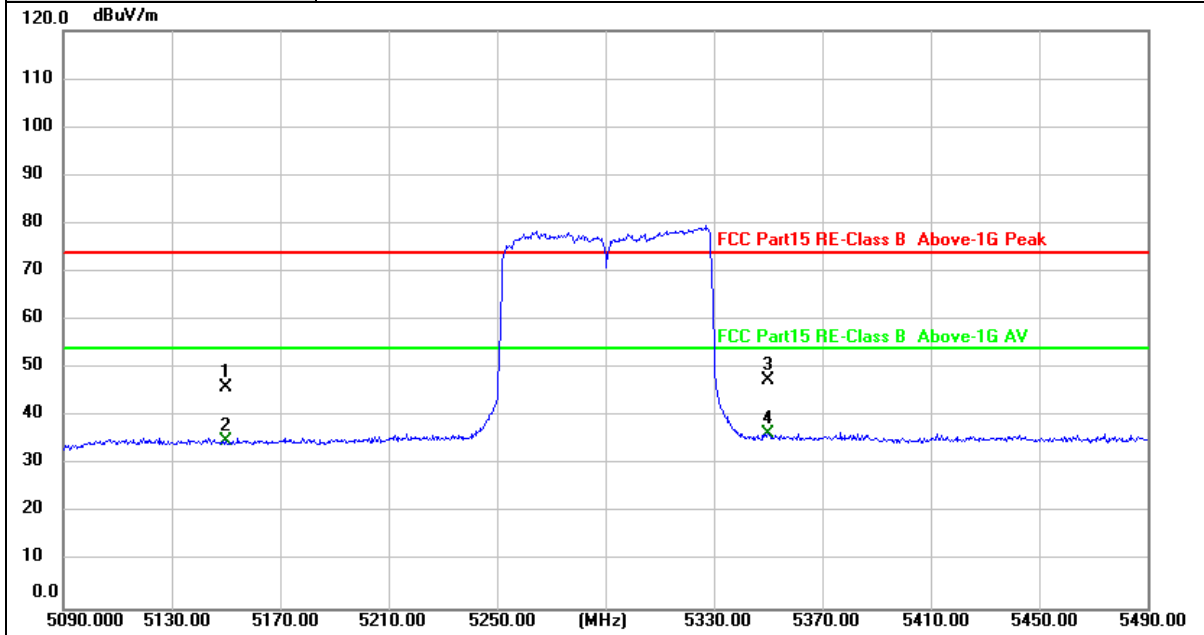

No.	Frequency (MHz)	Reading (dBuV)	Factor (dB/m)	Level (dBuV/m)	Limit (dBuV/m)	Margin (dB)	Detector
1	5150.000	47.20	-1.18	46.02	74.00	-27.98	peak
2	5150.000	36.25	-1.18	35.07	54.00	-18.93	AVG
3	5350.000	48.24	-0.62	47.62	74.00	-26.38	peak
4 *	5350.000	36.99	-0.62	36.37	54.00	-17.63	AVG

Remarks:

1. Factor (dB/m) = Antenna Factor (dB/m)+Cable Factor (dB)-Pre-amplifier Factor
2. Margin value = Level -Limit value



Ant. No.	Ant 2
Ant. Pol.	Horizontal
Test Mode:	TX 802.11a Mode 5500MHz (U-NII-2C)

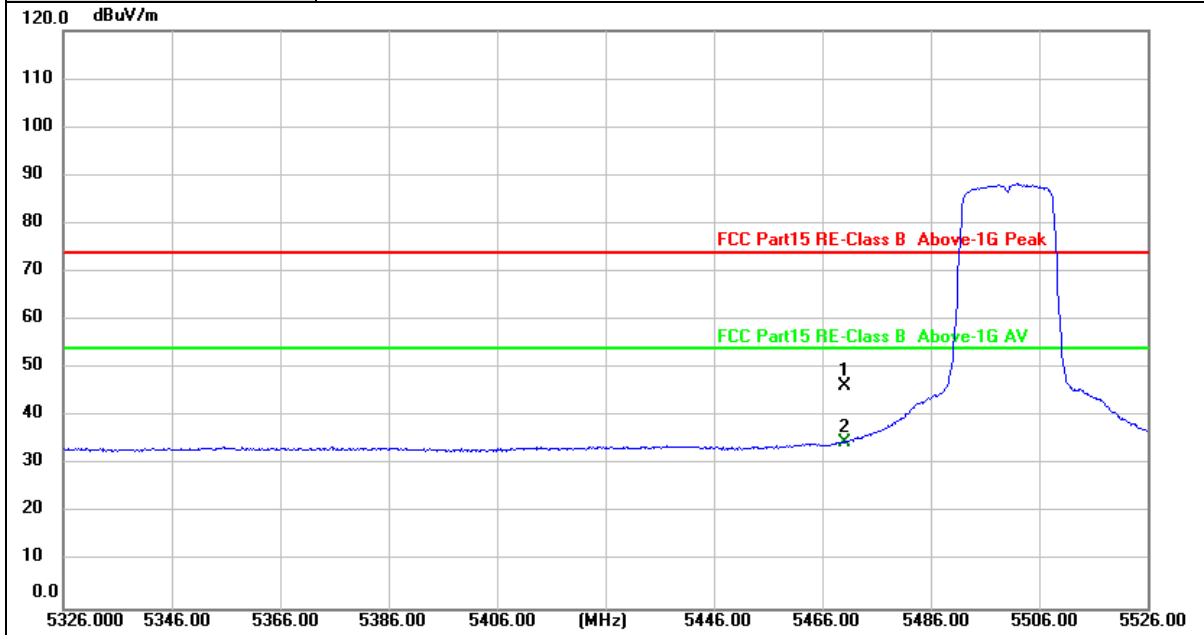

No.	Frequency (MHz)	Reading (dBuV)	Factor (dB/m)	Level (dBuV/m)	Limit (dBuV/m)	Margin (dB)	Detector
1	5470.000	46.68	-0.28	46.40	74.00	-27.60	peak
2 *	5470.000	34.88	-0.28	34.60	54.00	-19.40	AVG

Remarks:

1. Factor (dB/m) = Antenna Factor (dB/m)+Cable Factor (dB)-Pre-amplifier Factor
2. Margin value = Level -Limit value



Ant. No.	Ant 2
Ant. Pol.	Vertical
Test Mode:	TX 802.11a Mode 5500MHz (U-NII-2C)

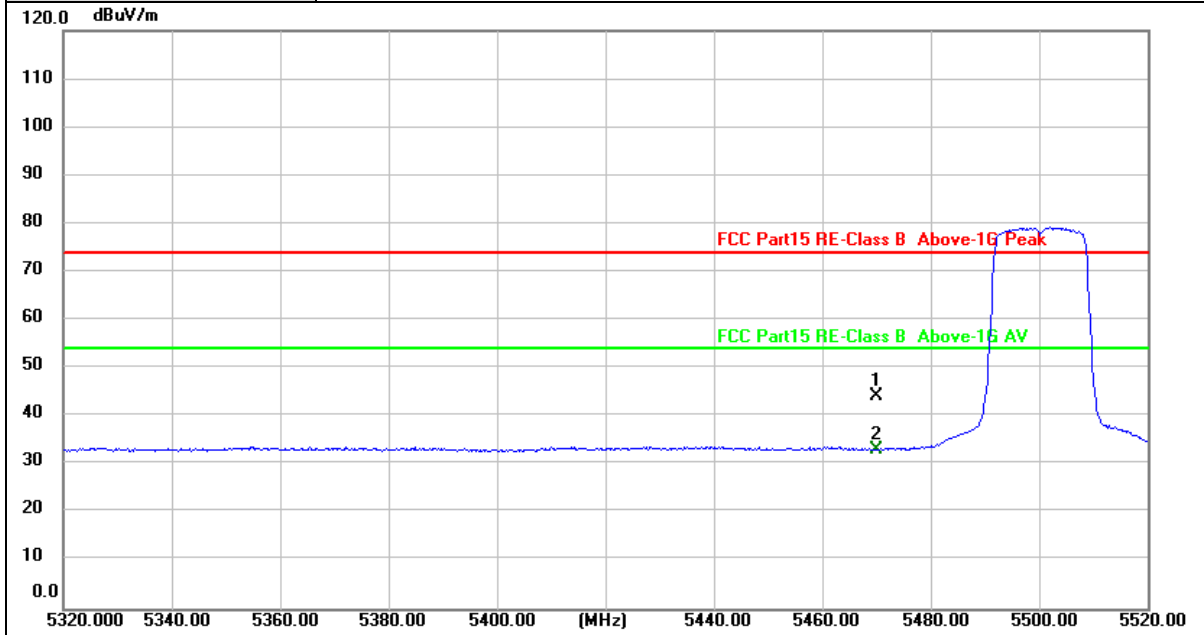

No.	Frequency (MHz)	Reading (dBuV)	Factor (dB/m)	Level (dBuV/m)	Limit (dBuV/m)	Margin (dB)	Detector
1	5470.000	44.48	-0.28	44.20	74.00	-29.80	peak
2 *	5470.000	33.50	-0.28	33.22	54.00	-20.78	AVG

Remarks:

- Factor (dB/m) = Antenna Factor (dB/m)+Cable Factor (dB)-Pre-amplifier Factor
- Margin value = Level -Limit value



Ant. No.	Ant 2
Ant. Pol.	Horizontal
Test Mode:	TX 802.11a Mode 5700MHz (U-NII-2C)

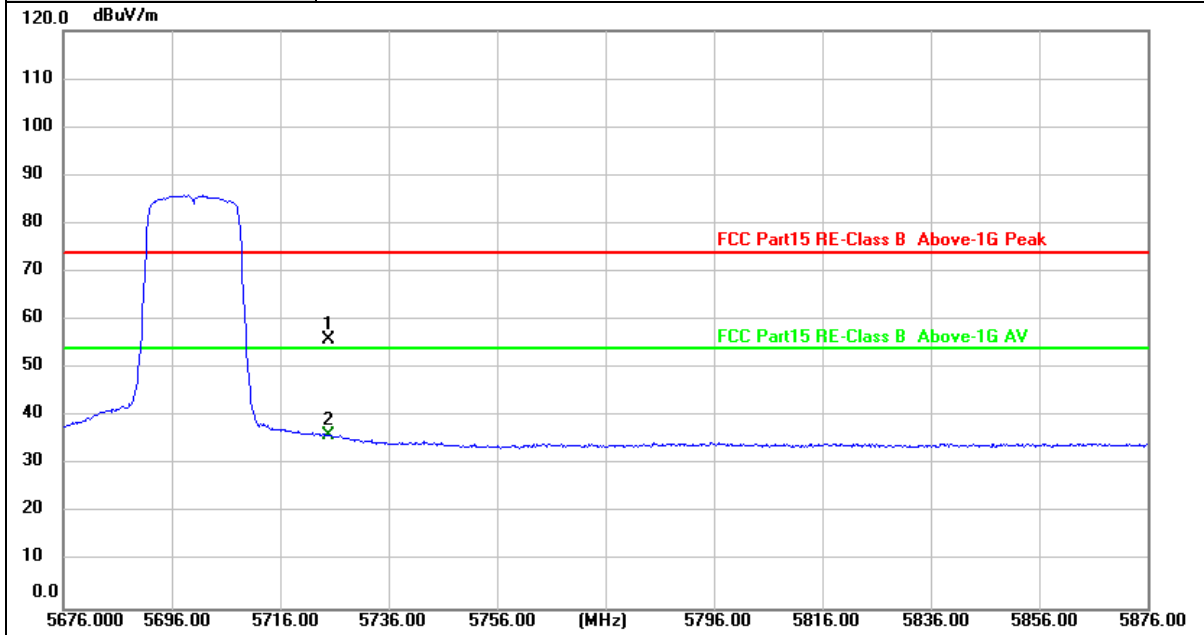

No.	Frequency (MHz)	Reading (dBuV)	Factor (dB/m)	Level (dBuV/m)	Limit (dBuV/m)	Margin (dB)	Detector
1	5725.000	55.49	0.39	55.88	74.00	-18.12	peak
2 *	5725.000	35.79	0.39	36.18	54.00	-17.82	AVG

Remarks:

- 1. Factor (dB/m) = Antenna Factor (dB/m)+Cable Factor (dB)-Pre-amplifier Factor
- 2. Margin value = Level -Limit value



Ant. No.	Ant 2
Ant. Pol.	Vertical
Test Mode:	TX 802.11a Mode 5700MHz (U-NII-2C)

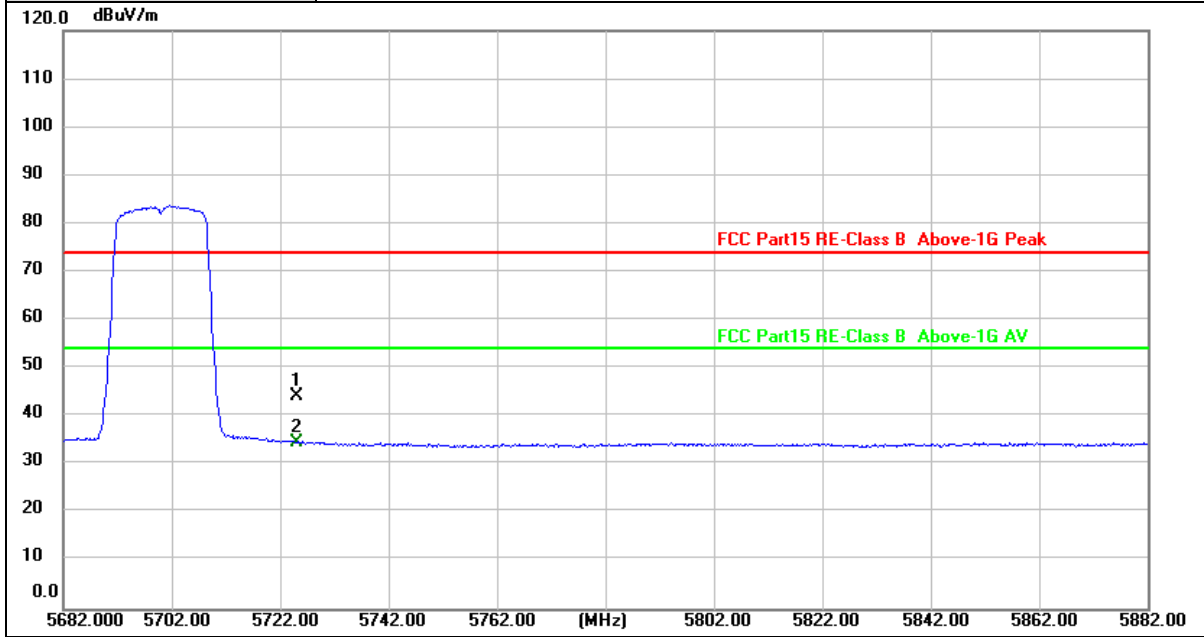

No.	Frequency (MHz)	Reading (dBuV)	Factor (dB/m)	Level (dBuV/m)	Limit (dBuV/m)	Margin (dB)	Detector
1	5725.000	43.78	0.39	44.17	74.00	-29.83	peak
2 *	5725.000	34.25	0.39	34.64	54.00	-19.36	AVG

Remarks:

- 1. Factor (dB/m) = Antenna Factor (dB/m)+Cable Factor (dB)-Pre-amplifier Factor
- 2. Margin value = Level -Limit value



Ant. No.	Ant 1 + Ant 2
Ant. Pol.	Horizontal
Test Mode:	TX 802.11n(HT20) Mode 5500MHz (U-NII-2C)

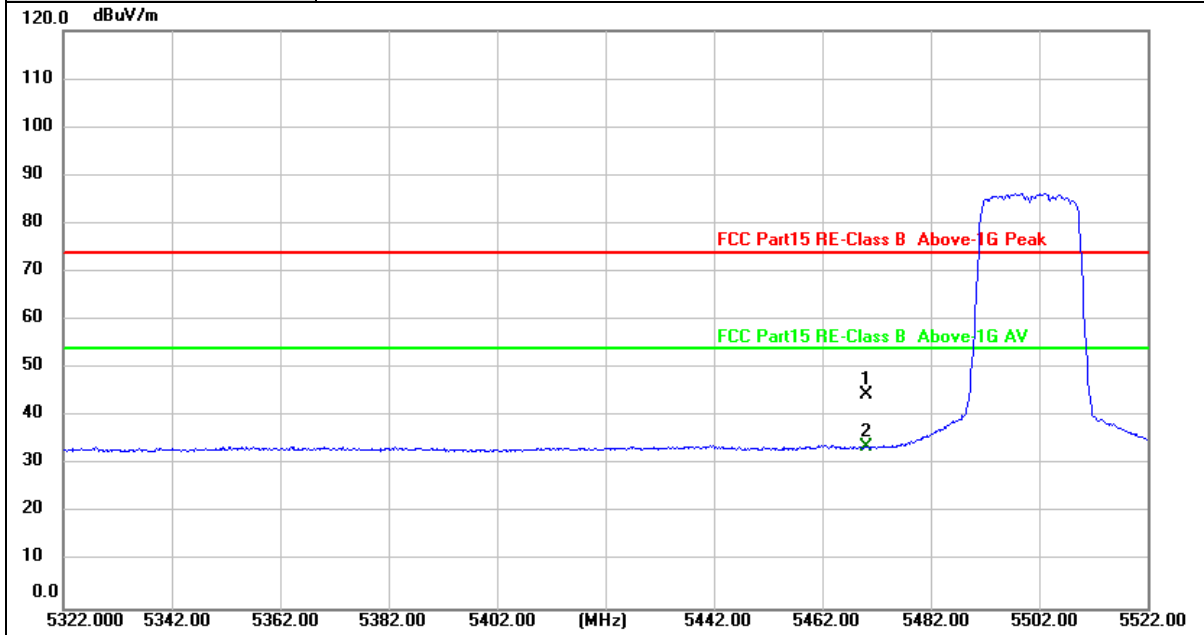

No.	Frequency (MHz)	Reading (dBuV)	Factor (dB/m)	Level (dBuV/m)	Limit (dBuV/m)	Margin (dB)	Detector
1	5470.000	44.96	-0.28	44.68	74.00	-29.32	peak
2 *	5470.000	33.90	-0.28	33.62	54.00	-20.38	AVG

Remarks:

- 1. Factor (dB/m) = Antenna Factor (dB/m)+Cable Factor (dB)-Pre-amplifier Factor
- 2. Margin value = Level -Limit value



Ant. No.	Ant 1 + Ant 2
Ant. Pol.	Vertical
Test Mode:	TX 802.11n(HT20) Mode 5500MHz (U-NII-2C)

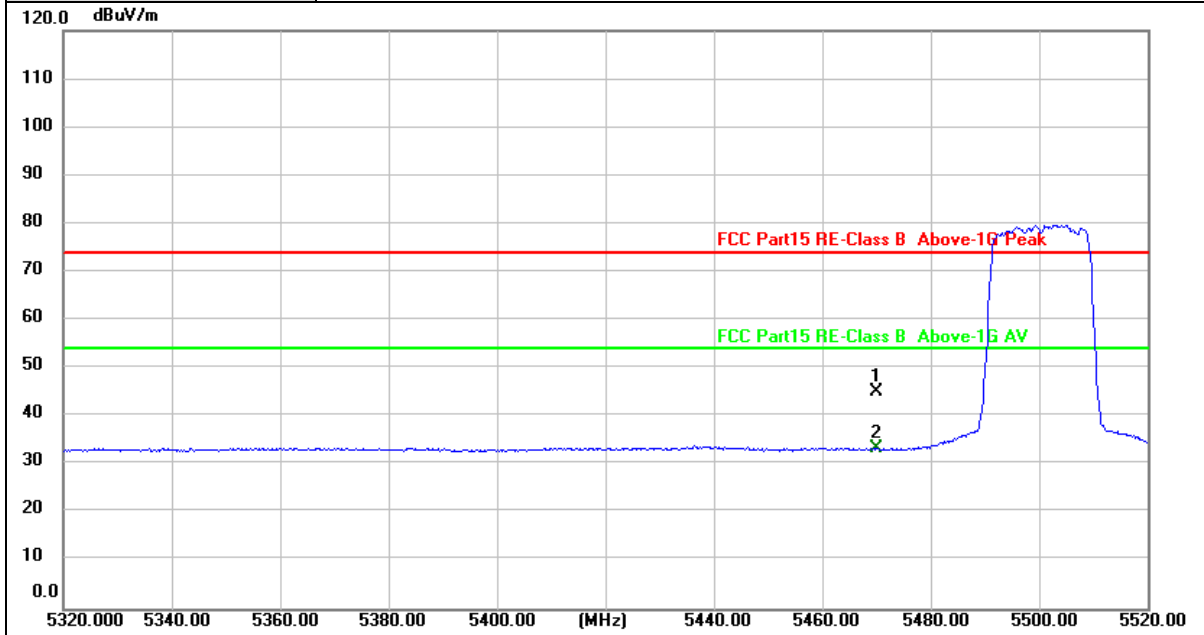

No.	Frequency (MHz)	Reading (dBuV)	Factor (dB/m)	Level (dBuV/m)	Limit (dBuV/m)	Margin (dB)	Detector
1	5470.000	45.41	-0.28	45.13	74.00	-28.87	peak
2 *	5470.000	33.63	-0.28	33.35	54.00	-20.65	AVG

Remarks:

- 1. Factor (dB/m) = Antenna Factor (dB/m)+Cable Factor (dB)-Pre-amplifier Factor
- 2. Margin value = Level -Limit value



Ant. No.	Ant 1 + Ant 2
Ant. Pol.	Horizontal
Test Mode:	TX 802.11n(HT20) Mode 5700MHz (U-NII-2C)

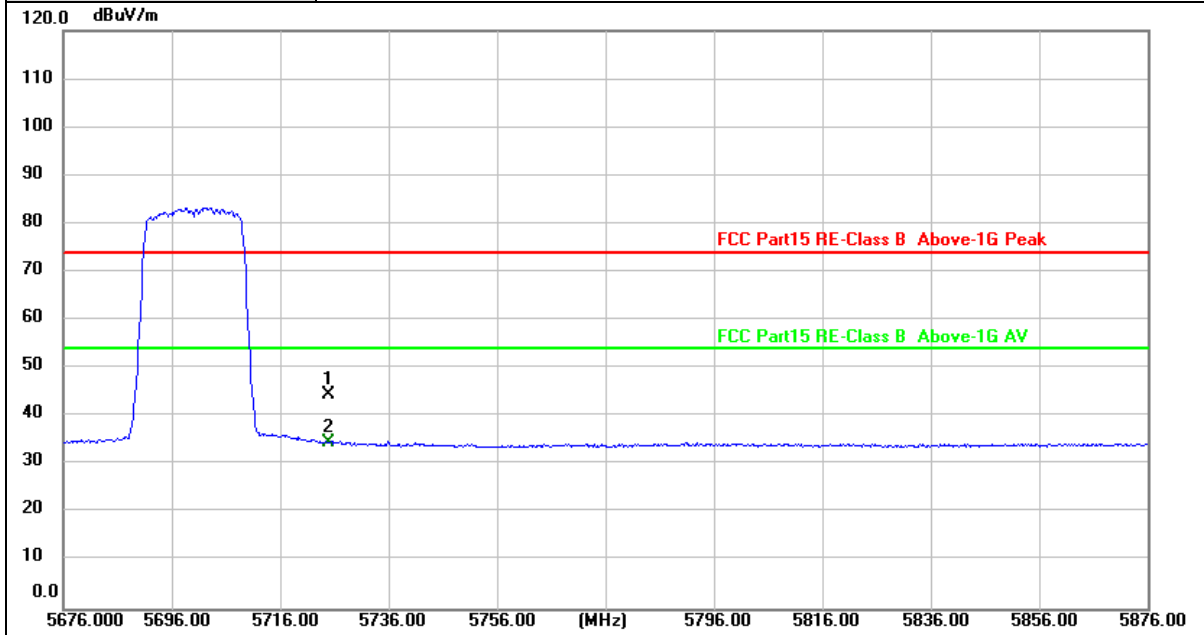

No.	Frequency (MHz)	Reading (dBuV)	Factor (dB/m)	Level (dBuV/m)	Limit (dBuV/m)	Margin (dB)	Detector
1	5725.000	44.05	0.39	44.44	74.00	-29.56	peak
2 *	5725.000	34.17	0.39	34.56	54.00	-19.44	AVG

Remarks:

- 1. Factor (dB/m) = Antenna Factor (dB/m)+Cable Factor (dB)-Pre-amplifier Factor
- 2. Margin value = Level -Limit value



Ant. No.	Ant 1 + Ant 2
Ant. Pol.	Vertical
Test Mode:	TX 802.11n(HT20) Mode 5700MHz (U-NII-2C)

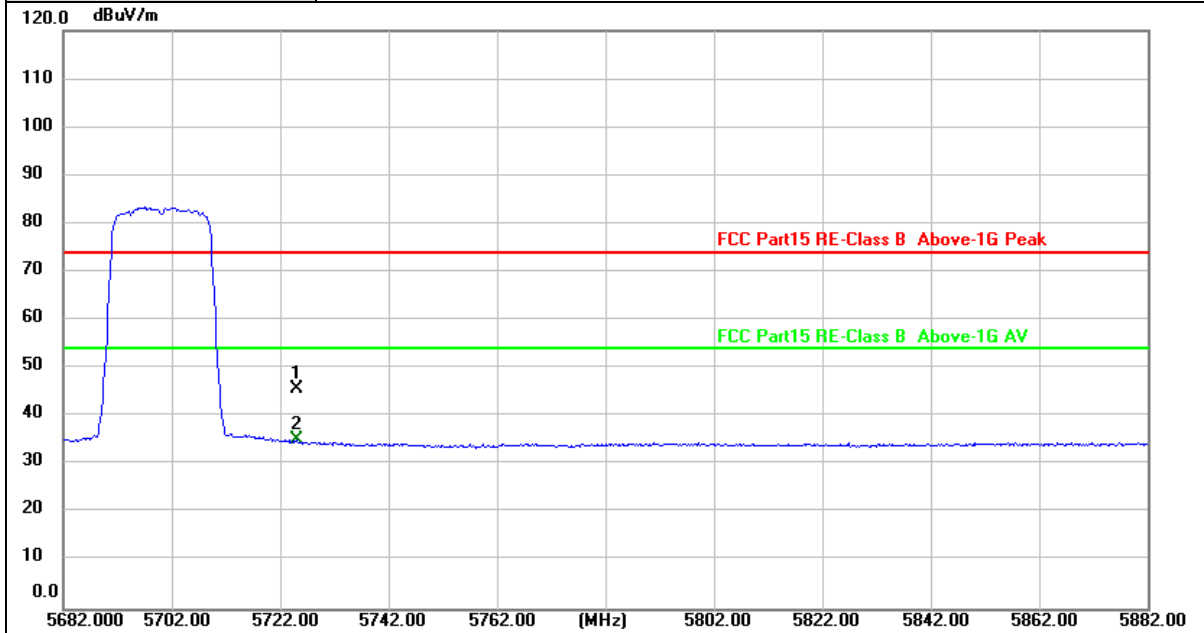

No.	Frequency (MHz)	Reading (dBuV)	Factor (dB/m)	Level (dBuV/m)	Limit (dBuV/m)	Margin (dB)	Detector
1	5725.000	45.42	0.39	45.81	74.00	-28.19	peak
2 *	5725.000	34.74	0.39	35.13	54.00	-18.87	AVG

Remarks:

1. Factor (dB/m) = Antenna Factor (dB/m)+Cable Factor (dB)-Pre-amplifier Factor
2. Margin value = Level -Limit value





Ant. No.	Ant 1 + Ant 2
Ant. Pol.	Horizontal
Test Mode:	TX 802.11ac(VHT20) Mode 5500MHz (U-NII-2C)

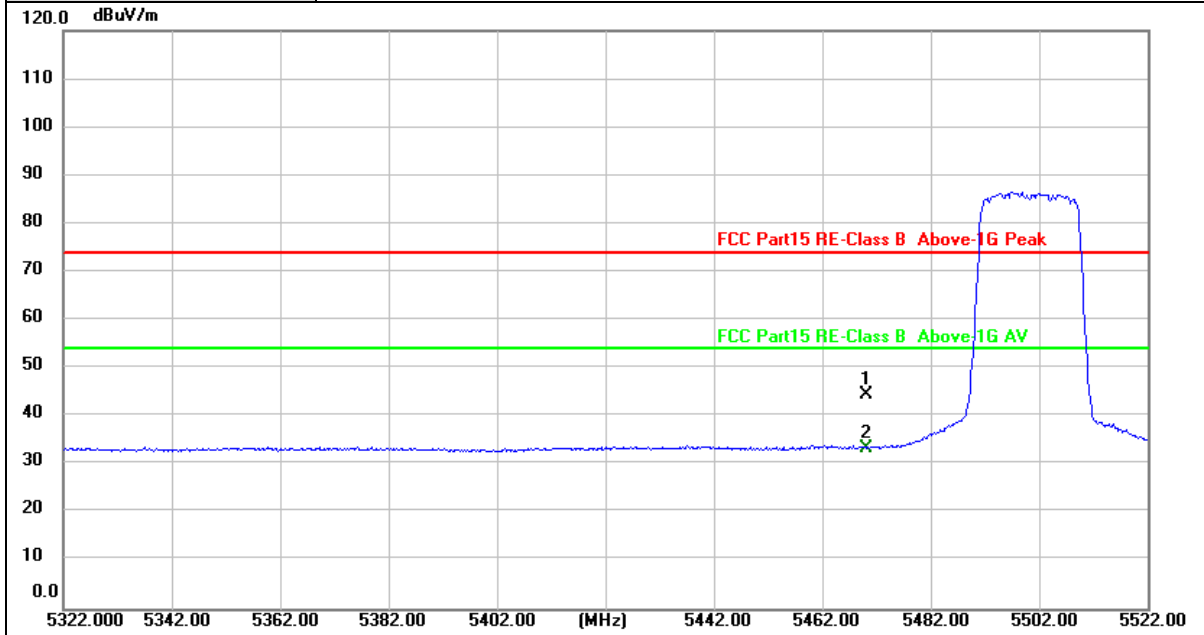

No.	Frequency (MHz)	Reading (dBuV)	Factor (dB/m)	Level (dBuV/m)	Limit (dBuV/m)	Margin (dB)	Detector
1	5470.000	44.86	-0.28	44.58	74.00	-29.42	peak
2 *	5470.000	33.80	-0.28	33.52	54.00	-20.48	AVG

Remarks:

- 1. Factor (dB/m) = Antenna Factor (dB/m)+Cable Factor (dB)-Pre-amplifier Factor
- 2. Margin value = Level -Limit value





Ant. No.	Ant 1 + Ant 2
Ant. Pol.	Vertical
Test Mode:	TX 802.11ac(VHT20) Mode 5500MHz (U-NII-2C)

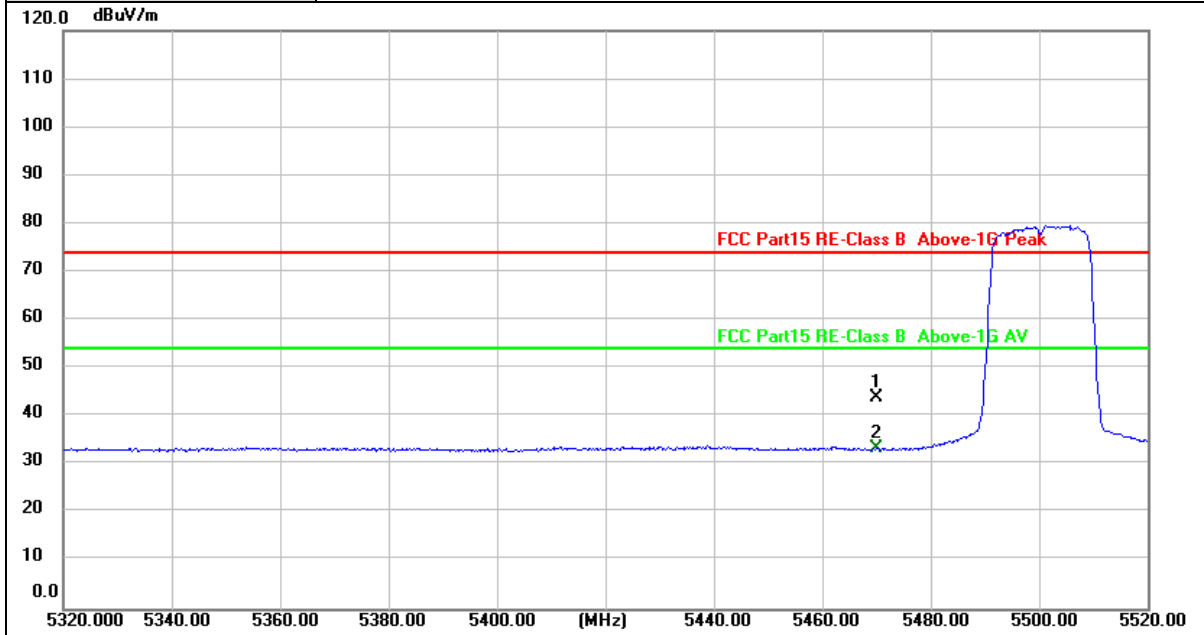

No.	Frequency (MHz)	Reading (dBuV)	Factor (dB/m)	Level (dBuV/m)	Limit (dBuV/m)	Margin (dB)	Detector
1	5470.000	44.30	-0.28	44.02	74.00	-29.98	peak
2 *	5470.000	33.77	-0.28	33.49	54.00	-20.51	AVG

Remarks:

- Factor (dB/m) = Antenna Factor (dB/m)+Cable Factor (dB)-Pre-amplifier Factor
- Margin value = Level -Limit value





Ant. No.	Ant 1 + Ant 2
Ant. Pol.	Horizontal
Test Mode:	TX 802.11ac(VHT20) Mode 5700MHz (U-NII-2C)

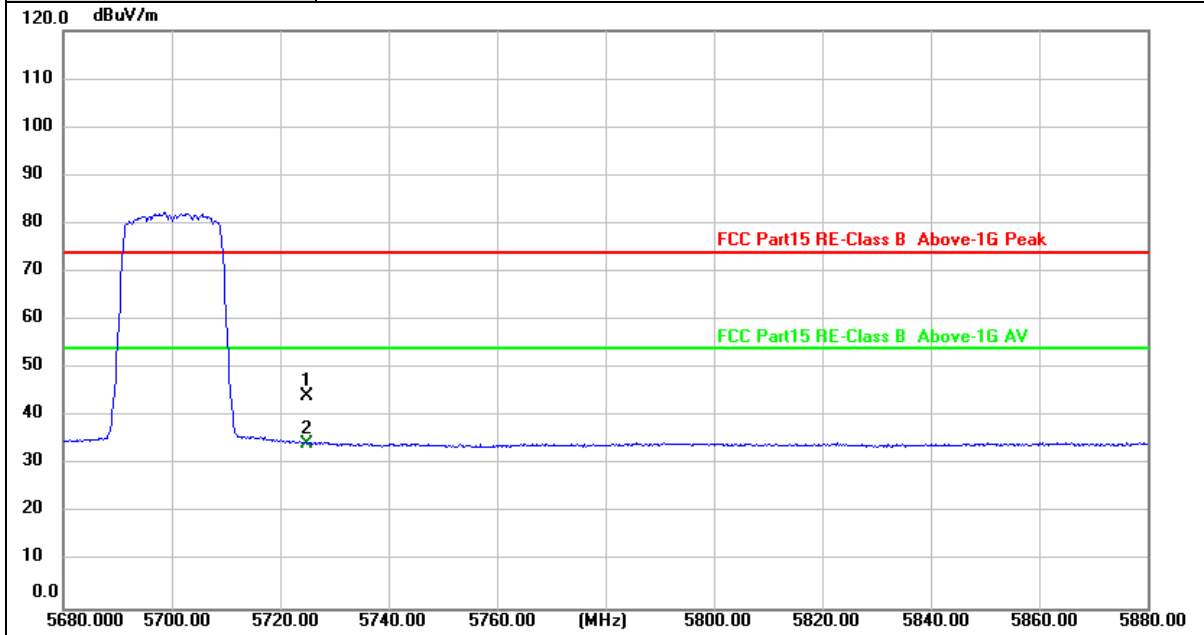

No.	Frequency (MHz)	Reading (dBuV)	Factor (dB/m)	Level (dBuV/m)	Limit (dBuV/m)	Margin (dB)	Detector
1	5725.000	43.98	0.39	44.37	74.00	-29.63	peak
2 *	5725.000	34.05	0.39	34.44	54.00	-19.56	AVG

Remarks:

- 1. Factor (dB/m) = Antenna Factor (dB/m)+Cable Factor (dB)-Pre-amplifier Factor
- 2. Margin value = Level -Limit value



Ant. No.	Ant 1 + Ant 2
Ant. Pol.	Vertical
Test Mode:	TX 802.11ac(VHT20) Mode 5700MHz (U-NII-2C)

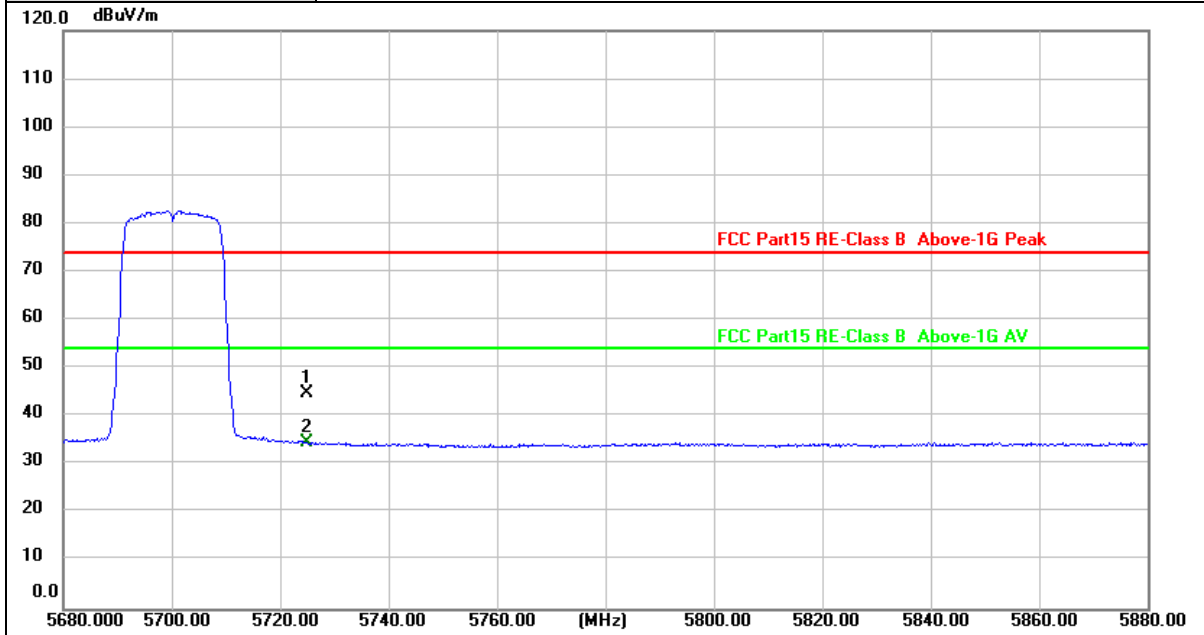

No.	Frequency (MHz)	Reading (dBuV)	Factor (dB/m)	Level (dBuV/m)	Limit (dBuV/m)	Margin (dB)	Detector
1	5725.000	44.37	0.39	44.76	74.00	-29.24	peak
2 *	5725.000	34.24	0.39	34.63	54.00	-19.37	AVG

Remarks:

1. Factor (dB/m) = Antenna Factor (dB/m)+Cable Factor (dB)-Pre-amplifier Factor
2. Margin value = Level -Limit value



Ant. No.	Ant 1 + Ant 2
Ant. Pol.	Horizontal
Test Mode:	TX 802.11n(HT40) Mode 5510MHz (U-NII-2C)

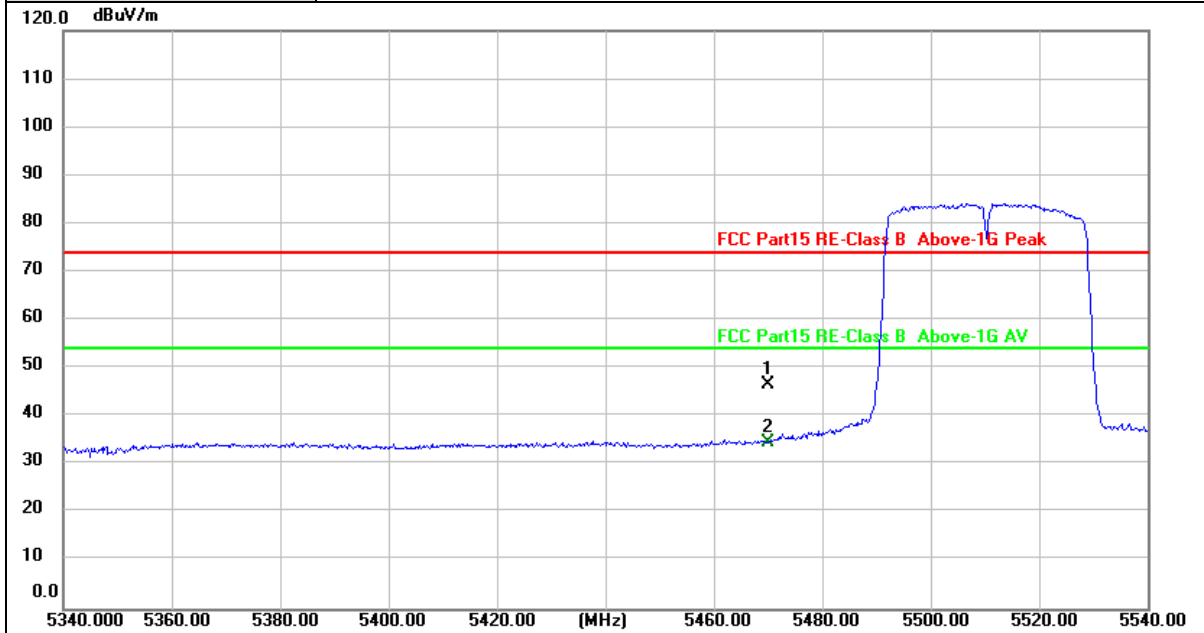

No.	Frequency (MHz)	Reading (dBuV)	Factor (dB/m)	Level (dBuV/m)	Limit (dBuV/m)	Margin (dB)	Detector
1	5470.000	47.00	-0.28	46.72	74.00	-27.28	peak
2 *	5470.000	34.88	-0.28	34.60	54.00	-19.40	AVG

Remarks:

- 1. Factor (dB/m) = Antenna Factor (dB/m)+Cable Factor (dB)-Pre-amplifier Factor
- 2. Margin value = Level -Limit value



Ant. No.	Ant 1 + Ant 2
Ant. Pol.	Vertical
Test Mode:	TX 802.11n(HT40) Mode 5510MHz (U-NII-2C)

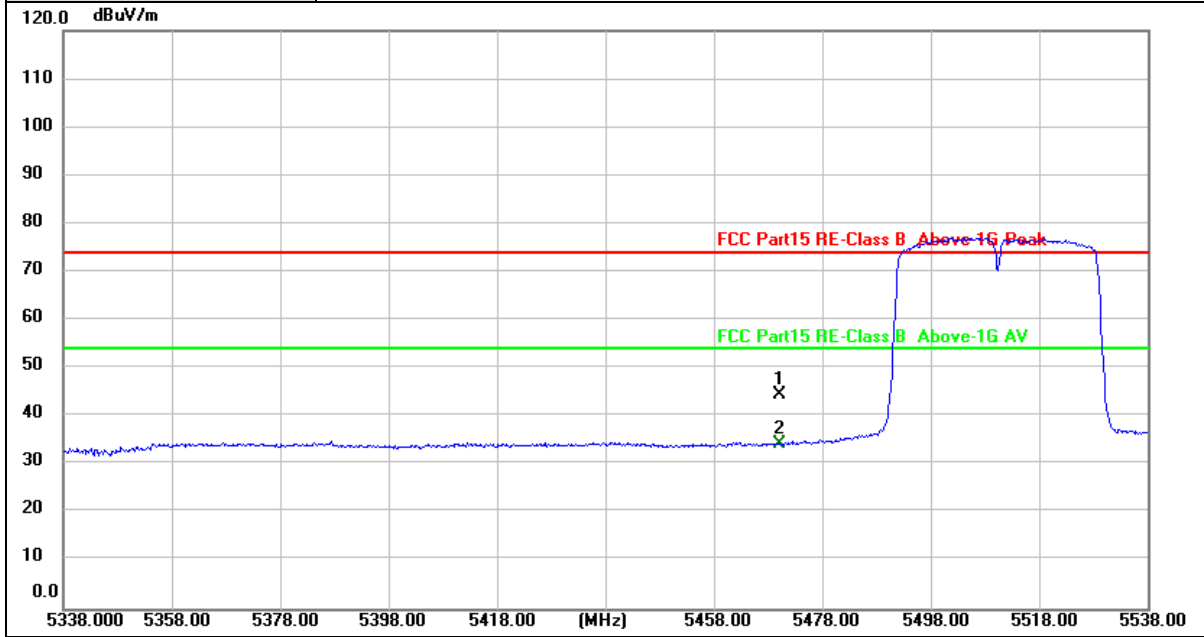

No.	Frequency (MHz)	Reading (dBuV)	Factor (dB/m)	Level (dBuV/m)	Limit (dBuV/m)	Margin (dB)	Detector
1	5470.000	44.92	-0.28	44.64	74.00	-29.36	peak
2 *	5470.000	34.55	-0.28	34.27	54.00	-19.73	AVG

Remarks:

- Factor (dB/m) = Antenna Factor (dB/m)+Cable Factor (dB)-Pre-amplifier Factor
- Margin value = Level -Limit value





Ant. No.	Ant 1 + Ant 2
Ant. Pol.	Horizontal
Test Mode:	TX 802.11n(HT40) Mode 5670MHz (U-NII-2C)

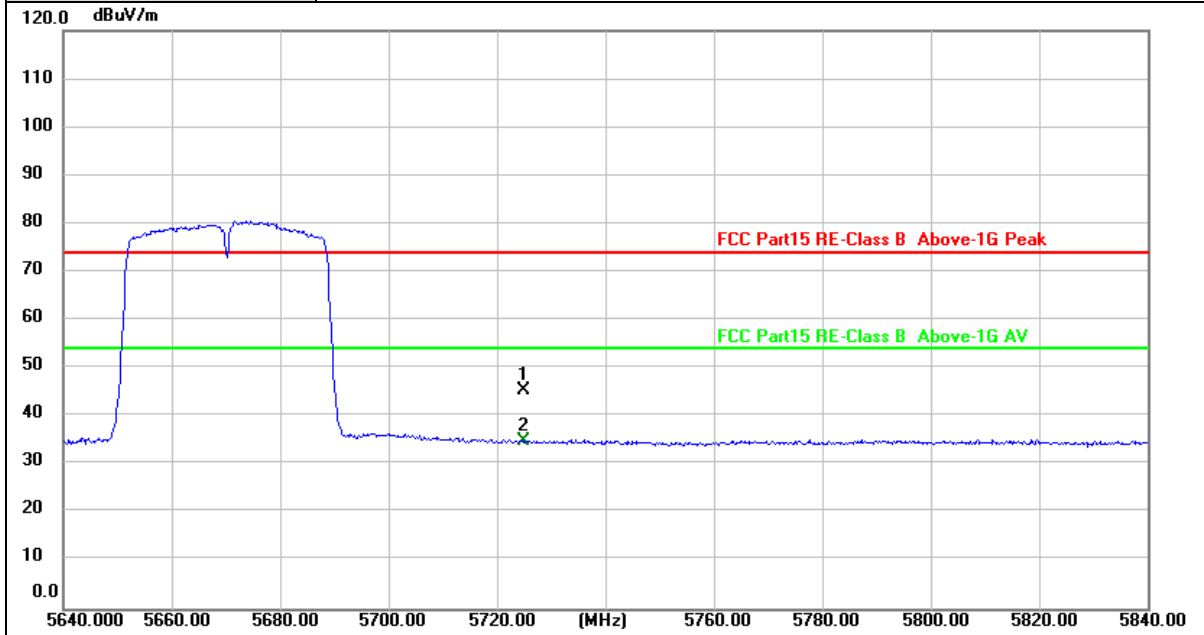

No.	Frequency (MHz)	Reading (dBuV)	Factor (dB/m)	Level (dBuV/m)	Limit (dBuV/m)	Margin (dB)	Detector
1	5725.000	45.15	0.39	45.54	74.00	-28.46	peak
2 *	5725.000	34.42	0.39	34.81	54.00	-19.19	AVG

Remarks:

- 1. Factor (dB/m) = Antenna Factor (dB/m)+Cable Factor (dB)-Pre-amplifier Factor
- 2. Margin value = Level -Limit value



Ant. No.	Ant 1 + Ant 2
Ant. Pol.	Vertical
Test Mode:	TX 802.11n(HT40) Mode 5670MHz (U-NII-2C)

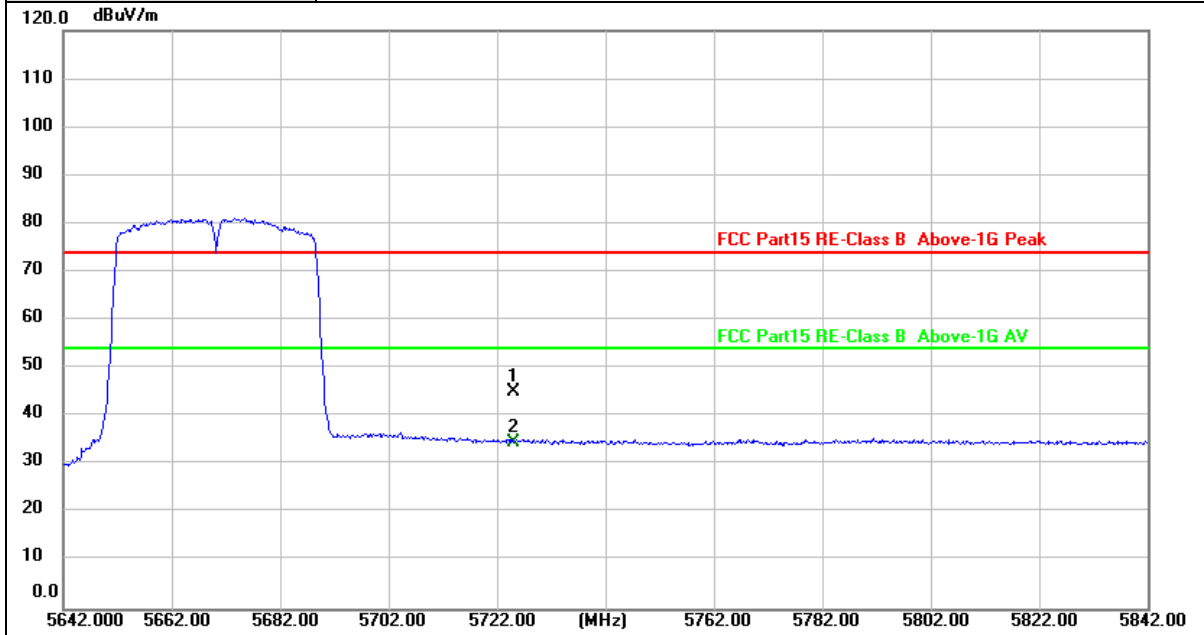

No.	Frequency (MHz)	Reading (dBuV)	Factor (dB/m)	Level (dBuV/m)	Limit (dBuV/m)	Margin (dB)	Detector
1	5725.000	44.83	0.39	45.22	74.00	-28.78	peak
2 *	5725.000	34.39	0.39	34.78	54.00	-19.22	AVG

Remarks:

1. Factor (dB/m) = Antenna Factor (dB/m)+Cable Factor (dB)-Pre-amplifier Factor
2. Margin value = Level -Limit value



Ant. No.	Ant 1 + Ant 2
Ant. Pol.	Horizontal
Test Mode:	TX 802.11ac(VHT40) Mode 5510MHz (U-NII-2C)

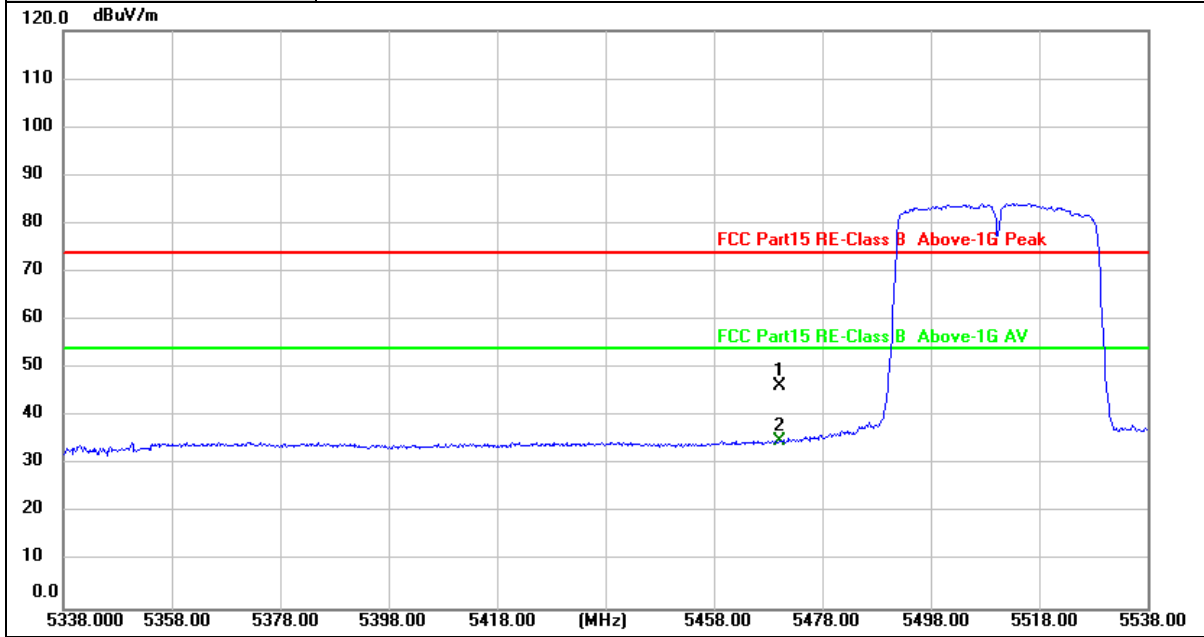

No.	Frequency (MHz)	Reading (dBuV)	Factor (dB/m)	Level (dBuV/m)	Limit (dBuV/m)	Margin (dB)	Detector
1	5470.000	46.78	-0.28	46.50	74.00	-27.50	peak
2 *	5470.000	35.20	-0.28	34.92	54.00	-19.08	AVG

Remarks:

- 1. Factor (dB/m) = Antenna Factor (dB/m)+Cable Factor (dB)-Pre-amplifier Factor
- 2. Margin value = Level -Limit value