



Shenzhen CTL Testing Technology Co., Ltd.
Tel: +86-755-89486194 E-mail: ctl@ctl-lab.com

TEST REPORT

47 CFR Part 15, Subpart C 15.247

Report Reference No.: CTL2406047073-WF

Compiled by:
(position+printed name+signature)

Happy Guo
(File administrators)

Tested by:
(position+printed name+signature)

Wuqiang Wu
(Test Engineer)

Approved by:
(position+printed name+signature)

Ivan Xie
(Manager)

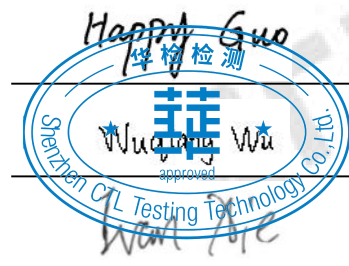

Product Name.....: Bluetooth speaker

Model/Type reference.....: MPD12MG

List Model(s).....: N/A

Trade Mark.....: Max power

FCC ID.....: **A5C-MPD12MG**

Applicant's name.....: **Universal Electronics, Inc.**

Address of applicant.....: 5610 Parkersburg Dr. Houston, TX 77036

Test Firm.....: **Shenzhen CTL Testing Technology Co., Ltd.**

Address of Test Firm.....: Floor 1-A, Baisha Technology Park, No.3011, Shahehexi Road, Nanshan District, Shenzhen, China 518055

Test specification.....:

Standard.....: **47 CFR Part 15, Subpart C 15.247:** Operation within the bands 902-928 MHz, 2400-2483.5 MHz and 5725-5850 MHz.

TRF Originator.....: Shenzhen CTL Testing Technology Co., Ltd.

Master TRF.....: Dated 2011-01

Date of receipt of test item.....: June 27, 2024

Date of Test Date.....: June 27, 2024-July 4, 2024

Date of Issue.....: July 9, 2024

Result.....: **Pass**

Shenzhen CTL Testing Technology Co., Ltd. All rights reserved.

This publication may be reproduced in whole or in part for non-commercial purposes as long as the Shenzhen CTL Testing Technology Co., Ltd. is acknowledged as copyright owner and source of the material. Shenzhen CTL Testing Technology Co., Ltd. takes no responsibility for and will not assume liability for damages resulting from the reader's interpretation of the reproduced material due to its placement and context.

TEST REPORT

Test Report No. : CTL2406047073-WF	July 9, 2024 Date of issue
---	-------------------------------

Equipment under Test : Bluetooth speaker

Sample No : CTL2406047073

Model /Type : MPD12MG

Listed Models : N/A

Applicant : **Universal Electronics, Inc.**

Address : 5610 Parkersburg Dr. Houston, TX 77036

Manufacturer : **Shenzhen Trendwoo Tech. Co.,Ltd.**

Address : Units 3202&3208, 32nd floor, Block C, Phase 2 Galaxy World, Minle community, Minzhi street, Longhua district, Shenzhen, China

Test result	Pass *
--------------------	---------------

*In the configuration tested, the EUT complied with the standards specified page 5.

The test results presented in this report relate only to the object tested.

This report shall not be reproduced, except in full, without the written approval of the issuing testing laboratory.

Table of Contents

Page

1. SUMMARY	5
1.1. TEST STANDARDS	5
1.2. TEST DESCRIPTION	5
1.3. TEST FACILITY	6
1.4. STATEMENT OF THE MEASUREMENT UNCERTAINTY	6
2. GENERAL INFORMATION	8
2.1. ENVIRONMENTAL CONDITIONS	8
2.2. GENERAL DESCRIPTION OF EUT	8
2.3. DESCRIPTION OF TEST MODES AND TEST FREQUENCY	9
2.4. EQUIPMENTS USED DURING THE TEST	10
2.5. RELATED SUBMITTAL(S) / GRANT (S)	10
2.6. MODIFICATIONS	11
3. TEST CONDITIONS AND RESULTS	12
3.1. CONDUCTED EMISSIONS TEST	12
3.2. RADIATED EMISSIONS AND BAND EDGE	15
3.3. MAXIMUM PEAK OUTPUT POWER	25
3.4. 20DB BANDWIDTH	26
3.5. FREQUENCY SEPARATION	27
3.6. NUMBER OF HOPPING FREQUENCY	28
3.7. TIME OF OCCUPANCY (DWELL TIME)	29
3.8. OUT-OF-BAND EMISSIONS	30
3.9. PSEUDORANDOM FREQUENCY HOPPING SEQUENCE	31
3.10. ANTENNA REQUIREMENT	32
4. TEST SETUP PHOTOS OF THE EUT	33
5. PHOTOS OF THE EUT	35

1. SUMMARY

1.1. TEST STANDARDS

The tests were performed according to following standards:

[47 CFR Part 15, Subpart C 15.247](#): Frequency Hopping, Direct Spread Spectrum and Hybrid Systems that are in operation within the bands of 902-928 MHz, 2400-2483.5 MHz, and 5725-5850 MHz

[ANSI C63.10: 2013](#): American National Standard for Testing Unlicensed Wireless Devices

[KDB 558074 D01 v05r02](#): KDB558074 D01 15.247 Meas Guidance v05r02

1.2. Test Description

47 CFR Part 15, Subpart C 15.247		
47 CFR Part 15, Subpart C 15.207	AC Power Conducted Emission	PASS
47 CFR Part 15, Subpart C 15.247(a)(1)(i)	20dB Bandwidth	PASS
47 CFR Part 15, Subpart C 15.247(d)	Spurious RF Conducted Emission	PASS
47 CFR Part 15, Subpart C 15.247(b)	Maximum Peak Output Power	PASS
47 CFR Part 15, Subpart C 15.247(a)	Pseudorandom Frequency Hopping Sequence	PASS
47 CFR Part 15, Subpart C 15.247(a)(1)(iii)	Number of hopping frequency & Time of Occupancy	PASS
47 CFR Part 15, Subpart C 15.247(a)(1)	Frequency Separation	PASS
47 CFR Part 15, Subpart C 15.205/15.209	Radiated Emissions	PASS
47 CFR Part 15, Subpart C 15.247(d)	Band Edge Compliance of RF Emission	PASS
47 CFR Part 15, Subpart C 15.203/15.247 (b)	Antenna Requirement	PASS

1.3. Test Facility

1.3.1 Address of the test laboratory

Shenzhen CTL Testing Technology Co.,Ltd.
Floor 1-A, Baisha Technology Park, No.3011, Shahexi Road, Nanshan District, Shenzhen, China
518055

There is one 3m semi-anechoic chamber and two line conducted labs for final test. The Test Sites meet the requirements in documents ANSI C63.10 and CISPR 32/EN 55032 requirements.

1.3.2 Laboratory accreditation

The test facility is recognized, certified, or accredited by the following organizations:

CNAS-Lab Code: L7497

Shenzhen CTL Testing Technology Co., Ltd. has been assessed and proved to be in compliance with CNAS-CL01 Accreditation Criteria for Testing and Calibration Laboratories (identical to ISO/IEC 17025: 2017 General Requirements) for the Competence of Testing and Calibration Laboratories.

A2LA-Lab Cert. No. 4343.01

Shenzhen CTL Testing Technology Co., Ltd, EMC Laboratory has been accredited by A2LA for technical competence in the field of electrical testing, and proved to be in compliance with ISO/IEC 17025: 2017 General Requirements for the Competence of Testing and Calibration Laboratories and any additional program requirements in the identified field of testing.

IC Registration No.: 9618B

CAB identifier: CN0041

The 3m alternate test site of Shenzhen CTL Testing Technology Co., Ltd. EMC Laboratory has been registered by Innovation, Science and Economic Development Canada to test to Canadian radio equipment requirements with Registration No.: 9618B.

FCC-Registration No.: 399832

Designation No.: CN1216

Shenzhen CTL Testing Technology Co., Ltd. EMC Laboratory has been registered and fully described in a report filed with the (FCC) Federal Communications Commission. The acceptance letter from the FCC is maintained in our files. Registration 399832.

1.4. Statement of the measurement uncertainty

The data and results referenced in this document are true and accurate. The reader is cautioned that there may be errors within the calibration limits of the equipment and facilities. The measurement uncertainty was calculated for all measurements listed in this test report acc. to CISPR 16 - 4 "Specification for radio disturbance and immunity measuring apparatus and methods – Part 4: Uncertainty in EMC Measurements" and is documented in the Shenzhen CTL Testing Technology Co., Ltd. quality system acc. to DIN EN ISO/IEC 17025. Furthermore, component and process variability of devices similar to that tested may result in additional deviation. The manufacturer has the sole responsibility of continued compliance of the device.

Hereafter the best measurement capability for CTL laboratory is reported:

Test	Measurement Uncertainty	Notes
Transmitter power Radiated	±2.20dB	(1)
Radiated Emission 9KHz~30MHz	±3.66dB	(1)
Radiated Emission 30~1000MHz	±4.10dB	(1)
Radiated Emission Above 1GHz	±4.32dB	(1)
20dB Emission Bandwidth	±1.9%	(1)

Carrier Frequency Separation	$\pm 1.9\%$	(1)
Maximum Power Spectral Density Level	± 0.98 dB	(1)
Number of Hopping Channel	$\pm 1.9\%$	(1)
Time of Occupancy	$\pm 0.11\%$	(1)
Max Peak Conducted Output Power	± 0.98 dB	(1)
Band-edge Spurious Emission	± 1.21 dB	(1)
Conducted RF Spurious Emission	9kHz-7GHz: ± 1.09 dB 7GHz-26.5GHz: ± 3.27 dB	(1)

(1) This uncertainty represents an expanded uncertainty expressed at approximately the 95% confidence level using a coverage factor of $k=1.96$.

2. GENERAL INFORMATION

2.1. Environmental conditions

During the measurement the environmental conditions were within the listed ranges:

Normal Temperature:	25°C
Relative Humidity:	55 %
Air Pressure:	101 kPa

2.2. General Description of EUT

Product Name:	Bluetooth speaker
Model/Type reference:	MPD12MG
Power supply:	DC 3.7V from battery or AC 100-240V~ 50/60Hz 0.2A Max from Adapter
Adapter information:	Model: KA0601A-0501000USU Input: 100-240V~ 50/60Hz 0.A Max Output: 5V == 1000mA
Bluetooth:	
Version:	Supported BR/EDR
Modulation:	GFSK, $\pi/4$ DQPSK, 8DPSK
Operation frequency:	2402MHz to 2480MHz
Channel number:	79
Channel separation:	1MHz
Antenna type:	PCB Antenna
Antenna gain:	1.08dBi

Note1: For more details, please refer to the user's manual of the EUT.

Note2: Antenna gain provided by the applicant.

2.3. Description of Test Modes and Test Frequency

The Applicant provides communication tools software to control the EUT for staying in continuous transmitting (Duty Cycle more than 98%) and receiving mode for testing .There are 79 channels provided to the EUT and Channel 00/39/78 were selected to test.

Operation Frequency :

Channel	Frequency (MHz)
00	2402
01	2403
⋮	⋮
38	2440
39	2441
40	2442
⋮	⋮
77	2479
78	2480

Preliminary tests were performed in each mode and packet length of BT, and found worst case as bellow, finally test were conducted at those mode and recorded in this report.

Test Items	Worst case
Conducted Emissions	DH5 Middle channel
Radiated Emissions and Band Edge	DH5
Maximum Conducted Output Power	DH5/2DH5/3DH5
20dB Bandwidth	DH5/2DH5/3DH5
Frequency Separation	DH5/2DH5/3DH5 Middle channel
Number of hopping frequency	DH5/2DH5/3DH5
Time of Occupancy (Dwell Time)	DH1/DH3/DH5 Middle channel 2DH1/2DH3/2DH5 Middle channel 3DH1/3DH3/3DH5 Middle channel
Out-of-band Emissions	DH5/2DH5/3DH5

2.4. Equipments Used during the Test

Conducted Emission						
Test Equipment	Manufacturer	Model No.	Serial No.	Previous calibration	Last Cal.	Cal.Due
EMI Test Receiver	ROHDE & SCHWARZ	ESCI	1166.5950.03	2023/05/04	2024/04/30	2025/04/29
LISN	ROHDE & SCHWARZ	ESH2-Z5	860014/010	2023/05/04	2024/04/30	2025/04/29
Limitator	ROHDE & SCHWARZ	ESH3-Z2	100408	2023/05/04	2024/04/30	2025/04/29
Software:						
Name of Software:			Version:			
ES-K1			V1.71			

Radiated Emission						
Test Equipment	Manufacturer	Model No.	Serial No.	Previous calibration	Last Cal.	Cal.Due
Active Loop Antenna	Da Ze	ZN30900A	/	2021/05/13	2024/04/30	2025/04/29
Double cone logarithmic antenna	Schwarzbeck	VULB 9168	824	/	2023/02/13	2026/02/12
Horn Antenna	Sunol Sciences Corp.	DRH-118	A062013	/	2021/12/23	2024/12/22
Horn Antenna	Ocean Microwave	OBH100400	26999002	/	2021/12/22	2024/12/21
Amplifier	MRT-AP01M06	MRT	S-001	2023/05/04	2024/04/30	2025/04/29
Amplifier	Agilent	8449B	3008A02306	2023/05/04	2024/04/30	2025/04/29
Amplifier	Brief&Smart	LNA-4018	2104197	2023/05/05	2024/05/03	2025/05/02
EMI Test Receiver	ROHDE & SCHWARZ	ESCI	1166.5950.03	2023/05/04	2024/04/30	2025/04/29
Spectrum Analyzer	RS	FSP	1164.4391.38	2023/05/05	2024/05/03	2025/05/02
Software:						
Name of Software:			Version:			
EZ_EMG(Below 1GHz)			V1.1.4.2			
EZ_EMG(Above 1GHz)			V1.1.4.2			

RF Conducted						
Test Equipment	Manufacturer	Model No.	Serial No.	Previous calibration	Last Cal.	Cal.Due
Spectrum Analyzer	Keysight	N9020A	MY53420874	2023/05/04	2024/05/01	2025/04/30
Temperature/Humidity Meter	Ji Yu	MC501	/	2023/05/09	2024/05/04	2025/05/03
Software:						
Name of Software:			Version:			
TST-PASS			V2.0			

2.5. Related Submittal(s) / Grant (s)

This submittal(s) (test report) is intended to comply with Section 15.247 of the FCC Part 15, Subpart C Rules.

2.6. Modifications

No modifications were implemented to meet testing criteria.

3. TEST CONDITIONS AND RESULTS

3.1. Conducted Emissions Test

LIMIT

FCC CFR Title 47 Part 15 Subpart C Section 15.207

Frequency range (MHz)	Limit (dBuV)	
	Quasi-peak	Average
0.15-0.5	66 to 56*	56 to 46*
0.5-5	56	46
5-30	60	50

* Decreases with the logarithm of the frequency.

TEST CONFIGURATION

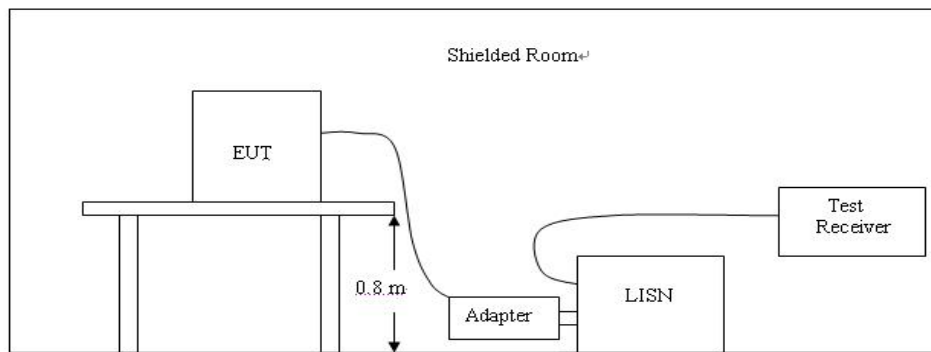

TEST PROCEDURE

1. The equipment was set up as per the test configuration to simulate typical actual usage per the user's manual. The EUT is a tabletop system; a wooden table with a height of 0.8 meters is used and is placed on the ground plane as per ANSI C63.10:2013.
2. Support equipment, if needed, was placed as per ANSI C63.10:2013.
3. All I/O cables were positioned to simulate typical actual usage as per ANSI C63.10:2013.
4. The adapter received AC120V/60Hz power through a Line Impedance Stabilization Network (LISN) which supplied power source and was grounded to the ground plane.
5. All support equipments received AC power from a second LISN, if any.
6. The EUT test program was started. Emissions were measured on each current carrying line of the EUT using a spectrum Analyzer / Receiver connected to the LISN powering the EUT. The LISN has two monitoring points: Line 1 (Hot Side) and Line 2 (Neutral Side). Two scans were taken: one with Line 1 connected to Analyzer / Receiver and Line 2 connected to a 50 ohm load; the second scan had Line 1 connected to a 50 ohm load and Line 2 connected to the Analyzer / Receiver.
7. Analyzer / Receiver scanned from 150 KHz to 30MHz for emissions in each of the test modes.
8. During the above scans, the emissions were maximized by cable manipulation.

TEST RESULTS

Remark: All modes of GFSK, Pi/4 DQPSK, and 8DPSK were test at Low, Middle, and High channel; only the worst result of GFSK Low Channel was reported as below:

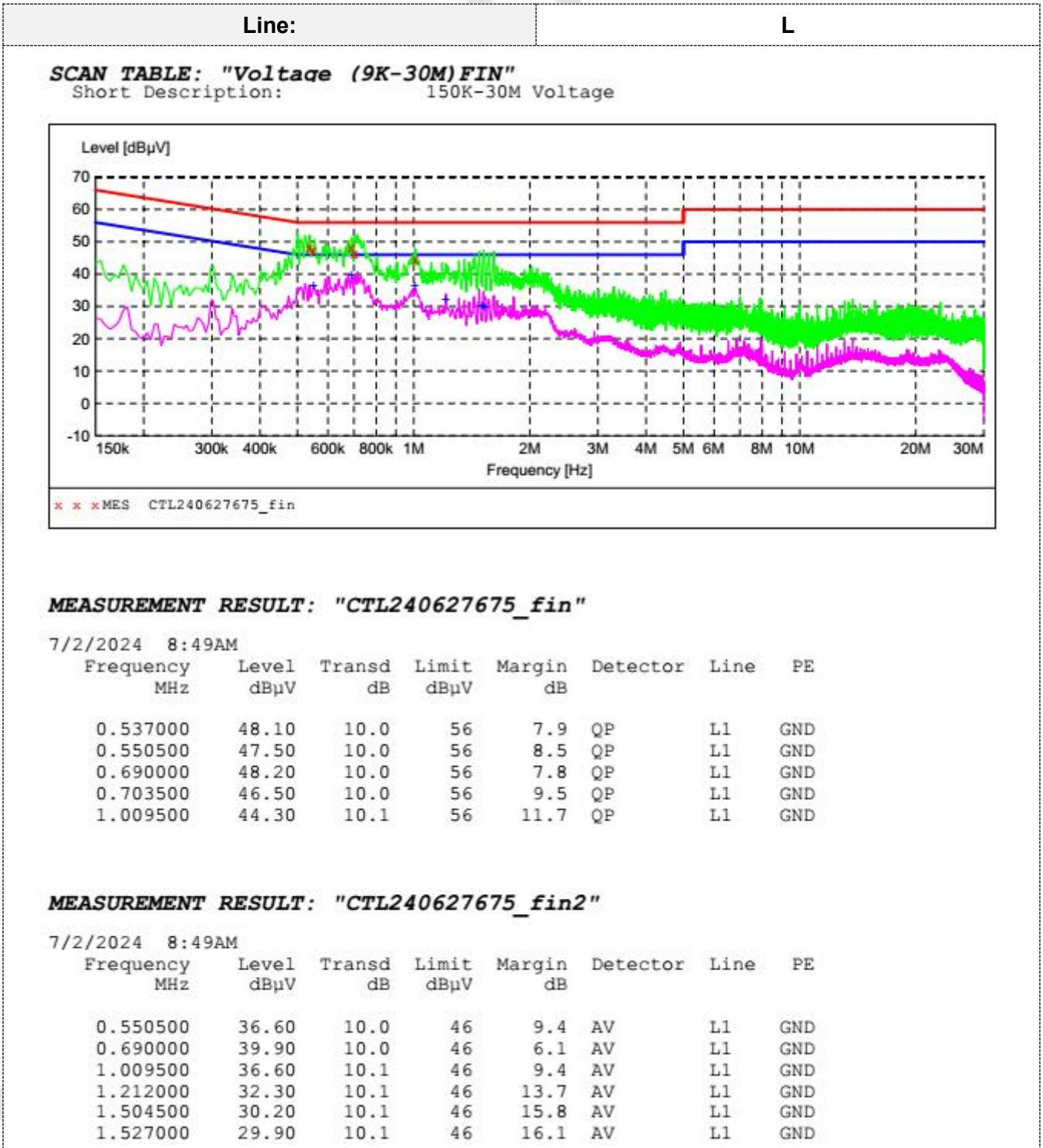

Line:

N

SCAN TABLE: "Voltage (9K-30M)FIN"

Short Description: 150K-30M Voltage

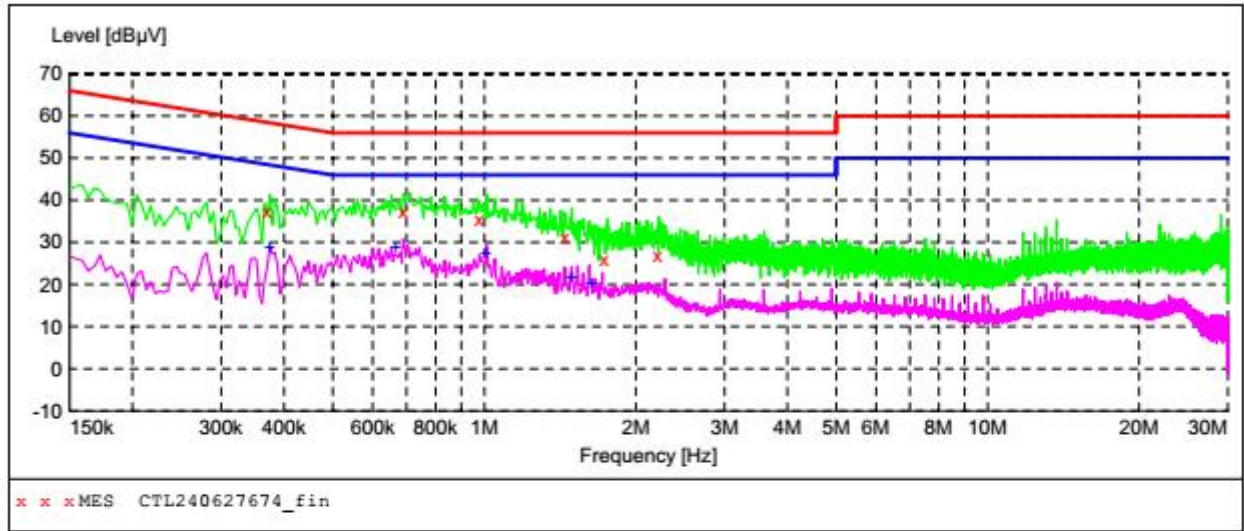

MEASUREMENT RESULT: "CTL240627674_fin"

7/2/2024 8:46AM

Frequency MHz	Level dBµV	Transd dB	Limit dBµV	Margin dB	Detector	Line	PE
0.370500	37.10	10.0	59	21.4	QP	N	GND
0.690000	37.50	10.0	56	18.5	QP	N	GND
0.978000	35.50	10.1	56	20.5	QP	N	GND
1.446000	31.40	10.1	56	24.6	QP	N	GND
1.729500	26.00	10.1	56	30.0	QP	N	GND
2.211000	27.10	10.1	56	28.9	QP	N	GND

MEASUREMENT RESULT: "CTL240627674_fin2"

7/2/2024 8:46AM

Frequency MHz	Level dBµV	Transd dB	Limit dBµV	Margin dB	Detector	Line	PE
0.375000	28.80	10.0	48	19.6	AV	N	GND
0.667500	28.60	10.0	46	17.4	AV	N	GND
1.009500	27.50	10.1	46	18.5	AV	N	GND
1.491000	21.70	10.1	46	24.3	AV	N	GND
1.635000	20.30	10.1	46	25.7	AV	N	GND

3.2. Radiated Emissions and Band Edge

Limit

For intentional device, according to § 15.209(a), the general requirement of field strength of radiated emission out of authorized band shall not exceed the following table at a 3 meters measurement distance.

In addition, radiated emissions which fall in the restricted bands, as defined in §15.205(a), must also comply with the radiated emission limits specified in §15.209(a)

Radiated emission limits

Frequency (MHz)	Distance (Meters)	Radiated (dB μ V/m)	Radiated (μ V/m)
0.009-0.49	3	$20\log(2400/F(\text{KHz}))+40\log(300/3)$	$2400/F(\text{KHz})$
0.49-1.705	3	$20\log(24000/F(\text{KHz}))+40\log(30/3)$	$24000/F(\text{KHz})$
1.705-30	3	$20\log(30)+40\log(30/3)$	30
30-88	3	40.0	100
88-216	3	43.5	150
216-960	3	46.0	200
Above 960	3	54.0	500

TEST CONFIGURATION

(A) Radiated Emission Test Set-Up, Frequency Below 30MHz

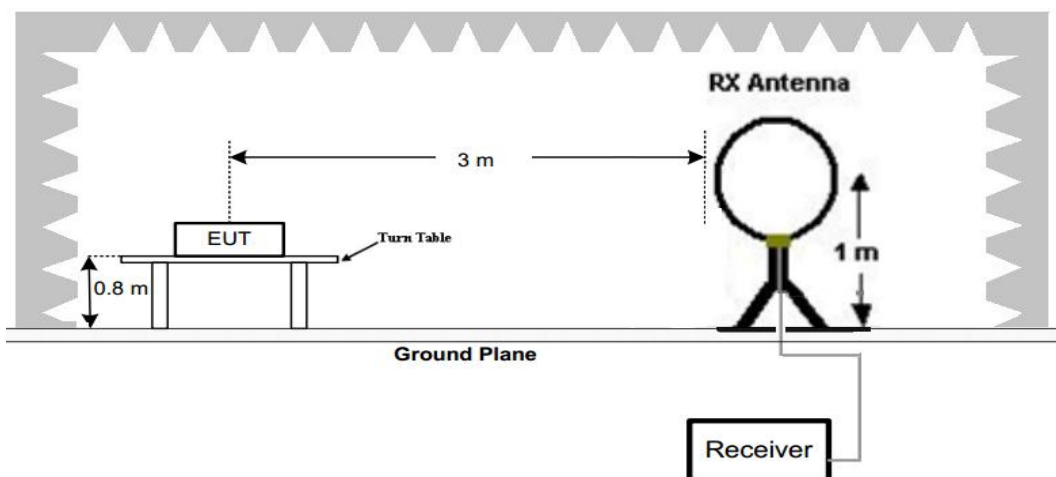

(B) Radiated Emission Test Set-Up, Frequency below 1000MHz

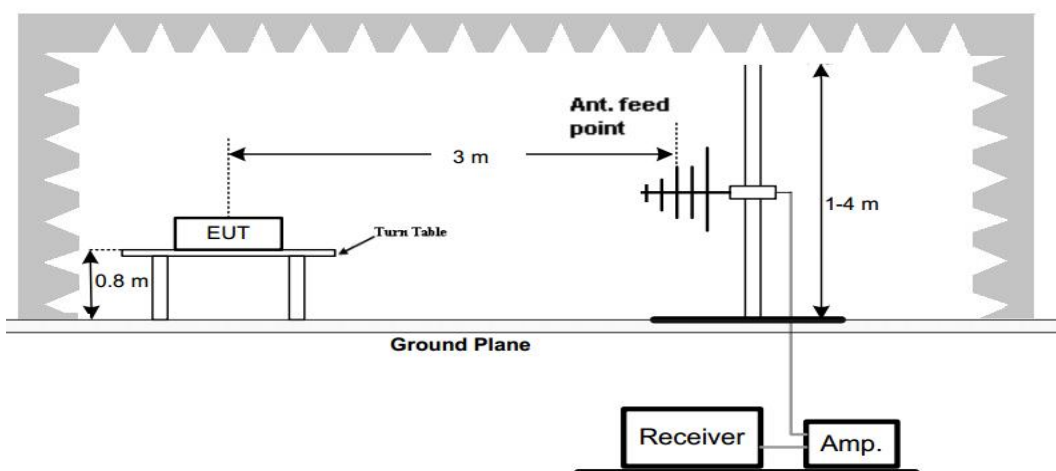

(C) Radiated Emission Test Set-Up, Frequency above 1000MHz

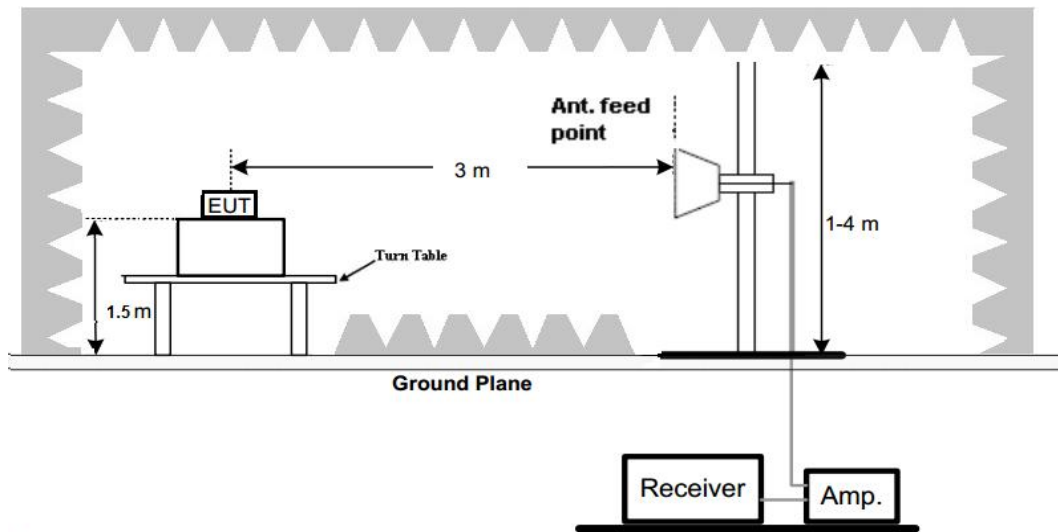

Test Procedure

1. Below 1GHz measurement the EUT is placed on a turntable which is 0.8m above ground plane, and above 1GHz measurement EUT was placed on a low permittivity and low loss tangent turn table which is 1.5m above ground plane.
2. Maximum procedure was performed by raising the receiving antenna from 1m to 4m and rotating the turn table from 0° to 360° to acquire the highest emissions from EUT
3. And also, each emission was to be maximized by changing the polarization of receiving antenna both horizontal and vertical.
4. Repeat above procedures until all frequency measurements have been completed.
5. The EUT was pretested with 3 orientations placed on the table for the radiated emission measurement –X, Y, and Z-plane. The X-plane results were found as the worst case and were shown in this report.

TEST RESULTS

Remark:

1. We measured Radiated Emission at GFSK, $\pi/4$ DQPSK and 8DPSK mode from 9 KHz to 25GHz and recorded worst case at GFSK DH5 mode..
2. For below 1GHz testing recorded worst at GFSK DH5 low channel.
3. Radiated emission test from 9 KHz to 10th harmonic of fundamental was verified, Found the emission level are attenuated 20dB below the limits from 9 kHz to 30MHz, so it does not recorded in report.

For 30MHz-1GHz

Horizontal



Shenzhen CTL Testing Technology Co., Ltd
Tel: +86-755-89486194

Radiated Emission Measurement

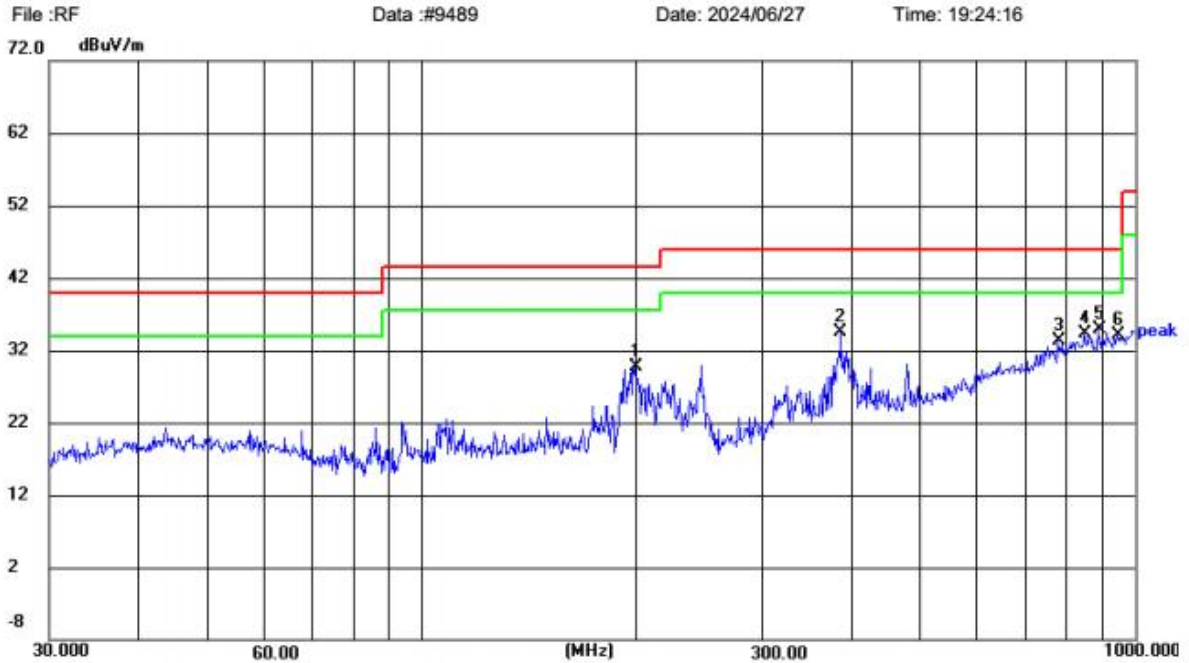

Site LAB Chamber 2 Polarization: **Horizontal** Temperature: 25(C)
 Limit: FCC Part15 RE-Class C_30-1000MHz Power: Humidity: 50 %
 EUT: / Distance: 3m
 M/N: MPD12MG
 Mode: BT 2402MHz
 Note: Universal Electronics, Inc.

No.	Frequency (MHz)	Reading (dBuV)	Factor (dB/m)	Level (dBuV/m)	Limit (dBuV/m)	Margin (dB)	Detector	Height (cm)	Azimuth (deg.)	P/F	Remark
1	198.5879	18.21	11.40	29.61	43.50	13.89	peak	100	321	P	
2	386.9728	17.50	16.96	34.46	46.00	11.54	peak	100	82	P	
3	780.2905	8.15	25.21	33.36	46.00	12.64	peak	100	60	P	
4	850.2895	8.16	26.24	34.40	46.00	11.60	peak	100	142	P	
5	888.3883	8.57	26.24	34.81	46.00	11.19	peak	100	321	P	
6	943.7837	7.10	27.10	34.20	46.00	11.80	peak	100	60	P	

Vertical



Shenzhen CTL Testing Technology Co., Ltd
Tel: +86-755-89486194

Radiated Emission Measurement

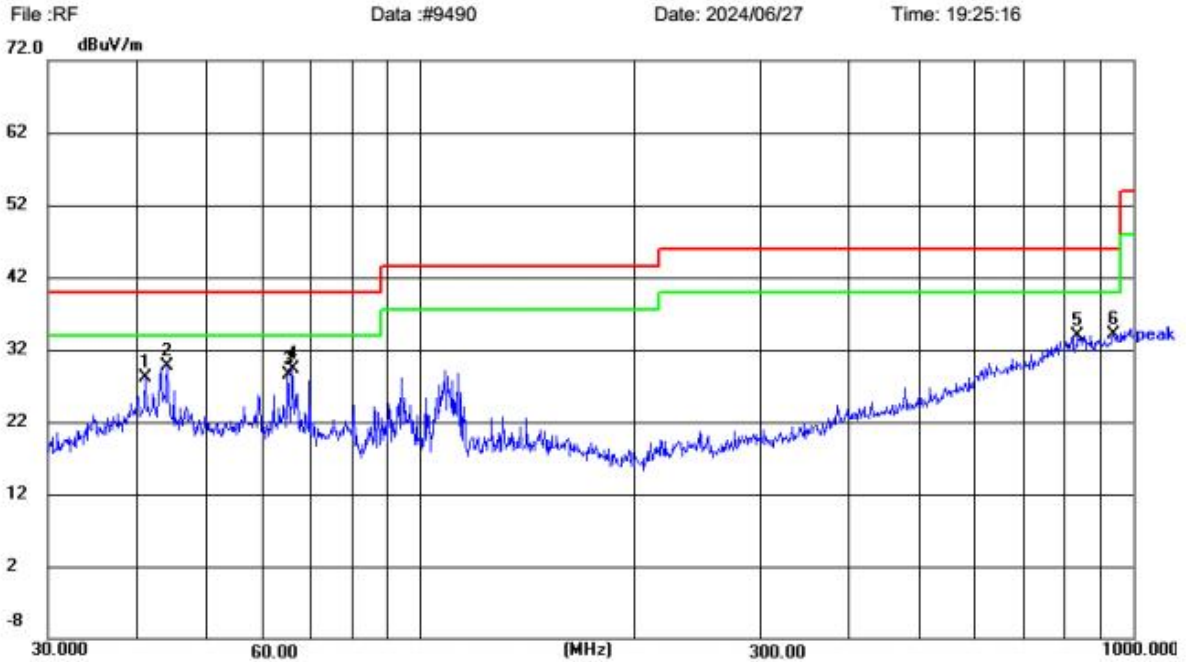

Site LAB Chamber 2 Polarization: **Vertical** Temperature: 25(C)
 Limit: FCC Part15 RE-Class C_30-1000MHz Power: Humidity: 50 %
 EUT: / Distance: 3m
 M/N: MPD12MG
 Mode: BT 2402MHz
 Note: Universal Electronics, Inc.

No.	Frequency (MHz)	Reading (dBuV)	Factor (dB/m)	Level (dBuV/m)	Limit (dBuV/m)	Margin (dB)	Detector	Height (cm)	Azimuth (deg.)	P/F	Remark
1	41.2584	13.94	14.26	28.20	40.00	11.80	peak	100	53	P	
2	44.1395	15.30	14.46	29.76	40.00	10.24	peak	100	292	P	
3	65.1716	15.52	12.99	28.51	40.00	11.49	peak	100	360	P	
4	66.1211	16.28	12.95	29.23	40.00	10.77	peak	100	173	P	
5	836.9777	7.90	26.03	33.93	46.00	12.07	peak	100	307	P	
6	939.2442	7.11	27.09	34.20	46.00	11.80	peak	100	195	P	

For 1GHz to 25GHz

Horizontal



Shenzhen CTL Testing Technology Co., Ltd
Tel: +86-755-89486194

Radiated Emission Measurement

File :RF-RSE 4

Data :#9469

Date: 2024/06/27

Time: 20:11:55

80.0 dBuV/m

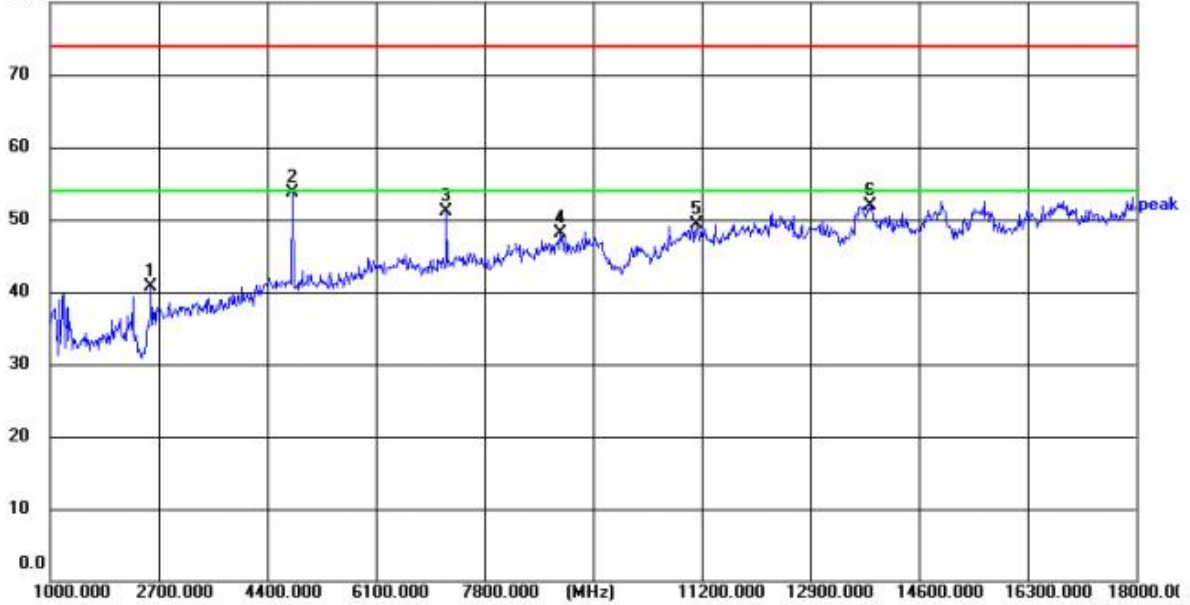

Site LAB Chamber 2

Polarization: **Horizontal**

Temperature: 25(C)

Limit: FCC Part15 RE-Class C_Above 1GHz_PK

Power:

Humidity: 50 %

EUT:

Distance: 3m

M/N: MPD12MG

Mode: BT 2402MHz TX

Note: Universal Electronics, Inc.

No.	Frequency (MHz)	Reading (dBuV)	Factor (dB/m)	Level (dBuV/m)	Limit (dBuV/m)	Margin (dB)	Detector	Height (cm)	Azimuth (deg.)	P/F	Remark
1	2593.750	56.85	-16.20	40.65	74.00	33.35	peak	150	169	P	
2	4803.750	61.76	-8.09	53.67	74.00	20.33	peak	150	54	P	
3	7205.000	54.32	-3.29	51.03	74.00	22.97	peak	150	344	P	
4	8994.250	48.37	-0.30	48.07	74.00	25.93	peak	150	192	P	
5	11119.250	48.48	0.79	49.27	74.00	24.73	peak	150	146	P	
6	13837.125	48.23	3.75	51.98	74.00	22.02	peak	150	77	P	

Vertical



Shenzhen CTL Testing Technology Co., Ltd
Tel: +86-755-89486194

Radiated Emission Measurement

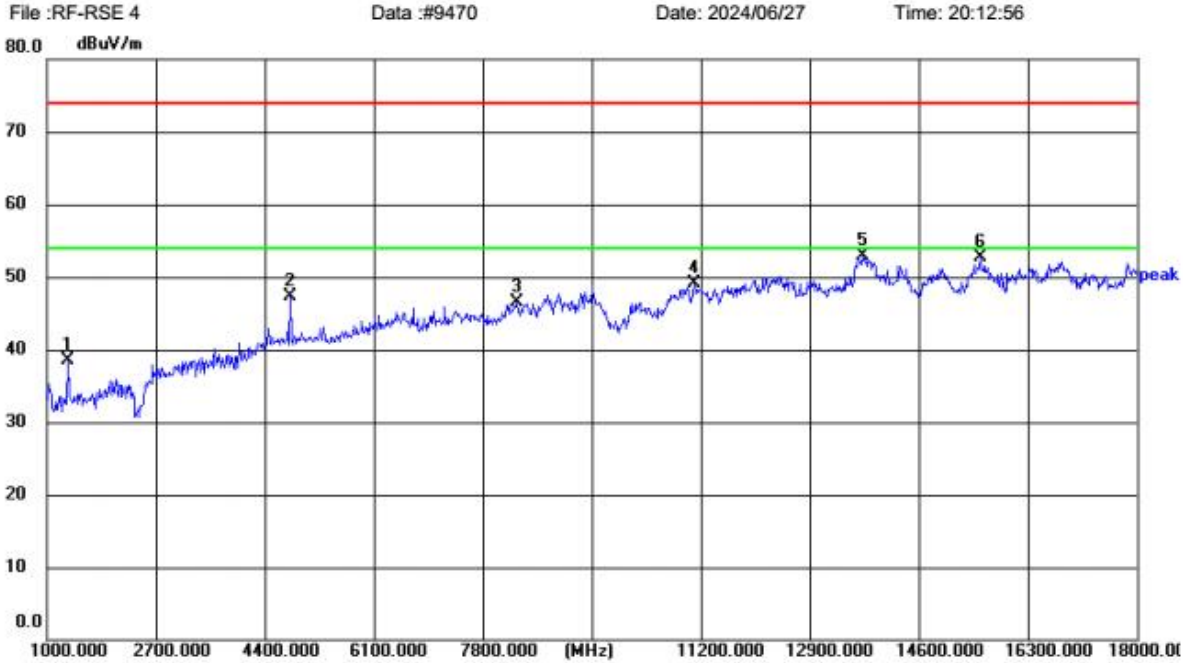

Site LAB Chamber 2 Polarization: **Vertical** Temperature: 25(C)
 Limit: FCC Part15 RE-Class C_Above 1GHz_PK Power: Humidity: 50 %
 EUT: Distance: 3m
 M/N: MPD12MG
 Mode: BT 2402MHz TX
 Note: Universal Electronics, Inc.

No.	Frequency (MHz)	Reading (dBuV)	Factor (dB/m)	Level (dBuV/m)	Limit (dBuV/m)	Margin (dB)	Detector	Height (cm)	Azimuth (deg.)	P/F	Remark
1	1331.500	60.79	-22.34	38.45	74.00	35.55	peak	150	222	P	
2	4803.750	55.38	-8.09	47.29	74.00	26.71	peak	150	306	P	
3	8335.500	48.71	-2.15	46.56	74.00	27.44	peak	150	115	P	
4	11108.625	48.30	0.78	49.08	74.00	24.92	peak	150	328	P	
5	13726.625	49.03	3.85	52.88	74.00	21.12	peak	150	298	P	
6	15564.750	48.71	3.92	52.63	74.00	21.37	peak	150	282	P	

REMARKS:

- 18GHz-26GHz not recorded for no spurious point have a margin of less than 6 dB with respect to the limits.
- PK detector measurement value is lower than the average limit. Therefore, there is no need to test AV detector measurements.

Results of Band Edges Test (Radiated)

Note: All modulations have been tested, only worse case GFSK is reported.

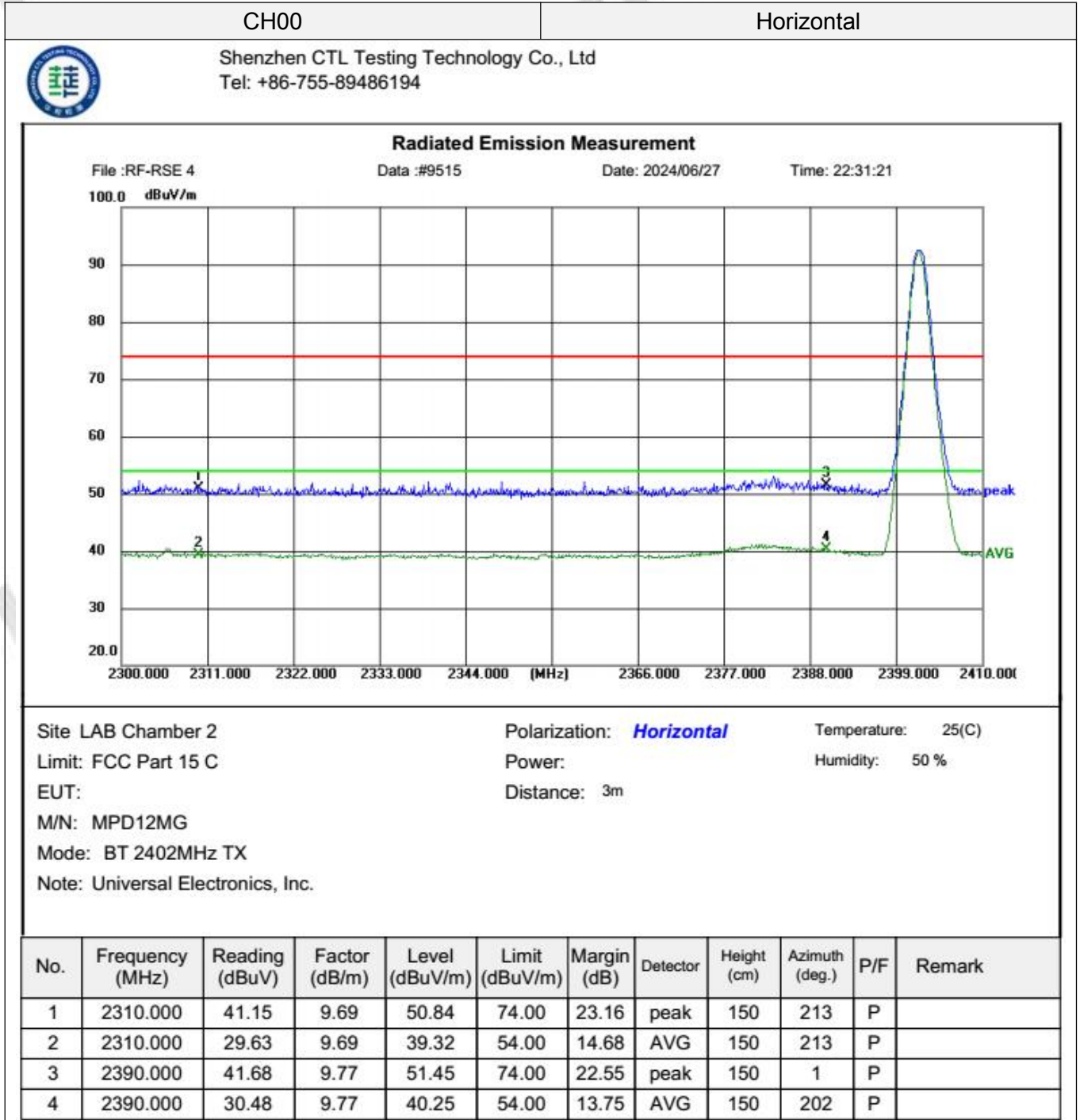

CH00

Vertical



Shenzhen CTL Testing Technology Co., Ltd
Tel: +86-755-89486194

Radiated Emission Measurement

File :RF-RSE 4

Data :#9516

Date: 2024/06/27

Time: 22:32:23

100.0 dBuV/m

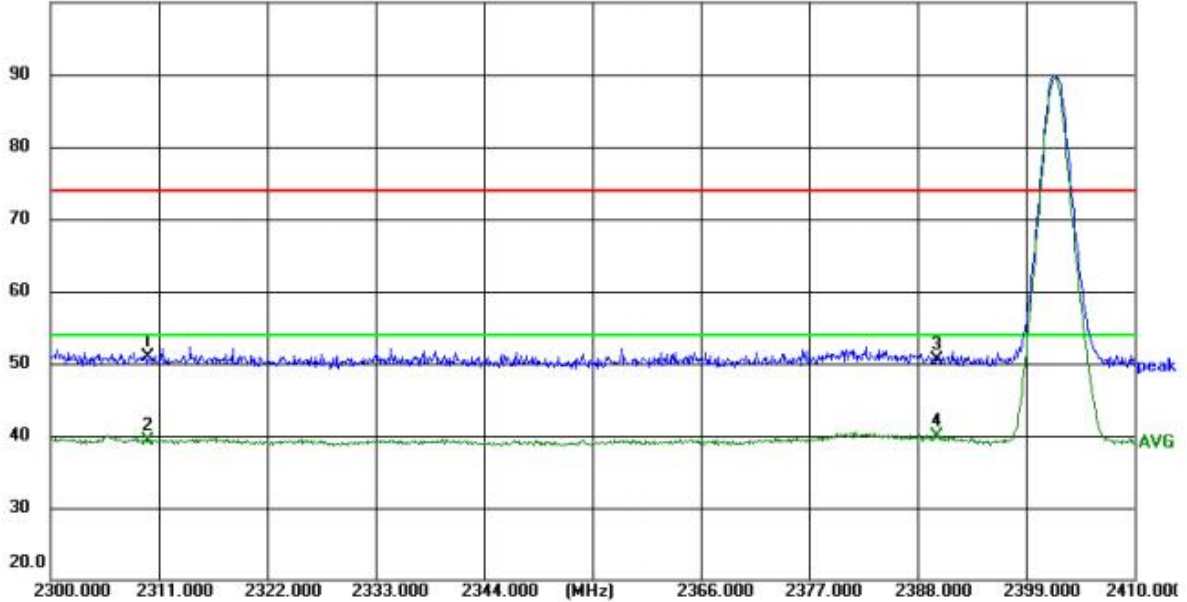

Site LAB Chamber 2
Limit: FCC Part 15 C
EUT:
M/N: MPD12MG
Mode: BT 2402MHz TX
Note: Universal Electronics, Inc.

Polarization: **Vertical**
Power:
Distance: 3m

Temperature: 25(C)
Humidity: 50 %

No.	Frequency (MHz)	Reading (dBuV)	Factor (dB/m)	Level (dBuV/m)	Limit (dBuV/m)	Margin (dB)	Detector	Height (cm)	Azimuth (deg.)	P/F	Remark
1	2310.000	41.25	9.69	50.94	74.00	23.06	peak	150	63	P	
2	2310.000	29.68	9.69	39.37	54.00	14.63	AVG	150	105	P	
3	2390.000	40.71	9.77	50.48	74.00	23.52	peak	150	126	P	
4	2390.000	30.14	9.77	39.91	54.00	14.09	AVG	150	126	P	

CH78

Horizontal



Shenzhen CTL Testing Technology Co., Ltd
Tel: +86-755-89486194

Radiated Emission Measurement

File :RF-RSE 4

Data :#9517

Date: 2024/06/27

Time: 22:35:16

100.0 dBuV/m

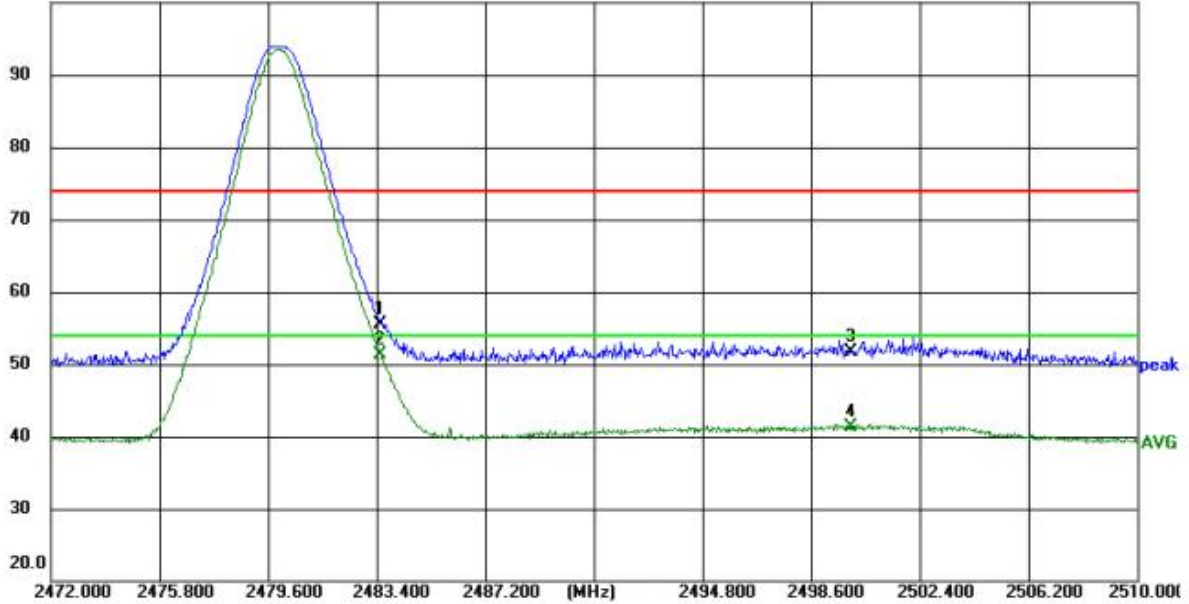

Site LAB Chamber 2

Polarization: **Horizontal**

Temperature: 25(C)

Limit: FCC Part 15 C

Power:

Humidity: 50 %

EUT:

Distance: 3m

M/N: MPD12MG

Mode: BT 2480MHz TX

Note: Universal Electronics, Inc.

No.	Frequency (MHz)	Reading (dBuV)	Factor (dB/m)	Level (dBuV/m)	Limit (dBuV/m)	Margin (dB)	Detector	Height (cm)	Azimuth (deg.)	P/F	Remark
1	2483.500	45.51	9.93	55.44	74.00	18.56	peak	150	227	P	
2	2483.500	41.41	9.93	51.34	54.00	2.66	AVG	150	227	P	
3	2500.000	41.75	10.00	51.75	74.00	22.25	peak	150	194	P	
4	2500.000	31.24	10.00	41.24	54.00	12.76	AVG	150	194	P	

CH78

Vertical



Shenzhen CTL Testing Technology Co., Ltd
Tel: +86-755-89486194

Radiated Emission Measurement

File :RF-RSE 4

Data :#9518

Date: 2024/06/27

Time: 22:36:17

100.0 dBuV/m

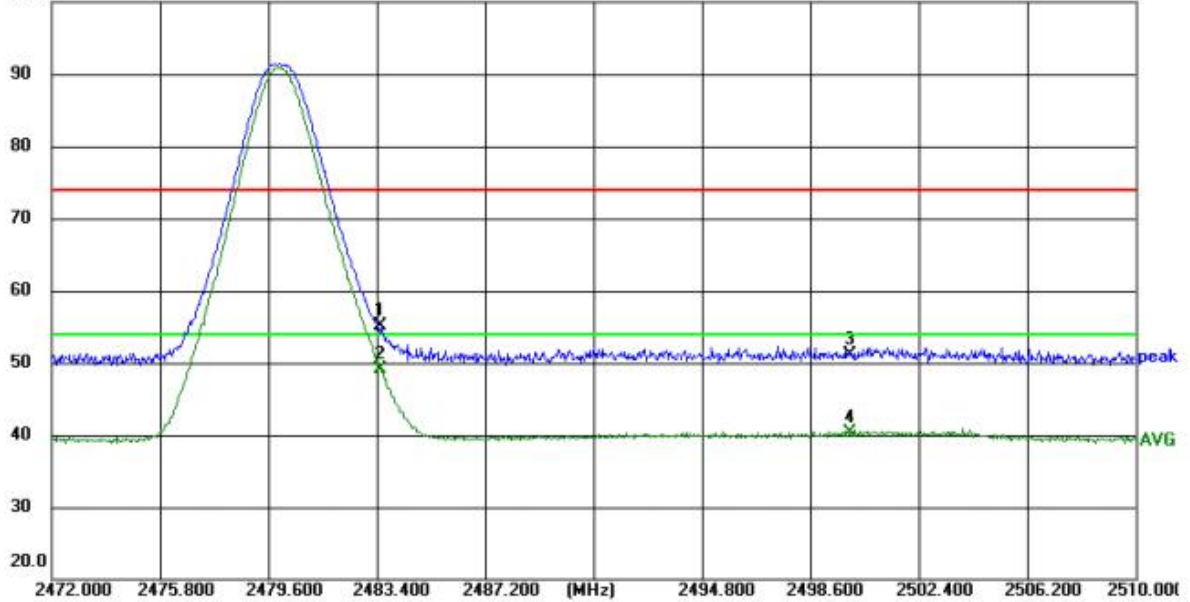

Site LAB Chamber 2

Polarization: **Vertical**

Temperature: 25(C)

Limit: FCC Part 15 C

Power:

Humidity: 50 %

EUT:

Distance: 3m

M/N: MPD12MG

Mode: BT 2480MHz TX

Note: Universal Electronics, Inc.

No.	Frequency (MHz)	Reading (dBuV)	Factor (dB/m)	Level (dBuV/m)	Limit (dBuV/m)	Margin (dB)	Detector	Height (cm)	Azimuth (deg.)	P/F	Remark
1	2483.500	45.24	9.93	55.17	74.00	18.83	peak	150	295	P	
2	2483.500	39.24	9.93	49.17	54.00	4.83	AVG	150	295	P	
3	2500.000	41.09	10.00	51.09	74.00	22.91	peak	150	36	P	
4	2500.000	30.22	10.00	40.22	54.00	13.78	AVG	150	25	P	

3.3. Maximum Peak Output Power

Limit

For frequency hopping systems operating in the 2400-2483.5 MHz band employing at least 75 non-overlapping hopping channels: 1 watt.

For all other frequency hopping systems in the 2400-2483.5 MHz band: 0.125 watts.

Test Procedure

Remove the antenna from the EUT and then connect a low loss RF cable from the antenna port to the spectrum.

Test Configuration



Test Results

Raw data reference to Section 2 of document No. CTL2406047073-WF_Bluetooth_Appendix.

3.4. 20dB Bandwidth

Limit

For frequency hopping systems operating in the 2400MHz-2483.5MHz no limit for 20dB bandwidth.

Test Procedure

The transmitter output was connected to the spectrum analyzer through an attenuator. The bandwidth of the fundamental frequency was measured by spectrum analyzer with 30 KHz RBW and 91 KHz VBW.

The 20dB bandwidth is defined as the total spectrum the power of which is higher than peak power minus 20dB.

Test Configuration



Test Results

Raw data reference to Section 1 of document No. CTL2406047073-WF_Bluetooth_Appendix.

3.5. Frequency Separation

LIMIT

According to 15.247(a)(1), frequency hopping systems shall have hopping channel carrier frequencies separated by minimum of 25KHz or the $2/3 * 20\text{dB}$ bandwidth of the hopping channel, whichever is greater.

TEST PROCEDURE

The transmitter output was connected to the spectrum analyzer through an attenuator. The bandwidth of the fundamental frequency was measured by spectrum analyzer with 300 KHz RBW and 300 KHz VBW.

TEST CONFIGURATION



TEST RESULTS

Raw data reference to Section 3 of document No. CTL2406047073-WF_Bluetooth_Appendix.

3.6. Number of hopping frequency

Limit

Frequency hopping systems in the 2400–2483.5 MHz band shall use at least 15 channels.

Test Procedure

The transmitter output was connected to the spectrum analyzer through an attenuator. Set spectrum analyzer start 2400MHz to 2483.5MHz with 300 KHz RBW and 300 KHz VBW.

Test Configuration



Test Results

Raw data reference to Section 4 of document No. CTL2406047073-WF_Bluetooth_Appendix.

3.7. Time of Occupancy (Dwell Time)

Limit

The average time of occupancy on any channel shall not be greater than 400 milliseconds within a period of 400 milliseconds multiplied by the number of hopping channels employed.

Test Procedure

The transmitter output was connected to the spectrum analyzer through an attenuator. Set center frequency of spectrum analyzer=operating frequency with 910 KHz RBW and 910 KHz VBW, Span 0Hz.

Test Configuration



Test Results

Raw data reference to Section 5 of document No. CTL2406047073-WF_Bluetooth_Appendix.

3.8. Out-of-band Emissions

Limit

In any 100 kHz bandwidth outside the frequency band in which the spread spectrum or digitally modulated intentional radiator is operating, the radio frequency power that is produced by the intentional radiator shall be at least 20 dB below that in the 100 kHz bandwidth within the band that contains the highest level of the desired power, based on either an RF conducted or a radiated measurement, provided the transmitter demonstrates compliance with the peak conducted power limits. If the transmitter complies with the conducted power limits based on the use of RMS averaging over a time interval, as permitted under paragraph (b)(3) of this section, the attenuation required under this paragraph shall be 30 dB instead of 20 dB. Attenuation below the general limits specified in §15.209(a) is not required.

Test Procedure

Connect the transmitter output to spectrum analyzer using a low loss RF cable, and set the spectrum analyzer to RBW=100 kHz, VBW= 300 kHz, peak detector , and max hold. Measurements utilizing these setting are made of the in-band reference level, bandedge and out-of-band emissions.

Test Configuration



Test Results

Raw data reference to Section 6 of document No. CTL2406047073-WF_Bluetooth_Appendix.

3.9. Pseudorandom Frequency Hopping Sequence

TEST APPLICABLE

For 47 CFR Part 15C section 15.247 (a) (1) requirement:

Frequency hopping systems shall have hopping channel carrier frequencies separated by a minimum of 25 kHz or the 20 dB bandwidth of the hop-ping channel, whichever is greater. Alternatively, frequency hopping systems operating in the 2400–2483.5 MHz band may have hopping channel carrier frequencies that are separated by 25 kHz or two-thirds of the 20 dB bandwidth of the hopping channel, whichever is greater, provided the systems operate with an output power no greater than 125 mW. The system shall hop to channel frequencies that are selected at the system hopping rate from a pseudo randomly ordered list of hopping frequencies. Each frequency must be used equally on the average by each transmitter. The system receivers shall have input bandwidths that match the hop-ping channel bandwidths of their corresponding transmitters and shall shift frequencies in synchronization with the transmitted signals.

EUT Pseudorandom Frequency Hopping Sequence Requirement

The pseudorandom frequency hopping sequence may be generated in a nine-stage shift register whose 5th and 9th stage outputs are added in a modulo-two addition stage. And the result is fed back to the input of the first stage. The sequence begins with the first one of 9 consecutive ones, for example: the shift register is initialized with nine ones.

- Number of shift register stages:9
- Length of pseudo-random sequence:29-1=511 bits
- Longest sequence of zeros:8(non-inverted signal)

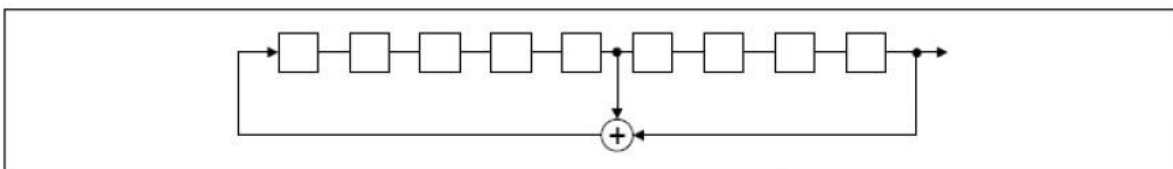

Linear Feedback Shift Register for Generation of the PRBS sequence

An example of pseudorandom frequency hopping sequence as follows:

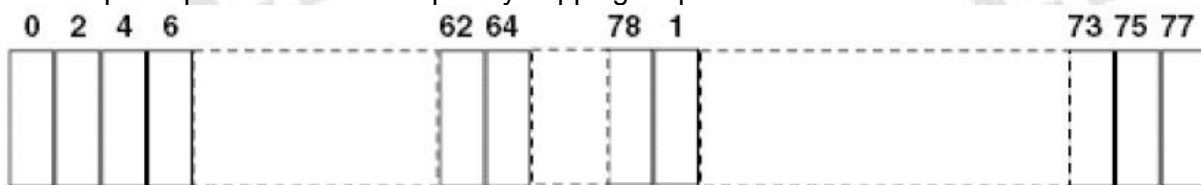

Each frequency used equally one the average by each transmitter.

The system receiver have input bandwidths that match the hopping channel bandwidths of their corresponding transmitter and shift frequencies in synchronization with the transmitted signals.

3.10. Antenna Requirement

Standard Applicable

For intentional device, according to FCC 47 CFR Section 15.203, an intentional radiator shall be designed to ensure that no antenna other than that furnished by the responsible party shall be used with the device.

And according to FCC 47 CFR Section 15.247 (b), if transmitting antennas of directional gain greater than 6dBi are used, the power shall be reduced by the amount in dB that the directional gain of the antenna exceeds 6dBi.

Refer to statement below for compliance

The manufacturer may design the unit so that the user can replace a broken antenna, but the use of a standard antenna jack or electrical connector is prohibited. Further, this requirement does not apply to intentional radiators that must be professionally installed.

Antenna Connected Construction

The maximum gain of antenna was 1.08dBi.

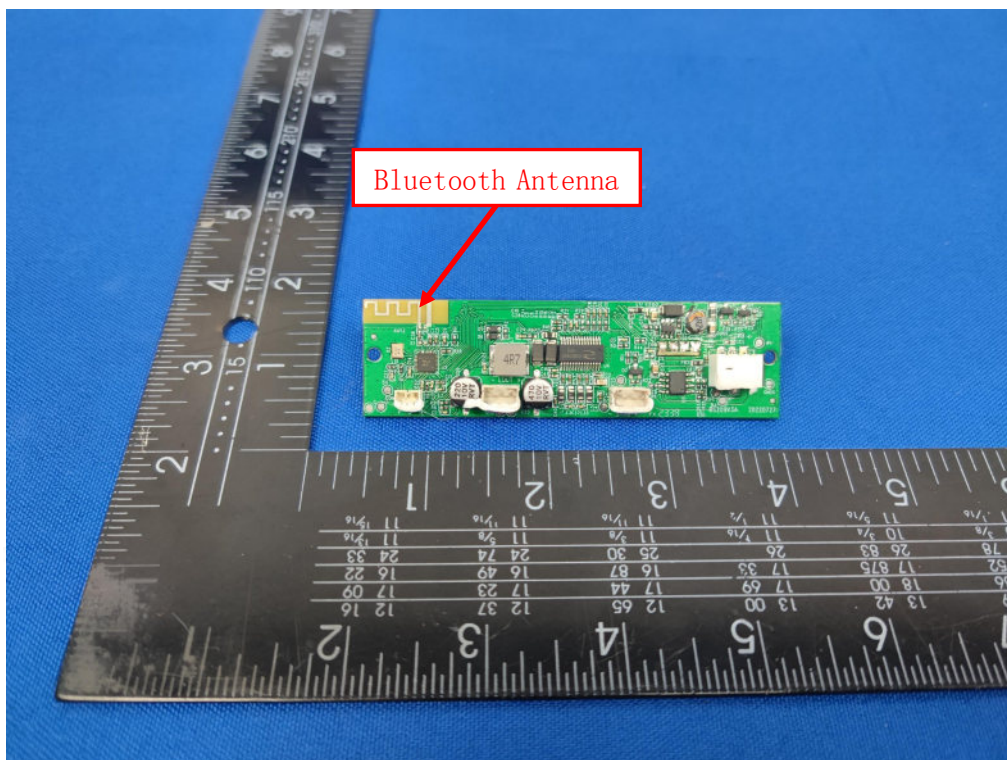

4. Test Setup Photos of the EUT

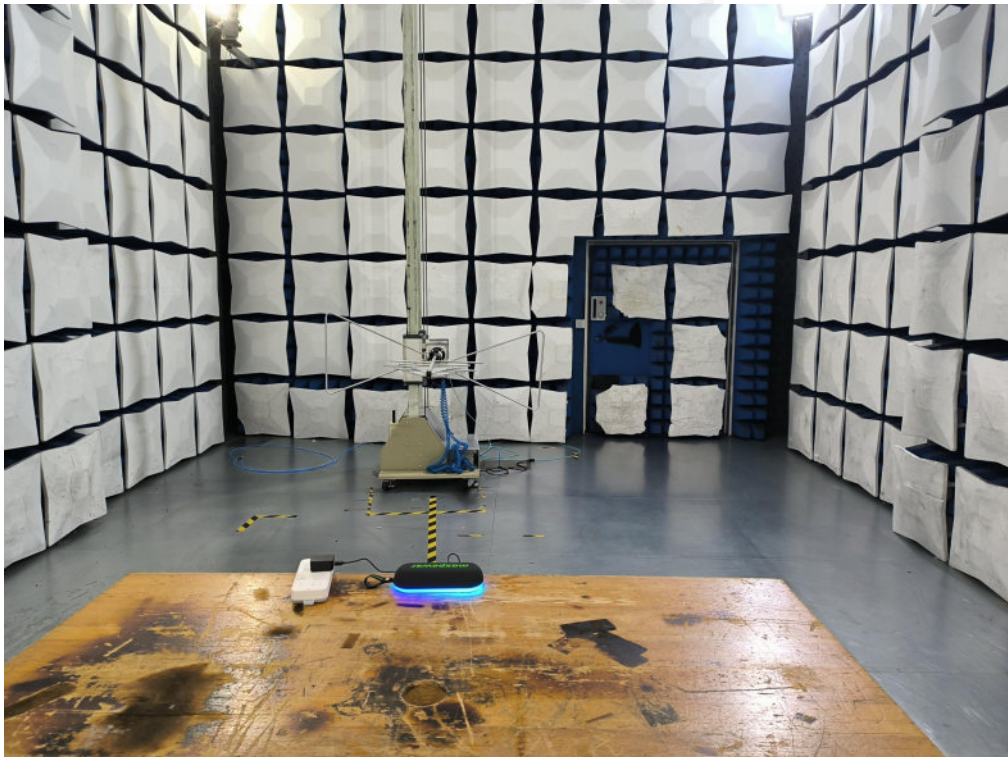



5. Photos of the EUT

External Photos of EUT





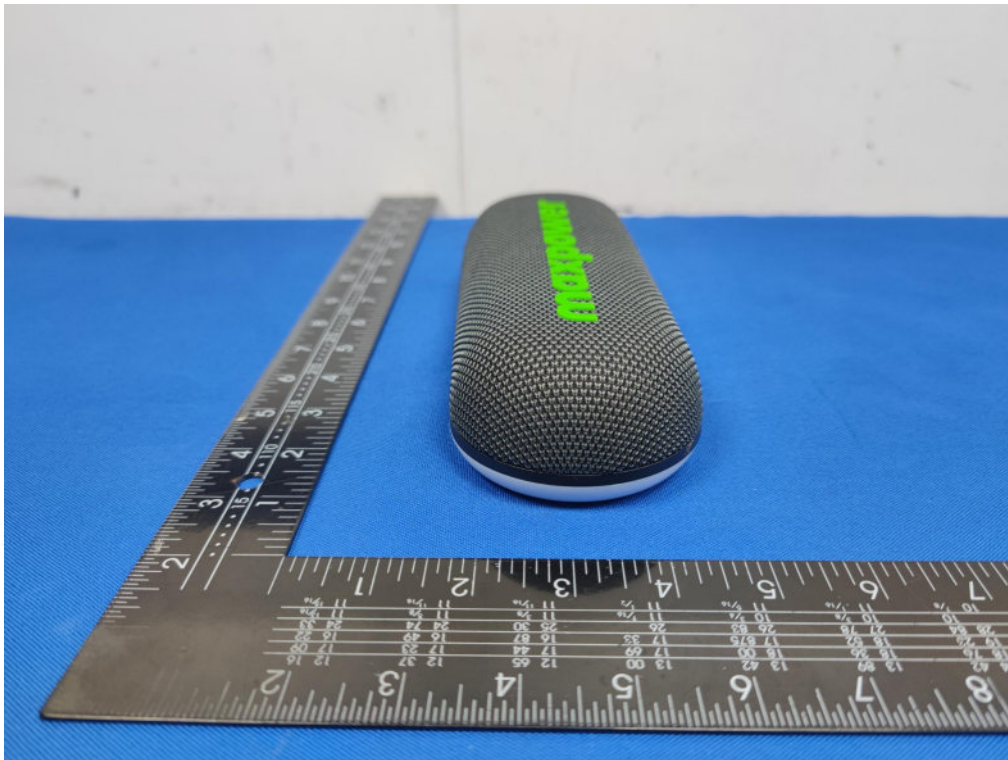

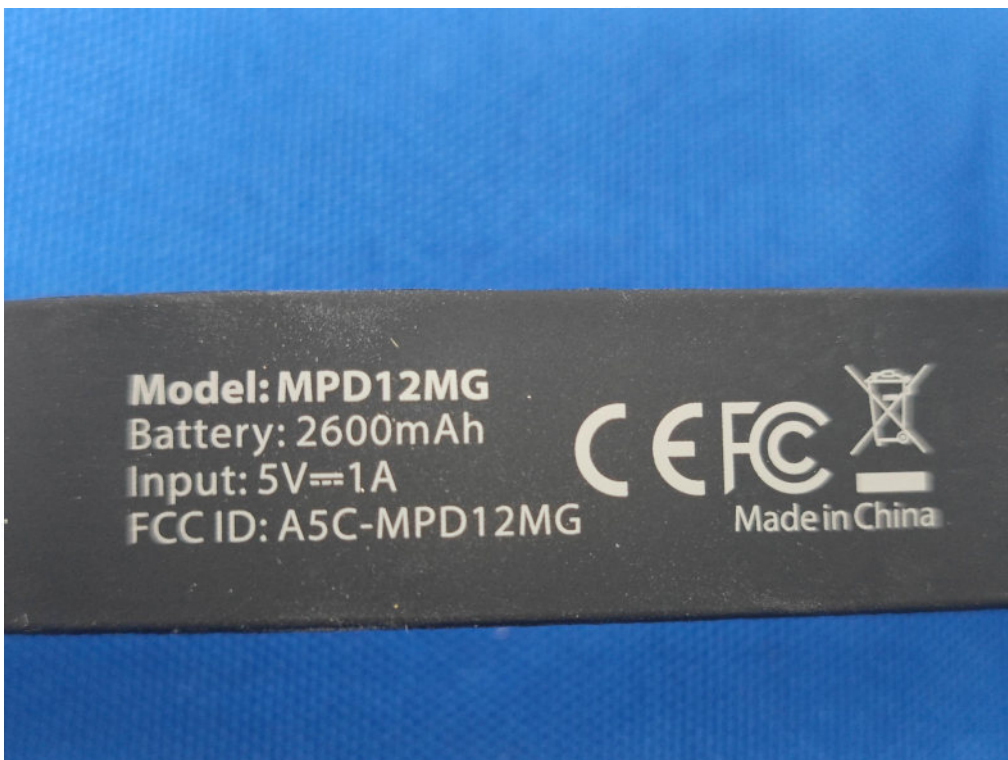
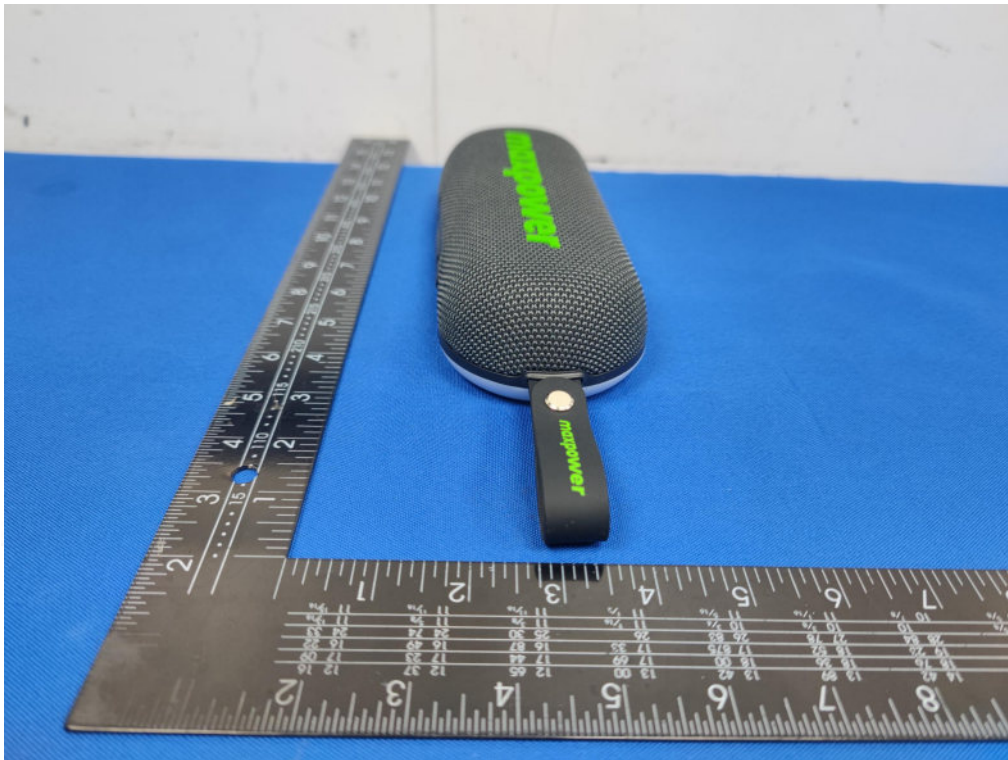

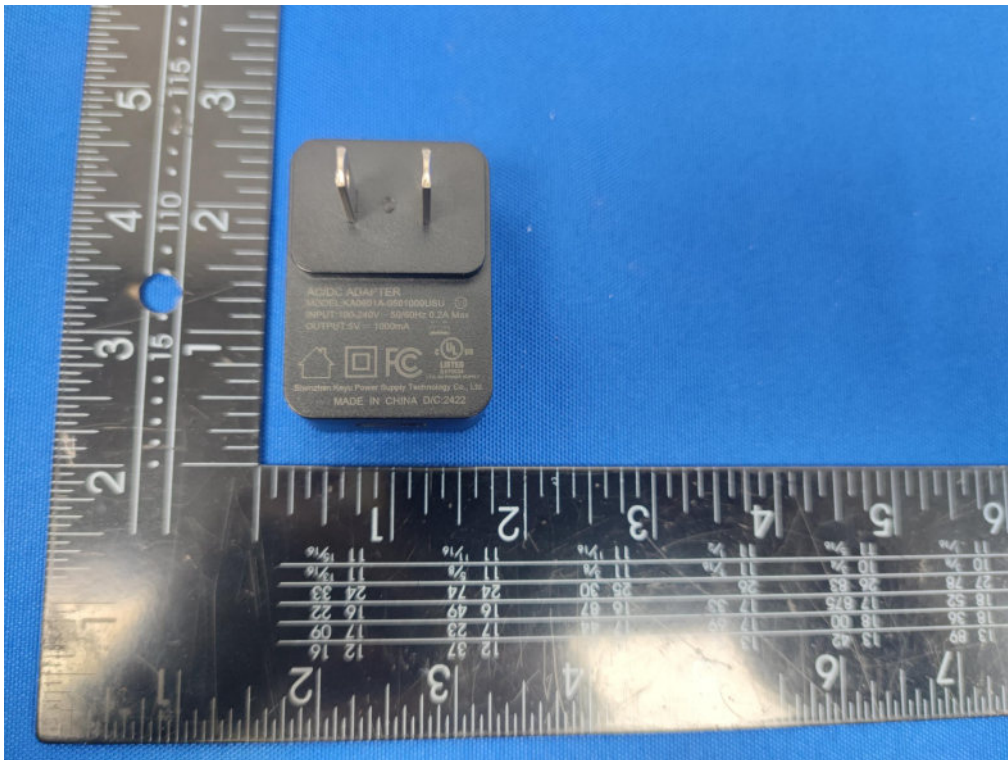



Internal Photos of EUT

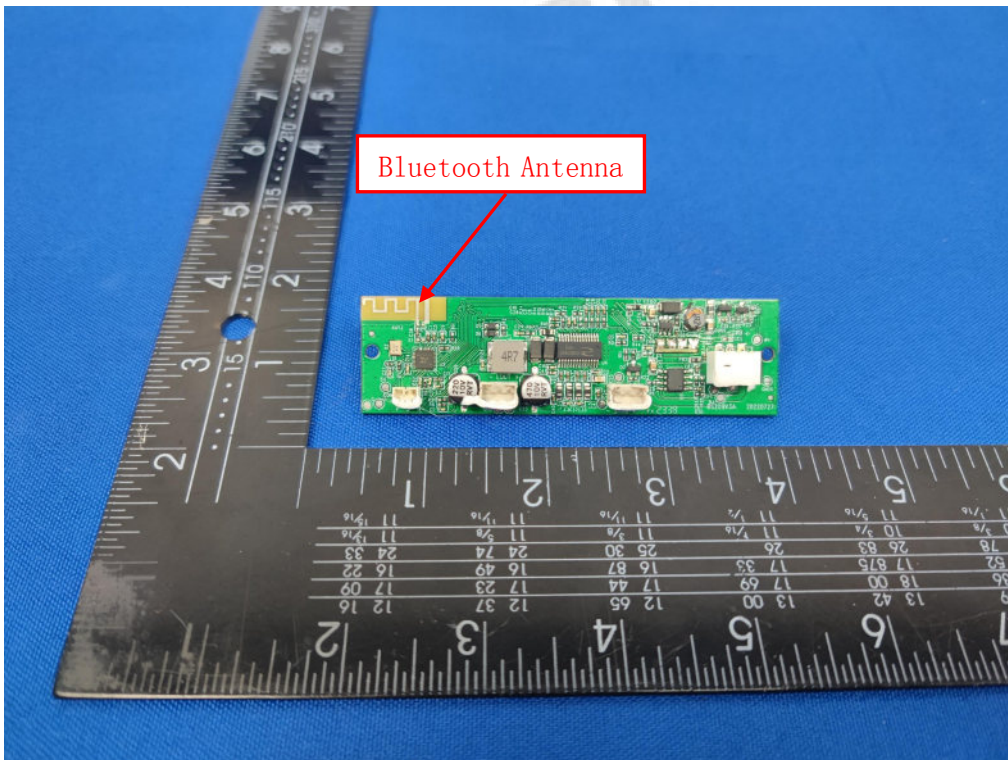
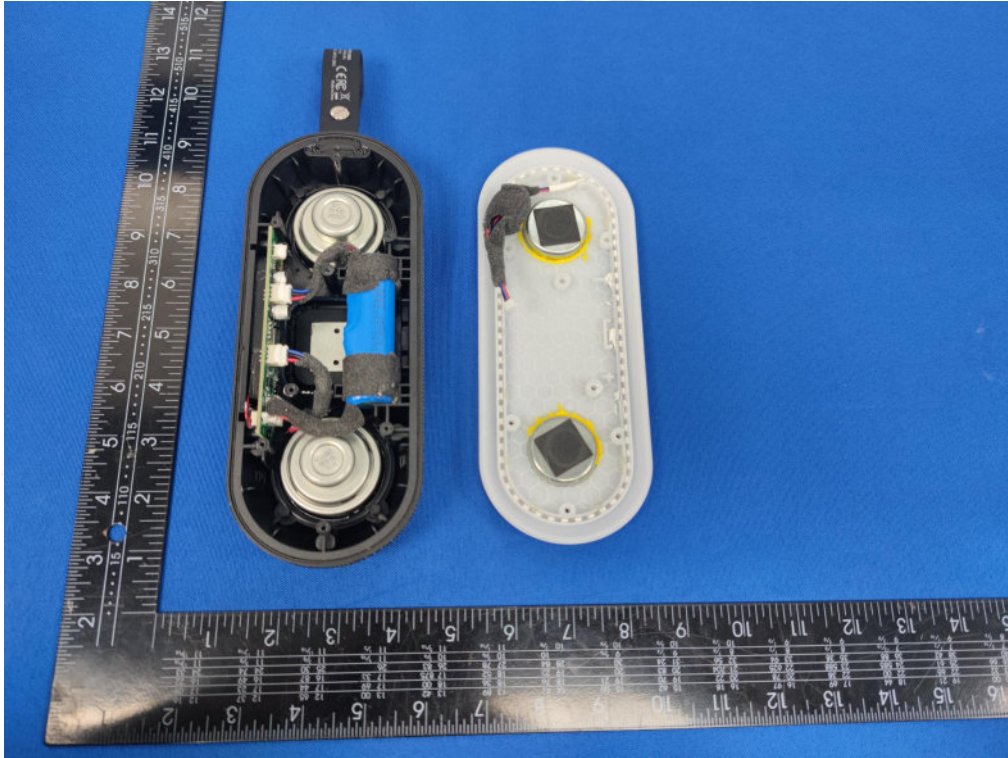

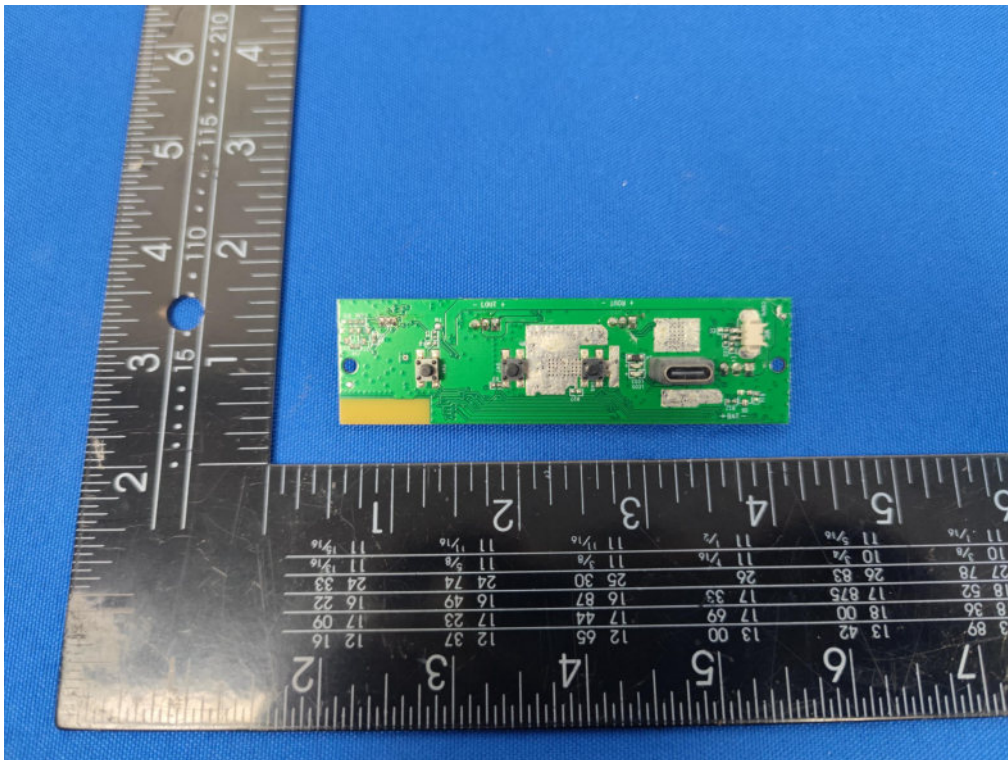
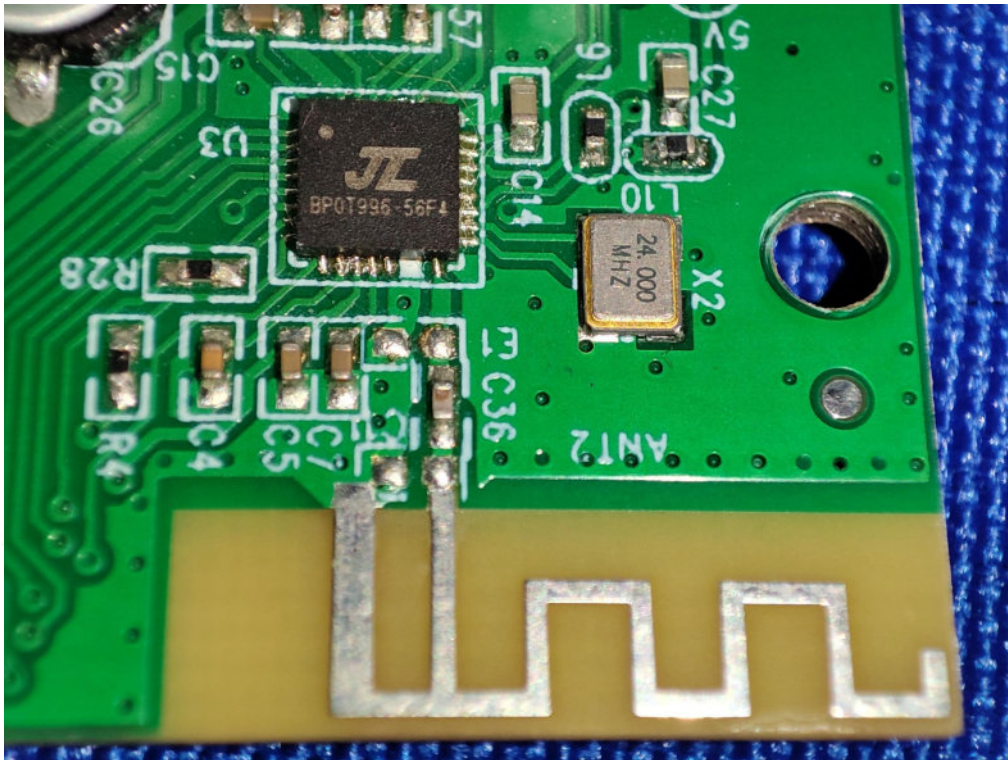

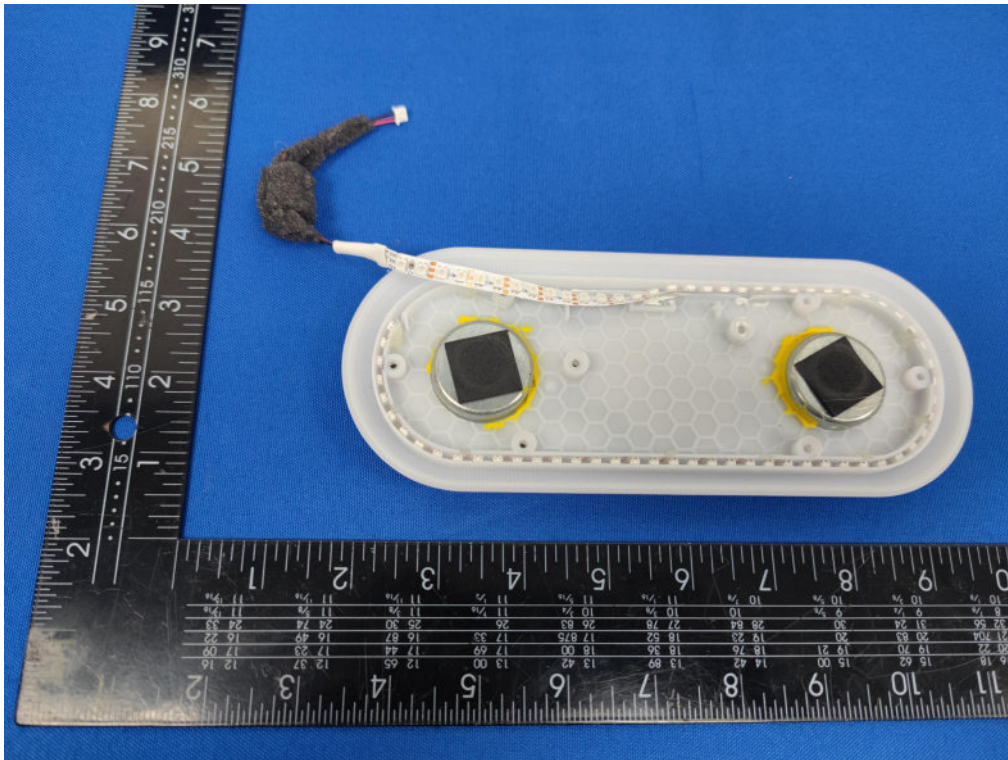



***** End of Report *****