



**FCC 47 CFR PART 15 SUBPART C**

**TEST REPORT**

**For**

**Car Video Recorder**

**Model:  
DrivePro 220**

**Trade Name: Transcend**

*Issued to*

**Transcend Information Inc  
No.70, Xing Zhong Rd., NeiHu Dist., Taipei, Taiwan**

*Issued by*

**Compliance Certification Services Inc.**

**No.11, Wugong 6th Rd., Wugu Dist.,  
New Taipei City 24891, Taiwan. (R.O.C.)**

**<http://www.ccsrf.com>**

**[service@ccsrf.com](mailto:service@ccsrf.com)**

**Issued Date: March 10, 2015**



---

*Note: This report shall not be reproduced except in full, without the written approval of Compliance Certification Services Inc. This document may be altered or revised by Compliance Certification Services Inc. personnel only, and shall be noted in the revision section of the document.*



**Revision History**

Rev.	Issue Date	Revisions	Effect Page	Revised By
00	March 10, 2015	Initial Issue	ALL	Angel Cheng



## TABLE OF CONTENTS

<b>1. TEST RESULT CERTIFICATION.....</b>	<b>4</b>
<b>2. EUT DESCRIPTION .....</b>	<b>5</b>
<b>3. TEST METHODOLOGY .....</b>	<b>6</b>
3.1 EUT CONFIGURATION .....	6
3.2 EUT EXERCISE.....	6
3.3 GENERAL TEST PROCEDURES.....	6
3.4 FCC PART 15.205 RESTRICTED BANDS OF OPERATIONS.....	7
3.5 DESCRIPTION OF TEST MODES .....	8
<b>4. INSTRUMENT CALIBRATION.....</b>	<b>9</b>
4.1 MEASURING INSTRUMENT CALIBRATION .....	9
4.2 MEASUREMENT EQUIPMENT USED .....	9
4.3 MEASUREMENT UNCERTAINTY .....	10
<b>5. FACILITIES AND ACCREDITATIONS .....</b>	<b>11</b>
5.1 FACILITIES .....	11
5.2 EQUIPMENT.....	11
5.3 TABLE OF ACCREDITATIONS AND LISTINGS.....	12
<b>6. SETUP OF EQUIPMENT UNDER TEST .....</b>	<b>13</b>
6.1 SETUP CONFIGURATION OF EUT.....	13
6.2 SUPPORT EQUIPMENT .....	13
<b>7. FCC PART 15.247 REQUIREMENTS.....</b>	<b>14</b>
7.1 6DB BANDWIDTH.....	14
7.2 PEAK POWER.....	25
7.3 AVERAGE POWER .....	27
7.4 BAND EDGES MEASUREMENT .....	29
7.5 PEAK POWER SPECTRAL DENSITY.....	49
7.6 SPURIOUS EMISSIONS.....	60
7.7 RADIATED EMISSIONS .....	70
7.8 POWERLINE CONDUCTED EMISSIONS.....	84
<b>APPENDIX I PHOTOGRAPHS OF TEST SETUP.....</b>	<b>87</b>
<b>APPENDIX 1 - PHOTOGRAPHS OF EUT</b>	



# 1. TEST RESULT CERTIFICATION

**Applicant:** Transcend Information Inc  
 No.70, Xing Zhong Rd., NeiHu Dist., Taipei, Taiwan

**Equipment Under Test:** Car Video Recorder

**Trade Name:** Transcend

**Model:** DrivePro 220

**Date of Test:** February 25 ~ March 5, 2015

APPLICABLE STANDARDS	
STANDARD	TEST RESULT
FCC 47 CFR Part 15 Subpart C	No non-compliance noted

### We hereby certify that:

The above equipment was tested by Compliance Certification Services Inc. The test data, data evaluation, test procedures, and equipment configurations shown in this report were made in accordance with the procedures given in ANSI C63.4: 2009 and the energy emitted by the sample EUT tested as described in this report is in compliance with the requirements of FCC Rules Part 15.207, 15.209, 15.247.

The test results of this report relate only to the tested sample EUT identified in this report.

Approved by:

Reviewed by:

---

Miller Lee  
 Section Manager  
 Compliance Certification Services Inc.

---

Angel Cheng  
 Section Manager  
 Compliance Certification Services Inc.



## 2. EUT DESCRIPTION

<b>Product</b>	Car Video Recorder
<b>Trade Name</b>	Transcend
<b>Model Number</b>	DrivePro 220
<b>Model Discrepancy</b>	N/A
<b>Received Date</b>	February 4, 2015
<b>Power Rating</b>	1. 1. Power form car charge: P/N: RF-299-1085-0 Input: 10-30VDC, 1A(MAX) Output: 4.6-5.25 VDC, 1A 2. Power form battery: Model: 582535 Li-Polymer 3.7V, 470mAh, 1.7Wh
<b>Frequency Range</b>	2412 ~ 2462 MHz
<b>Transmit Power</b>	IEEE 802.11b mode: 16.85 dBm IEEE 802.11g mode: 21.70 dBm IEEE 802.11n HT 20 MHz Channel mode: 20.48dBm
<b>Modulation Technique</b>	IEEE 802.11b mode: DSSS (1, 2, 5.5 and 11 Mbps) IEEE 802.11g mode: OFDM (6, 9, 12, 18, 24, 36, 48 and 54 Mbps) IEEE 802.11n HT 20 mode: OFDM (7.2, 14.4, 21.7,28.9,43.3,57.8,65.0, 72.2 Mbps)
<b>Number of Channels</b>	IEEE 802.11b/g mode: 11 Channels IEEE 802.11n HT 20 mode: 11 Channels
<b>Antenna Specification</b>	Chip Antenna / Gain: 3.32dBi

**Remark:**

1. The sample selected for test was engineering sample that approximated to production product and was provided by manufacturer.
2. This submittal(s) (test report) is intended for FCC ID: **A4Z-DP220** filing to comply with Section 15.207, 15.209 and 15.247 of the FCC Part 15, Subpart C Rules.



### **3. TEST METHODOLOGY**

The tests documented in this report were performed in accordance with ANSI C63.4: 2009 and FCC CFR 47 Part 15.207, 15.209, 15.247, KDB558074.

#### **3.1 EUT CONFIGURATION**

The EUT configuration for testing is installed on RF field strength measurement to meet the Commissions requirement and operating in a manner that intends to maximize its emission characteristics in a continuous normal application.

#### **3.2 EUT EXERCISE**

The EUT was operated in the engineering mode to fix the TX frequency that was for the purpose of the measurements.

According to its specifications, the EUT must comply with the requirements of the Section 15.207, 15.209 and 15.247 under the FCC Rules Part 15 Subpart C.

#### **3.3 GENERAL TEST PROCEDURES**

##### **Conducted Emissions**

The EUT is placed on the turntable, which is 0.8 m above ground plane. According to the requirements in Section 13.1.4.1 of ANSI C63.4 Conducted emissions from the EUT measured in the frequency range between 0.15 MHz and 30MHz using CISPR Quasi-peak and average detector modes.

##### **Radiated Emissions**

The EUT is placed on a turn table, which is 0.8 m above ground plane. The turntable shall rotate 360 degrees to determine the position of maximum emission level. EUT is set 3m away from the receiving antenna, which varied from 1m to 4m to find out the highest emission. And also, each emission was to be maximized by changing the polarization of receiving antenna both horizontal and vertical. In order to find out the maximum emissions, exploratory radiated emission measurements were made according to the requirements in Section 13.1.4.1 of ANSI C63.4.



### 3.4 FCC PART 15.205 RESTRICTED BANDS OF OPERATIONS

(a) Except as shown in paragraph (d) of this section, only spurious emissions are permitted in any of the frequency bands listed below:

MHz	MHz	MHz	GHz
0.090 - 0.110	16.42 - 16.423	399.9 - 410	4.5 - 5.15
<sup>1</sup> 0.495 - 0.505	16.69475 - 16.69525	608 - 614	5.35 - 5.46
2.1735 - 2.1905	16.80425 - 16.80475	960 - 1240	7.25 - 7.75
4.125 - 4.128	25.5 - 25.67	1300 - 1427	8.025 - 8.5
4.17725 - 4.17775	37.5 - 38.25	1435 - 1626.5	9.0 - 9.2
4.20725 - 4.20775	73 - 74.6	1645.5 - 1646.5	9.3 - 9.5
6.215 - 6.218	74.8 - 75.2	1660 - 1710	10.6 - 12.7
6.26775 - 6.26825	108 - 121.94	1718.8 - 1722.2	13.25 - 13.4
6.31175 - 6.31225	123 - 138	2200 - 2300	14.47 - 14.5
8.291 - 8.294	149.9 - 150.05	2310 - 2390	15.35 - 16.2
8.362 - 8.366	156.52475 -	2483.5 - 2500	17.7 - 21.4
8.37625 - 8.38675	156.52525	2655 - 2900	22.01 - 23.12
8.41425 - 8.41475	156.7 - 156.9	3260 - 3267	23.6 - 24.0
12.29 - 12.293	162.0125 - 167.17	3332 - 3339	31.2 - 31.8
12.51975 - 12.52025	167.72 - 173.2	3345.8 - 3358	36.43 - 36.5
12.57675 - 12.57725	240 - 285	3600 - 4400	( <sup>2</sup> )
13.36 - 13.41	322 - 335.4		

<sup>1</sup> Until February 1, 1999, this restricted band shall be 0.490-0.510 MHz.

<sup>2</sup> Above 38.6

(b) Except as provided in paragraphs (d) and (e), the field strength of emissions appearing within these frequency bands shall not exceed the limits shown in Section 15.209. At frequencies equal to or less than 1000 MHz, compliance with the limits in Section 15.209 shall be demonstrated using measurement instrumentation employing a CISPR quasi-peak detector. Above 1000 MHz, compliance with the emission limits in Section 15.209 shall be demonstrated based on the average value of the measured emissions. The provisions in Section 15.35 apply to these measurements.



### **3.5 DESCRIPTION OF TEST MODES**

The EUT (model: DrivePro 220 ) had been tested under operating condition.

Software used to control the EUT for staying in continuous transmitting mode was programmed.

After verification, all tests were carried out with the worst case test modes as shown below except radiated spurious emission below 1GHz and power line conducted emissions below 30MHz, which worst case was in normal link mode only.

#### **IEEE 802.11b mode:**

Channel Low (2412MHz), Channel Mid (2437MHz) and Channel High (2462MHz) with 1Mbps data rate were chosen for full testing.

#### **IEEE 802.11g mode:**

Channel Low (2412MHz), Channel Mid (2437MHz) and Channel High (2462MHz) with 6Mbps data rate were chosen for full testing.

#### **IEEE 802.11n HT 20 mode:**

Channel Low (2412MHz), Channel Mid (2437MHz) and Channel High (2462MHz) with 6.5Mbps data rate were chosen for full testing.





## 4. INSTRUMENT CALIBRATION

### 4.1 MEASURING INSTRUMENT CALIBRATION

The measuring equipment, which was utilized in performing the tests documented herein, has been calibrated in accordance with the manufacturer's recommendations for utilizing calibration equipment, which is traceable to recognized national standards.

### 4.2 MEASUREMENT EQUIPMENT USED

#### Equipment Used for Emissions Measurement

*Remark: Each piece of equipment is scheduled for calibration once a year.*

Conducted Emissions Test Site				
Name of Equipment	Manufacturer	Model	Serial Number	Calibration Due
Spectrum Analyzer	Agilent	E4446A	US42510252	11/23/2015
Thermostatic/Hrgrosatic Chamber	TAICHY	MHG-150LF	930619	10/07/2015
AC Power Source	EXTECH	6205	1140845	N.C.R
DC Power Supply	ABM	8301HD	D011531	N.C.R
Power Meter	Anritsu	ML2495A	1012009	06/03/2015
Power Sensor	Anritsu	MA2411A	0917072	06/03/2015
Spectrum Analyzer	ROHDE&SCHWARZ	FSV40	101073	07/09/2015

Wugu 966 Chamber A				
Name of Equipment	Manufacturer	Model	Serial Number	Calibration Due
Spectrum Analyzer	Agilent	E4446A	US42510268	09/18/2015
EMI Test Receiver	R&S	ESCI	100064	05/30/2015
Bilog Antenna	Sunol Sciences	JB3	A030105	08/19/2015
Horn Antenna	EMCO	3117	00055165	01/26/2016
Turn Table	CCS	CC-T-1F	N/A	N.C.R
Antenna Tower	CCS	CC-A-1F	N/A	N.C.R
Controller	CCS	CC-C-1F	N/A	N.C.R
Test S/W	EZ-EMC (CCS-3A1RE)			

Conducted Emission Room #B				
Name of Equipment	Manufacturer	Model	Serial Number	Calibration Due
EMI Test Receiver	R&S	ESCI	101073	09/18/2015
LISN	R&S	ENV216	101054	05/18/2015
LISN	SCHWARZBECK	NSLK 8127	8127-541	11/25/2015
Capacitive Voltage Probe	FCC	F-CVP-1	100185	03/09/2015
Test S/W	CCS-3A1-CE			



### 4.3 MEASUREMENT UNCERTAINTY

PARAMETER	UNCERTAINTY
Powerline Conducted Emission	+/- 1.2575
3M Semi Anechoic Chamber / <200M	+/- 4.0138
3M Semi Anechoic Chamber / 200M~1000M	+/- 3.9483
3M Semi Anechoic Chamber / 1G~8G	+/- 2.5975
3M Semi Anechoic Chamber / 8G~18G	+/- 2.6112
3M Semi Anechoic Chamber / 18G~26G	+/- 2.7389
3M Semi Anechoic Chamber / 26G~40G	+/- 2.9683

**Remark:** This uncertainty represents an expanded uncertainty expressed at approximately the 95% confidence level using a coverage factor of  $k=2$ .



## 5. FACILITIES AND ACCREDITATIONS

### 5.1 FACILITIES

All measurement facilities used to collect the measurement data are located at

No.199, Chungshen Road, Hsintien City, Taipei Hsien, Taiwan, R.O.C.

Tel: 886-2-2217-0894 / Fax: 886-2-2217-1029

No.11, Wugong 6th Rd., Wugu Dist., New Taipei City 24891, Taiwan. (R.O.C.)

Tel: 886-2-2299-9720 / Fax: 886-2-2298-4045

No.81-1, Lane 210, Bade 2nd Rd., Lujhu Township, Taoyuan County 33841, TAIWAN, R.O.C.

Tel: 886-3-324-0332 / Fax: 886-3-324-5235

The sites are constructed in conformance with the requirements of ANSI C63.7, ANSI C63.4 and CISPR Publication 22.

### 5.2 EQUIPMENT

Radiated emissions are measured with one or more of the following types of linearly polarized antennas: tuned dipole, biconical, log periodic, bi-log, and/or ridged waveguide, horn. Spectrum analyzers with pre-selectors and quasi-peak detectors are used to perform radiated measurements.



Conducted emissions are measured with Line Impedance Stabilization Networks and EMI Test Receivers.

Calibrated wideband preamplifiers, coaxial cables, and coaxial attenuators are also used for making measurements.

All receiving equipment conforms to CISPR Publication 16-1, "Radio Interference Measuring Apparatus and Measurement Methods."



### 5.3 TABLE OF ACCREDITATIONS AND LISTINGS

Country	Agency	Scope of Accreditation	Logo
USA	FCC	3M Semi Anechoic Chamber (FCC MRA: TW1039) to perform FCC Part 15 measurements	 FCC MRA: TW1039
Taiwan	TAF	LP0002, RTTE01, FCC Method-47 CFR Part 15 Subpart C, D, E, RSS-210, RSS-310 IDA TS SRD, AS/NZS 4268, AS/NZS 4771, TS 12.1 & 12.2, ETSI EN 300 440-1, ETSI EN 300 440-2, ETSI EN 300 328, ETSI EN 300 220-1, ETSI EN 300 220-2, ETSI EN 301 893, ETSI EN 301 489-1/3/7/17 FCC OET Bulletin 65 + Supplement C, EN 50360, EN 50361, EN 50371, RSS 102, EN 50383, EN 50385, EN 50392, IEC 62209, CNS 14958-1, CNS 14959 FCC Method -47 CFR Part 15 Subpart B IEC / EN 61000-3-2, IEC / EN 61000-3-3, IEC / EN 61000-4-2/3/4/5/6/8/11	
Canada	Industry Canada	3M Semi Anechoic Chamber (IC 2324G-1 / IC 2324G-2) to perform	

\* No part of this report may be used to claim or imply product endorsement by A2LA or any agency of the US Government.



## 6. SETUP OF EQUIPMENT UNDER TEST

### 6.1 SETUP CONFIGURATION OF EUT

See test photographs attached in Appendix II for the actual connections between EUT and support equipment.

### 6.2 SUPPORT EQUIPMENT

No	Device Type	Brand	Model	Series No.	FCC ID	Data Cable	Power Cord
1.	Notebook PC	DELL	PP19L	7B3ZP1S	N/A	N/A	AC I/P: Unshielded, 1.8m DC O/P: Unshielded, 1.8m with a core
2.	Notebook PC	HP	dv6-1332TX	CNF9491GPS	PD9112BNHU	N/A	AC I/P: Unshielded, 1.8m DC O/P: Unshielded, 1.8m with a core

**Remark:**

1. All the equipment/cables were placed in the worst-case configuration to maximize the emission during the test.
2. Grounding was established in accordance with the manufacturer's requirements and conditions for the intended use.



## 7. FCC PART 15.247 REQUIREMENTS

### 7.1 6DB BANDWIDTH

#### LIMIT

According to §15.247(a)(2), systems using digital modulation techniques may operate in the 902 - 928 MHz, 2400 - 2483.5 MHz, and 5725 - 5850 MHz bands. The minimum 6dB bandwidth shall be at least 500 kHz.

#### Test Configuration

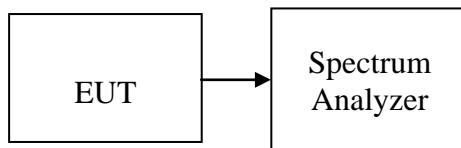

#### TEST PROCEDURE

The transmitter output is connected to the spectrum analyzer. Set the RBW=100kHz the emission bandwidth, VBW  $\geq 3 \times$  RBW, Detector = Peak, Trace mode = max hold, Sweep = auto couple. Measure the maximum width of the emission that is constrained by the frequencies associated with the two amplitude points (upper and lower) that are attenuated by 6dB relative to the maximum level measured in the fundamental emission.

#### TEST RESULTS

*No non-compliance noted*



**Test Data**

**Test mode: IEEE 802.11b mode**

Channel	Frequency (MHz)	6dB Bandwidth (MHz)	Limit (kHz)	Result
Low	2412	8.3334	>500	PASS
Mid	2437	8.75		PASS
High	2462	8.3334		PASS

**Test mode: IEEE 802.11g mode**

Channel	Frequency (MHz)	6dB Bandwidth (MHz)	Limit (kHz)	Result
Low	2412	16.1667	>500	PASS
Mid	2437	16.1667		PASS
High	2462	16.0833		PASS

**Test mode: IEEE 802.11n HT 20 mode**

Channel	Frequency (MHz)	6dB Bandwidth (MHz)	Limit (kHz)	Result
Low	2412	17.4166	>500	PASS
Mid	2437	17.3333		PASS
High	2462	17.4167		PASS



IEEE 802.11b mode

6dB Bandwidth (CH Low)

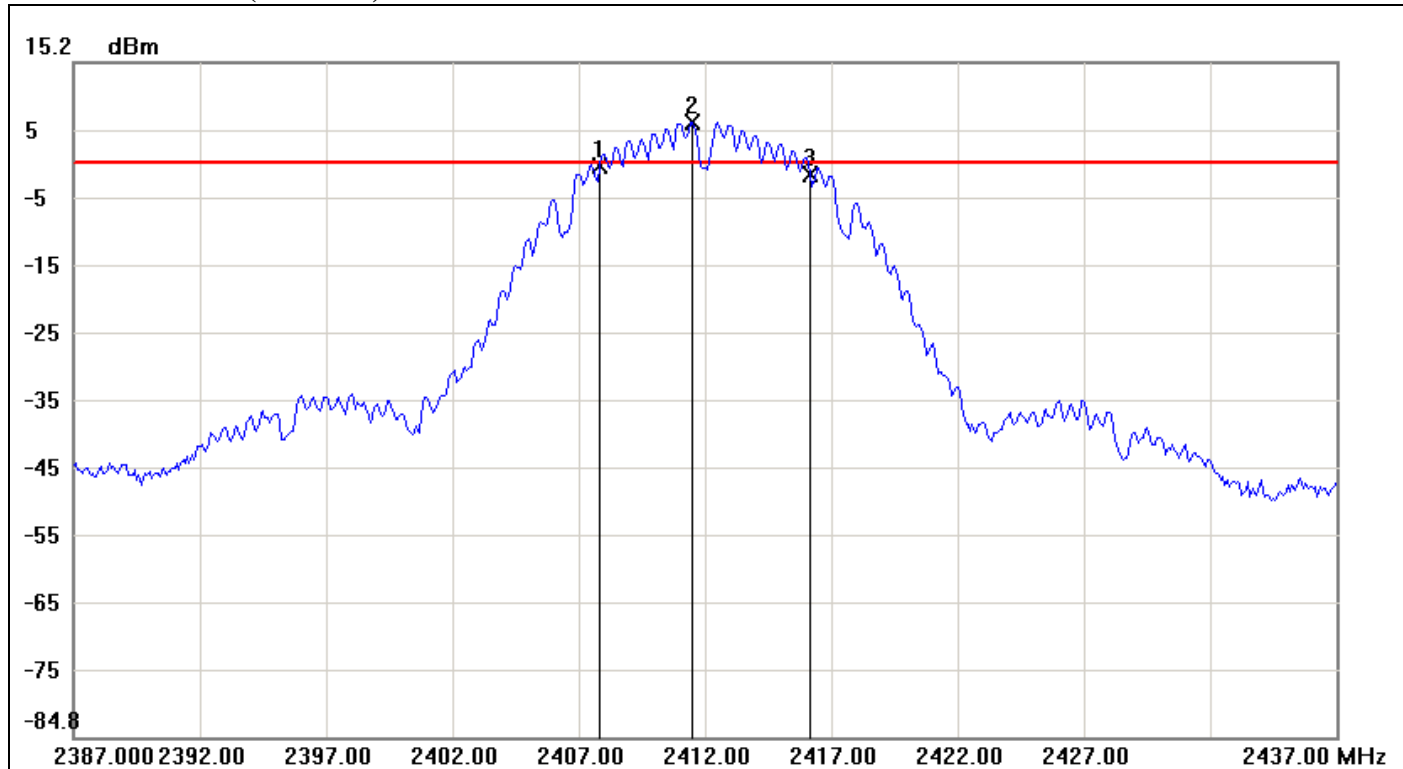

No.	Frequency(MHz)	Result(dBm)	Limit(dBm)	Margin(dBm)
1	2407.8333	-0.12	0.35	-0.47
2	2411.5000	6.35	0.35	6.00
3	2416.1667	-1.46	0.35	-1.81

No.		$\Delta$ Frequency(MHz)	$\Delta$ Level(dB)
1	mk3-mk1	8.3334	-1.34





### 6dB Bandwidth (CH Mid)

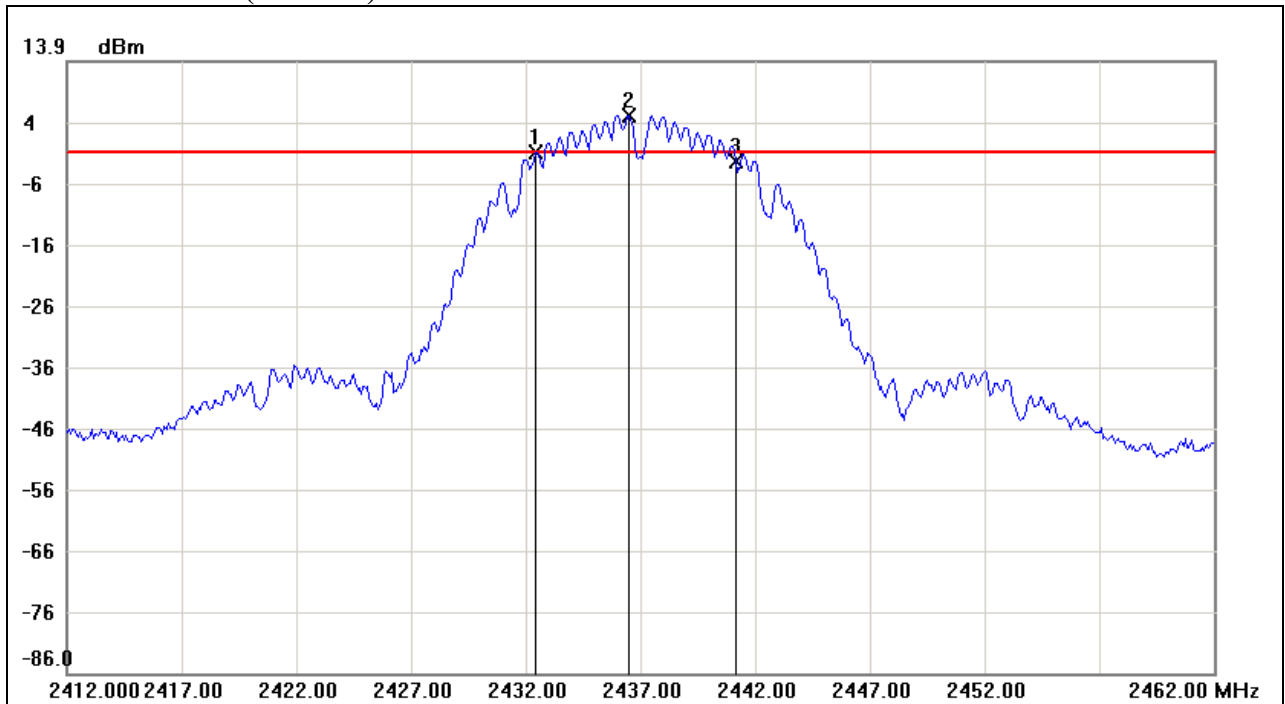

No.	Frequency(MHz)	Result(dBm)	Limit(dBm)	Margin(dBm)
1	2432.4167	-0.98	-0.89	-0.09
2	2436.5000	5.11	-0.89	6.00
3	2441.1667	-2.48	-0.89	-1.59

No.		$\Delta$ Frequency(MHz)	$\Delta$ Level(dB)
1	mk3-mk1	8.75	-1.5



**6dB Bandwidth (CH High)**

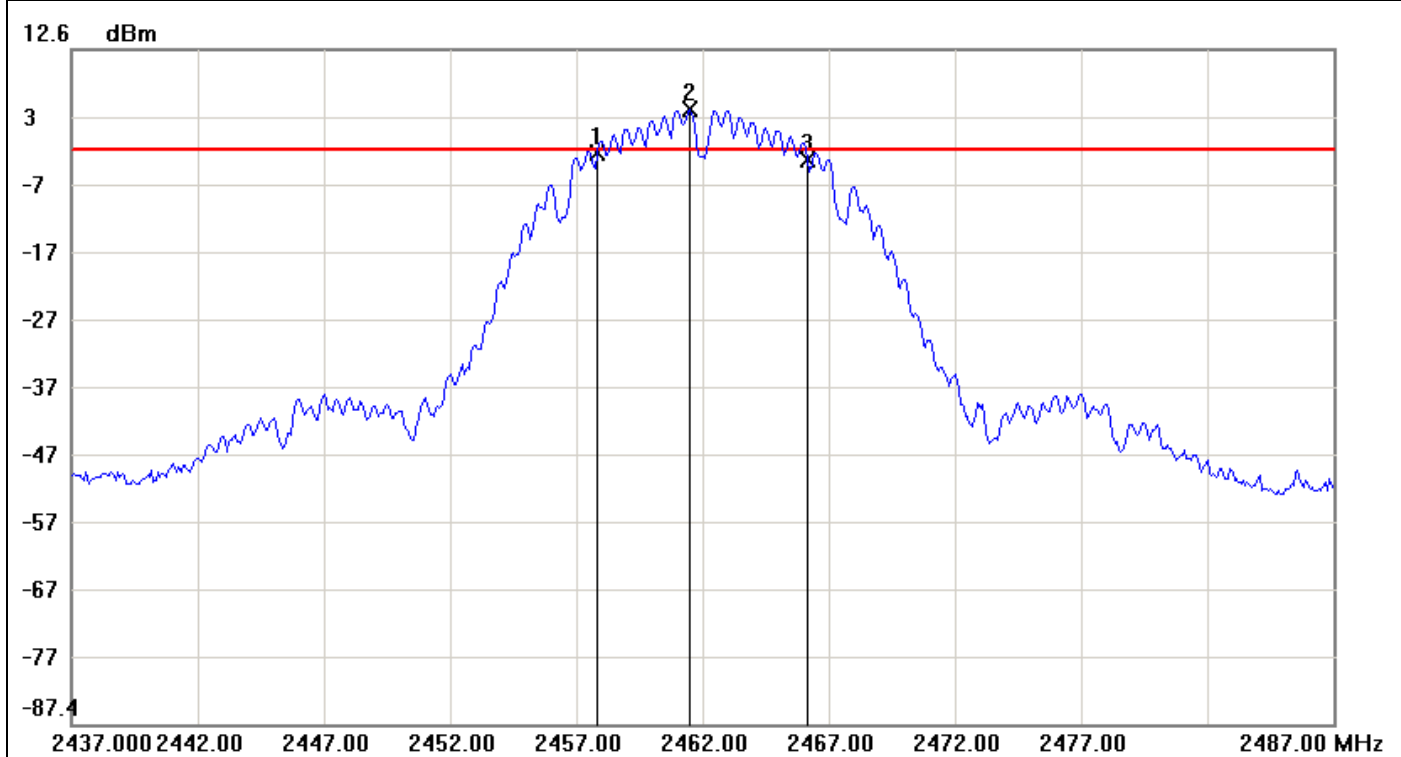

No.	Frequency(MHz)	Result(dBm)	Limit(dBm)	Margin(dBm)
1	2457.8333	-2.81	-2.38	-0.43
2	2461.5000	3.62	-2.38	6.00
3	2466.1667	-3.84	-2.38	-1.46

No.		$\Delta$ Frequency(MHz)	$\Delta$ Level(dB)
1	mk3-mk1	8.3334	-1.03



IEEE 802.11g mode

6dB Bandwidth (CH Low)

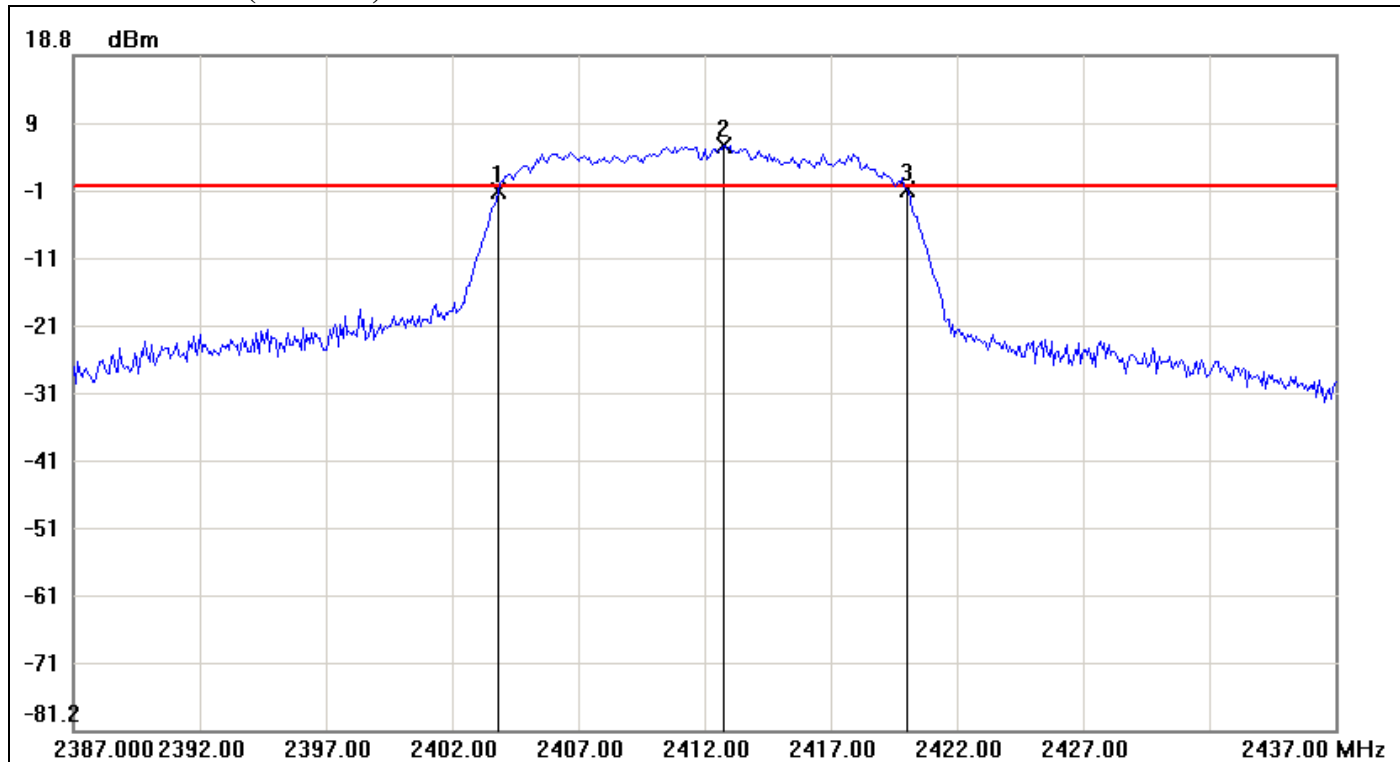

No.	Frequency(MHz)	Result(dBm)	Limit(dBm)	Margin(dBm)
1	2403.8333	-1.28	-0.50	-0.78
2	2412.7500	5.50	-0.50	6.00
3	2420.0000	-1.11	-0.50	-0.61

No.		$\Delta$ Frequency(MHz)	$\Delta$ Level(dB)
1	mk3-mk1	16.1667	0.17



**6dB Bandwidth (CH Mid)**

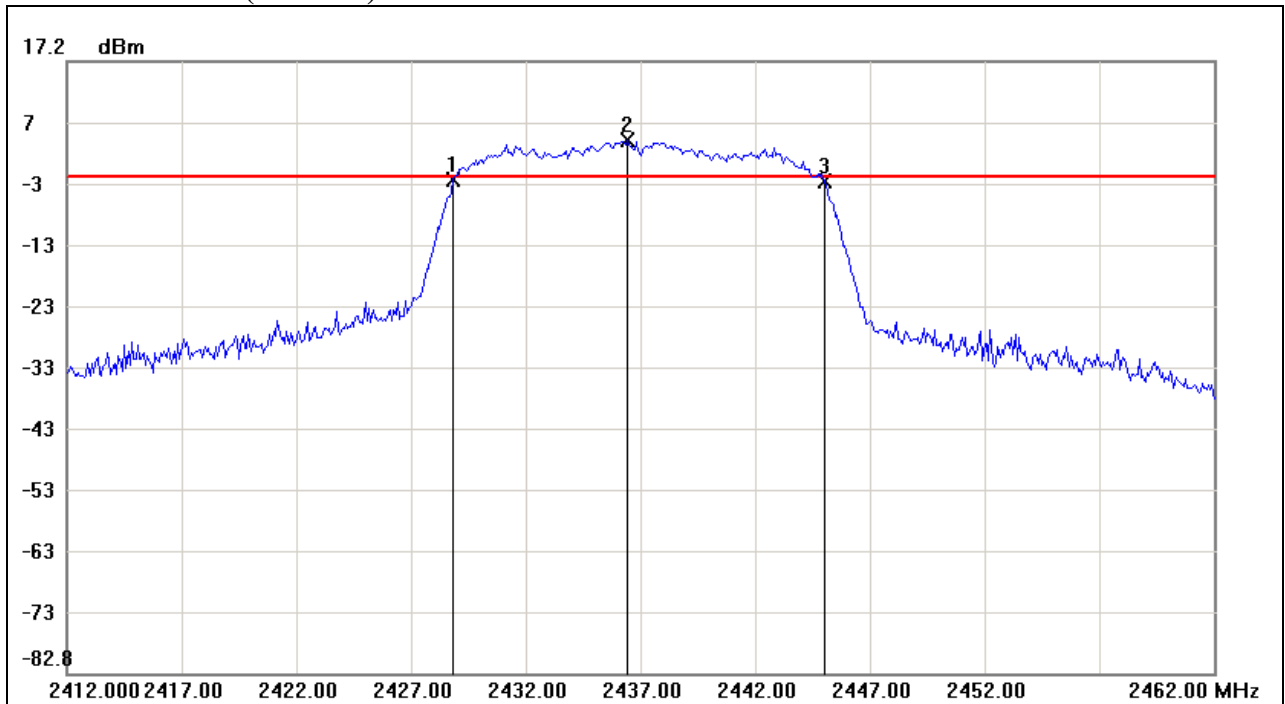

No.	Frequency(MHz)	Result(dBm)	Limit(dBm)	Margin(dBm)
1	2428.8333	-2.30	-1.77	-0.53
2	2436.4167	4.23	-1.77	6.00
3	2445.0000	-2.50	-1.77	-0.73

No.		$\Delta$ Frequency(MHz)	$\Delta$ Level(dB)
1	mk3-mk1	16.1667	-0.2



### 6dB Bandwidth (CH High)

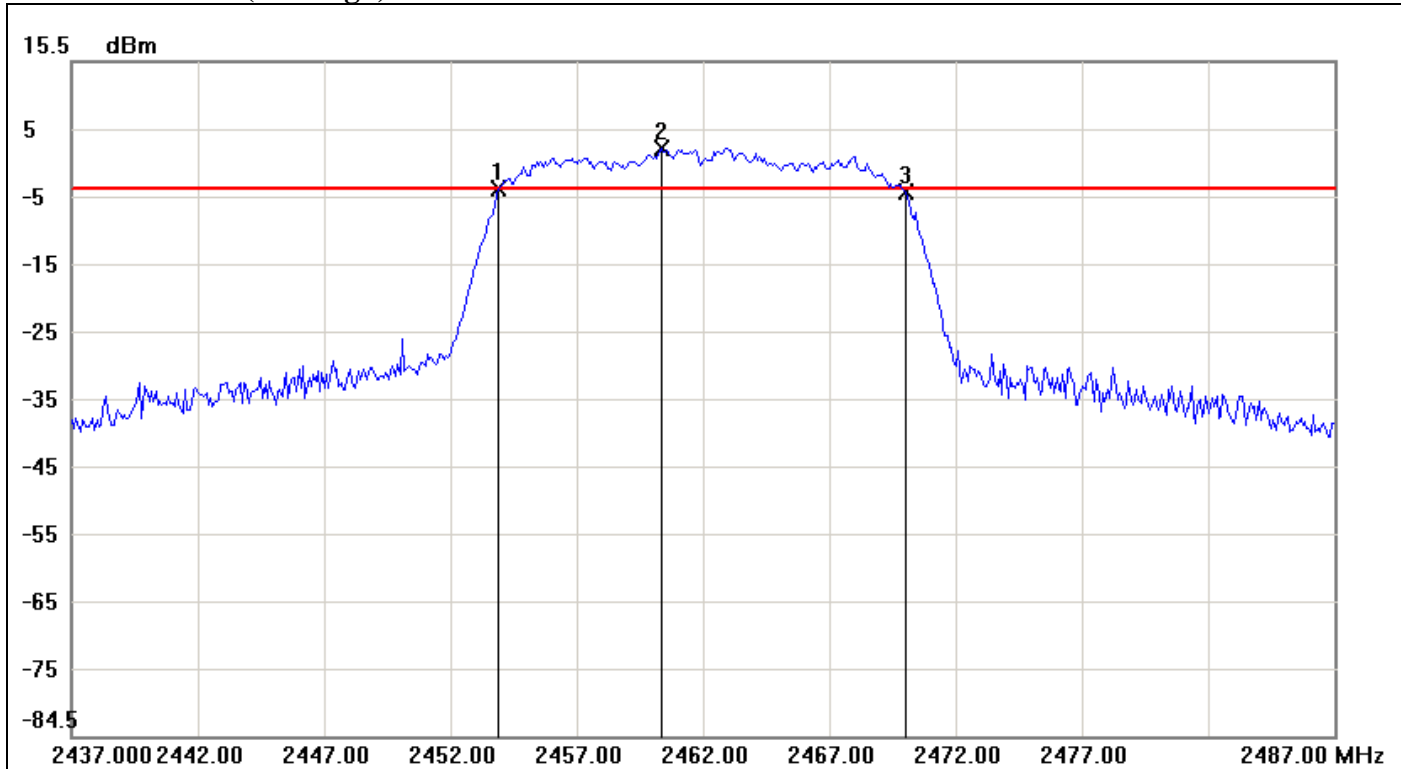

No.	Frequency(MHz)	Result(dBm)	Limit(dBm)	Margin(dBm)
1	2453.9167	-3.44	-3.39	-0.05
2	2460.3333	2.61	-3.39	6.00
3	2470.0000	-3.92	-3.39	-0.53

No.		$\Delta$ Frequency(MHz)	$\Delta$ Level(dB)
1	mk3-mk1	16.0833	-0.48



IEEE 802.11n HT 20 mode

6dB Bandwidth (CH Low)

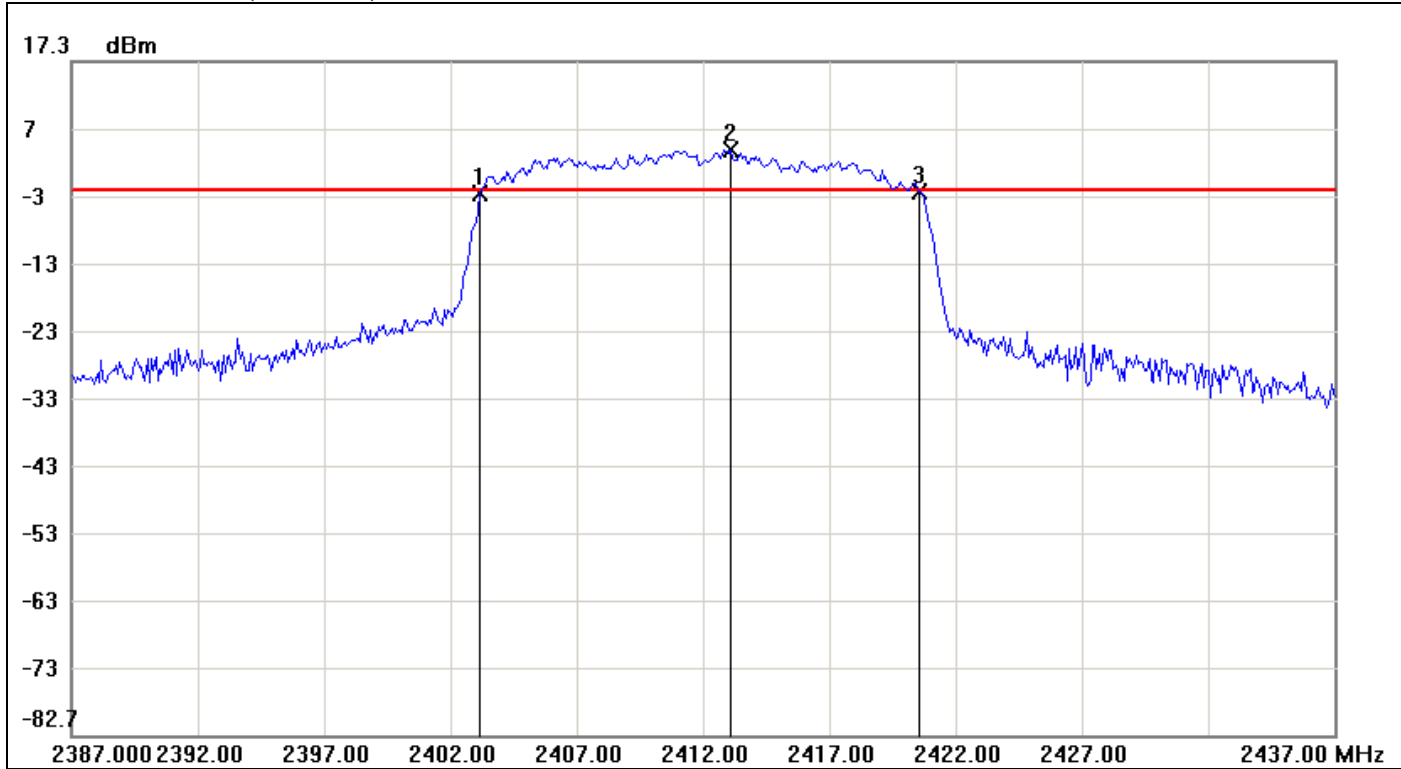

No.	Frequency(MHz)	Result(dBm)	Limit(dBm)	Margin(dBm)
1	2403.1667	-2.35	-1.72	-0.63
2	2413.0833	4.28	-1.72	6.00
3	2420.5833	-2.18	-1.72	-0.46

No.		$\Delta$ Frequency(MHz)	$\Delta$ Level(dB)
1	mk3-mk1	17.4166	0.17



**6dB Bandwidth (CH Mid)**

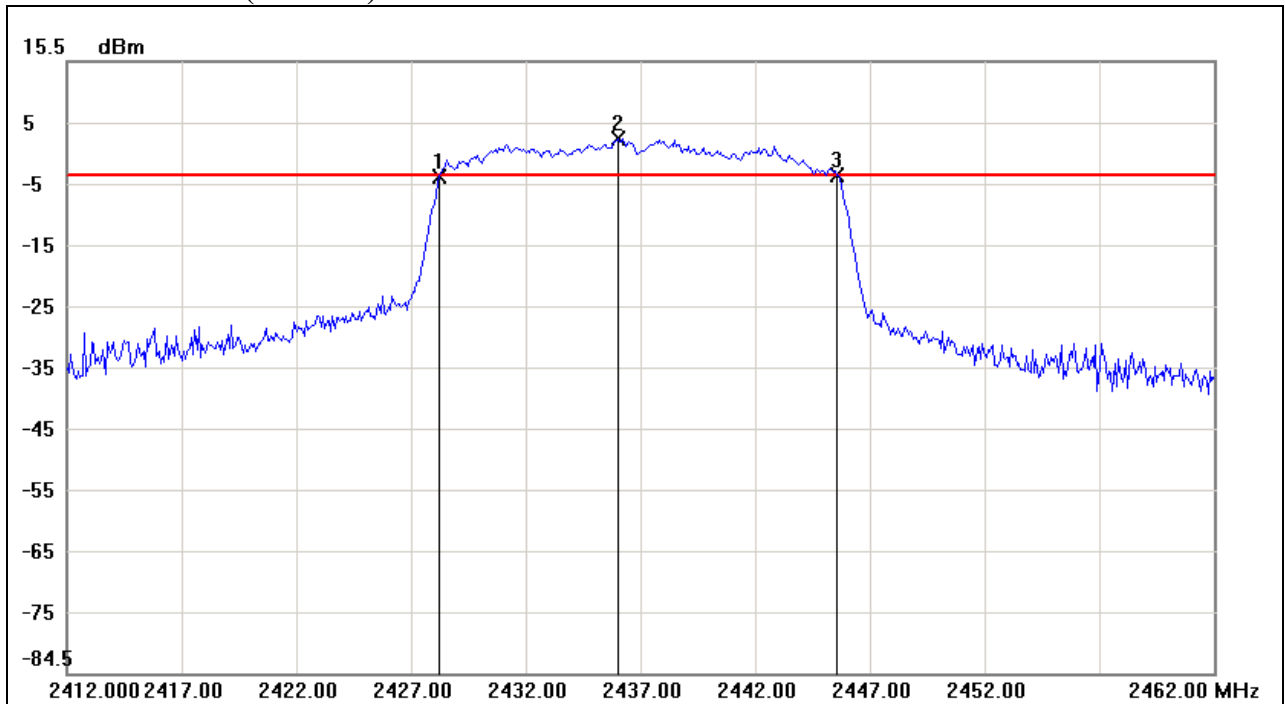

No.	Frequency(MHz)	Result(dBm)	Limit(dBm)	Margin(dBm)
1	2428.2500	-3.29	-3.04	-0.25
2	2436.0000	2.96	-3.04	6.00
3	2445.5833	-3.14	-3.04	-0.10

No.		$\Delta$ Frequency(MHz)	$\Delta$ Level(dB)
1	mk3-mk1	17.3333	0.15



6dB Bandwidth (CH High)

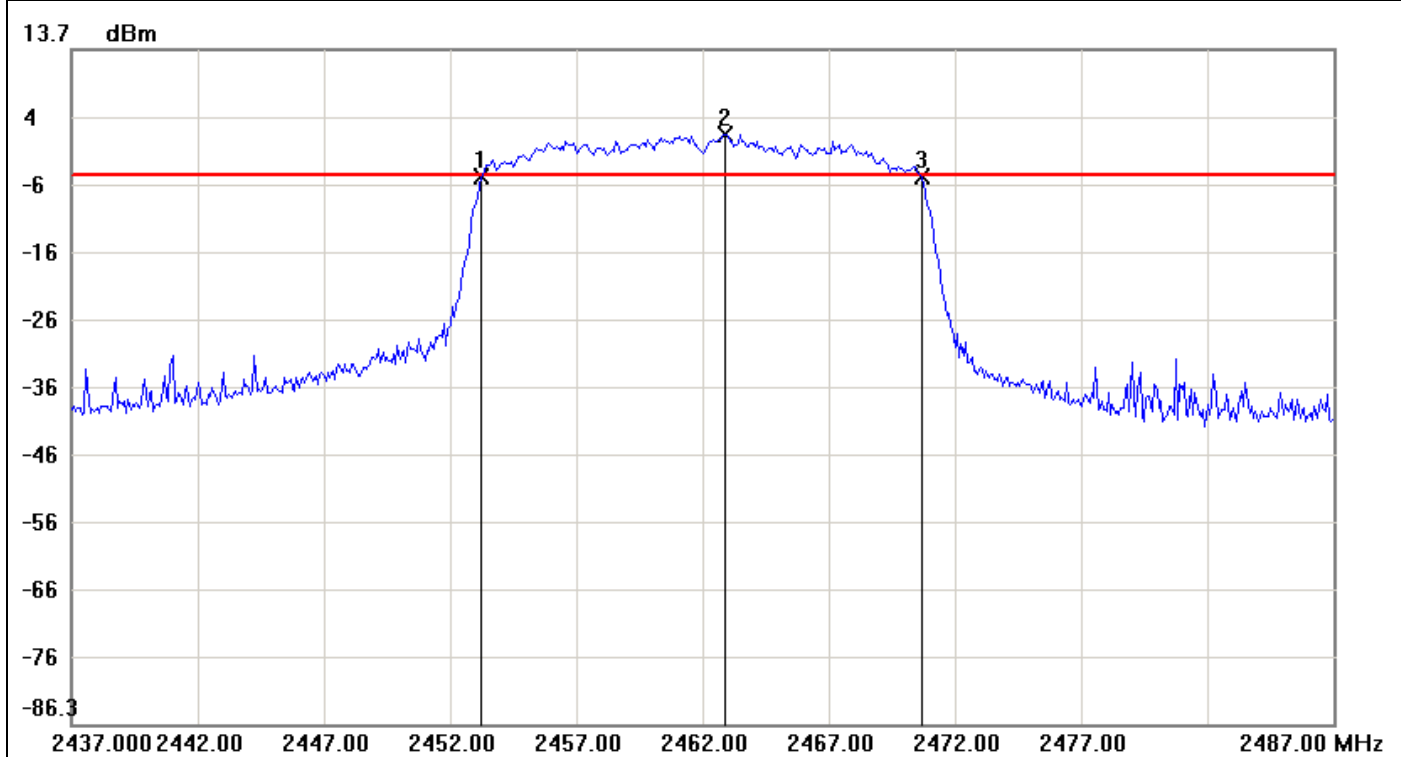

No.	Frequency(MHz)	Result(dBm)	Limit(dBm)	Margin(dBm)
1	2453.2500	-5.21	-4.83	-0.38
2	2462.9167	1.17	-4.83	6.00
3	2470.6667	-5.13	-4.83	-0.30

No.		$\Delta$ Frequency(MHz)	$\Delta$ Level(dB)
1	mk3-mk1	17.4167	0.08





## 7.2 PEAK POWER

### LIMIT

The maximum peak output power of the intentional radiator shall not exceed the following:

1. According to §15.247(b)(3), for systems using digital modulation in the bands of 902-928 MHz, 2400-2483.5 MHz, and 5725-5850 MHz: 1 Watt.
2. According to §15.247(b)(4), the conducted output power limit specified in paragraph (b) of this section is based on the use of antennas with directional gains that do not exceed 6 dBi. Except as shown in paragraph (c) of this section, if transmitting antennas of directional gain greater than 6 dBi are used, the conducted output power from the intentional radiator shall be reduced below the stated values in paragraphs (b)(1), (b)(2), and (b)(3) of this section, as appropriate, by the amount in dB that the directional gain of the antenna exceeds 6 dBi.

### Test Configuration

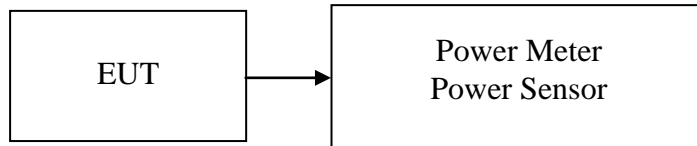

### TEST PROCEDURE

The transmitter output is connected to the Power Meter. The Power Meter is set to the peak power detection.

### TEST RESULTS

*No non-compliance noted*



**Test Data**

**Test mode: IEEE 802.11b mode**

Channel	Frequency (MHz)	Output Power (dBm)	Output Power (W)	Limit (W)	Result
Low	2412	16.85	0.0484	1.00	PASS
Mid	2437	15.67	0.0369		PASS
High	2462	14.18	0.0262		PASS

**Test mode: IEEE 802.11g mode**

Channel	Frequency (MHz)	Output Power (dBm)	Output Power (W)	Limit (W)	Result
Low	2412	21.70	0.1479	1.00	PASS
Mid	2437	20.25	0.1059		PASS
High	2462	18.49	0.0706		PASS

**Test mode: IEEE 802.11n HT 20 mode**

Channel	Frequency (MHz)	Output Power (dBm)	Output Power (W)	Limit (W)	Result
Low	2412	20.48	0.1117	1.00	PASS
Mid	2437	18.96	0.0787		PASS
High	2462	17.14	0.0518		PASS



### **7.3 AVERAGE POWER**

#### **LIMIT**

None; for reporting purposes only.

#### **Test Configuration**

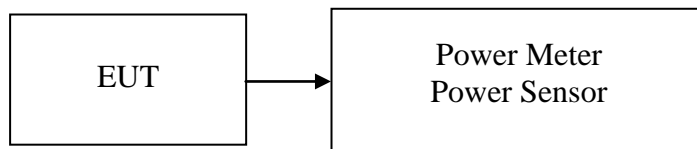

#### **TEST PROCEDURE**

The transmitter output is connected to the Power Meter. The Power Meter is set to the average power detection.



## **TEST RESULTS**

*No non-compliance noted*

### **Test Data**

#### **Test mode: IEEE 802.11b mode**

Channel	Frequency (MHz)	Output Power (dBm)	Output Power (W)
Low	2412	13.14	0.0206
Mid	2437	11.56	0.0143
High	2462	10.92	0.0124

#### **Test mode: IEEE 802.11g mode**

Channel	Frequency (MHz)	Output Power (dBm)	Output Power (W)
Low	2412	11.82	0.0152
Mid	2437	10.45	0.0111
High	2462	8.68	0.0074

#### **Test mode: IEEE 802.11n HT 20 mode**

Channel	Frequency (MHz)	Output Power (dBm)	Output Power (W)
Low	2412	10.86	0.0122
Mid	2437	9.39	0.0087
High	2462	7.09	0.0051



## 7.4 BAND EDGES MEASUREMENT

### LIMIT

According to §15.247(d), in any 100 kHz bandwidth outside the frequency bands in which the spread spectrum intentional radiator is operating, the radio frequency power that is produced by the intentional radiator shall be at least 20 dB below that in the 100 kHz bandwidth within the band that contains the highest level of the desired power, based on either an RF conducted or a radiated measurement, provided the transmitter demonstrates compliance with the peak conducted power limits. In addition, radiated emissions which fall in the restricted bands, as defined in §15.205(a), must also comply with the radiated emission limits specified in 15.209(a) (see Section 15.205(c)).

### Test Configuration

#### For Radiated

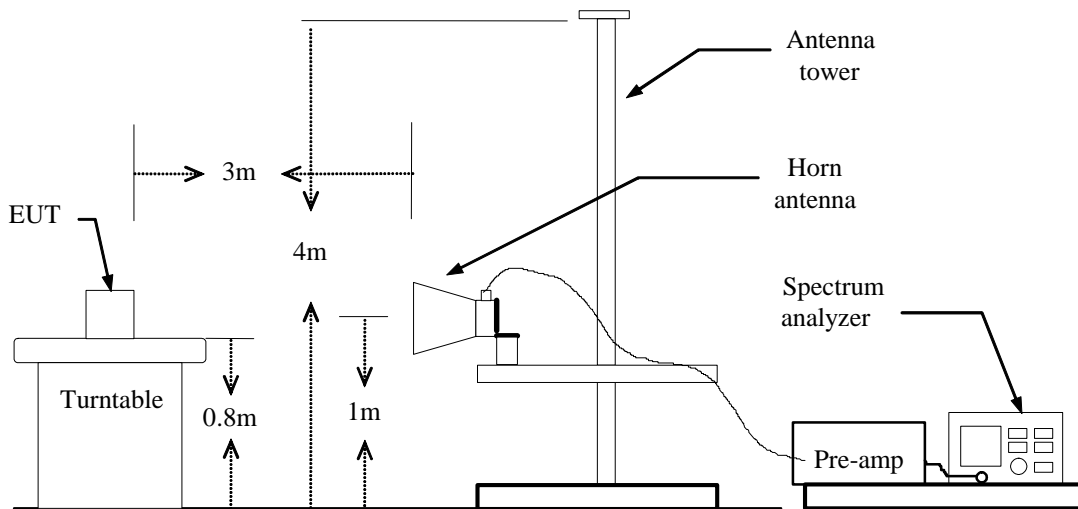

#### For Conducted

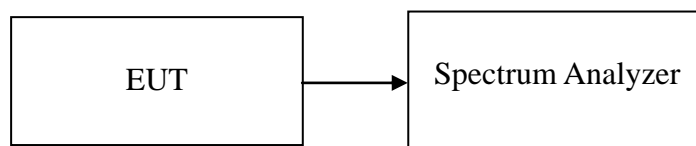



## **TEST PROCEDURE**

### **For Radiated**

1. The EUT is placed on a turntable, which is 0.8m above the ground plane.
2. The turntable shall be rotated for 360 degrees to determine the position of maximum emission level.
3. EUT is set 3m away from the receiving antenna, which is varied from 1m to 4m to find out the highest emission.
4. Set the spectrum analyzer in the following setting in order to capture the lower and upper band-edges of the emission:
  - (a) PEAK: RBW=1MHz / VBW=3MHz / Sweep=AUTO
  - (b) AVERAGE: RBW=1MHz / VBW= 300Hz / Sweep=AUTO
5. Repeat the procedures until all the PEAK and AVERAGE versus POLARIZATION are measured.

### **For Conducted**

Conducted RF measurements of the transmitter output were made to confirm that the EUT antenna port conducted emissions meet the specified limit and to identify any spurious signals that require further investigation or measurements on the radiated emissions site.

The transmitter output is connected to the spectrum analyzer. The resolution bandwidth is set to 100 kHz. The video bandwidth is set to 100 kHz.

## **TEST RESULTS**

Refer to attach spectrum analyzer data chart.



### Band Edges (IEEE 802.11b mode / CH Low)

Polarity: Vertical

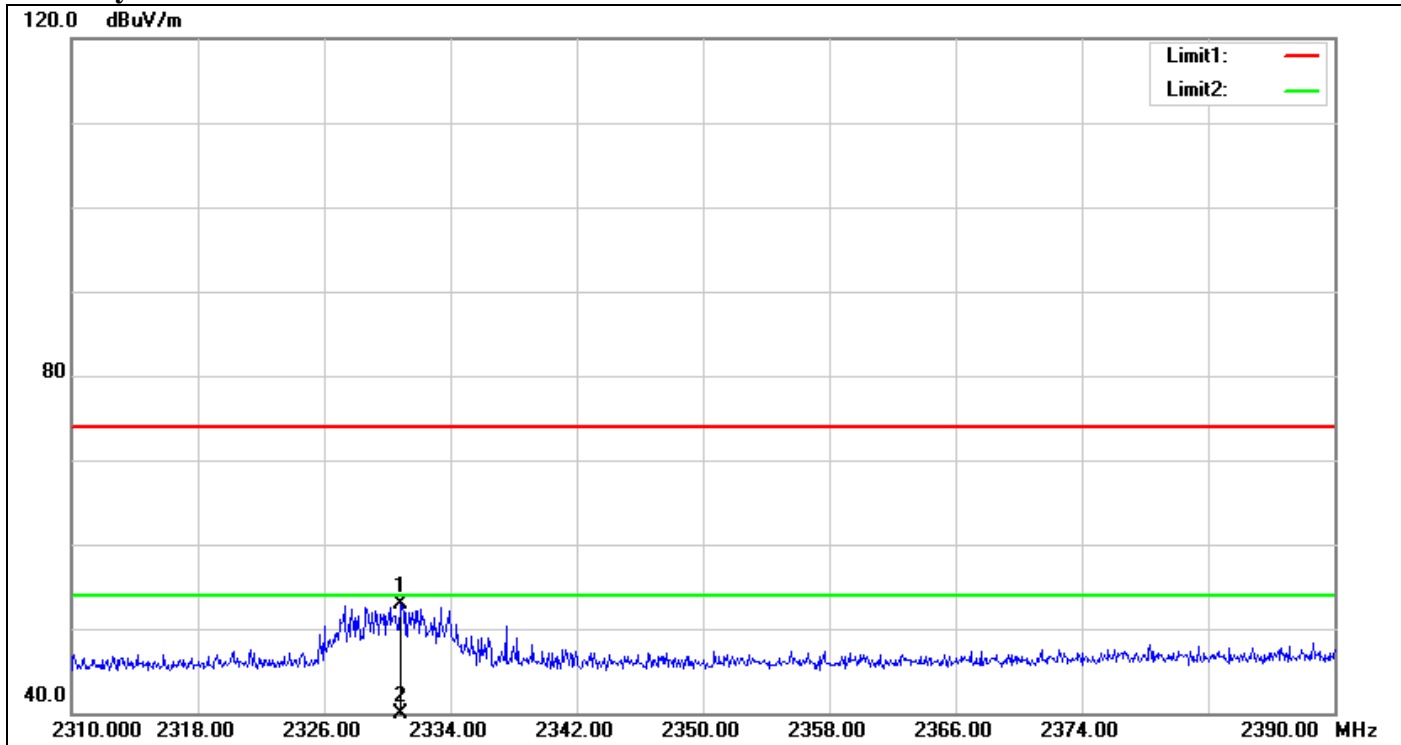

No.	Frequency (MHz)	Reading (dBuV)	Correct Factor(dB/m)	Result (dBuV/m)	Limit (dBuV/m)	Margin (dB)	Height (cm)	Degree (°)	Remark
1	2330.800	57.11	-4.22	52.89	74.00	-21.11	100	13	peak
2	2330.800	39.21	-4.22	34.99	54.00	-19.01	100	13	AVG



**Polarity: Horizontal**

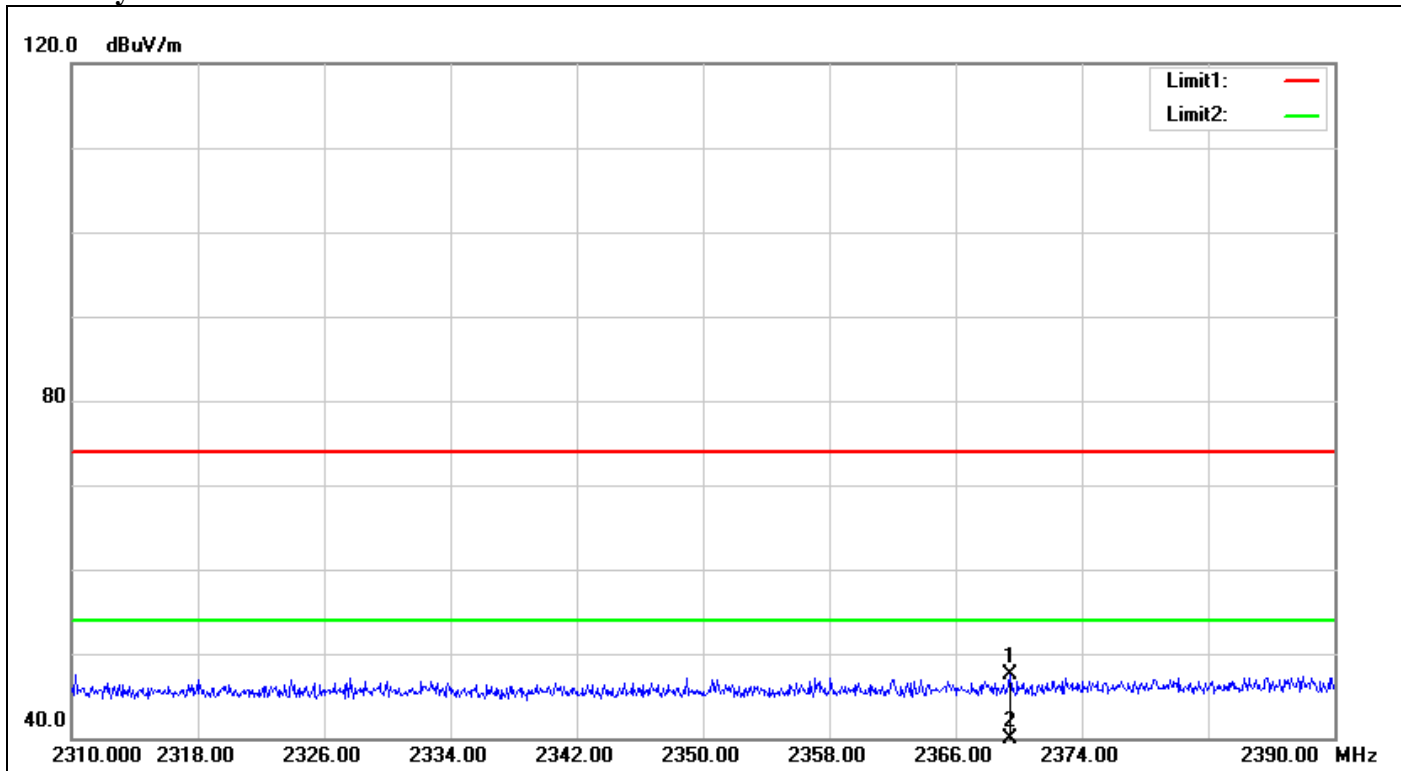

No.	Frequency (MHz)	Reading (dBuV)	Correct Factor(dB/m)	Result (dBuV/m)	Limit (dBuV/m)	Margin (dB)	Height (cm)	Degree (°)	Remark
1	2369.440	51.41	-3.94	47.47	74.00	-26.53	100	28	peak
2	2369.440	37.79	-3.94	33.85	54.00	-20.15	100	28	AVG





**Band Edges (IEEE 802.11b mode / CH High)**

**Polarity: Vertical**

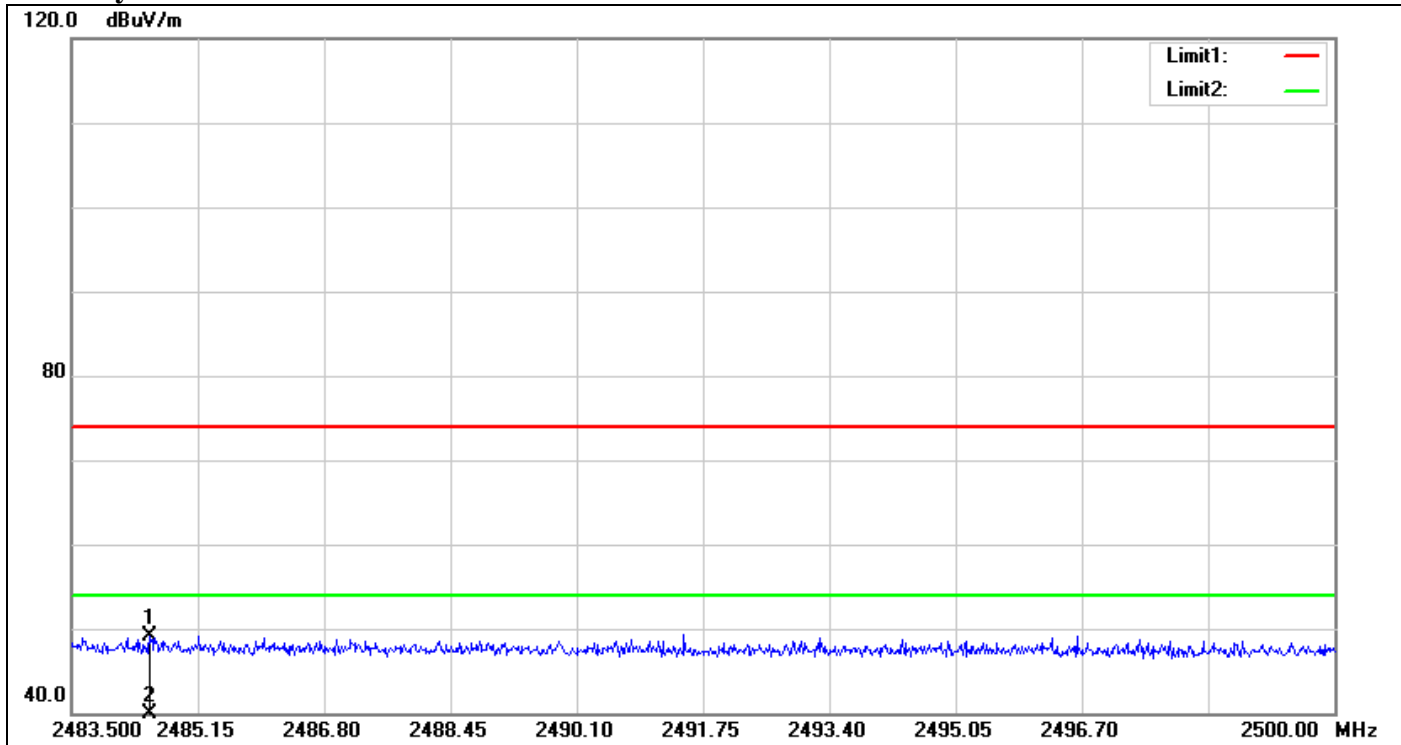

No.	Frequency (MHz)	Reading (dBuV)	Correct Factor(dB/m)	Result (dBuV/m)	Limit (dBuV/m)	Margin (dB)	Height (cm)	Degree (°)	Remark
1	2484.523	52.41	-3.26	49.15	74.00	-24.85	100	129	peak
2	2484.523	38.52	-3.26	35.26	54.00	-18.74	100	129	AVG



**Polarity: Horizontal**

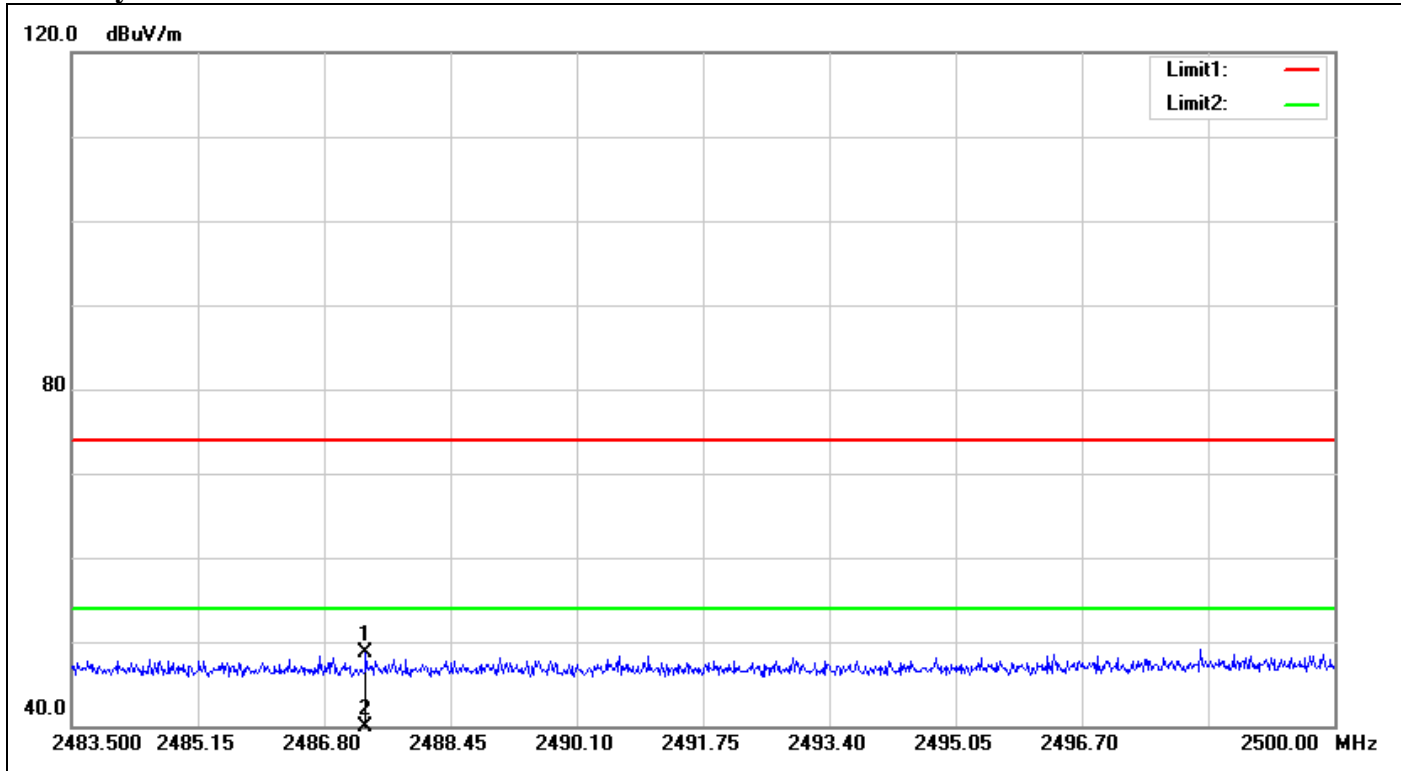

No.	Frequency (MHz)	Reading (dBuV)	Correct Factor(dB/m)	Result (dBuV/m)	Limit (dBuV/m)	Margin (dB)	Height (cm)	Degree (°)	Remark
1	2487.345	51.86	-3.24	48.62	74.00	-25.38	100	278	peak
2	2487.345	38.74	-3.24	35.50	54.00	-18.50	100	278	AVG



### Band Edges (IEEE 802.11g mode / CH Low)

Polarity: Vertical

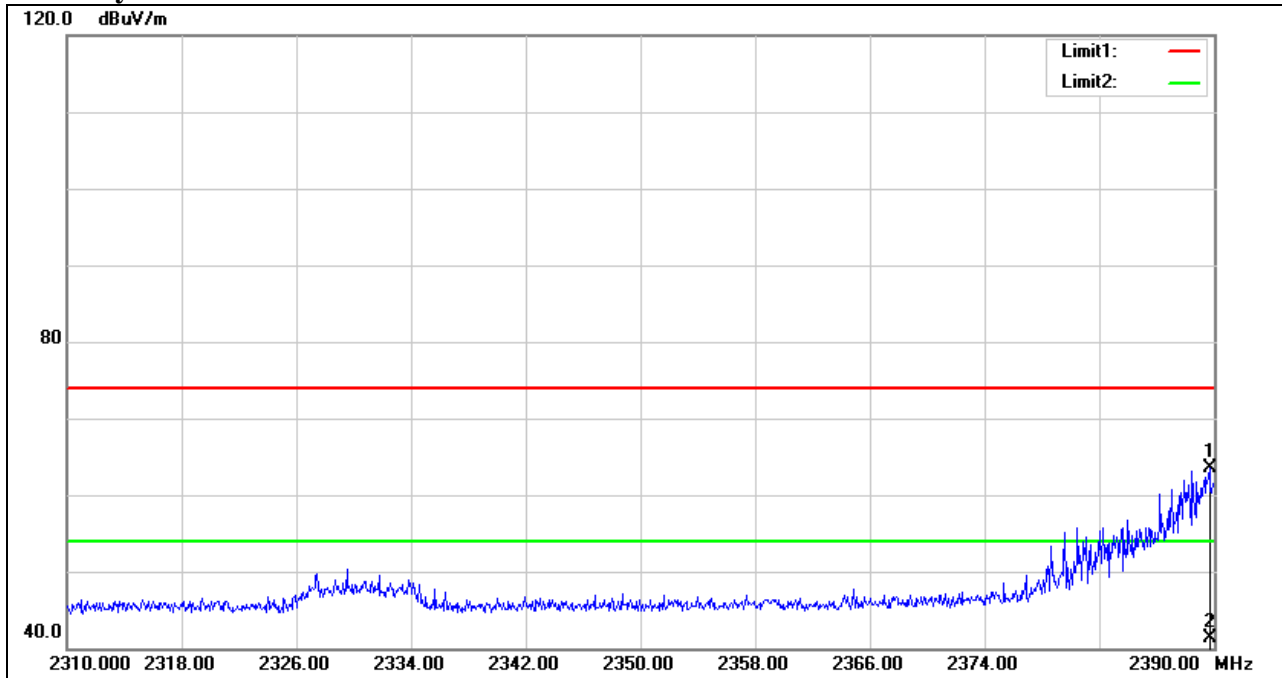

No.	Frequency (MHz)	Reading (dBuV)	Correct Factor(dB/m)	Result (dBuV/m)	Limit (dBuV/m)	Margin (dB)	Height (cm)	Degree (°)	Remark
1	2389.680	67.29	-3.77	63.52	74.00	-10.48	100	336	peak
2	2389.680	45.15	-3.77	41.38	54.00	-12.62	100	336	AVG



**Polarity: Horizontal**

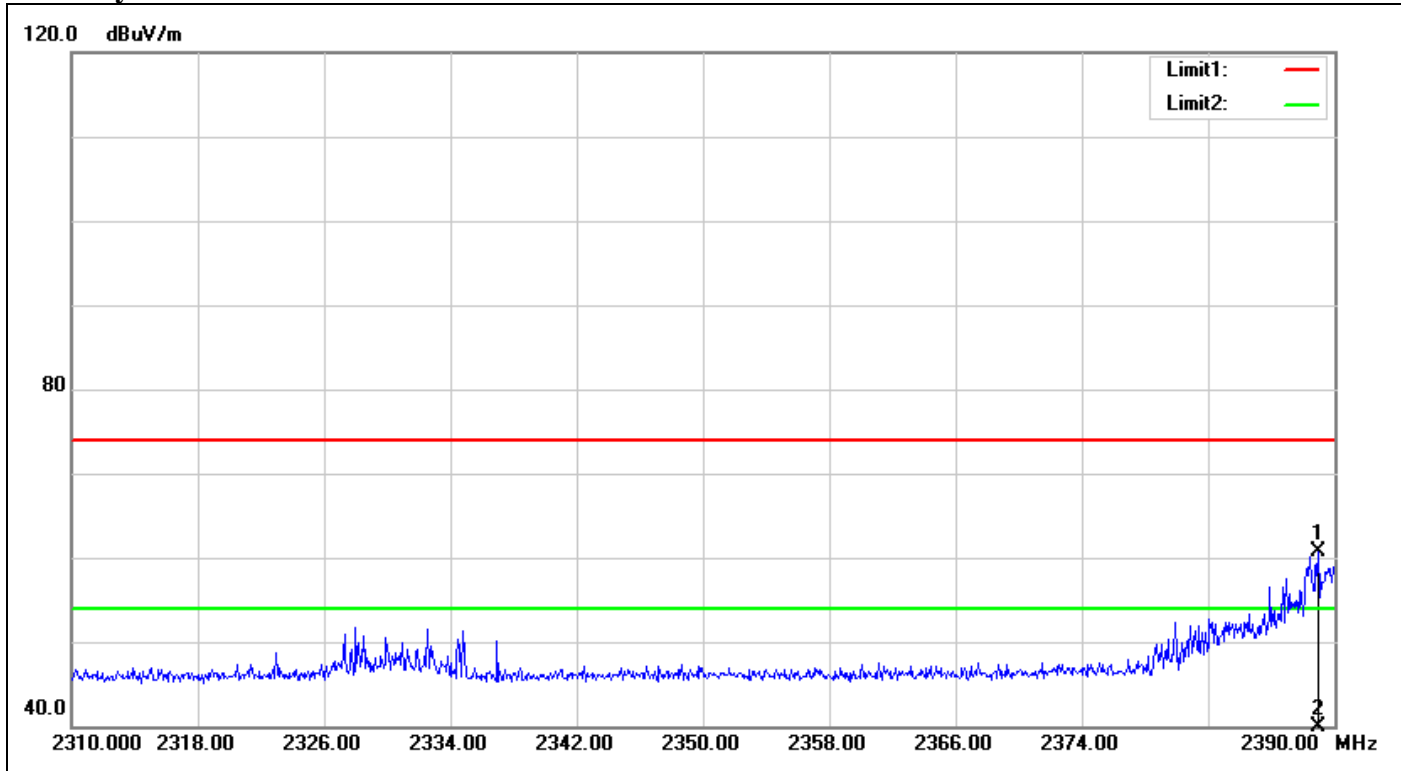

No.	Frequency (MHz)	Reading (dBuV)	Correct Factor(dB/m)	Result (dBuV/m)	Limit (dBuV/m)	Margin (dB)	Height (cm)	Degree (°)	Remark
1	2388.960	64.48	-3.78	60.70	74.00	-13.30	100	278	peak
2	2388.960	42.88	-3.78	39.10	54.00	-14.90	100	278	AVG



### Band Edges (IEEE 802.11g mode / CH High)

Polarity: Vertical

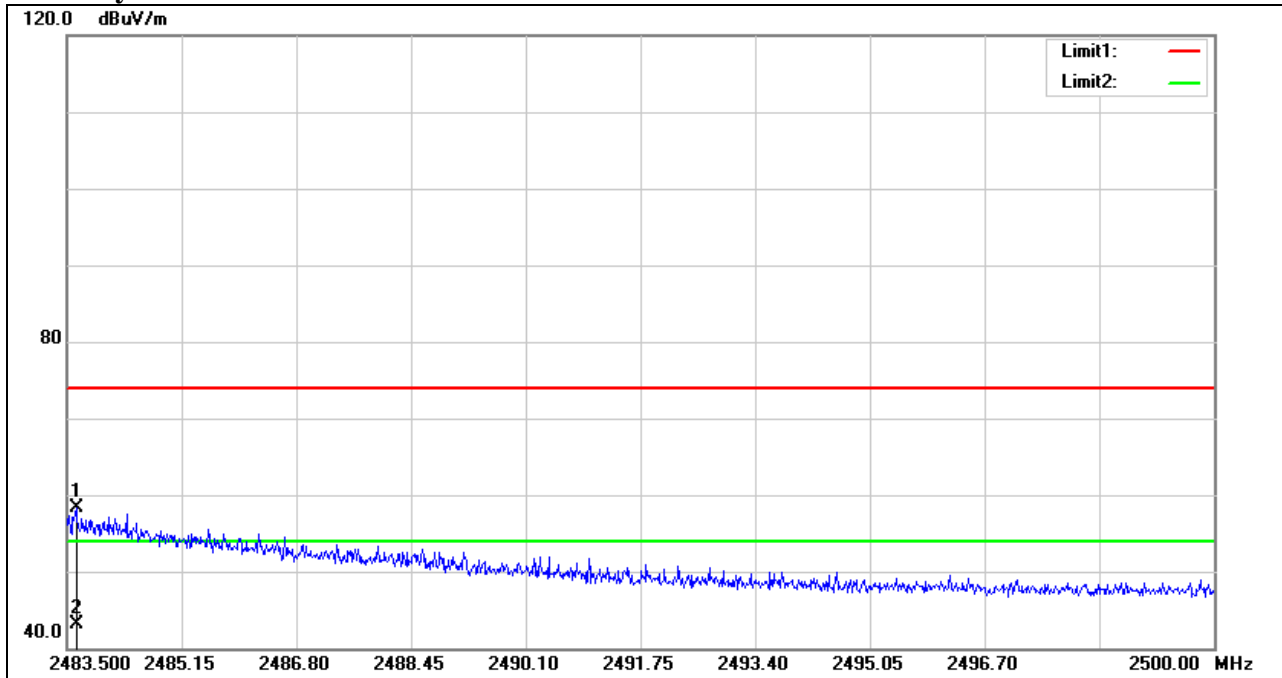

No.	Frequency (MHz)	Reading (dBuV)	Correct Factor(dB/m)	Result (dBuV/m)	Limit (dBuV/m)	Margin (dB)	Height (cm)	Degree (°)	Remark
1	2483.632	61.51	-3.27	58.24	74.00	-15.76	100	208	peak
2	2483.632	46.40	-3.27	43.13	54.00	-10.87	100	208	AVG



**Polarity: Horizontal**

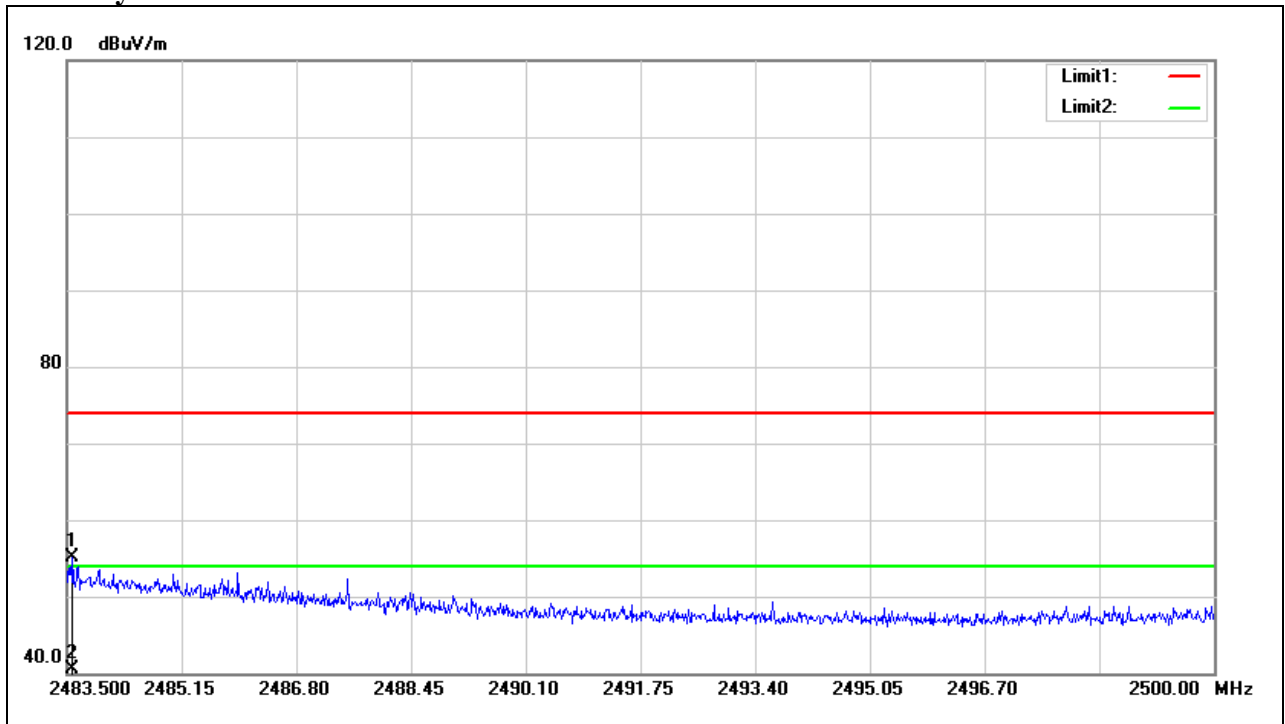

No.	Frequency (MHz)	Reading (dBuV)	Correct Factor(dB/m)	Result (dBuV/m)	Limit (dBuV/m)	Margin (dB)	Height (cm)	Degree (°)	Remark
1	2483.582	58.45	-3.27	55.18	74.00	-18.82	100	113	peak
2	2483.582	43.71	-3.27	40.44	54.00	-13.56	100	113	AVG



**Band Edges (IEEE 802.11n HT 20 mode / CH Low)**

**Polarity: Vertical**

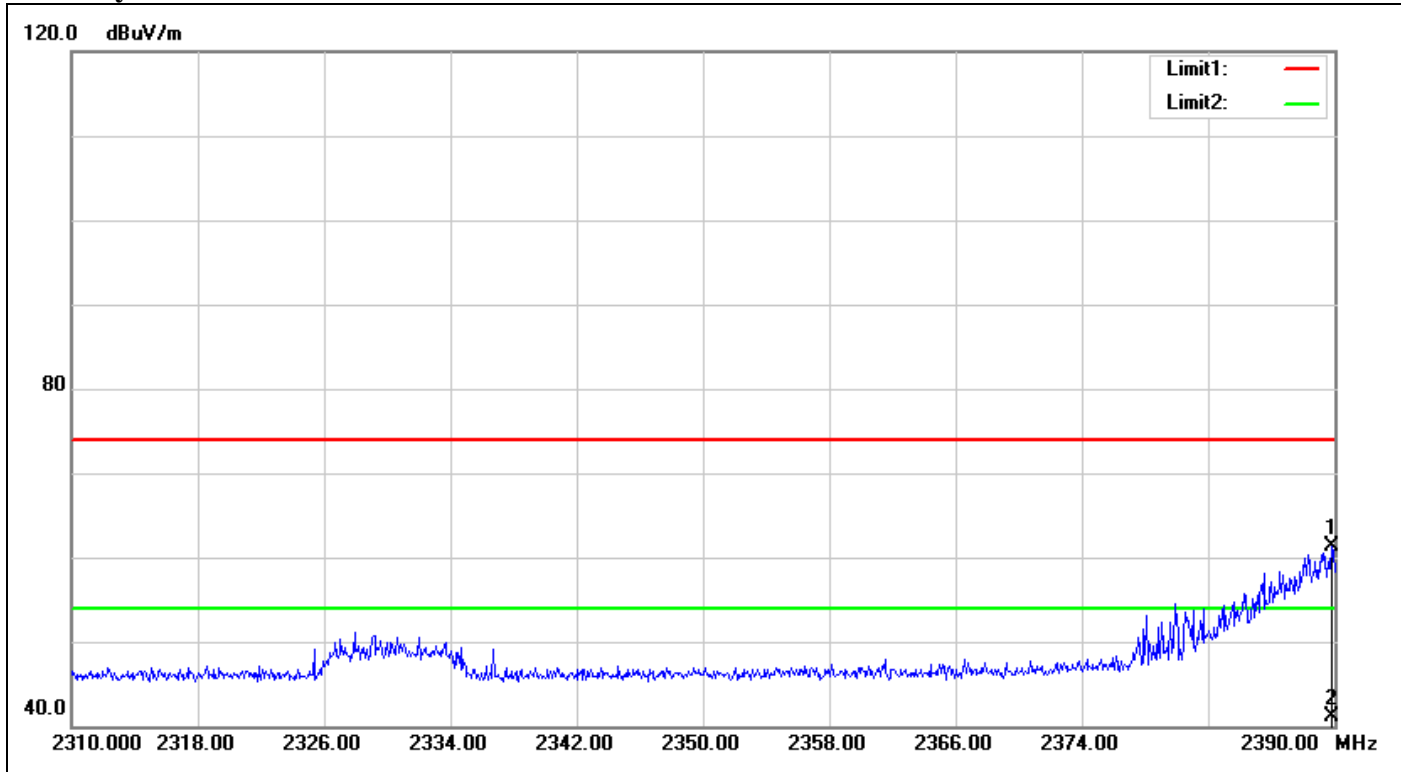

No.	Frequency (MHz)	Reading (dBuV)	Correct Factor(dB/m)	Result (dBuV/m)	Limit (dBuV/m)	Margin (dB)	Height (cm)	Degree (°)	Remark
1	2389.840	65.15	-3.77	61.38	74.00	-12.62	100	120	peak
2	2389.840	44.92	-3.77	41.15	54.00	-12.85	100	120	AVG



**Polarity: Horizontal**

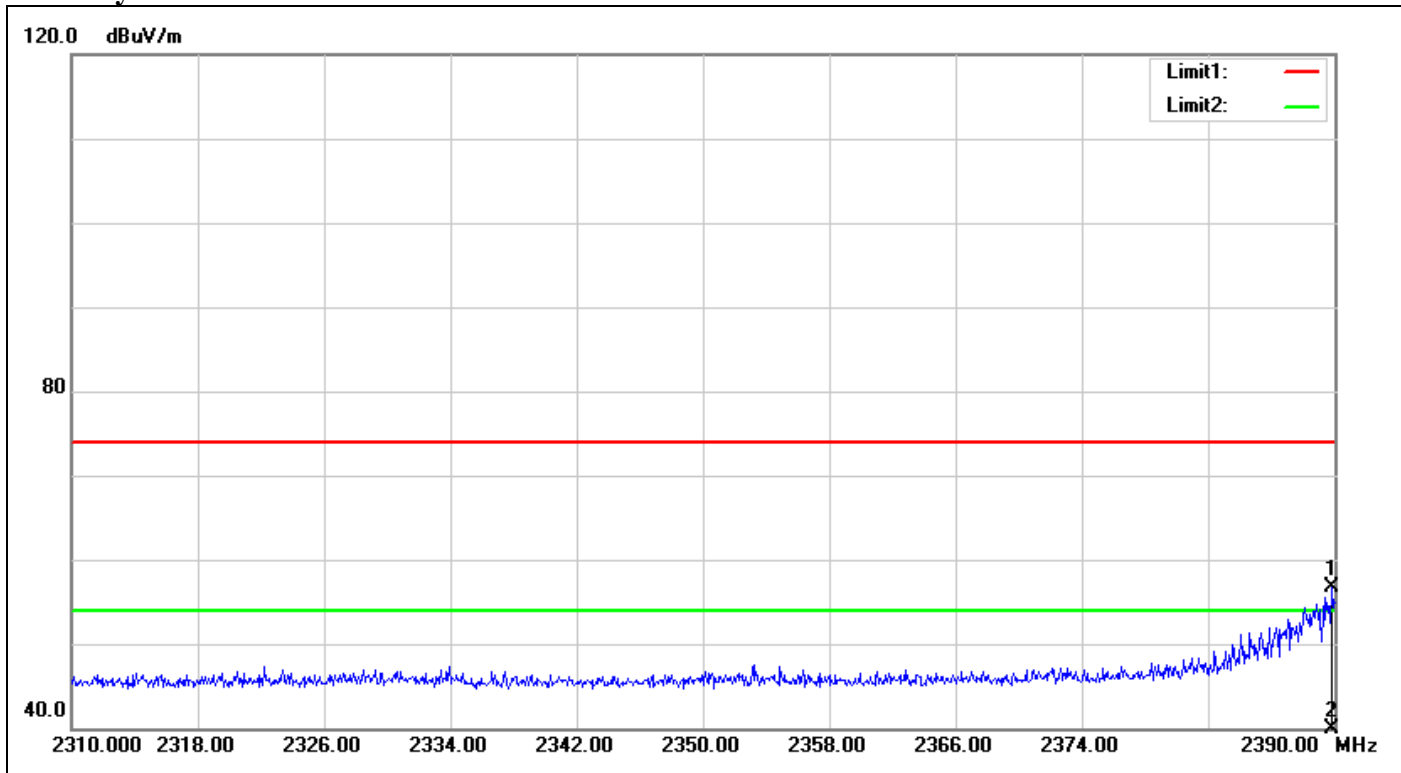

No.	Frequency (MHz)	Reading (dBuV)	Correct Factor(dB/m)	Result (dBuV/m)	Limit (dBuV/m)	Margin (dB)	Height (cm)	Degree (°)	Remark
1	2389.840	60.44	-3.77	56.67	74.00	-17.33	100	265	peak
2	2389.840	42.31	-3.77	38.54	54.00	-15.46	100	265	AVG





**Band Edges (IEEE 802.11n HT 20 mode / CH High)**

**Polarity: Vertical**

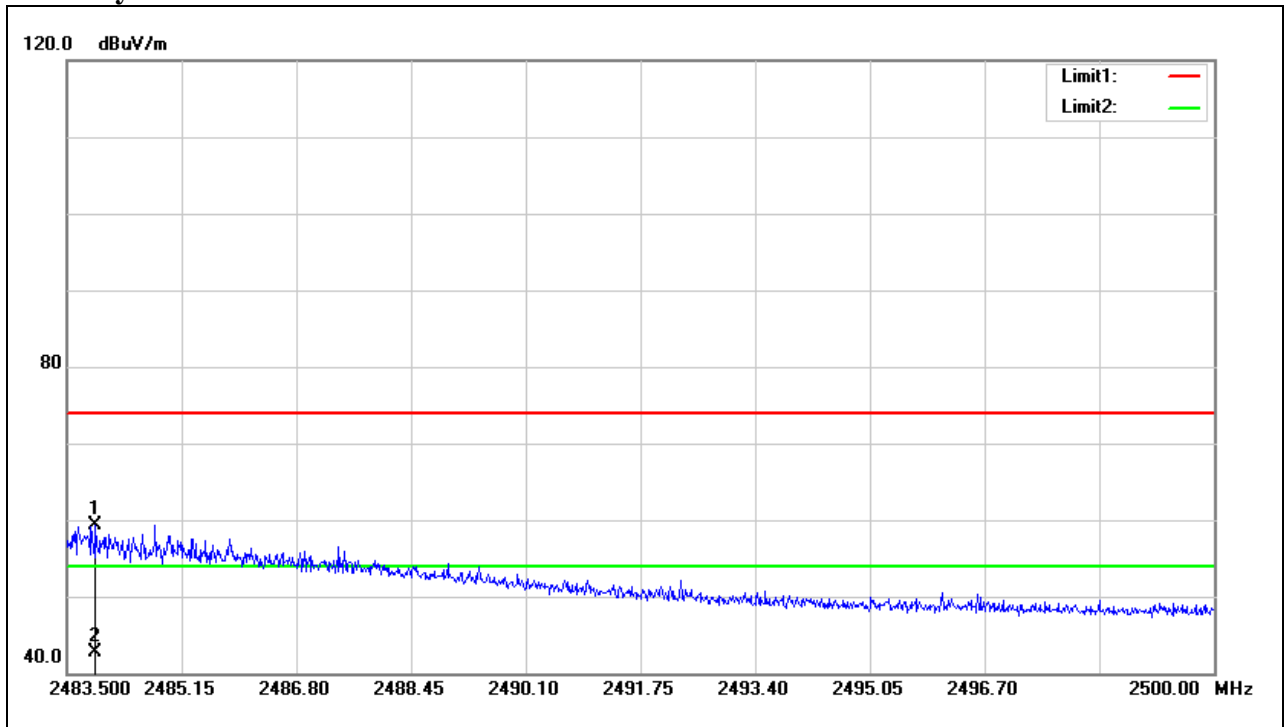

No.	Frequency (MHz)	Reading (dBuV)	Correct Factor(dB/m)	Result (dBuV/m)	Limit (dBuV/m)	Margin (dB)	Height (cm)	Degree (°)	Remark
1	2483.912	62.60	-3.27	59.33	74.00	-14.67	100	205	peak
2	2483.912	45.94	-3.27	42.67	54.00	-11.33	100	205	AVG



**Polarity: Horizontal**

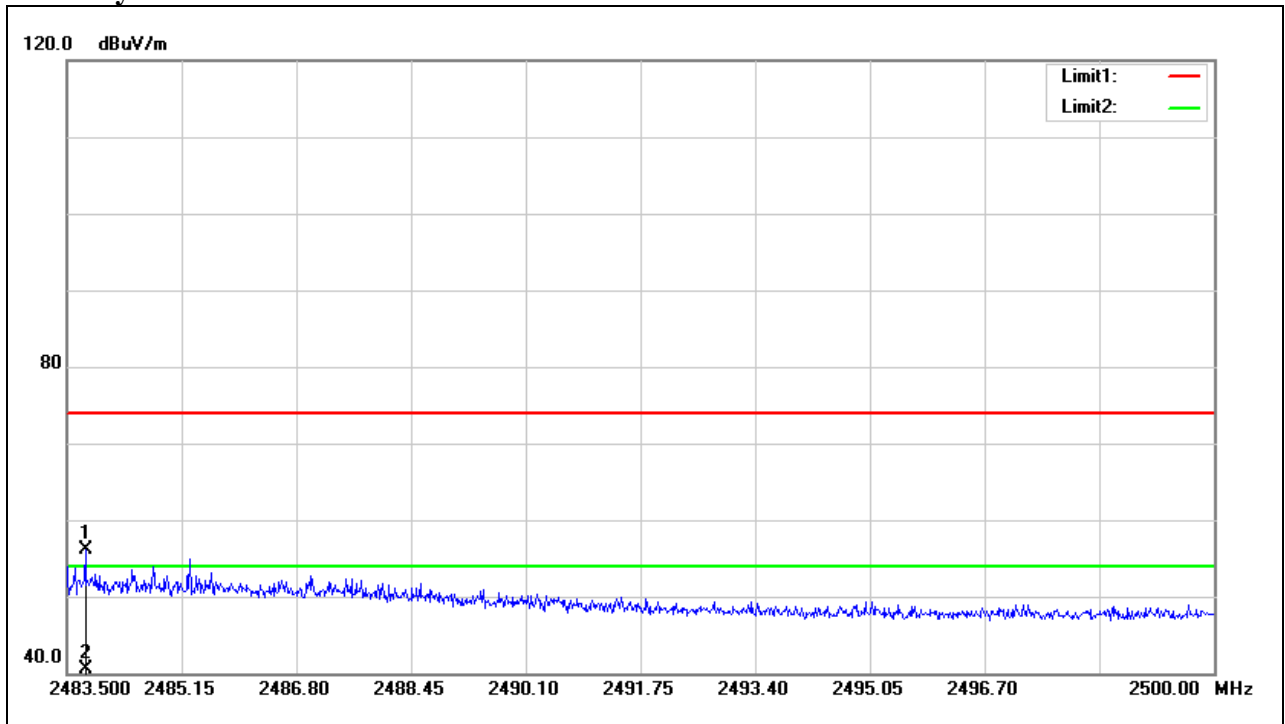

No.	Frequency (MHz)	Reading (dBuV)	Correct Factor(dB/m)	Result (dBuV/m)	Limit (dBuV/m)	Margin (dB)	Height (cm)	Degree (°)	Remark
1	2483.764	59.33	-3.27	56.06	74.00	-17.94	100	215	peak
2	2483.764	43.74	-3.27	40.47	54.00	-13.53	100	215	AVG



### Conducted Band Edge

IEEE 802.11b

(CH Low)

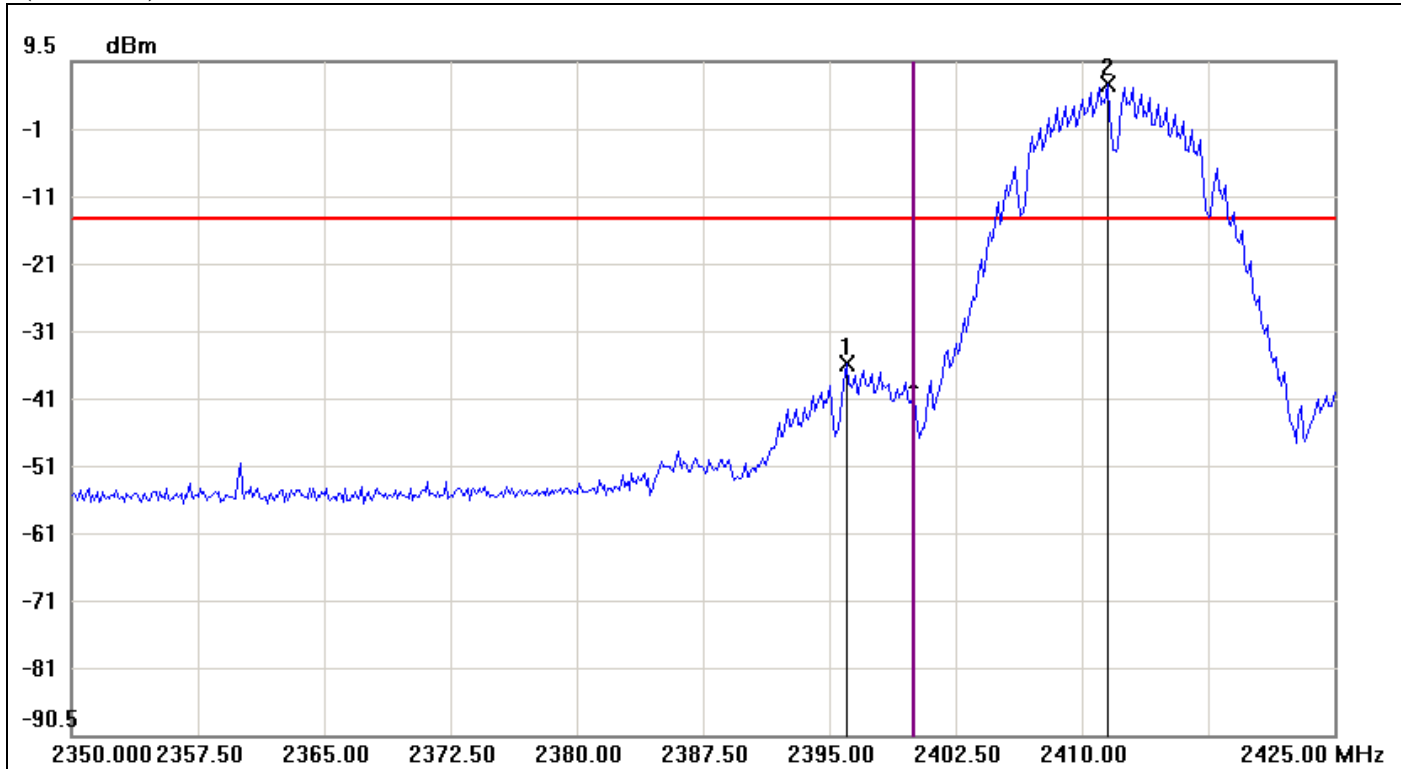

No.	Frequency(MHz)	Result(dBm)	Limit(dBm)	Margin(dBm)
1	2396.0000	-35.41	-13.84	-21.57
2	2411.5000	6.16	-13.84	20.00



(CH High)

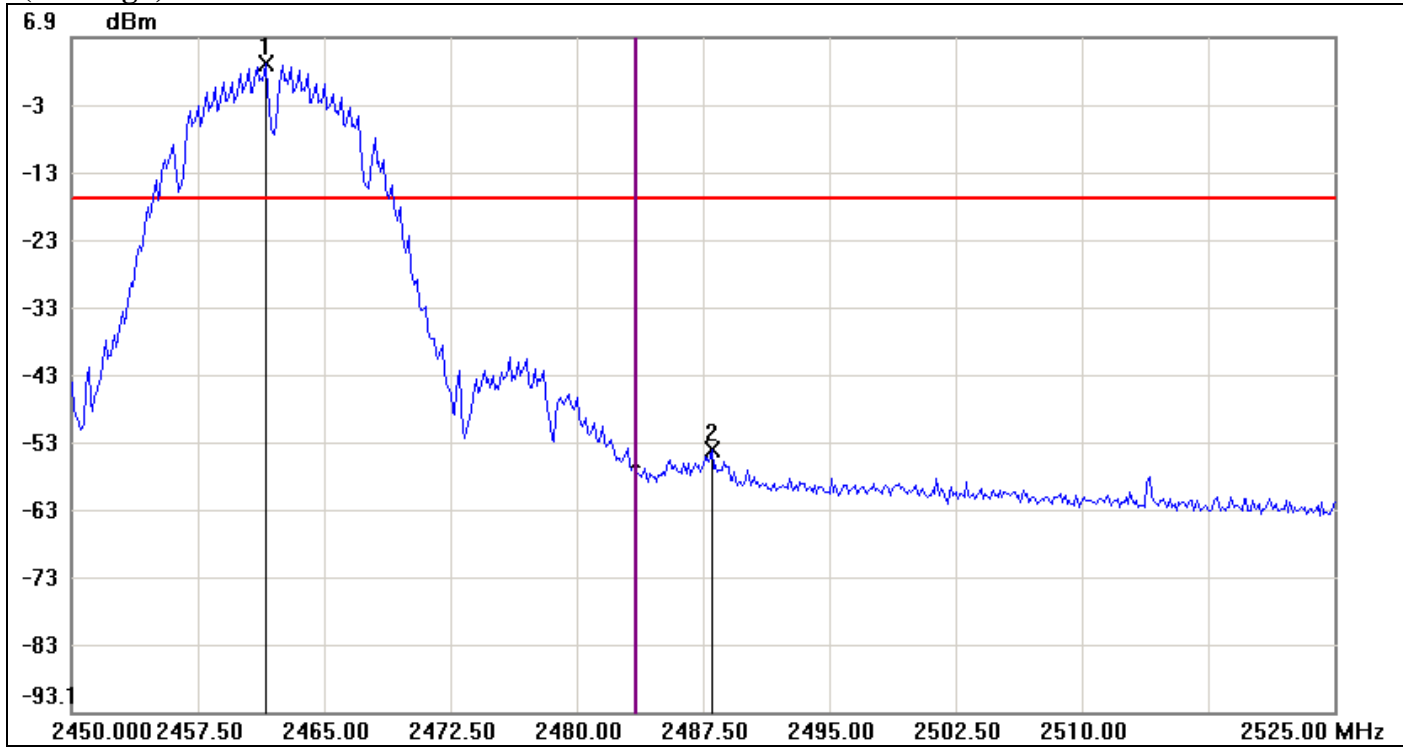

No.	Frequency(MHz)	Result(dBm)	Limit(dBm)	Margin(dBm)
1	2461.5000	3.04	-16.96	20.00
2	2488.0000	-54.26	-16.96	-37.30



IEEE 802.11g

(CH Low)

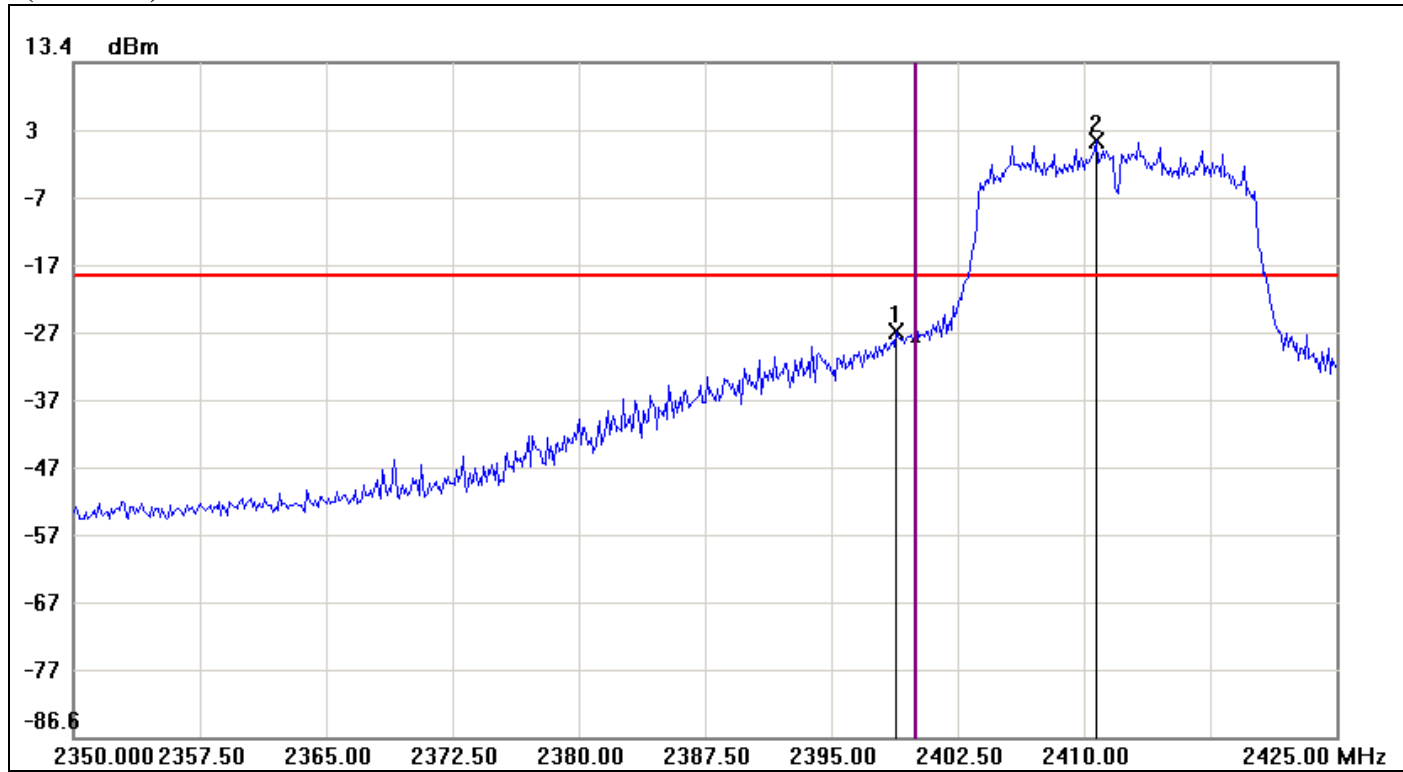

No.	Frequency(MHz)	Result(dBm)	Limit(dBm)	Margin(dBm)
1	2398.8750	-26.51	-18.17	-8.34
2	2410.7500	1.83	-18.17	20.00



(CH High)

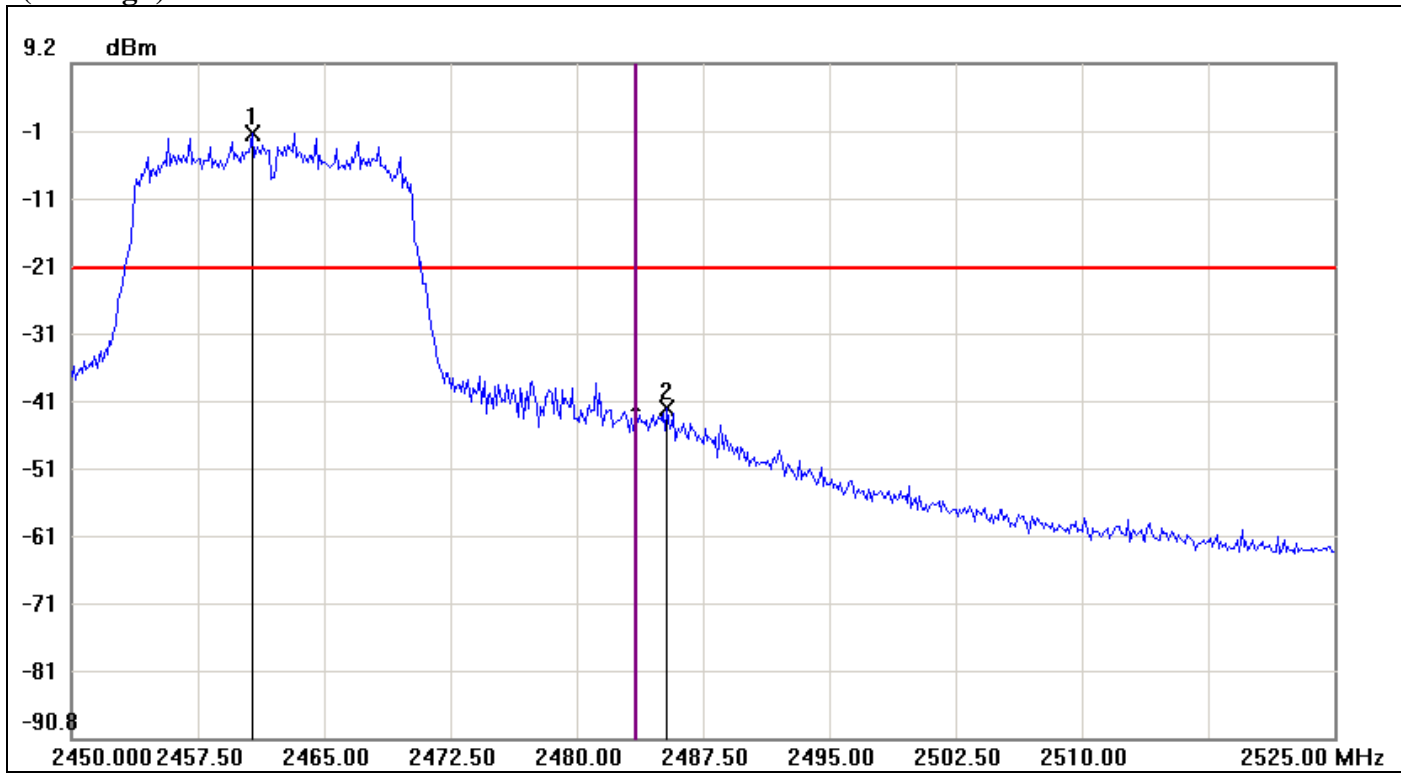

No.	Frequency(MHz)	Result(dBm)	Limit(dBm)	Margin(dBm)
1	2460.7500	-1.07	-21.07	20.00
2	2485.3750	-41.87	-21.07	-20.80



IEEE 802.11n HT 20 mode

(CH Low)

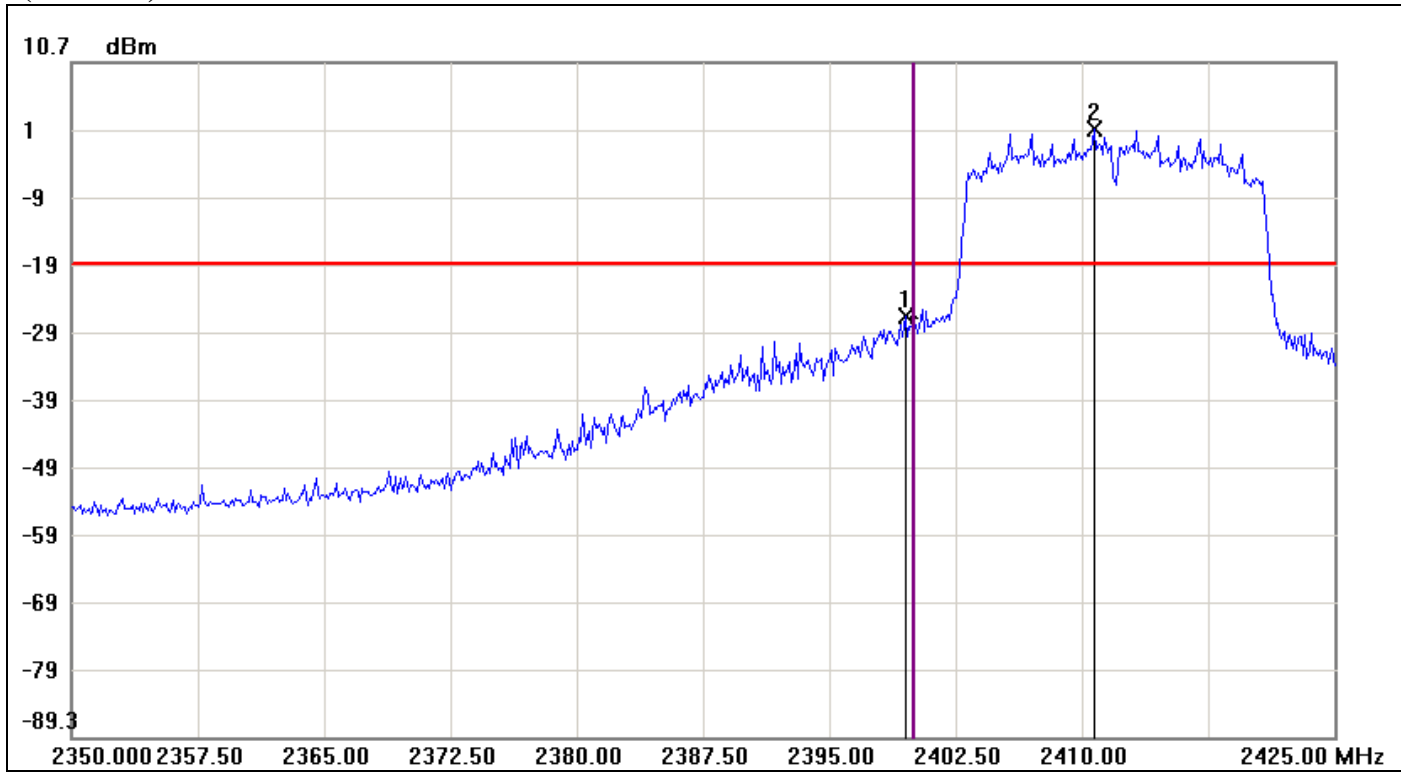

No.	Frequency(MHz)	Result(dBm)	Limit(dBm)	Margin(dBm)
1	2399.5000	-26.91	-19.19	-7.72
2	2410.7500	0.81	-19.19	20.00



(CH High)

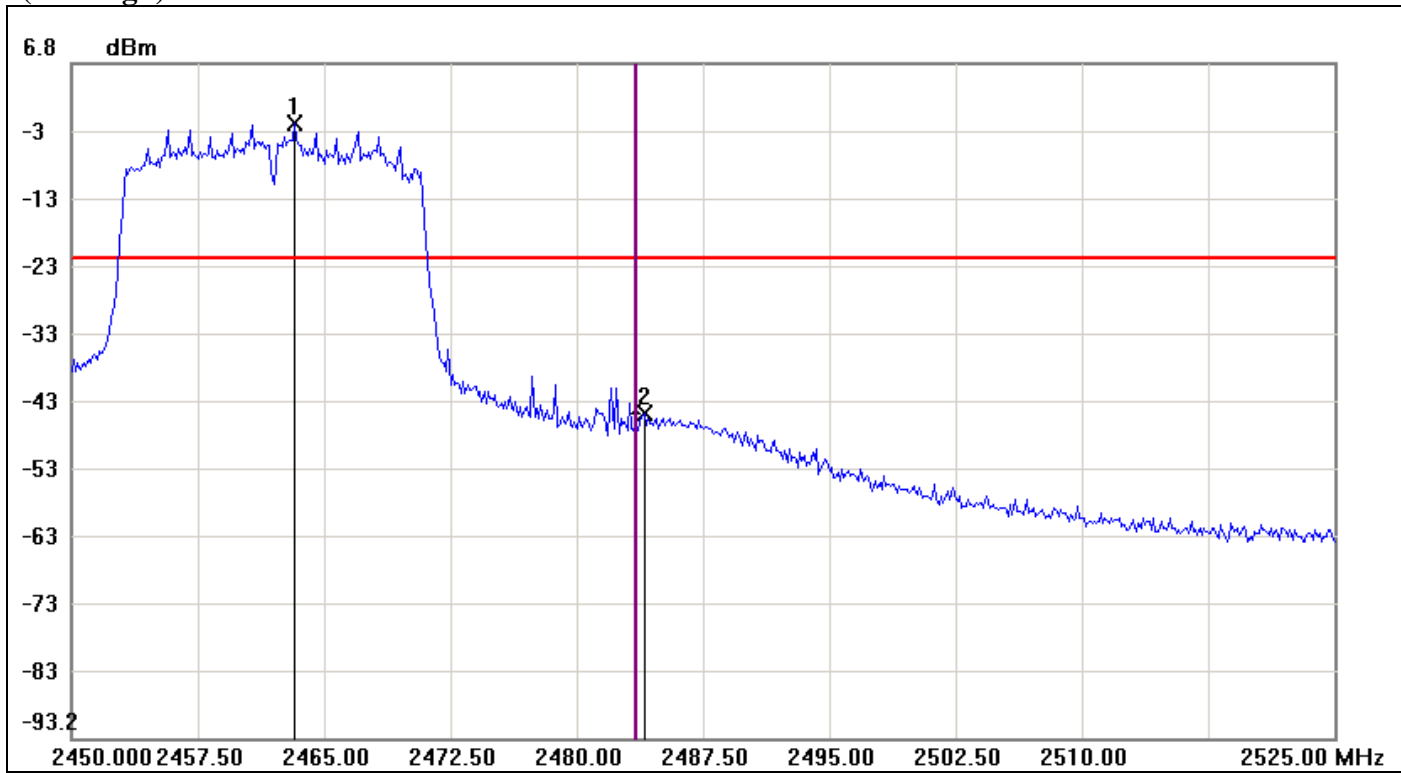

No.	Frequency(MHz)	Result(dBm)	Limit(dBm)	Margin(dBm)
1	2463.2500	-2.13	-22.13	20.00
2	2484.0000	-45.04	-22.13	-22.91





## 7.5 PEAK POWER SPECTRAL DENSITY

### LIMIT

1. According to §15.247(e), for digitally modulated systems, the power spectral density conducted from the intentional radiator to the antenna shall not be greater than 8 dBm in any 3 kHz band during any time interval of continuous transmission.
2. According to §15.247(f), the digital modulation operation of the hybrid system, with the frequency hopping turned off, shall comply with the power density requirements of paragraph (d) of this section.

### Test Configuration

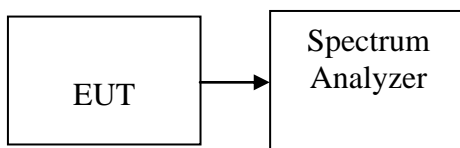

### TEST PROCEDURE

The transmitter output is connected to a spectrum analyzer. Set the RBW = 100 kHz, VBW  $\geq$  300 kHz, span to 1.5 times the DTS bandwidth, Detector = peak, Trace mode = max hold, Sweep = auto couple. Use the peak marker function to determine the maximum amplitude level within the RBW. If measured value exceeds limit, reduce RBW (no less than 3 kHz).



## **TEST RESULTS**

*No non-compliance noted*

### **Test Data**

#### **Test mode: IEEE 802.11b mode**

Channel	Frequency (MHz)	PPSD (dBm)	Limit (dBm)	Result
Low	2412	-2.52	8.00	PASS
Mid	2437	-4.04		PASS
High	2462	-4.85		PASS

#### **Test mode: IEEE 802.11g mode**

Channel	Frequency (MHz)	PPSD (dBm)	Limit (dBm)	Result
Low	2412	-5.41	8.00	PASS
Mid	2437	-5.73		PASS
High	2462	-8.78		PASS

#### **Test mode: IEEE 802.11n HT 20 mode**

Channel	Frequency (MHz)	PPSD (dBm)	Limit (dBm)	Result
Low	2412	-6.37	8.00	PASS
Mid	2437	-7.34		PASS
High	2462	-9.30		PASS



**Test Plot**

IEEE 802.11b mode

PPSD (CH Low)

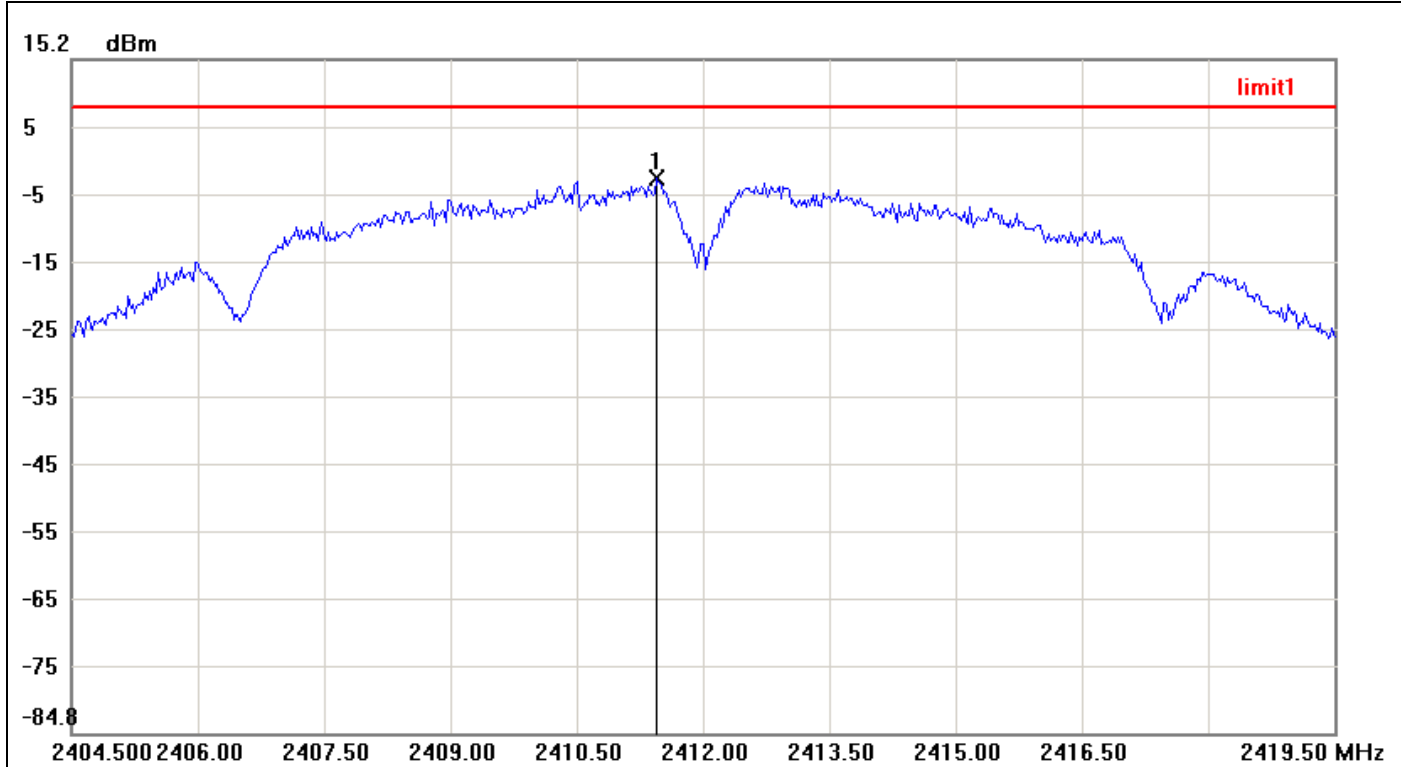

No.	Frequency(MHz)	Result(dBm)	Limit(dBm)	Margin(dBm)
1	2411.4500	-2.52	8.00	-10.52



### PPSD (CH Mid)

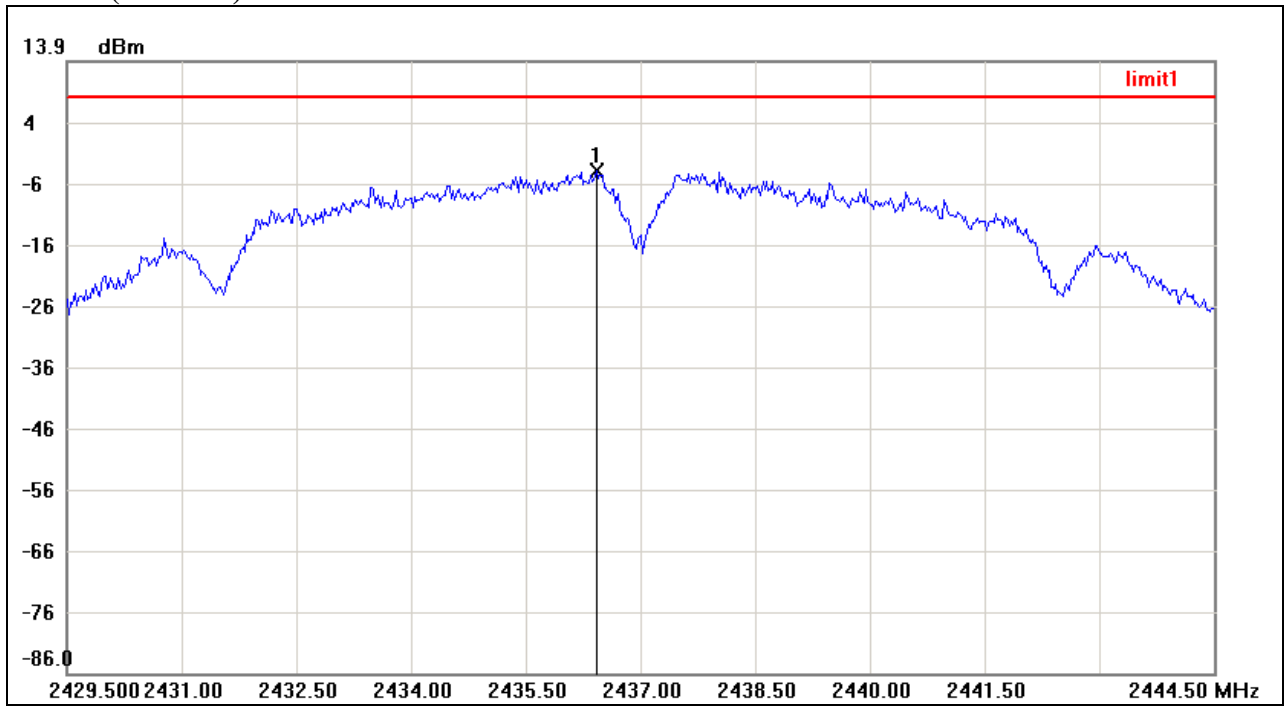

No.	Frequency(MHz)	Result(dBm)	Limit(dBm)	Margin(dBm)
1	2436.4250	-4.04	8.00	-12.04



PPSD (CH High)

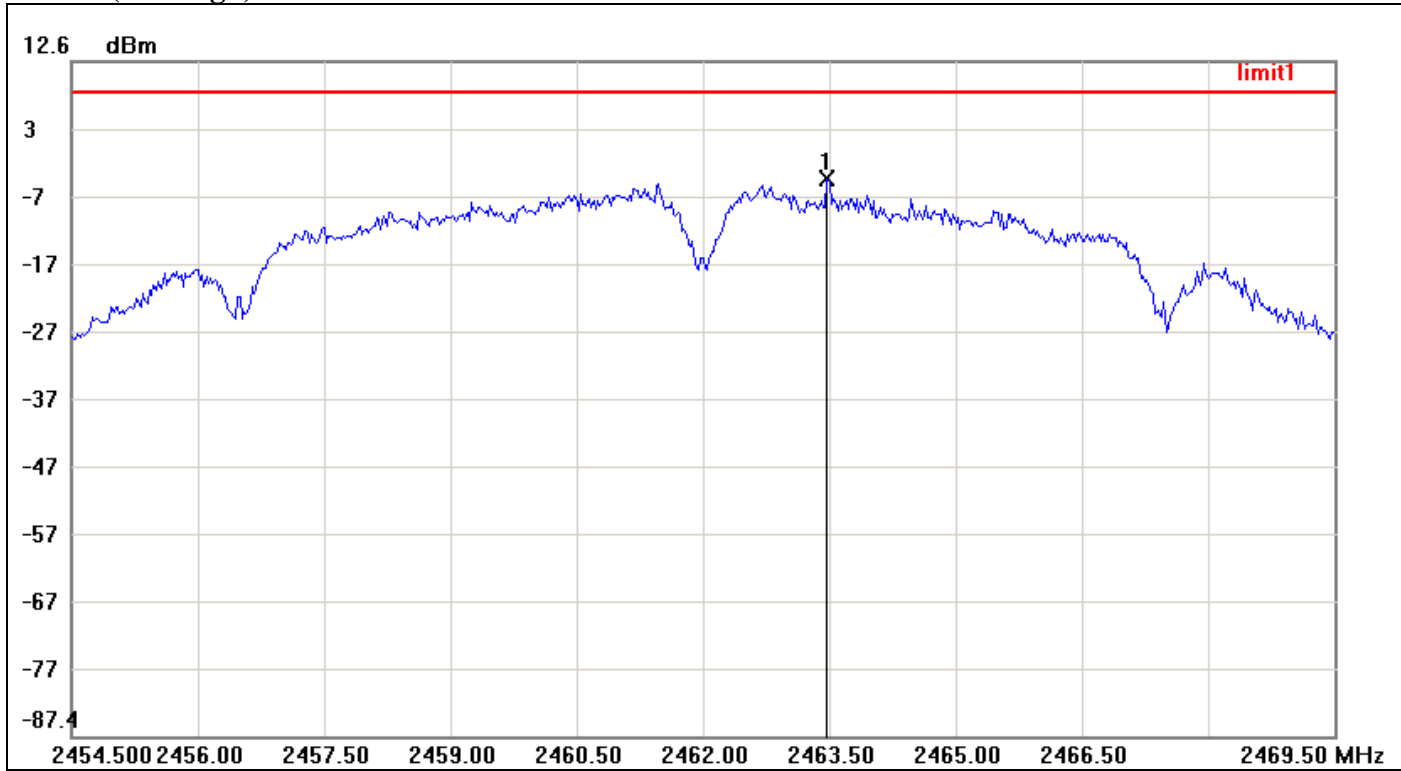

No.	Frequency(MHz)	Result(dBm)	Limit(dBm)	Margin(dBm)
1	2463.4750	-4.85	8.00	-12.85



IEEE 802.11g mode

PPSD (CH Low)

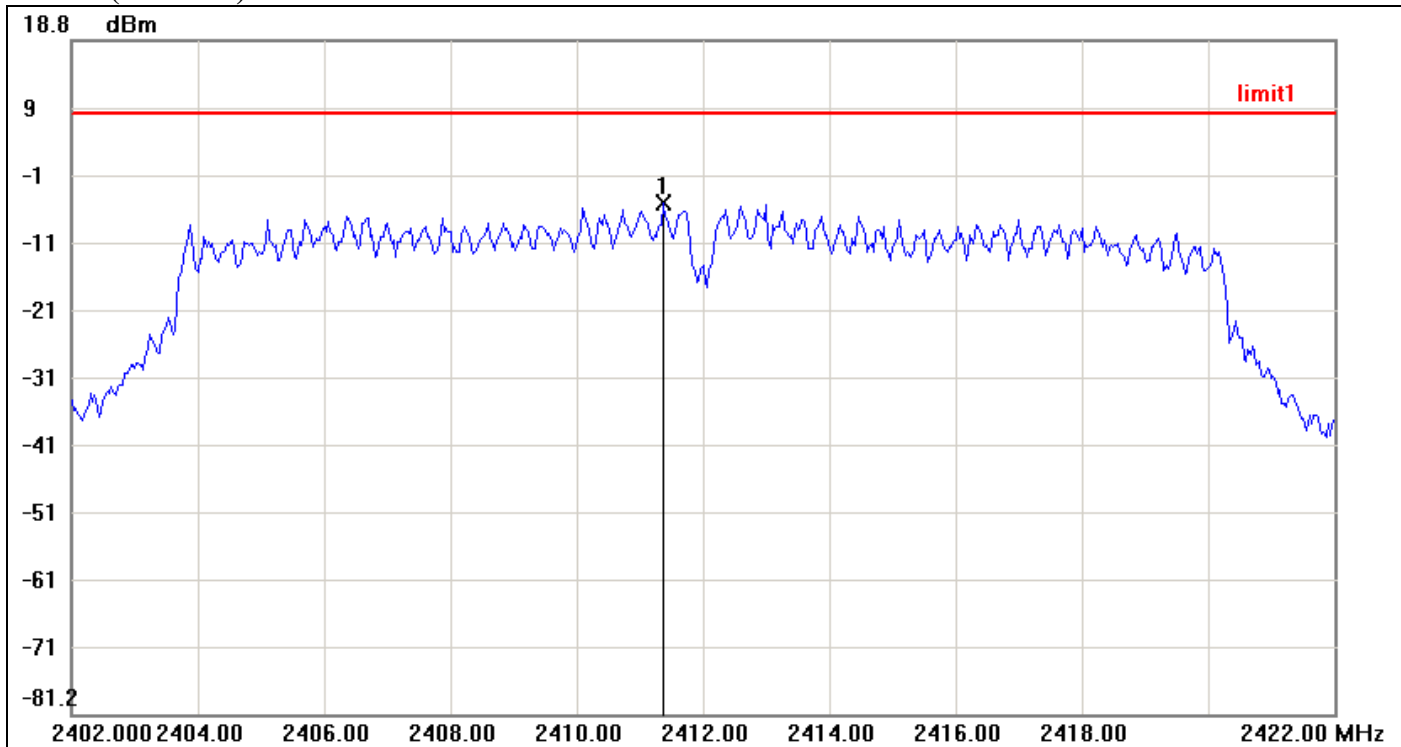

No.	Frequency(MHz)	Result(dBm)	Limit(dBm)	Margin(dBm)
1	2411.3667	-5.41	8.00	-13.41



### PPSD (CH Mid)

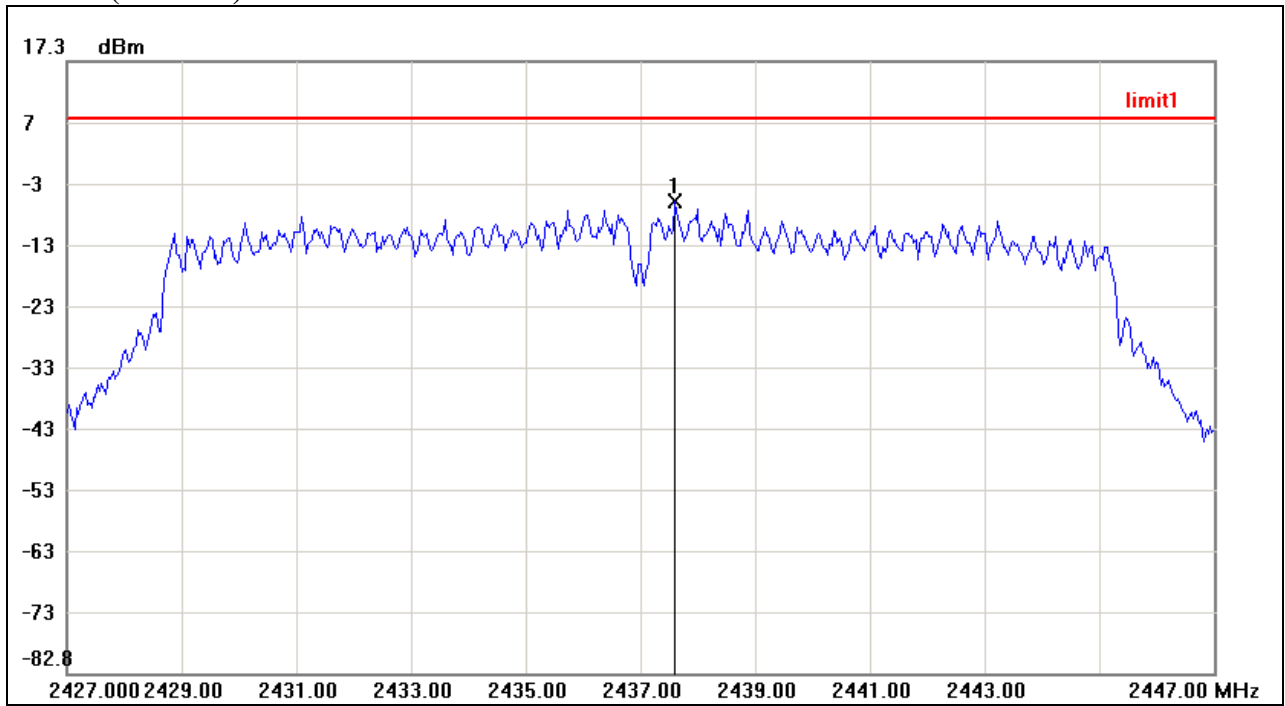

No.	Frequency(MHz)	Result(dBm)	Limit(dBm)	Margin(dBm)
1	2437.6000	-5.73	8.00	-13.73



**PPSD (CH High)**

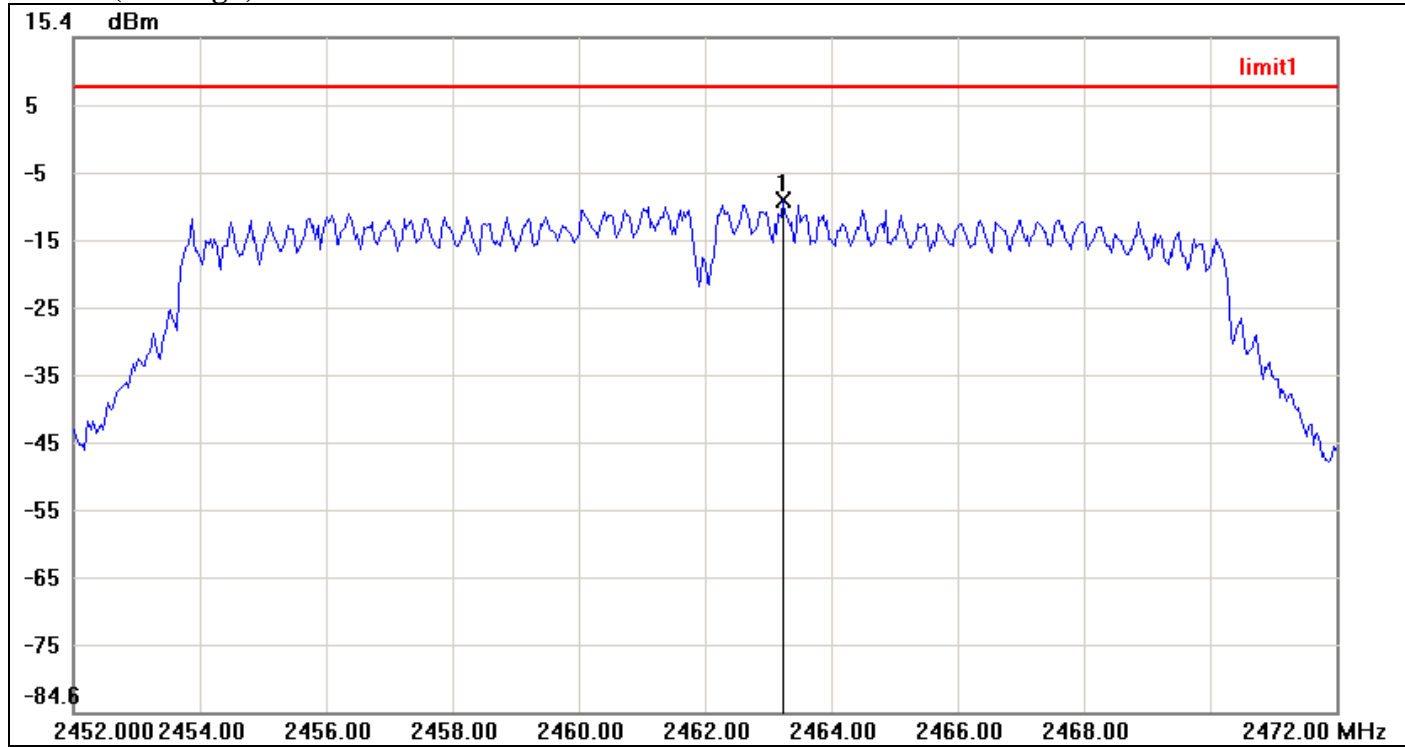

No.	Frequency(MHz)	Result(dBm)	Limit(dBm)	Margin(dBm)
1	2463.2333	-8.78	8.00	-16.78





IEEE 802.11n HT 20 mode

PPSD (CH Low)

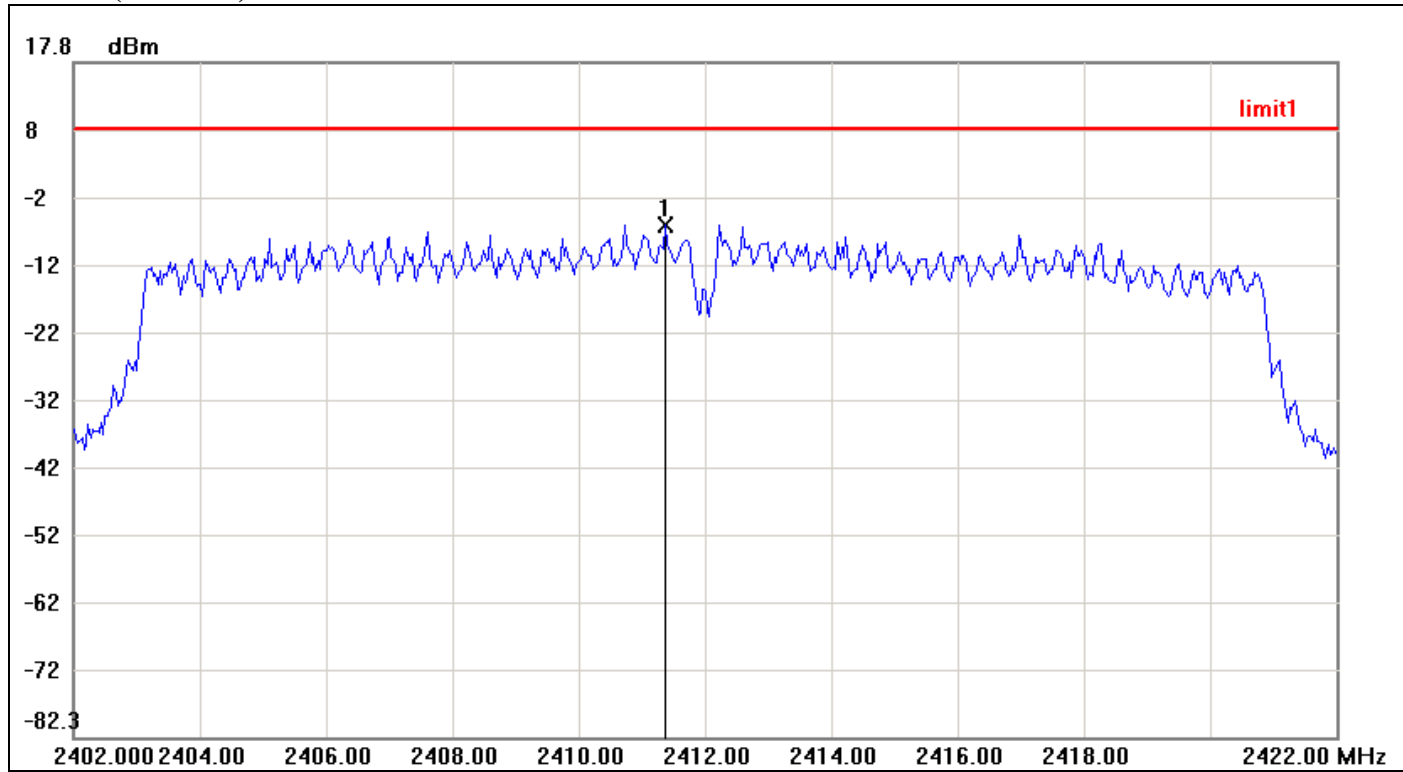

No.	Frequency(MHz)	Result(dBm)	Limit(dBm)	Margin(dBm)
1	2411.3667	-6.37	8.00	-14.37



PPSD (CH Mid)

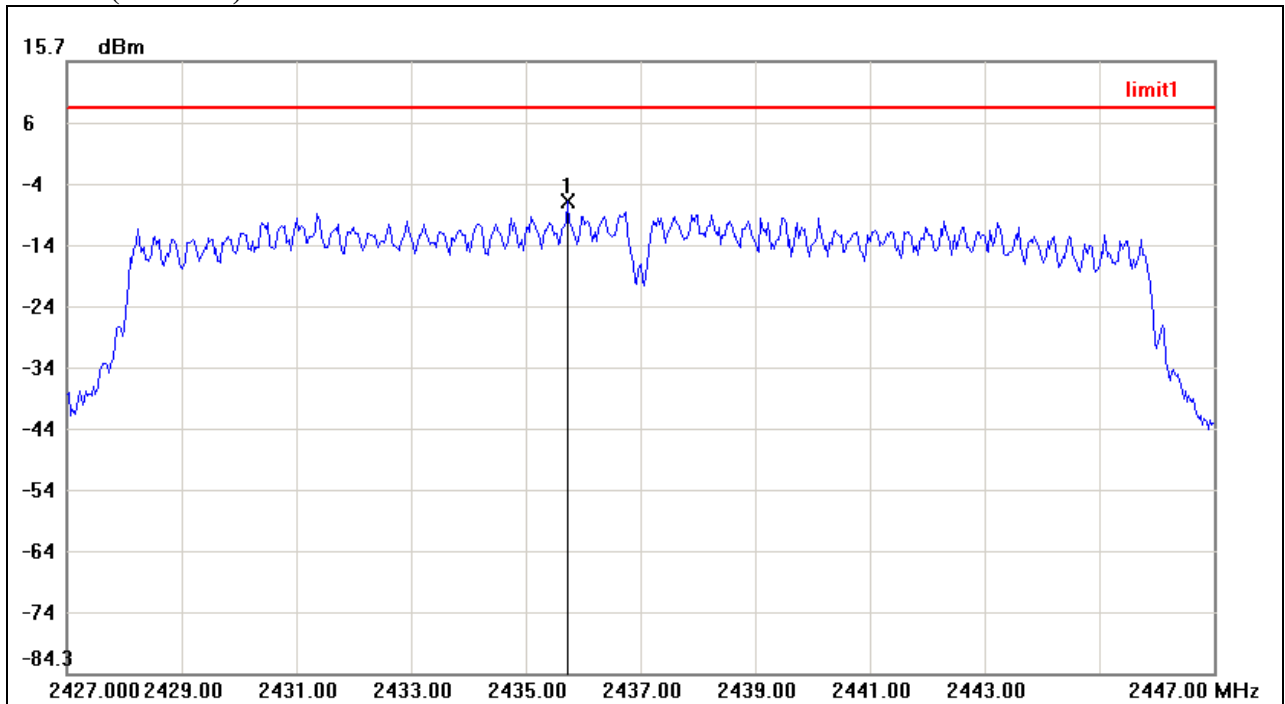

No.	Frequency(MHz)	Result(dBm)	Limit(dBm)	Margin(dBm)
1	2435.7333	-7.34	8.00	-15.34



PPSD (CH High)

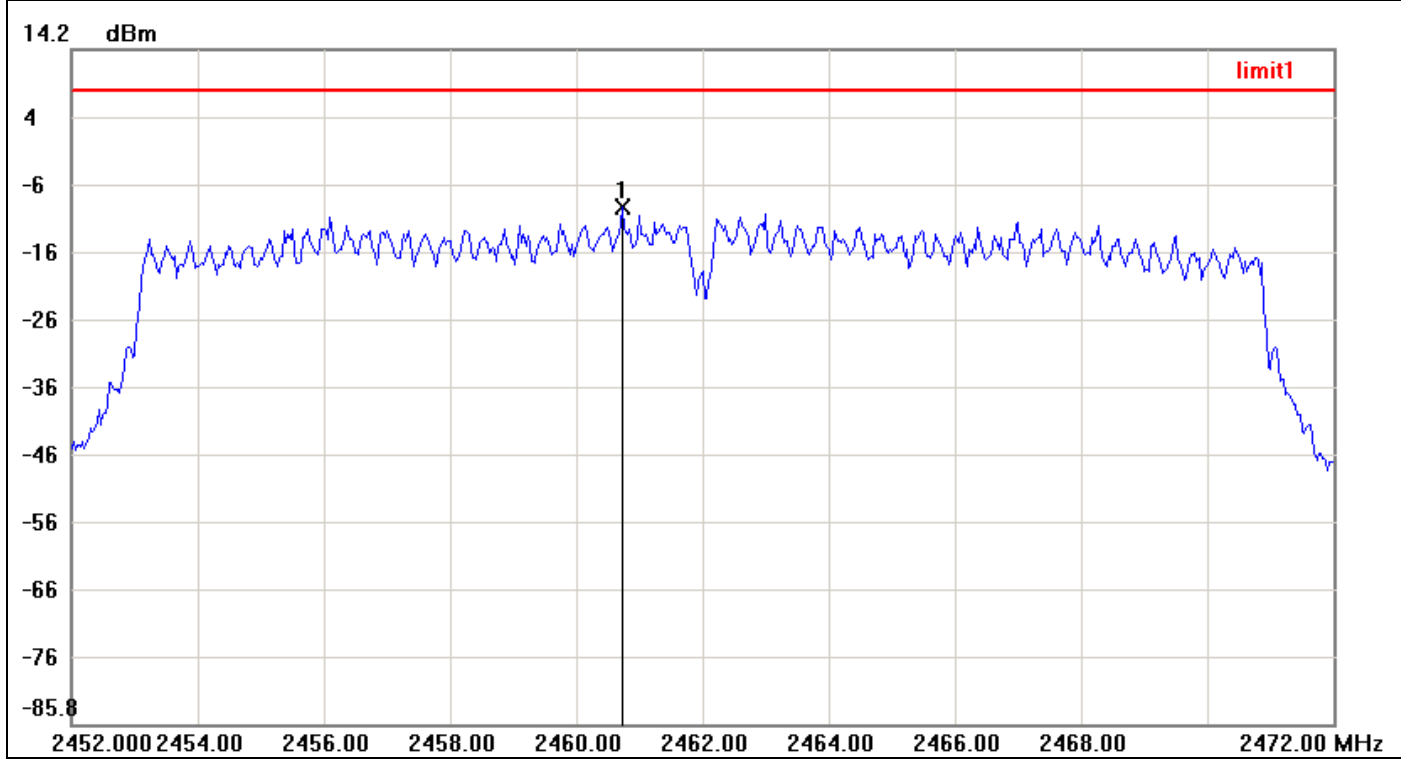

No.	Frequency(MHz)	Result(dBm)	Limit(dBm)	Margin(dBm)
1	2460.7333	-9.30	8.00	-17.30



## 7.6 SPURIOUS EMISSIONS

### 7.6.1 Conducted Measurement

#### **LIMIT**

According to §15.247(d), in any 100 kHz bandwidth outside the frequency bands in which the spread spectrum intentional radiator is operating, the radio frequency power that is produced by the intentional radiator shall be at least 20 dB below that in the 100 kHz bandwidth within the band that contains the highest level of the desired power, based on either an RF conducted or a radiated measurement, provided the transmitter demonstrates compliance with the peak conducted power limits. In addition, radiated emissions which fall in the restricted bands, as defined in §15.205(a), must also comply with the radiated emission limits specified in 15.209(a) (see Section 15.205(c)).

#### **Test Configuration**

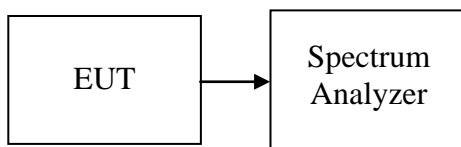

#### **TEST PROCEDURE**

Conducted RF measurements of the transmitter output were made to confirm that the EUT antenna port conducted emissions meet the specified limit and to identify any spurious signals that require further investigation or measurements on the radiated emissions site.

The transmitter output is connected to the spectrum analyzer. The resolution bandwidth is set to 100 kHz. The video bandwidth is set to 100 kHz.

Measurements are made over the 30MHz to 26GHz range with the transmitter set to the lowest, middle, and highest channels.

#### **TEST RESULTS**

*No non-compliance noted*



**Test Plot**

**IEEE 802.11b mode**

**CH Low**

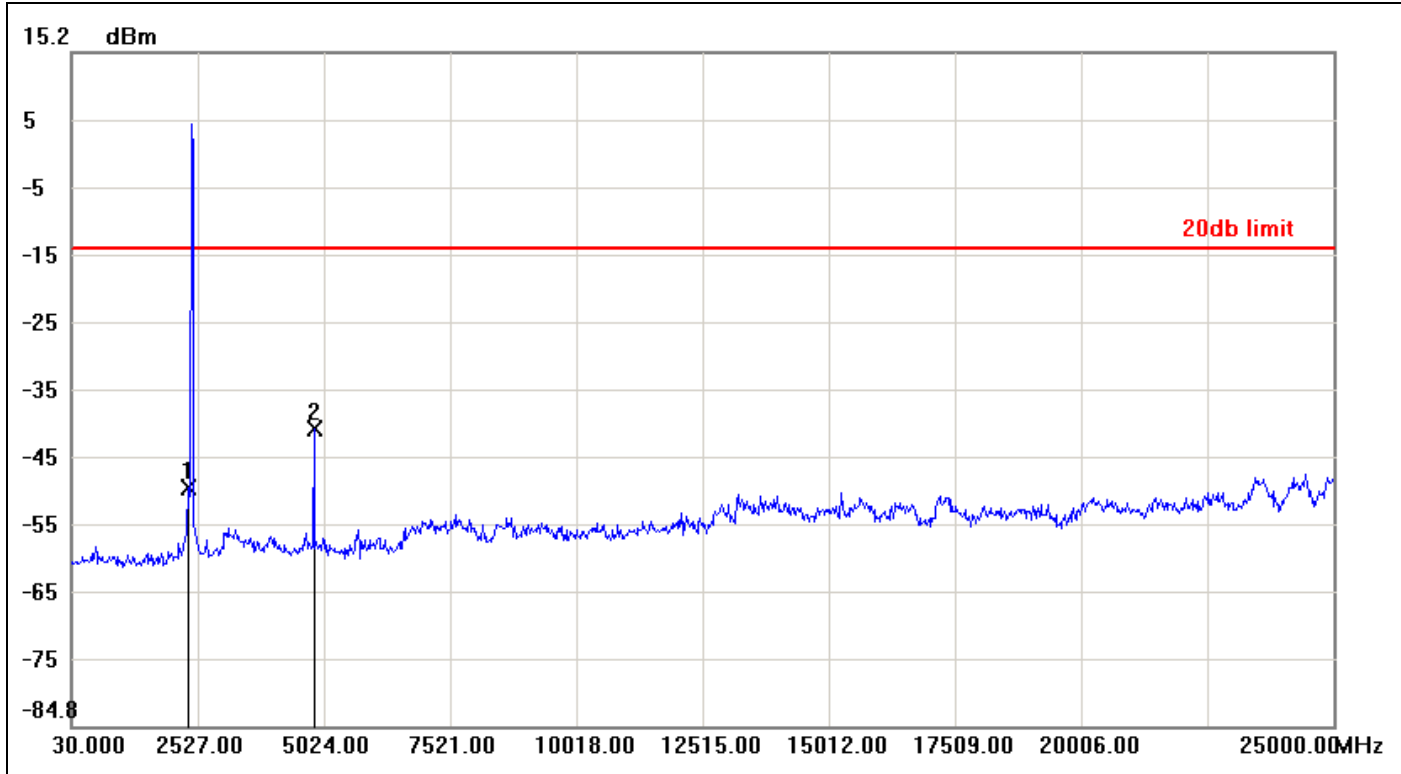

No.	Frequency(MHz)	Result(dBm)	Limit(dBm)	Margin(dBm)
1	2327.2400	-49.45	-13.85	-35.60
2	4824.2400	-40.63	-13.85	-26.78



### CH Mid

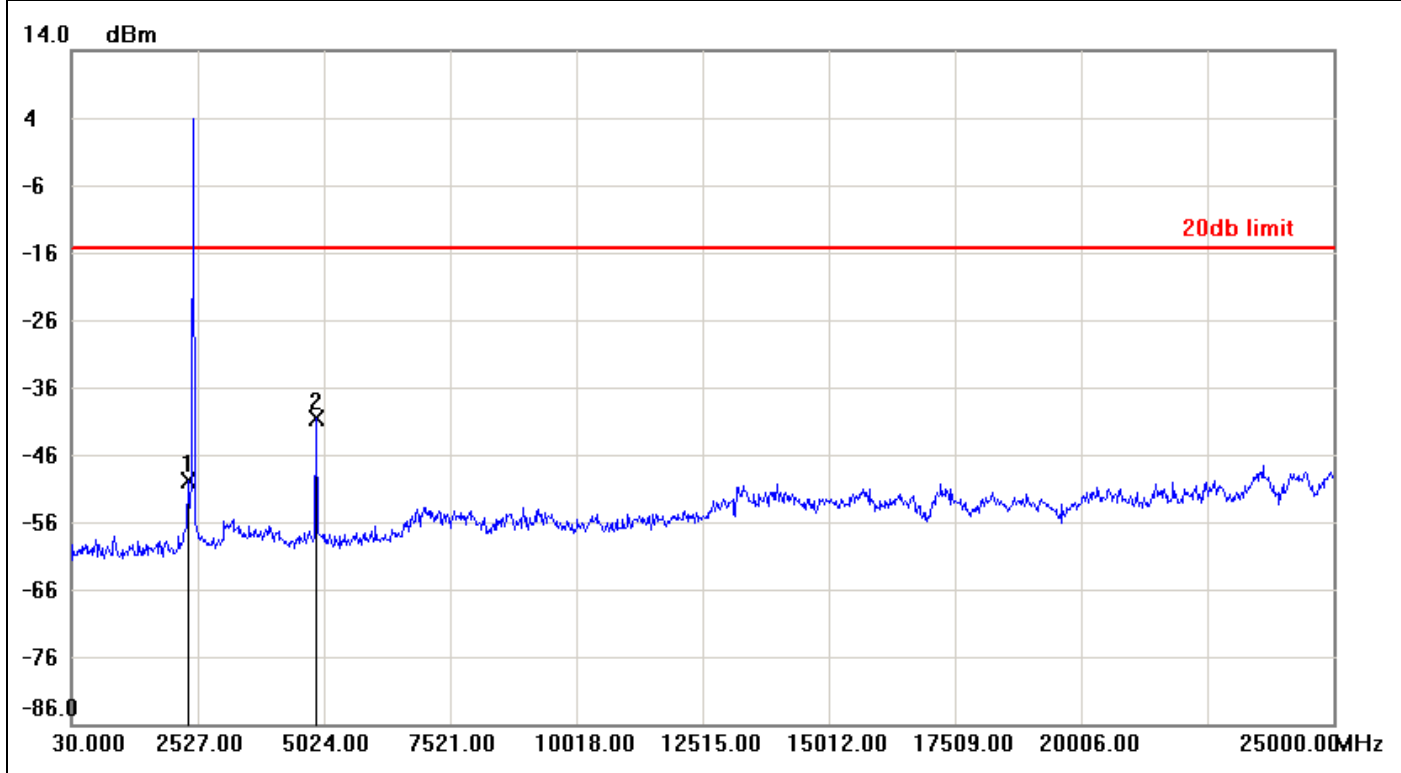

No.	Frequency(MHz)	Result(dBm)	Limit(dBm)	Margin(dBm)
1	2327.2400	-49.80	-15.28	-34.52
2	4874.1800	-40.49	-15.28	-25.21



### CH High

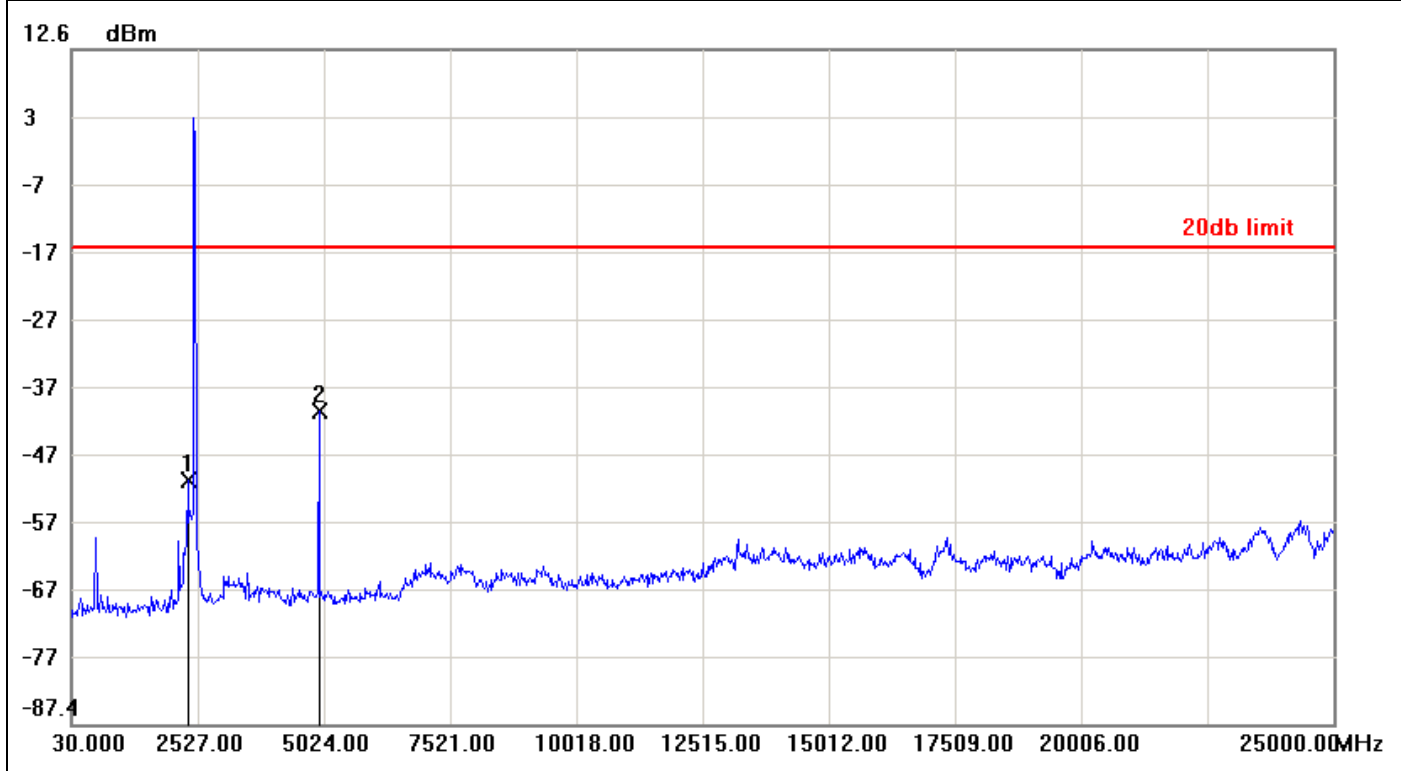

No.	Frequency(MHz)	Result(dBm)	Limit(dBm)	Margin(dBm)
1	2327.2400	-51.23	-16.83	-34.40
2	4924.1200	-40.91	-16.83	-24.08



IEEE 802.11g mode

CH Low

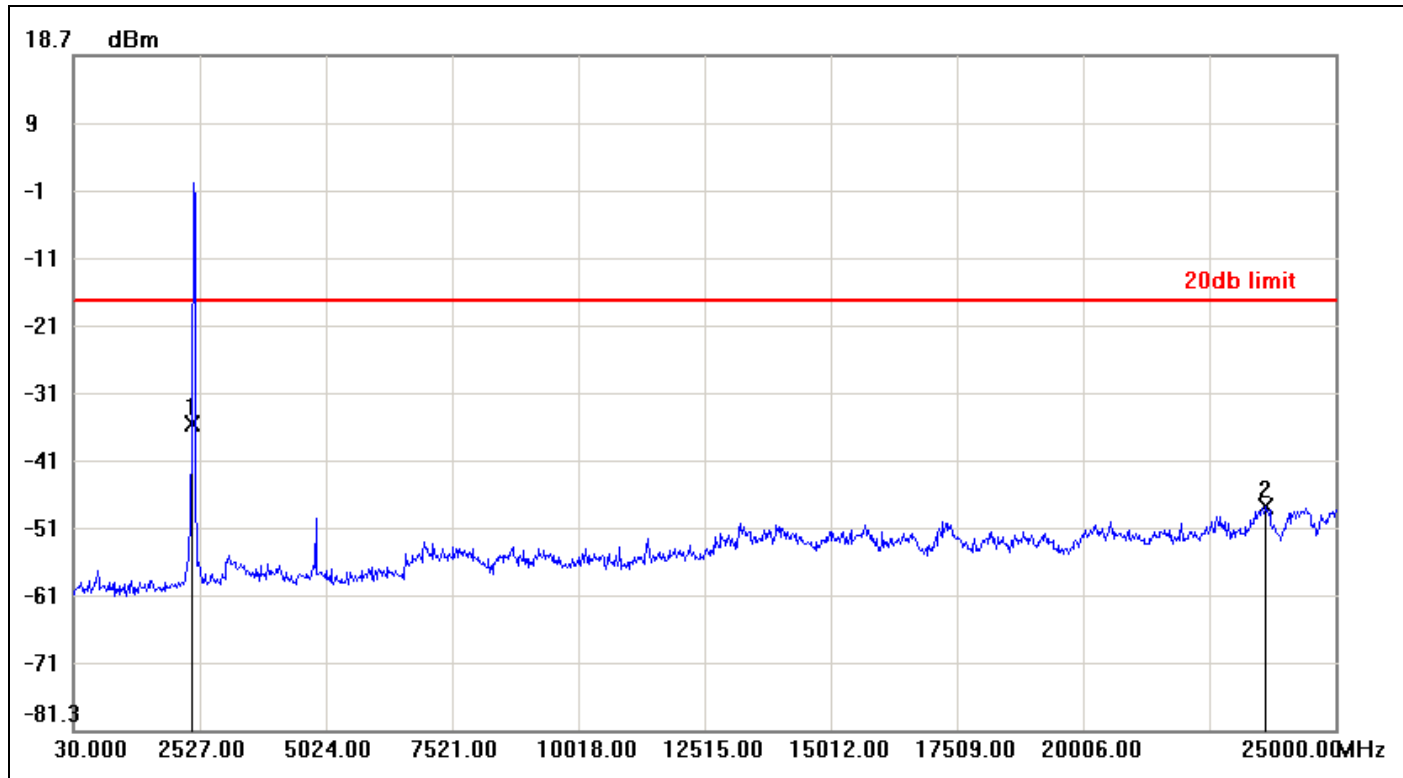

No.	Frequency(MHz)	Result(dBm)	Limit(dBm)	Margin(dBm)
1	2377.1800	-35.87	-17.64	-18.23
2	23626.6500	-48.15	-17.64	-30.51





### CH Mid

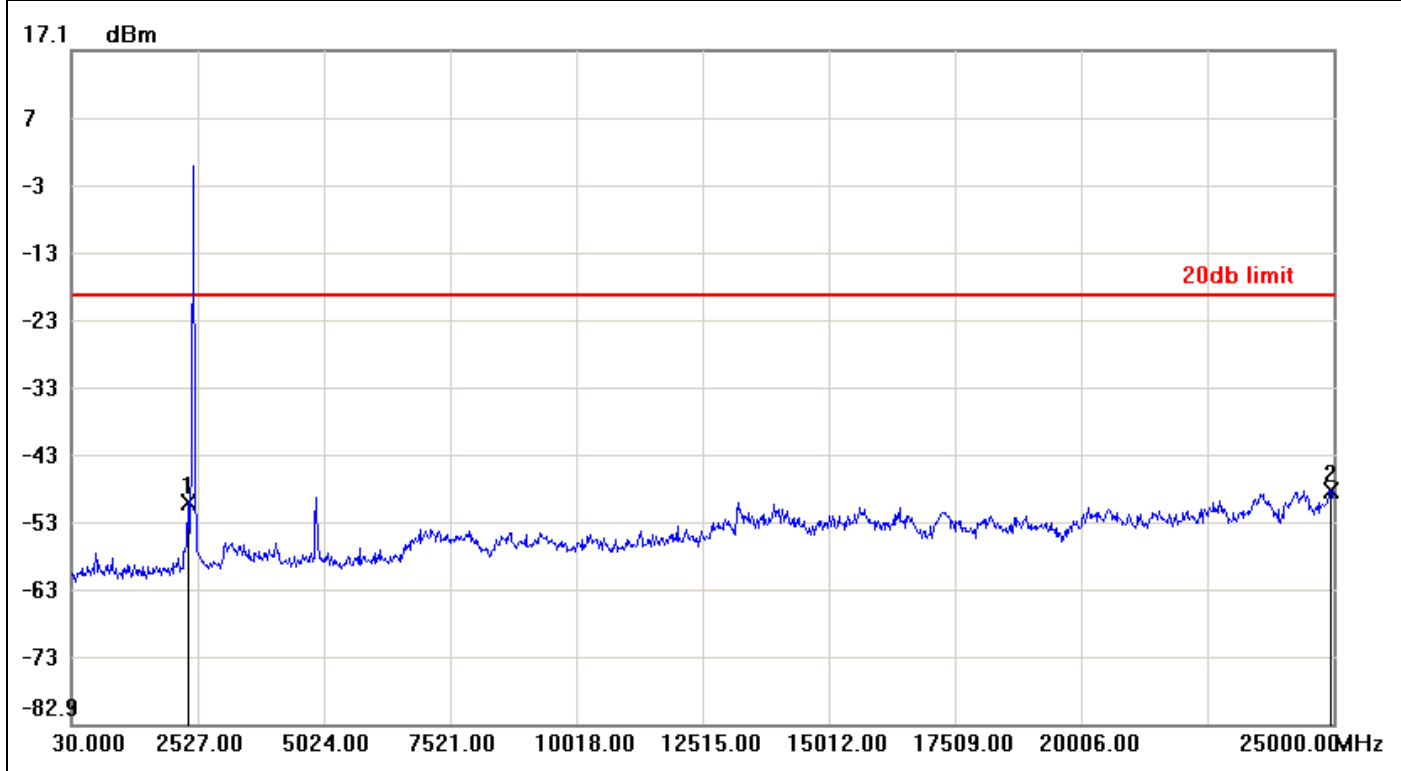

No.	Frequency(MHz)	Result(dBm)	Limit(dBm)	Margin(dBm)
1	2327.2400	-50.10	-19.40	-30.70
2	24950.0600	-48.17	-19.40	-28.77



### CH High

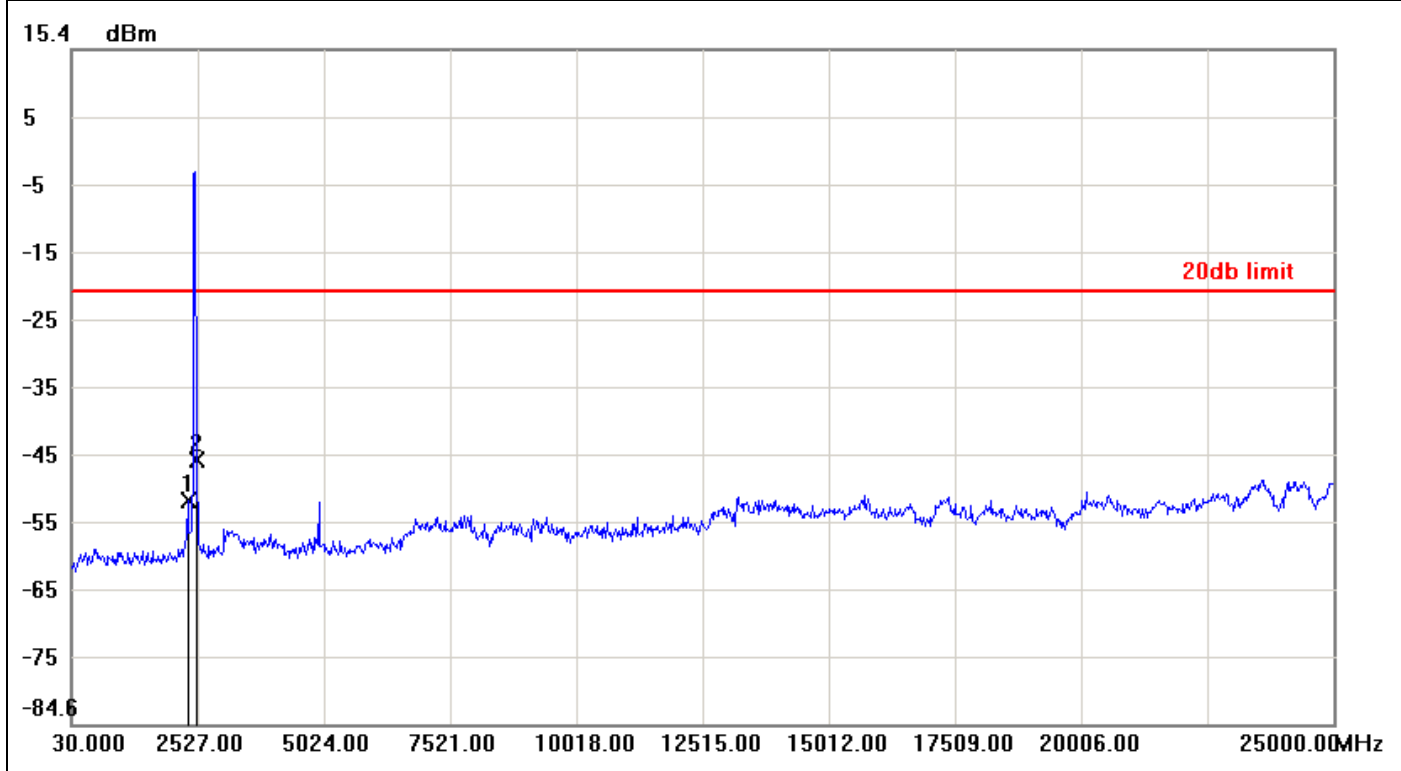

No.	Frequency(MHz)	Result(dBm)	Limit(dBm)	Margin(dBm)
1	2327.2400	-51.47	-20.41	-31.06
2	2502.0300	-45.56	-20.41	-25.15



IEEE 802.11n HT 20 mode

CH Low

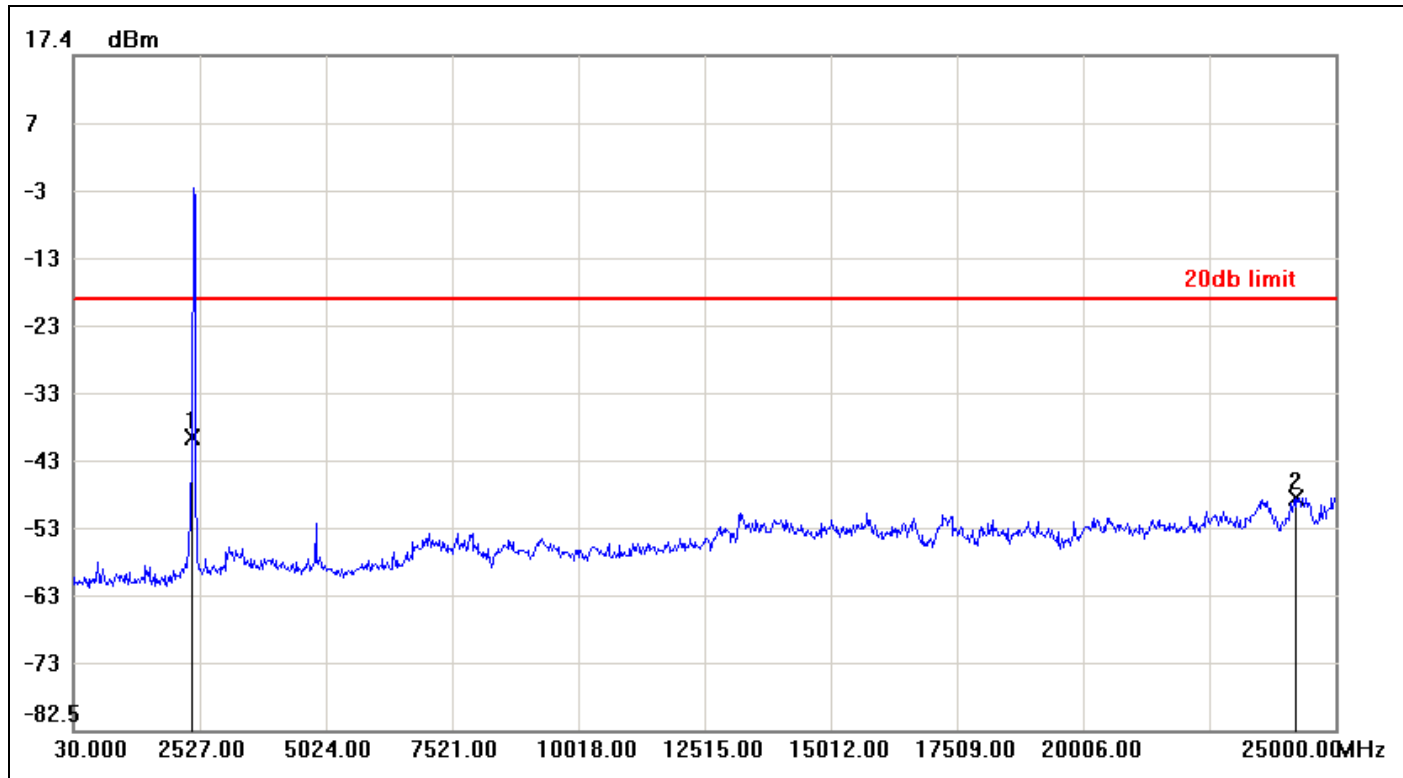

No.	Frequency(MHz)	Result(dBm)	Limit(dBm)	Margin(dBm)
1	2377.1800	-39.08	-18.69	-20.39
2	24225.9300	-48.09	-18.69	-29.40



CH Mid

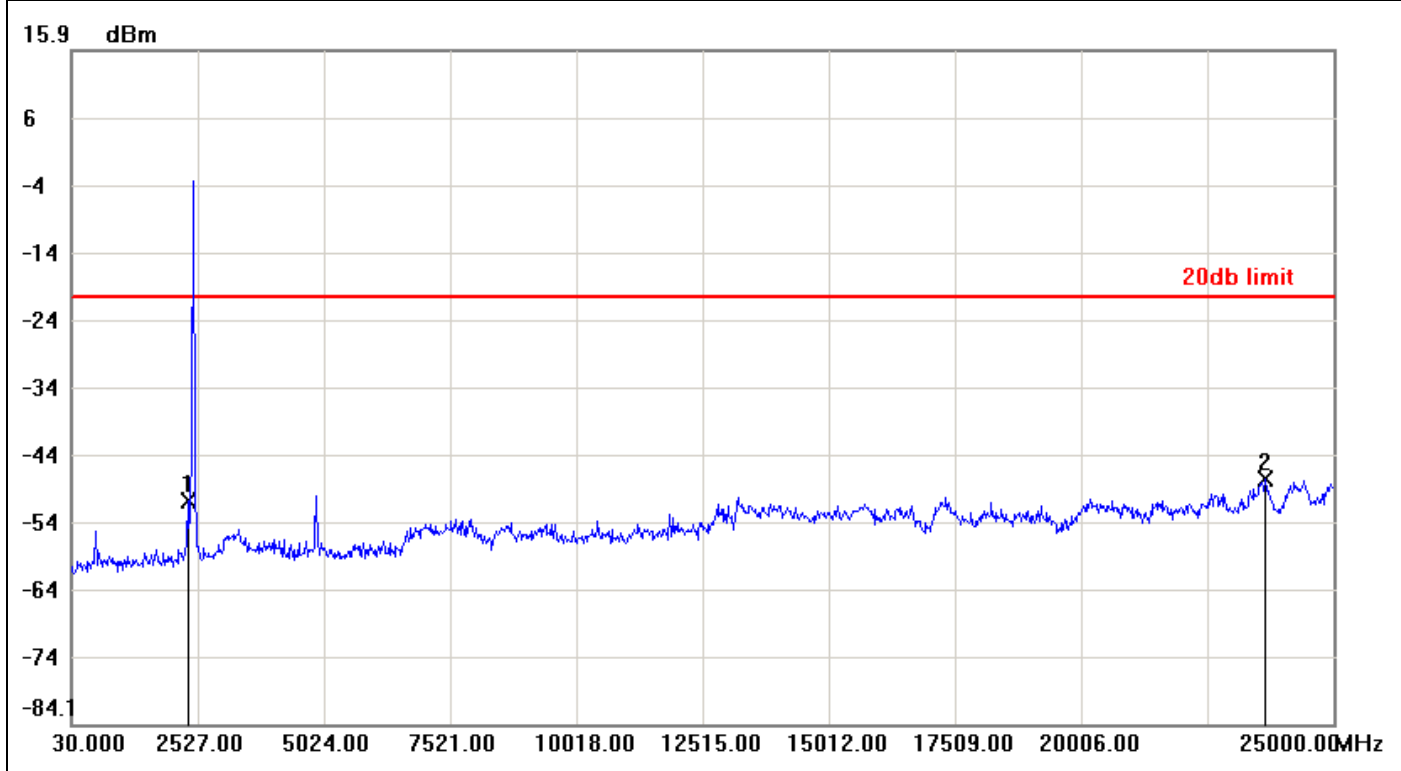

No.	Frequency(MHz)	Result(dBm)	Limit(dBm)	Margin(dBm)
1	2327.2400	-51.03	-20.61	-30.42
2	23651.6200	-47.74	-20.61	-27.13



### CH High

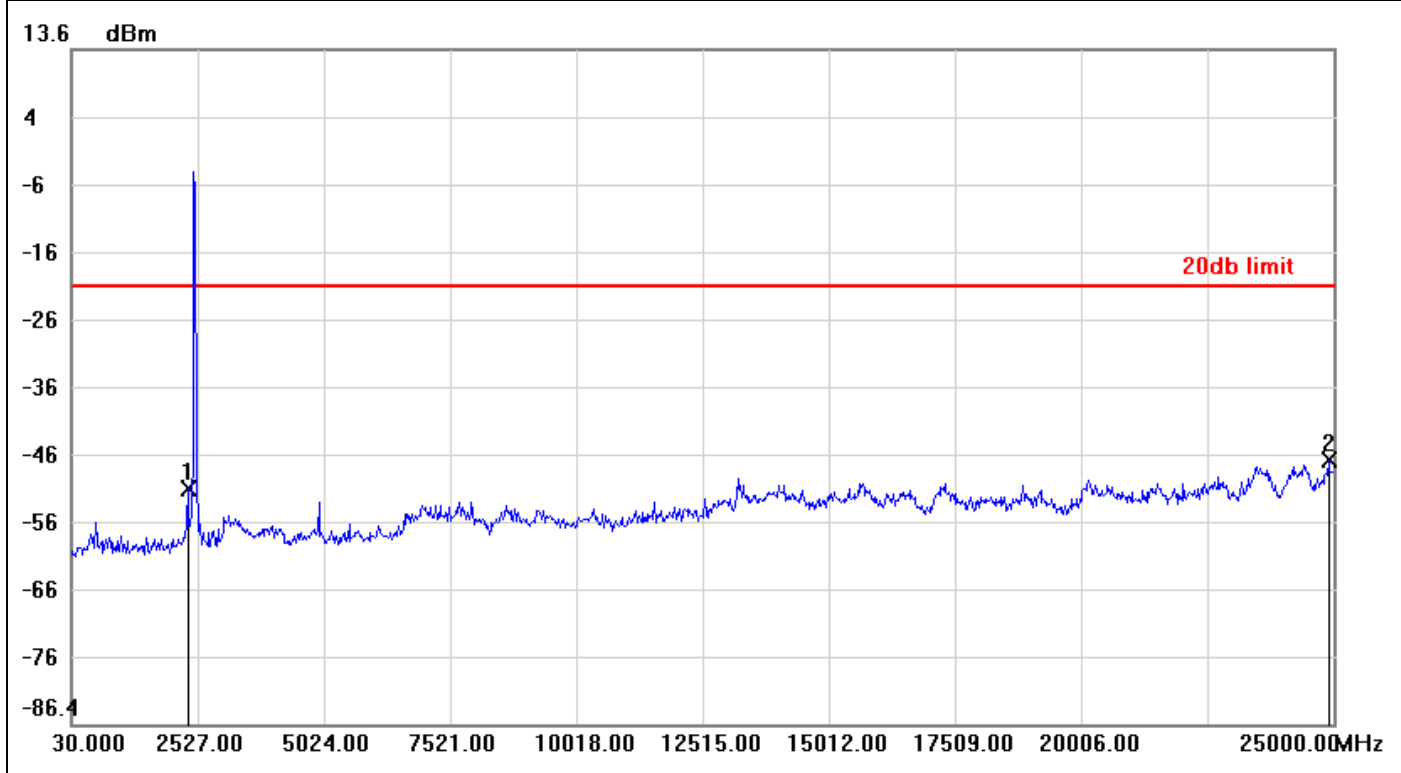

No.	Frequency(MHz)	Result(dBm)	Limit(dBm)	Margin(dBm)
1	2327.2400	-51.43	-21.47	-29.96
2	24900.1200	-47.38	-21.47	-25.91



## 7.7 RADIATED EMISSIONS

### LIMIT

1. According to §15.209(a), except as provided elsewhere in this Subpart, the emissions from an intentional radiator shall not exceed the field strength levels specified in the following table:

Frequency (MHz)	Field Strength ( $\mu\text{V/m}$ )	Measurement Distance (m)
0.009 - 0.490	2400/F(kHz)	300
0.490 - 1.705	24000/F(kHz)	30
1.705 – 30.0	30	30
30-88	100	3
88-216	150	3
216-960	200	3
Above 960	500	3

**Remark:** Except as provided in paragraph (g), fundamental emissions from intentional radiators operating under this Section shall not be located in the frequency bands 54-72 MHz, 76-88 MHz, 174-216 MHz or 470-806 MHz. However, operation within these frequency bands is permitted under other sections of this Part, e.g., Sections 15.231 and 15.241.

2. In the emission table above, the tighter limit applies at the band edges.

Frequency (MHz)	Field Strength ( $\mu\text{V/m}$ at 3-meter)	Field Strength (dB $\mu\text{V/m}$ at 3-meter)
0.009 - 0.490	2400/F(kHz) +80	20LOG((2400/F(kHz))+80)
0.490 - 1.705	24000/F(kHz) +40	20LOG((24000/F(kHz))+40)
1.705 – 30.0	30	69.54
30-88	100	40
88-216	150	43.5
216-960	200	46
Above 960	500	54



**Test Configuration**

**9kHz ~ 30MHz**

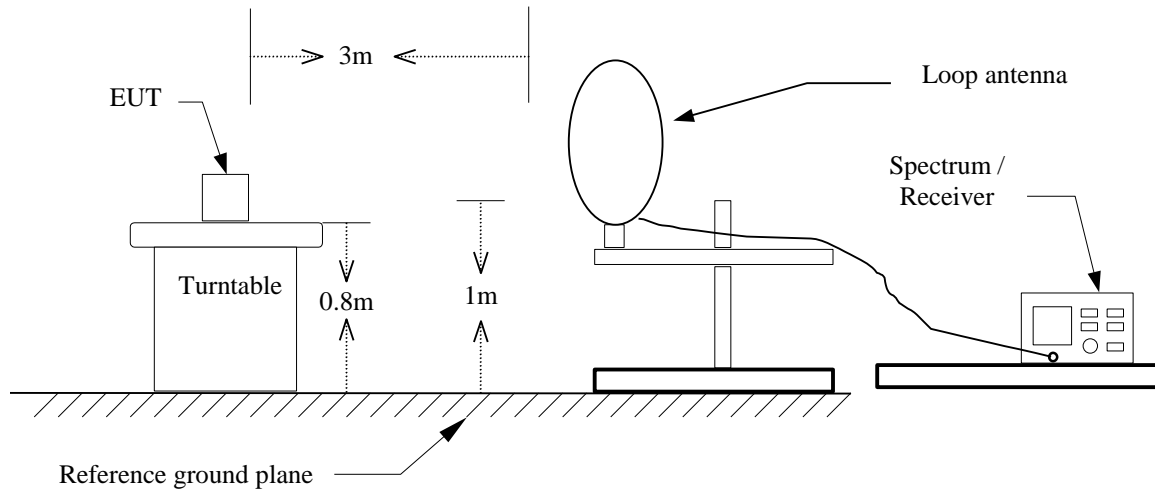

**30MHz ~ 1GHz**

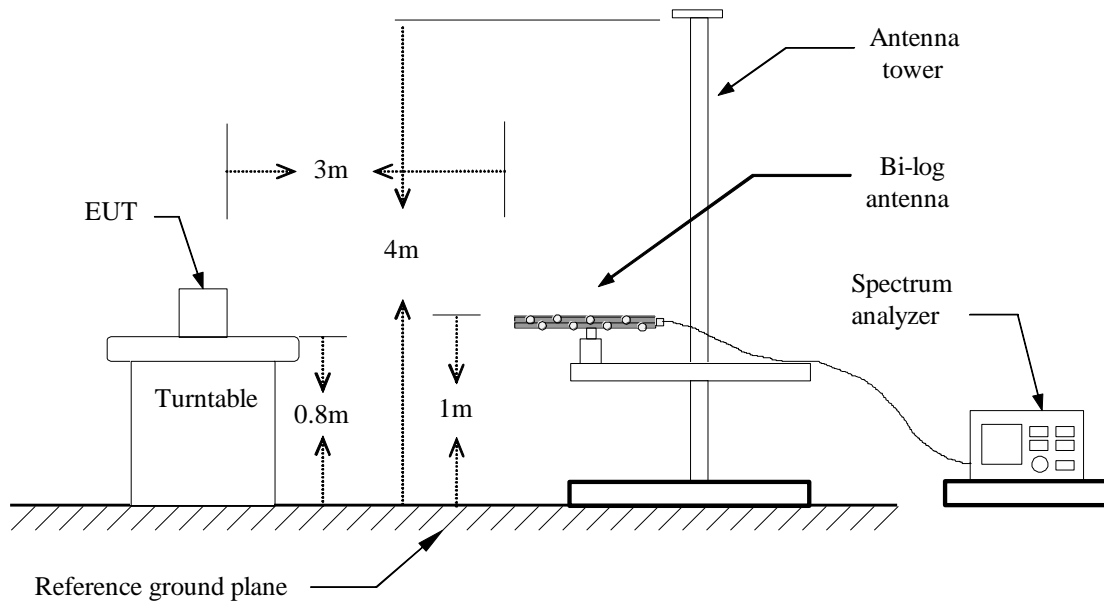



Above 1 GHz

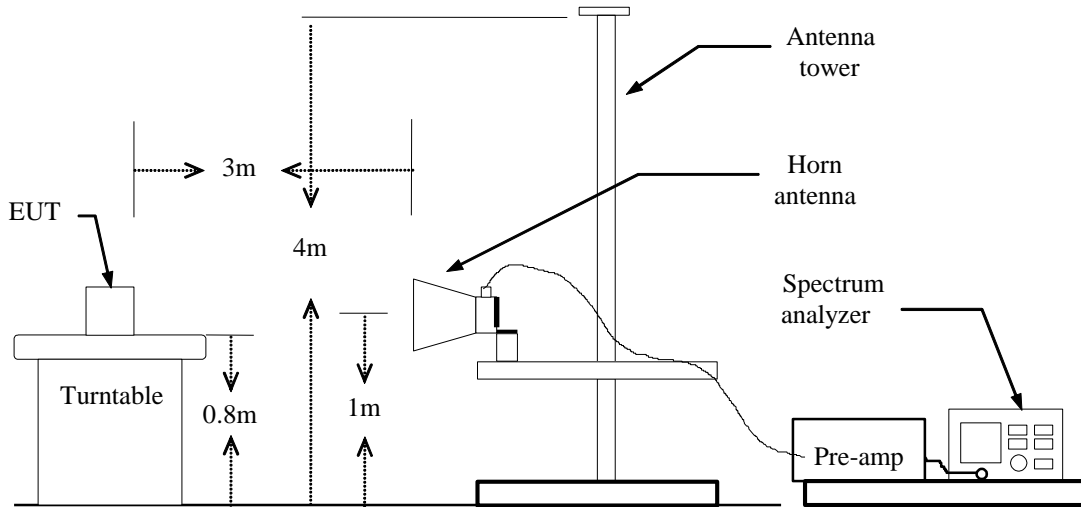





## **TEST PROCEDURE**

1. The EUT is placed on a turntable, which is 0.8m above ground plane.
2. The turntable shall be rotated for 360 degrees to determine the position of maximum emission level.
3. EUT is set 3m away from the receiving antenna, which is varied from 1m to 4m to find out the highest emissions.
4. Maximum procedure was performed on the six highest emissions to ensure EUT compliance.
5. And also, each emission was to be maximized by changing the polarization of receiving antenna both horizontal and vertical.
6. Set the spectrum analyzer in the following setting as:  
Below 1GHz:  
RBW=100kHz / VBW=300kHz / Sweep=AUTO  
Above 1GHz:  
(a) PEAK: RBW=1MHz / VBW=3MHz / Sweep=AUTO  
(b) AVERAGE: RBW=1MHz / VBW=300Hz / Sweep=AUTO
7. Repeat above procedures until the measurements for all frequencies are complete.



## TEST RESULTS

### Below 1GHz

**Operation Mode:** Normal Link

**Test Date:** February 25, 2015

**Temperature:** 26°C

**Tested by:** Owen Wu

**Humidity:** 60% RH

**Polarity:** Ver. / Hor.

Frequency (MHz)	Reading (dBuV)	Correction Factor (dB/m)	Result (dBuV/m)	Limit (dBuV/m)	Margin (dB)	Remark	Ant. Pol. (H/V)
167.7400	50.57	-18.69	31.88	43.50	-11.62	Peak	V
282.2000	43.11	-16.72	26.39	46.00	-19.61	Peak	V
451.9500	42.41	-12.63	29.78	46.00	-16.22	Peak	V
506.2700	40.00	-11.73	28.27	46.00	-17.73	Peak	V
676.9900	34.20	-9.03	25.17	46.00	-20.83	Peak	V
735.1900	34.52	-8.15	26.37	46.00	-19.63	Peak	V
149.3100	34.34	-17.96	16.38	43.50	-27.12	Peak	H
279.2900	35.41	-16.78	18.63	46.00	-27.37	Peak	H
425.7600	34.84	-13.32	21.52	46.00	-24.48	Peak	H
545.0700	34.51	-11.08	23.43	46.00	-22.57	Peak	H
667.2900	34.50	-9.13	25.37	46.00	-20.63	Peak	H
743.9200	34.56	-7.99	26.57	46.00	-19.43	Peak	H

### **Remark:**

1. No emission found between lowest internal used/generated frequency to 30MHz (9kHz~30MHz)
2. Radiated emissions measured in frequency range from 30 MHz to 1000MHz were made with an instrument using peak/quasi-peak detector mode.
3. Quasi-peak test would be performed if the peak result were greater than the quasi-peak limit or as required by the applicant.
4. Measurements above show only up to 6 maximum emissions noted, or would be lesser, with " N/A " remark, if no specific emissions from the EUT are recorded (ie: margin>20dB from the applicable limit) and considered that's already beyond the background noise floor.
5.  $Margin (dB) = Result (dBuV/m) - Limit (dBuV/m)$ .



**Above 1 GHz**

**Operation Mode:** TX / IEEE 802.11b / CH Low

**Test Date:** February 25, 2015

**Temperature:** 23°C

**Tested by:** Owen Wu

**Humidity:** 55 % RH

**Polarity:** Ver. / Hor.

Frequency (MHz)	Reading (dBuV)	Correction (dB/m)	Result (dBuV/m)	Limit (dBuV/m)	Margin (dB)	Remark	Ant.Pol. (H/V)
1898.000	50.32	-5.42	44.90	74.00	-29.10	peak	V
4825.000	56.20	4.01	60.21	74.00	-13.79	peak	V
4825.000	48.40	4.01	52.41	54.00	-1.59	AVG	V
N/A							
1960.000	50.45	-5.09	45.36	74.00	-28.64	peak	H
4825.000	48.93	4.01	52.94	74.00	-21.06	peak	H
4825.000	47.42	4.01	51.43	54.00	-2.57	AVG	H
N/A							

**Remark:**

1. Measuring frequencies from 1 GHz to the 10th harmonic of highest fundamental frequency.
2. Radiated emissions measured in frequency above 1000MHz were made with an instrument using peak/average detector mode.
3. Average test would be performed if the peak result were greater than the average limit or as required by the applicant.
4. Data of measurement within this frequency range shown “ --- ” in the table above means the reading of emissions are attenuated more than 20dB below the permissible limits or the field strength is too small to be measured.
5. Measurements above show only up to 6 maximum emissions noted, or would be lesser, with “ N/A ” remark, if no specific emissions from the EUT are recorded (ie: margin>20dB from the applicable limit) and considered that's already beyond the background noise floor.
6. Margin (dB) = Result (dBuV/m) – limit (dBuV/m).



**Operation Mode:** TX / IEEE 802.11b / CH Mid

**Test Date:** February 25, 2015

**Temperature:** 23°C

**Tested by:** Owen Wu

**Humidity:** 55 % RH

**Polarity:** Ver. / Hor.

Frequency (MHz)	Reading (dBuV)	Correction (dB/m)	Result (dBuV/m)	Limit (dBuV/m)	Margin (dB)	Remark	Ant.Pol. (H/V)
2000.000	50.89	-4.88	46.01	74.00	-27.99	peak	V
4875.000	54.08	3.92	58.00	74.00	-16.00	peak	V
4875.000	48.43	3.92	52.35	54.00	-1.65	AVG	V
N/A							
2332.000	52.50	-4.22	48.28	74.00	-25.72	peak	H
4875.000	49.79	3.92	53.71	74.00	-20.29	peak	H
4875.000	47.97	3.92	51.89	54.00	-2.11	AVG	H
N/A							

**Remark:**

1. Measuring frequencies from 1 GHz to the 10th harmonic of highest fundamental frequency.
2. Radiated emissions measured in frequency above 1000MHz were made with an instrument using peak/average detector mode.
3. Average test would be performed if the peak result were greater than the average limit or as required by the applicant.
4. Data of measurement within this frequency range shown “ --- ” in the table above means the reading of emissions are attenuated more than 20dB below the permissible limits or the field strength is too small to be measured.
5. Measurements above show only up to 6 maximum emissions noted, or would be lesser; with “ N/A ” remark, if no specific emissions from the EUT are recorded (ie: margin>20dB from the applicable limit) and considered that's already beyond the background noise floor.
6. Margin (dB) = Result (dBuV/m) – limit (dBuV/m).



**Operation Mode:** TX / IEEE 802.11b / CH High

**Test Date:** February 25, 2015

**Temperature:** 23°C

**Tested by:** Owen Wu

**Humidity:** 55 % RH

**Polarity:** Ver. / Hor.

Frequency (MHz)	Reading (dBuV)	Correction (dB/m)	Result (dBuV/m)	Limit (dBuV/m)	Margin (dB)	Remark	Ant.Pol. (H/V)
2330.000	52.80	-4.22	48.58	74.00	-25.42	peak	V
4925.000	54.57	3.90	58.47	74.00	-15.53	peak	V
4925.000	48.43	3.90	52.33	54.00	-1.67	AVG	V
N/A							
1984.000	49.93	-4.96	44.97	74.00	-29.03	peak	H
4925.000	46.95	3.90	50.85	74.00	-23.15	peak	H
N/A							

**Remark:**

1. Measuring frequencies from 1 GHz to the 10th harmonic of highest fundamental frequency.
2. Radiated emissions measured in frequency above 1000MHz were made with an instrument using peak/average detector mode.
3. Average test would be performed if the peak result were greater than the average limit or as required by the applicant.
4. Data of measurement within this frequency range shown “ --- ” in the table above means the reading of emissions are attenuated more than 20dB below the permissible limits or the field strength is too small to be measured.
5. Measurements above show only up to 6 maximum emissions noted, or would be lesser, with “ N/A ” remark, if no specific emissions from the EUT are recorded (ie: margin>20dB from the applicable limit) and considered that's already beyond the background noise floor.
6. Margin (dB) = Result (dBuV/m) – limit (dBuV/m).



**Operation Mode:** TX / IEEE 802.11g / CH Low

**Test Date:** February 25, 2015

**Temperature:** 23°C

**Tested by:** Owen Wu

**Humidity:** 55 % RH

**Polarity:** Ver. / Hor.

Frequency (MHz)	Reading (dBuV)	Correction (dB/m)	Result (dBuV/m)	Limit (dBuV/m)	Margin (dB)	Remark	Ant.Pol. (H/V)
2332.000	52.94	-4.22	48.72	74.00	-25.28	peak	V
4545.000	40.58	7.37	47.95	74.00	-26.05	peak	V
6000.000	40.68	12.40	53.08	74.00	-20.92	peak	V
N/A							
2330.000	52.23	-4.22	48.01	74.00	-25.99	peak	H
4405.000	40.80	6.84	47.64	74.00	-26.36	peak	H
5440.000	39.24	10.01	49.25	74.00	-24.75	peak	H
N/A							

**Remark:**

1. Measuring frequencies from 1 GHz to the 10th harmonic of highest fundamental frequency.
2. Radiated emissions measured in frequency above 1000MHz were made with an instrument using peak/average detector mode.
3. Average test would be performed if the peak result were greater than the average limit or as required by the applicant.
4. Data of measurement within this frequency range shown “ --- ” in the table above means the reading of emissions are attenuated more than 20dB below the permissible limits or the field strength is too small to be measured.
5. Measurements above show only up to 6 maximum emissions noted, or would be lesser, with “ N/A ” remark, if no specific emissions from the EUT are recorded (ie: margin>20dB from the applicable limit) and considered that's already beyond the background noise floor.
6.  $Margin (dB) = Result (dBuV/m) - limit (dBuV/m).$



**Operation Mode:** TX / IEEE 802.11g / CH Mid

**Test Date:** February 25, 2015

**Temperature:** 23°C

**Tested by:** Owen Wu

**Humidity:** 55 % RH

**Polarity:** Ver. / Hor.

Frequency (MHz)	Reading (dBuV)	Correction (dB/m)	Result (dBuV/m)	Limit (dBuV/m)	Margin (dB)	Remark	Ant.Pol. (H/V)
2332.000	54.42	-4.22	50.20	74.00	-23.80	peak	V
4385.000	41.12	6.75	47.87	74.00	-26.13	peak	V
5330.000	40.04	9.60	49.64	74.00	-24.36	peak	V
N/A							
1996.000	50.33	-4.90	45.43	74.00	-28.57	peak	H
4645.000	40.65	7.64	48.29	74.00	-25.71	peak	H
6315.000	39.71	13.51	53.22	74.00	-20.78	peak	H
N/A							

**Remark:**

1. Measuring frequencies from 1 GHz to the 10th harmonic of highest fundamental frequency.
2. Radiated emissions measured in frequency above 1000MHz were made with an instrument using peak/average detector mode.
3. Average test would be performed if the peak result were greater than the average limit or as required by the applicant.
4. Data of measurement within this frequency range shown “ --- ” in the table above means the reading of emissions are attenuated more than 20dB below the permissible limits or the field strength is too small to be measured.
5. Measurements above show only up to 6 maximum emissions noted, or would be lesser; with “ N/A ” remark, if no specific emissions from the EUT are recorded (ie: margin > 20dB from the applicable limit) and considered that's already beyond the background noise floor.
6.  $Margin (dB) = Result (dBuV/m) - limit (dBuV/m).$



**Operation Mode:** TX / IEEE 802.11g / CH High

**Test Date:** February 25, 2015

**Temperature:** 23°C

**Tested by:** Owen Wu

**Humidity:** 55 % RH

**Polarity:** Ver. / Hor.

Frequency (MHz)	Reading (dBuV)	Correction (dB/m)	Result (dBuV/m)	Limit (dBuV/m)	Margin (dB)	Remark	Ant.Pol. (H/V)
2334.000	53.02	-4.23	48.79	74.00	-25.21	peak	V
4460.000	40.40	7.08	47.48	74.00	-26.52	peak	V
6390.000	39.43	13.77	53.20	74.00	-20.80	peak	V
N/A							
2336.000	53.25	-4.23	49.02	74.00	-24.98	peak	H
4495.000	40.80	7.23	48.03	74.00	-25.97	peak	H
6490.000	38.15	14.12	52.27	74.00	-21.73	peak	H
N/A							

**Remark:**

1. Measuring frequencies from 1 GHz to the 10th harmonic of highest fundamental frequency.
2. Radiated emissions measured in frequency above 1000MHz were made with an instrument using peak/average detector mode.
3. Average test would be performed if the peak result were greater than the average limit or as required by the applicant.
4. Data of measurement within this frequency range shown “ --- ” in the table above means the reading of emissions are attenuated more than 20dB below the permissible limits or the field strength is too small to be measured.
5. Measurements above show only up to 6 maximum emissions noted, or would be lesser; with “ N/A ” remark, if no specific emissions from the EUT are recorded (ie: margin > 20dB from the applicable limit) and considered that's already beyond the background noise floor.
6. Margin (dB) = Result (dBuV/m) – limit (dBuV/m).





**Operation Mode:** TX / IEEE 802.11n HT 20 mode / CH Low

**Test Date:** February 25, 2015

**Temperature:** 23°C

**Tested by:** Owen Wu

**Humidity:** 55 % RH

**Polarity:** Ver. / Hor.

Frequency (MHz)	Reading (dBuV)	Correction (dB/m)	Result (dBuV/m)	Limit (dBuV/m)	Margin (dB)	Remark	Ant.Pol. (H/V)
2328.000	54.04	-4.23	49.81	74.00	-24.19	peak	V
4450.000	40.09	7.03	47.12	74.00	-26.88	peak	V
5490.000	39.71	9.78	49.49	74.00	-24.51	peak	V
N/A							
2130.000	51.33	-4.82	46.51	74.00	-27.49	peak	H
4615.000	40.24	7.56	47.80	74.00	-26.20	peak	H
5540.000	39.42	9.94	49.36	74.00	-24.64	peak	H
N/A							

**Remark:**

1. Measuring frequencies from 1 GHz to the 10th harmonic of highest fundamental frequency.
2. Radiated emissions measured in frequency above 1000MHz were made with an instrument using peak/average detector mode.
3. Average test would be performed if the peak result were greater than the average limit or as required by the applicant.
4. Data of measurement within this frequency range shown “ --- ” in the table above means the reading of emissions are attenuated more than 20dB below the permissible limits or the field strength is too small to be measured.
5. Measurements above show only up to 6 maximum emissions noted, or would be lesser, with “ N/A ” remark, if no specific emissions from the EUT are recorded (ie: margin>20dB from the applicable limit) and considered that's already beyond the background noise floor.
6.  $Margin (dB) = Result (dBuV/m) - limit (dBuV/m).$



**Operation Mode:** TX / IEEE 802.11n HT 20 mode / CH Mid

**Test Date:** February 25, 2015

**Temperature:** 23°C

**Tested by:** Owen Wu

**Humidity:** 55 % RH

**Polarity:** Ver. / Hor.

Frequency (MHz)	Reading (dBuV)	Correction (dB/m)	Result (dBuV/m)	Limit (dBuV/m)	Margin (dB)	Remark	Ant.Pol. (H/V)
2330.000	54.39	-4.22	50.17	74.00	-23.83	peak	V
4335.000	40.08	6.53	46.61	74.00	-27.39	peak	V
5340.000	40.29	9.68	49.97	74.00	-24.03	peak	V
N/A							
1996.000	50.48	-4.90	45.58	74.00	-28.42	peak	H
3740.000	42.50	4.00	46.50	74.00	-27.50	peak	H
5500.000	39.74	9.73	49.47	74.00	-24.53	peak	H
N/A							

**Remark:**

1. Measuring frequencies from 1 GHz to the 10th harmonic of highest fundamental frequency.
2. Radiated emissions measured in frequency above 1000MHz were made with an instrument using peak/average detector mode.
3. Average test would be performed if the peak result were greater than the average limit or as required by the applicant.
4. Data of measurement within this frequency range shown “ --- ” in the table above means the reading of emissions are attenuated more than 20dB below the permissible limits or the field strength is too small to be measured.
5. Measurements above show only up to 6 maximum emissions noted, or would be lesser; with “ N/A ” remark, if no specific emissions from the EUT are recorded (ie: margin>20dB from the applicable limit) and considered that's already beyond the background noise floor.
6. Peak Margin (dB) = Peak result (dBuV/m) – Peak limit (dBuV/m).  
Average Margin (dB) = Peak result (dBuV/m) – Average limit (dBuV/m).



**Operation Mode:** TX / IEEE 802.11n HT 20 mode / CH High

**Test Date:** February 25, 2015

**Temperature:** 23°C

**Tested by:** Owen Wu

**Humidity:** 55 % RH

**Polarity:** Ver. / Hor.

Frequency (MHz)	Reading (dBuV)	Correction (dB/m)	Result (dBuV/m)	Limit (dBuV/m)	Margin (dB)	Remark	Ant.Pol. (H/V)
1666.000	52.67	-6.65	46.02	74.00	-27.98	peak	V
4395.000	41.04	6.79	47.83	74.00	-26.17	peak	V
5385.000	39.42	10.07	49.49	74.00	-24.51	peak	V
N/A							
2248.000	50.34	-4.36	45.98	74.00	-28.02	peak	H
3710.000	41.97	3.87	45.84	74.00	-28.16	peak	H
5440.000	39.89	10.01	49.90	74.00	-24.10	peak	H
N/A							

**Remark:**

1. Measuring frequencies from 1 GHz to the 10th harmonic of highest fundamental frequency.
2. Radiated emissions measured in frequency above 1000MHz were made with an instrument using peak/average detector mode.
3. Average test would be performed if the peak result were greater than the average limit or as required by the applicant.
4. Data of measurement within this frequency range shown “ --- ” in the table above means the reading of emissions are attenuated more than 20dB below the permissible limits or the field strength is too small to be measured.
5. Measurements above show only up to 6 maximum emissions noted, or would be lesser; with “ N/A ” remark, if no specific emissions from the EUT are recorded (ie: margin>20dB from the applicable limit) and considered that's already beyond the background noise floor.
6. Margin (dB) = Result (dBuV/m) – limit (dBuV/m).



## 7.8 POWERLINE CONDUCTED EMISSIONS

### LIMIT

According to §15.207(a), except as shown in paragraphs (b) and (c) of this section, for an intentional radiator that is designed to be connected to the public utility (AC) power line, the radio frequency voltage that is conducted back onto the AC power line on any frequency or frequencies within the band 150 kHz to 30 MHz shall not exceed the limits in the following table, as measured using a 50  $\mu$ H/50 ohms line impedance stabilization network (LISN). Compliance with the provisions of this paragraph shall be based on the measurement of the radio frequency voltage between each power line and ground at the power terminal. The lower limit applies at the boundary between the frequency ranges.

Frequency Range (MHz)	Limits (dB $\mu$ V)	
	Quasi-peak	Average
0.15 to 0.50	66 to 56*	56 to 46*
0.50 to 5	56	46
5 to 30	60	50

\* Decreases with the logarithm of the frequency.

### Test Configuration

See test photographs attached in Appendix 1 for the actual connections between EUT and support equipment.

### TEST PROCEDURE

1. The EUT was placed on a table, which is 0.8m above ground plane.
2. Maximum procedure was performed on the six highest emissions to ensure EUT compliance.
3. Repeat above procedures until all frequency measured were complete.



### TEST RESULTS

The initial step in collecting conducted data is a spectrum analyzer peak scan of the measurement range. Significant peaks are then marked as shown on the following data page, and these signals are then quasi-peaked.

#### Test Data

**Operation Mode:** Normal Link                      **Test Date:** March 2, 2015  
**Temperature:** 24°C                                      **Tested by:** Owen Wu  
**Humidity:** 50% RH

Freq. (MHz)	QP Reading (dBuV)	AV Reading (dBuV)	Corr. factor (dB/m)	QP Result (dBuV/m)	AV Result (dBuV/m)	QP Limit (dBuV)	AV Limit (dBuV)	QP Margin (dB)	AV Margin (dB)	Note
0.2678	33.00	31.98	9.58	42.58	41.56	61.18	51.19	-18.60	-9.63	L1
0.4876	22.71	16.02	9.58	32.29	25.60	56.21	46.21	-23.92	-20.61	L1
0.5197	36.26	27.46	9.58	45.84	37.04	56.00	46.00	-10.16	-8.96	L1
0.7229	28.38	17.64	9.59	37.97	27.23	56.00	46.00	-18.03	-18.77	L1
0.8562	28.61	17.66	9.59	38.20	27.25	56.00	46.00	-17.80	-18.75	L1
2.5752	26.91	16.17	9.60	36.51	25.77	56.00	46.00	-19.49	-20.23	L1
0.2679	32.58	31.73	9.63	42.21	41.36	61.18	51.18	-18.97	-9.82	L2
0.5039	28.72	19.06	9.63	38.35	28.69	56.00	46.00	-17.65	-17.31	L2
0.5917	26.90	17.19	9.63	36.53	26.82	56.00	46.00	-19.47	-19.18	L2
0.7316	22.93	13.73	9.64	32.57	23.37	56.00	46.00	-23.43	-22.63	L2
1.4299	18.52	11.75	9.64	28.16	21.39	56.00	46.00	-27.84	-24.61	L2
2.5111	20.16	12.60	9.65	29.81	22.25	56.00	46.00	-26.19	-23.75	L2

**Remark:**

1. Measuring frequencies from 0.15 MHz to 30MHz.
2. The emissions measured in frequency range from 0.15 MHz to 30MHz were made with an instrument using Quasi-peak detector and average detector.
3. The IF bandwidth of SPA between 0.15MHz and 30MHz was 10 kHz; the IF bandwidth of Test Receiver between 0.15MHz and 30MHz was 9 kHz;
4. L1 = Line One (Live Line) / L2 = Line Two (Neutral Line)



**Test Plots**

**Conducted emissions (Line 1)**

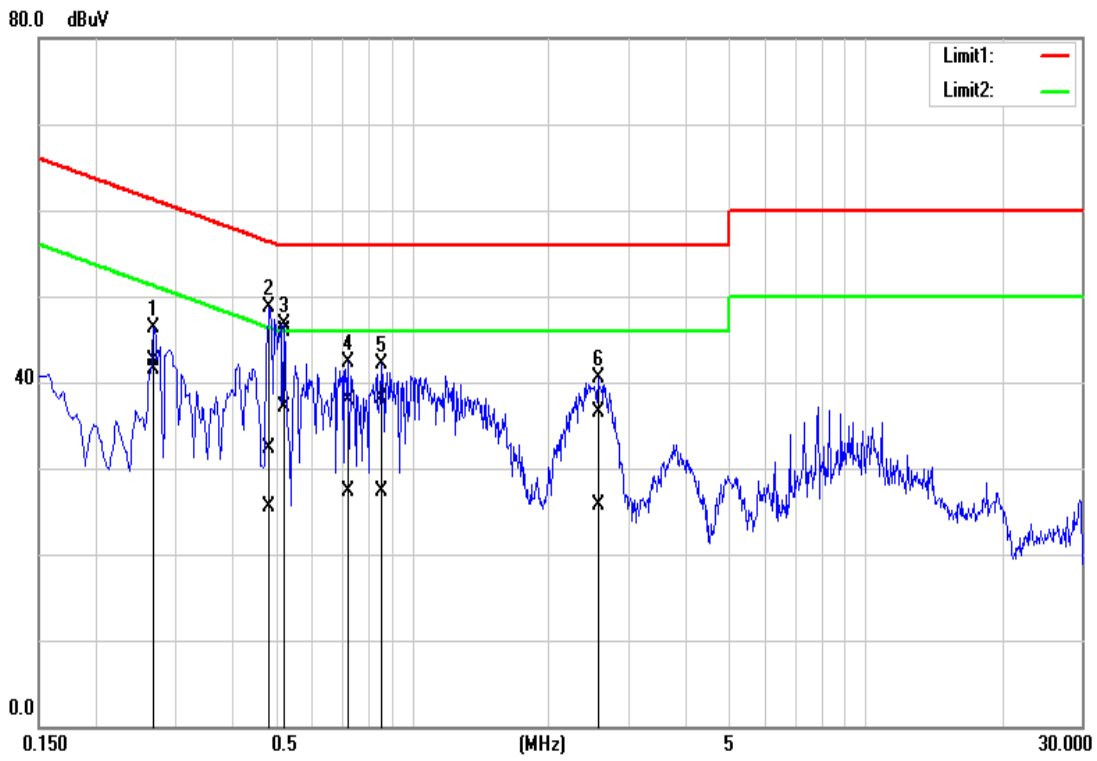

**Conducted emissions (Line 2)**

