

# TEST REPORT

of

## FCC Part 15 Subpart C

New Application;  Class I PC;  Class II PC

**Product :** Dashcam  
**Brand:** Transcend  
**Model:** DrivePro 230, DrivePro 250  
**Model Difference:** The angle of view of the lens is different  
**FCC ID:** A4Z-A00E6  
**FCC Rule Part:** §15.247, Cat: DTS  
**Applicant:** Transcend Information Inc.  
**Address:** No.70, Xing Zhong Rd., NeiHu Dist., Taipei, Taiwan

**Test Performed by:**  
**International Standards Laboratory**

<Lung-Tan LAB>

\*Site Registration No.

BSMI: SL2-IN-E-0013; MRA TW1036; TAF: 0997; IC: IC4067B-3;

\*Address:

No. 120, Lane 180, Hsin Ho Rd.

Lung-Tan Dist., Tao Yuan City 325, Taiwan

\*Tel : 886-3-407-1718; Fax: 886-3-407-1738

Report No.: **ISL-16LR246FC-R1**

Issue Date : **2017/05/25**



Test results given in this report apply only to the specific sample(s) tested and are traceable to national or international standard through calibration of the equipment and evaluating measurement uncertainty herein.

This report MUST not be used to claim product endorsement by TAF, NEMKO or any agency of the Government.

This test report shall not be reproduced except in full, without the written approval of International Standards Laboratory.



## VERIFICATION OF COMPLIANCE

**Applicant:** Transcend Information Inc.  
**Product Description:** Dashcam  
**Brand Name:** Transcend  
**Model No.:** DrivePro 230, DrivePro 250  
**Model Difference:** The angle of view of the lens is different  
**FCC ID:** A4Z-A00E6  
**Date of test:** 2016/09/06 ~ 2017/05/24  
**Date of EUT Received:** 2016/09/06, 2017/05/19

### We hereby certify that:

All the tests in this report have been performed and recorded in accordance with the standards described above and performed by an independent electromagnetic compatibility consultant, International Standards Laboratory.

The test results contained in this report accurately represent the measurements of the characteristics and the energy generated by sample equipment under test at the time of the test. The sample equipment tested as described in this report is in compliance with the limits of above standards.

<b>Test By:</b>	 _____	<b>Date:</b>	2017/05/25 _____
	<i>Dion Chang / Engineer</i>		
<b>Prepared By:</b>	 _____	<b>Date:</b>	2017/05/25 _____
	<i>Eva Kao / Technical Supervisor</i>		
<b>Approved By:</b>	 _____	<b>Date:</b>	2017/05/25 _____
	<i>Vincent Su / Technical Manager</i>		

## Version

Version No.	Date	Description
00	2017/05/25	Initial creation of document

## Uncertainty of Measurement

Description Of Test	Uncertainty
Conducted Emission (AC power line)	2.586 dB
Field Strength of Spurious Radiation	<=30MHz: 2.96dB 30-1GHz: 4.22 dB 1-40 GHz: 4.08 dB
Conducted Power	2.412 GHz: 1.30 dB 5.805 GHz: 1.55 dB
Power Density	2.412 GHz:1.30 dB 5.805 GHz: 1.67 dB
Frequency	0.0032%
Time	0.01%
DC Voltage	1%

## Table of Contents

<b>1</b>	<b>GENERAL INFORMATION .....</b>	<b>7</b>
1.1	Related Submittal(s) / Grant (s) .....	8
1.2	Test Methodology .....	8
1.3	Test Facility .....	8
1.4	Special Accessories .....	8
1.5	Equipment Modifications.....	8
<b>2</b>	<b>SYSTEM TEST CONFIGURATION .....</b>	<b>9</b>
2.1	EUT Configuration .....	9
2.2	EUT Exercise .....	9
2.3	Test Procedure.....	9
2.4	Configuration of Tested System.....	10
<b>3</b>	<b>SUMMARY OF TEST RESULTS .....</b>	<b>12</b>
<b>4</b>	<b>DESCRIPTION OF TEST MODES .....</b>	<b>12</b>
<b>5</b>	<b>CONDUCTED EMISSION TEST.....</b>	<b>13</b>
5.1	Standard Applicable: .....	13
5.2	Measurement Equipment Used: .....	13
5.3	EUT Setup:.....	13
5.4	Measurement Procedure: .....	14
5.5	Measurement Result: .....	14
<b>6</b>	<b>PEAK OUTPUT POWER MEASUREMENT.....</b>	<b>17</b>
6.1	Standard Applicable: .....	17
6.2	Measurement Equipment Used: .....	18
6.3	Test Set-up: .....	18
6.4	Measurement Procedure: .....	18
6.5	Measurement Result: .....	19
<b>7</b>	<b>6dB Bandwidth.....</b>	<b>20</b>
7.1	Standard Applicable: .....	20
7.2	Measurement Equipment Used: .....	20
7.3	Test Set-up: .....	20
7.4	Measurement Procedure: .....	20
7.5	Measurement Result: .....	21
<b>8</b>	<b>100KHz BANDWIDTH OF BAND EDGES MEASUREMENT.....</b>	<b>28</b>
8.1	Standard Applicable: .....	28
8.2	Measurement Equipment Used: .....	28
8.3	Test SET-UP:.....	30
8.4	Measurement Procedure: .....	31
8.5	Field Strength Calculation: .....	31
8.6	Measurement Result: .....	31
<b>9</b>	<b>SPURIOUS RADIATED EMISSION TEST.....</b>	<b>36</b>
9.1	Standard Applicable .....	36
9.2	Measurement Equipment Used: .....	36
9.3	Test SET-UP:.....	36
9.4	Measurement Procedure: .....	36
9.5	Field Strength Calculation .....	37
9.6	Measurement Result: .....	37

<b>10</b>	<b>Peak Power Spectral Density .....</b>	<b>44</b>
10.1	Standard Applicable: .....	44
10.2	Measurement Equipment Used: .....	44
10.3	Test Set-up: .....	44
10.4	Measurement Procedure: .....	44
10.5	Measurement Result: .....	45
<b>11</b>	<b>ANTENNA REQUIREMENT .....</b>	<b>52</b>
11.1	Standard Applicable: .....	52
11.2	Antenna Connected Construction: .....	52

## 1 GENERAL INFORMATION

General:

Product Name:	Dashcam	
Brand Name:	Transcend	
Model Name:	DrivePro 230, DrivePro 250	
Model Difference:	The angle of view of the lens is different	
Micro USB port	One provided	
Micro SD Slot	One provided	
Power Supply	5Vdc from USB or 3.7 Vdc from rechargeable battery	
	Car charger	Common ID CLA 5V1A INPUT:DC10-30V, 1A(Max) OUTPUT:DC4.6-5.25V,1A
	Li-on battery	552535 DC3.7V, 1.59Wh

WLAN: 1TX/1RX

Frequency Range:	802.11b/g/n HT20: 2412 – 2462MHz 802.11n HT40: 2422 – 2452MHz
Channel number:	802.11b/g/n HT20: 11 channels 802.11n HT40: 7 channels
Transmit Power:	802.11b: 15.42dBm Peak 802.11g: 24.46dBm Peak 802.11n HT20: 23.55dBm Peak 802.11n HT40: 24.18dBm Peak
Modulation Technology	11b: DSSS 11g/n: OFDM
Power Tolerance	+/- 1 dB
Modulation type:	CCK, DQPSK, DBPSK for DSSS 256QAM.64QAM. 16QAM, QPSK, BPSK for OFDM
Antenna Designation:	Fixed Chip antenna -3.86 dBi

The EUT is compliance with IEEE 802.11 b/g/n Standard.

### 1.1 Related Submittal(s) / Grant (s)

This submittal(s) (test report) is intended for **FCC ID: A4Z-A00E6** filing to comply with Section 15.247 of the FCC Part 15, Subpart C Rules.

### 1.2 Test Methodology

Both conducted and radiated testing were performed according to the procedures in, ANSI C63.10: 2013. Radiated testing was performed at an antenna to EUT distance 3 meters.

KDB Document: 558074 D01 DTS Meas Guidance v03r05

### 1.3 Test Facility

The measurement facilities used to collect the 3m Radiated Emission and AC power line conducted data are located on the address of **International Standards Laboratory** <Lung-Tan LAB> No. 120, Lane 180, Hsin Ho Rd., Lung-Tan Dist., Tao Yuan City 325, Taiwan which are constructed and calibrated to meet the FCC requirements in documents ANSI C63.10: 2013. FCC Registration Number is: 872200; Designation Number is: TW1036, Canada Registration Number: 4067B-3.

### 1.4 Special Accessories

Not available for this EUT intended for grant.

### 1.5 Equipment Modifications

Not available for this EUT intended for grant.



## 2 SYSTEM TEST CONFIGURATION

### 2.1 EUT Configuration

The EUT configuration for testing is installed on RF field strength measurement to meet the Commissions requirement and operating in a manner which intends to maximize its emission characteristics in a continuous normal application.

### 2.2 EUT Exercise

The EUT (Transmitter) was operated in the engineering mode to fix the Tx frequency that was for the purpose of the measurements.

### 2.3 Test Procedure

#### 2.3.1 Conducted Emissions

The EUT is a placed on as turn table which is 0.8 m above ground plane. According to the requirements in Section 6 of ANSI C63.10: 2013. Con-ducted emissions from the EUT measured in the frequency range between 0.15 MHz and 30MHz using CISPR 16-1-1 Quasi-Peak and Average detector mode.

#### 2.3.2 Radiated Emissions

The EUT is a placed on as turn table which is 0.8 m/1.5m (Frequency above 1GHz) above ground plane. The turn table shall rotate 360 degrees to determine the position of maxi-mum emission level. EUT is set 3m away from the receiving antenna which varied from 1m to 4m to find out the highest emission. And also, each emission was to be maximized by changing the polarization of receiving antenna both horizontal and vertical. In order to find out the max. emission, the relative positions of this hand-held transmitter(EUT) was rotated through three orthogonal axes according to the requirements in Section 6 and 11 of ANSI C63.10: 2013.

## 2.4 Configuration of Tested System

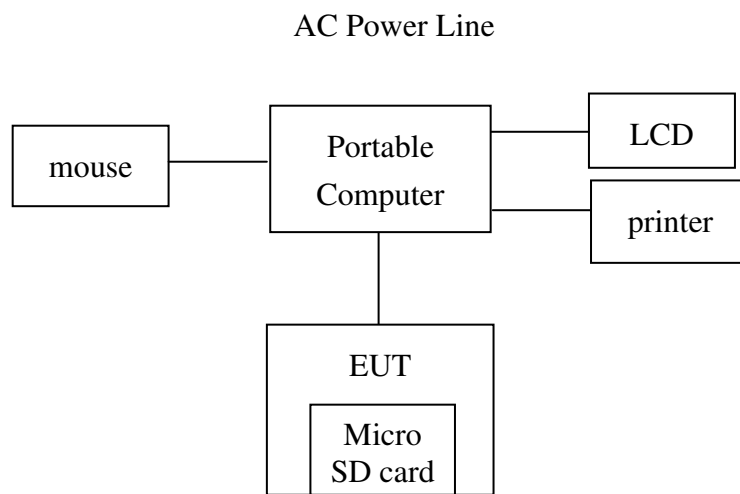
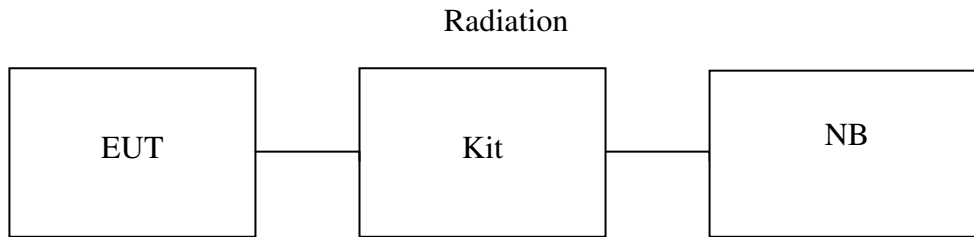

**Table 1 Equipment Used in Tested System**

Item	Equipment	Mfr/Brand	Model/ Type No.	Series No.	Data Cable	Power Cord
1	Kit	NA	NA	NA	NA	NA
2	Notebook	HP	440i	NA	Non-shielding	Non-shielding
3	24" LCD Monitor	DELL	P2416Db	N/A	Shielded /1.8M	Non-shielded /1.8M
4	Car Battery	YUASA	SMF 46B24R(S)	N/A	N/A	N/A
5	Portable Computer	DELL	P18S	6VWSKT1	N/A	Non-shielded /1.8M
6	USB mouse	DELL	MO56UC	G17009ZJ	Shielded /1.8M	N/A
7	Printer	HP	C930	N/A	Shielded /1.8M	Non-shielded /1.8M
8	Micro SD card	Transcend	TS16GUSDHC1 0V	N/A	N/A	N/A
9	VECTOR SIGNAL GENERA- TOR	R&S	SMU200A	N/A	N/A	Non-shielded /1.8M

### 3 SUMMARY OF TEST RESULTS

FCC Rules	Description Of Test	Result
§ 15.207(a)	AC Power Line Conducted Emission	Compliant
§ 15.247(b) (3),(4)	Peak Output Power/ EIRP	Compliant
§ 15.247(a)(2)	6dB & 99% Power Bandwidth	Compliant
§ 15.247(d)	100 KHz Bandwidth Of Frequency Band Edges	Compliant
§ 15.247(d)	Spurious Emission	Compliant
§ 15.247(e)	Peak Power Density	Compliant
§ 15.203	Antenna Requirement	Compliant

### 4 DESCRIPTION OF TEST MODES

The EUT has been tested under engineering operating condition.

Test program used to control the EUT for staying in continuous transmitting mode is programmed.

#### 2.4GHz:

802.11 b mode: Channel low (2412MHz) 、 mid (2437MHz) 、 high (2462MHz) with 1Mbps lowest data rate are chosen for peak output power, band edge, radiated spurious emission testing.

802.11 g mode: Channel low (2412MHz) 、 mid (2437MHz) 、 high (2462MHz) with 6Mbps lowest data rate are chosen for peak output power, band edge, radiated spurious emission testing.

802.11 n \_20MHz: Channel low (2412MHz) 、 mid (2437MHz) 、 high (2462MHz) with 6.5Mbps lowest data rate are chosen for peak output power, band edge, radiated spurious emission testing.

802.11 n \_40MHz: Channel low (2422MHz) 、 mid (2437MHz) 、 high (2452MHz) with 13.5Mbps lowest data rate are chosen for peak output power, band edge, radiated spurious emission testing.

The worst case 802.11g mode was reported for Radiated Emission.

## 5 CONDUCTED EMISSION TEST

### 5.1 Standard Applicable:

According to §15.207, frequency range within 150KHz to 30MHz shall not exceed the Limit table as below.

Frequency range MHz	Limits dB(uV)	
	Quasi-peak	Average
0.15 to 0.50	66 to 56	56 to 46
0.50 to 5	56	46
5 to 30	60	50

Note

- The lower limit shall apply at the transition frequencies
- The limit decreases linearly with the logarithm of the frequency in the range 0.15 MHz to 0.50 MHz.

### 5.2 Measurement Equipment Used:

Conducted Emission Test Site					
EQUIPMENT TYPE	MFR	MODEL NUMBER	SERIAL NUMBER	LAST CAL.	CAL DUE.
Conduction 04-3 Cable	WOKEN	CFD 300-NL	Conduction 04 -3	07/27/2016	07/26/2017
EMI Receiver 17	Rohde & Schwarz	ESCI 7	100887	09/08/2016	09/07/2017
LISN 18	ROHDE & SCHWARZ	ENV216	101424	02/11/2016	02/10/2017
LISN 19	ROHDE & SCHWARZ	ENV216	101425	03/12/2016	03/11/2017
Test Software	Farad	EZEMC Ver:ISL-03A2	N/A	N/A	N/A

### 5.3 EUT Setup:

- The conducted emission tests were performed in the test site, using the setup in accordance with the ANSI C63.10: 2013.
- The AC/DC Power adaptor of EUT was plug-in LISN. The EUT was placed flushed with the rear of the table.
- The LISN was connected with 120Vac/60Hz power source.

#### **5.4 Measurement Procedure:**

1. The EUT was placed on a table which is 0.8m above ground plane.
2. Maximum procedure was performed on the six highest emissions to ensure EUT compliance.
3. Repeat above procedures until all frequency measured were complete.

#### **5.5 Measurement Result:**

The initial step in collecting conducted data is a spectrum analyzer peak scan of the measurement range. Significant peaks are then marked as shown on the following data page, and these signals are then quasi-peaked.

Note: Refer to next page for measurement data and plots.

## AC POWER LINE CONDUCTED EMISSION TEST DATA

Operation Mode:	Normal Operation	Test Date:	2016/09/19
Test By:	Lake		



Address: No. 120, Lane 180, Hsin Ho Rd., Lung-Tan Dist.,  
Tao Yuan City 325, Taiwan.  
Tel: 03-4071718

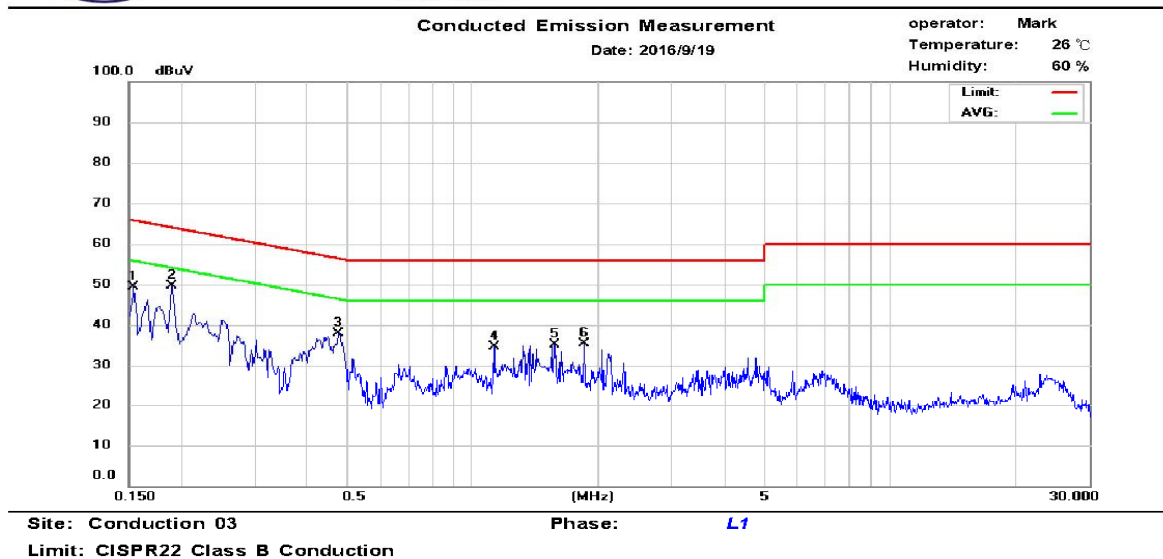

No.	Frequency (MHz)	QP_R (dBuV)	AVG_R (dBuV)	Correct Factor (dB)	QP Emission (dBuV)	QP Limit (dBuV)	QP Margin (dB)	AVG Emission (dBuV)	AVG Limit (dBuV)	AVG Margin (dB)
1	0.154	41.36	27.73	9.77	51.13	65.78	-14.65	37.50	55.78	-18.28
2	0.190	38.94	24.53	9.77	48.71	64.04	-15.33	34.30	54.04	-19.74
3	0.478	26.02	21.83	9.78	35.80	56.37	-20.57	31.61	46.37	-14.76
4	1.126	16.55	9.47	9.79	26.34	56.00	-29.66	19.26	46.00	-26.74
5	1.574	18.08	10.32	9.81	27.89	56.00	-28.11	20.13	46.00	-25.87
6	1.850	15.76	8.10	9.82	25.58	56.00	-30.42	17.92	46.00	-28.08



Address: No. 120, Lane 180, Hsin Ho Rd., Lung-Tan Dist.,  
Tao Yuan City 325, Taiwan.  
Tel: 03-4071718

Conducted Emission Measurement

operator: Mark  
Temperature: 26 °C  
Humidity: 60 %

Date: 2016/9/19

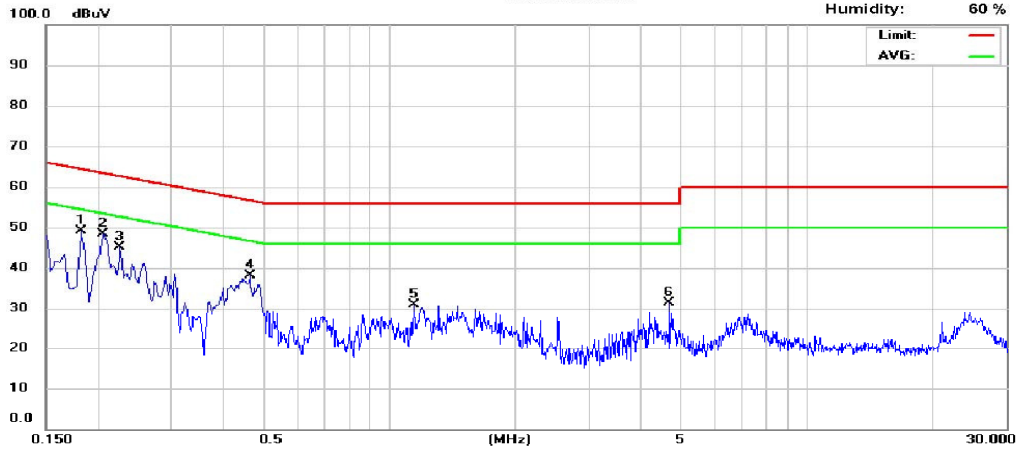

Site: Conduction 03

Phase: N

Limit: CISPR22 Class B Conduction

No.	Frequency (MHz)	QP_R (dBuV)	AVG_R (dBuV)	Correct Factor (dB)	QP Emission (dBuV)	QP Limit (dBuV)	QP Margin (dB)	AVG Emission (dBuV)	AVG Limit (dBuV)	AVG Margin (dB)
1	0.182	39.44	26.14	9.75	49.19	64.39	-15.20	35.89	54.39	-18.50
2	0.206	34.82	24.32	9.75	44.57	63.37	-18.80	34.07	53.37	-19.30
3	0.226	29.00	17.98	9.75	38.75	62.60	-23.85	27.73	52.60	-24.87
4	0.462	24.65	16.45	9.77	34.42	56.66	-22.24	26.22	46.66	-20.44
5	1.142	15.37	8.06	9.77	25.14	56.00	-30.86	17.83	46.00	-28.17
6	4.694	11.11	1.52	9.86	20.97	56.00	-35.03	11.38	46.00	-34.62



## 6 PEAK OUTPUT POWER/ERIP MEASUREMENT

### 6.1 Standard Applicable:

According to §15.247(b)(3),(4)(b)

(3) For systems using digital modulation in the 902-928 MHz, 2400-2483.5 MHz, and 5725-5850 MHz bands: 1 Watt. As an alternative to a peak power measurement, compliance with the one Watt limit can be based on a measurement of the maximum conducted output power. Maximum Conducted Output Power is defined as the total transmit power delivered to all antennas and antenna elements averaged across all symbols in the signaling alphabet when the transmitter is operating at its maximum power control level. Power must be summed across all antennas and antenna elements. The average must not include any time intervals during which the transmitter is off or is transmitting at a reduced power level. If multiple modes of operation are possible (e.g., alternative modulation methods), the maximum conducted output power is the highest total transmit power occurring in any mode.

(4) The conducted output power limit specified in paragraph (b) of this section is based on the use of antennas with directional gains that do not exceed 6 dBi. Except as shown in paragraph (c) of this section, if transmitting antennas of directional gain greater than 6 dBi are used, the conducted output power from the intentional radiator shall be reduced below the stated values in paragraphs (b)(1), (b)(2), and (b)(3) of this section, as appropriate, by the amount in dB that the directional gain of the antenna exceeds 6 dBi.

(c) Operation with directional antenna gains greater than 6 dBi.

(1) Fixed point-to-point operation:

(i) Systems operating in the 2400-2483.5 MHz band that are used exclusively for fixed, point-to-point operations may employ transmitting antennas with directional gain greater than 6 dBi provided the maximum conducted output power of the intentional radiator is reduced by 1 dB for every 3 dB that the directional gain of the antenna exceeds 6 dBi.

(ii) Systems operating in the 5725-5850 MHz band that are used exclusively for fixed, point-to-point operations may employ transmitting antennas with directional gain greater than 6 dBi without any corresponding reduction in transmitter conducted output power.

## 6.2 Measurement Equipment Used:

Conducted Emission Test Site					
EQUIPMENT TYPE	MFR	MODEL NUMBER	SERIAL NUMBER	LAST CAL.	CAL DUE.
Power Meter 05	Anritsu	ML2495A	1116010	07/28/2016	07/27/2017
Power Sensor 05	Anritsu	MA2411B	34NKF50	07/28/2016	07/27/2017
Power Sensor 06	DARE	RPR3006W	13I00030SNO3 3	11/03/2016	11/02/2017
Power Sensor 07	DARE	RPR3006W	13I00030SNO3 4	11/03/2016	11/02/2017
Temperature Chamber	KSON	THS-B4H100	2287	06/28/2016	06/27/2017
DC Power supply	ABM	8185D	N/A	10/06/2016	10/05/2017
AC Power supply	EXTECH	CFC105W	NA	12/25/2016	12/24/2017
Attenuator	Woken	Watt-65m3502	11051601	NA	NA
Splitter	MCLI	PS4-199	12465	12/26/2015	12/25/2017
Spectrum analyzer	keysight	N9010A	MY56070257	05/31/2017	05/30/2018
Spectrum analyzer	R&S	FSP40	100143	08/07/2016	08/06/2017
Test Software	DARE	Radimation Ver:2013.1.23	NA	NA	NA

## 6.3 Test Set-up:

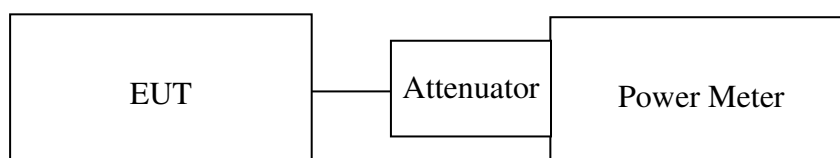

## 6.4 Measurement Procedure:

1. Place the EUT on the table and set it in transmitting mode.
2. Remove the antenna from the EUT and then connect a low loss RF cable from the antenna port to the power meter
3. Record the max. reading.
4. Repeat above procedures until all frequency measured were complete.

**6.5 Measurement Result:**

802.11b

Cable loss = 0	Output Power		Limit (dBm)
CH	Detector		
	PK (dBm)	AV (dBm)	
Low	14.33	11.89	30
Mid	15.21	12.25	
High	15.42	12.68	

802.11g

Cable loss = 0	Output Power		Limit (dBm)
CH	Detector		
	PK (dBm)	AV (dBm)	
Low	23.86	14.35	30
Mid	24,35	15.12	
High	24.46	15.52	

802.11N HT20

Cable loss = 0	Output Power		Limit (dBm)
CH	Detector		
	PK (dBm)	AV (dBm)	
Low	22.79	13.43	30
Mid	23.32	14.45	
High	23.55	14.37	

802.11N HT40

Cable loss = 0	Output Power		Limit (dBm)
CH	Detector		
	PK (dBm)	AV (dBm)	
Low	23.53	12.65	30
Mid	23.72	13.54	
High	24.18	14.61	

## **7 6dB Bandwidth**

### **7.1 Standard Applicable:**

According to §15.247(a)(2), Systems using digital modulation techniques may operate in the 902 - 928 MHz, 2400 - 2483.5 MHz, and 5725 - 5850 MHz bands. The minimum 6 dB bandwidth shall be at least 500kHz.

### **7.2 Measurement Equipment Used:**

Refer to section 6.2 for details.

### **7.3 Test Set-up:**

Refer to section 6.3 for details.

### **7.4 Measurement Procedure:**

1. Place the EUT on the table and set it in transmitting mode.
2. Remove the antenna from the EUT and then connect a low loss RF cable from the antenna port to the spectrum analyzer.
3. Set the spectrum analyzer as RBW=100KHz, VBW = 3\*RBW, Span= cover the complete power envelope of the signal of the UUT Sweep=auto
4. Mark the peak frequency and -6dB (upper and lower) frequency.
5. Repeat above procedures until all frequency measured were complete.

## 7.5 Measurement Result:

802.11b

CH	Bandwidth (MHz)	Bandwidth (KHz)	Result
Low	10.08	> 500	PASS
Mid	10.2	> 500	PASS
High	10.2	> 500	PASS

802.11g

CH	Bandwidth (MHz)	Bandwidth (KHz)	Result
Low	16.62	> 500	PASS
Mid	16.62	> 500	PASS
High	16.62	> 500	PASS

802.11n HT20

CH	Bandwidth (MHz)	Bandwidth (KHz)	Result
Low	17.88	> 500	PASS
Mid	17.82	> 500	PASS
High	17.76	> 500	PASS

802.11n HT40

CH	Bandwidth (MHz)	Bandwidth (KHz)	Result
Low	36.4	> 500	PASS
Mid	36.3	> 500	PASS
High	36.4	> 500	PASS

802.11b

6dB Band Width Test Data CH-Low

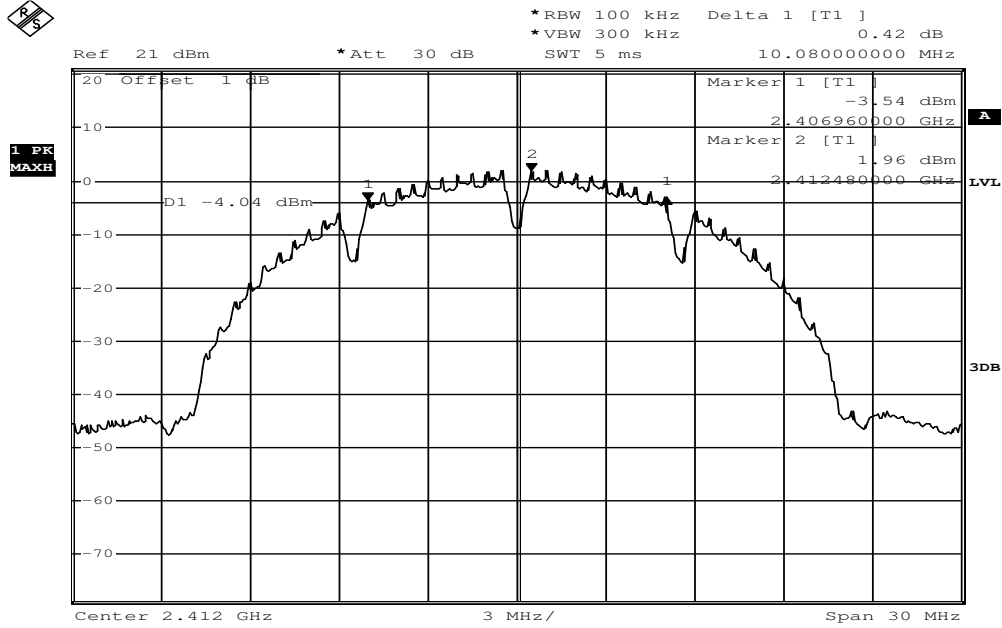

Date: 26.AUG.2016 10:58:17

6dB Band Width Test Data CH-Mid

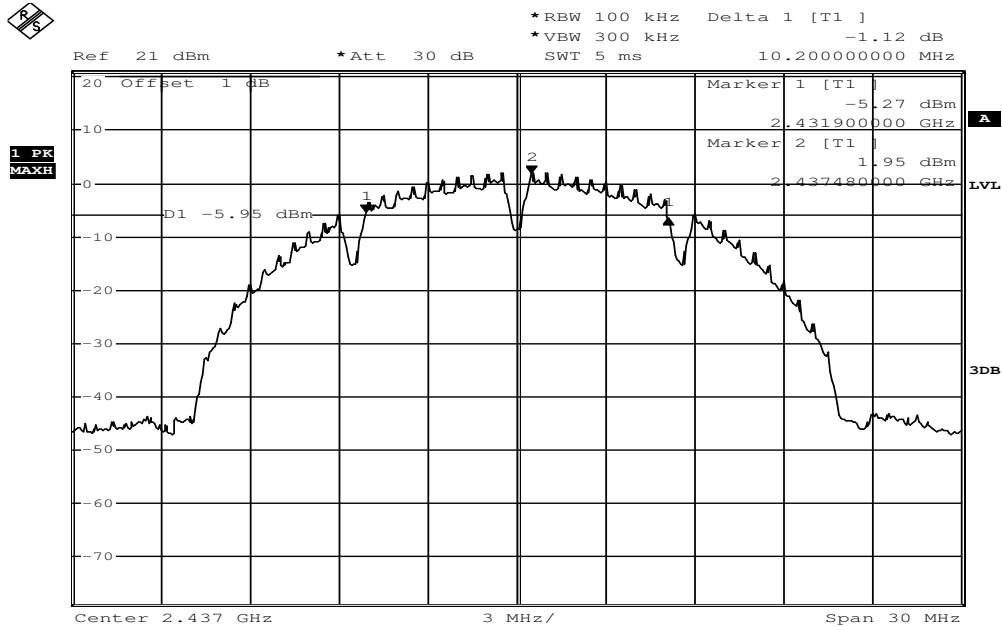

Date: 26.AUG.2016 11:11:07

### 6dB Band Width Test Data CH-High

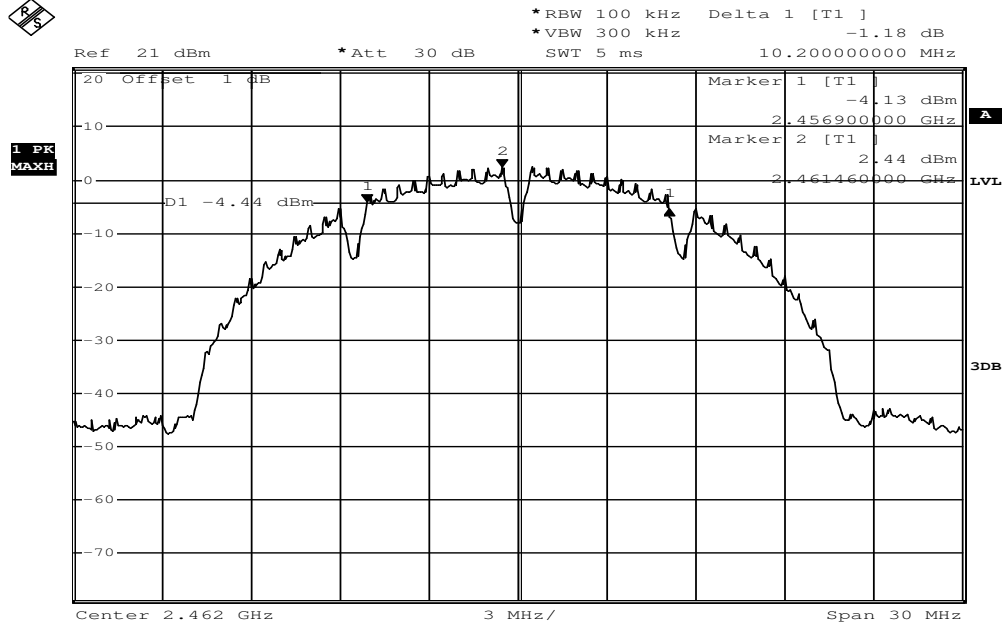

Date: 26.AUG.2016 11:14:48

### 802.11g

### 6dB Band Width Test Data CH-Low

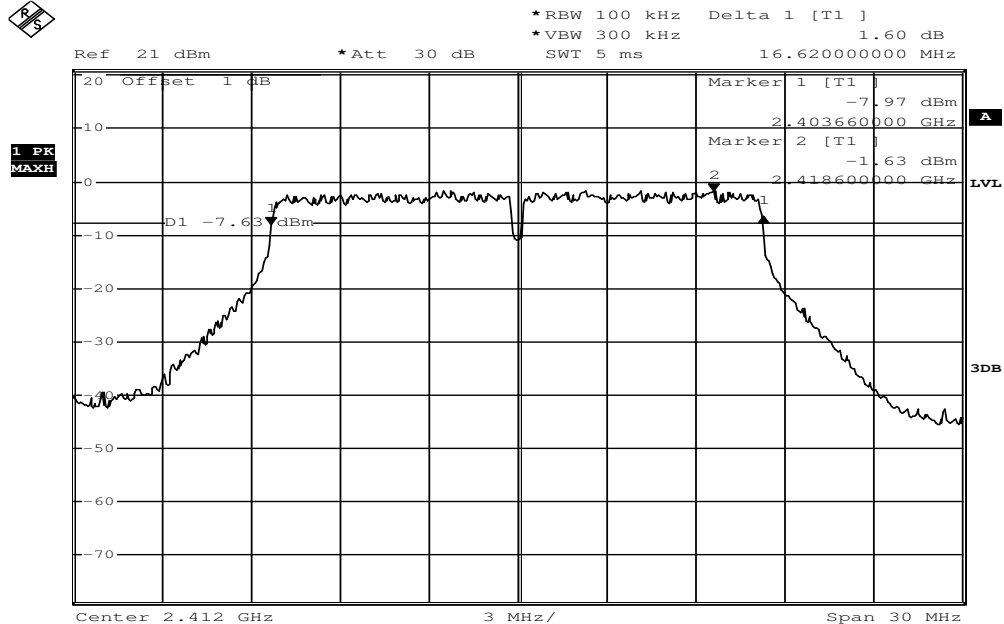

Date: 26.AUG.2016 11:19:36

### 6dB Band Width Test Data CH-Mid

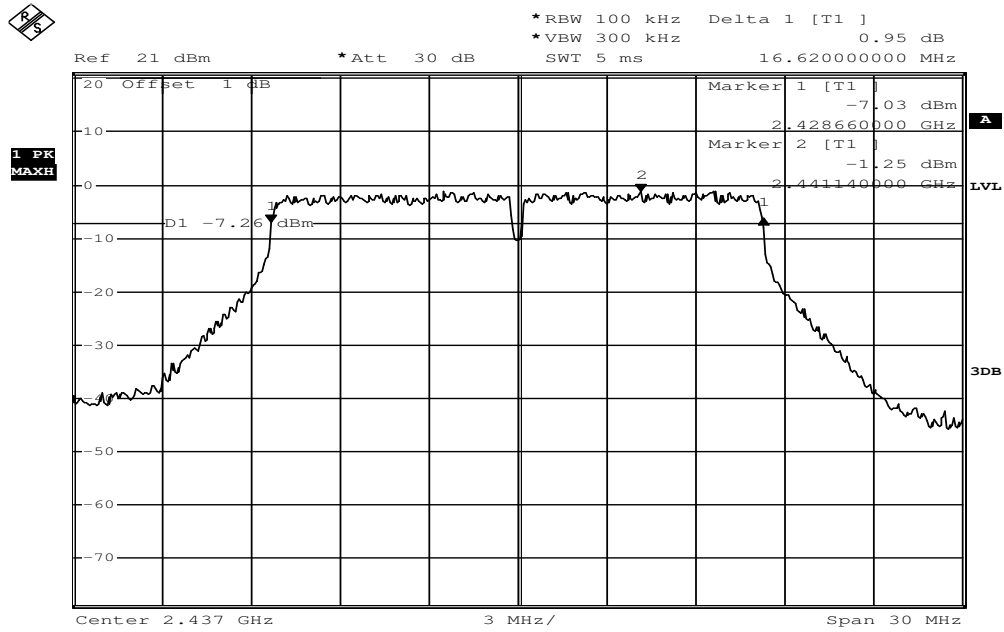

Date: 26.AUG.2016 11:22:16

### 6dB Band Width Test Data CH-High

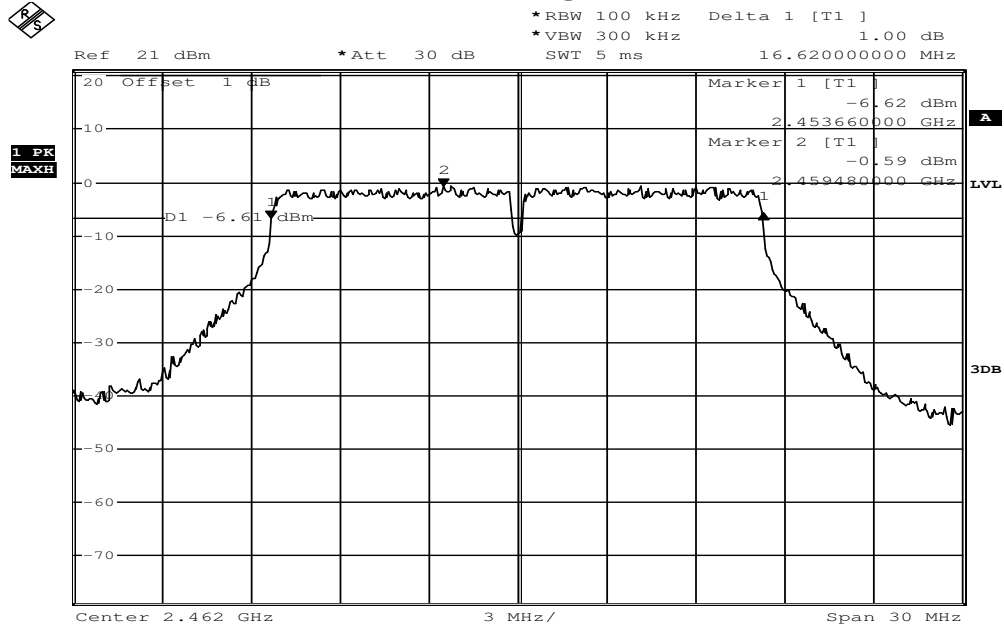

Date: 26.AUG.2016 11:24:27



### 802.11n\_20M

### 6dB Band Width Test Data CH-Low

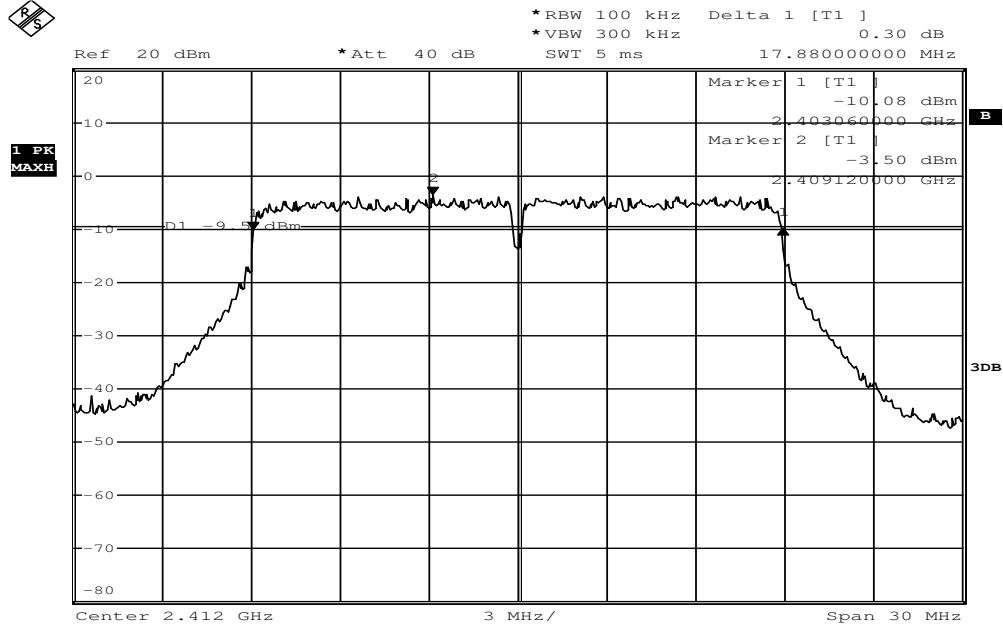

Date: 26.AUG.2016 11:37:16

### 6dB Band Width Test Data CH-Mid

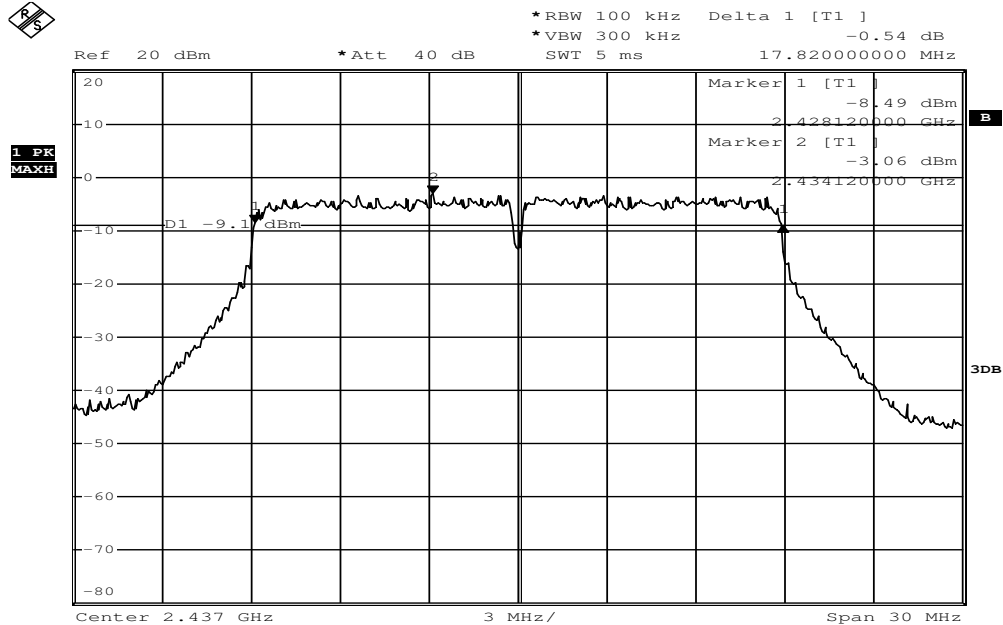

Date: 26.AUG.2016 11:45:28

### 6dB Band Width Test Data CH-High

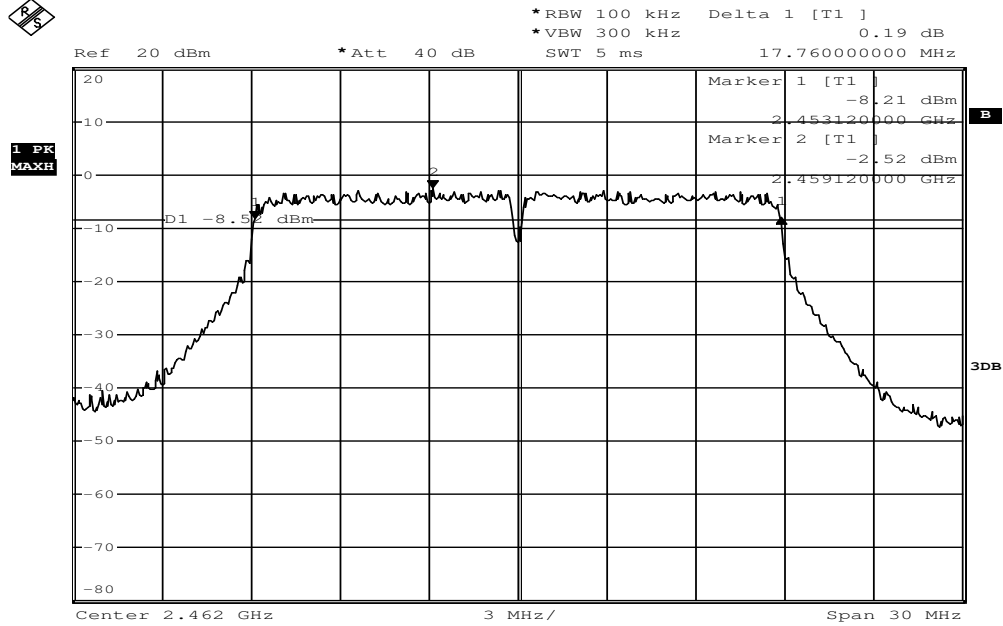

Date: 26.AUG.2016 12:13:17

### 802.11n\_40M

### 6dB Band Width Test Data CH-Low

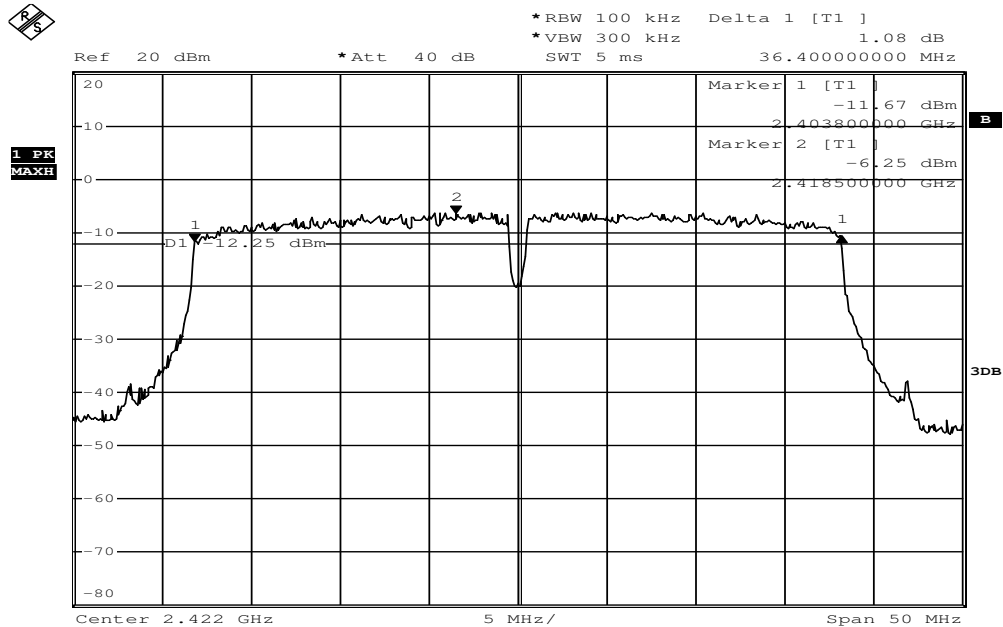

Date: 26.AUG.2016 14:13:02

### 6dB Band Width Test Data CH-Mid

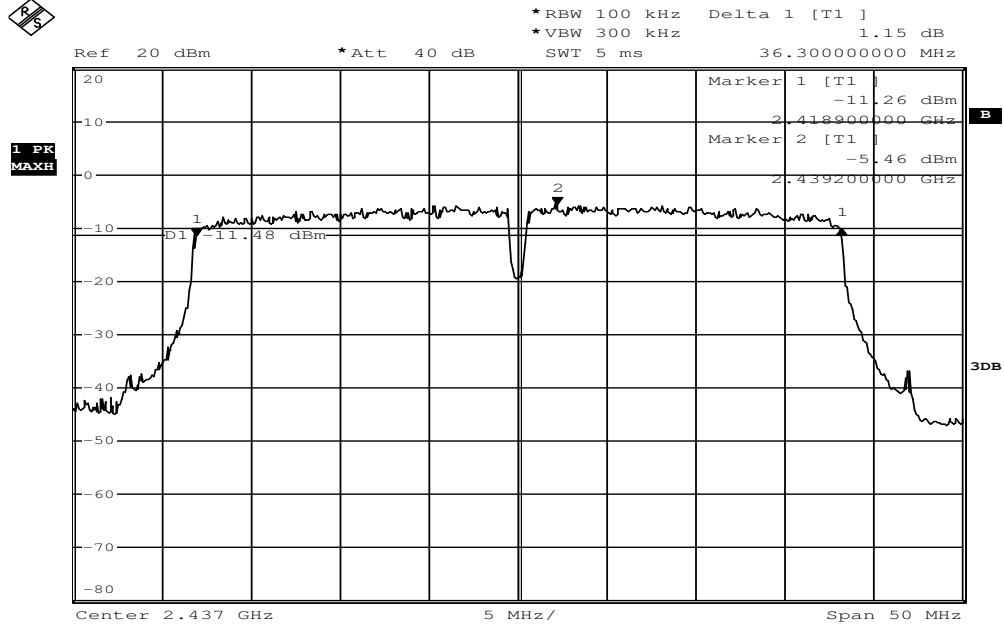

Date: 26.AUG.2016 14:05:08

### 6dB Band Width Test Data CH-High

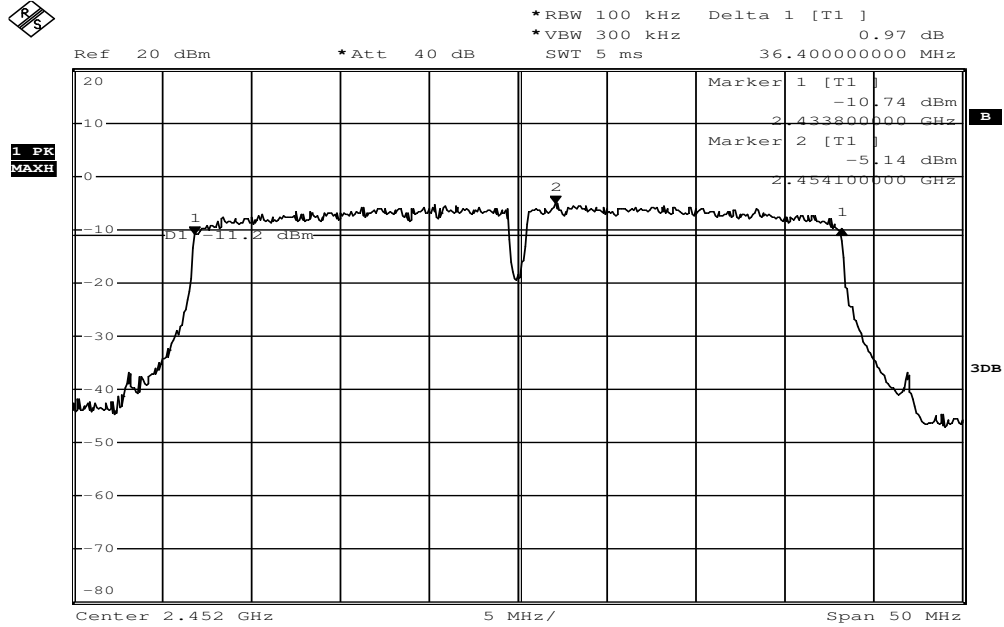

Date: 26.AUG.2016 14:03:22

## **8 100KHz BANDWIDTH OF BAND EDGES MEASUREMENT**

### **8.1 Standard Applicable:**

According to §15.247(c), in any 100 KHz bandwidth outside the frequency bands in which the spread spectrum intentional radiator is operating, the radio frequency power that is produced by the intentional radiator shall be at least 20dB below that in the 100KHz bandwidth within the band that contains the highest level of the desired power, In addition, radiated emissions which fall in the restricted bands, as defined in §15.205(a), must also comply with the radiated emission limits specified in 15.209(a).

### **8.2 Measurement Equipment Used:**

#### **8.2.1 Conducted Emission at antenna port:**

Refer to section 6.2 for details.

**8.2.2 Radiated emission:**

<b>Chamber 19( 966 Chamber)</b>					
<b>EQUIPMENT TYPE</b>	<b>MFR</b>	<b>MODEL NUMBER</b>	<b>SERIAL NUMBER</b>	<b>LAST CAL.</b>	<b>CAL DUE.</b>
966 Chamber	Chance Most	Chamber 19	N/A	08/15/2016	08/14/2017
Spectrum Analyzer 21(3Hz-44GHz)	Agilent	N9030A	MY5136002 1	11/14/2016	11/13/2017
EMI Receiver	SCHWARZBECK	FCVU1534	1534149	11/30/2016	11/29/2017
Loop Antenna(9K-30M)	EM	EM-6879	271	11/01/2016	10/31/2018
Loop Antenna (9K-30M)	A.H.SYSTEM	SAS-564	294	06/17/2015	06/16/2017
Bilog Antenna (30M-1G)	SCHWARZBECK	VULB9168 w 5dB Att	736	07/22/2016	07/21/2017
Horn antenna (1G-18G)	SCHWARZBECK	9120D	9120D-162 7	07/22/2016	07/21/2017
Horn antenna (18G-26G)	Com-power	AH-826	081001	07/24/2015	07/23/2017
Horn antenna (26G-40G)	Com-power	AH-640	100A	02/22/2017	02/21/2019
Preamplifier (9k-1000M)	HP	8447F	3113A06362	11/13/2016	11/12/2017
Preamplifier(1G-26G)	Agilent	8449B	3008A02471	08/25/2016	08/24/2017
Preamplifier (26G-40G)	MITEQ	JS4-26004000-27- 5A	818471	07/23/2015	07/22/2017
RF Cable (9k-18G)	HUBER SUHNER	SUCOFLEX 104A	MY1397/4A	08/25/2016	08/24/2017
RF cable (18G~40G)	HUBER SUHNER	Sucoflex 102	27963/2&374 21/2	11/03/2015	11/02/2017
Turn Table	MF	Turn Table-19	Turn Ta- ble-19	N/A	N/A
Mast Tower	MF	JSDES-15A	1308283	N/A	N/A
Controller	MF	MF-7802BS	MF7802084 60	N/A	N/A
AC power source	T-Power	TFC-1005	40006471	N/A	N/A
Signal Generator	R&S	SMU200A	102330	03/15/2017	03/14/2018
Signal Generator	Anritsu	MG3692A	20311	11/04/2016	11/03/2017
2.4G Filter	Micro-Tronics	Brm50702	76	12/25/2016	12/24/2017
Test Software	Audix	E3 Ver:6.12023	N/A	N/A	N/A

### 8.3 Test SET-UP:

The test item only performed radiated mode

(A) Radiated Emission Test Set-Up, Frequency Below 1000MHz

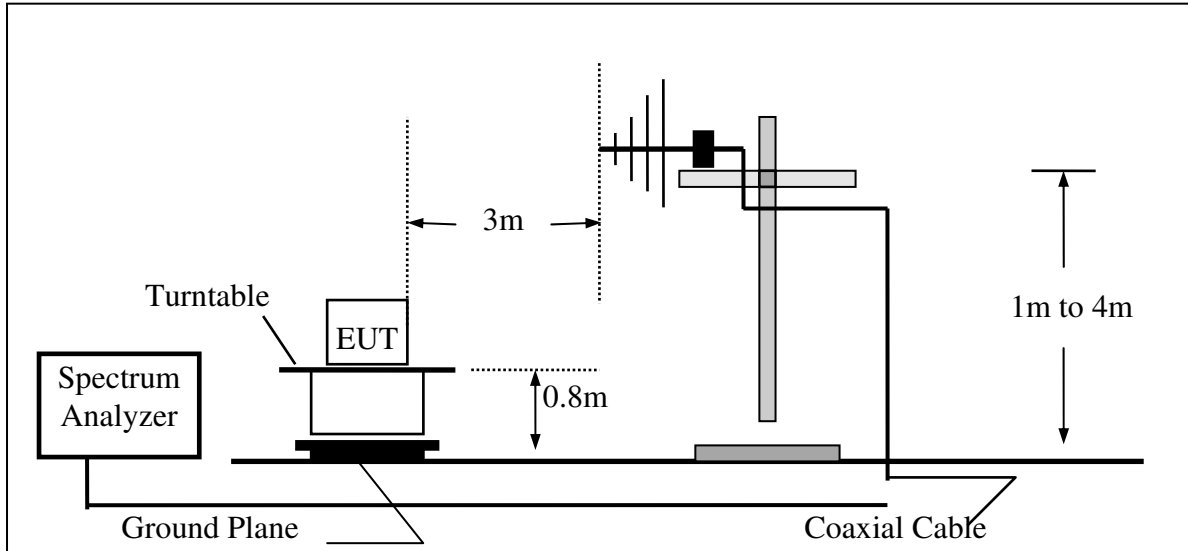

(B) Radiated Emission Test Set-UP Frequency Over 1 GHz

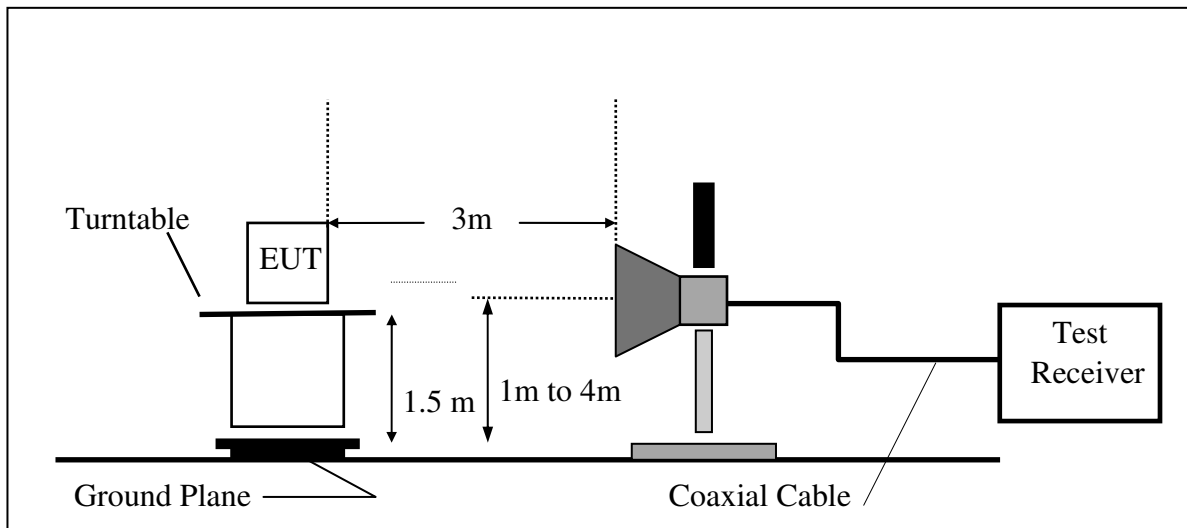

#### 8.4 Measurement Procedure:

1. Place the EUT on the table and set it in transmitting mode.
2. Remove the antenna from the EUT and then connect a low loss RF cable from the antenna port to the spectrum analyzer.
3. Set center frequency of spectrum analyzer = operating frequency.
4. Set the spectrum analyzer as RBW, VBW=100KHz, Span=25MHz, Sweep = auto
5. Mark Peak, 2.390GHz and 2.4835GHz and record the max. level.
6. Repeat above procedures until all frequency measured were complete.

#### 8.5 Field Strength Calculation:

The field strength is calculated by adding the Antenna Factor and Cable Factor and subtracting the Amplifier Gain and Duty Cycle Correction Factor(if any) from the measured reading. The basic equation with a sample calculation is as follows:

$$FS = RA + AF + CL - AG$$

Where	FS = Field Strength	CL = Cable Attenuation Factor (Cable Loss)
	RA = Reading Amplitude	AG = Amplifier Gain
	AF = Antenna Factor	

#### 8.6 Measurement Result:

Note: Refer to next page spectrum analyzer data chart and tabular data sheets.

**Radiated Emission: 802.11 g mode (worst case)**

Operation Mode TX CH Low  
Channel Number 2412 MHz  
Temperature 25 °C

Test Date 2017/05/24  
Test By Lake  
Humidity 60 %

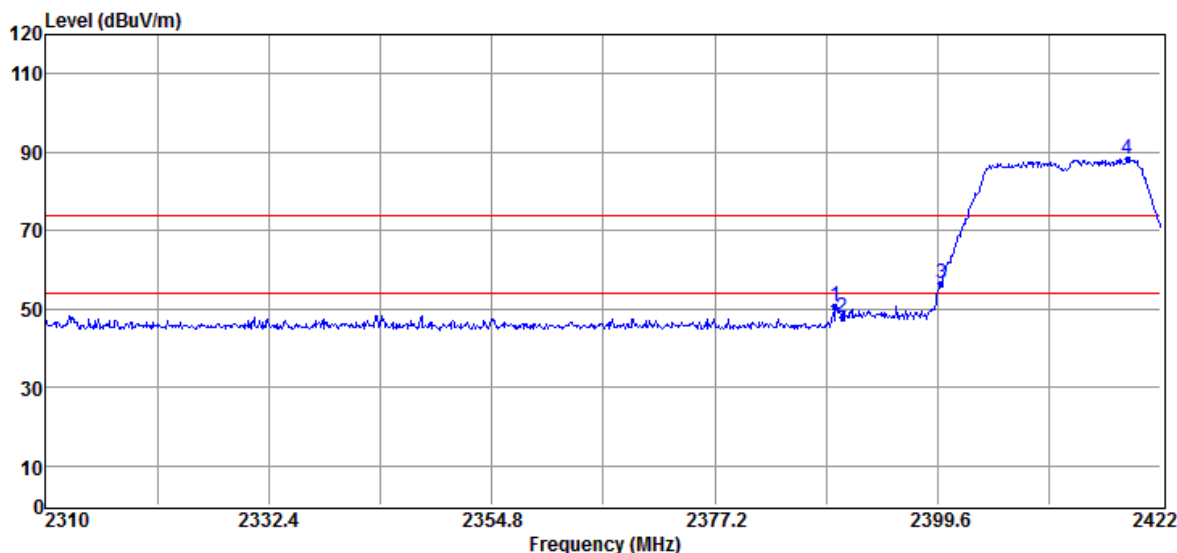

No	Freq MHz	Reading dBUV	Factor dB/m	Level dBUV/m	Limit dBUV/m	Over Li mit dB	Remark	Pol V/H
1	2389.30	53.79	-3.15	50.64	74.00	-23.36	Peak	VERTICAL
2	2390.00	50.92	-3.15	47.77	74.00	-26.23	Peak	VERTICAL
3	2400.00	59.82	-3.16	56.66	68.16	-11.50	Peak	VERTICAL
4	2418.64	91.31	-3.15	88.16	F	---	Peak	VERTICAL

Remark:

- 1 Measuring frequencies from the lowest internal frequency to the 10th of fundamental frequency
- 2 Field strength limits for frequency above 1000MHz are based on average limits. However, Peak mode field strength shall not exceed the average limits specified plus 20dB.
- 3 Measurement of data within this frequency range shown “ - ” in the table above means the reading of emissions are attenuated more than 20dB below the permissible limits or the field strength is too small to be measured.
- 4 Spectrum Peak mode IF bandwidth Setting : 1GHz- 26GHz, RBW= 1MHz, Sweep time= 200 ms., the VBW setting was 3 MHz.
- 5 Spectrum AV mode if bandwidth Setting : 1GHz- 26GHz, RBW= 1MHz, VBW= 10Hz, Sweep time= 200 ms.

Note: “F” denotes fundamental frequency



Operation Mode TX CH Low  
Channel Number 2412 MHz  
Temperature 25 °C

Test Date 2017/05/24  
Test By Lake  
Humidity 60 %

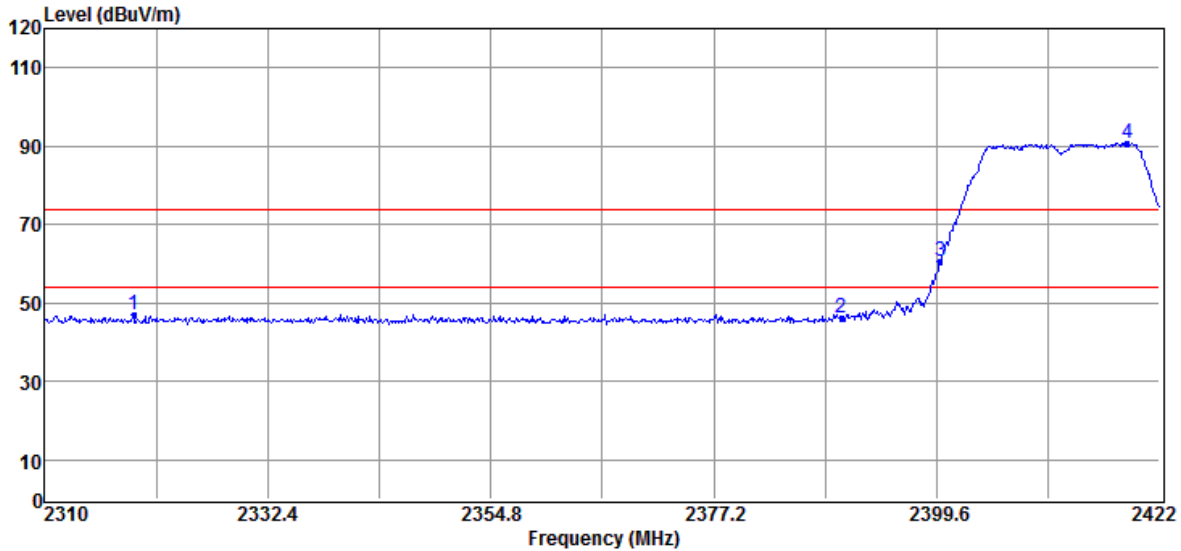

No	Freq MHz	Reading dBuV	Factor dB/m	Level dBuV/m	Limit dBuV/m	Over L imit dB	Remark	Pol V/H
1	2318.96	50.24	-3.10	47.14	74.00	-26.86	Peak	HORIZONTAL
2	2390.00	49.38	-3.15	46.23	74.00	-27.77	Peak	HORIZONTAL
3	2400.00	63.70	-3.16	60.54	70.78	-10.24	Peak	HORIZONTAL
4	2418.75	93.93	-3.15	90.78	F	---	Peak	HORIZONTAL

Remark:

- 1 Measuring frequencies from the lowest internal frequency to the 10th of fundamental frequency
- 2 Field strength limits for frequency above 1000MHz are based on average limits. However, Peak mode field strength shall not exceed the average limits specified plus 20dB.
- 3 Measurement of data within this frequency range shown “ - ” in the table above means the reading of emissions are attenuated more than 20dB below the permissible limits or the field strength is too small to be measured.
- 4 Spectrum Peak mode IF bandwidth Setting : 1GHz- 26GHz, RBW= 1MHz, Sweep time= 200 ms., the VBW setting was 3 MHz.
- 5 Spectrum AV mode if bandwidth Setting : 1GHz- 26GHz, RBW= 1MHz, VBW= 10Hz, Sweep time= 200 ms.

Note: “F” denotes fundamental frequency

Operation Mode TX CH High  
Channel Number 2462 MHz  
Temperature 25 °C

Test Date 2017/05/24  
Test By Lake  
Humidity 60 %

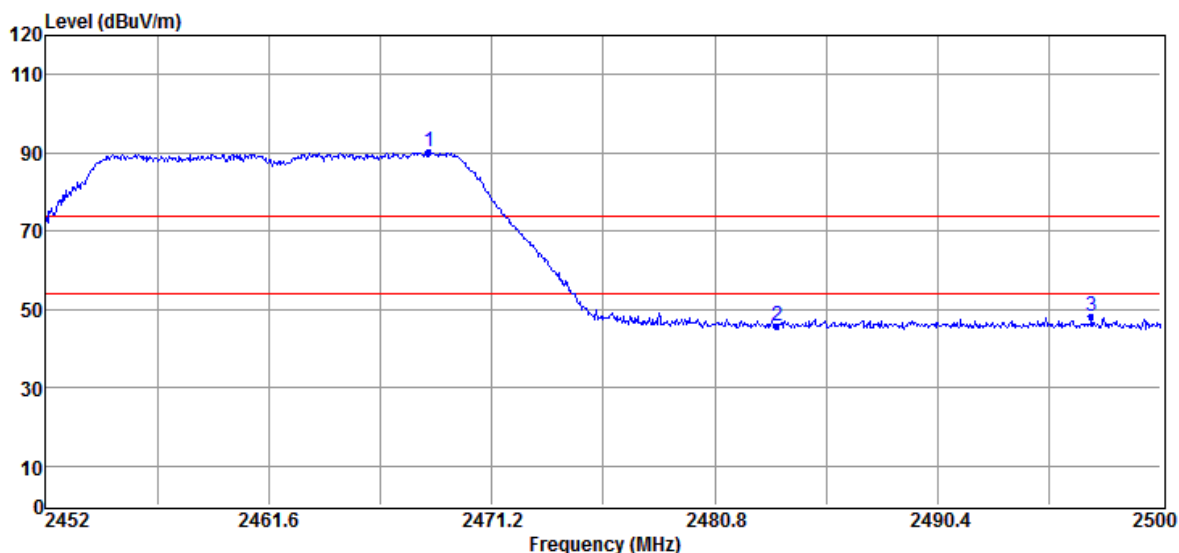

No	Freq MHz	Reading dBuV	Factor dB/m	Level dBuV/m	Limit dBuV/m	Over Li mit dB	Remark	Pol V/H
1	2468.51	93.28	-3.12	90.16	F	---	Peak	VERTICAL
2	2483.50	48.80	-3.11	45.69	74.00	-28.31	Peak	VERTICAL
3	2497.02	51.16	-3.10	48.06	74.00	-25.94	Peak	VERTICAL

Remark:

- 1 Measuring frequencies from the lowest internal frequency to the 10th of fundamental frequency
- 2 Field strength limits for frequency above 1000MHz are based on average limits. However, Peak mode field strength shall not exceed the average limits specified plus 20dB.
- 3 Measurement of data within this frequency range shown “ - ” in the table above means the reading of emissions are attenuated more than 20dB below the permissible limits or the field strength is too small to be measured.
- 4 Spectrum Peak mode IF bandwidth Setting : 1GHz- 26GHz, RBW= 1MHz, Sweep time= 200 ms., the VBW setting was 3 MHz.
- 5 Spectrum AV mode if bandwidth Setting : 1GHz- 26GHz, RBW= 1MHz, VBW= 10Hz, Sweep time= 200 ms.

Note: “F” denotes fundamental frequency

Operation Mode TX CH High  
Channel Number 2462 MHz  
Temperature 25 °C

Test Date 2017/05/24  
Test By Lake  
Humidity 60 %

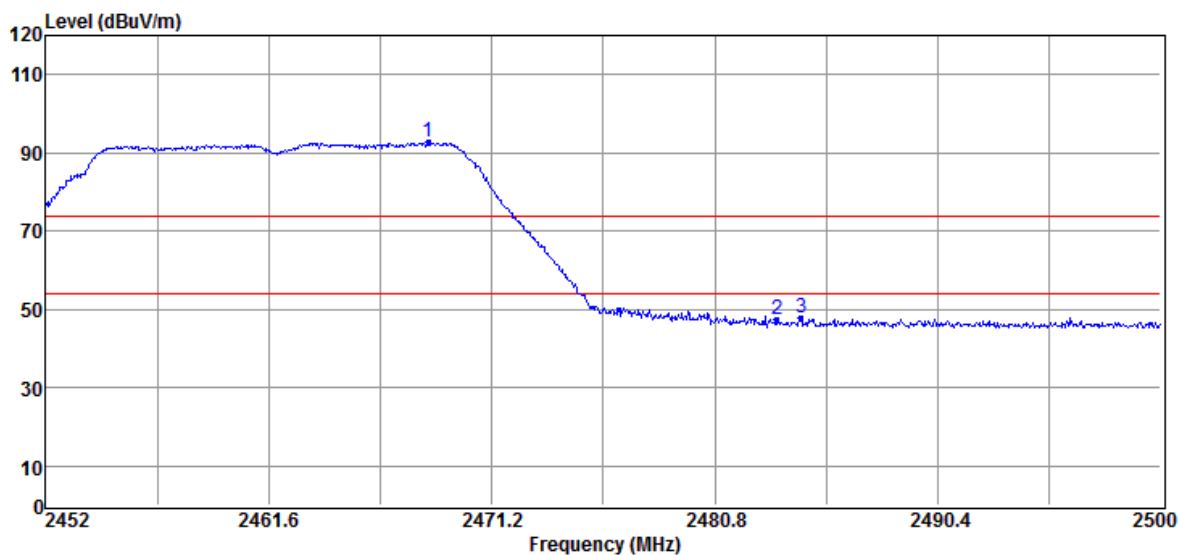

No	Freq MHz	Reading dBuV	Factor dB/m	Level dBuV/m	Limit dBuV/m	Over L imit dB	Remark	Pol V/H
1	2468.46	95.70	-3.12	92.58	F	---	Peak	HORIZONTAL
2	2483.50	50.60	-3.11	47.49	74.00	-26.51	Peak	HORIZONTAL
3	2484.54	50.78	-3.11	47.67	74.00	-26.33	Peak	HORIZONTAL

Remark:

- 1 Measuring frequencies from the lowest internal frequency to the 10th of fundamental frequency
- 2 Field strength limits for frequency above 1000MHz are based on average limits. However, Peak mode field strength shall not exceed the average limits specified plus 20dB.
- 3 Measurement of data within this frequency range shown “ - ” in the table above means the reading of emissions are attenuated more than 20dB below the permissible limits or the field strength is too small to be measured.
- 4 Spectrum Peak mode IF bandwidth Setting : 1GHz- 26GHz, RBW= 1MHz, Sweep time= 200 ms., the VBW setting was 3 MHz.
- 5 Spectrum AV mode if bandwidth Setting : 1GHz- 26GHz, RBW= 1MHz, VBW= 10Hz, Sweep time= 200 ms.

Note: “F” denotes fundamental frequency

## 9 SPURIOUS RADIATED EMISSION TEST

### 9.1 Standard Applicable

According to §15.247(c), all other emissions outside these bands shall not exceed the general radiated emission limits specified in §15.209(a). And according to §15.33(a)(1), for an intentional radiator operates below 10GHz, the frequency range of measurements: to the tenth harmonic of the highest fundamental frequency or to 40GHz, whichever is lower.

### 9.2 Measurement Equipment Used:

Refer to section 7.2 for details.

### 9.3 Test SET-UP:

Refer to section 7.3 for details.

### 9.4 Measurement Procedure:

- 1 According 414788 section 2, Either OATS or chamber for radiated emission below 30MHz, the test was done at 966 chamber, the test site was evaluated with OATS and the Chamber has test signals level greater than OATS's .
- 2 The EUT was placed on a turn table which is 0.8m/1.5m above ground plane in 966 chamber.
- 3 The turn table shall rotate 360 degrees to determine the position of maximum emission level.
- 4 EUT is set 3m away from the receiving antenna which varied from 1m to 4m to find out the highest emissions.
- 5 When measurement procedures for electric field radiated emissions above 1 GHz the EUT measurement is to be made “while keeping the antenna in the ‘cone of radiation’ from that area and pointed at the area both in azimuth and elevation, with polarization oriented for maximum response.” is still within the 3dB illumination BW of the measurement antenna.
- 6 Maximum procedure was performed on the six highest emissions to ensure EUT compliance.
- 7 And also, each emission was to be maximized by changing the polarization of receiving antenna both horizontal and vertical.
- 8 Repeat above procedures until all frequency measured were complete.

## 9.5 Field Strength Calculation

The field strength is calculated by adding the Antenna Factor and Cable Factor and subtracting the Amplifier Gain and Duty Cycle Correction Factor(if any) from the measured reading. The basic equation with a sample calculation is as follows:

$$FS = RA + AF + CL - AG$$

Where	FS = Field Strength	CL = Cable Attenuation Factor (Cable Loss)
	RA = Reading Amplitude	AG = Amplifier Gain
	AF = Antenna Factor	

## 9.6 Measurement Result:

Note: Refer to next page spectrum analyzer data chart and tabular data sheets.

**Radiated Spurious Emission Measurement Result (below 1GHz) (worst case: 802.11g mode)**

Operation Mode	TX CH Low	Test Date	2017/05/24
Channel Number	2412MHz	Test By	Lake
Temperature	25 °C	Humidity	60 %

No	Freq MHz	Reading dBuV	Factor dB	Level dBuV/m	Limit dBuV/m	Over Limit dB	Remark	Pol V/H
1	47.46	64.67	-26.94	37.73	40.00	-2.27	Peak	VERTICAL
2	94.99	66.38	-26.54	39.84	43.50	-3.66	Peak	VERTICAL
3	144.46	67.20	-26.14	41.06	43.50	-2.44	Peak	VERTICAL
4	240.49	63.13	-25.52	37.61	46.00	-8.39	Peak	VERTICAL
5	719.67	68.51	-25.15	43.36	46.00	-2.64	Peak	VERTICAL
6	815.70	68.70	-24.72	43.98	46.00	-2.02	Peak	VERTICAL
1	72.68	64.02	-26.71	37.31	40.00	-2.69	Peak	HORIZONTAL
2	94.99	65.57	-26.54	39.03	43.50	-4.47	Peak	HORIZONTAL
3	144.46	65.89	-26.14	39.75	43.50	-3.75	Peak	HORIZONTAL
4	239.52	65.72	-25.52	40.20	46.00	-5.80	Peak	HORIZONTAL
5	719.67	68.65	-25.15	43.50	46.00	-2.50	Peak	HORIZONTAL
6	768.17	68.36	-24.94	43.42	46.00	-2.58	Peak	HORIZONTAL

Remark:

- 1 No further spurious emissions detected from the lowest internal frequency and 30MHz.
- 2 Measuring frequencies from the lowest internal frequency to the 1GHz.
- 3 Radiated emissions measured in frequency range from 9MHz to 1000MHz were made with an instrument detector setting 9-90KHz/110-490KHz using PK/AV and other Frequency Band using PK/QP
- 4 Measurement result within this frequency range shown “ - ” in the table above means the reading of emissions are attenuated more than 20dB below the permissible limits or the field strength is too small to be measured.
- 5 The IF bandwidth of SPA between 9kHz to 30MHz was 10kHz, VBW= 30kHz; between 30MHz to 1GHz was 100KHz, VBW=300KHz.

**Radiated Spurious Emission Measurement Result (below 1GHz)**

Operation Mode	TX CH Mid	Test Date	2017/05/24
Channel Number	2437MHz	Test By	Lake
Temperature	25 °C	Humidity	60 %

No	Freq MHz	Reading dBuV	Factor dB	Level dBuV/m	Limit dBuV/m	Over Limit dB	Remark	Pol V/H
1	47.46	63.78	-26.94	36.84	40.00	-3.16	Peak	VERTICAL
2	95.96	66.98	-26.54	40.44	43.50	-3.06	Peak	VERTICAL
3	144.46	65.61	-26.14	39.47	43.50	-4.03	Peak	VERTICAL
4	240.49	63.53	-25.52	38.01	46.00	-7.99	Peak	VERTICAL
5	480.08	58.56	-25.65	32.91	46.00	-13.09	Peak	VERTICAL
6	623.64	60.27	-25.50	34.77	46.00	-11.23	Peak	VERTICAL
1	48.43	64.25	-26.94	37.31	40.00	-2.69	Peak	HORIZONTAL
2	95.96	67.77	-26.54	41.23	43.50	-2.27	Peak	HORIZONTAL
3	144.46	68.41	-26.14	42.27	43.50	-1.23	Peak	HORIZONTAL
4	239.52	62.35	-25.52	36.83	46.00	-9.17	Peak	HORIZONTAL
5	719.67	69.01	-25.15	43.86	46.00	-2.14	Peak	HORIZONTAL
6	700.27	37.96	-4.03	33.93	46.00	-12.07	Peak	HORIZONTAL

Remark:

- 1 No further spurious emissions detected from the lowest internal frequency and 30MHz.
- 2 Measuring frequencies from the lowest internal frequency to the 1GHz.
- 3 Radiated emissions measured in frequency range from 9MHz to 1000MHz were made with an instrument detector setting 9-90KHz/110-490KHz using PK/AV and other Frequency Band using PK/QP
- 4 Measurement result within this frequency range shown “ - ” in the table above means the reading of emissions are attenuated more than 20dB below the permissible limits or the field strength is too small to be measured.
- 5 The IF bandwidth of SPA between 9kHz to 30MHz was 10kHz, VBW= 30kHz; between 30MHz to 1GHz was 100KHz, VBW=300KHz.

**Radiated Spurious Emission Measurement Result (below 1GHz)**

Operation Mode	TX CH High	Test Date	2017/05/24
Channel Number	2462MHz	Test By	Lake
Temperature	25 °C	Humidity	60 %

No	Freq MHz	Reading dBuV	Factor dB	Level dBuV/m	Limit dBuV/m	Over Limit dB	Remark	Pol V/H
1	47.46	64.72	-26.94	37.78	40.00	-2.22	Peak	VERTICAL
2	95.96	66.71	-26.54	40.17	43.50	-3.33	Peak	VERTICAL
3	144.46	65.42	-26.14	39.28	43.50	-4.22	Peak	VERTICAL
4	240.49	61.59	-25.52	36.07	46.00	-9.93	Peak	VERTICAL
5	480.08	57.92	-25.65	32.27	46.00	-13.73	Peak	VERTICAL
6	623.64	60.00	-25.50	34.50	46.00	-11.50	Peak	VERTICAL
1	72.68	64.43	-26.71	37.72	40.00	-2.28	Peak	HORIZONTAL
2	95.96	67.14	-26.54	40.60	43.50	-2.90	Peak	HORIZONTAL
3	144.46	67.23	-26.14	41.09	43.50	-2.41	Peak	HORIZONTAL
4	719.67	69.00	-25.15	43.85	46.00	-2.15	Peak	HORIZONTAL
5	768.17	68.47	-24.94	43.53	46.00	-2.47	Peak	HORIZONTAL
6	815.70	67.70	-24.72	42.98	46.00	-3.02	Peak	HORIZONTAL

Remark:

- 1 No further spurious emissions detected from the lowest internal frequency and 30MHz.
- 2 Measuring frequencies from the lowest internal frequency to the 1GHz.
- 3 Radiated emissions measured in frequency range from 9MHz to 1000MHz were made with an instrument detector setting 9-90KHz/110-490KHz using PK/AV and other Frequency Band using PK/QP
- 4 Measurement result within this frequency range shown “ - ” in the table above means the reading of emissions are attenuated more than 20dB below the permissible limits or the field strength is too small to be measured.
- 5 The IF bandwidth of SPA between 9kHz to 30MHz was 10kHz, VBW= 30kHz; between 30MHz to 1GHz was 100KHz, VBW=300KHz.



**Radiated Spurious Emission Measurement Result (above 1GHz) (worst case: 802.11g mode)**

Operation Mode	TX CH Low	Test Date	2017/05/24
Channel Number	2412MHz	Test By	Lake
Temperature	25 °C	Pol	Ver.
Humidity	60 %		

No	Freq MHz	Reading dBuV	Factor dB	Level dBuV/m	Limit dBuV/m	Over Limit dB	Remark	Pol V/H
1	4824.00	29.49	0.98	30.47	74.00	-43.53	Peak	VERTICAL
2	7236.00	28.17	7.69	35.86	74.00	-38.14	Peak	VERTICAL
1	4824.00	30.42	0.98	31.40	74.00	-42.60	Peak	HORIZONTAL
2	7236.00	28.67	7.69	36.36	74.00	-37.64	Peak	HORIZONTAL

Remark:

- 1 Field strength limits for frequency above 1000MHz are based on average limits. However, Peak mode field strength shall not exceed the average limits specified plus 20dB.
- 2 Measurement of data within this frequency range shown “ - ” in the table above means the reading of emissions are attenuated more than 20dB below the permissible limits or the field strength is too small to be measured.
- 3 Spectrum Peak mode IF bandwidth Setting : 1GHz- 26GHz, RBW= 1MHz, Sweep time= 200 ms., the VBW setting was 3 MHz.
- 4 Spectrum AV mode if bandwidth Setting : 1GHz- 26GHz, RBW= 1MHz, VBW= 10Hz, Sweep time= 200 ms.

### Radiated Spurious Emission Measurement Result (above 1GHz)

Operation Mode	TX CH Mid	Test Date	2017/05/24
Channel Number	2437MHz	Test By	Lake
Temperature	25 °C	Pol	Ver./Hor
Humidity	60 %		

No	Freq MHz	Reading dBuV	Factor dB	Level dBuV/m	Limit dBuV/m	Over Limit dB	Remark	Pol V/H
1	4874.00	30.08	1.07	31.15	74.00	-42.85	Peak	VERTICAL
2	7311.00	28.27	7.81	36.08	74.00	-37.92	Peak	VERTICAL
1	4874.00	29.40	1.07	30.47	74.00	-43.53	Peak	HORIZONTAL
2	7311.00	27.52	7.81	35.33	74.00	-38.67	Peak	HORIZONTAL

Remark:

- 1 Field strength limits for frequency above 1000MHz are based on average limits. However, Peak mode field strength shall not exceed the average limits specified plus 20dB.
- 2 Measurement of data within this frequency range shown “ - ” in the table above means the reading of emissions are attenuated more than 20dB below the permissible limits or the field strength is too small to be measured.
- 3 Spectrum Peak mode IF bandwidth Setting : 1GHz- 26GHz, RBW= 1MHz, Sweep time= 200 ms., the VBW setting was 3 MHz.
- 4 Spectrum AV mode if bandwidth Setting : 1GHz- 26GHz, RBW= 1MHz, VBW= 10Hz, Sweep time= 200 ms.

**Radiated Spurious Emission Measurement Result (above 1GHz)**

Operation Mode	TX CH High	Test Date	2017/05/24
Channel Number	2462MHz	Test By	Lake
Temperature	25 °C	Pol	Ver./Hor
Humidity	60 %		

No	Freq MHz	Reading dBuV	Factor dB	Level dBuV/m	Limit dBuV/m	Over Limit dB	Remark	Pol V/H
1	4924.00	29.39	1.17	30.56	74.00	-43.44	Peak	VERTICAL
2	7386.00	28.27	7.91	36.18	74.00	-37.82	Peak	VERTICAL
1	4924.00	29.14	1.17	30.31	74.00	-43.69	Peak	HORIZONTAL
2	7386.00	26.50	7.91	34.41	74.00	-39.59	Peak	HORIZONTAL

Remark:

- 1 Field strength limits for frequency above 1000MHz are based on average limits. However, Peak mode field strength shall not exceed the average limits specified plus 20dB.
- 2 Measurement of data within this frequency range shown “ - ” in the table above means the reading of emissions are attenuated more than 20dB below the permissible limits or the field strength is too small to be measured.
- 3 Spectrum Peak mode IF bandwidth Setting : 1GHz- 26GHz, RBW= 1MHz, Sweep time= 200 ms., the VBW setting was 3 MHz.
- 4 Spectrum AV mode if bandwidth Setting : 1GHz- 26GHz, RBW= 1MHz, VBW= 10Hz, Sweep time= 200 ms.

## 10 Peak Power Spectral Density

### 10.1 Standard Applicable:

According to §15.247(e) For digitally modulated systems, the power spectral density conducted from the intentional radiator to the antenna shall not be greater than 8 dBm in any 3 kHz band during any time interval of continuous transmission. This power spectral density shall be determined in accordance with the provisions of paragraph (b) of this section. The same method of determining the conducted output power shall be used to determine the power spectral density.

### 10.2 Measurement Equipment Used:

Refer to section 6.2 for details.

### 10.3 Test Set-up:

Refer to section 6.3 for details.

### 10.4 Measurement Procedure:

1. Place the EUT on the table and set it in transmitting mode.
2. Remove the antenna from the EUT and then connect a low loss RF cable from the antenna port to the spectrum analyzer.
3. Set the spectrum analyzer as RBW =100KHz, VBW = 300KHz, Span =5 to 30% greater than emission BW, Sweep=Auto
4. Record the max. reading.
5. Repeat above procedures until all frequency measured were complete.

## 10.5 Measurement Result:

### 802.11b Mode

CH	Power Density Level (dBm)	Maximum Limit (dBm)
Low	-19.19	8
Mid	-19.05	8
High	-18.49	8

### 802.11g Mode

CH	Power Density Level (dBm)	Maximum Limit (dBm)
Low	-16.17	8
Mid	-15.93	8
High	-14.7	8

### 802.11N HT20

CH	Power Density Level (dBm)	Maximum Limit (dBm)
Low	-17.43	8
Mid	-16.01	8
High	-15.72	8

### 802.11N HT40

CH	Power Density Level (dBm)	Maximum Limit (dBm)
Low	-15.33	8
Mid	-17.59	8
High	-16.84	8

### 802.11b

### Power Spectral Density Test Plot (CH-Low)

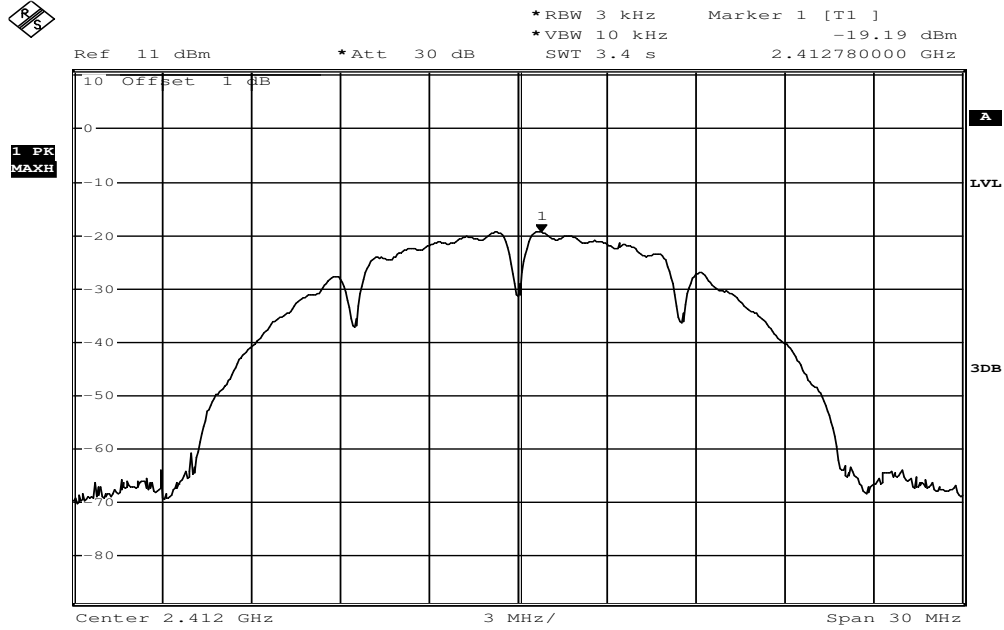

Date: 26.AUG.2016 14:16:00

### Power Spectral Density Test Plot (CH-Mid)

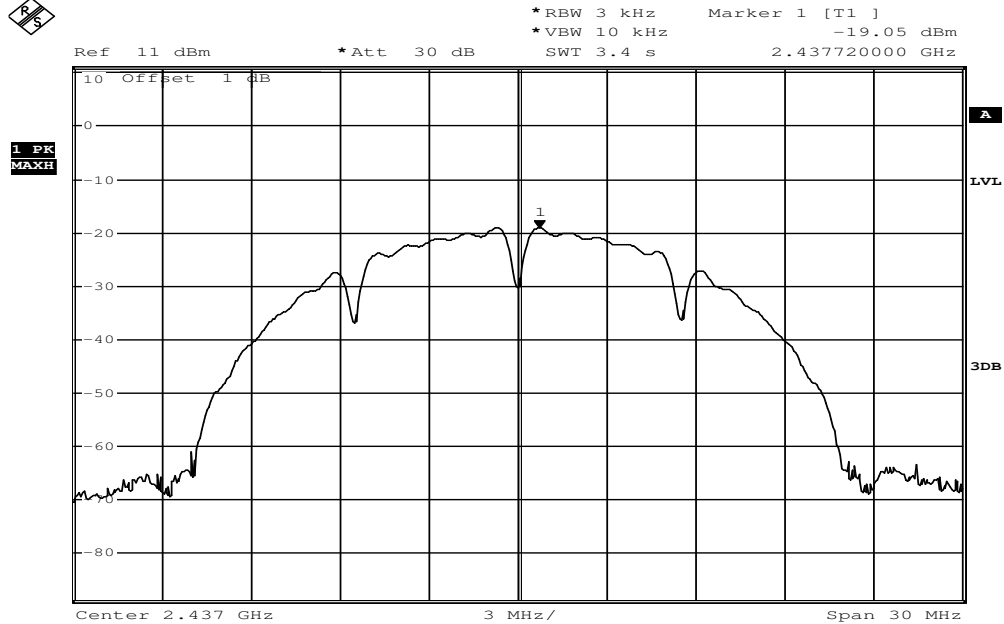

Date: 26.AUG.2016 14:17:44

### Power Spectral Density Test Plot (CH-High)

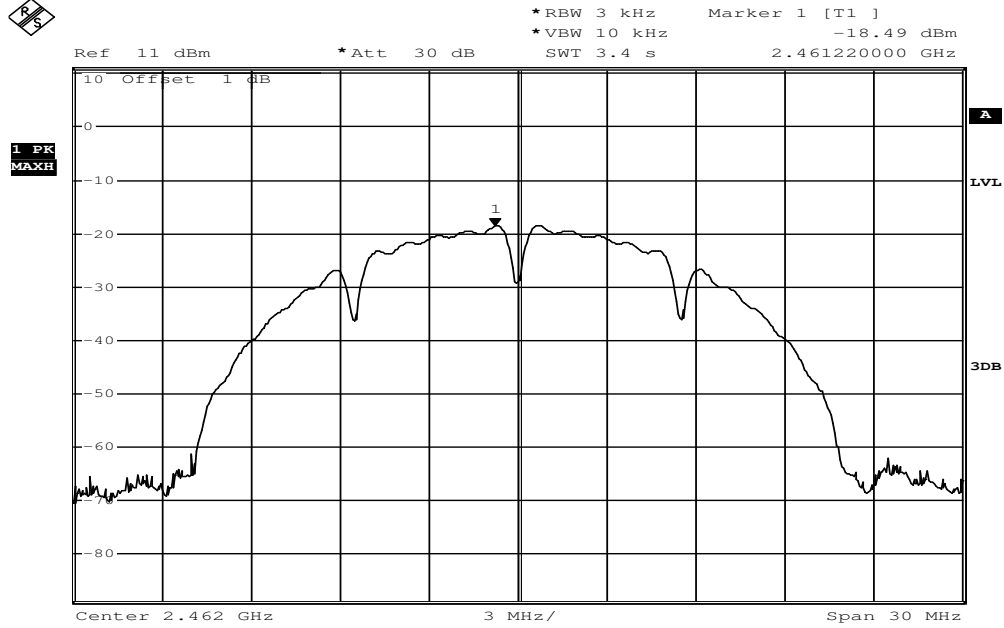

Date: 26.AUG.2016 14:18:49

### 802.11g

### Power Spectral Density Test Plot (CH-Low)

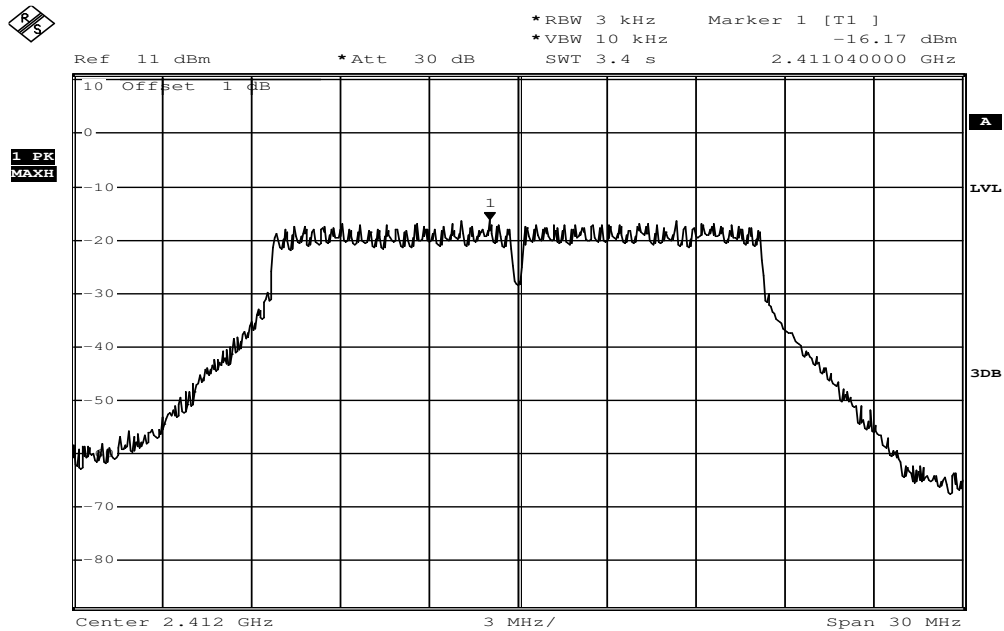

Date: 26.AUG.2016 14:21:56

### Power Spectral Density Test Plot (CH-Mid)

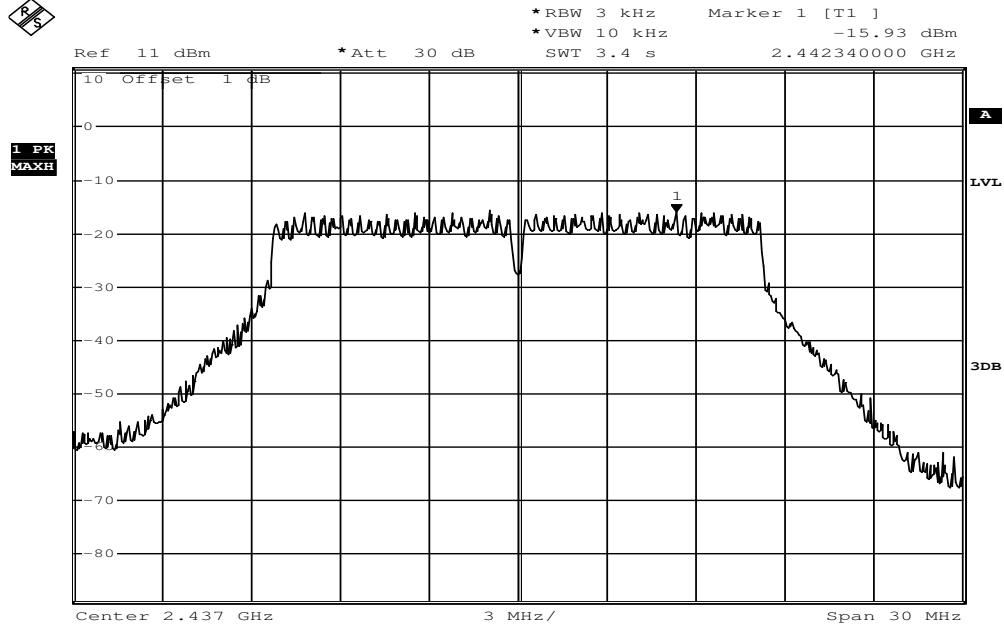

Date: 26.AUG.2016 14:21:08

### Power Spectral Density Test Plot (CH-High)

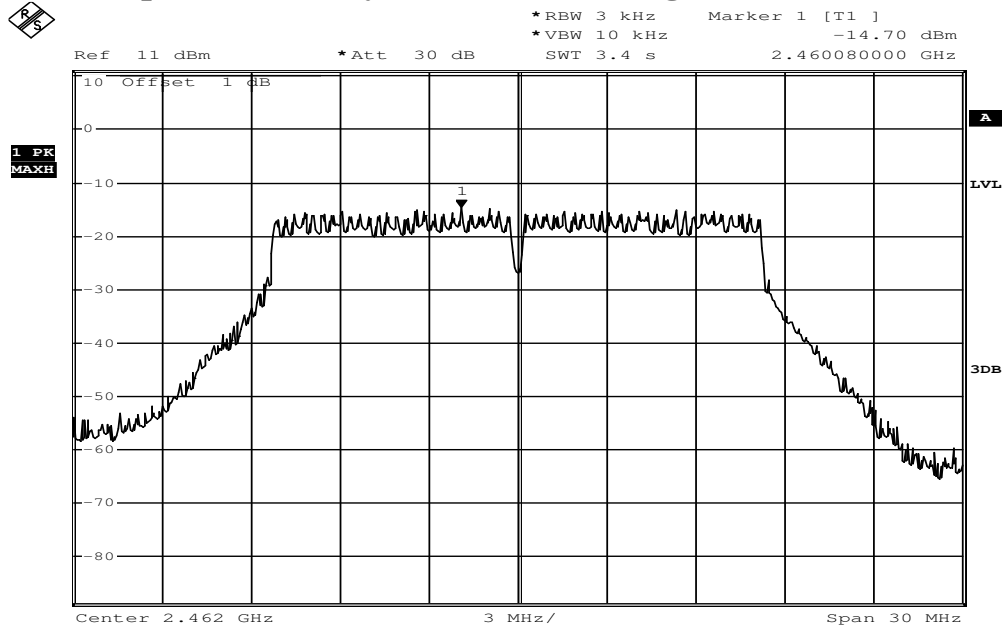

Date: 26.AUG.2016 14:20:33



### 802.11n\_20M

### Power Spectral Density Test Plot (CH-Low)

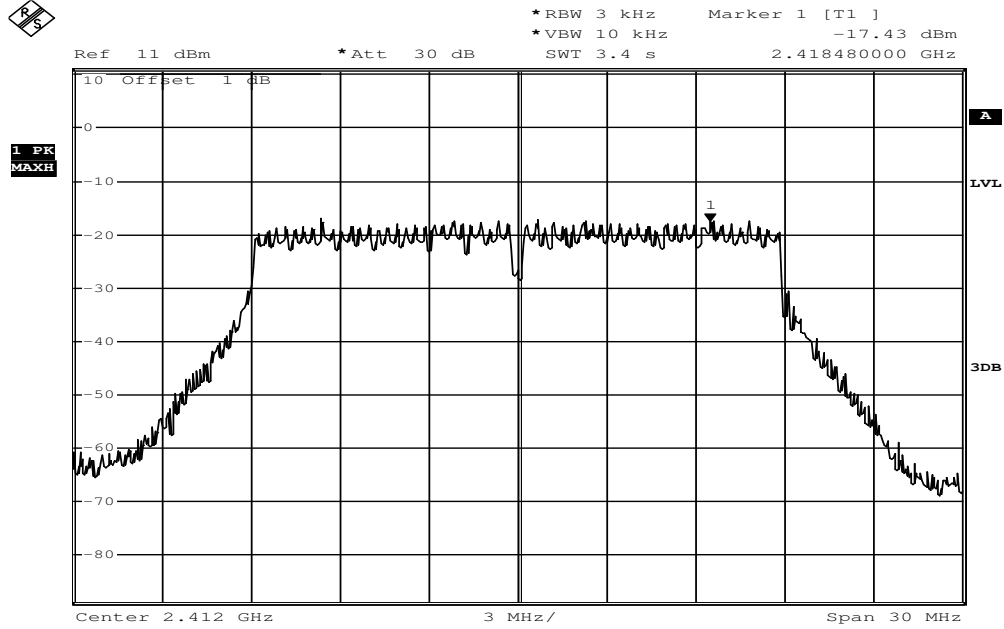

Date: 26.AUG.2016 11:42:20

### Power Spectral Density Test Plot (CH-Mid)

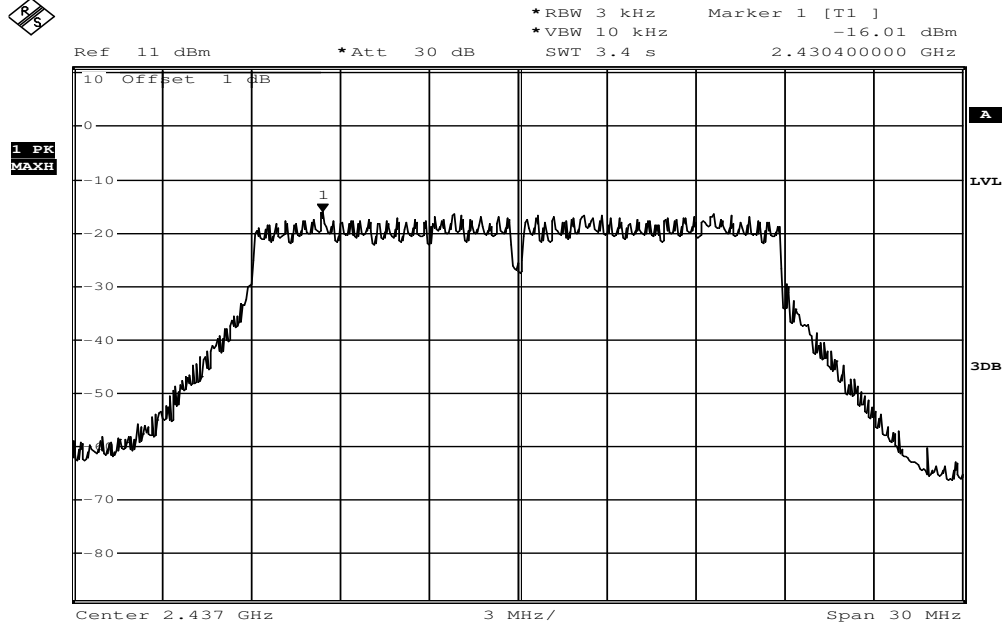

Date: 26.AUG.2016 11:41:20

### Power Spectral Density Test Plot (CH-High)

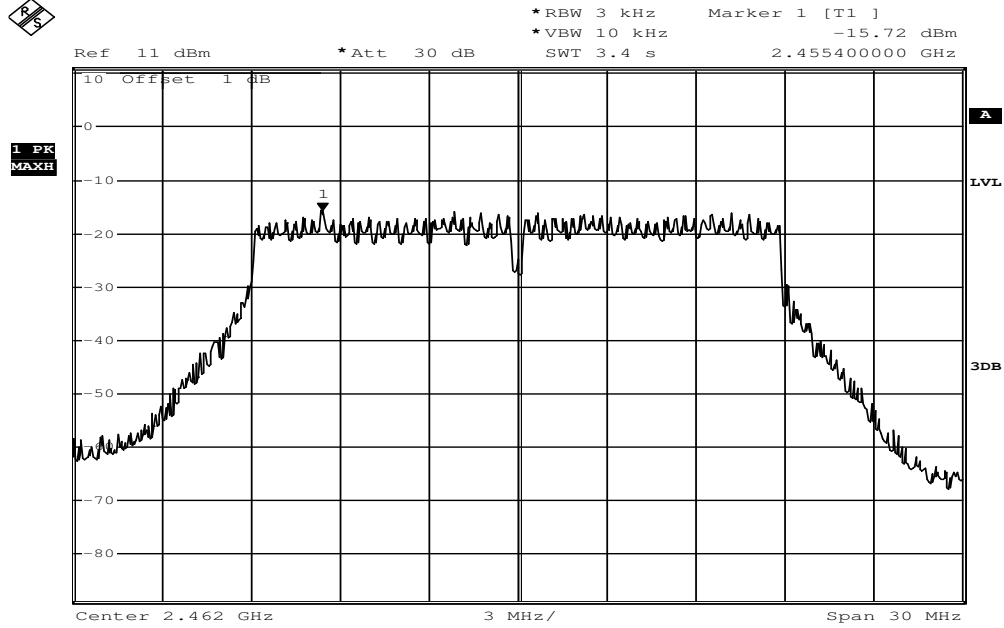

Date: 26.AUG.2016 11:43:02

### 802.11n\_40M

### Power Spectral Density Test Plot (CH-Low)

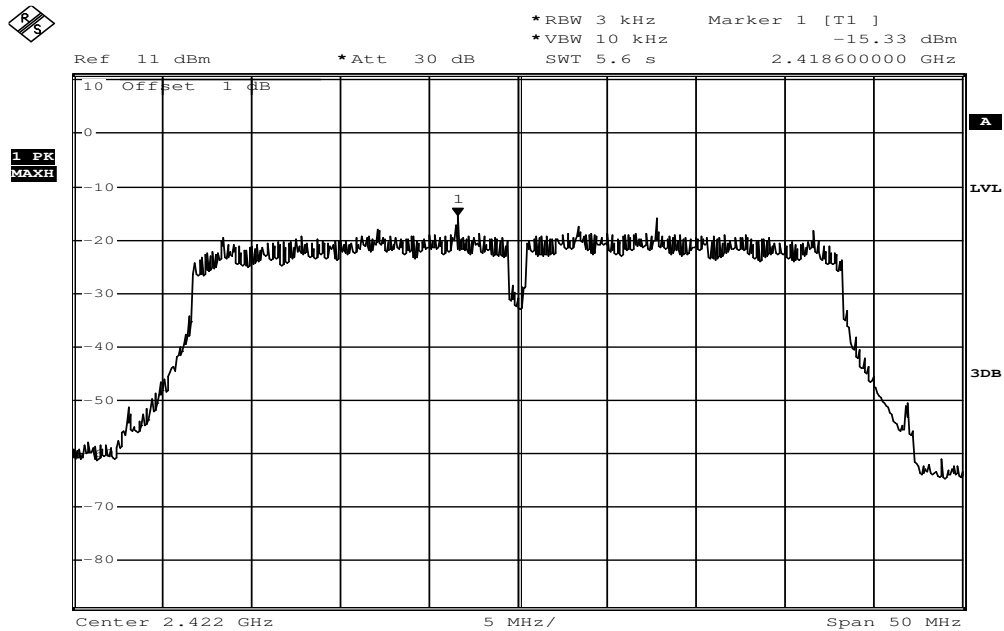

Date: 26.AUG.2016 13:59:12

### Power Spectral Density Test Plot (CH-Mid)

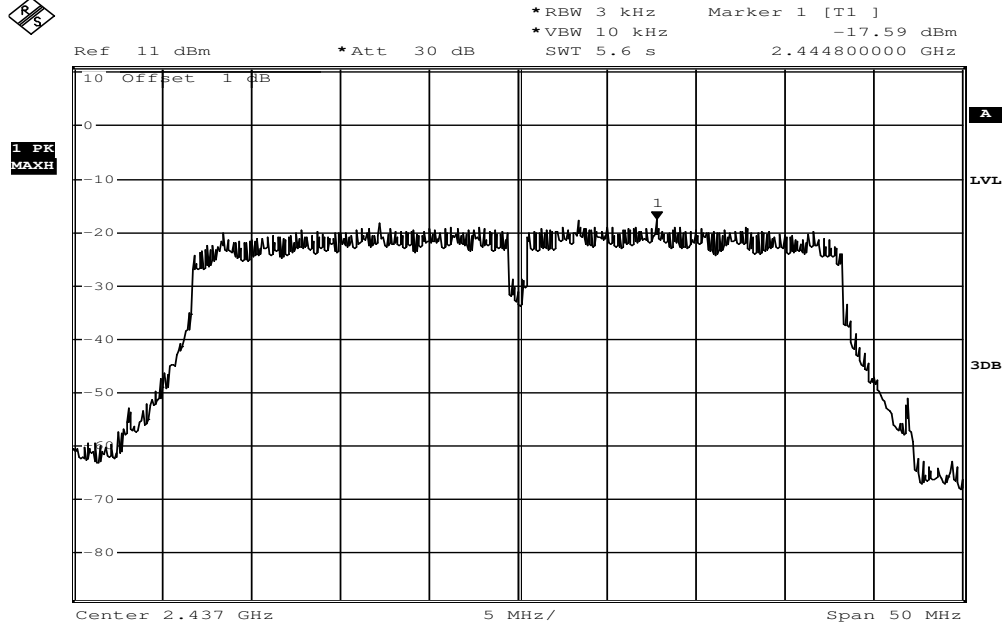

Date: 26.AUG.2016 14:00:26

### Power Spectral Density Test Plot (CH-High)

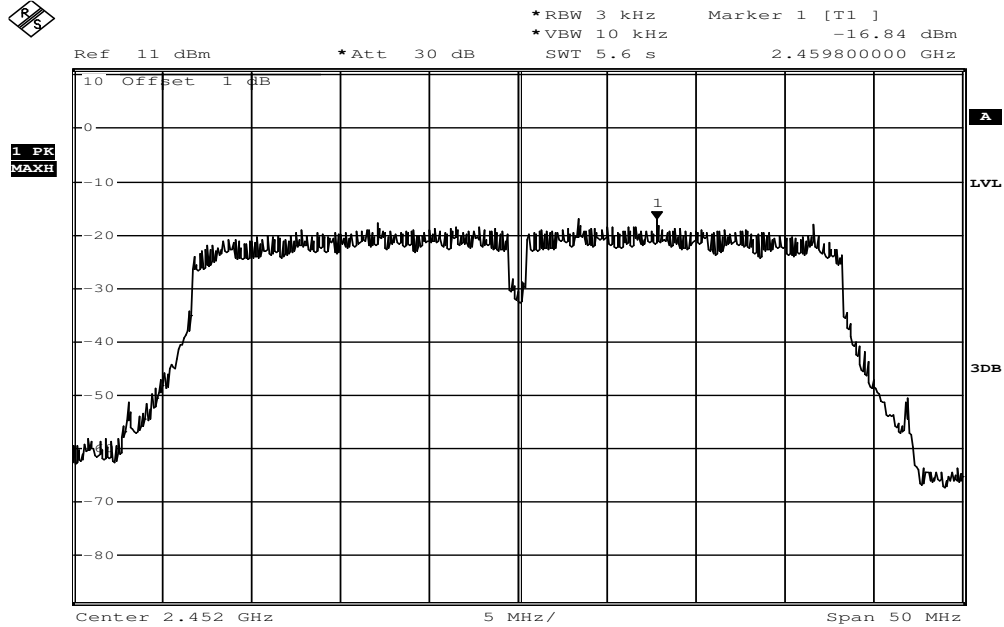

Date: 26.AUG.2016 14:01:39

## 11 ANTENNA REQUIREMENT

### 11.1 Standard Applicable:

According to §15.203, Antenna requirement.

An intentional radiator shall be designed to ensure that no antenna other than that furnished by the responsible party shall be used with the device. The use of a permanently attached antenna or of an antenna that uses a unique coupling to the intentional radiator shall be considered sufficient to comply with the provisions of this Section. The manufacturer may design the unit so that a broken antenna can be replaced by the user, but the use of a standard antenna jack or electrical connector is prohibited. This requirement does not apply to carrier current devices or to devices operated under the provisions of Sections 15.211, 15.213, 15.217, 15.219, or 15.221. Further, this requirement does not apply to intentional radiators that must be professionally installed, such as perimeter protection systems and some field disturbance sensors, or to other intentional radiators which, in accordance with Section 15.31(d), must be measured at the installation site. However, the installer shall be responsible for ensuring that the proper antenna is employed so that the limits in this Part are not exceeded.

### 11.2 Antenna Connected Construction:

The directional gains of antenna used for transmitting is -3.86dBi, and the antenna connector is designed with fixed type and no consideration of replacement. Please see EUT photo and antenna spec. for details.