



# SPORTON International Inc.

No. 52, Hwa Ya 1st Rd., Hwa Ya Technology Park, Kwei-Shan Hsiang, Tao Yuan Hsien, Taiwan, R.O.C.  
Ph: 886-3-327-3456 / FAX: 886-3-327-0973 / www.sporton.com.tw

## FCC RADIO TEST REPORT

Applicant's company	Google Inc.
Applicant Address	1600 Amphitheater Parkway, Mountain View, CA 94043
FCC ID	A4RNLS-1304-25
Manufacturer's company	Wistron NeWeb Corporation
Manufacturer Address	20 Park Ave. II, Hsinchu Science Park, Hsinchu 308, Taiwan

Product Name	Dual band WiFi Router
Brand Name	Google
Model Name	NLS-1304-25
Test Rule	47 CFR FCC Part 15 Subpart C § 15.247
Test Freq. Range	2402 ~ 2480MHz
Received Date	Sep. 14, 2016
Final Test Date	Oct. 11, 2016
Submission Type	Original Equipment

### Statement

**Test result included is only for the Bluetooth LE of the product.**

The test result in this report refers exclusively to the presented test model / sample.

Without written approval of SPORTON International Inc., the test report shall not be reproduced except in full.

The measurements and test results shown in this test report were made in accordance with the procedures and found in compliance with the limit given in **ANSI C63.10-2013, 47 CFR FCC Part 15 Subpart C** and **KDB558074 D01 v03r05**.

The test equipment used to perform the test is calibrated and traceable to NML/ROC.



## Table of Contents

<b>1. VERIFICATION OF COMPLIANCE</b> .....	<b>1</b>
<b>2. SUMMARY OF THE TEST RESULT</b> .....	<b>2</b>
<b>3. GENERAL INFORMATION</b> .....	<b>3</b>
3.1. Product Details.....	3
3.2. Accessories.....	3
3.3. Table for Filed Antenna.....	4
3.4. Table for Carrier Frequencies .....	5
3.5. Table for Test Modes.....	5
3.6. Table for Testing Locations.....	6
3.7. Table for Multiple source Listing .....	6
3.8. Table for Supporting Units .....	7
3.9. Table for Parameters of Test Software Setting .....	7
3.10. EUT Operation during Test .....	7
3.11. Duty Cycle.....	7
3.12. Test Configurations .....	8
<b>4. TEST RESULT</b> .....	<b>11</b>
4.1. AC Power Line Conducted Emissions Measurement.....	11
4.2. Maximum Conducted Output Power Measurement.....	17
4.3. Power Spectral Density Measurement .....	19
4.4. 6dB Spectrum Bandwidth Measurement .....	23
4.5. Radiated Emissions Measurement .....	27
4.6. Emissions Measurement .....	39
4.7. Antenna Requirements .....	47
<b>5. LIST OF MEASURING EQUIPMENTS</b> .....	<b>48</b>
<b>6. MEASUREMENT UNCERTAINTY</b> .....	<b>49</b>
<b>APPENDIX A. TEST PHOTOS</b> .....	<b>A1 ~ A4</b>



### History of This Test Report

REPORT NO.	VERSION	DESCRIPTION	ISSUED DATE
FR690910AD	Rev. 01	Initial issue of report	Oct. 24, 2016

## 1. VERIFICATION OF COMPLIANCE

Product Name : Dual band WiFi Router  
Brand Name : Google  
Model No. : NLS-1304-25  
Applicant : Google Inc.  
Test Rule Part(s) : 47 CFR FCC Part 15 Subpart C § 15.247

Sporton International as requested by the applicant to evaluate the EMC performance of the product sample received on Sep. 14, 2016 would like to declare that the tested sample has been evaluated and found to be in compliance with the tested rule parts. The data recorded as well as the test configuration specified is true and accurate for showing the sample's EMC nature.



Sam Chen

SPORTON INTERNATIONAL INC.

## 2. SUMMARY OF THE TEST RESULT

Applied Standard: 47 CFR FCC Part 15 Subpart C			
Part	Rule Section	Description of Test	Result
4.1	15.207	AC Power Line Conducted Emissions	Complies
4.2	15.247(b)(3)	Maximum Conducted Output Power	Complies
4.3	15.247(e)	Power Spectral Density	Complies
4.4	15.247(a)(2)	6dB Spectrum Bandwidth	Complies
4.5	15.247(d)	Radiated Emissions	Complies
4.6	15.247(d)	Band Edge Emissions	Complies
4.7	15.203	Antenna Requirements	Complies

### 3. GENERAL INFORMATION

#### 3.1. Product Details

Items	Description
Power Type	From power adapter
Modulation	DSSS
Data Rate (Mbps)	GFSK: 1
Frequency Range	2402 ~ 2480MHz
Channel Number	40 (37 hopping + 3 advertising channel)
Channel Bandwidth (99%)	1.03 MHz
Maximum Conducted Output Power	10.27 dBm
Carrier Frequencies	Please refer to section 3.4
Antenna	Please refer to section 3.3

#### 3.2. Accessories

Power	Brand	Model	Rating
Adapter	Salcomp	GL0102	Input: 100-240V~50/60Hz, 0.4A Output: 5V, 3A
<b>Other</b>			
RJ-45 cable*1, Non-shielded, 2m			

### 3.3. Table for Filed Antenna

Ant.	Chain		Brand	Model No.	Antenna Type	Connector	Gain (dBi)				Remark
	2.4 GHz	5 GHz					2.4 GHz	5 GHz	BT	Zigbee	
1	1	2	WNC	N/A	LG material	I-PEX	3.72	4.86	-	-	TX/RX
2	2	-	WNC	N/A	LG material	I-PEX	3.72	-	-	-	TX/RX
3	-	1	WNC	N/A	LG material	I-PEX	-	4.86	-	-	TX/RX
4	3	3	WNC	N/A	LG material	I-PEX	-	4.86	-	2.89	For Zigbee TX/RX. For 5GHz only RX.
5	4	-	WNC	N/A	LG material	I-PEX	-	-	5.84	-	TX/RX

Note: The EUT has five antennas.

**For 2.4GHz function:**

For IEEE 802.11b/g/n/ac mode (2TX/2RX):

Chain.1 and Chain.2 can be used as transmitting/receiving antenna.

Chain.1 and Chain.2 could transmit/receive simultaneously.

**For 5GHz function:**

For IEEE 802.11a/n/ac mode (2TX/3RX):

Chain.1 and Chain.2 can be use as transmitting antenna.

Chain 1 and chain 2 can transmitting simultaneously.

Chain 1, Chain 2 and Chain 3 can be used as receiving antennas.

Chain 1, Chain 2 and Chain 3 could receive simultaneously.

**For Zigbee function:**

Only Chain.3 can be used as transmitting/receiving antenna.

**For Bluetooth function:**

Only Chain.4 can be used as transmitting/receiving antenna.

### 3.4. Table for Carrier Frequencies

Frequency Band	Channel No.	Frequency	Channel No.	Frequency
2400~2483.5MHz	0	2402 MHz	20	2442 MHz
	1	2404 MHz	:	:
	2	2406 MHz	37	2476 MHz
	:	:	38	2478 MHz
	18	2438 MHz	39	2480 MHz
	19	2440 MHz	-	-

### 3.5. Table for Test Modes

Preliminary tests were performed in different data rate to find the worst radiated emission. The data rate shown in the table below is the worst-case rate with respect to the specific test item. Investigation has been done on all the possible configurations for searching the worst cases. The following table is a list of the test modes shown in this test report.

Test Items	Mode	Data Rate	Channel	Chain
AC Power Line Conducted Emissions	Normal Link	-	-	-
Maximum Conducted Output Power Power Spectral Density	GFSK	1 Mbps	0/20/39	4
6dB Spectrum Bandwidth	GFSK	1 Mbps	0/20/39	4
Radiated Emissions 9kHz~1GHz	Normal Link	-	-	-
Radiated Emissions 1GHz~10 <sup>th</sup> Harmonic	GFSK	1 Mbps	0/20/39	4
Band Edge Emissions	GFSK	1 Mbps	0/20/39	4

Note1: The EUT can be used at Z-axis only.

Note2: There two source for the EUT. It has influence for Conducted Emission and Radiated Emission (Below 1GHz). Thus both sources were tested. It has no influence for the others test and the EUT with main source was selected to test.

The following test modes were performed for all tests:

#### For Conducted Emission test:

Mode 1. Normal Link – Main Source

Mode 2. Normal Link – Second Source

Both modes were record in this test report

#### For Radiated Emission test (Below 1GHz):

Mode 1. Normal Link – Main Source

Mode 2. Normal Link – Second Source

Both modes were record in this test report



**For Radiated Emission test (Above 1GHz):**

Mode 1. CTX – Main Source

**For Co-location MPE Test:**

The EUT could be applied with 2.4GHz/5GHz WLAN function, Zigbee function and Bluetooth function; therefore Co-location Maximum Permissible Exposure (Please refer to FA690910) tests is added for simultaneously transmit among 2.4GHz/5GHz WLAN function, Zigbee function and Bluetooth function.

**3.6. Table for Testing Locations**

Test Site Location				
Address:	No.8, Lane 724, Bo-ai St., Jhubei City, Hsinchu County 302, Taiwan, R.O.C.			
TEL:	886-3-656-9065			
FAX:	886-3-656-9085			
Test Site No.	Site Category	Location	FCC Designation No.	IC File No.
03CH01-CB	SAC	Hsin Chu	TW0006	IC 4086D
CO01-CB	Conduction	Hsin Chu	TW0006	IC 4086D
TH01-CB	OVEN Room	Hsin Chu	-	-

Open Area Test Site (OATS); Semi Anechoic Chamber (SAC).

**3.7. Table for Multiple source Listing**

There two sources for PHY.

Source	Model Name
Main source	QCA8072
Second source	QCA8075

### 3.8. Table for Supporting Units

For Test Site No: 03CH01-CB / <Below 1GHz>

Support Unit	Brand	Model	FCC ID
NB*2	DELL	E4300	DoC
NB*2	Apple	Mac Book	DoC
iPad	Apple	A1430	DoC

For Test Site No: CO01-CB

Support Unit	Brand	Model	FCC ID
NB*4	DELL	E6430	DoC
iPad	Apple	A1430	DoC

For Test Site No: TH01-CB and 03CH01-CB / <Above 1GHz>

Support Unit	Brand	Model	FCC ID
NB	DELL	E4300	DoC

### 3.9. Table for Parameters of Test Software Setting

During testing, Channel and Power Controlling Software provided by the customer was used to control the operating channel as well as the output power level. The RF output power selection is for the setting of RF output power expected by the customer and is going to be fixed on the firmware of the final end product.

**Power Parameters:**

Test Software Version	Putty		
Frequency	2402 MHz	2442 MHz	2480 MHz
Power Parameters	Default	Default	Default

### 3.10. EUT Operation during Test

The EUT was programmed to be in continuously transmitting mode.

### 3.11. Duty Cycle

Mode	On Time (ms)	On+Off Time (ms)	Duty Cycle (%)	Duty Factor (dB)	1/T Minimum VBW (kHz)
GFSK	0.217	0.626	34.72%	4.59	4.60

### 3.12. Test Configurations

#### 3.12.1. AC Power Line Conduction Emissions Test Configuration

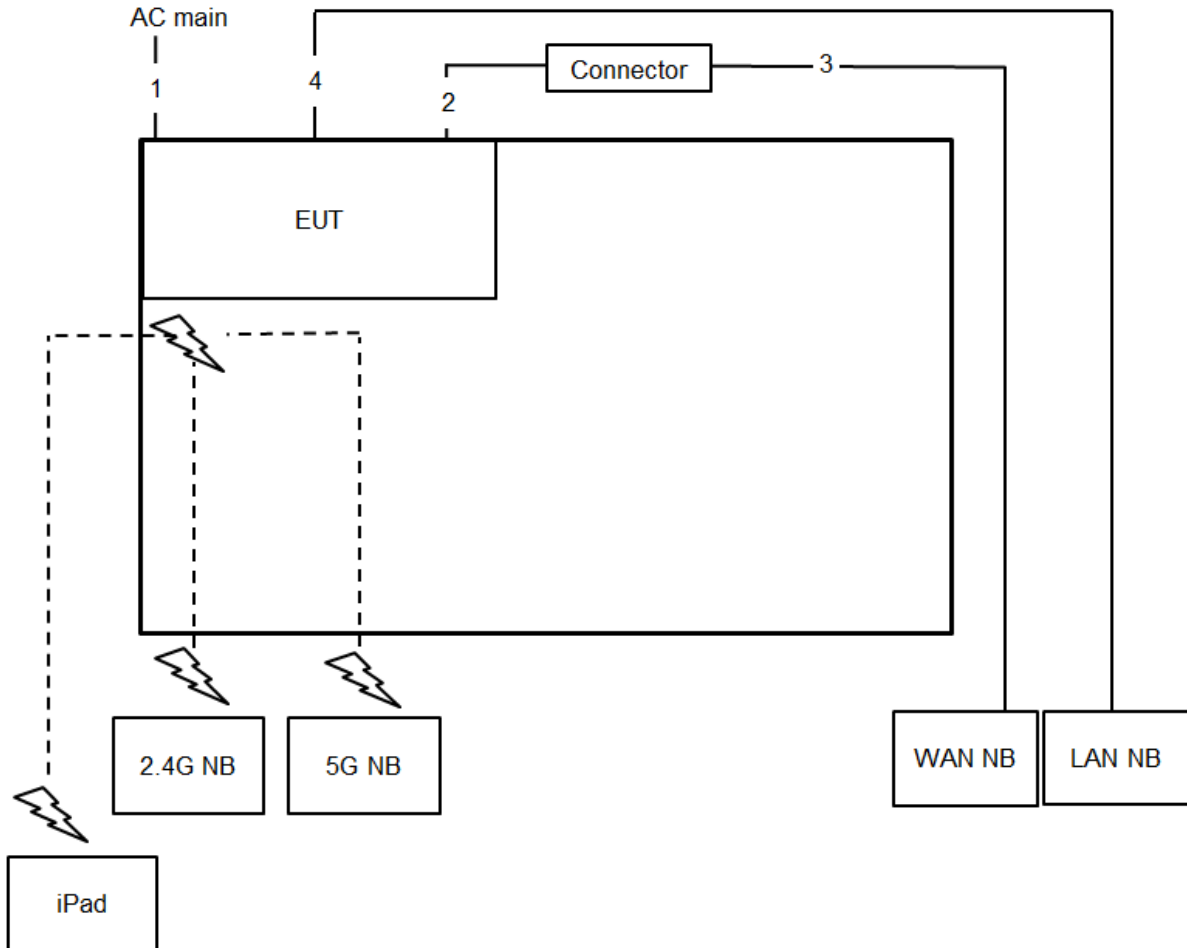

Item	Connection	Shielded	Length
1	Power cable	No	1.8m
2	RJ-45 cable	No	2m
3	RJ-45 cable	No	10m
4	RJ-45 cable	No	10m

### 3.12.2. Radiation Emissions Test Configuration

Test Configuration: 30MHz~1GHz

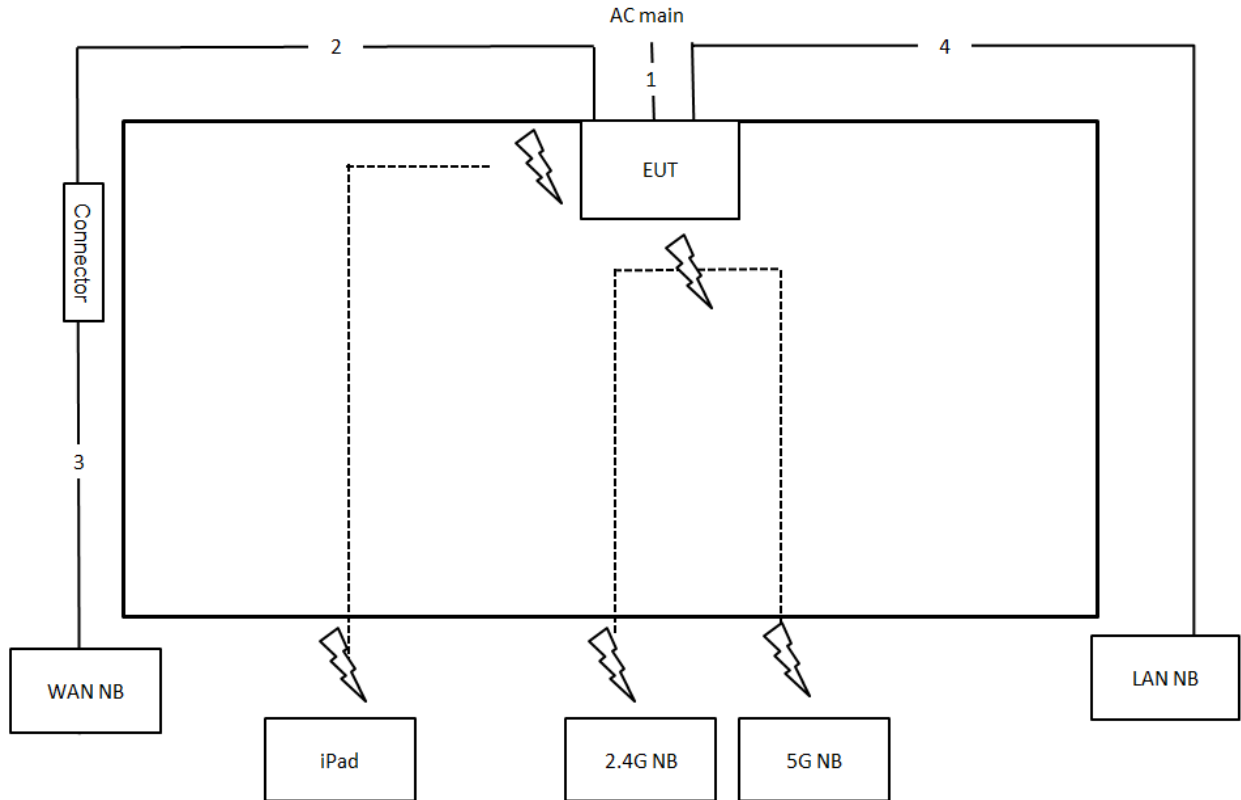

Item	Connection	Shielded	Length
1	Power cable	No	1.8m
2	RJ-45 cable	No	2m
3	RJ-45 cable	No	10m
4	RJ-45 cable	No	10m

Test Configuration: above 1GHz

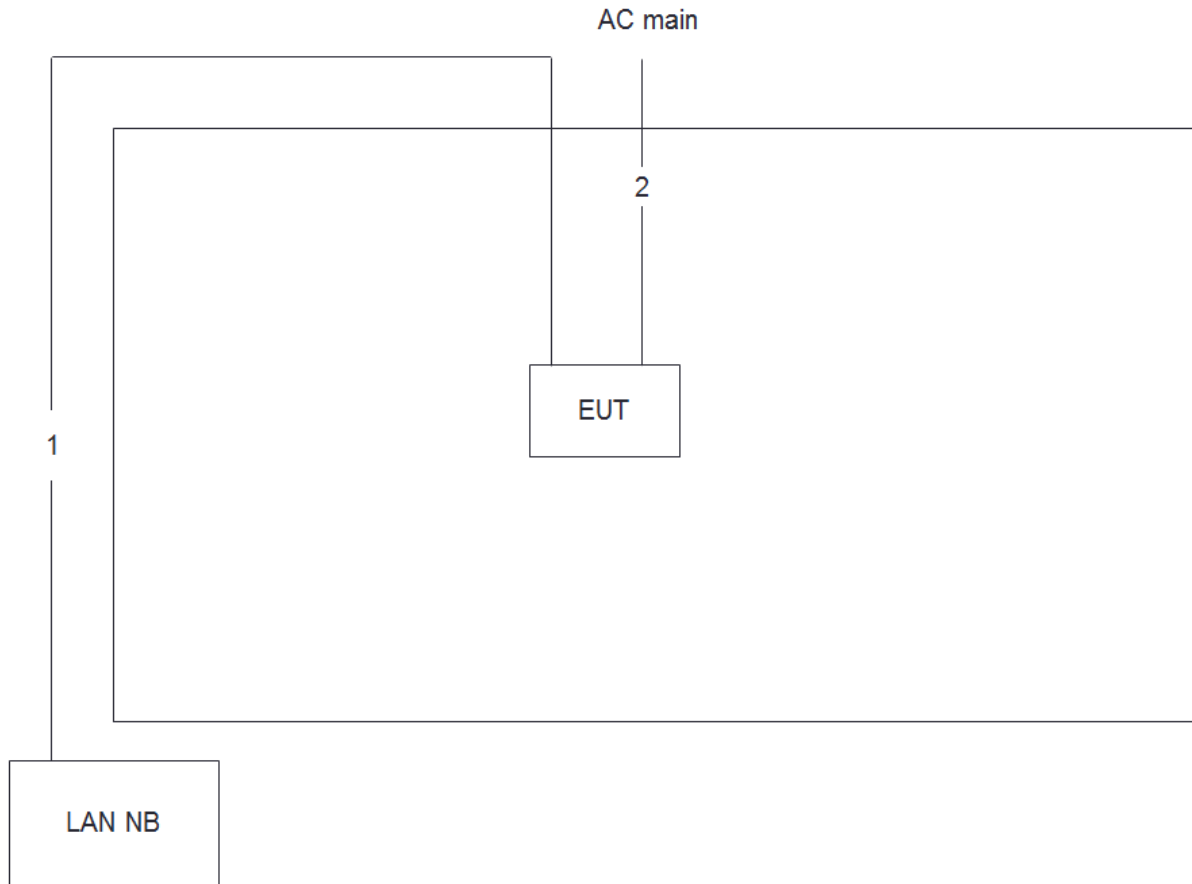

Item	Connection	Shielded	Length
1	RJ-45 cable	No	10m
2	Power cable	No	1.8m

## 4. TEST RESULT

### 4.1. AC Power Line Conducted Emissions Measurement

#### 4.1.1. Limit

For this product which is designed to be connected to the AC power line, the radio frequency voltage that is conducted back onto the AC power line on any frequency or frequencies within the band 150 kHz to 30 MHz shall not exceed below limits table.

Frequency (MHz)	QP Limit (dBuV)	AV Limit (dBuV)
0.15~0.5	66~56	56~46
0.5~5	56	46
5~30	60	50

#### 4.1.2. Measuring Instruments and Setting

Please refer to section 5 of equipments list in this report. The following table is the setting of the receiver.

Receiver Parameters	Setting
Attenuation	10 dB
Start Frequency	0.15 MHz
Stop Frequency	30 MHz
IF Bandwidth	9 kHz

#### 4.1.3. Test Procedures

1. Configure the EUT according to ANSI C63.10. The EUT or host of EUT has to be placed 0.4 meter far from the conducting wall of the shielding room and at least 80 centimeters from any other grounded conducting surface.
2. Connect EUT or host of EUT to the power mains through a line impedance stabilization network (LISN).
3. All the support units are connected to the other LISNs. The LISN should provide 50uH/50ohms coupling impedance.
4. The frequency range from 150 kHz to 30 MHz was searched.
5. Set the test-receiver system to Peak Detect Function and Specified Bandwidth with Maximum Hold Mode.
6. The measurement has to be done between each power line and ground at the power terminal.



4.1.7. Results of AC Power Line Conducted Emissions Measurement

Temperature	22°C	Humidity	52%
Test Engineer	Hank Yang	Phase	Line
Configuration	Normal Link	Test Mode	Mode 1

Line

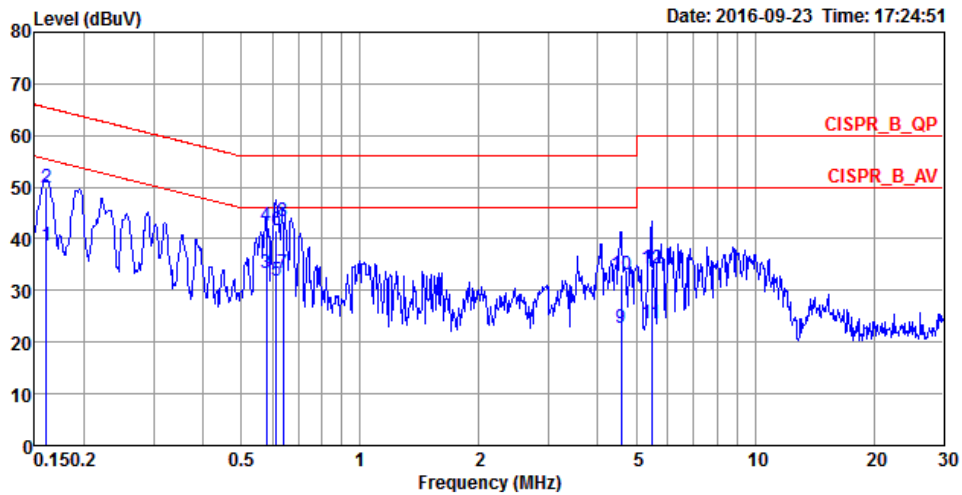

	Freq	Level	Over Limit	Limit Line	Read Level	LISN Factor	Cable Loss	Pol/Phase	Remark
	MHz	dBuV	dB	dBuV	dBuV	dB	dB		
1	0.1607	38.62	-16.81	55.43	28.43	10.02	0.17	LINE	Average
2	0.1607	49.99	-15.44	65.43	39.80	10.02	0.17	LINE	QP
3	0.5792	33.25	-12.75	46.00	23.02	9.93	0.30	LINE	Average
4	0.5792	42.38	-13.62	56.00	32.15	9.93	0.30	LINE	QP
5	0.6140	31.77	-14.23	46.00	21.49	9.93	0.35	LINE	Average
6	0.6140	41.62	-14.38	56.00	31.34	9.93	0.35	LINE	QP
7	0.6372	33.33	-12.67	46.00	23.02	9.93	0.38	LINE	Average
8	0.6372	43.48	-12.52	56.00	33.17	9.93	0.38	LINE	QP
9	4.5736	22.63	-23.37	46.00	12.52	10.01	0.10	LINE	Average
10	4.5736	33.01	-22.99	56.00	22.90	10.01	0.10	LINE	QP
11	5.4763	23.62	-26.38	50.00	13.48	10.03	0.11	LINE	Average
12	5.4763	34.34	-25.66	60.00	24.20	10.03	0.11	LINE	QP



Temperature	22°C	Humidity	52%
Test Engineer	Hank Yang	Phase	Neutral
Configuration	Normal Link	Test Mode	Mode 1

Neutral

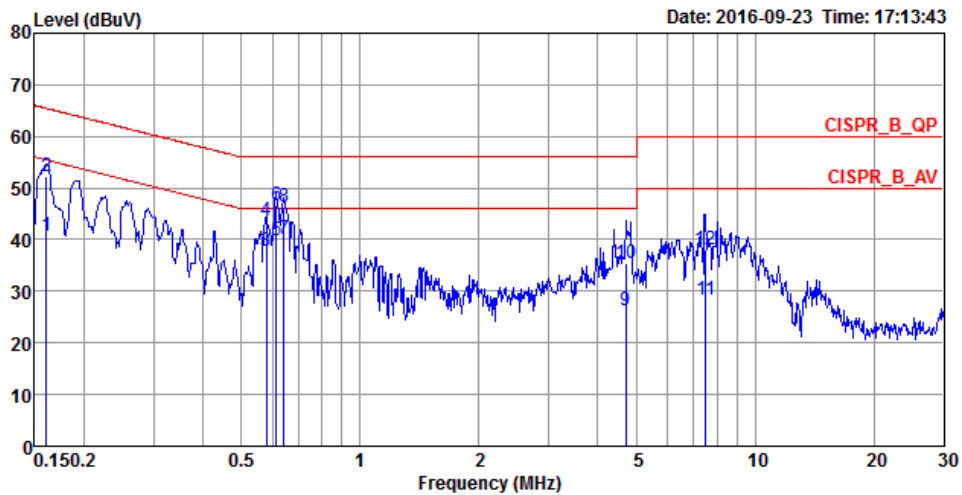

	Freq	Level	Over Limit	Limit Line	Read Level	LISN Factor	Cable Loss	Pol/Phase	Remark
	MHz	dBuV	dB	dBuV	dBuV	dB	dB		
1	0.1607	40.66	-14.77	55.43	30.47	10.02	0.17	NEUTRAL	Average
2	0.1607	52.36	-13.07	65.43	42.17	10.02	0.17	NEUTRAL	QP
3	0.5792	37.75	-8.25	46.00	27.52	9.93	0.30	NEUTRAL	Average
4	0.5792	43.82	-12.18	56.00	33.59	9.93	0.30	NEUTRAL	QP
5	0.6140	39.77	-6.23	46.00	29.49	9.93	0.35	NEUTRAL	Average
6	0.6140	46.51	-9.49	56.00	36.23	9.93	0.35	NEUTRAL	QP
7	0.6406	40.21	-5.79	46.00	29.90	9.93	0.38	NEUTRAL	Average
8	0.6406	46.33	-9.67	56.00	36.02	9.93	0.38	NEUTRAL	QP
9	4.6964	26.14	-19.86	46.00	16.03	10.01	0.10	NEUTRAL	Average
10	4.6964	35.34	-20.66	56.00	25.23	10.01	0.10	NEUTRAL	QP
11	7.4860	28.44	-21.56	50.00	18.23	10.08	0.13	NEUTRAL	Average
12	7.4860	38.05	-21.95	60.00	27.84	10.08	0.13	NEUTRAL	QP

Note: Level = Read Level + LISN Factor + Cable Loss.

Temperature	22°C	Humidity	52%
Test Engineer	Hank Yang	Phase	Line
Configuration	Normal Link	Test Mode	Mode 2

Line

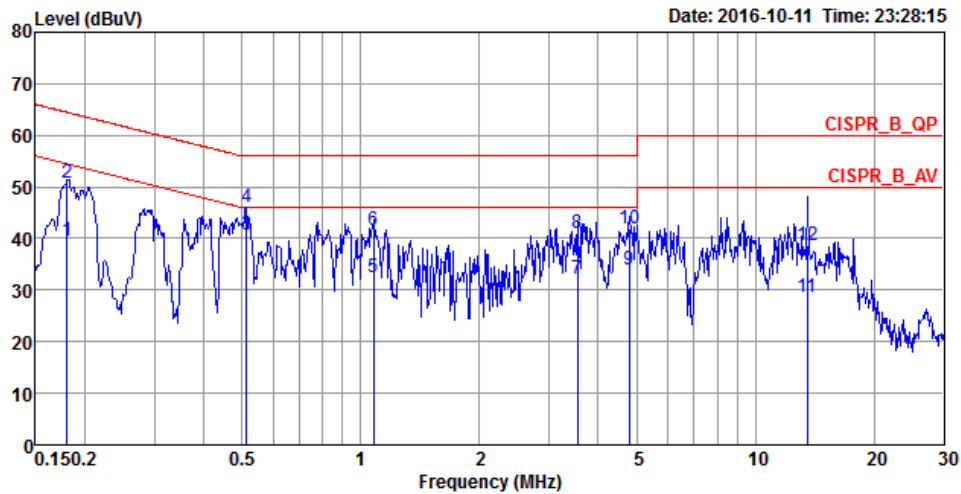

	Freq	Level	Over Limit	Limit Line	Read Level	LISN Factor	Cable Loss	Remark	Pol/Phase
	MHz	dBuV	dB	dBuV	dBuV	dB	dB		
1	0.1806	39.51	-14.95	54.46	29.38	9.95	0.18	Average	LINE
2	0.1806	50.90	-13.56	64.46	40.77	9.95	0.18	QP	LINE
3	0.5128	40.80	-5.20	46.00	30.58	10.02	0.20	Average	LINE
4	0.5128	46.04	-9.96	56.00	35.82	10.02	0.20	QP	LINE
5	1.0767	32.50	-13.50	46.00	22.25	10.05	0.20	Average	LINE
6	1.0767	41.55	-14.45	56.00	31.30	10.05	0.20	QP	LINE
7	3.5466	32.12	-13.88	46.00	21.71	10.10	0.31	Average	LINE
8	3.5466	41.17	-14.83	56.00	30.76	10.10	0.31	QP	LINE
9	4.7969	33.84	-12.16	46.00	23.38	10.12	0.34	Average	LINE
10	4.7969	42.05	-13.95	56.00	31.59	10.12	0.34	QP	LINE
11	13.5509	28.58	-21.42	50.00	17.95	10.21	0.42	Average	LINE
12	13.5509	38.57	-21.43	60.00	27.94	10.21	0.42	QP	LINE

Temperature	22°C	Humidity	52%
Test Engineer	Hank Yang	Phase	Neutral
Configuration	Normal Link	Test Mode	Mode 2

Neutral

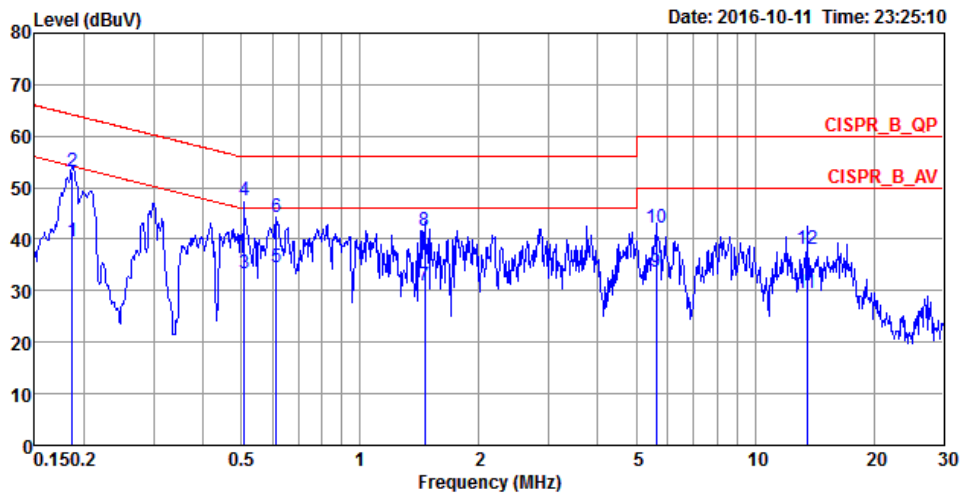

	Freq	Level	Over Limit	Limit Line	Read Level	LISN Factor	Cable Loss	Remark	Pol/Phase
	MHz	dBuV	dB	dBuV	dBuV	dB	dB		
1	0.1864	39.60	-14.60	54.20	29.46	9.96	0.18	Average	NEUTRAL
2	0.1864	53.06	-11.14	64.20	42.92	9.96	0.18	QP	NEUTRAL
3	0.5101	33.49	-12.51	46.00	23.32	9.97	0.20	Average	NEUTRAL
4	0.5101	47.40	-8.60	56.00	37.23	9.97	0.20	QP	NEUTRAL
5	0.6140	34.43	-11.57	46.00	24.26	9.97	0.20	Average	NEUTRAL
6	0.6140	44.30	-11.70	56.00	34.13	9.97	0.20	QP	NEUTRAL
7	1.4562	31.14	-14.86	46.00	20.94	9.98	0.22	Average	NEUTRAL
8	1.4562	41.65	-14.35	56.00	31.45	9.98	0.22	QP	NEUTRAL
9	5.6234	33.72	-16.28	50.00	23.31	10.07	0.34	Average	NEUTRAL
10	5.6234	42.36	-17.64	60.00	31.95	10.07	0.34	QP	NEUTRAL
11	13.5509	29.48	-20.52	50.00	18.85	10.21	0.42	Average	NEUTRAL
12	13.5509	38.22	-21.78	60.00	27.59	10.21	0.42	QP	NEUTRAL

Note: Level = Read Level + LISN Factor + Cable Loss.

## 4.2. Maximum Conducted Output Power Measurement

### 4.2.1. Limit

The limit for output power is 30dBm.

### 4.2.2. Measuring Instruments and Setting

Please refer to section 5 of equipments list in this report. The following table is the setting of the power meter.

Power Meter Parameter	Setting
Bandwidth	50MHz bandwidth is greater than the EUT emission bandwidth
Detector	Average

### 4.2.3. Test Procedures

1. Test procedures refer KDB558074 D01 v03r05 section 9.2.3.2.
2. This procedure provides an alternative for determining the RMS output power using a broadband RF average power meter with a thermocouple detector.

### 4.2.4. Test Setup Layout

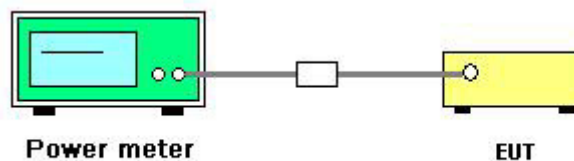

### 4.2.5. Test Deviation

There is no deviation with the original standard.

### 4.2.6. EUT Operation during Test

The EUT was programmed to be in continuously transmitting mode.

#### 4.2.7. Test Result of Maximum Conducted Output Power

<b>Temperature</b>	22°C	<b>Humidity</b>	54%
<b>Test Engineer</b>	Wen Chao	<b>Configurations</b>	GFSK
<b>Test Date</b>	Sep. 14, 2016 ~ Oct. 06, 2016		

Channel	Frequency	Conducted Power (dBm)	Max. Limit (dBm)	Result
0	2402 MHz	9.28	30.00	Complies
20	2442 MHz	9.66	30.00	Complies
39	2480 MHz	10.27	30.00	Complies

### 4.3. Power Spectral Density Measurement

#### 4.3.1. Limit

For digitally modulated systems, the power spectral density conducted from the intentional radiator to the antenna shall not be greater than 8 dBm in any 3 kHz band during any time interval of continuous transmission.

#### 4.3.2. Measuring Instruments and Setting

Please refer to section 5 of equipments list in this report. The following table is the setting of the spectrum analyzer.

Spectrum Parameter	Setting
Attenuation	Auto
Span Frequency	5-30 % greater than the DTS channel bandwidth.
RBW	$3 \text{ kHz} \leq \text{RBW} \leq 100\text{kHz}$
VBW	$\geq 3 \times \text{RBW}$
Detector	Peak
Trace	Max Hold
Sweep Time	Auto couple

#### 4.3.3. Test Procedures

1. Test was performed in accordance with KDB558074 D01 v03r05 for Performing Compliance Measurements on Digital Transmission Systems (DTS) - section 10.2 Method PKPSD (peak PSD).
2. Use this procedure when the maximum conducted output power in the fundamental emission is used to demonstrate compliance. The EUT must be configured to transmit continuously at full power over the measurement duration.
3. Ensure that the number of measurement points in the sweep  $\geq 2 \times \text{span}/\text{RBW}$  (use of a greater number of measurement points than this minimum requirement is recommended).
4. Use the peak marker function to determine the maximum level in any 3 kHz band segment within the fundamental EBW.
5. The resulting PSD level must be  $\leq 8 \text{ dBm}$ .

#### 4.3.4. Test Setup Layout

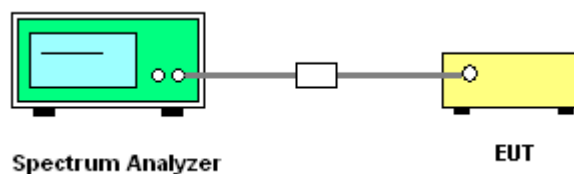

#### 4.3.5. Test Deviation

There is no deviation with the original standard.

#### 4.3.6. EUT Operation during Test

The EUT was programmed to be in continuously transmitting mode.

#### 4.3.7. Test Result of Power Spectral Density

<b>Temperature</b>	22°C	<b>Humidity</b>	54%
<b>Test Engineer</b>	Wen Chao	<b>Configurations</b>	GFSK

Channel	Frequency	Power Density (dBm/3kHz)	Power Density Limit (dBm/3kHz)	Result
0	2402 MHz	-4.83	8.00	Complies
20	2442 MHz	-5.13	8.00	Complies
39	2480 MHz	-4.26	8.00	Complies

Note: All the test values were listed in the report.

For plots, only the channel with worse result was shown.



### Power Density Plot on Configuration Bluetooth / 2480 MHz

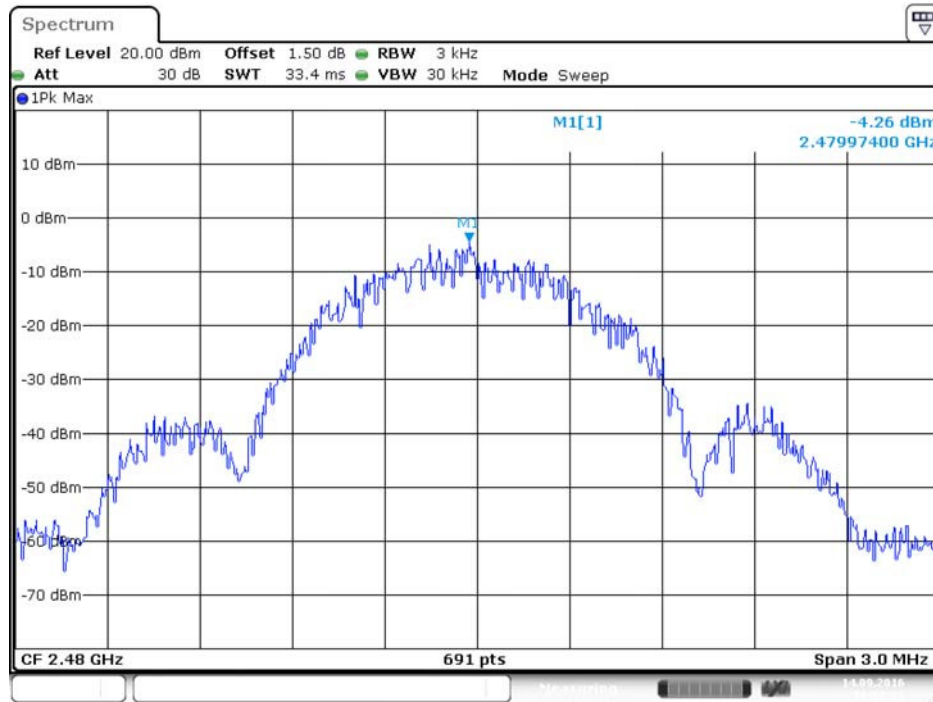

Date: 14.SEP.2016 16:38:11

## 4.4. 6dB Spectrum Bandwidth Measurement

### 4.4.1. Limit

For digital modulation systems, the minimum 6dB bandwidth shall be at least 500 kHz.

### 4.4.2. Measuring Instruments and Setting

Please refer to section 5 of equipments list in this report. The following table is the setting of the spectrum analyzer.

6dB Spectrum Bandwidth	
Spectrum Parameters	Setting
Attenuation	Auto
Span Frequency	> 6dB Bandwidth
RBW	100kHz
VBW	$\geq 3 \times \text{RBW}$
Detector	Peak
Trace	Max Hold
Sweep Time	Auto
99% Occupied Bandwidth	
Spectrum Parameters	Setting
Span	1.5 times to 5.0 times the OBW
RBW	1 % to 5 % of the OBW
VBW	$\geq 3 \times \text{RBW}$
Detector	Peak
Trace	Max Hold

### 4.4.3. Test Procedures

For Radiated 6dB Bandwidth Measurement:

1. The transmitter was radiated to the spectrum analyzer in peak hold mode.
2. Test was performed in accordance with KDB558074 D01 v03r05 for Performing Compliance Measurements on Digital Transmission Systems (DTS) - section 8.0 DTS bandwidth=> 8.1 Option 1.
3. Measured the spectrum width with power higher than 6dB below carrier.

### 4.4.4. Test Setup Layout

For Radiated 6dB Bandwidth Measurement:

This test setup layout is the same as that shown in section 4.5.4.

#### 4.4.5. Test Deviation

There is no deviation with the original standard.

#### 4.4.6. EUT Operation during Test

The EUT was programmed to be in continuously transmitting mode.

#### 4.4.7. Test Result of 6dB Spectrum Bandwidth

<b>Temperature</b>	22°C	<b>Humidity</b>	54%
<b>Test Engineer</b>	Wen Chao	<b>Configurations</b>	GFSK

Channel	Frequency	6dB Bandwidth (MHz)	99% Occupied Bandwidth (MHz)	Min. Limit (kHz)	Test Result
0	2402 MHz	0.66	1.03	500	Complies
20	2442 MHz	0.66	1.03	500	Complies
39	2480 MHz	0.66	1.03	500	Complies

Note: All the test values were listed in the report.

For plots, only the channel with worse result was shown.

### 6 dB Bandwidth Plot on Configuration Bluetooth / 2442 MHz

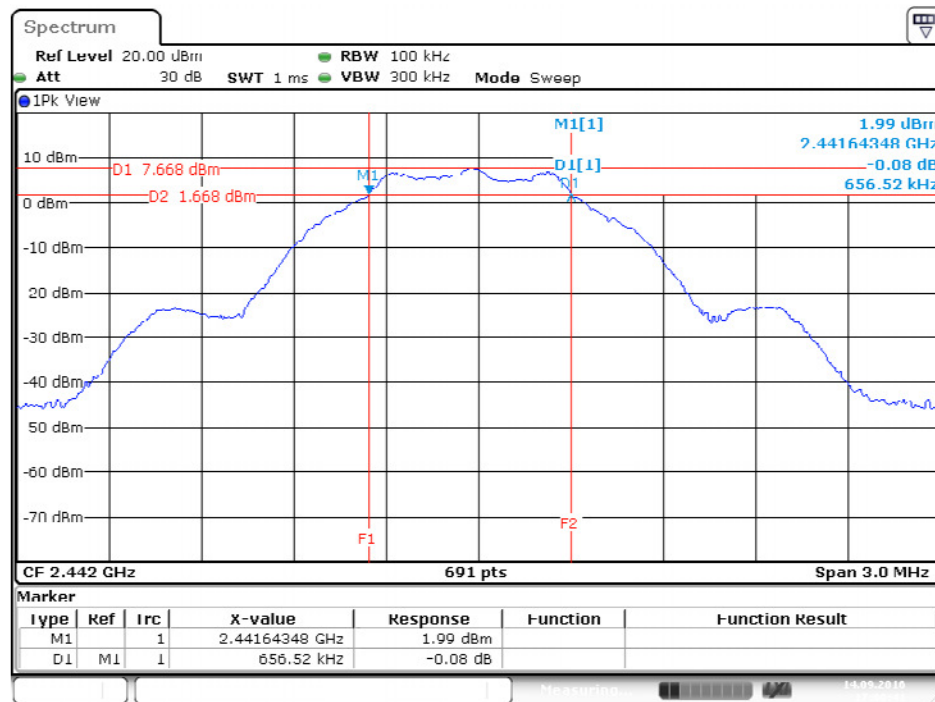

Date: 14.NOV.2016 17:00:41

### 99% Occupied Bandwidth Plot on Configuration Bluetooth / 2442 MHz

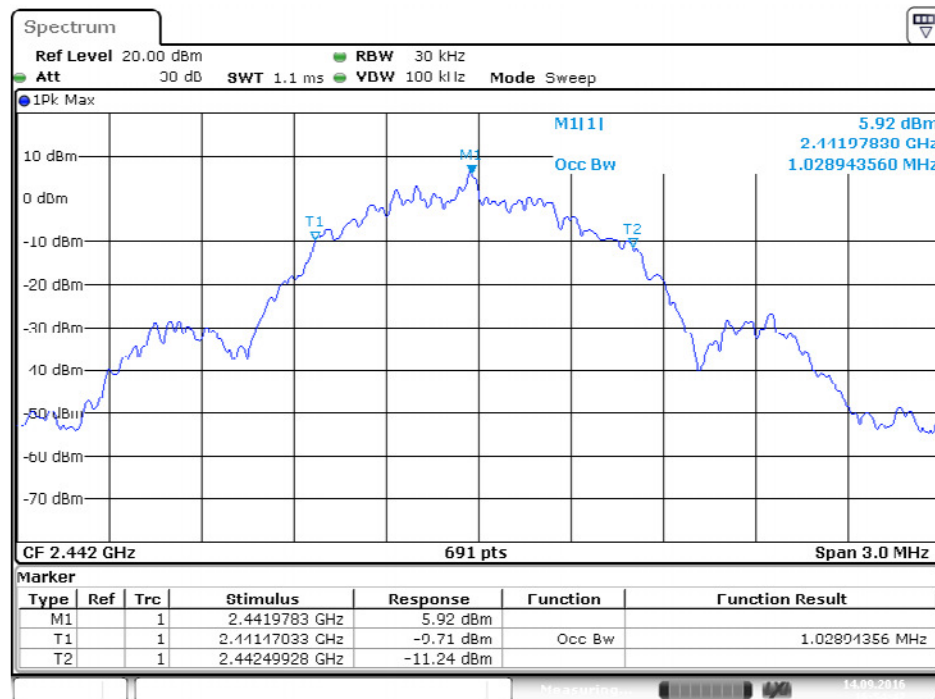

Date: 14.NOV.2016 16:54:47

## 4.5. Radiated Emissions Measurement

### 4.5.1. Limit

30dBc in any 100 kHz bandwidth outside the operating frequency band. In case the emission fall within the restricted band specified on 15.205(a), then the 15.209(a) limit in the table below has to be followed.

Frequencies (MHz)	Field Strength (micorvolts/meter)	Measurement Distance (meters)
0.009~0.490	2400/F(kHz)	300
0.490~1.705	24000/F(kHz)	30
1.705~30.0	30	30
30~88	100	3
88~216	150	3
216~960	200	3
Above 960	500	3

### 4.5.2. Measuring Instruments and Setting

Please refer to section 5 of equipments list in this report. The following table is the setting of spectrum analyzer and receiver.

Spectrum Parameter	Setting
Attenuation	Auto
Start Frequency	1000 MHz
Stop Frequency	10th carrier harmonic
RBW / VBW (Emission in restricted band)	1 MHz / 3MHz for Peak, 1 MHz / 1/T for Average
RBW / VBW (Emission in non-restricted band)	100kHz / 300kHz for peak

Receiver Parameter	Setting
Attenuation	Auto
Start ~ Stop Frequency	9kHz~150kHz / RBW 200Hz for QP
Start ~ Stop Frequency	150kHz~30MHz / RBW 9kHz for QP
Start ~ Stop Frequency	30MHz~1000MHz / RBW 120kHz for QP

#### 4.5.3. Test Procedures

1. Configure the EUT according to ANSI C63.10. The EUT was placed on the top of the turntable 1.5 meter above ground. The phase center of the receiving antenna mounted on the top of a height-variable antenna tower was placed 1m & 3m far away from the turntable.
2. Power on the EUT and all the supporting units. The turntable was rotated by 360 degrees to determine the position of the highest radiation.
3. The height of the broadband receiving antenna was varied between one meter and four meters above ground to find the maximum emissions field strength of both horizontal and vertical polarization.
4. For each suspected emissions, the antenna tower was scan (from 1 M to 4 M) and then the turntable was rotated (from 0 degree to 360 degrees) to find the maximum reading.
5. Set the test-receiver system to Peak or CISPR quasi-peak Detect Function with specified bandwidth under Maximum Hold Mode.
6. For emissions above 1GHz, use 1MHz VBW and 3MHz RBW for peak reading. Then 1MHz RBW and 1/T VBW for average reading in spectrum analyzer.
7. If the emissions level of the EUT in peak mode was 3 dB lower than the average limit specified, then testing will be stopped and peak values of EUT will be reported, otherwise, the emissions which do not have 3 dB margin will be repeated one by one using the quasi-peak method for below 1GHz.
8. For testing above 1GHz, the emissions level of the EUT in peak mode was lower than average limit (that means the emissions level in peak mode also complies with the limit in average mode), then testing will be stopped and peak values of EUT will be reported, otherwise, the emissions will be measured in average mode again and reported.
9. In case the emission is lower than 30MHz, loop antenna has to be used for measurement and the recorded data should be QP measured by receiver. High – Low scan is not required in this case.

#### 4.5.4. Test Setup Layout

For Radiated Emissions: 9kHz ~30MHz

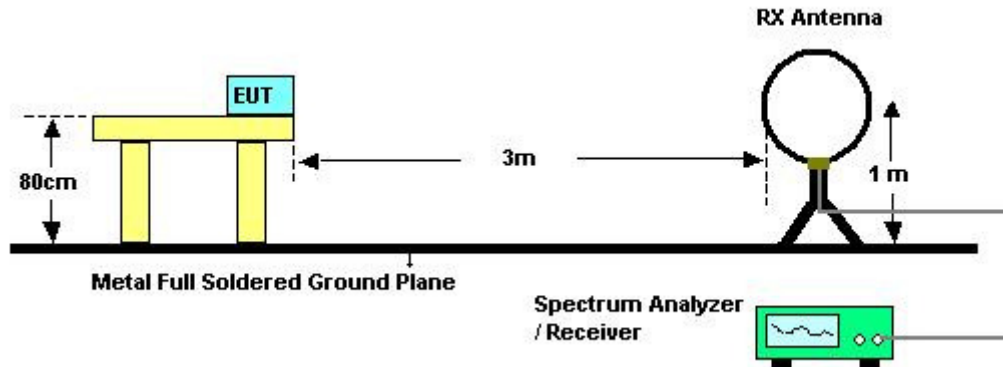

For Radiated Emissions: 30MHz~1GHz

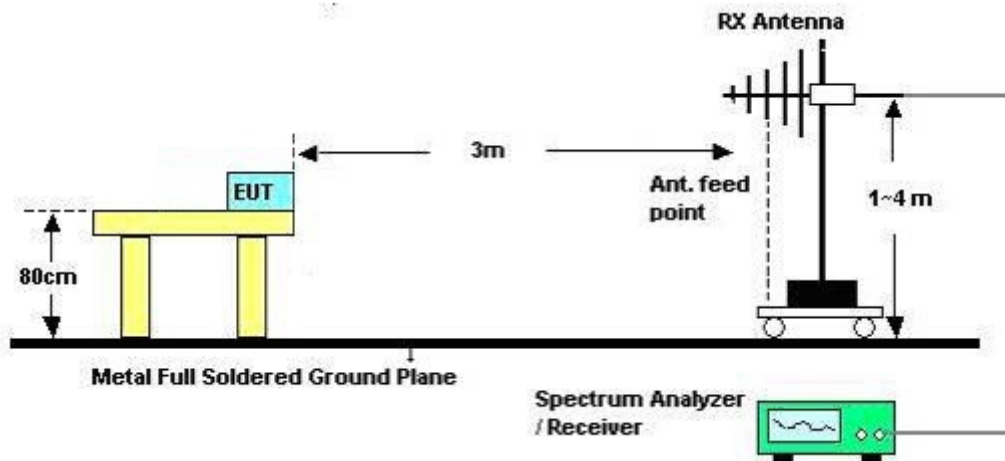



### For Radiated Emissions: Above 1GHz

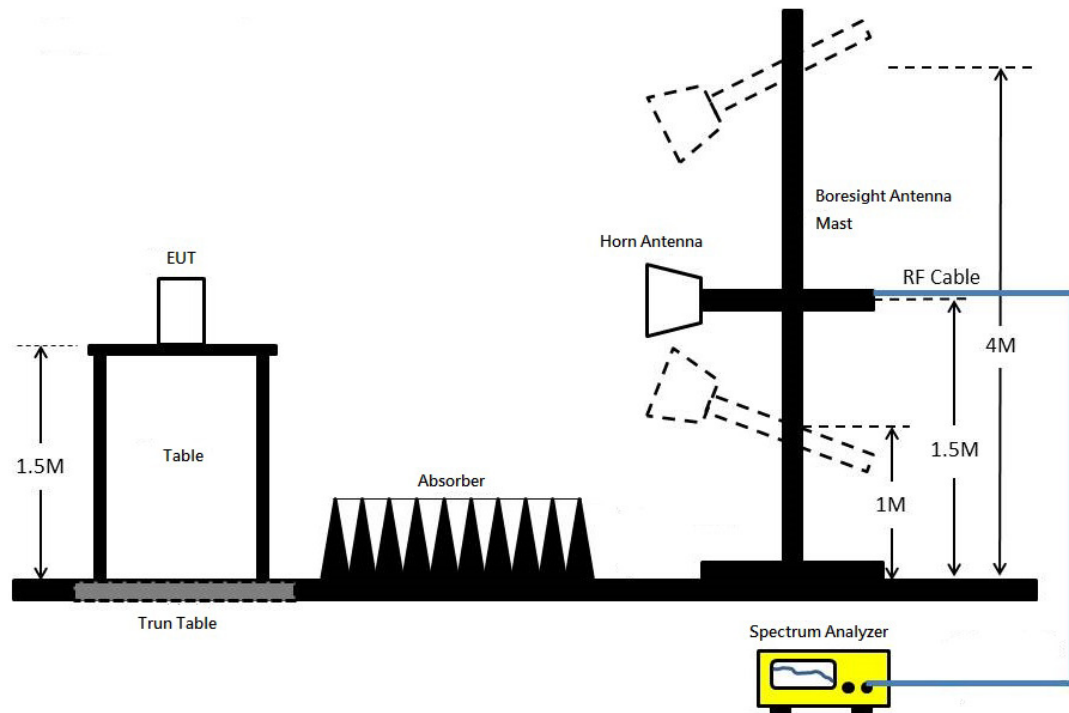

#### 4.5.5. Test Deviation

There is no deviation with the original standard.

#### 4.5.6. EUT Operation during Test

The EUT was programmed to be in continuously transmitting mode.

#### 4.5.7. Results of Radiated Emissions (9kHz~30MHz)

<b>Temperature</b>	22°C	<b>Humidity</b>	54%
<b>Test Engineer</b>	Stim Sung / Jay Lo	<b>Configurations</b>	Normal Link
<b>Test Date</b>	Sep. 22, 2016, Oct. 09, 2016	<b>Test Mode</b>	Mode 1~Mode 2

<b>Freq. (MHz)</b>	<b>Level (dBuV)</b>	<b>Over Limit (dB)</b>	<b>Limit Line (dBuV)</b>	<b>Remark</b>
-	-	-	-	See Note

Note:

The amplitude of spurious emissions that are attenuated by more than 20 dB below the permissible value has no need to be reported.

Distance extrapolation factor =  $40 \log(\text{specific distance} / \text{test distance})$  (dB);

Limit line = specific limits (dBuV) + distance extrapolation factor.

4.5.8. Results of Radiated Emissions (30MHz~1GHz)

Temperature	22°C	Humidity	54%
Test Engineer	Stim Sung/Jay Lo	Configurations	Normal Link
Test Mode	Mode 1		

Horizontal

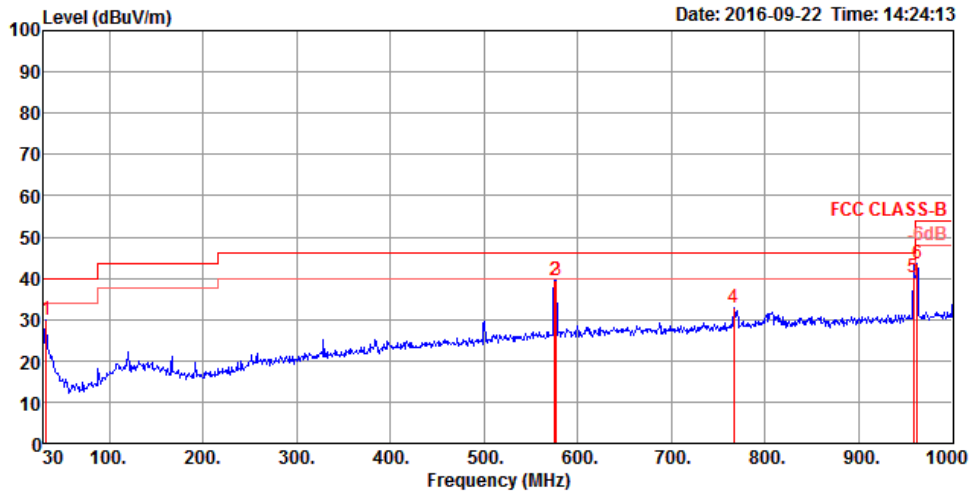

	Freq	Level	Limit	Over	Read	CableAntenna	Preamp	A/Pos	T/Pos	Remark	Pol/Phase
	MHz	dBuV/m	dBuV/m	dB	dBuV	dB	dB/m	dB	cm	deg	
1	32.91	29.78	40.00	-10.22	37.91	0.54	24.24	32.91	100	358 Peak	HORIZONTAL
2	575.14	39.54	46.00	-6.46	44.47	2.36	25.10	32.39	100	212 Peak	HORIZONTAL
3	577.08	39.61	46.00	-6.39	44.52	2.36	25.12	32.39	100	212 Peak	HORIZONTAL
4	766.23	32.77	46.00	-13.23	35.67	2.82	26.53	32.25	150	95 Peak	HORIZONTAL
5	958.29	40.29	46.00	-5.71	40.19	3.02	28.20	31.12	200	78 QP	HORIZONTAL
6	962.17	43.62	54.00	-10.38	43.44	3.03	28.23	31.08	200	63 Peak	HORIZONTAL

**Vertical**

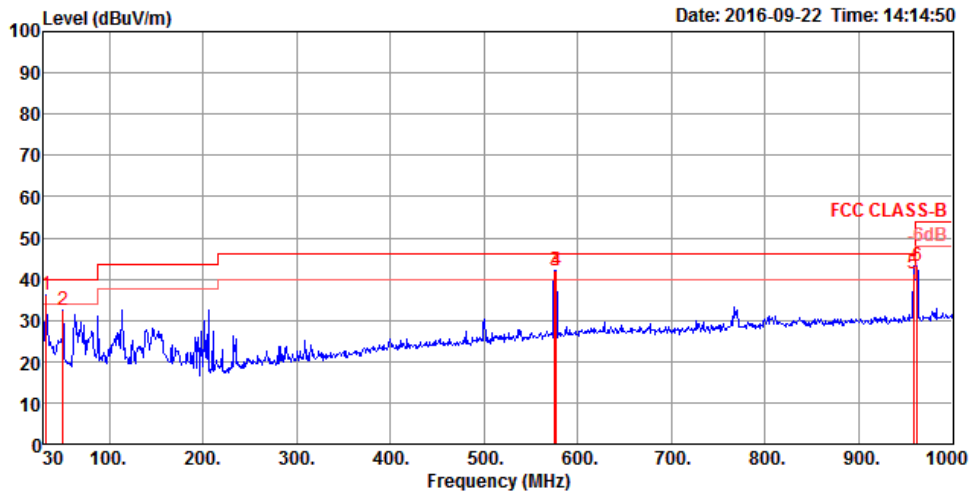

	Freq	Level	Limit	Over	Read	CableAntenna	Preamp	A/Pos	T/Pos	Remark	Pol/Phase
	MHz	dBuV/m	dBuV/m	dB	dBuV	dB	dB/m	dB	cm	deg	
1	32.91	36.24	40.00	-3.76	44.37	0.54	24.24	32.91	150	126 Peak	VERTICAL
2	50.37	32.35	40.00	-7.65	49.20	0.68	14.85	32.38	100	215 Peak	VERTICAL
3	575.14	42.04	46.00	-3.96	46.97	2.36	25.10	32.39	150	134 Peak	VERTICAL
4	577.08	42.16	46.00	-3.84	47.07	2.36	25.12	32.39	125	166 Peak	VERTICAL
5	958.29	41.15	46.00	-4.85	41.05	3.02	28.20	31.12	112	142 QP	VERTICAL
6	962.17	43.22	54.00	-10.78	43.04	3.03	28.23	31.08	150	232 Peak	VERTICAL

Temperature	22°C	Humidity	54%
Test Engineer	Stim Sung/Jay Lo	Configurations	Normal Link
Test Mode	Mode 2		

**Horizontal**

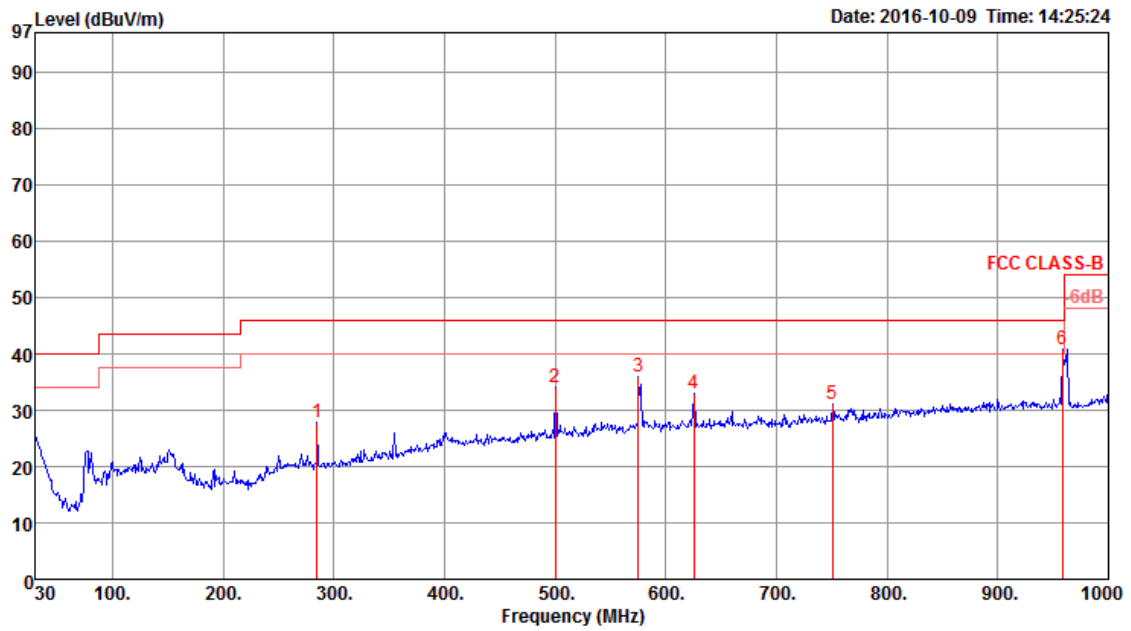

	Freq	Level	Limit	Over	Read	CableAntenna	Preamp	A/Pos	T/Pos	Remark	Pol/Phase
	MHz	dBuV/m	dBuV/m	dB	dBuV	dB	dB/m	dB	cm	deg	
1	285.11	27.77	46.00	-18.23	36.12	1.63	19.35	29.33	125	137 Peak	HORIZONTAL
2	500.45	34.05	46.00	-11.95	37.42	2.17	23.92	29.46	150	28 Peak	HORIZONTAL
3	575.14	35.97	46.00	-10.03	38.11	2.33	24.80	29.27	200	214 Peak	HORIZONTAL
4	625.58	32.90	46.00	-13.10	34.39	2.44	25.21	29.14	100	304 Peak	HORIZONTAL
5	750.71	31.08	46.00	-14.92	30.89	2.70	26.30	28.81	125	264 Peak	HORIZONTAL
6	958.29	40.85	46.00	-5.15	37.51	3.05	27.84	27.55	100	197 Peak	HORIZONTAL

**Vertical**

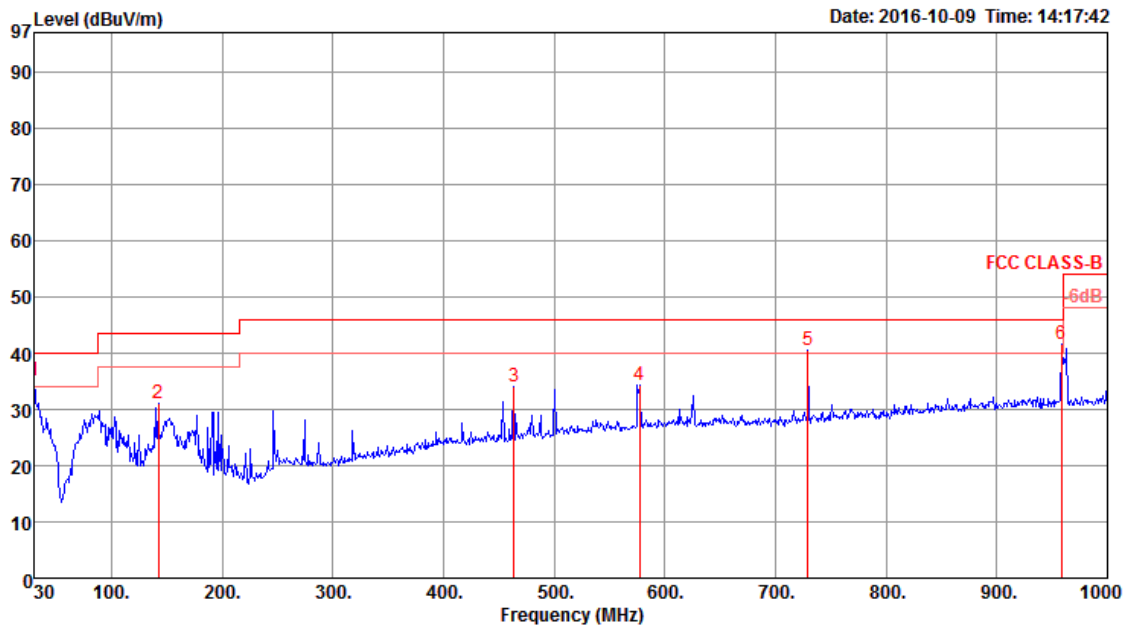

	Freq	Level	Limit	Over	Read	Cable	Antenna	Preamp	A/Pos	T/Pos	Remark	Pol/Phase
	MHz	dBuV/m	dBuV/m	dB	dBuV	dB	dB/m	dB	cm	deg		
1	30.00	35.06	40.00	-4.94	38.60	0.56	25.50	29.60	100	249	Peak	VERTICAL
2	142.52	31.05	43.50	-12.45	41.63	1.16	17.40	29.14	125	355	Peak	VERTICAL
3	463.59	34.08	46.00	-11.92	38.00	2.09	23.34	29.35	125	99	Peak	VERTICAL
4	577.08	34.43	46.00	-11.57	36.54	2.34	24.82	29.27	200	265	Peak	VERTICAL
5	729.37	40.43	46.00	-5.57	40.63	2.65	26.02	28.87	150	278	Peak	VERTICAL
6	958.29	41.74	46.00	-4.26	38.40	3.05	27.84	27.55	100	115	Peak	VERTICAL

**Note:**

The amplitude of spurious emissions which are attenuated by more than 20 dB below the permissible value has no need to be reported.

Emission level (dBuV/m) = 20 log Emission level (uV/m).

Corrected Reading: Antenna Factor + Cable Loss + Read Level - Preamp Factor = Level.

#### 4.5.9. Results for Radiated Emissions (1GHz~10<sup>th</sup> Harmonic)

<b>Temperature</b>	22°C	<b>Humidity</b>	54%
<b>Test Engineer</b>	Stim Sung/Jay Lo	<b>Configurations</b>	Channel 0
<b>Test Date</b>	Sep. 16, 2016 ~ Sep. 22, 2016		

##### Horizontal

	Freq	Level	Limit Line	Over Limit	Read Level	CableAntenna Loss	Antenna Factor	Preamp Factor	A/Pos	T/Pos	Remark	Pol/Phase
	MHz	dBuV/m	dBuV/m	dB	dBuV	dB	dB/m	dB	cm	deg		
1	4803.43	49.20	74.00	-24.80	42.80	6.26	33.08	32.94	210	271	Peak	HORIZONTAL
2	4803.78	39.21	54.00	-14.79	32.81	6.26	33.08	32.94	210	271	Average	HORIZONTAL

##### Vertical

	Freq	Level	Limit Line	Over Limit	Read Level	CableAntenna Loss	Antenna Factor	Preamp Factor	A/Pos	T/Pos	Remark	Pol/Phase
	MHz	dBuV/m	dBuV/m	dB	dBuV	dB	dB/m	dB	cm	deg		
1	4803.37	49.16	74.00	-24.84	42.76	6.26	33.08	32.94	113	188	Peak	VERTICAL
2	4803.92	38.77	54.00	-15.23	32.37	6.26	33.08	32.94	113	188	Average	VERTICAL

<b>Temperature</b>	22°C	<b>Humidity</b>	54%
<b>Test Engineer</b>	Stim Sung/Jay Lo	<b>Configurations</b>	Channel 20
<b>Test Date</b>	Sep. 16, 2016 ~ Sep. 22, 2016		

### Horizontal

	Freq	Level	Limit Line	Over Limit	Read Level	CableAntenna Loss	Antenna Factor	Preamp Factor	A/Pos	T/Pos	Remark	Pol/Phase
	MHz	dBuV/m	dBuV/m	dB	dBuV	dB	dB/m	dB	cm	deg		
1	4883.90	40.41	54.00	-13.59	33.80	6.28	33.26	32.93	227	269	Average	HORIZONTAL
2	4884.32	49.84	74.00	-24.16	43.23	6.28	33.26	32.93	227	269	Peak	HORIZONTAL

### Vertical

	Freq	Level	Limit Line	Over Limit	Read Level	CableAntenna Loss	Antenna Factor	Preamp Factor	A/Pos	T/Pos	Remark	Pol/Phase
	MHz	dBuV/m	dBuV/m	dB	dBuV	dB	dB/m	dB	cm	deg		
1	4883.41	49.10	74.00	-24.90	42.49	6.28	33.26	32.93	110	33	Peak	VERTICAL
2	4883.75	38.89	54.00	-15.11	32.28	6.28	33.26	32.93	110	33	Average	VERTICAL



<b>Temperature</b>	22°C	<b>Humidity</b>	54%
<b>Test Engineer</b>	Stim Sung/Jay Lo	<b>Configurations</b>	Channel 39
<b>Test Date</b>	Sep. 16, 2016 ~ Sep. 22, 2016		

#### Horizontal

	Freq	Level	Limit Line	Over Limit	Read Level	CableAntenna Loss	Antenna Factor	Preamp Factor	A/Pos	T/Pos	Remark	Pol/Phase
	MHz	dBuV/m	dBuV/m	dB	dBuV	dB	dB/m	dB	cm	deg		
1	4959.80	43.18	54.00	-10.82	36.38	6.30	33.41	32.91	233	268	Average	HORIZONTAL
2	4959.91	51.35	74.00	-22.65	44.55	6.30	33.41	32.91	233	268	Peak	HORIZONTAL

#### Vertical

	Freq	Level	Limit Line	Over Limit	Read Level	CableAntenna Loss	Antenna Factor	Preamp Factor	A/Pos	T/Pos	Remark	Pol/Phase
	MHz	dBuV/m	dBuV/m	dB	dBuV	dB	dB/m	dB	cm	deg		
1	4959.50	50.21	74.00	-23.79	43.41	6.30	33.41	32.91	127	29	Peak	VERTICAL
2	4959.92	40.43	54.00	-13.57	33.63	6.30	33.41	32.91	127	29	Average	VERTICAL

#### Note:

The amplitude of spurious emissions that are attenuated by more than 20dB below the permissible value has no need to be reported.

Emission level (dBuV/m) = 20 log Emission level (uV/m).

Corrected Reading: Antenna Factor + Cable Loss + Read Level - Preamp Factor = Level.

## 4.6. Emissions Measurement

### 4.6.1. Limit

30dBc in any 100 kHz bandwidth outside the operating frequency band. In case the emission fall within the restricted band specified on 15.205(a), then the 15.209(a) limit in the table below has to be followed.

Frequencies (MHz)	Field Strength (micorvolts/meter)	Measurement Distance (meters)
0.009~0.490	2400/F(kHz)	300
0.490~1.705	24000/F(kHz)	30
1.705~30.0	30	30
30~88	100	3
88~216	150	3
216~960	200	3
Above 960	500	3

### 4.6.2. Measuring Instruments and Setting

Please refer to section 5 of equipments list in this report. The following table is the setting of the spectrum analyzer.

Spectrum Parameter	Setting
Attenuation	Auto
Span Frequency	100 MHz
RBW / VBW (Emission in restricted band)	1MHz / 3MHz for Peak, 1MHz / 1/T for Average
RBW / VBW (30dBc in any 100 kHz bandwidth emission)	100 kHz / 300 kHz for Peak

### 4.6.3. Test Procedures

#### For Radiated band edges Measurement:

1. The test procedure is the same as section 4.5.3.

#### For Radiated Out of Band Emission Measurement:

1. Test was performed in accordance with KDB558074 D01 v03r05 for Performing Compliance Measurements on Digital Transmission Systems (DTS) Operating Under §15.247 section 11.0 Unwanted Emissions into Non-Restricted Frequency Bands Measurement Procedure.

#### **4.6.4. Test Setup Layout**

For Radiated band edges Measurement:

This test setup layout is the same as that shown in section 4.5.4.

For Radiated Out of Band Emission Measurement:

This test setup layout is the same as that shown in section 4.5.4.

#### **4.6.5. Test Deviation**

There is no deviation with the original standard.

#### **4.6.6. EUT Operation during Test**

The EUT was programmed to be in continuously transmitting mode.

4.6.7. Test Result of Band Edge and Fundamental Emissions

Temperature	22°C	Humidity	54%
Test Engineer	Stim Sung/Jay Lo	Configurations	Channel 0, 20, 39

Channel 0

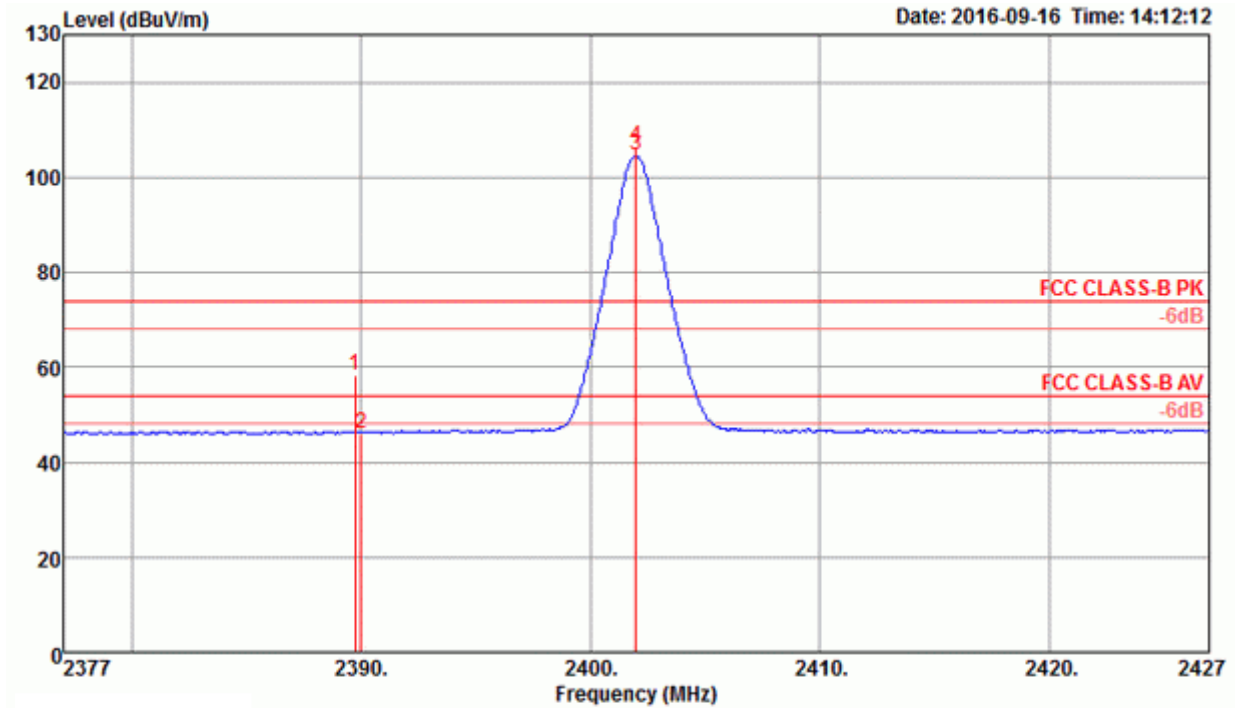

	Freq	Level	Limit Line	Over Limit	Read Level	CableAntenna Loss	Preamp Factor	A/Pos	T/Pos	Remark	Pol/Phase
	MHz	dBUV/m	dBUV/m	dB	dBUV	dB	dB/m	dB	cm	deg	
1	2389.74	58.36	74.00	-15.64	26.45	3.60	28.31	0.00	252	274 Peak	HORIZONTAL
2	2390.00	46.12	54.00	-7.88	14.21	3.60	28.31	0.00	252	274 Average	HORIZONTAL
3 @	2402.00	104.48			72.53	3.61	28.34	0.00	252	274 Average	HORIZONTAL
4 @	2402.00	106.34			74.39	3.61	28.34	0.00	252	274 Peak	HORIZONTAL

Item 3, 4 are the fundamental frequency at 2402 MHz.

Channel 20

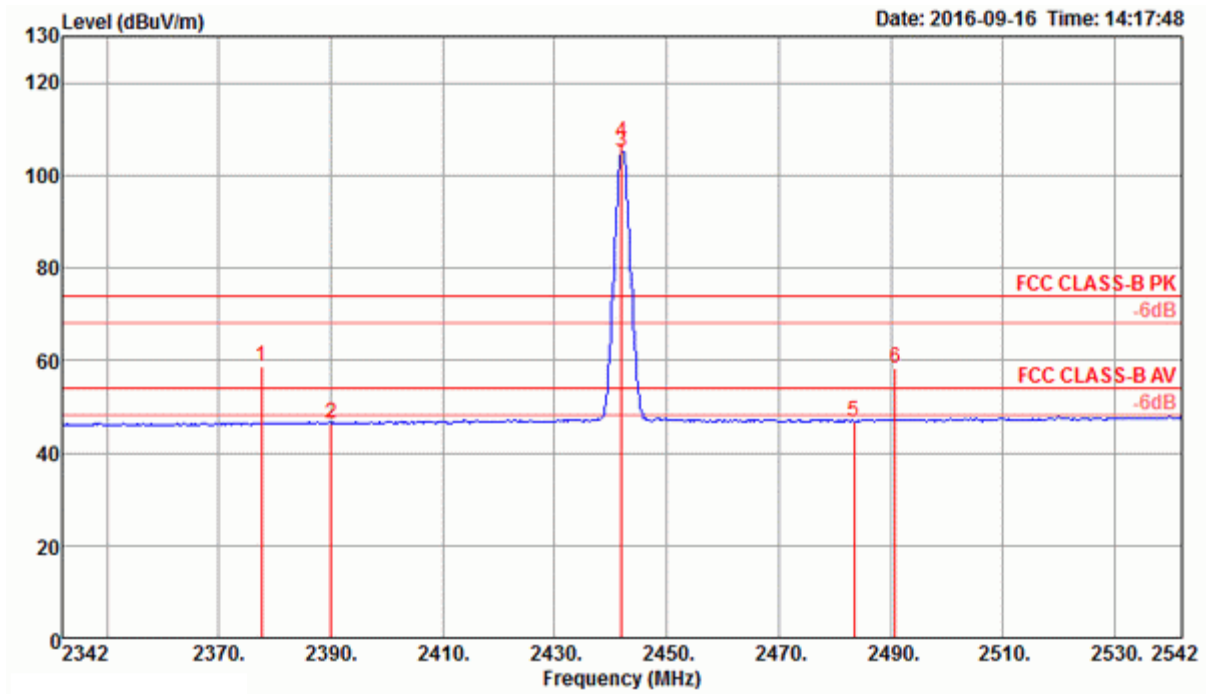

	Freq	Level	Limit	Over	Read	CableAntenna	Preamp	A/Pos	T/Pos	Remark	Pol/Phase
	MHz	dBuV/m	dBuV/m	dB	dBuV	dB	dB/m	dB	cm	deg	
1	2377.58	58.84	74.00	-15.16	26.95	3.59	28.30	0.00	274	272 Peak	HORIZONTAL
2	2390.00	46.43	54.00	-7.57	14.52	3.60	28.31	0.00	274	272 Average	HORIZONTAL
3 @	2442.00	105.16			73.11	3.64	28.41	0.00	274	272 Average	HORIZONTAL
4 @	2442.00	107.02			74.97	3.64	28.41	0.00	274	272 Peak	HORIZONTAL
5	2483.50	46.87	54.00	-7.13	14.71	3.68	28.48	0.00	274	272 Average	HORIZONTAL
6	2490.87	58.45	74.00	-15.55	26.28	3.68	28.49	0.00	274	272 Peak	HORIZONTAL

Item 3, 4 are the fundamental frequency at 2442 MHz.

Channel 39

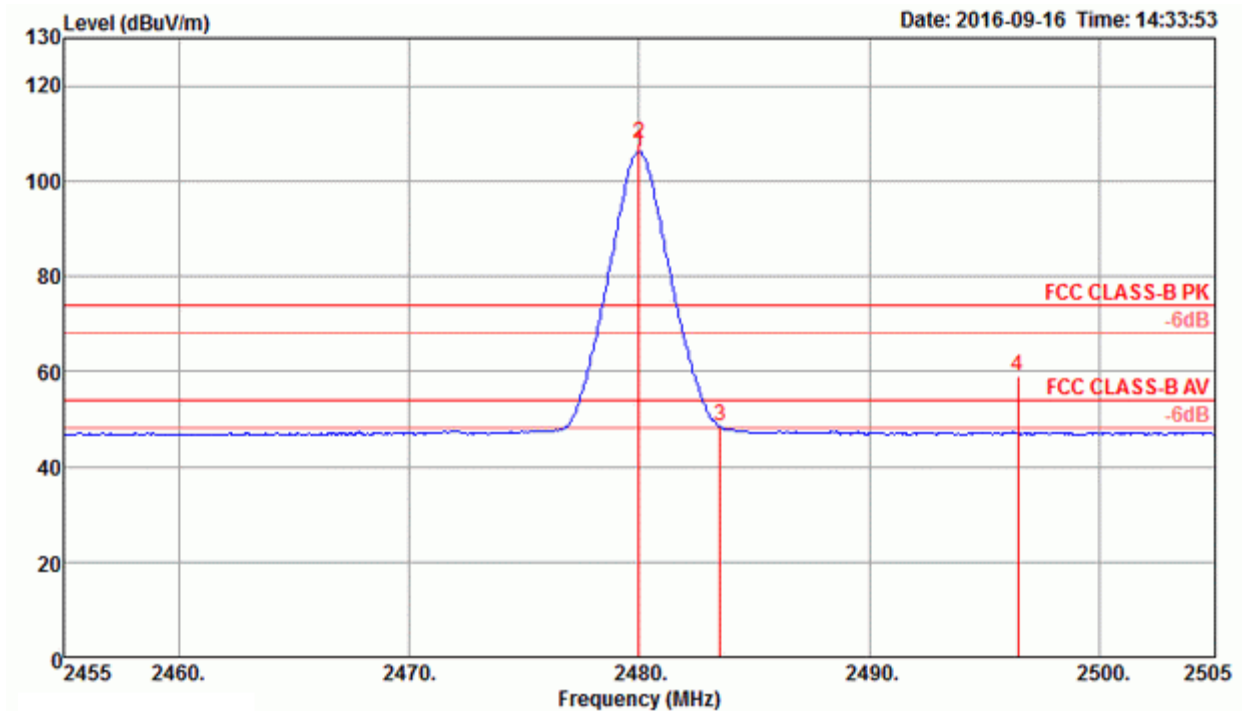

	Freq	Level	Limit	Over	Read	CableAntenna	Preamp	A/Pos	T/Pos	Remark	Pol/Phase
	MHz	dBUV/m	dBUV/m	dB	dBuV	dB	dB/m	dB	cm	deg	
1 @	2480.00	106.08			73.95	3.67	28.46	0.00	265	278 Average	HORIZONTAL
2 @	2480.00	107.98			75.85	3.67	28.46	0.00	265	278 Peak	HORIZONTAL
3	2483.50	48.52	54.00	-5.48	16.36	3.68	28.48	0.00	265	278 Average	HORIZONTAL
4	2496.43	59.04	74.00	-14.96	26.85	3.69	28.50	0.00	265	278 Peak	HORIZONTAL

Item 1, 2 are the fundamental frequency at 2480 MHz.

Note:

Emission level (dBUV/m) = 20 log Emission level (uV/m).

Corrected Reading: Antenna Factor + Cable Loss + Read Level - Preamp Factor = Level.

**For Emission not in Restricted Band**  
**Plot on Configuration / Reference Level**

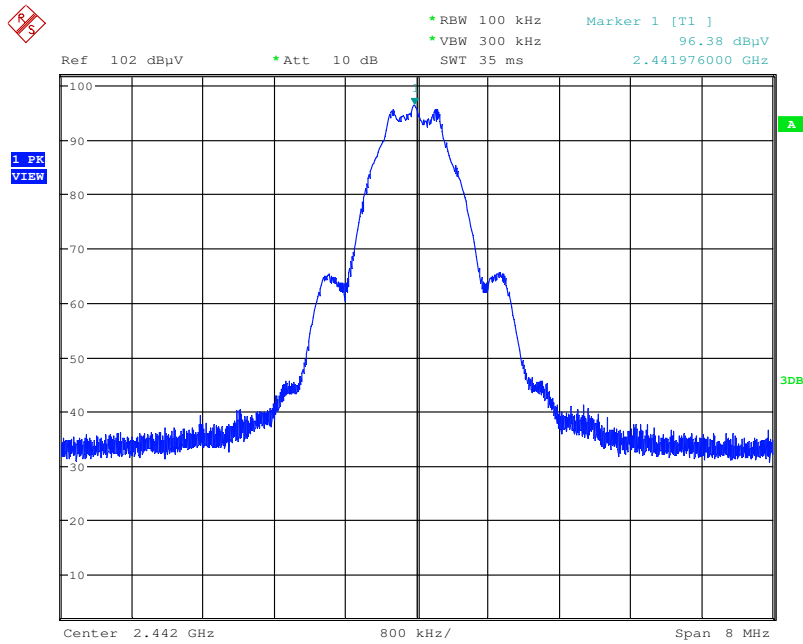

Date: 16.SEP.2016 16:12:23

**Plot on Configuration For Bluetooth 4.0 / Channel 0 / 30MHz~2400MHz (down 30dBc)**

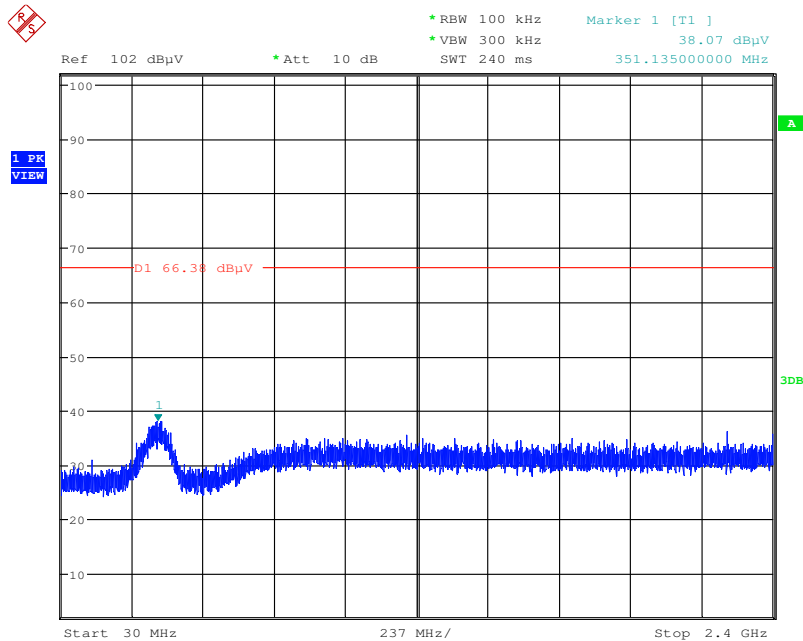

Date: 16.SEP.2016 16:21:11

Plot on Configuration For Bluetooth 4.0 / Channel 0 / 2483.5MHz~26500MHz (down 30dBc)

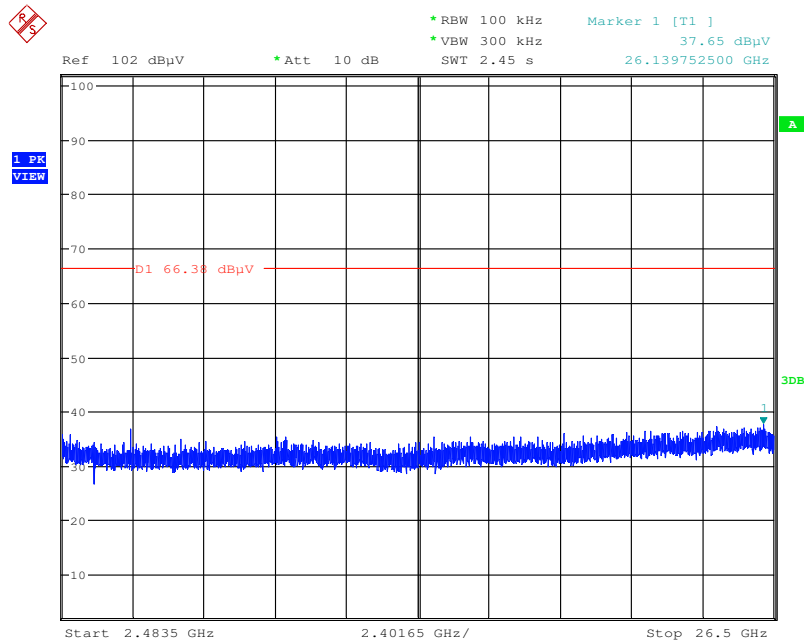

Date: 16.SEP.2016 16:21:52

Plot on Configuration For Bluetooth 4.0 / Channel 39 / 30MHz~2400MHz (down 30dBc)

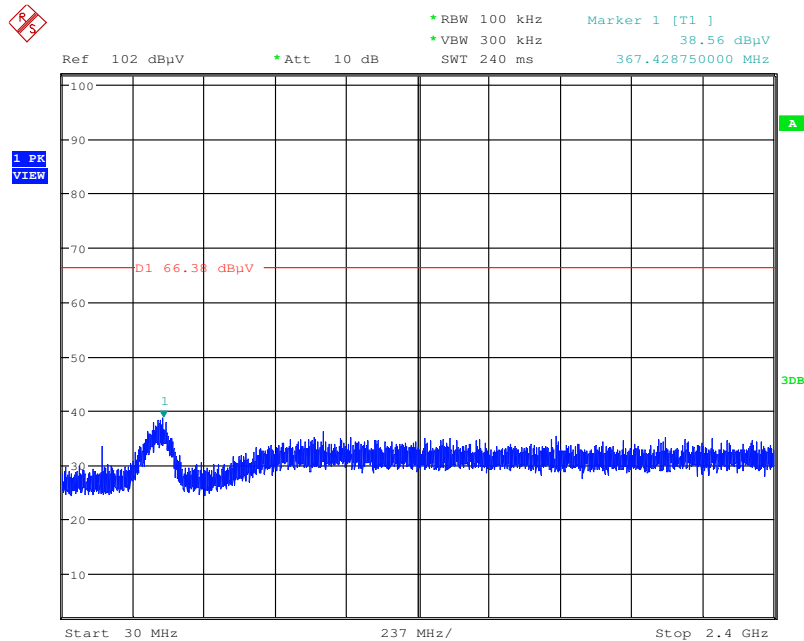

Date: 16.SEP.2016 16:20:08



Plot on Configuration For Bluetooth 4.0 / Channel 39 / 2483.5MHz~26500MHz (down 30dBc)

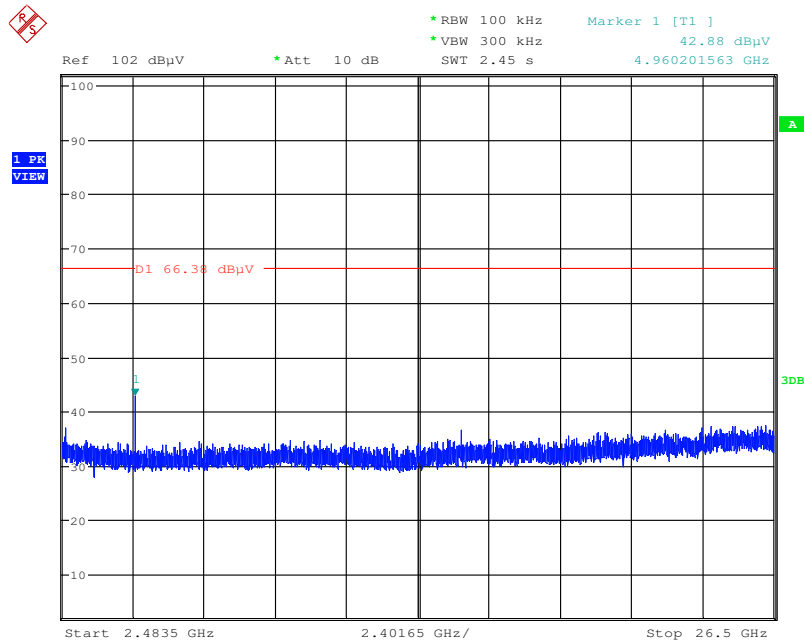

Date: 16.SEP.2016 16:18:50

## 4.7. Antenna Requirements

### 4.7.1. Limit

Except for special regulations, the Low-power Radio-frequency Devices must not be equipped with any jacket for installing an antenna with extension cable. An intentional radiator shall be designed to ensure that no antenna other than that furnished by the responsible party shall be used with the device. The use of a permanently attached antenna or of an antenna that uses a unique coupling to the intentional radiator shall be considered sufficient to comply with the provisions of this Section. The manufacturer may design the unit so that the user can replace a broken antenna, but the use of a standard antenna jack or electrical connector is prohibited. Further, this requirement does not apply to intentional radiators that must be professionally installed.

### 4.7.2. Antenna Connector Construction

Please refer to section 3.3 in this test report; antenna connector complied with the requirements.

## 5. LIST OF MEASURING EQUIPMENTS

Instrument	Manufacturer	Model No.	Serial No.	Characteristics	Calibration Date	Remark
EMI Receiver	Agilent	N9038A	My52260123	9kHz ~ 8.45GHz	Jan. 27, 2016	Conduction (CO01-CB)
LISN	F.C.C.	FCC-LISN-50-16-2	04083	150kHz ~ 100MHz	Dec. 08, 2015	Conduction (CO01-CB)
LISN	Schwarzbeck	NSLK 8127	8127647	9kHz ~ 30MHz	Dec. 23, 2015	Conduction (CO01-CB)
COND Cable	Woken	Cable	01	150kHz ~ 30MHz	May 24, 2016	Conduction (CO01-CB)
Software	Audix	E3	6.120210n	-	N.C.R.	Conduction (CO01-CB)
BILOG ANTENNA	TESEQ	CBL6112D	37880	20MHz ~ 2GHz	Aug. 30, 2016	Radiation (O3CH01-CB)
Loop Antenna	Teseq	HLA 6120	24155	9kHz - 30 MHz	Mar. 16, 2016*	Radiation (O3CH01-CB)
Horn Antenna	EMCO	3115	00075790	750MHz ~ 18GHz	Oct. 22, 2015	Radiation (O3CH01-CB)
Horn Antenna	Schwarzbeck	BBHA 9170	BBHA9170252	15GHz ~ 40GHz	Jul. 25, 2016	Radiation (O3CH01-CB)
Pre-Amplifier	Agilent	8447D	2944A10991	0.1MHz ~ 1.3GHz	Mar. 15, 2016	Radiation (O3CH01-CB)
Pre-Amplifier	Agilent	8449B	3008A02310	1GHz ~ 26.5GHz	Jan. 18, 2016	Radiation (O3CH01-CB)
Spectrum Analyzer	R&S	FSP40	100056	9kHz ~ 40GHz	Oct. 27, 2015	Radiation (O3CH01-CB)
EMI Test	R&S	ESCS	100355	9kHz ~ 2.75GHz	May 16, 2016	Radiation (O3CH01-CB)
RF Cable-low	Woken	Low Cable-1	N/A	30 MHz ~ 1 GHz	Nov. 02, 2015	Radiation (O3CH01-CB)
RF Cable-high	Woken	High Cable-16	N/A	1 GHz ~ 18 GHz	Nov. 02, 2015	Radiation (O3CH01-CB)
RF Cable-high	Woken	High Cable-17	N/A	1 GHz ~ 18 GHz	Nov. 02, 2015	Radiation (O3CH01-CB)
RF Cable-high	Woken	High Cable-40G-1	N/A	18GHz ~ 40 GHz	Nov. 02, 2015	Radiation (O3CH01-CB)
RF Cable-high	Woken	High Cable-40G-2	N/A	18GHz ~ 40 GHz	Nov. 02, 2015	Radiation (O3CH01-CB)
Test Software	Audix	E3	6.2009-10-7	N/A	N/A	Radiation (O3CH01-CB)
Spectrum analyzer	R&S	FSV40	100979	9kHz~40GHz	Dec. 09, 2015	Conducted (TH01-CB)
RF Cable-high	Woken	RG402	High Cable-6	1 GHz – 26.5 GHz	Nov. 02, 2015	Conducted (TH01-CB)
RF Cable-high	Woken	RG402	High Cable-7	1 GHz – 26.5 GHz	Nov. 02, 2015	Conducted (TH01-CB)
RF Cable-high	Woken	RG402	High Cable-8	1 GHz – 26.5 GHz	Nov. 02, 2015	Conducted (TH01-CB)
RF Cable-high	Woken	RG402	High Cable-9	1 GHz – 26.5 GHz	Nov. 02, 2015	Conducted (TH01-CB)
RF Cable-high	Woken	RG402	High Cable-10	1 GHz – 26.5 GHz	Nov. 02, 2015	Conducted (TH01-CB)
Power Sensor	Agilent	U2021XA	MY53410001	50MHz~18GHz	Nov. 02, 2015	Conducted (TH01-CB)

Note: Calibration Interval of instruments listed above is one year.

\*Calibration Interval of instruments listed above is two years.

N.C.R. means Non-Calibration required.

## 6. MEASUREMENT UNCERTAINTY

Test Items	Uncertainty	Remark
Conducted Emission (150kHz ~ 30MHz)	3.2 dB	Confidence levels of 95%
Radiated Emission (30MHz ~ 1,000MHz)	3.6 dB	Confidence levels of 95%
Radiated Emission (1GHz ~ 18GHz)	3.7 dB	Confidence levels of 95%
Radiated Emission (18GHz ~ 40GHz)	3.5 dB	Confidence levels of 95%
Conducted Emission	1.7 dB	Confidence levels of 95%