

# ENGINEERING TEST REPORT

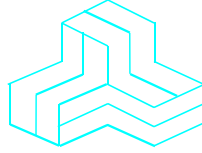

**H840 DEVICE**  
**Model: H2G2-42**  
**FCC ID: A4RH2G2-42**

*Applicant:*

**Google Inc.**  
1600 Amphitheatre Parkway.  
Mountain View, California 94043  
USA

***In Accordance With***

**Federal Communications Commission (FCC)  
Part 15, Subpart C, Section 15.247 Digital Modulation Systems (DTS)**

**UltraTech's File No.: FLC-007F15C247**

This Test report is Issued under the Authority of  
Tri M. Luu  
Vice President of Engineering  
UltraTech Group of Labs

Date: March 26, 2013

Report Prepared by: Dan Huynh

Tested by: Mr. Hung Trinh

Issued Date: March 26, 2013

Test Dates: March 14-21, 2013

*The results in this Test Report apply only to the sample(s) tested, and the sample tested is randomly selected.  
This report must not be used by the client to claim product endorsement by NVLAP or any agency of the US Government.*

## UltraTech

3000 Bristol Circle, Oakville, Ontario, Canada, L6H 6G4  
Tel.: (905) 829-1570 Fax.: (905) 829-8050  
Website: [www.ultratech-labs.com](http://www.ultratech-labs.com), Email: [vic@ultratech-labs.com](mailto:vic@ultratech-labs.com), Email: [tri@ultratech-labs.com](mailto:tri@ultratech-labs.com)

FCC

91038



1309



46390-2049



NVLAP LAB CODE 200093-0



SL2-IN-E-1119R



Korea KCC-RRL

CA2049

**TABLE OF CONTENTS**

**EXHIBIT 1. INTRODUCTION ..... 1**

1.1. SCOPE..... 1

1.2. RELATED SUBMITTAL(S)/GRANT(S) ..... 1

1.3. NORMATIVE REFERENCES ..... 1

**EXHIBIT 2. PERFORMANCE ASSESSMENT ..... 2**

2.1. CLIENT INFORMATION ..... 2

2.2. EQUIPMENT UNDER TEST (EUT) INFORMATION..... 2

2.3. PRIMARY USER FUNCTIONS OF EUT ..... 2

2.4. EUT’S TECHNICAL SPECIFICATIONS ..... 3

2.5. LIST OF ACCESSORY DEVICES ..... 3

2.6. LIST OF EUT’S PORTS ..... 3

2.7. ANCILLARY EQUIPMENT ..... 4

**EXHIBIT 3. EUT OPERATING CONDITIONS AND CONFIGURATIONS DURING TESTS ..... 5**

3.1. CLIMATE TEST CONDITIONS ..... 5

3.2. OPERATIONAL TEST CONDITIONS & ARRANGEMENT FOR TESTS ..... 5

**EXHIBIT 4. SUMMARY OF TEST RESULTS ..... 6**

4.1. LOCATION OF TESTS ..... 6

4.2. APPLICABILITY & SUMMARY OF EMC EMISSION TEST RESULTS ..... 6

4.3. MODIFICATIONS INCORPORATED IN THE EUT FOR COMPLIANCE PURPOSES ..... 6

**EXHIBIT 5. TEST DATA..... 7**

5.1. POWER LINE CONDUCTED EMISSIONS [§15.207(A)] ..... 7

5.2. OCCUPIED BANDWIDTH [§ 15.247(A)(2)] ..... 10

5.3. PEAK CONDUCTED OUTPUT POWER - DTS [§ 15.247(B)(3)] ..... 75

5.4. TRANSMITTER BAND-EDGE & SPURIOUS CONDUCTED EMISSIONS [§ 15.247(D)] ..... 77

5.5. TRANSMITTER RADIATED BAND-EDGE & SPURIOUS RADIATED EMISSIONS AT 3 METERS [§ 15.247(D), 15.209 & 15.205] ..... 102

5.6. POWER SPECTRAL DENSITY [§ 15.247(E)] ..... 121

5.7. RF EXPOSURE REQUIRMENTS [§§ 15.247(B)(5), 1.1310 & 2.1091] ..... 157

**EXHIBIT 6. MEASUREMENT UNCERTAINTY..... 159**

6.1. LINE CONDUCTED EMISSION MEASUREMENT UNCERTAINTY ..... 159

6.2. RADIATED EMISSION MEASUREMENT UNCERTAINTY ..... 159

## EXHIBIT 1. INTRODUCTION

### 1.1. SCOPE

<b>Reference:</b>	FCC Part 15, Subpart C, Section 15.247
<b>Title:</b>	Code of Federal Regulations (CFR), Title 47 – Telecommunication, Part 15
<b>Purpose of Test:</b>	Equipment Certification for Digital Modulation Systems (DTS) Transmitter.
<b>Test Procedures:</b>	Both conducted and radiated emissions measurements were conducted in accordance with American National Standards Institute ANSI C63.4 - American National Standard for Methods of Measurement of Radio-Noise Emissions from Low-Voltage Electrical and Electronic Equipment in the Range of 9 kHz to 40 GHz.
<b>Environmental Classification:</b>	<input checked="" type="checkbox"/> Commercial, industrial or business environment <input checked="" type="checkbox"/> Residential environment

### 1.2. RELATED SUBMITTAL(S)/GRANT(S)

None.

### 1.3. NORMATIVE REFERENCES

Publication	Year	Title
47 CFR Parts 0-19	2012	Code of Federal Regulations (CFR), Title 47 – Telecommunication
ANSI C63.4	2009	American National Standard for Methods of Measurement of Radio-Noise Emissions from Low-Voltage Electrical and Electronic Equipment in the Range of 9 KHz to 40 GHz
ANSI C63.10	2009	American National Standard for Testing Unlicensed Wireless Devices
CISPR 22 & EN 55022	2008-09, Edition 6.0 2006	Information Technology Equipment - Radio Disturbance Characteristics - Limits and Methods of Measurement
CISPR 16-1-1 +A1 +A2	2006 2006 2007	Specification for radio disturbance and immunity measuring apparatus and methods. Part 1-1: Measuring Apparatus
CISPR 16-1-2 +A1 +A2	2003 2004 2006	Specification for radio disturbance and immunity measuring apparatus and methods. Part 1-2: Conducted disturbances
FCC KDB Publication No. 558074 D01 DTS Meas Guidance v01	2012	Guidance for Performing Compliance Measurements on Digital Transmission Systems (DTS) Operating Under §15.247

## EXHIBIT 2. PERFORMANCE ASSESSMENT

### 2.1. CLIENT INFORMATION

APPLICANT	
<b>Name:</b>	Google Inc.
<b>Address:</b>	1600 Amphitheatre Parkway. Mountain View, California 94043 USA
<b>Contact Person:</b>	Mr. Warwick Wong, Regulatory Compliance Specialist Phone #: 408-425-6290 Fax #: N/A Email Address: <a href="mailto:warwickwong@google.com">warwickwong@google.com</a>

MANUFACTURER	
<b>Name:</b>	Flextronics International LTD
<b>Address:</b>	2 Changi South Lane Singapore, Singapore 486123
<b>Contact Person:</b>	Mr. Rich Teltz, Vice President of Engineering Phone #: + 289-288-1530 Fax #: N/A Email Address: <a href="mailto:Richard.Teltz@flextronics.com">Richard.Teltz@flextronics.com</a>

### 2.2. EQUIPMENT UNDER TEST (EUT) INFORMATION

The following information (with the exception of the Date of Receipt) has been supplied by the applicant.

<b>Brand Name:</b>	Google Inc.
<b>Product Name:</b>	H840 DEVICE
<b>Model Name or Number:</b>	H2G2-42
<b>Serial Number:</b>	Test sample
<b>Type of Equipment:</b>	Digital Transmission System (DTS)
<b>Input Power Supply Type:</b>	5 Vdc from AC/DC Power Supply: GPN, M/N: SSW-2222US

### 2.3. PRIMARY USER FUNCTIONS OF EUT

The device functions as a media player.

## 2.4. EUT'S TECHNICAL SPECIFICATIONS

TRANSMITTER	
<b>Equipment Type:</b>	Fixed base station
<b>Intended Operating Environment:</b>	Commercial, industrial, business and residential environment
<b>Power Supply Requirement:</b>	5 Vdc from AC/DC Power Supply: GPN, M/N: SSW-2222US
<b>RF Output Power Rating:</b>	802.11b: 18.1 dBm peak conducted 802.11g: 20.2 dBm peak conducted 802.11n: 18.4 dBm peak conducted
<b>Operating Frequency Range:</b>	2412 – 2462 MHz
<b>RF Output Impedance:</b>	50 $\Omega$
<b>Modulation Type:</b>	DBPSK DQPSK CCK QPSK QAM (DSSS OFDM)
<b>Antenna Connector Type:</b>	Integral (PCB type)
<b>Antenna Description:</b>	Manufacturer: PCB Vendor Type: IFA PCB Model No.: N/A Freq. Range: 2.4 GHz Band Gain: 1.9 dBi

## 2.5. LIST OF ACCESSORY DEVICES

AC/DC Power Supply: GPN, M/N: SSW-2222US, AC Input: 120-240 V, 50/60 Hz, DC Output: 5 Vdc.

\*\*\* This AC adapter incorporating a ferrite core at the connector end of its dc line must be provided with every unit sold

## 2.6. LIST OF EUT'S PORTS

Please refer to users' manual

## 2.7. ANCILLARY EQUIPMENT

The EUT was tested while connected to the following representative configuration of ancillary equipment necessary to exercise the ports during tests:

<b>Ancillary Equipment # 1</b>	
Description:	Dell 24" Monitor
Brand name:	Dell
Model Name or Number:	Dell 2408WFP
Connected to EUT's Port:	USB port

## EXHIBIT 3. EUT OPERATING CONDITIONS AND CONFIGURATIONS DURING TESTS

### 3.1. CLIMATE TEST CONDITIONS

The climate conditions of the test environment are as follows:

Temperature:	21 to 23 °C
Humidity:	45 to 58%
Pressure:	102 kPa
Power Input Source:	5 Vdc from AC/DC Power Supply: GPN, M/N: SSW-2222US

### 3.2. OPERATIONAL TEST CONDITIONS & ARRANGEMENT FOR TESTS

<b>Operating Modes:</b>	The transmitter was operated in a continuous transmission mode with the carrier modulated as specified in the Test Data.
<b>Special Test Software:</b>	Special software provided by the Applicant to operate the EUT at each channel frequency continuously and in the range of typical modes of operation.
<b>Special Hardware Used:</b>	N/A
<b>Transmitter Test Antenna:</b>	The EUT is tested with the antenna fitted in a manner typical of normal intended use as integral antenna equipment.

<b>Transmitter Test Signals</b>	
<b>Frequency Band(s):</b>	2412 -2462 MHz
<b>Frequency(ies) Tested:</b>	2412 MHz, 2437 MHz and 2462 MHz
<b>RF Power Output:</b> (measured maximum output power at antenna terminals)	802.11b: 18.1 dBm peak conducted 802.11g: 20.2 dBm peak conducted 802.11n: 18.4 dBm peak conducted
<b>Normal Test Modulation:</b>	DBPSK DQPSK CCK QPSK QAM (DSSS OFDM)
<b>Modulating Signal Source:</b>	Internal

## EXHIBIT 4. SUMMARY OF TEST RESULTS

### 4.1. LOCATION OF TESTS

All of the measurements described in this report were performed at Ultratech Group of Labs located in the city of Oakville, Province of Ontario, Canada.

- AC Power Line Conducted Emissions were performed in UltraTech's shielded room, 24'(L) by 16'(W) by 8'(H).
- Radiated Emissions were performed at the Ultratech's 3-10 TDK Semi-Anechoic Chamber situated in the Town of Oakville, province of Ontario. This test site been calibrated in accordance with ANSI C63.4, and found to be in compliance with the requirements of Sec. 2.948 of the FCC Rules. The descriptions and site measurement data of the Oakville 3-10 TDK Semi-Anechoic Chamber has been filed with FCC office (FCC File No.: 91038) and Industry Canada office (Industry Canada File No.: 2049A-3). Expiry Date: 2014-04-04.

### 4.2. APPLICABILITY & SUMMARY OF EMC EMISSION TEST RESULTS

FCC Section(s)	Test Requirements	Compliance (Yes/No)
15.203	Antenna requirements	Yes
15.207(a)	AC Power Line Conducted Emissions	Yes
15.247(a)(2)	6 dB Bandwidth	Yes
15.247(b)(3)	Peak Conducted Output Power - DTS	Yes
15.247(d)	Band-Edge and RF Conducted Spurious Emissions at the Transmitter Antenna Terminal	Yes
15.247(d), 15.209 & 15.205	Transmitter Spurious Radiated Emissions	Yes
15.247(e)	Power Spectral Density	Yes
15.247(i), 1.1307, 1.1310, 2.1091	RF Exposure	Yes

### 4.3. MODIFICATIONS INCORPORATED IN THE EUT FOR COMPLIANCE PURPOSES

None.



## EXHIBIT 5. TEST DATA

### 5.1. POWER LINE CONDUCTED EMISSIONS [§15.207(a)]

#### 5.1.1. Limit(s)

The equipment shall meet the limits of the following table:

Frequency of emission (MHz)	Conducted Limits (dBµV)	
	Quasi-peak	Average
0.15–0.5 .....	66 to 56* .....	56 to 46*
0.5–5 .....	56 .....	46
5–30 .....	60 .....	50

\*Decreases linearly with the logarithm of the frequency

#### 5.1.2. Method of Measurements

ANSI C63.4-2009

#### 5.1.3. Test Instruments

Test Instruments	Manufacturer	Model No.	Serial No.	Frequency Range	Cal Due Date
EMI Receiver System/Spectrum Analyzer with built-in Amplifier	Agilent	E7401A	US40240432	9kHz-1.5GHz	May 1, 2013
Attenuator	Pasternack	PE7010-20	---	DC to 2 GHz 20dB attenuation	January 11, 2014
L.I.S.N. Used	EMCO	3825/2	8907-1531	10Khz-100Mhz	April 5, 2013

#### 5.1.4. Test Arrangement

Refer to Annex 1 – Setup Photos

5.1.5. Test Data

Plot 5.1.5.1. Power Line Conducted Emissions - Voltage: 120 VAC; Line Tested: Hot

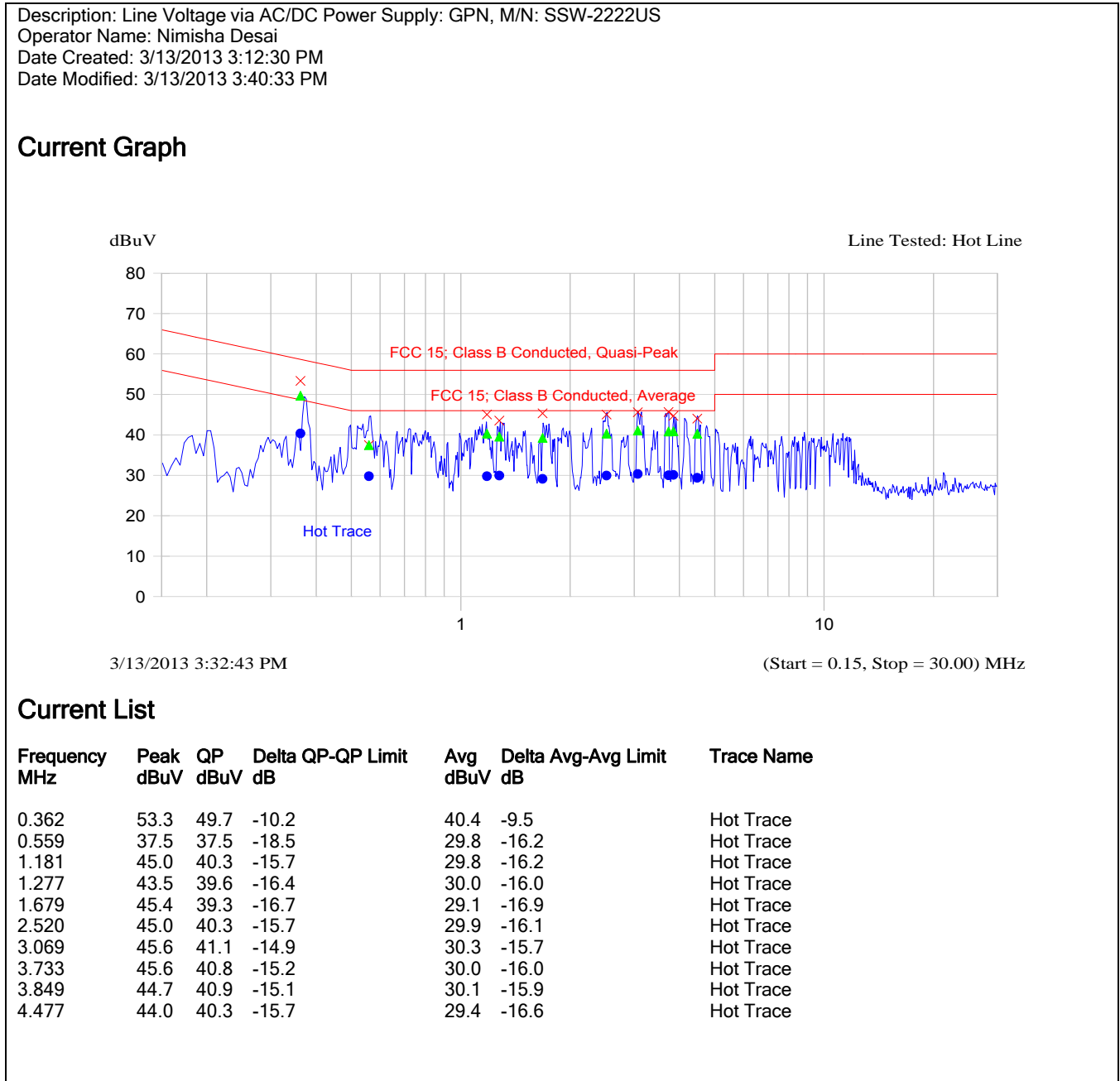

**Plot 5.1.5.2. Power Line Conducted Emissions - Voltage: 120 VAC; Line Tested: Neutral**

D Description: Line Voltage via AC/DC Power Supply: GPN, M/N: SSW-2222US  
Operator Name: Nimisha Desai  
Date Created: 3/13/2013 3:12:30 PM  
Date Modified: 3/13/2013 3:40:33 PM

**Current Graph**



**Current List**

Frequency MHz	Peak dBuV	QP dBuV	Delta QP-QP Limit dB	Avg dBuV	Delta Avg-Avg Limit dB	Trace Name
0.245	35.5	31.4	-31.9	20.0	-33.2	Neutral Trace
0.290	40.9	35.4	-26.5	24.4	-27.5	Neutral Trace
0.342	45.5	38.9	-21.6	26.2	-24.2	Neutral Trace
0.560	39.2	35.0	-21.0	24.3	-21.7	Neutral Trace
0.829	43.3	36.3	-19.7	25.5	-20.5	Neutral Trace
1.159	39.0	33.8	-22.2	22.8	-23.2	Neutral Trace
1.484	41.5	34.5	-21.5	24.2	-21.8	Neutral Trace
1.818	41.4	34.4	-21.6	23.1	-22.9	Neutral Trace
2.589	42.7	35.3	-20.7	24.6	-21.4	Neutral Trace
2.739	43.2	36.4	-19.6	25.3	-20.7	Neutral Trace
3.345	43.6	36.0	-20.0	25.4	-20.6	Neutral Trace
4.386	43.9	35.9	-20.1	24.8	-21.2	Neutral Trace
4.975	42.4	34.7	-21.3	23.3	-22.7	Neutral Trace

## 5.2. OCCUPIED BANDWIDTH [§ 15.247(a)(2)]

### 5.2.1. Limit(s)

Systems using digital modulation techniques may operate in the 902–928 MHz, 2400–2483.5 MHz, and 5725–5850 MHz bands. The minimum 6 dB bandwidth shall be at least 500 kHz.

### 5.2.2. Method of Measurements

KDB Publication No. 558074 D01 Section 5.1.1 EBW Measurement Procedure.

### 5.2.3. Test Instruments

Test Instruments	Manufacturer	Model No.	Serial No.	Frequency Range	Calibration Due Date
Spectrum Analyzer	Rohde & Schwarz	FSEK30	100077	20Hz–40 GHz	2 Nov 2013
Attenuator	Pasternack	PE7024-10	4	DC–26.5 GHz	Cal on use
DC Block	Hewlett Packard	11742A	12460	0.045–26.5 GHz	Cal on use
Laptop	Dell	PPL	9321C-12800-8A2-3775	-	-

### 5.2.4. Test Arrangement

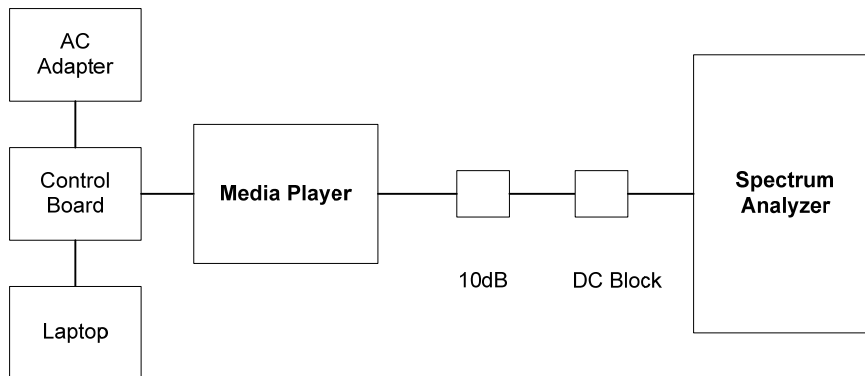

Test Data

Modulation	Data Rate (Mbps)	6 dB Bandwidth (MHz)			99% Occupied Bandwidth (MHz)		
		Ch 01 2412 MHz	Ch 06 2437 MHz	Ch 11 2462 MHz	Ch 01 2412 MHz	Ch 06 2437 MHz	Ch 11 2462 MHz
<b>802.11b</b>							
DBPSK	1	10.06	10.06	9.94	13.47	13.47	13.41
DQPSK	2	9.90	10.02	9.98	13.47	13.47	13.53
CCK	11	9.98	10.26	10.30	13.47	13.41	13.35
<b>802.11g</b>							
BPSK	9	16.62	16.52	16.56	16.97	17.04	17.04
QPSK	18	16.62	16.59	16.63	16.83	16.90	16.76
16-QAM	36	16.62	16.59	16.63	16.97	16.97	16.97
64-QAM	54	16.62	16.59	16.63	16.83	16.83	16.83
<b>802.11n</b>							
BPSK $\frac{1}{2}$	6.5	17.75	17.72	17.76	17.96	17.96	17.96
QPSK $\frac{3}{4}$	19.5	17.75	17.72	17.76	17.96	17.96	17.96
16-QAM $\frac{3}{4}$	39	17.75	17.72	17.76	17.96	17.96	17.96
64-QAM $\frac{5}{6}$	65	17.75	17.72	17.75	17.96	17.96	17.96

See the following plots for detailed measurements.

**Plot 5.2.4.1. 6 dB Bandwidth**

Test (specified rules):	FCC 15.247 (a)(2), RSS 210 A8.2(a) 6 dB BW
Date:	March 20 - 21, 2013
Tested by: Name	Hung Trinh
Test method:	KDB 558074 D01 Section 5.1.1 EBW Measurement Procedure
Comment(s):	2412 MHz, 802.11b, DBPSK 1 Mbps

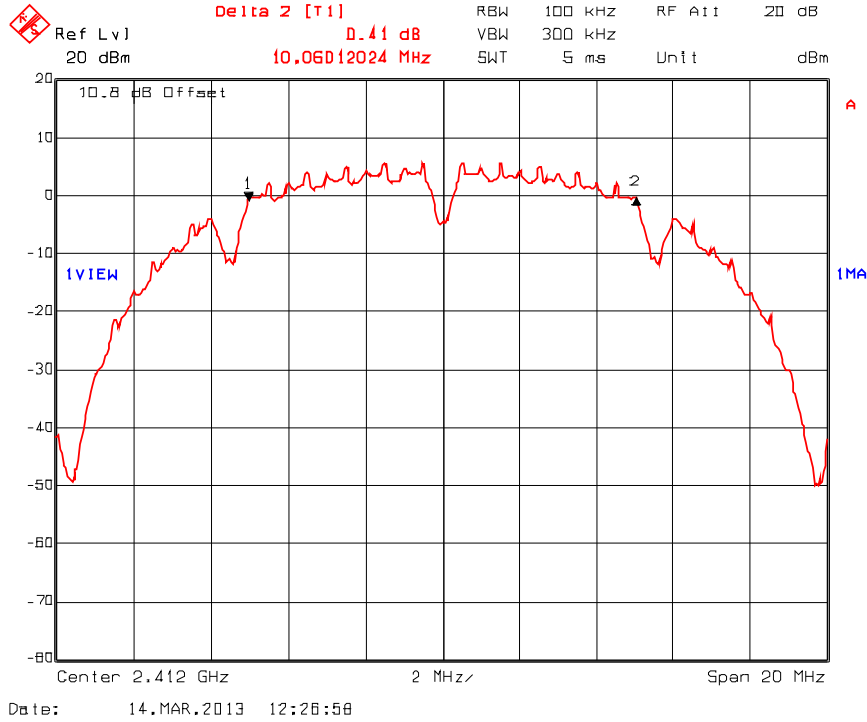

**Plot 5.2.4.2. 6 dB Bandwidth**

Test (specified rules):	FCC 15.247 (a)(2), RSS 210 A8.2(a) 6 dB BW
Date:	March 20 - 21, 2013
Tested by: Name	Hung Trinh
Test method:	KDB 558074 D01 Section 5.1.1 EBW Measurement Procedure
Comment(s):	2437 MHz, 802.11b, DBPSK 1 Mbps

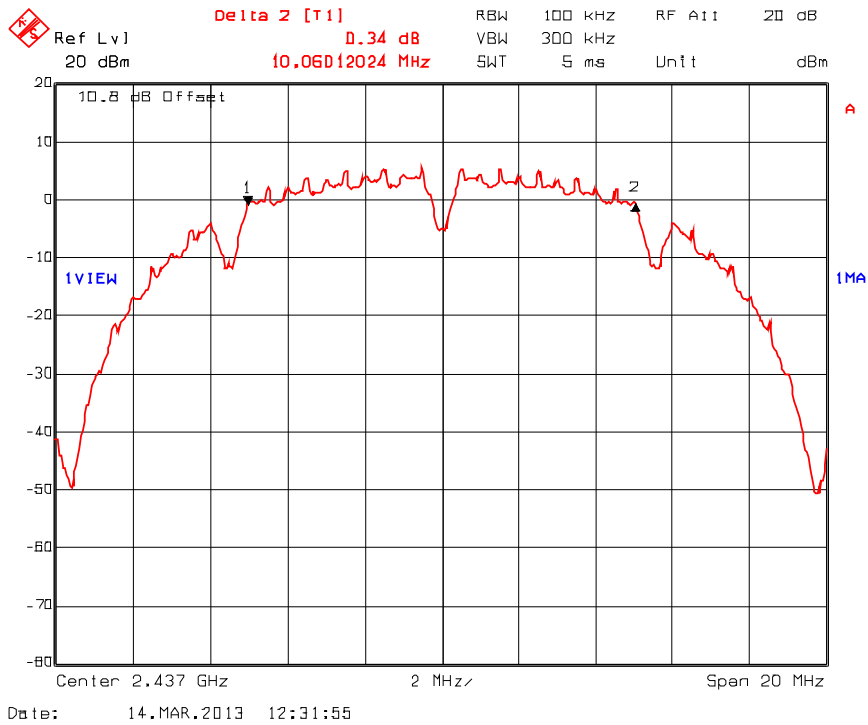

**Plot 5.2.4.3. 6 dB Bandwidth**

Test (specified rules):	FCC 15.247 (a)(2), RSS 210 A8.2(a) 6 dB BW
Date:	March 20 - 21, 2013
Tested by: Name	Hung Trinh
Test method:	KDB 558074 D01 Section 5.1.1 EBW Measurement Procedure
Comment(s):	2462 MHz, 802.11b, DBPSK 1 Mbps

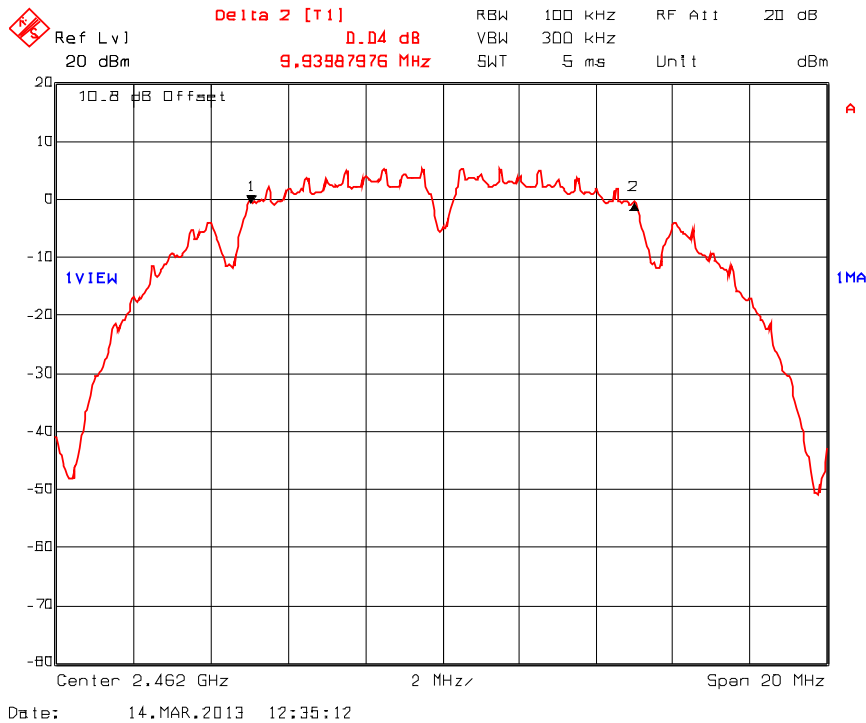

**ULTRATECH GROUP OF LABS**

3000 Bristol Circle, Oakville, Ontario, Canada L6H 6G4  
Tel. #: 905-829-1570, Fax. #: 905-829-8050, Email: [vic@ultratech-labs.com](mailto:vic@ultratech-labs.com), Website: <http://www.ultratech-labs.com>

File #: FLC-007F15C247

March 26, 2013

All test results contained in this engineering test report are traceable to National Institute of Standards and Technology (NIST)



**Plot 5.2.4.4. 6 dB Bandwidth**

Test (specified rules):	FCC 15.247 (a)(2), RSS 210 A8.2(a) 6 dB BW
Date:	March 20 - 21, 2013
Tested by: Name	Hung Trinh
Test method:	KDB 558074 D01 Section 5.1.1 EBW Measurement Procedure
Comment(s):	2412 MHz, 802.11b, DQPSK 2 Mbps

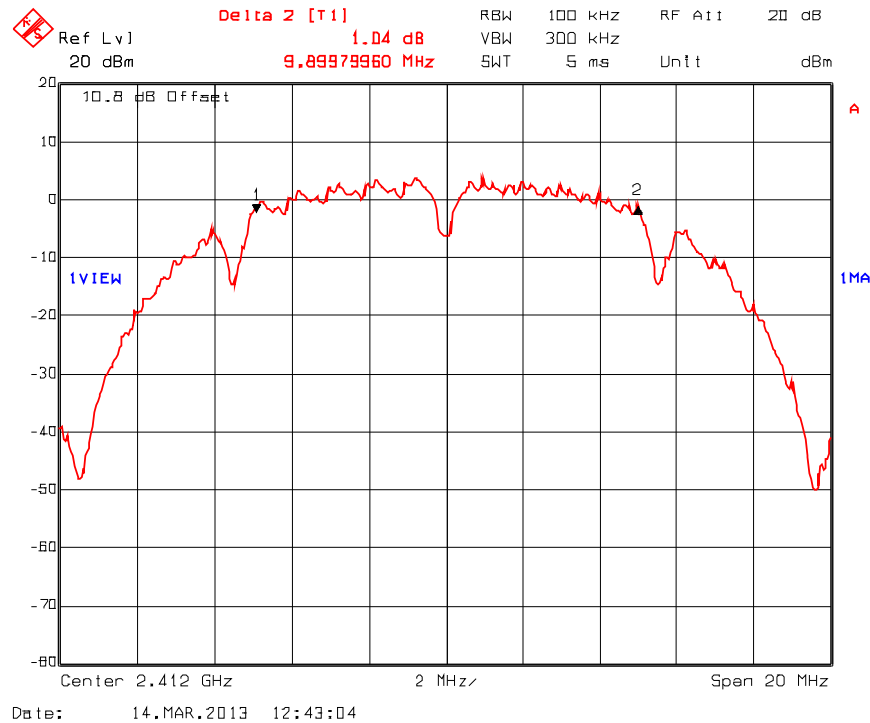

**ULTRATECH GROUP OF LABS**

3000 Bristol Circle, Oakville, Ontario, Canada L6H 6G4  
Tel. #: 905-829-1570, Fax. #: 905-829-8050, Email: [vic@ultratech-labs.com](mailto:vic@ultratech-labs.com), Website: <http://www.ultratech-labs.com>

File #: FLC-007F15C247

March 26, 2013

All test results contained in this engineering test report are traceable to National Institute of Standards and Technology (NIST)

**Plot 5.2.4.5. 6 dB Bandwidth**

Test (specified rules):	FCC 15.247 (a)(2), RSS 210 A8.2(a) 6 dB BW
Date:	March 20 - 21, 2013
Tested by: Name	Hung Trinh
Test method:	KDB 558074 D01 Section 5.1.1 EBW Measurement Procedure
Comment(s):	2437 MHz, 802.11b, DQPSK 2 Mbps

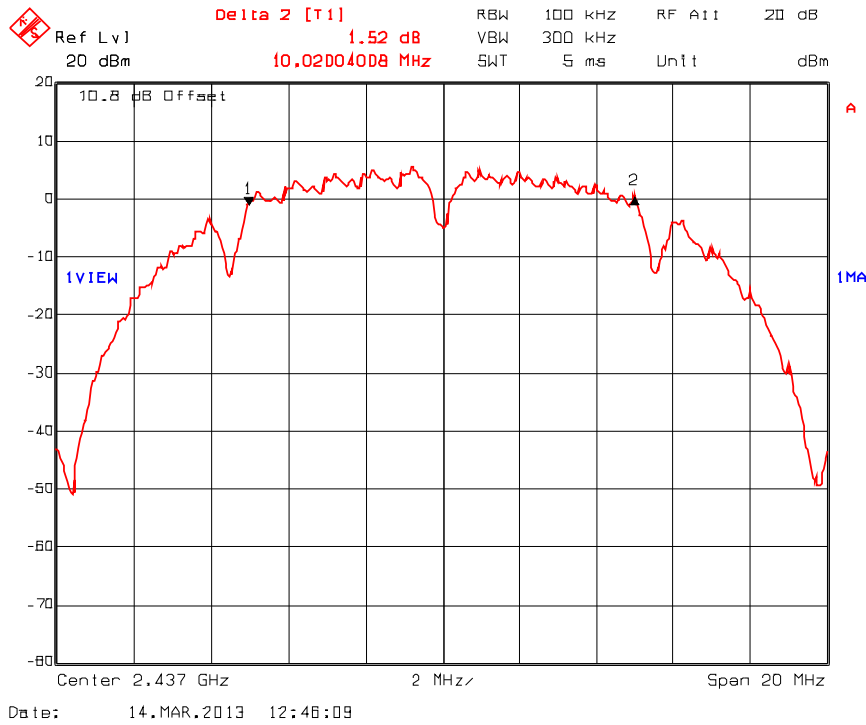

**Plot 5.2.4.6. 6 dB Bandwidth**

Test (specified rules):	FCC 15.247 (a)(2), RSS 210 A8.2(a) 6 dB BW
Date:	March 20 - 21, 2013
Tested by: Name	Hung Trinh
Test method:	KDB 558074 D01 Section 5.1.1 EBW Measurement Procedure
Comment(s):	2462 MHz, 802.11b, DQPSK 2 Mbps

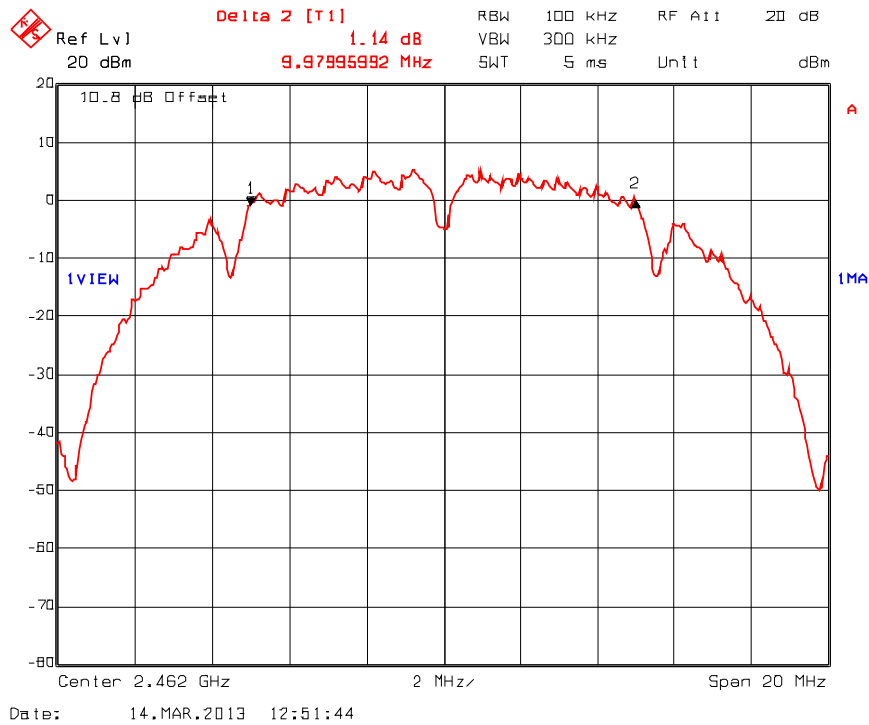

**ULTRATECH GROUP OF LABS**

3000 Bristol Circle, Oakville, Ontario, Canada L6H 6G4  
Tel. #: 905-829-1570, Fax. #: 905-829-8050, Email: [vic@ultratech-labs.com](mailto:vic@ultratech-labs.com), Website: <http://www.ultratech-labs.com>

File #: FLC-007F15C247

March 26, 2013

All test results contained in this engineering test report are traceable to National Institute of Standards and Technology (NIST)

**Plot 5.2.4.7. 6 dB Bandwidth**

Test (specified rules):	FCC 15.247 (a)(2), RSS 210 A8.2(a) 6 dB BW
Date:	March 20 - 21, 2013
Tested by: Name	Hung Trinh
Test method:	KDB 558074 D01 Section 5.1.1 EBW Measurement Procedure
Comment(s):	2412 MHz, 802.11b, CCK 11 Mbps

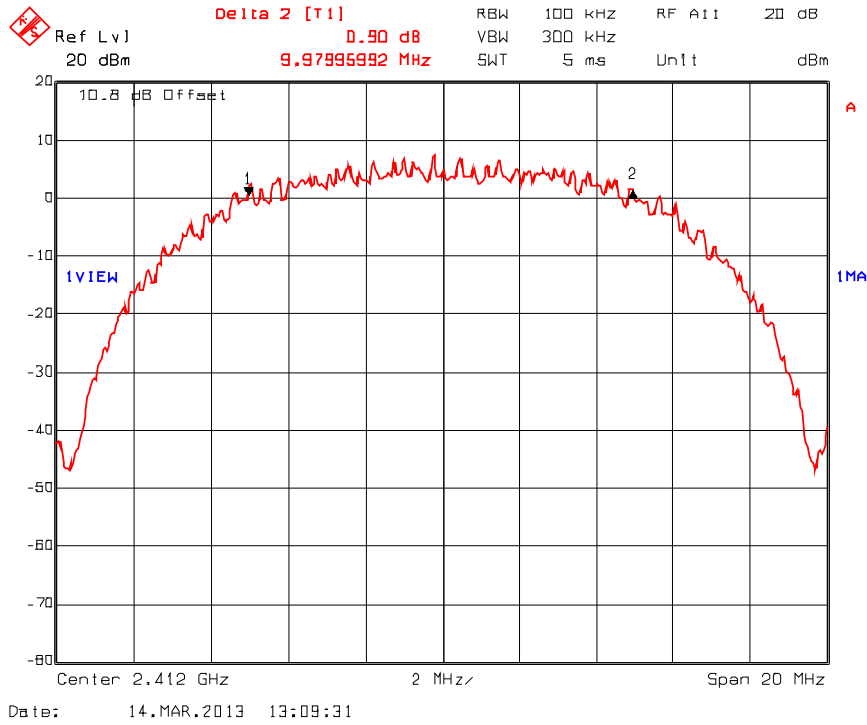

**ULTRATECH GROUP OF LABS**

3000 Bristol Circle, Oakville, Ontario, Canada L6H 6G4  
Tel. #: 905-829-1570, Fax. #: 905-829-8050, Email: [vic@ultratech-labs.com](mailto:vic@ultratech-labs.com), Website: <http://www.ultratech-labs.com>

File #: FLC-007F15C247

March 26, 2013

All test results contained in this engineering test report are traceable to National Institute of Standards and Technology (NIST)

**Plot 5.2.4.8. 6 dB Bandwidth**

Test (specified rules):	FCC 15.247 (a)(2), RSS 210 A8.2(a) 6 dB BW
Date:	March 20 - 21, 2013
Tested by: Name	Hung Trinh
Test method:	KDB 558074 D01 Section 5.1.1 EBW Measurement Procedure
Comment(s):	2437 MHz, 802.11b, CCK 11 Mbps

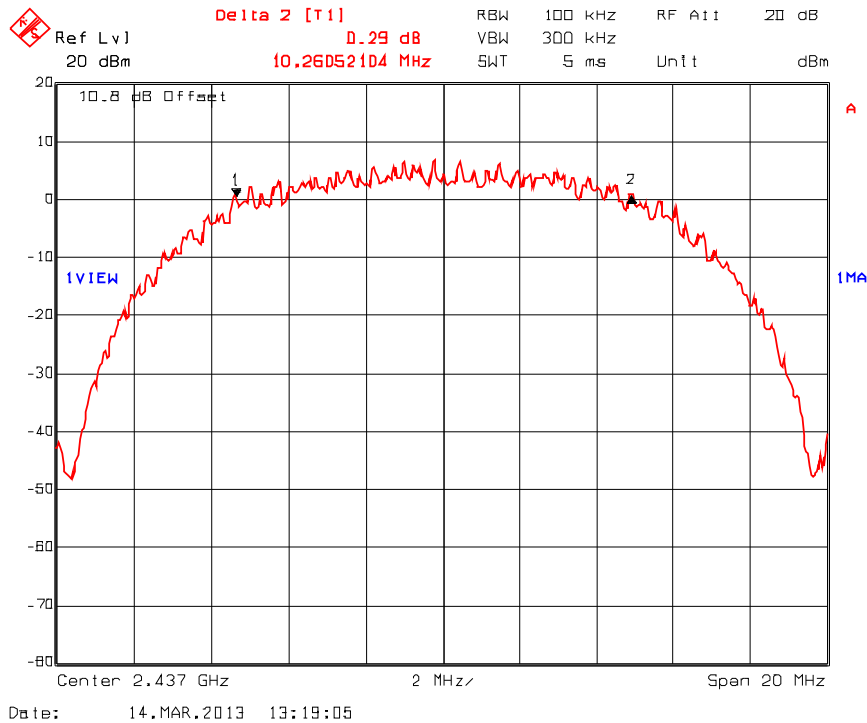

**Plot 5.2.4.9. 6 dB Bandwidth**

Test (specified rules):	FCC 15.247 (a)(2), RSS 210 A8.2(a) 6 dB BW
Date:	March 20 - 21, 2013
Tested by: Name	Hung Trinh
Test method:	KDB 558074 D01 Section 5.1.1 EBW Measurement Procedure
Comment(s):	2462 MHz, 802.11b, CCK 11 Mbps

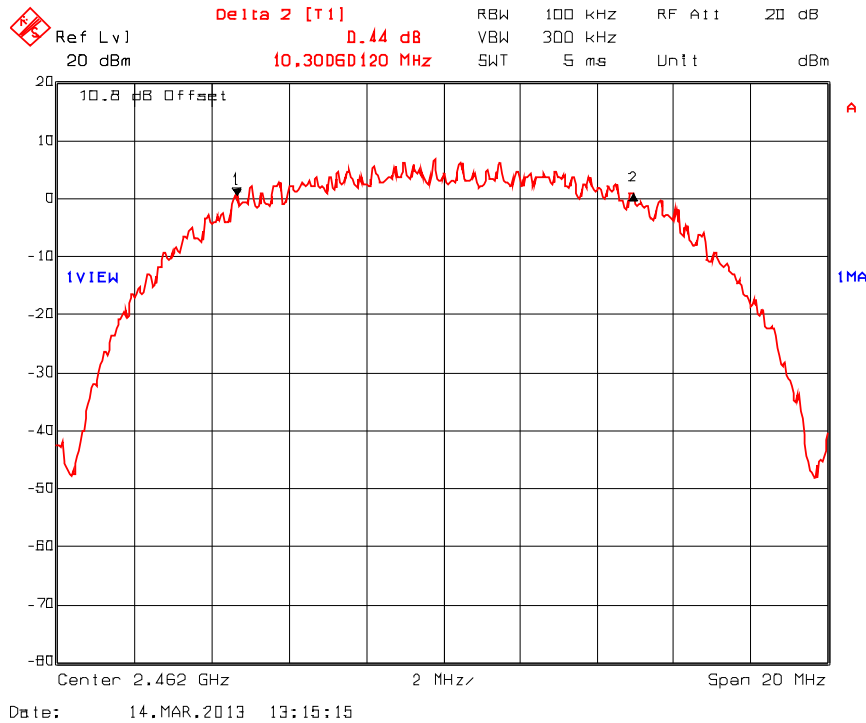

**Plot 5.2.4.10. 6 dB Bandwidth**

Test (specified rules):	FCC 15.247 (a)(2), RSS 210 A8.2(a) 6 dB BW
Date:	March 20 - 21, 2013
Tested by: Name	Hung Trinh
Test method:	KDB 558074 D01 Section 5.1.1 EBW Measurement Procedure
Comment(s):	2412 MHz, 802.11g, BPSK 9 Mbps

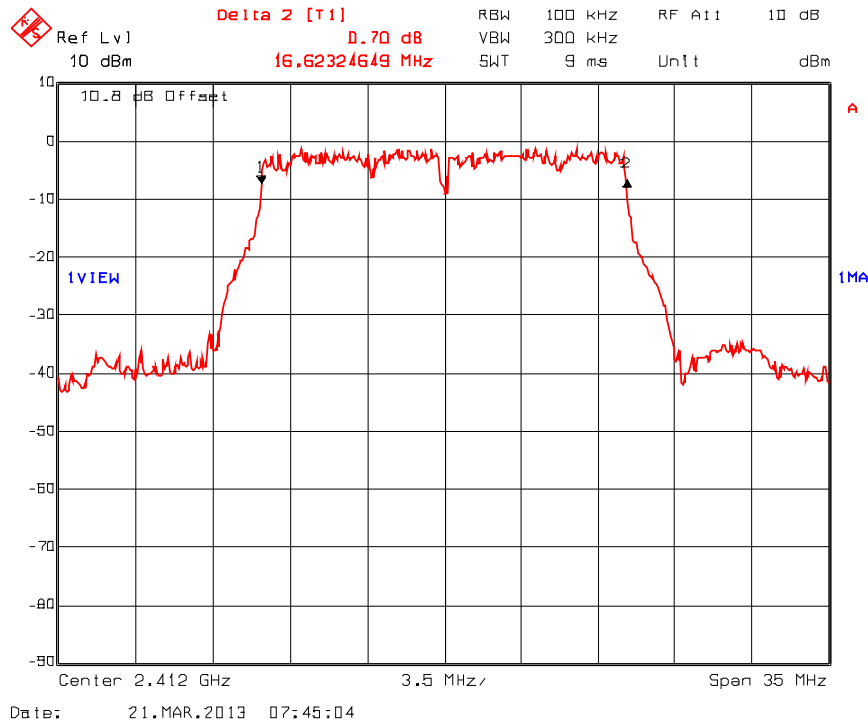

**ULTRATECH GROUP OF LABS**

3000 Bristol Circle, Oakville, Ontario, Canada L6H 6G4  
 Tel. #: 905-829-1570, Fax. #: 905-829-8050, Email: [vic@ultratech-labs.com](mailto:vic@ultratech-labs.com), Website: <http://www.ultratech-labs.com>

File #: FLC-007F15C247

March 26, 2013

All test results contained in this engineering test report are traceable to National Institute of Standards and Technology (NIST)

**Plot 5.2.4.11. 6 dB Bandwidth**

Test (specified rules):	FCC 15.247 (a)(2), RSS 210 A8.2(a) 6 dB BW
Date:	March 20 - 21, 2013
Tested by: Name	Hung Trinh
Test method:	KDB 558074 D01 Section 5.1.1 EBW Measurement Procedure
Comment(s):	2437 MHz, 802.11g, BPSK 9 Mbps

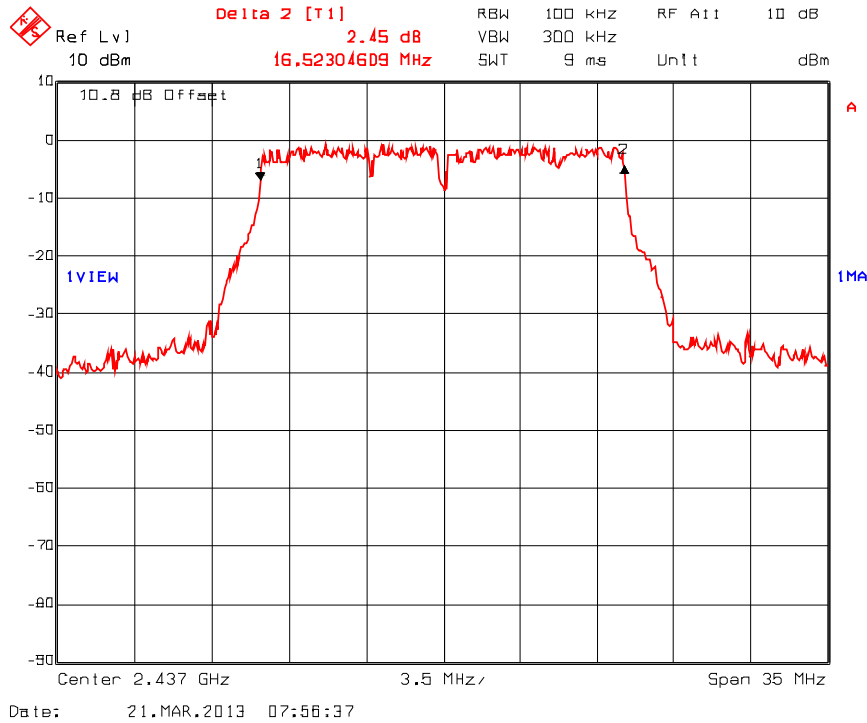

**ULTRATECH GROUP OF LABS**

3000 Bristol Circle, Oakville, Ontario, Canada L6H 6G4  
Tel. #: 905-829-1570, Fax. #: 905-829-8050, Email: [vic@ultratech-labs.com](mailto:vic@ultratech-labs.com), Website: <http://www.ultratech-labs.com>

File #: FLC-007F15C247

March 26, 2013

All test results contained in this engineering test report are traceable to National Institute of Standards and Technology (NIST)



**Plot 5.2.4.12. 6 dB Bandwidth**

Test (specified rules):	FCC 15.247 (a)(2), RSS 210 A8.2(a) 6 dB BW
Date:	March 20 - 21, 2013
Tested by: Name	Hung Trinh
Test method:	KDB 558074 D01 Section 5.1.1 EBW Measurement Procedure
Comment(s):	2462 MHz, 802.11g, BPSK 9 Mbps

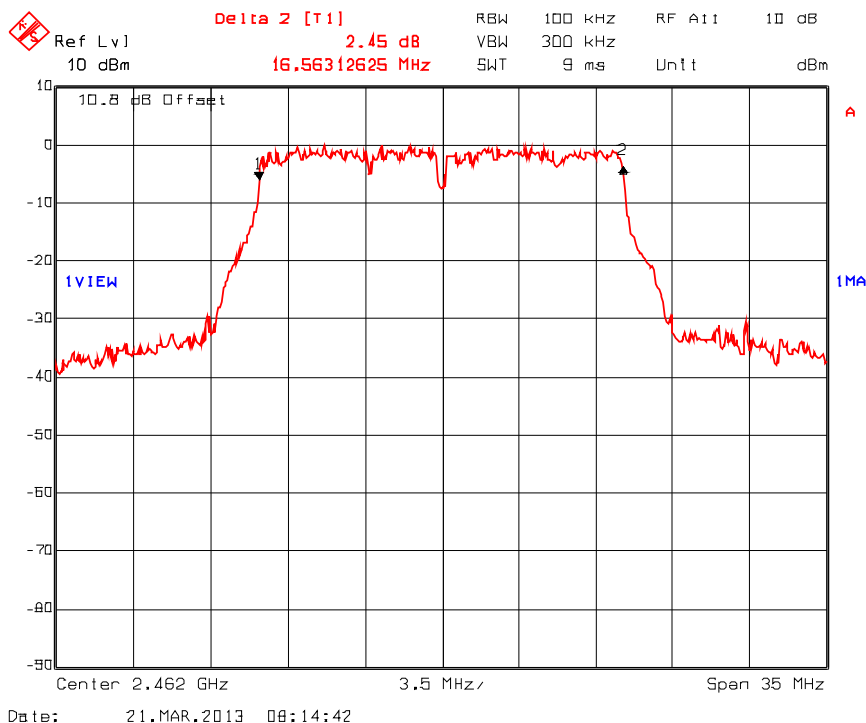

**ULTRATECH GROUP OF LABS**

3000 Bristol Circle, Oakville, Ontario, Canada L6H 6G4  
Tel. #: 905-829-1570, Fax. #: 905-829-8050, Email: [vic@ultratech-labs.com](mailto:vic@ultratech-labs.com), Website: <http://www.ultratech-labs.com>

File #: FLC-007F15C247  
March 26, 2013

All test results contained in this engineering test report are traceable to National Institute of Standards and Technology (NIST)

**Plot 5.2.4.13. 6 dB Bandwidth**

Test (specified rules):	FCC 15.247 (a)(2), RSS 210 A8.2(a) 6 dB BW
Date:	March 20 - 21, 2013
Tested by: Name	Hung Trinh
Test method:	KDB 558074 D01 Section 5.1.1 EBW Measurement Procedure
Comment(s):	2412 MHz, 802.11g, QPSK 18 Mbps

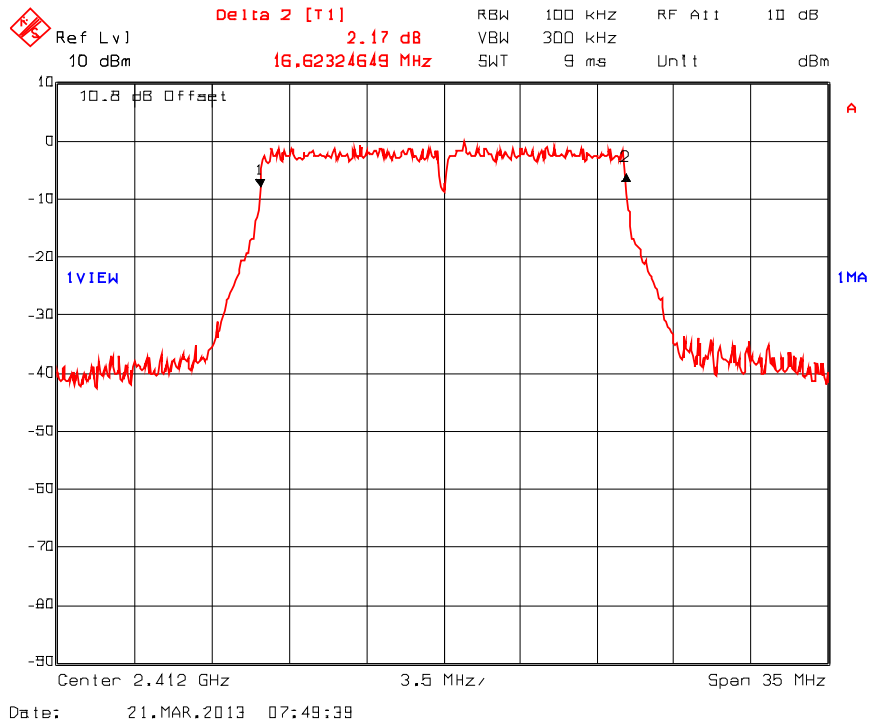

**Plot 5.2.4.14. 6 dB Bandwidth**

Test (specified rules):	FCC 15.247 (a)(2), RSS 210 A8.2(a) 6 dB BW
Date:	March 20 - 21, 2013
Tested by: Name	Hung Trinh
Test method:	KDB 558074 D01 Section 5.1.1 EBW Measurement Procedure
Comment(s):	2437 MHz, 802.11g, QPSK 18 Mbps

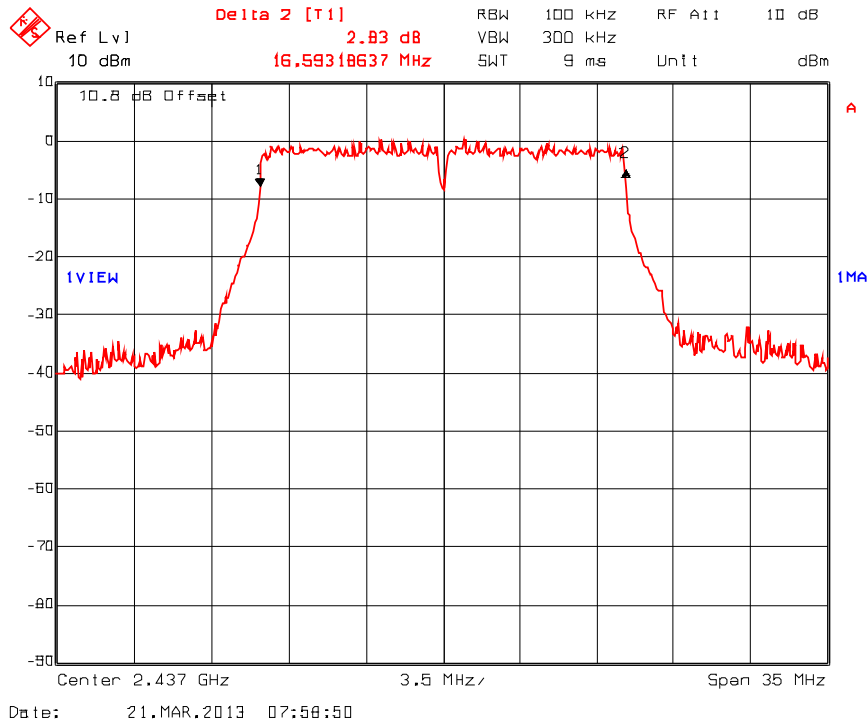

**ULTRATECH GROUP OF LABS**

3000 Bristol Circle, Oakville, Ontario, Canada L6H 6G4  
Tel. #: 905-829-1570, Fax. #: 905-829-8050, Email: [vic@ultratech-labs.com](mailto:vic@ultratech-labs.com), Website: <http://www.ultratech-labs.com>

File #: FLC-007F15C247

March 26, 2013

All test results contained in this engineering test report are traceable to National Institute of Standards and Technology (NIST)

**Plot 5.2.4.15. 6 dB Bandwidth**

Test (specified rules):	FCC 15.247 (a)(2), RSS 210 A8.2(a) 6 dB BW
Date:	March 20 - 21, 2013
Tested by: Name	Hung Trinh
Test method:	KDB 558074 D01 Section 5.1.1 EBW Measurement Procedure
Comment(s):	2462 MHz, 802.11g, QPSK 18 Mbps

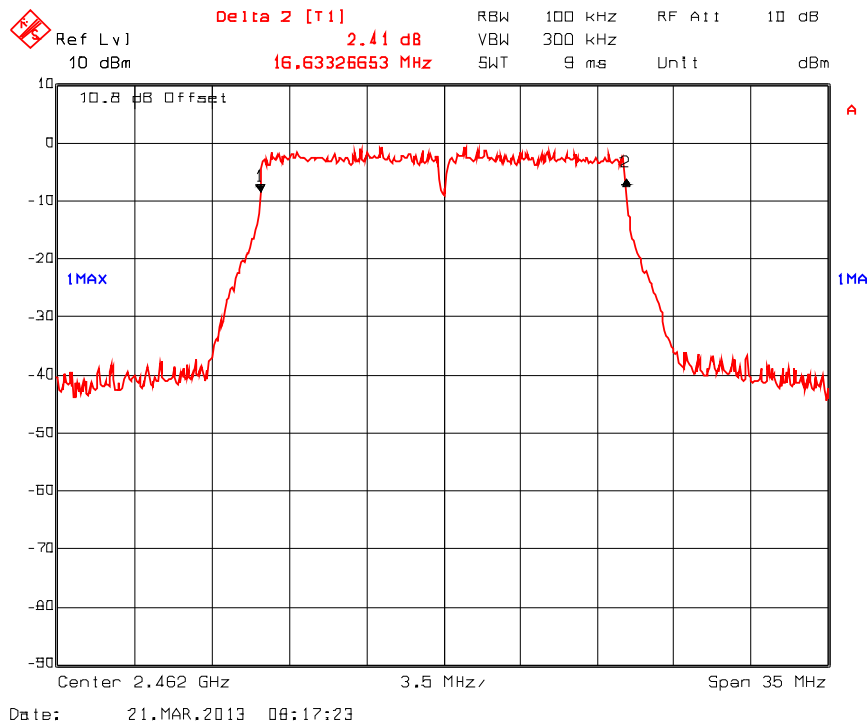

**ULTRATECH GROUP OF LABS**

3000 Bristol Circle, Oakville, Ontario, Canada L6H 6G4  
Tel. #: 905-829-1570, Fax. #: 905-829-8050, Email: [vic@ultratech-labs.com](mailto:vic@ultratech-labs.com), Website: <http://www.ultratech-labs.com>

File #: FLC-007F15C247

March 26, 2013

All test results contained in this engineering test report are traceable to National Institute of Standards and Technology (NIST)

**Plot 5.2.4.16. 6 dB Bandwidth**

Test (specified rules):	FCC 15.247 (a)(2), RSS 210 A8.2(a) 6 dB BW
Date:	March 20 - 21, 2013
Tested by: Name	Hung Trinh
Test method:	KDB 558074 D01 Section 5.1.1 EBW Measurement Procedure
Comment(s):	2412 MHz, 802.11g, 16-QAM 36 Mbps

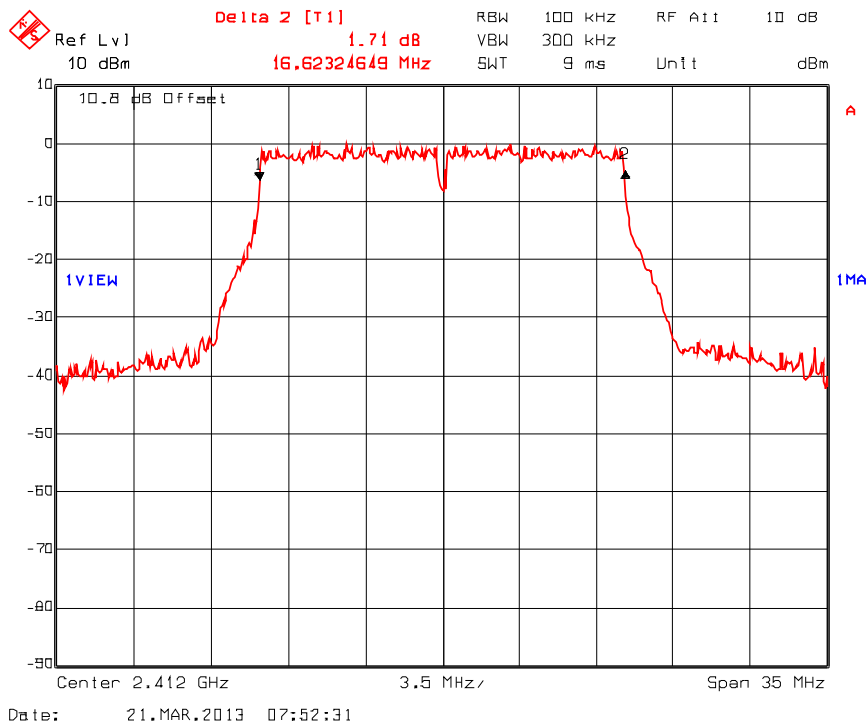

**Plot 5.2.4.17. 6 dB Bandwidth**

Test (specified rules):	FCC 15.247 (a)(2), RSS 210 A8.2(a) 6 dB BW
Date:	March 20 - 21, 2013
Tested by: Name	Hung Trinh
Test method:	KDB 558074 D01 Section 5.1.1 EBW Measurement Procedure
Comment(s):	2437 MHz, 802.11g, 16-QAM 36 Mbps

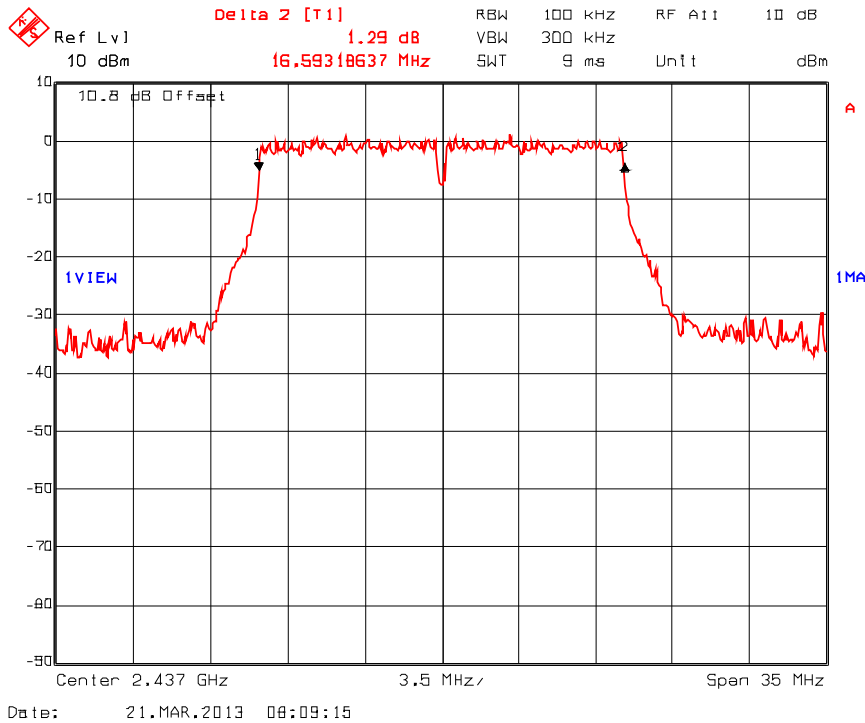

**ULTRATECH GROUP OF LABS**

3000 Bristol Circle, Oakville, Ontario, Canada L6H 6G4  
Tel. #: 905-829-1570, Fax. #: 905-829-8050, Email: [vic@ultratech-labs.com](mailto:vic@ultratech-labs.com), Website: <http://www.ultratech-labs.com>

File #: FLC-007F15C247

March 26, 2013

All test results contained in this engineering test report are traceable to National Institute of Standards and Technology (NIST)

**Plot 5.2.4.18. 6 dB Bandwidth**

Test (specified rules):	FCC 15.247 (a)(2), RSS 210 A8.2(a) 6 dB BW
Date:	March 20 - 21, 2013
Tested by: Name	Hung Trinh
Test method:	KDB 558074 D01 Section 5.1.1 EBW Measurement Procedure
Comment(s):	2462 MHz, 802.11g, 16-QAM 36 Mbps

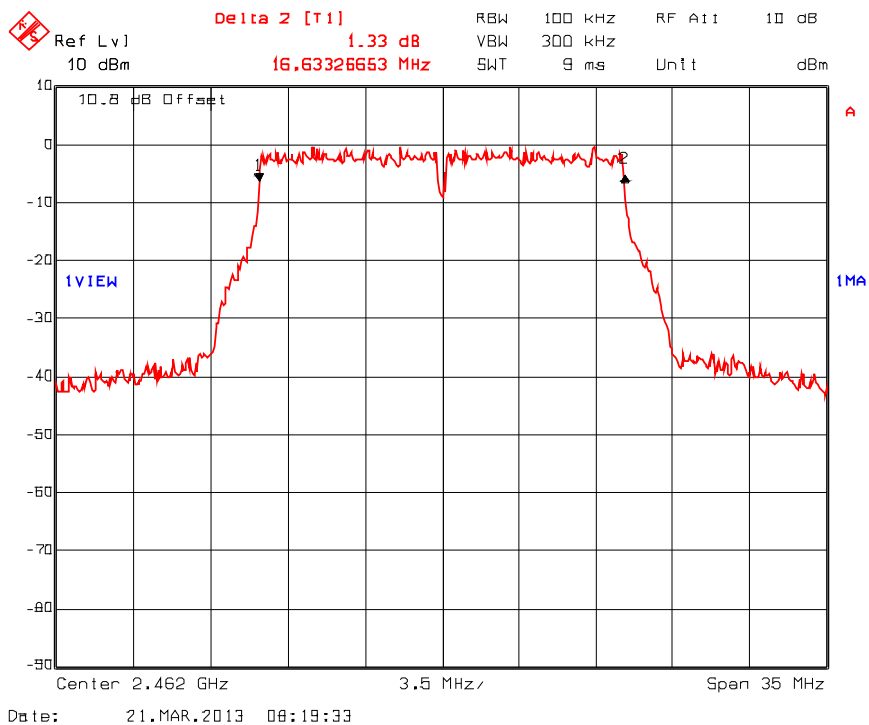

**ULTRATECH GROUP OF LABS**

3000 Bristol Circle, Oakville, Ontario, Canada L6H 6G4  
Tel. #: 905-829-1570, Fax. #: 905-829-8050, Email: [vic@ultratech-labs.com](mailto:vic@ultratech-labs.com), Website: <http://www.ultratech-labs.com>

File #: FLC-007F15C247

March 26, 2013

All test results contained in this engineering test report are traceable to National Institute of Standards and Technology (NIST)

**Plot 5.2.4.19. 6 dB Bandwidth**

Test (specified rules):	FCC 15.247 (a)(2), RSS 210 A8.2(a) 6 dB BW
Date:	March 20 - 21, 2013
Tested by: Name	Hung Trinh
Test method:	KDB 558074 D01 Section 5.1.1 EBW Measurement Procedure
Comment(s):	2412 MHz, 802.11g, 64-QAM 54 Mbps

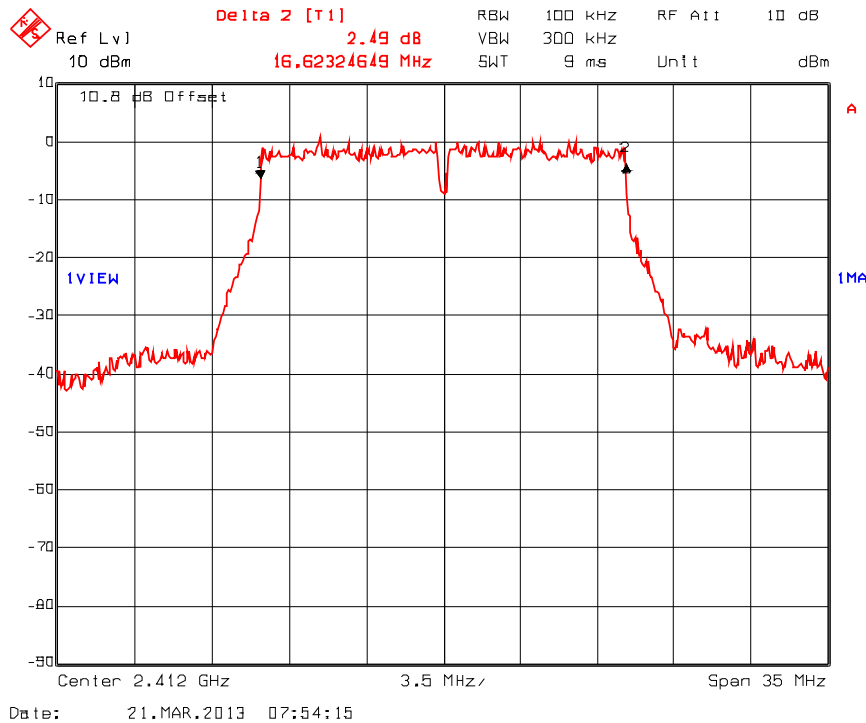



**Plot 5.2.4.20. 6 dB Bandwidth**

Test (specified rules):	FCC 15.247 (a)(2), RSS 210 A8.2(a) 6 dB BW
Date:	March 20 - 21, 2013
Tested by: Name	Hung Trinh
Test method:	KDB 558074 D01 Section 5.1.1 EBW Measurement Procedure
Comment(s):	2437 MHz, 802.11g, 64-QAM 54 Mbps

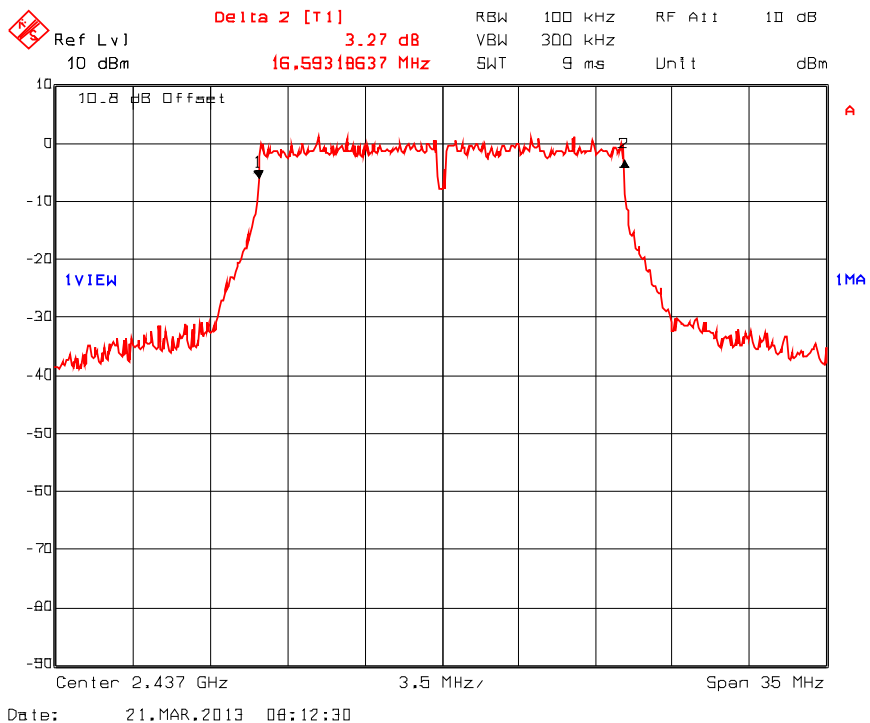

**ULTRATECH GROUP OF LABS**

3000 Bristol Circle, Oakville, Ontario, Canada L6H 6G4  
Tel. #: 905-829-1570, Fax. #: 905-829-8050, Email: [vic@ultratech-labs.com](mailto:vic@ultratech-labs.com), Website: <http://www.ultratech-labs.com>

File #: FLC-007F15C247

March 26, 2013

All test results contained in this engineering test report are traceable to National Institute of Standards and Technology (NIST)

**Plot 5.2.4.21. 6 dB Bandwidth**

Test (specified rules):	FCC 15.247 (a)(2), RSS 210 A8.2(a) 6 dB BW
Date:	March 20 - 21, 2013
Tested by: Name	Hung Trinh
Test method:	KDB 558074 D01 Section 5.1.1 EBW Measurement Procedure
Comment(s):	2462 MHz, 802.11g, 64-QAM 54 Mbps

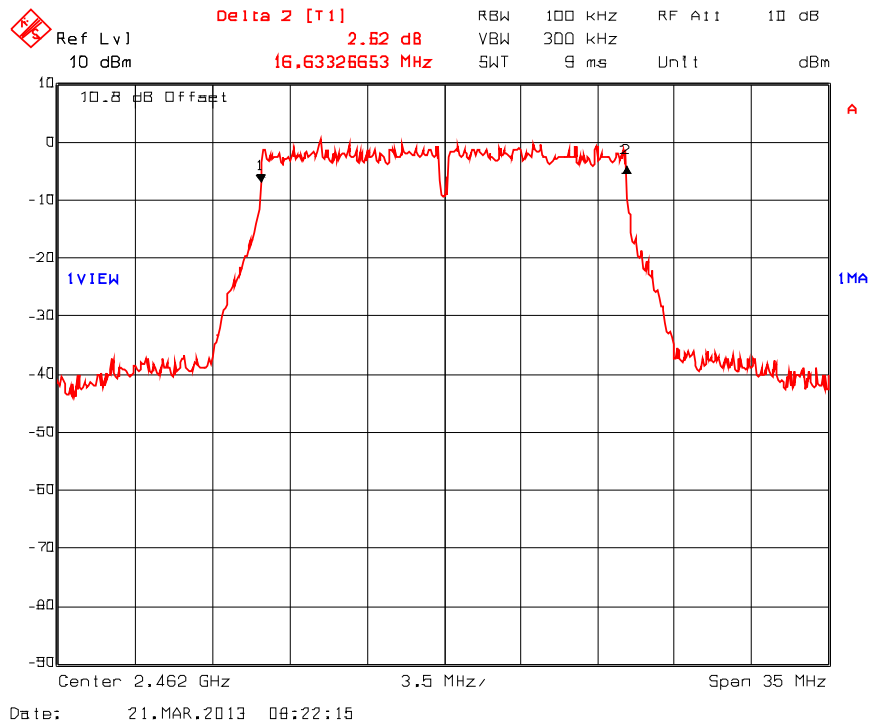

**ULTRATECH GROUP OF LABS**

3000 Bristol Circle, Oakville, Ontario, Canada L6H 6G4  
Tel. #: 905-829-1570, Fax. #: 905-829-8050, Email: [vic@ultratech-labs.com](mailto:vic@ultratech-labs.com), Website: <http://www.ultratech-labs.com>

File #: FLC-007F15C247  
March 26, 2013

All test results contained in this engineering test report are traceable to National Institute of Standards and Technology (NIST)

**Plot 5.2.4.22. 6 dB Bandwidth**

Test (specified rules):	FCC 15.247 (a)(2), RSS 210 A8.2(a) 6 dB BW
Date:	March 20 - 21, 2013
Tested by: Name	Hung Trinh
Test method:	KDB 558074 D01 Section 5.1.1 EBW Measurement Procedure
Comment(s):	2412 MHz, 802.11n, BPSK 1/2 6.5 Mbps

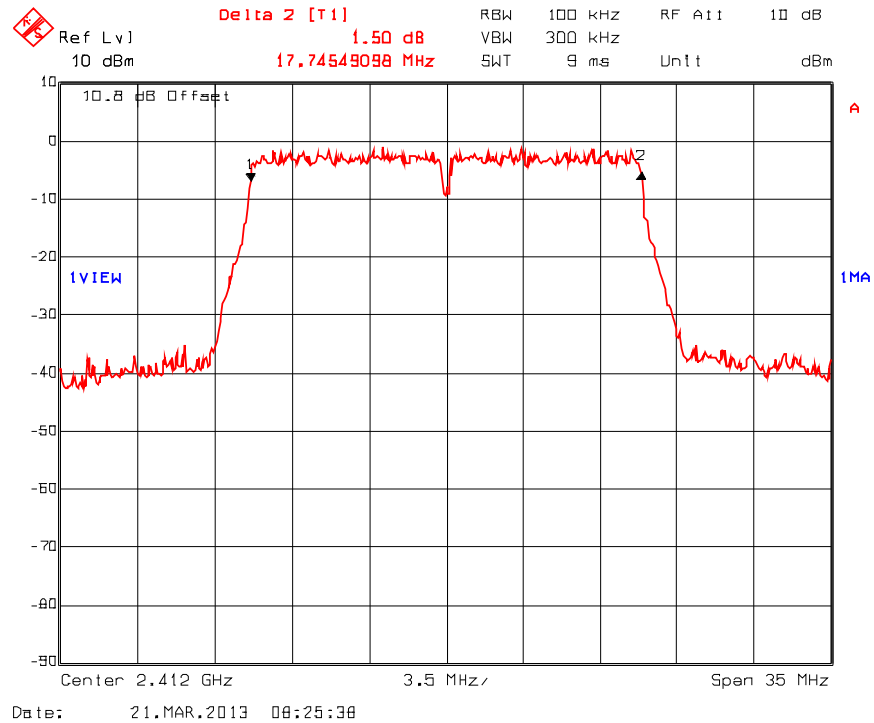

**ULTRATECH GROUP OF LABS**

3000 Bristol Circle, Oakville, Ontario, Canada L6H 6G4  
Tel. #: 905-829-1570, Fax. #: 905-829-8050, Email: [vic@ultratech-labs.com](mailto:vic@ultratech-labs.com), Website: <http://www.ultratech-labs.com>

File #: FLC-007F15C247

March 26, 2013

All test results contained in this engineering test report are traceable to National Institute of Standards and Technology (NIST)

**Plot 5.2.4.23. 6 dB Bandwidth**

Test (specified rules):	FCC 15.247 (a)(2), RSS 210 A8.2(a) 6 dB BW
Date:	March 20 - 21, 2013
Tested by: Name	Hung Trinh
Test method:	KDB 558074 D01 Section 5.1.1 EBW Measurement Procedure
Comment(s):	2437 MHz, 802.11n, BPSK 1/2 6.5 Mbps

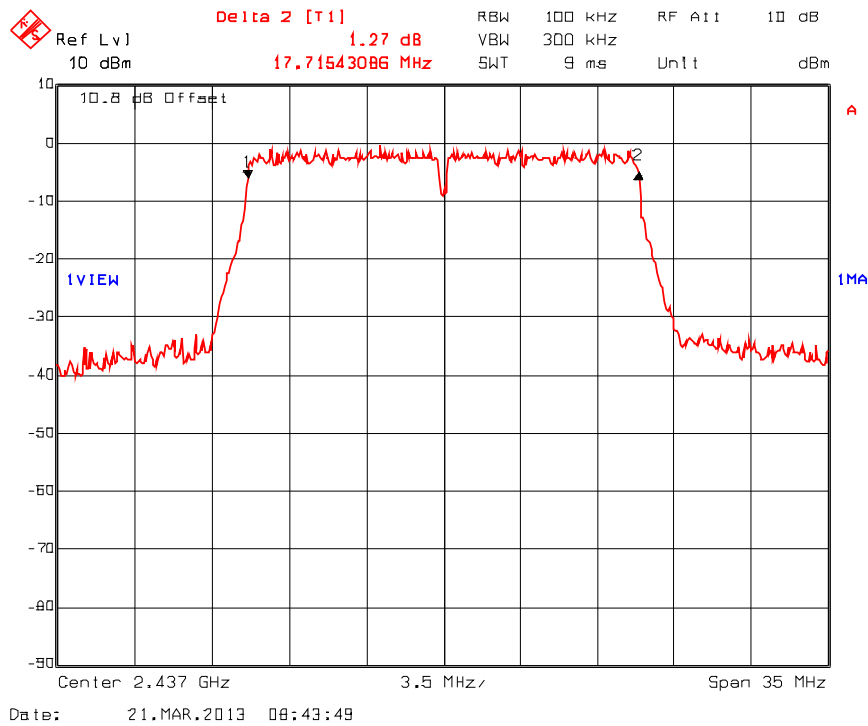

**Plot 5.2.4.24. 6 dB Bandwidth**

Test (specified rules):	FCC 15.247 (a)(2), RSS 210 A8.2(a) 6 dB BW
Date:	March 20 - 21, 2013
Tested by: Name	Hung Trinh
Test method:	KDB 558074 D01 Section 5.1.1 EBW Measurement Procedure
Comment(s):	2462 MHz, 802.11n, BPSK 1/2 6.5 Mbps

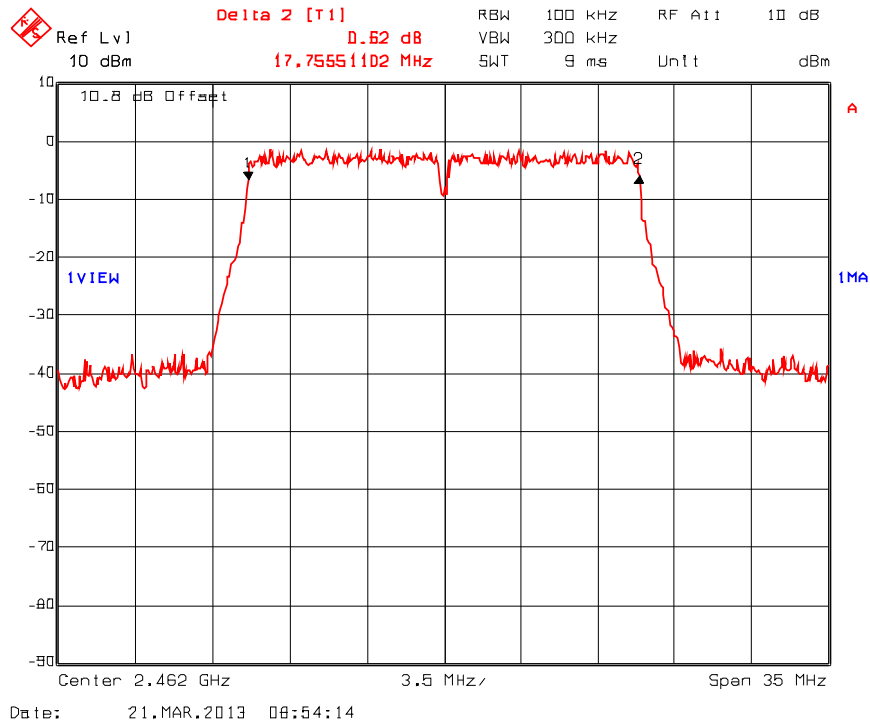

**ULTRATECH GROUP OF LABS**

3000 Bristol Circle, Oakville, Ontario, Canada L6H 6G4  
Tel. #: 905-829-1570, Fax. #: 905-829-8050, Email: [vic@ultratech-labs.com](mailto:vic@ultratech-labs.com), Website: <http://www.ultratech-labs.com>

File #: FLC-007F15C247

March 26, 2013

All test results contained in this engineering test report are traceable to National Institute of Standards and Technology (NIST)

**Plot 5.2.4.25. 6 dB Bandwidth**

Test (specified rules):	FCC 15.247 (a)(2), RSS 210 A8.2(a) 6 dB BW
Date:	March 20 - 21, 2013
Tested by: Name	Hung Trinh
Test method:	KDB 558074 D01 Section 5.1.1 EBW Measurement Procedure
Comment(s):	2412 MHz, 802.11n, QPSK $\frac{3}{4}$ 19.5 Mbps

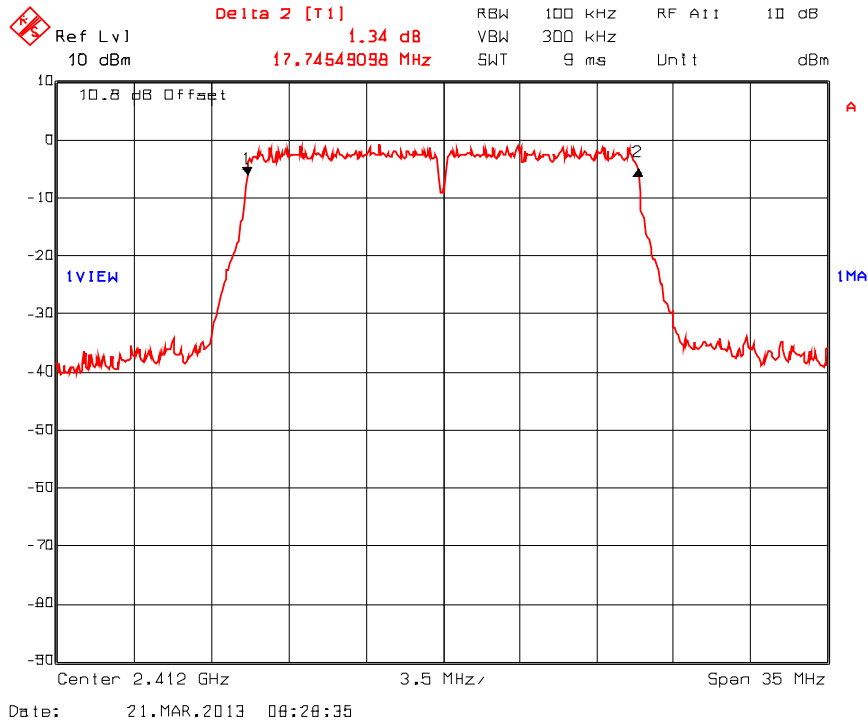

**ULTRATECH GROUP OF LABS**

3000 Bristol Circle, Oakville, Ontario, Canada L6H 6G4  
Tel. #: 905-829-1570, Fax. #: 905-829-8050, Email: [vic@ultratech-labs.com](mailto:vic@ultratech-labs.com), Website: <http://www.ultratech-labs.com>

File #: FLC-007F15C247  
March 26, 2013

All test results contained in this engineering test report are traceable to National Institute of Standards and Technology (NIST)

**Plot 5.2.4.26. 6 dB Bandwidth**

Test (specified rules):	FCC 15.247 (a)(2), RSS 210 A8.2(a) 6 dB BW
Date:	March 20 - 21, 2013
Tested by: Name	Hung Trinh
Test method:	KDB 558074 D01 Section 5.1.1 EBW Measurement Procedure
Comment(s):	2437 MHz, 802.11n, QPSK 3/4 19.5 Mbps

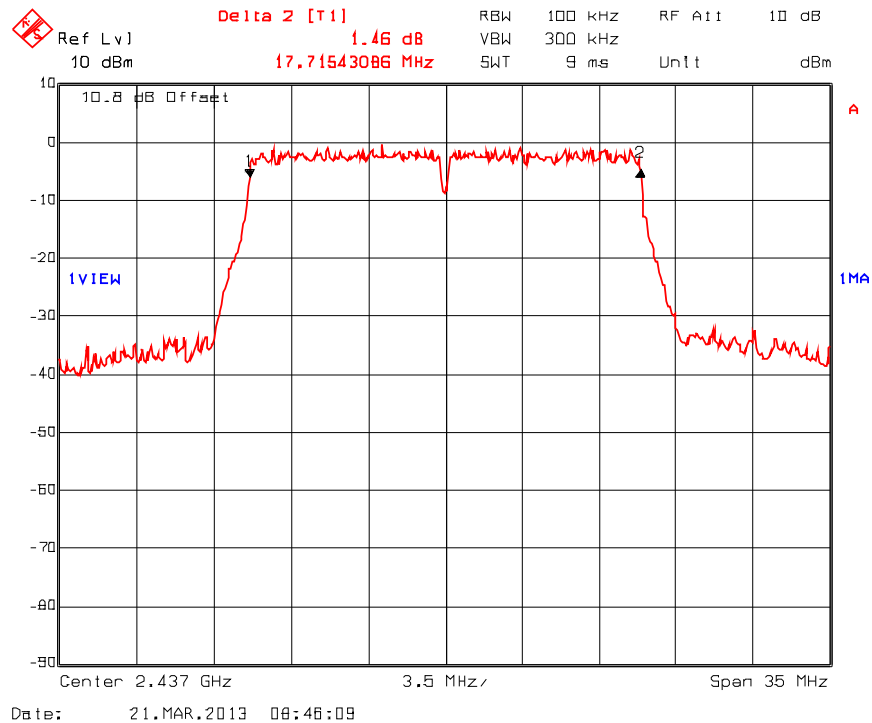

**Plot 5.2.4.27. 6 dB Bandwidth**

Test (specified rules):	FCC 15.247 (a)(2), RSS 210 A8.2(a) 6 dB BW
Date:	March 20 - 21, 2013
Tested by: Name	Hung Trinh
Test method:	KDB 558074 D01 Section 5.1.1 EBW Measurement Procedure
Comment(s):	2462 MHz, 802.11n, QPSK 3/4 19.5 Mbps

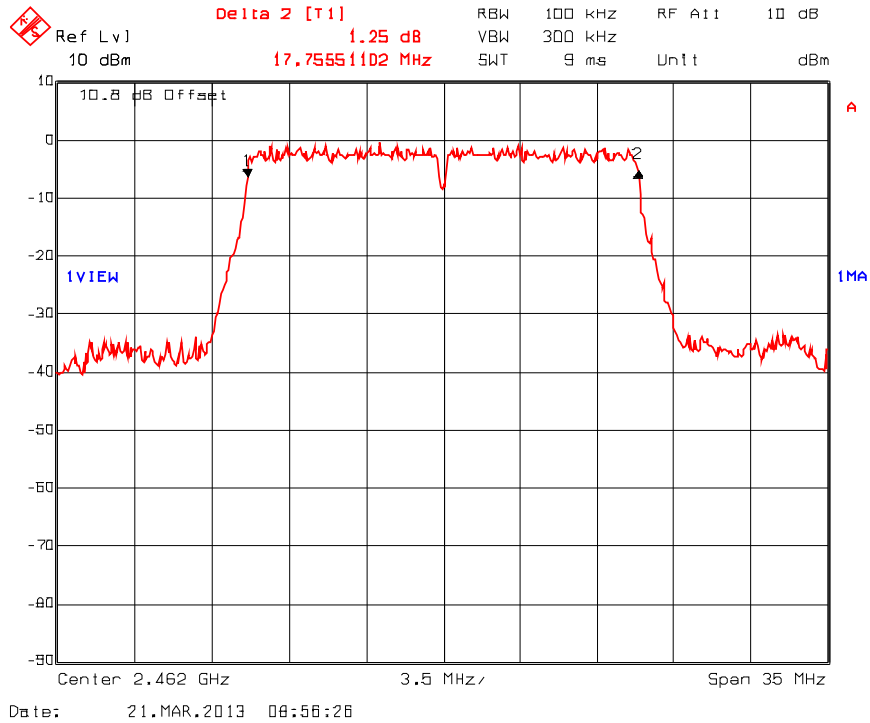



**Plot 5.2.4.28. 6 dB Bandwidth**

Test (specified rules):	FCC 15.247 (a)(2), RSS 210 A8.2(a) 6 dB BW
Date:	March 20 - 21, 2013
Tested by: Name	Hung Trinh
Test method:	KDB 558074 D01 Section 5.1.1 EBW Measurement Procedure
Comment(s):	2412 MHz, 802.11n, 64-QAM 5/6 65 Mbps

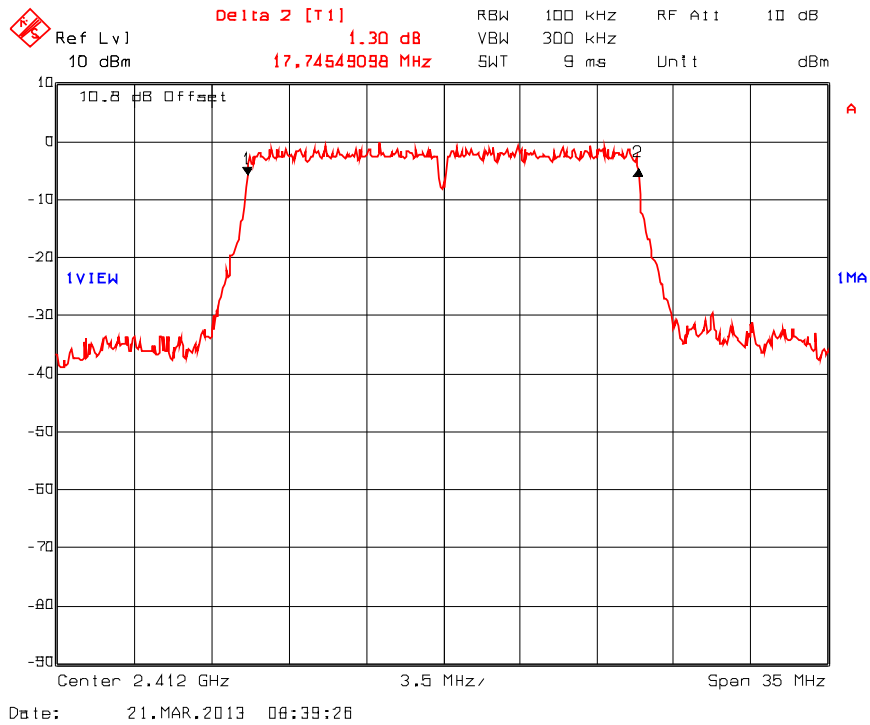

**Plot 5.2.4.29. 6 dB Bandwidth**

Test (specified rules):	FCC 15.247 (a)(2), RSS 210 A8.2(a) 6 dB BW
Date:	March 20 - 21, 2013
Tested by: Name	Hung Trinh
Test method:	KDB 558074 D01 Section 5.1.1 EBW Measurement Procedure
Comment(s):	2437 MHz, 802.11n, 64-QAM 5/6 65 Mbps

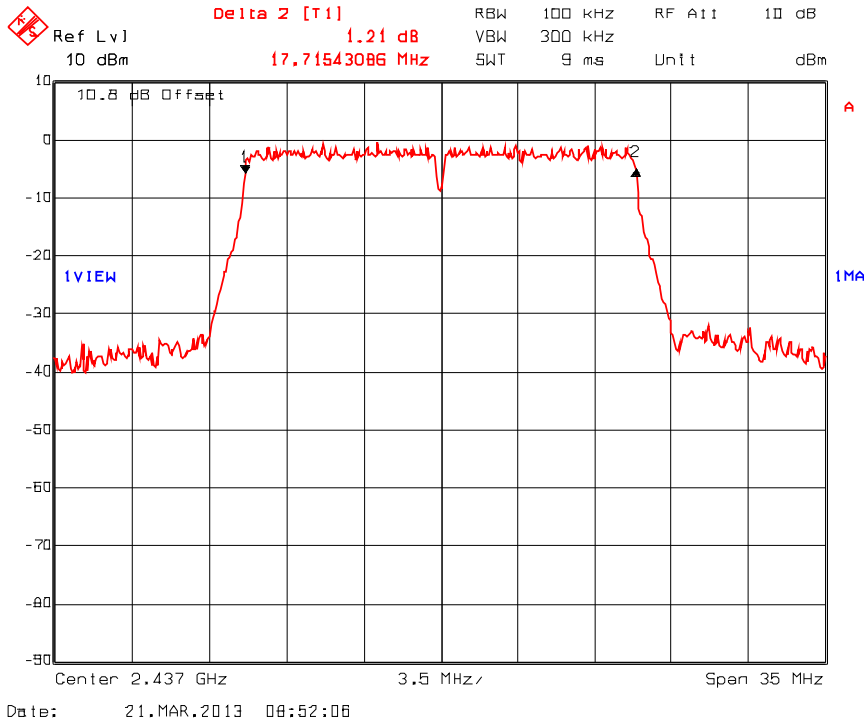

**Plot 5.2.4.30. 6 dB Bandwidth**

Test (specified rules):	FCC 15.247 (a)(2), RSS 210 A8.2(a) 6 dB BW
Date:	March 20 - 21, 2013
Tested by: Name	Hung Trinh
Test method:	KDB 558074 D01 Section 5.1.1 EBW Measurement Procedure
Comment(s):	2462 MHz, 802.11n, 64-QAM 5/6 65 Mbps

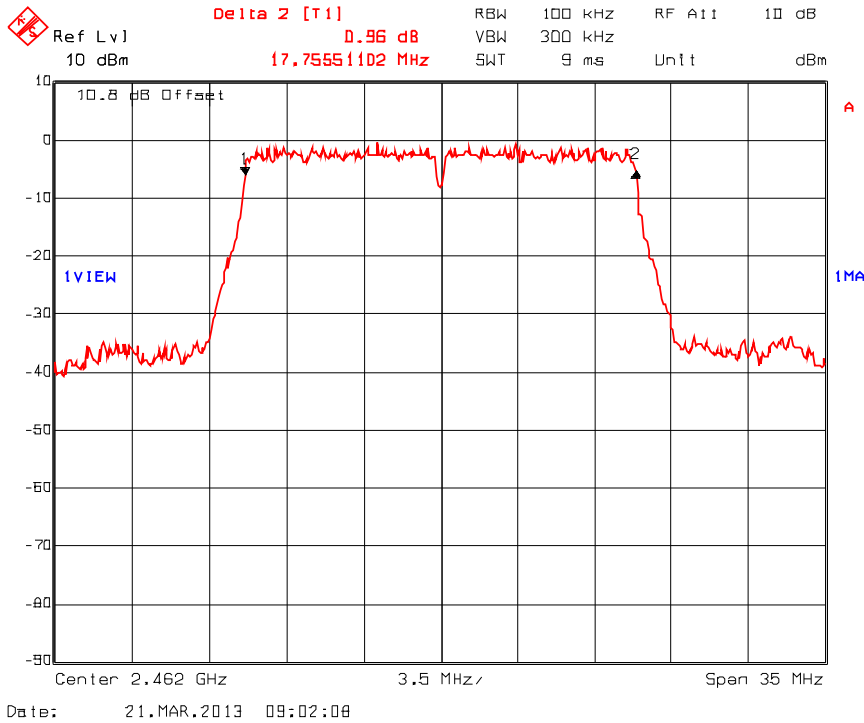

**ULTRATECH GROUP OF LABS**

3000 Bristol Circle, Oakville, Ontario, Canada L6H 6G4  
Tel. #: 905-829-1570, Fax. #: 905-829-8050, Email: [vic@ultratech-labs.com](mailto:vic@ultratech-labs.com), Website: <http://www.ultratech-labs.com>

File #: FLC-007F15C247

March 26, 2013

All test results contained in this engineering test report are traceable to National Institute of Standards and Technology (NIST)

**Plot 5.2.4.31. 99% Bandwidth**

Test (specified rules):	FCC 15.247 (a)(2), RSS 210 A8.2(a) 6 dB BW
Date:	March 20 - 21, 2013
Tested by: Name	Hung Trinh
Test method:	KDB 558074 D01 Section 5.1.1 EBW Measurement Procedure
Comment(s):	2412 MHz, 802.11b, DBPSK 1 Mbps

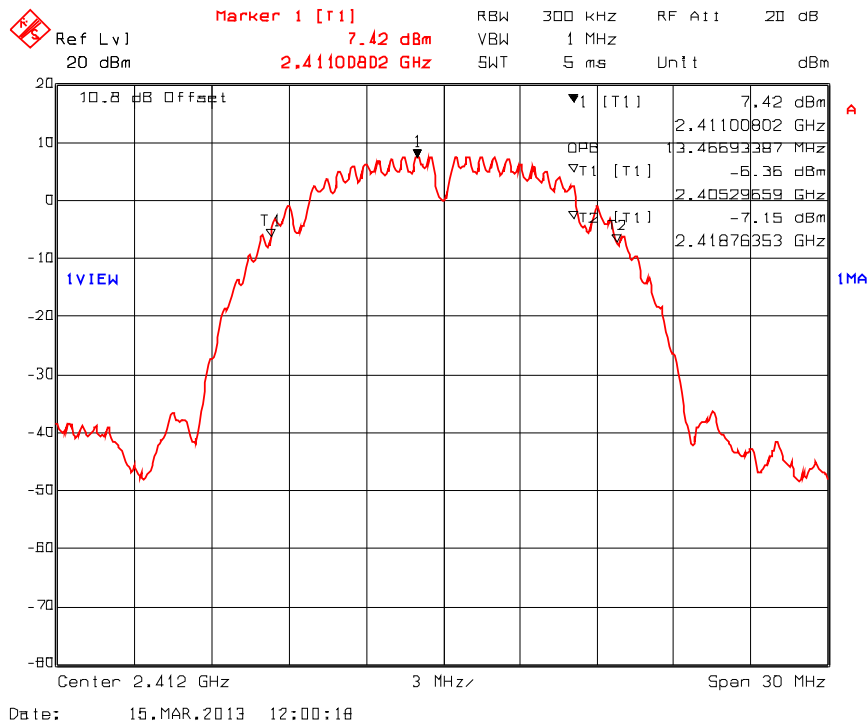

**Plot 5.2.4.32. 99% Bandwidth**

Test (specified rules):	FCC 15.247 (a)(2), RSS 210 A8.2(a) 6 dB BW
Date:	March 20 - 21, 2013
Tested by: Name	Hung Trinh
Test method:	KDB 558074 D01 Section 5.1.1 EBW Measurement Procedure
Comment(s):	2437 MHz, 802.11b, DBPSK 1 Mbps

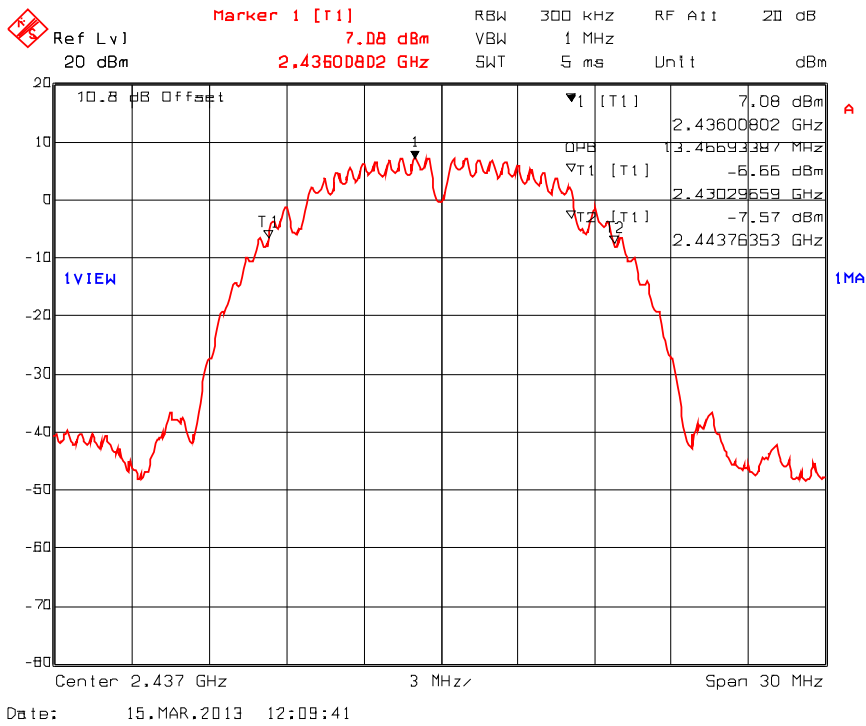

**Plot 5.2.4.33. 99% Bandwidth**

Test (specified rules):	FCC 15.247 (a)(2), RSS 210 A8.2(a) 6 dB BW
Date:	March 20 - 21, 2013
Tested by: Name	Hung Trinh
Test method:	KDB 558074 D01 Section 5.1.1 EBW Measurement Procedure
Comment(s):	2462 MHz, 802.11b, DBPSK 1 Mbps

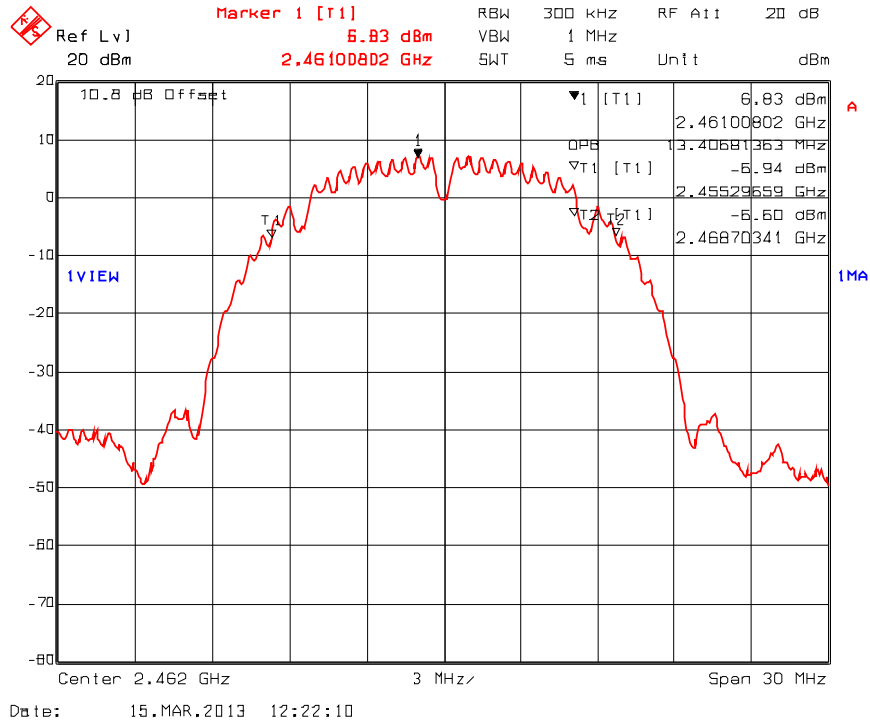

**Plot 5.2.4.34. 99% Bandwidth**

Test (specified rules):	FCC 15.247 (a)(2), RSS 210 A8.2(a) 6 dB BW
Date:	March 20 - 21, 2013
Tested by: Name	Hung Trinh
Test method:	KDB 558074 D01 Section 5.1.1 EBW Measurement Procedure
Comment(s):	2412 MHz, 802.11b, DQPSK 2 Mbps

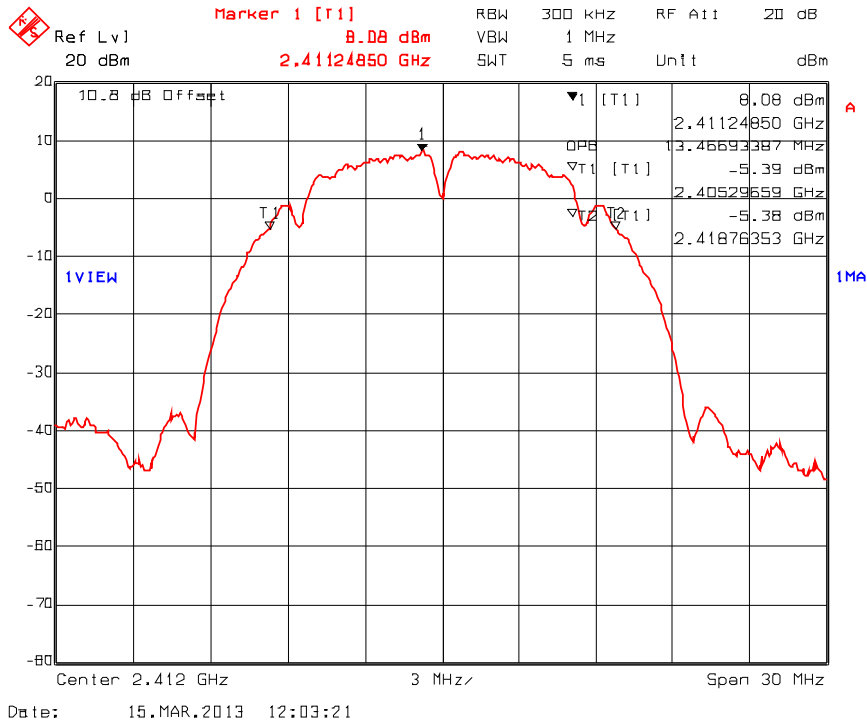

**Plot 5.2.4.35. 99% Bandwidth**

Test (specified rules):	FCC 15.247 (a)(2), RSS 210 A8.2(a) - 99% Occupied Bandwidth
Date:	March 20 - 21, 2013
Tested by: Name	Hung Trinh
Test method:	KDB 558074 D01 Section 5.1.1 EBW Measurement Procedure
Comment(s):	2437 MHz, 802.11b, DQPSK 2 Mbps

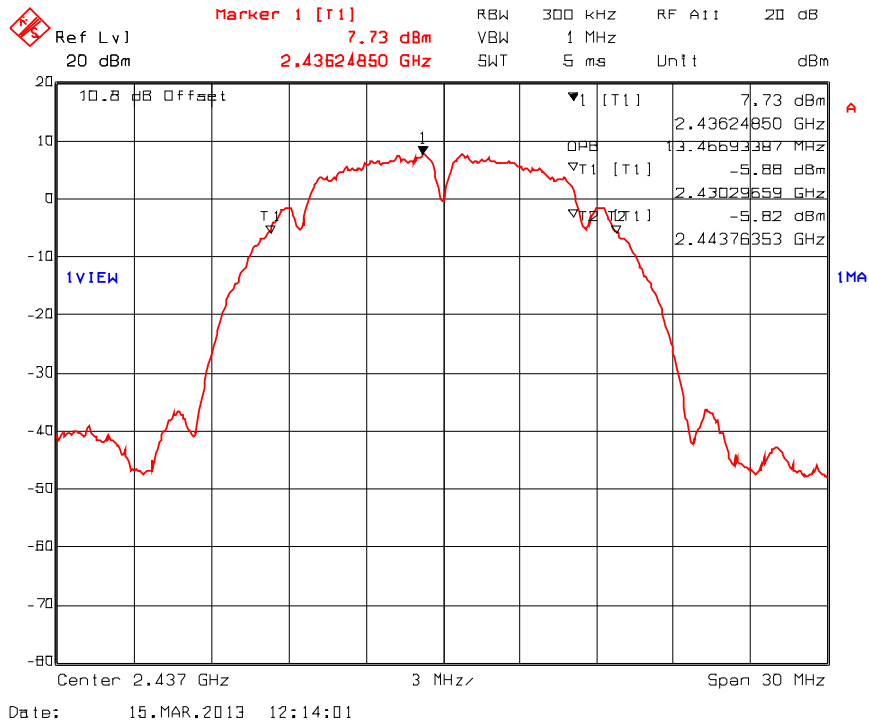

**ULTRATECH GROUP OF LABS**

3000 Bristol Circle, Oakville, Ontario, Canada L6H 6G4  
Tel. #: 905-829-1570, Fax. #: 905-829-8050, Email: [vic@ultratech-labs.com](mailto:vic@ultratech-labs.com), Website: <http://www.ultratech-labs.com>

File #: FLC-007F15C247  
March 26, 2013

All test results contained in this engineering test report are traceable to National Institute of Standards and Technology (NIST)



**Plot 5.2.4.36. 99% Bandwidth**

Test (specified rules):	FCC 15.247 (a)(2), RSS 210 A8.2(a) - 99% Occupied Bandwidth
Date:	March 20 - 21, 2013
Tested by: Name	Hung Trinh
Test method:	KDB 558074 D01 Section 5.1.1 EBW Measurement Procedure
Comment(s):	2462 MHz, 802.11b, DQPSK 2 Mbps

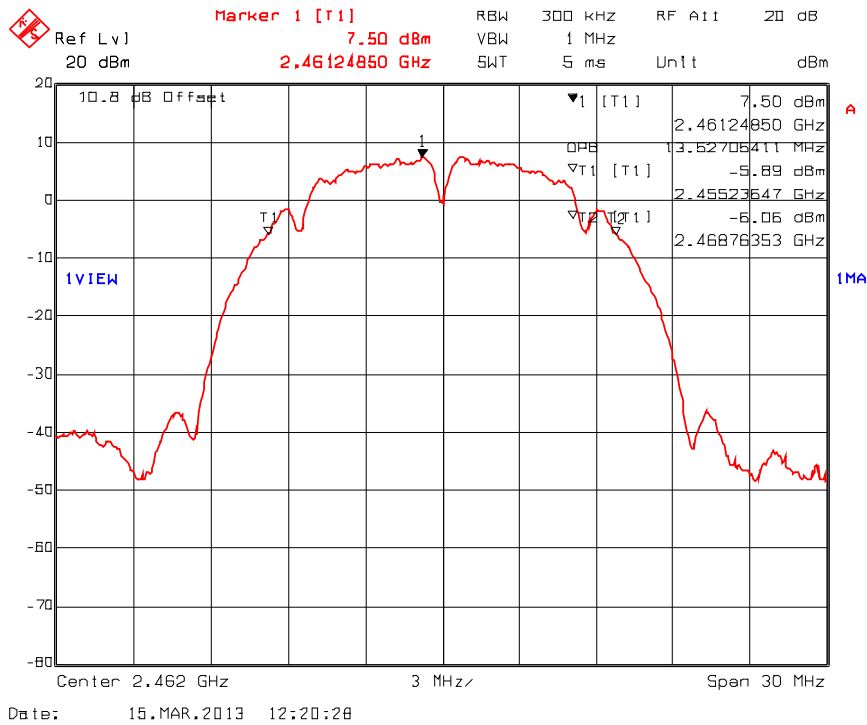

**Plot 5.2.4.37. 99% Bandwidth**

Test (specified rules):	FCC 15.247 (a)(2), RSS 210 A8.2(a) - 99% Occupied Bandwidth
Date:	March 20 - 21, 2013
Tested by: Name	Hung Trinh
Test method:	KDB 558074 D01 Section 5.1.1 EBW Measurement Procedure
Comment(s):	2412 MHz, 802.11b, CCK 11 Mbps

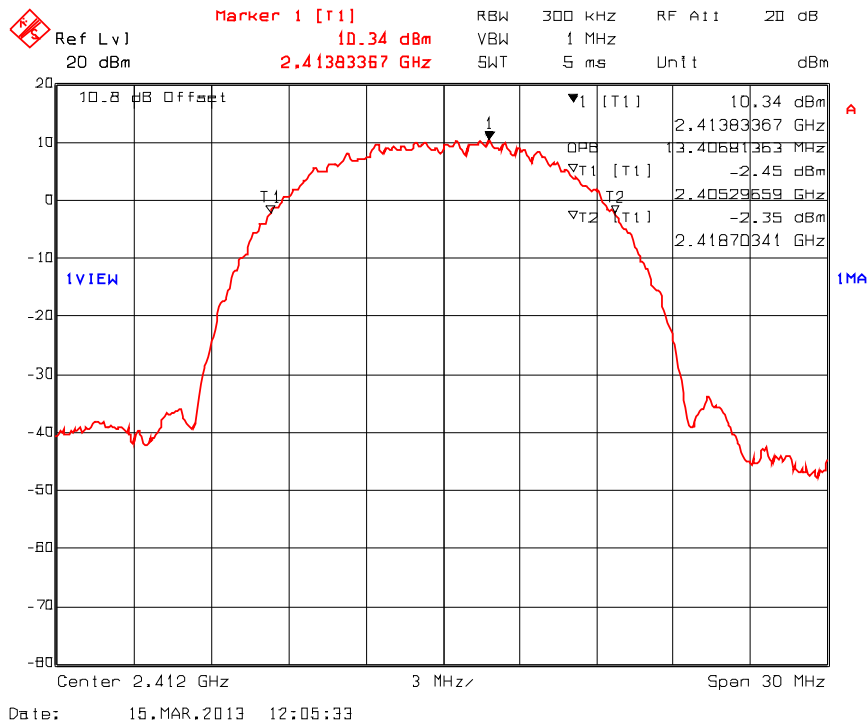

**Plot 5.2.4.38. 99% Bandwidth**

Test (specified rules):	FCC 15.247 (a)(2), RSS 210 A8.2(a) - 99% Occupied Bandwidth
Date:	March 20 - 21, 2013
Tested by: Name	Hung Trinh
Test method:	KDB 558074 D01 Section 5.1.1 EBW Measurement Procedure
Comment(s):	2437 MHz, 802.11b, CCK 11 Mbps

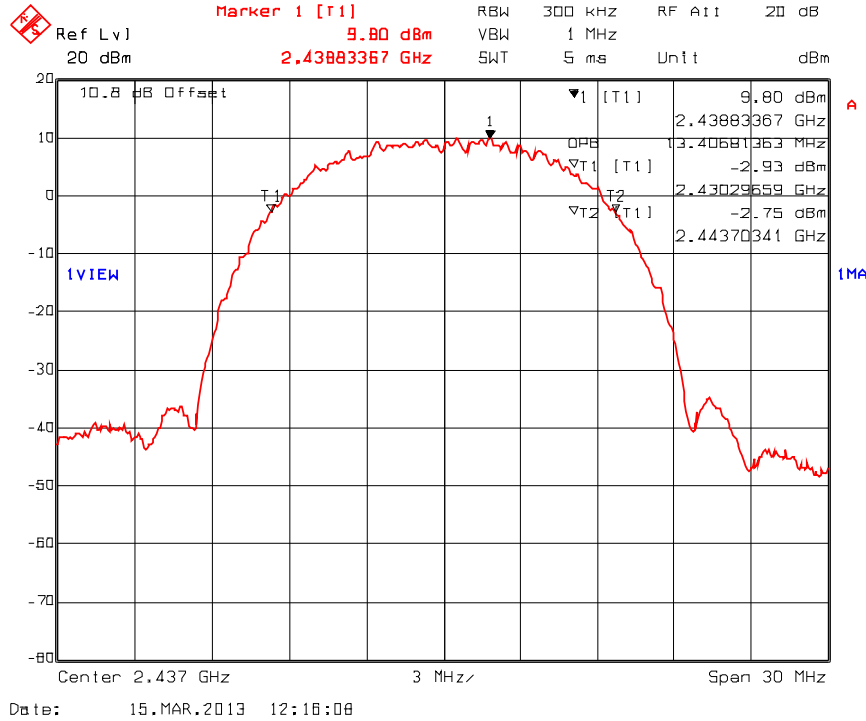

**Plot 5.2.4.39. 99% Bandwidth**

Test (specified rules):	FCC 15.247 (a)(2), RSS 210 A8.2(a) - 99% Occupied Bandwidth
Date:	March 20 - 21, 2013
Tested by: Name	Hung Trinh
Test method:	KDB 558074 D01 Section 5.1.1 EBW Measurement Procedure
Comment(s):	2462 MHz, 802.11b, CCK 11 Mbps

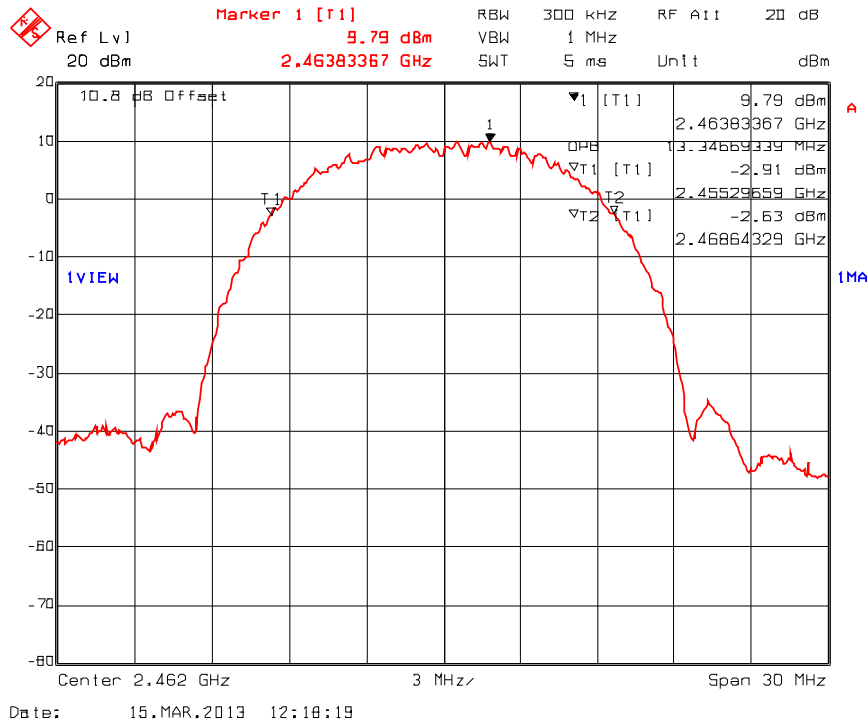

**Plot 5.2.4.40. 99% Bandwidth**

Test (specified rules):	FCC 15.247 (a)(2), RSS 210 A8.2(a) - 99% Occupied Bandwidth
Date:	March 20 - 21, 2013
Tested by: Name	Hung Trinh
Test method:	KDB 558074 D01 Section 5.1.1 EBW Measurement Procedure
Comment(s):	2412 MHz, 802.11g, BPSK 9 Mbps

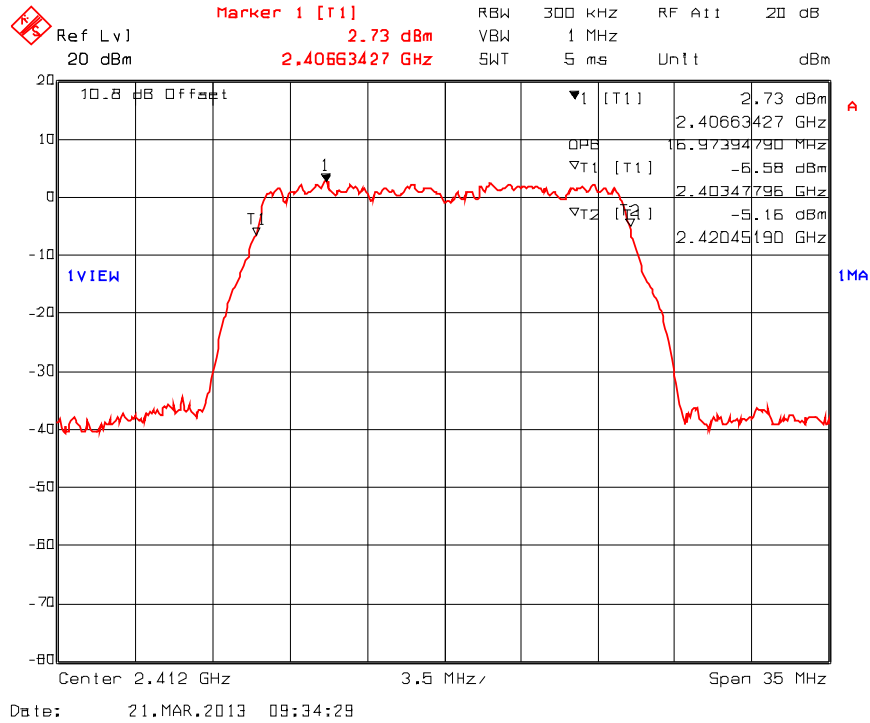

**Plot 5.2.4.41. 99% Bandwidth**

Test (specified rules):	FCC 15.247 (a)(2), RSS 210 A8.2(a) - 99% Occupied Bandwidth
Date:	March 20 - 21, 2013
Tested by: Name	Hung Trinh
Test method:	KDB 558074 D01 Section 5.1.1 EBW Measurement Procedure
Comment(s):	2437 MHz, 802.11g, BPSK 9 Mbps

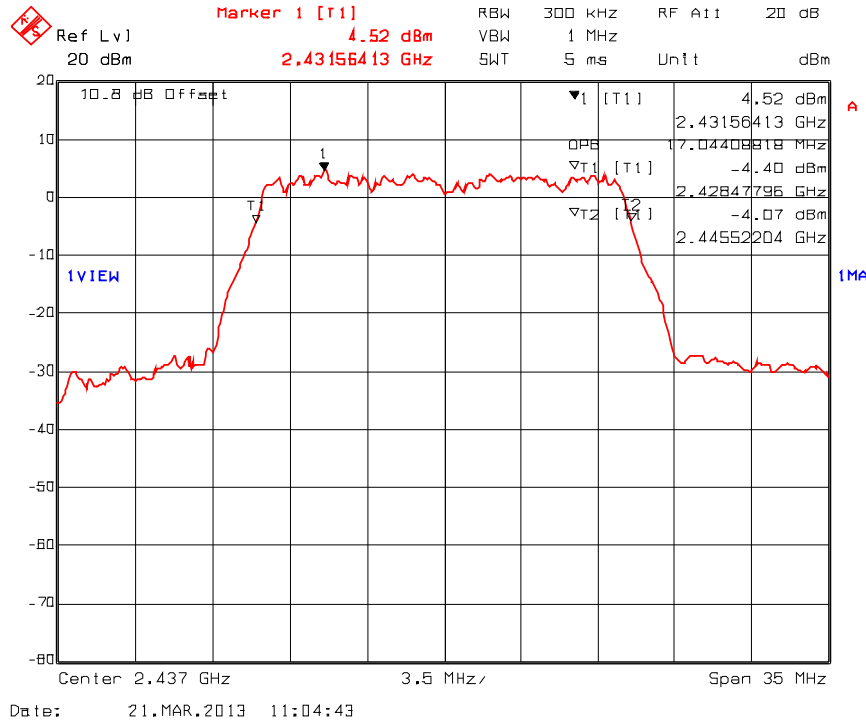

**Plot 5.2.4.42. 99% Bandwidth**

Test (specified rules):	FCC 15.247 (a)(2), RSS 210 A8.2(a) - 99% Occupied Bandwidth
Date:	March 20 - 21, 2013
Tested by: Name	Hung Trinh
Test method:	KDB 558074 D01 Section 5.1.1 EBW Measurement Procedure
Comment(s):	2462 MHz, 802.11g, BPSK 9 Mbps

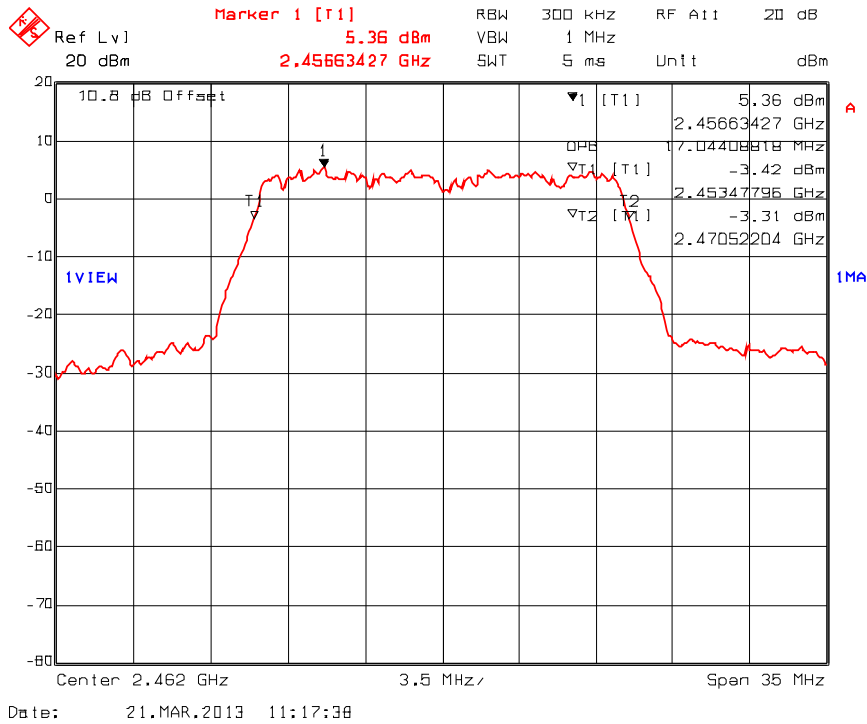

**Plot 5.2.4.43. 99% Bandwidth**

Test (specified rules):	FCC 15.247 (a)(2), RSS 210 A8.2(a) - 99% Occupied Bandwidth
Date:	March 20 - 21, 2013
Tested by: Name	Hung Trinh
Test method:	KDB 558074 D01 Section 5.1.1 EBW Measurement Procedure
Comment(s):	2412 MHz, 802.11g, QPSK 18 Mbps

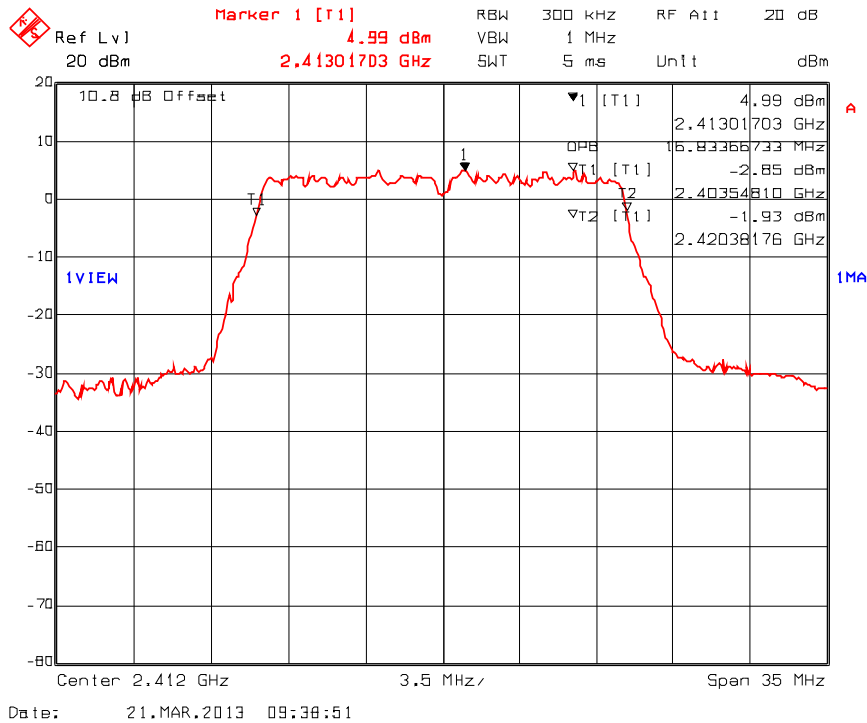



**Plot 5.2.4.44. 99% Bandwidth**

Test (specified rules):	FCC 15.247 (a)(2), RSS 210 A8.2(a) - 99% Occupied Bandwidth
Date:	March 20 - 21, 2013
Tested by: Name	Hung Trinh
Test method:	KDB 558074 D01 Section 5.1.1 EBW Measurement Procedure
Comment(s):	2437 MHz, 802.11g, QPSK 18 Mbps

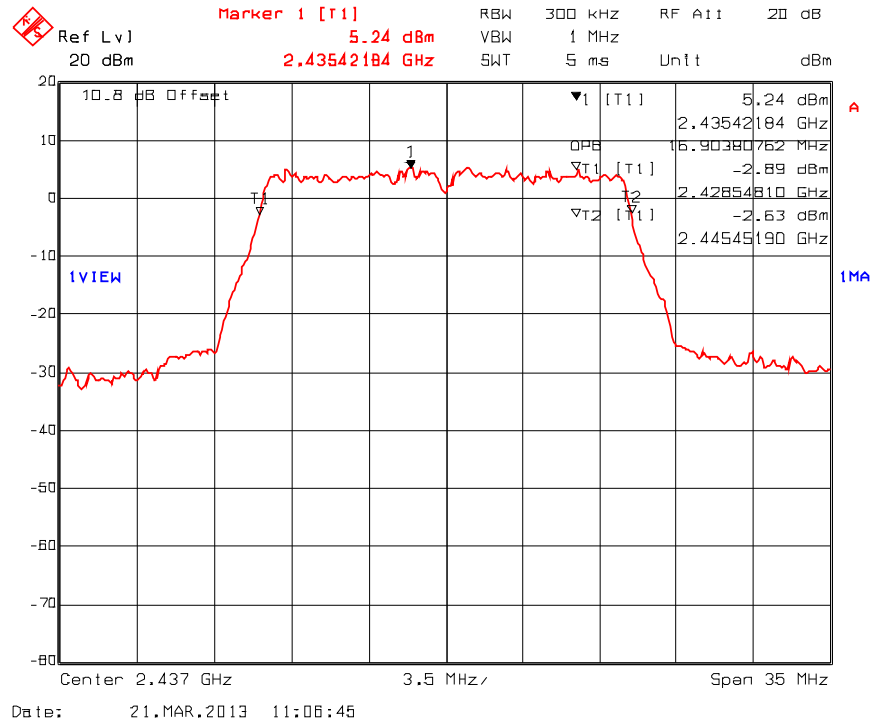

**Plot 5.2.4.45. 99% Bandwidth**

Test (specified rules):	FCC 15.247 (a)(2), RSS 210 A8.2(a) - 99% Occupied Bandwidth
Date:	March 20 - 21, 2013
Tested by: Name	Hung Trinh
Test method:	KDB 558074 D01 Section 5.1.1 EBW Measurement Procedure
Comment(s):	2462 MHz, 802.11g, QPSK 18 Mbps

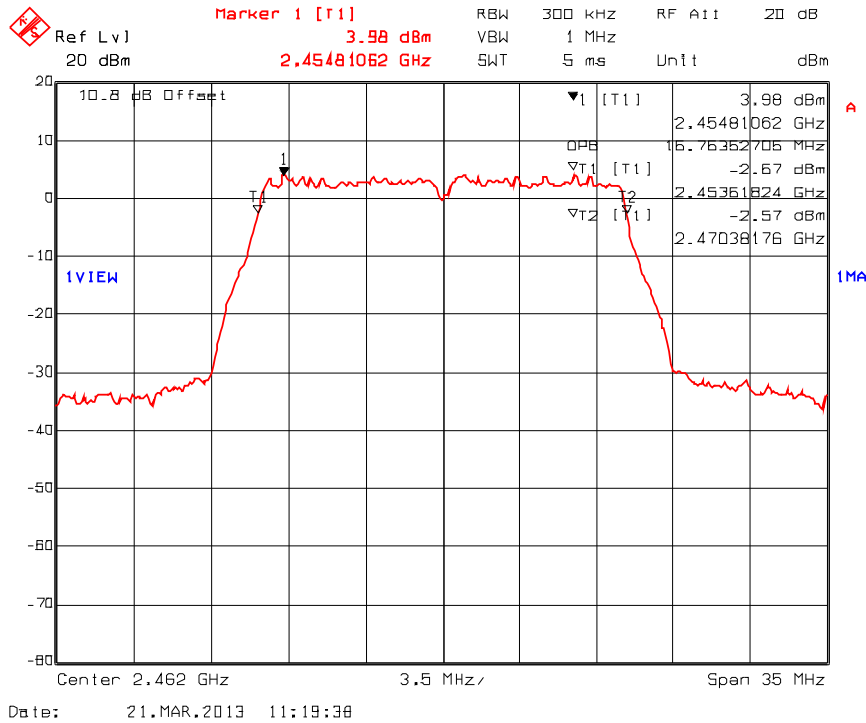

**Plot 5.2.4.46. 99% Bandwidth**

Test (specified rules):	FCC 15.247 (a)(2), RSS 210 A8.2(a) - 99% Occupied Bandwidth
Date:	March 20 - 21, 2013
Tested by: Name	Hung Trinh
Test method:	KDB 558074 D01 Section 5.1.1 EBW Measurement Procedure
Comment(s):	2412 MHz, 802.11g, 16-QAM 36 Mbps

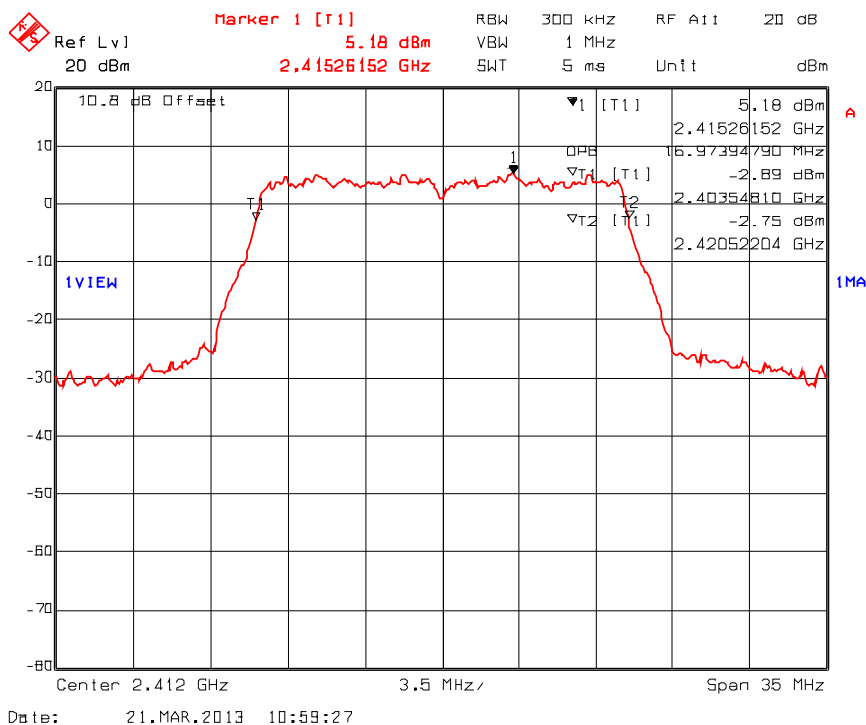

**Plot 5.2.4.47. 99% Bandwidth**

Test (specified rules):	FCC 15.247 (a)(2), RSS 210 A8.2(a) - 99% Occupied Bandwidth
Date:	March 20 - 21, 2013
Tested by: Name	Hung Trinh
Test method:	KDB 558074 D01 Section 5.1.1 EBW Measurement Procedure
Comment(s):	2437 MHz, 802.11g, 16-QAM 36 Mbps

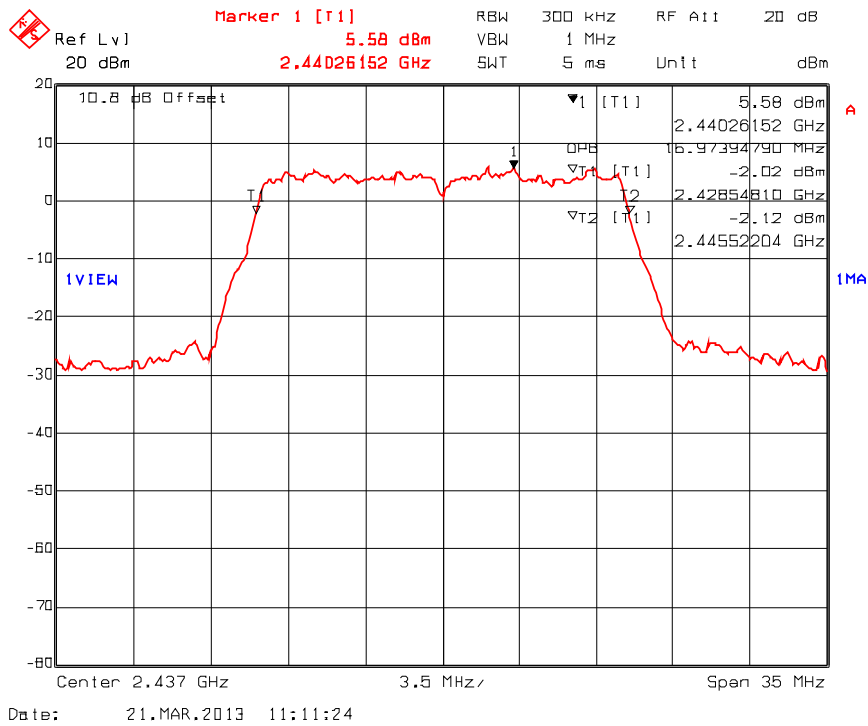

**Plot 5.2.4.48. 99% Bandwidth**

Test (specified rules):	FCC 15.247 (a)(2), RSS 210 A8.2(a) - 99% Occupied Bandwidth
Date:	March 20 - 21, 2013
Tested by: Name	Hung Trinh
Test method:	KDB 558074 D01 Section 5.1.1 EBW Measurement Procedure
Comment(s):	2462 MHz, 802.11g, 16-QAM 36 Mbps

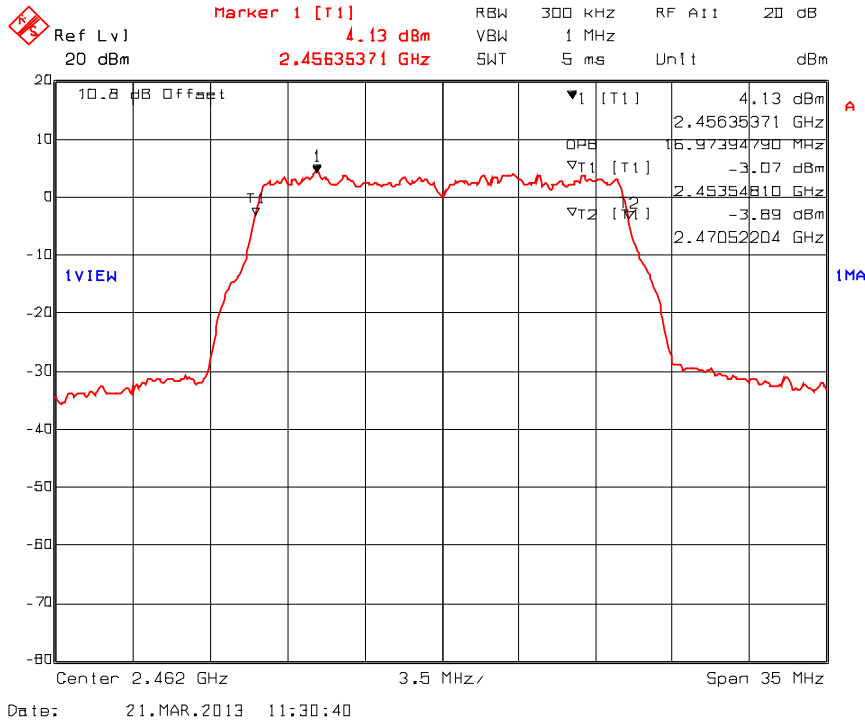

**ULTRATECH GROUP OF LABS**

3000 Bristol Circle, Oakville, Ontario, Canada L6H 6G4  
Tel. #: 905-829-1570, Fax. #: 905-829-8050, Email: [vic@ultratech-labs.com](mailto:vic@ultratech-labs.com), Website: <http://www.ultratech-labs.com>

File #: FLC-007F15C247

March 26, 2013

All test results contained in this engineering test report are traceable to National Institute of Standards and Technology (NIST)

**Plot 5.2.4.49. 99% Bandwidth**

Test (specified rules):	FCC 15.247 (a)(2), RSS 210 A8.2(a) - 99% Occupied Bandwidth
Date:	March 20 - 21, 2013
Tested by: Name	Hung Trinh
Test method:	KDB 558074 D01 Section 5.1.1 EBW Measurement Procedure
Comment(s):	2412 MHz, 802.11g, 64-QAM 54 Mbps

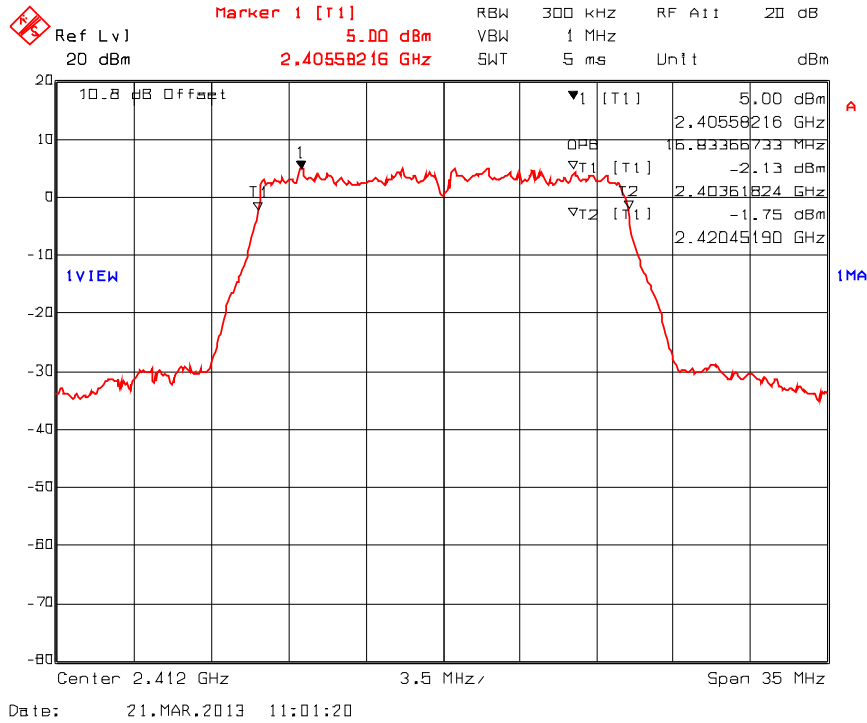

**ULTRATECH GROUP OF LABS**

3000 Bristol Circle, Oakville, Ontario, Canada L6H 6G4  
Tel. #: 905-829-1570, Fax. #: 905-829-8050, Email: [vic@ultratech-labs.com](mailto:vic@ultratech-labs.com), Website: <http://www.ultratech-labs.com>

File #: FLC-007F15C247

March 26, 2013

All test results contained in this engineering test report are traceable to National Institute of Standards and Technology (NIST)

**Plot 5.2.4.50. 99% Bandwidth**

Test (specified rules):	FCC 15.247 (a)(2), RSS 210 A8.2(a) - 99% Occupied Bandwidth
Date:	March 20 - 21, 2013
Tested by: Name	Hung Trinh
Test method:	KDB 558074 D01 Section 5.1.1 EBW Measurement Procedure
Comment(s):	2437 MHz, 802.11g, 64-QAM 54 Mbps

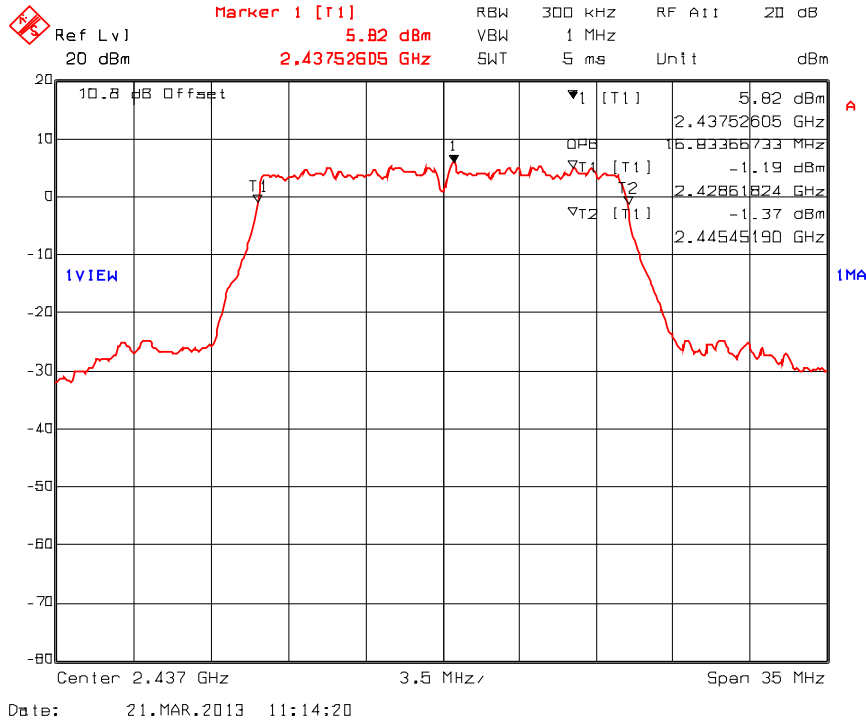

**Plot 5.2.4.51. 99% Bandwidth**

Test (specified rules):	FCC 15.247 (a)(2), RSS 210 A8.2(a) - 99% Occupied Bandwidth
Date:	March 20 - 21, 2013
Tested by: Name	Hung Trinh
Test method:	KDB 558074 D01 Section 5.1.1 EBW Measurement Procedure
Comment(s):	2462 MHz, 802.11g, 64-QAM 54 Mbps

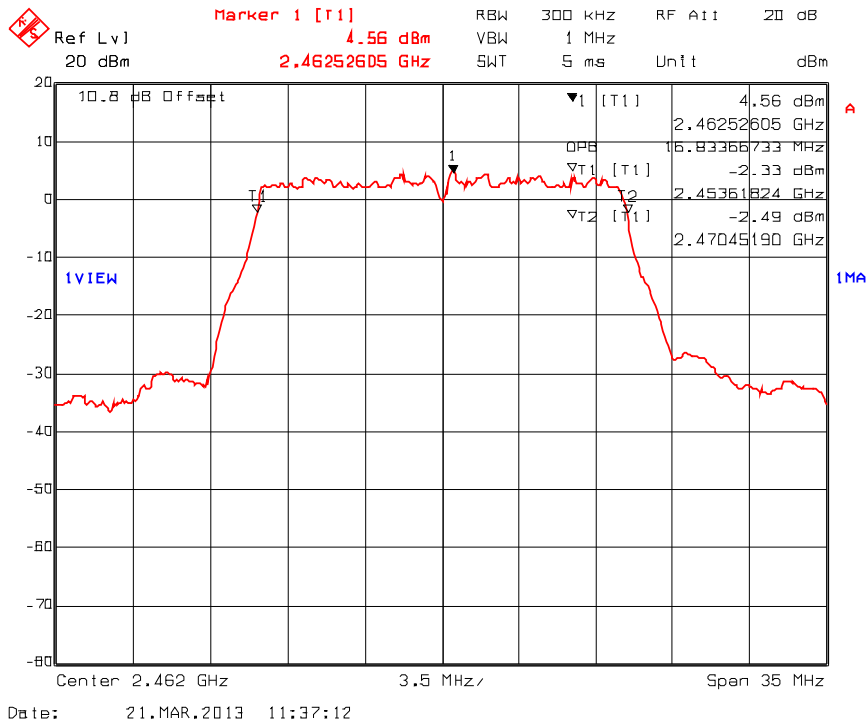



**Plot 5.2.4.52. 99% Bandwidth**

Test (specified rules):	FCC 15.247 (a)(2), RSS 210 A8.2(a) - 99% Occupied Bandwidth
Date:	March 20 - 21, 2013
Tested by: Name	Hung Trinh
Test method:	KDB 558074 D01 Section 5.1.1 EBW Measurement Procedure
Comment(s):	2412 MHz, 802.11n, BPSK 1/2 6.5 Mbps

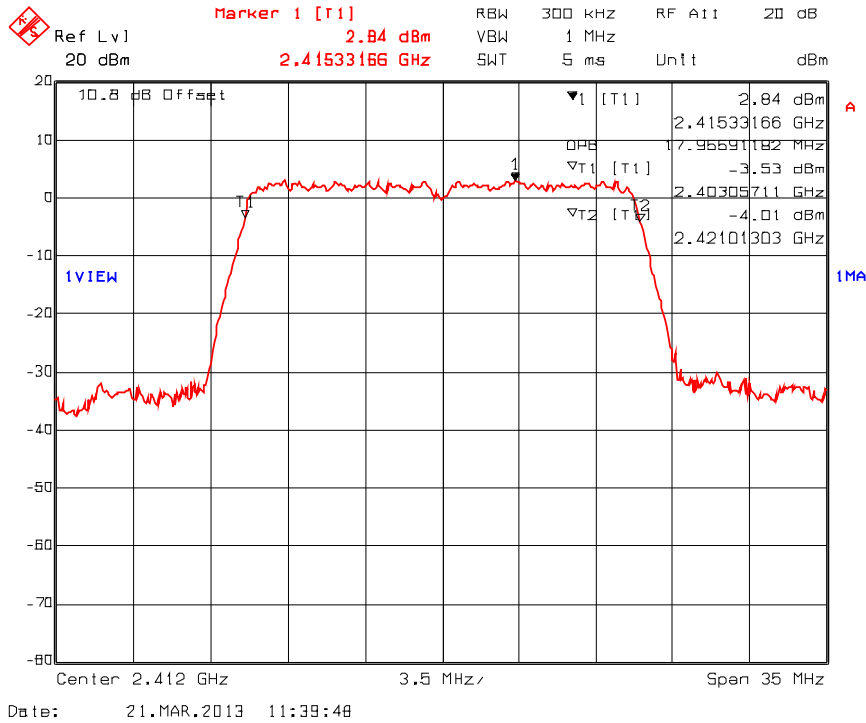

**Plot 5.2.4.53. 99% Bandwidth**

Test (specified rules):	FCC 15.247 (a)(2), RSS 210 A8.2(a) - 99% Occupied Bandwidth
Date:	March 20 - 21, 2013
Tested by: Name	Hung Trinh
Test method:	KDB 558074 D01 Section 5.1.1 EBW Measurement Procedure
Comment(s):	2437 MHz, 802.11n, BPSK 1/2 6.5 Mbps

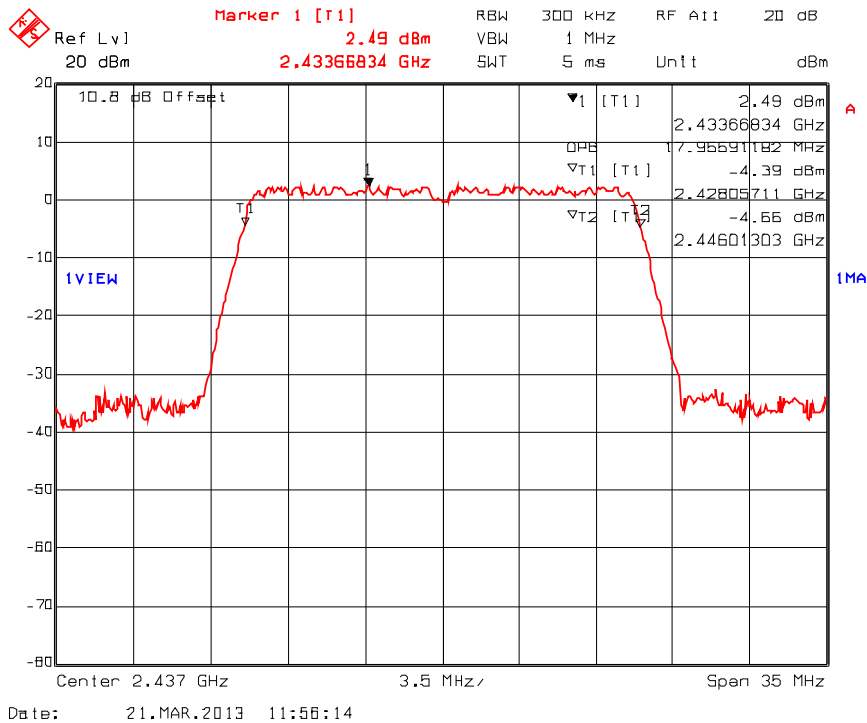

**ULTRATECH GROUP OF LABS**

3000 Bristol Circle, Oakville, Ontario, Canada L6H 6G4  
Tel. #: 905-829-1570, Fax. #: 905-829-8050, Email: [vic@ultratech-labs.com](mailto:vic@ultratech-labs.com), Website: <http://www.ultratech-labs.com>

File #: FLC-007F15C247  
March 26, 2013

All test results contained in this engineering test report are traceable to National Institute of Standards and Technology (NIST)

**Plot 5.2.4.54. 99% Bandwidth**

Test (specified rules):	FCC 15.247 (a)(2), RSS 210 A8.2(a) - 99% Occupied Bandwidth
Date:	March 20 - 21, 2013
Tested by: Name	Hung Trinh
Test method:	KDB 558074 D01 Section 5.1.1 EBW Measurement Procedure
Comment(s):	2462 MHz, 802.11n, BPSK 1/2 6.5 Mbps

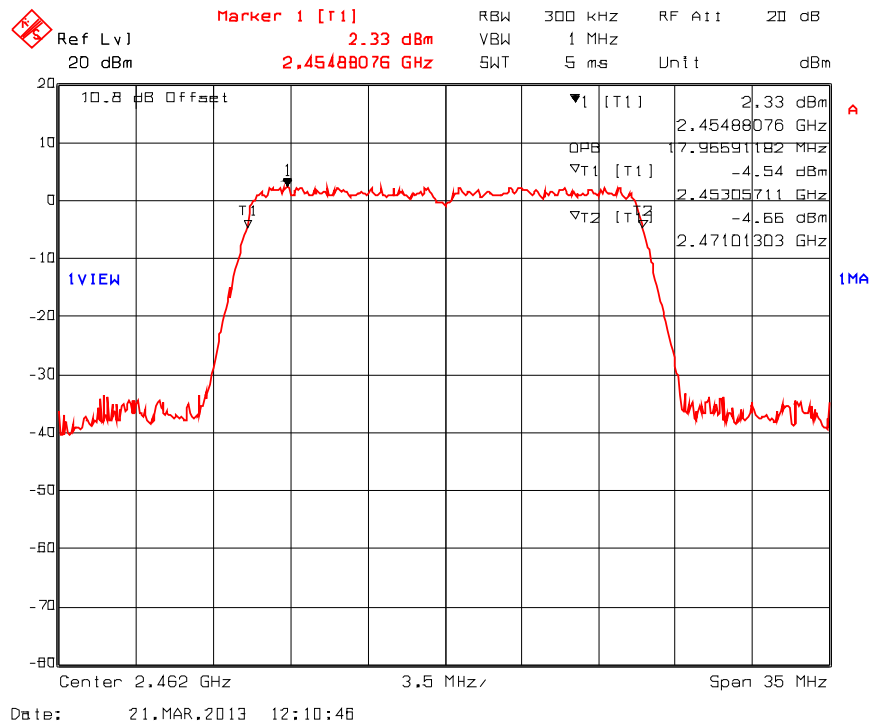

**ULTRATECH GROUP OF LABS**

3000 Bristol Circle, Oakville, Ontario, Canada L6H 6G4  
Tel. #: 905-829-1570, Fax. #: 905-829-8050, Email: [vic@ultratech-labs.com](mailto:vic@ultratech-labs.com), Website: <http://www.ultratech-labs.com>

File #: FLC-007F15C247

March 26, 2013

All test results contained in this engineering test report are traceable to National Institute of Standards and Technology (NIST)

**Plot 5.2.4.55. 99% Bandwidth**

Test (specified rules):	FCC 15.247 (a)(2), RSS 210 A8.2(a) - 99% Occupied Bandwidth
Date:	March 20 - 21, 2013
Tested by: Name	Hung Trinh
Test method:	KDB 558074 D01 Section 5.1.1 EBW Measurement Procedure
Comment(s):	2412 MHz, 802.11n, QPSK $\frac{3}{4}$ 19.5 Mbps

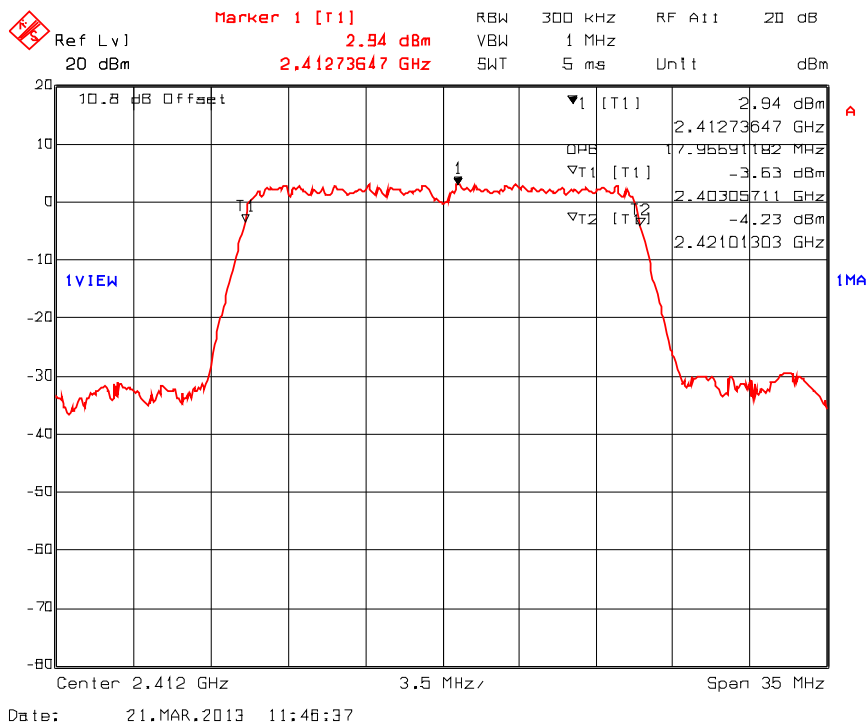

**Plot 5.2.4.56. 99% Bandwidth**

Test (specified rules):	FCC 15.247 (a)(2), RSS 210 A8.2(a) - 99% Occupied Bandwidth
Date:	March 20 - 21, 2013
Tested by: Name	Hung Trinh
Test method:	KDB 558074 D01 Section 5.1.1 EBW Measurement Procedure
Comment(s):	2437 MHz, 802.11n, QPSK $\frac{3}{4}$ 19.5 Mbps

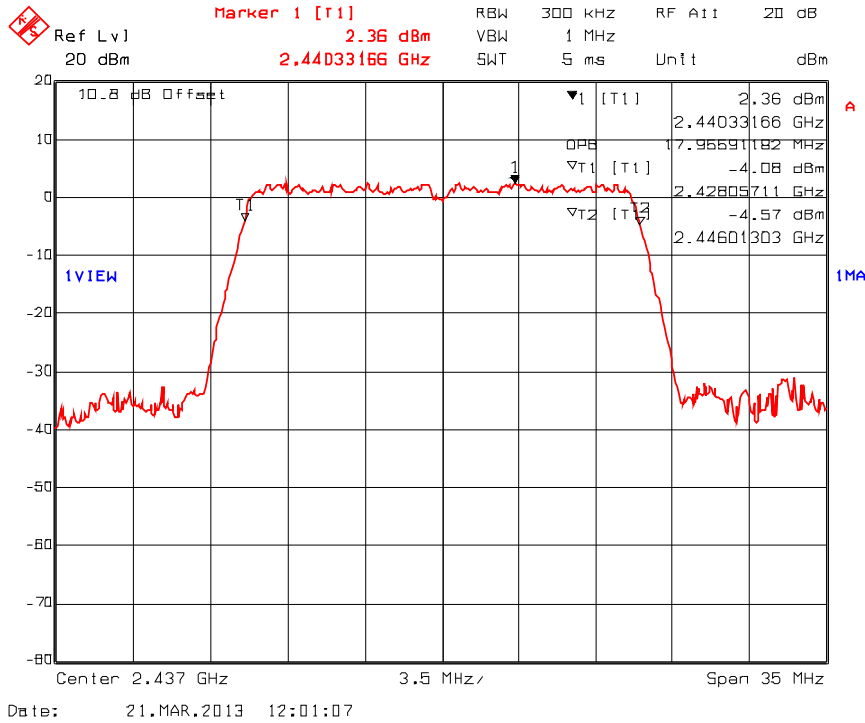

**Plot 5.2.4.57. 99% Bandwidth**

Test (specified rules):	FCC 15.247 (a)(2), RSS 210 A8.2(a) - 99% Occupied Bandwidth
Date:	March 20 - 21, 2013
Tested by: Name	Hung Trinh
Test method:	KDB 558074 D01 Section 5.1.1 EBW Measurement Procedure
Comment(s):	2462 MHz, 802.11n, QPSK 3/4 19.5 Mbps

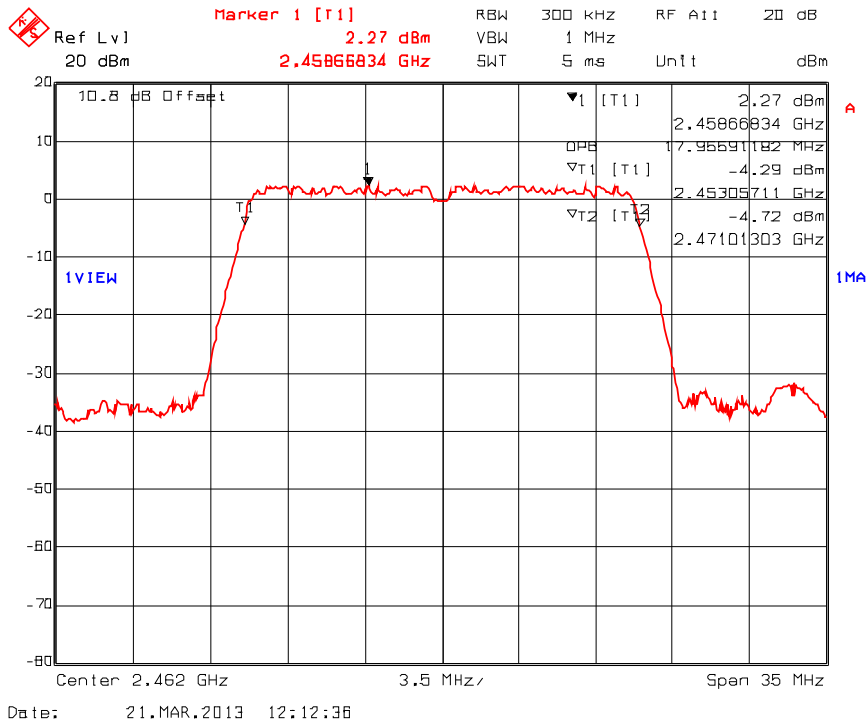

**Plot 5.2.4.58. 99% Bandwidth**

Test (specified rules):	FCC 15.247 (a)(2), RSS 210 A8.2(a) - 99% Occupied Bandwidth
Date:	March 20 - 21, 2013
Tested by: Name	Hung Trinh
Test method:	KDB 558074 D01 Section 5.1.1 EBW Measurement Procedure
Comment(s):	2412 MHz, 802.11n, 16-QAM 3/4 39 Mbps

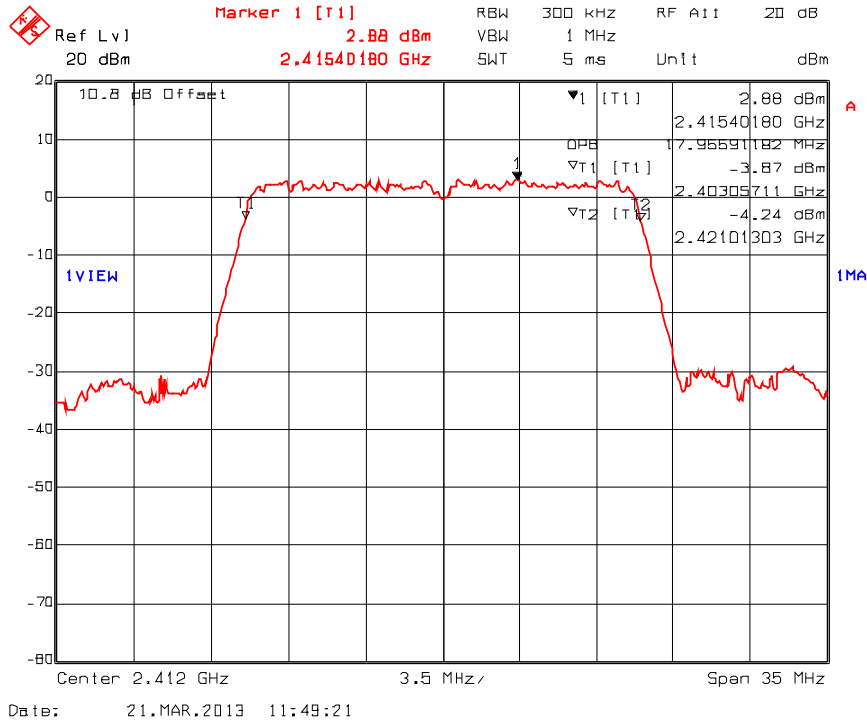

**Plot 5.2.4.59. 99% Bandwidth**

Test (specified rules):	FCC 15.247 (a)(2), RSS 210 A8.2(a) - 99% Occupied Bandwidth
Date:	March 20 - 21, 2013
Tested by: Name	Hung Trinh
Test method:	KDB 558074 D01 Section 5.1.1 EBW Measurement Procedure
Comment(s):	2437 MHz, 802.11n, 16-QAM 3/4 39 Mbps

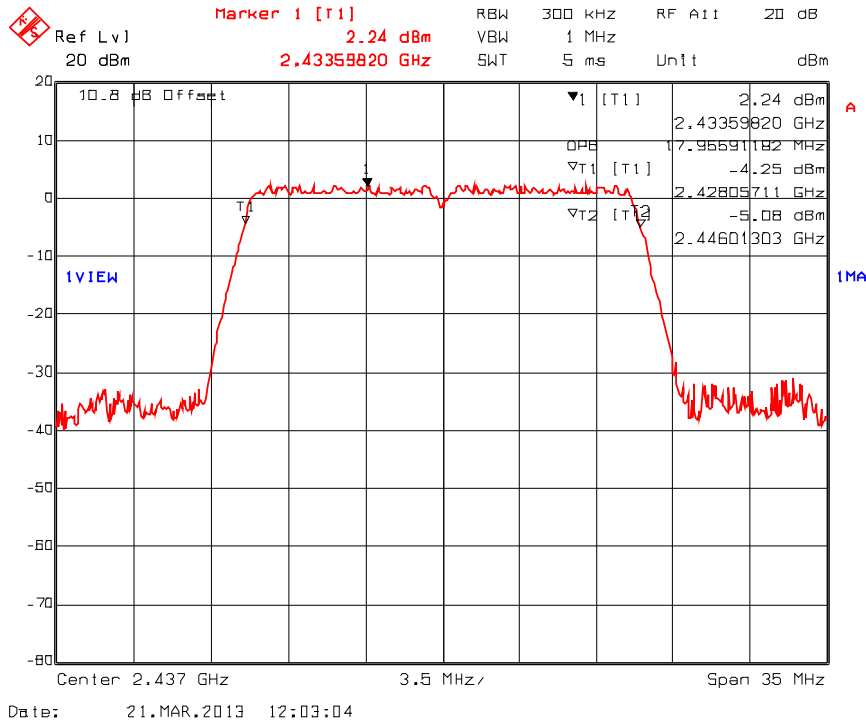



**Plot 5.2.4.60. 99% Bandwidth**

Test (specified rules):	FCC 15.247 (a)(2), RSS 210 A8.2(a) - 99% Occupied Bandwidth
Date:	March 20 - 21, 2013
Tested by: Name	Hung Trinh
Test method:	KDB 558074 D01 Section 5.1.1 EBW Measurement Procedure
Comment(s):	2462 MHz, 802.11n, 16-QAM ¾ 39 Mbps

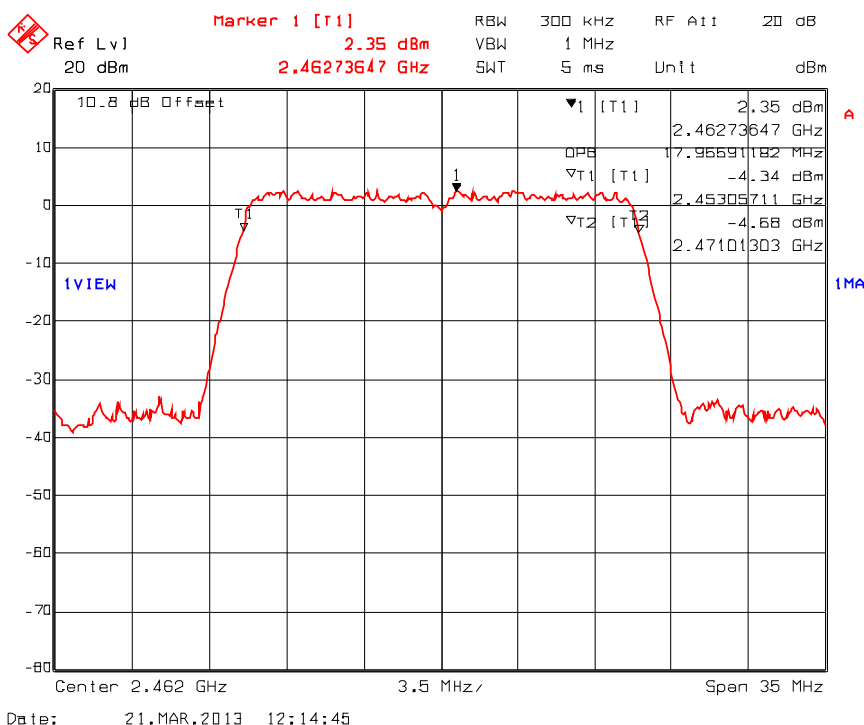

**ULTRATECH GROUP OF LABS**

3000 Bristol Circle, Oakville, Ontario, Canada L6H 6G4  
Tel. #: 905-829-1570, Fax. #: 905-829-8050, Email: [vic@ultratech-labs.com](mailto:vic@ultratech-labs.com), Website: <http://www.ultratech-labs.com>

File #: FLC-007F15C247  
March 26, 2013

All test results contained in this engineering test report are traceable to National Institute of Standards and Technology (NIST)

**Plot 5.2.4.61. 99% Bandwidth**

Test (specified rules):	FCC 15.247 (a)(2), RSS 210 A8.2(a) - 99% Occupied Bandwidth
Date:	March 20 - 21, 2013
Tested by: Name	Hung Trinh
Test method:	KDB 558074 D01 Section 5.1.1 EBW Measurement Procedure
Comment(s):	2412 MHz, 802.11n, 64-QAM 5/6 65 Mbps

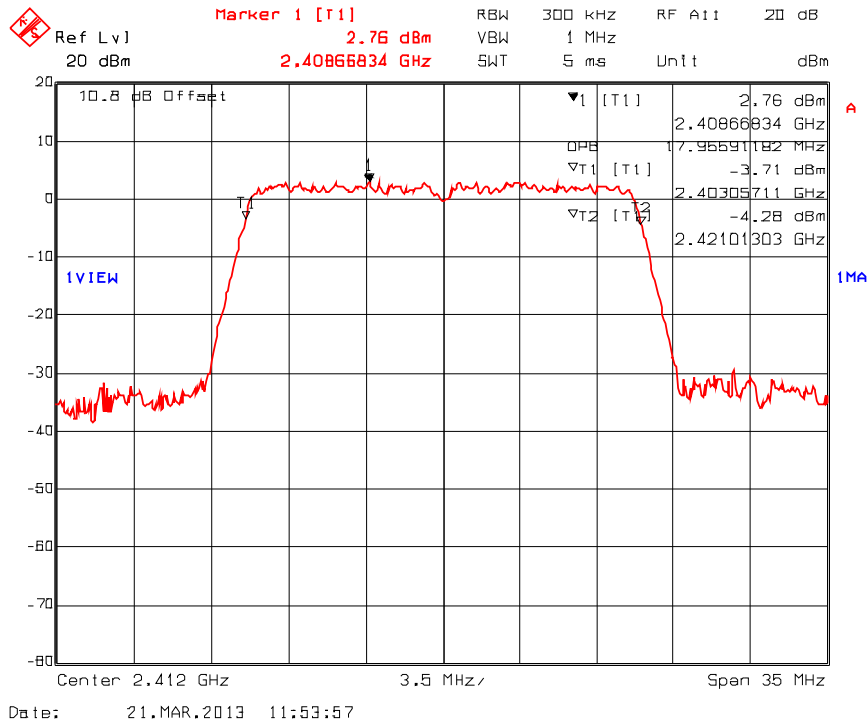

**Plot 5.2.4.62. 99% Bandwidth**

Test (specified rules):	FCC 15.247 (a)(2), RSS 210 A8.2(a) - 99% Occupied Bandwidth
Date:	March 20 - 21, 2013
Tested by: Name	Hung Trinh
Test method:	KDB 558074 D01 Section 5.1.1 EBW Measurement Procedure
Comment(s):	2437 MHz, 802.11n, 64-QAM 5/6 65 Mbps

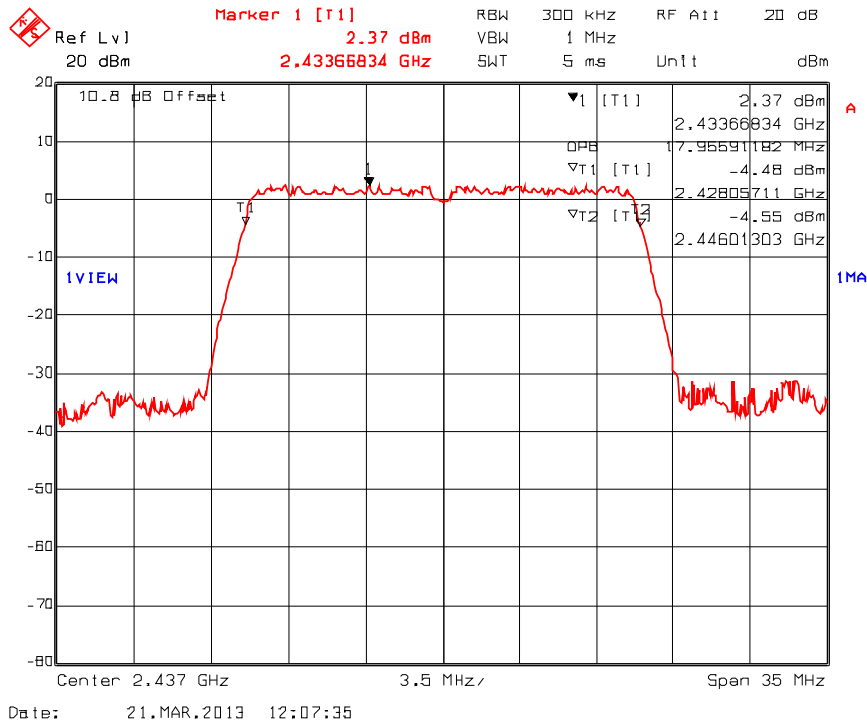

**Plot 5.2.4.63. 99% Bandwidth**

Test (specified rules):	FCC 15.247 (a)(2), RSS 210 A8.2(a) - 99% Occupied Bandwidth
Date:	March 20 - 21, 2013
Tested by: Name	Hung Trinh
Test method:	KDB 558074 D01 Section 5.1.1 EBW Measurement Procedure
Comment(s):	2462 MHz, 802.11n, 64-QAM 5/6 65 Mbps

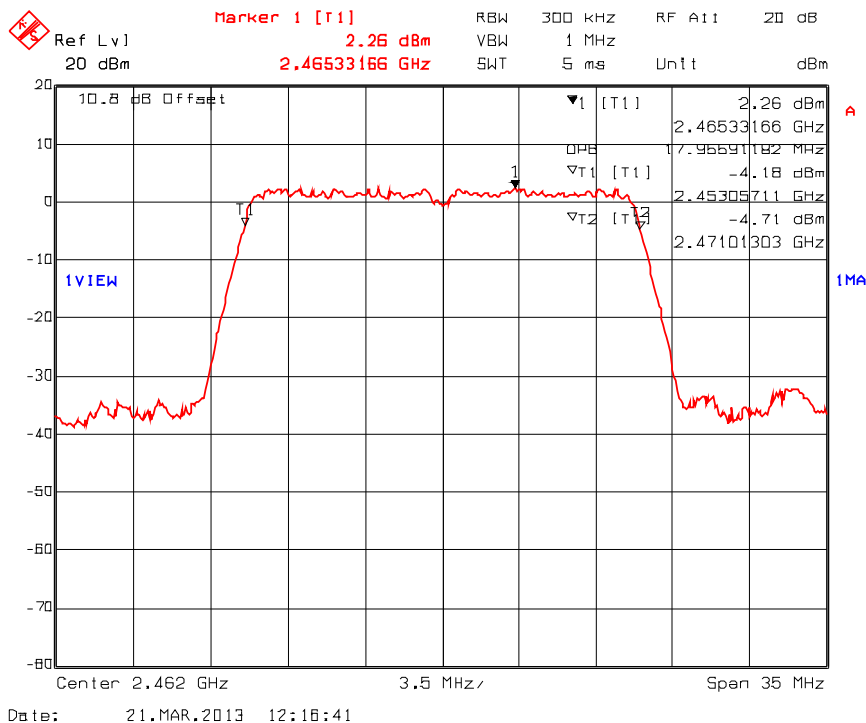

### 5.3. PEAK CONDUCTED OUTPUT POWER - DTS [§ 15.247(b)(3)]

#### 5.3.1. Limit(s)

**§ 15.247(b)(3):** For systems using digital modulation in the 902-928 MHz, 2400-2483.5 MHz, and 5725-5850 MHz bands: 1 Watt. As an alternative to a peak power measurement, compliance with the one Watt limit can be based on a measurement of the maximum conducted output power. Maximum Conducted Output Power is defined as the total transmit power delivered to all antennas and antenna elements averaged across all symbols in the signaling alphabet when the transmitter is operating at its maximum power control level. Power must be summed across all antennas and antenna elements. The average must not include any time intervals during which the transmitter is off or is transmitting at a reduced power level. If multiple modes of operation are possible (e.g., alternative modulation methods), the maximum conducted output power is the highest total transmit power occurring in any mode.

**§15.247(b)(4):** The conducted output power limit specified in paragraph (b) of this section is based on the use of antennas with directional gains that do not exceed 6 dBi. Except as shown in paragraph (c) of this section, if transmitting antennas of directional gain greater than 6 dBi are used, the conducted output power from the intentional radiator shall be reduced below the stated values in paragraphs (b)(1), (b)(2), and (b)(3) of this section, as appropriate, by the amount in dB that the directional gain of the antenna exceeds 6 dBi.

#### 5.3.2. Method of Measurements

KDB Publication No. 558074 D01 Section 5.2.1.2 Measurement Procedure PK2.

#### 5.3.3. Test Instruments

Test Instruments	Manufacturer	Model No.	Serial No.	Frequency Range	Calibration Due Date
Power Meter	Hewlett Packard	8900D	2131A01044	100 MHz–18 GHz	13 Nov 2013
Attenuator	Pasternack	PE7024-10	4	DC–26.5 GHz	Cal on use
DC Block	Hewlett Packard	11742A	12460	0.045–26.5 GHz	Cal on use

#### 5.3.4. Test Arrangement

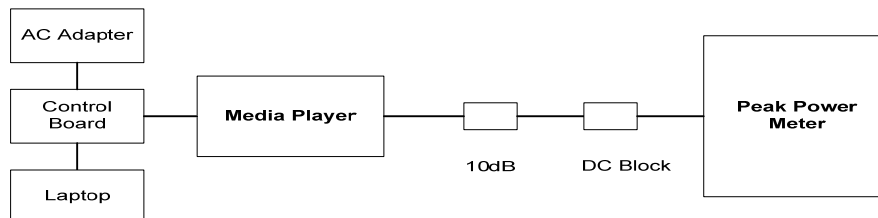

5.3.5. Test Data

Notes: EIRP = P<sub>dBm</sub> + G<sub>dBi</sub>, where G<sub>dBi</sub> = 1.9 dBi maximum antenna gain.

Operation Mode	Frequency (MHz)	Modulation	Data Rate (Mbps)	Peak Conducted Power P (dBm)	Peak EIRP (dBm)	Peak Conducted Power Limit (dBm)	EIRP Limit (dBm)	
802.11b	2412	DBPSK	1	17.30	19.20	30	36	
		DQPSK	2	17.71	19.61	30	36	
		CCK	11	<b>18.05</b>	<b>19.95</b>	30	36	
	2437	DBPSK	1	17.52	19.42	30	36	
		DQPSK	2	17.55	19.45	30	36	
		CCK	11	17.52	19.42	30	36	
	2462	DBPSK	1	17.36	19.26	30	36	
		DQPSK	2	17.41	19.31	30	36	
		CCK	11	17.37	19.27	30	36	
	802.11g	2412	BPSK	9	19.89	21.79	30	36
			QPSK	18	18.77	20.67	30	36
			16-QAM	36	19.21	21.11	30	36
64-QAM			54	19.70	21.60	30	36	
2437		BPSK	9	19.89	21.79	30	36	
		QPSK	18	18.76	20.66	30	36	
		16-QAM	36	19.21	21.11	30	36	
		64-QAM	54	19.33	21.23	30	36	
2462		BPSK	9	<b>20.15</b>	<b>22.05</b>	30	36	
		QPSK	18	18.68	20.58	30	36	
		16-QAM	36	19.16	21.06	30	36	
		64-QAM	54	19.31	21.21	30	36	
802.11n	2412	BPSK 1/2	6.5	<b>18.39</b>	<b>20.29</b>	30	36	
		QPSK 3/4	19.5	18.33	20.23	30	36	
		16-QAM 3/4	39	18.35	20.25	30	36	
		64-QAM 5/6	65	18.32	20.22	30	36	
	2437	BPSK 1/2	6.5	17.91	19.81	30	36	
		QPSK 3/4	19.5	17.90	19.80	30	36	
		16-QAM 3/4	39	17.91	19.81	30	36	
		64-QAM 5/6	65	17.94	19.84	30	36	
	2462	BPSK 1/2	6.5	17.94	19.84	30	36	
		QPSK 3/4	19.5	17.94	19.84	30	36	
		16-QAM 3/4	39	17.88	19.78	30	36	
		64-QAM 5/6	65	17.91	19.81	30	36	

## 5.4. TRANSMITTER BAND-EDGE & SPURIOUS CONDUCTED EMISSIONS [§ 15.247(d)]

### 5.4.1. Limit(s)

§ 15.247 (d): In any 100 kHz bandwidth outside the frequency band in which the spread spectrum or digitally modulated intentional radiator is operating, the radio frequency power that is produced by the intentional radiator shall be at least 20 dB below that in the 100 kHz bandwidth within the band that contains the highest level of the desired power, based on either an RF conducted or a radiated measurement, provided the transmitter demonstrates compliance with the peak conducted power limits. If the transmitter complies with the conducted power limits based on the use of RMS averaging over a time interval, as permitted under paragraph (b)(3) of this section, the attenuation required under this paragraph shall be 30 dB instead of 20 dB.

### 5.4.2. Method of Measurements

KDB Publication No. 558074 D01, Sections 5.4.2.2.4 Band-Edge Measurements, 5.4.1 Unwanted Emissions into Non-Restricted Bands, 5.4.2 Unwanted Emissions into Restricted Frequency Bands, 5.4.2.2.1.1 Peak Power Procedure, 5.4.2.2.2.1 Measurement Procedure RBAVG1 (Power Averaging) and 5.4.2.2.3 Applicability of §15.35(b) and §15.35(c).

### 5.4.3. Test Instruments

Test Instruments	Manufacturer	Model No.	Serial No.	Frequency Range	Calibration Due Date
Spectrum Analyzer	Rohde & Schwarz	FSEK30	100077	20Hz–40 GHz	2 Nov 2013
Attenuator	Pasternack	PE7024-10	4	DC–26.5 GHz	Cal on use
DC Block	Hewlett Packard	11742A	12460	0.045–26.5 GHz	Cal on use
High Pass Filter	K & L	11SH10-4000/T12000	4	Cut off 2.4 GHz	Cal on use
Laptop	Dell	PPL	9321C-12800-8A2-3775	-	-

### 5.4.4. Test Arrangement

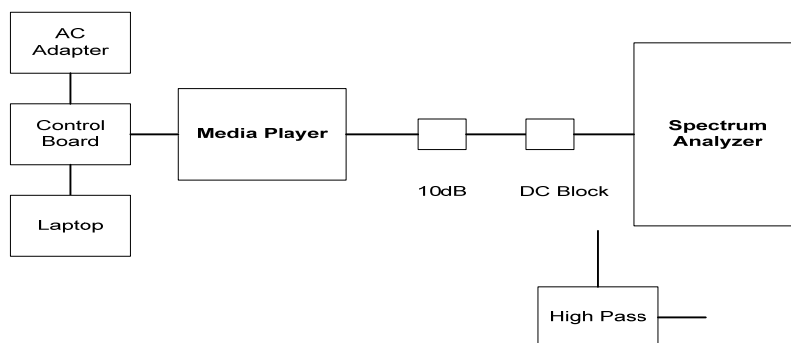

5.4.5. Test Data

**Remark:** The occupied bandwidths of 802.11b, 802.11g, and 802.11n were found similar. Therefore, the rf signals with the highest data rate of among 802.11b, 802.11g and 802.11n were chosen for testing to represent the worst case of emissions.

5.4.5.1. Band-Edge RF Conducted Emissions

Plot 5.4.5.1.1. Band-Edge RF Conducted Emissions

Test (specified rules):	FCC 15.247 (d) RSS 210 A8.5(a) Band-Edge Conducted
Date:	March 18, 2013
Tested by: Name	Hung Trinh
Test method:	KDB 558074 D01 Section 10.2.5 Band-Edge Conducted
Comment(s):	802.11b, CCK 11 Mbps

Lower Edge:

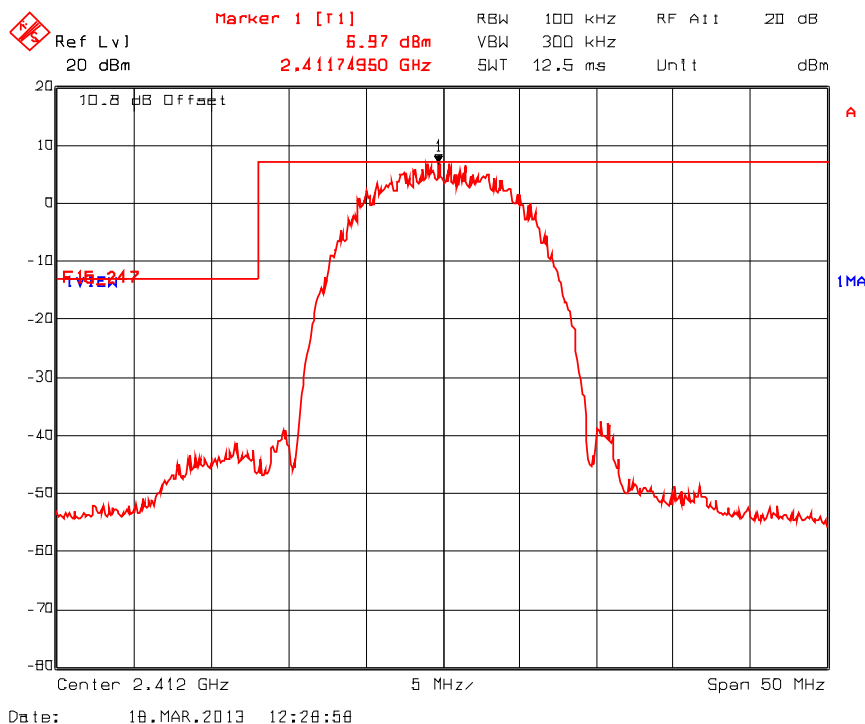



Upper Edge:

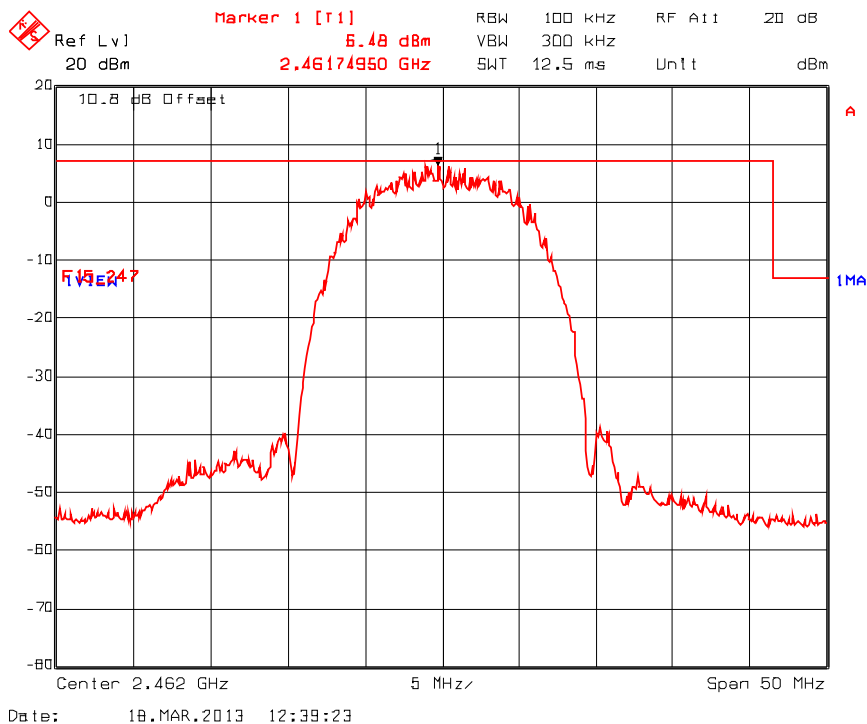

ULTRATECH GROUP OF LABS

3000 Bristol Circle, Oakville, Ontario, Canada L6H 6G4  
Tel. #: 905-829-1570, Fax. #: 905-829-8050, Email: [vic@ultratech-labs.com](mailto:vic@ultratech-labs.com), Website: <http://www.ultratech-labs.com>

File #: FLC-007F15C247

March 26, 2013

All test results contained in this engineering test report are traceable to National Institute of Standards and Technology (NIST)

**Plot 5.4.5.1.2. Band-Edge RF Conducted Emissions**

Test (specified rules):	FCC 15.247 (d) RSS 210 A8.5(a) Band-Edge Conducted
Date:	March 20, 2013
Tested by: Name	Hung Trinh
Test method:	KDB 558074 D01 Section 10.2.5 Band-Edge Conducted
Comment(s):	802.11g, 64-QAM 54 Mbps

**Lower Edge:**

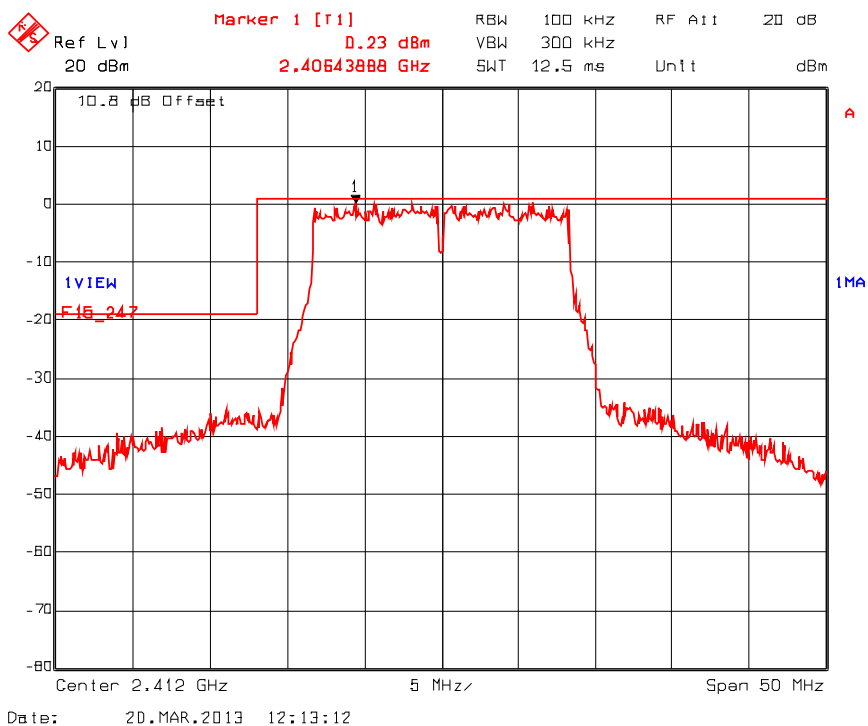

Upper Edge:

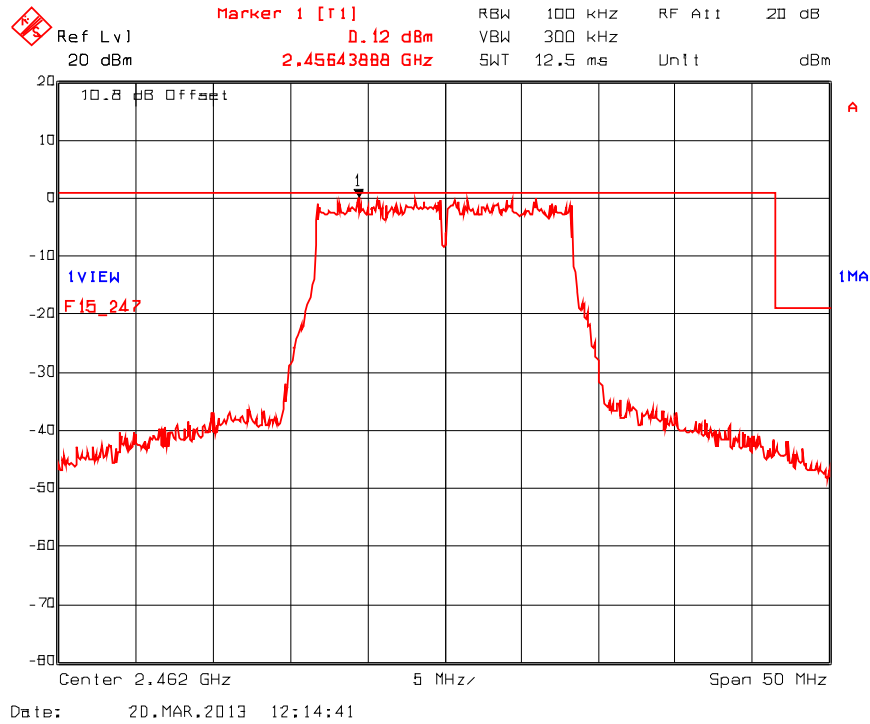

**Plot 5.4.5.1.3. Band-Edge RF Conducted Emissions**

Test (specified rules):	FCC 15.247 (d) RSS 210 A8.5(a) Band-Edge Conducted
Date:	March 20, 2013
Tested by: Name	Hung Trinh
Test method:	KDB 558074 D01 Section 10.2.5 Band-Edge Conducted
Comment(s):	802.11n, 64-QAM 5/6 65 Mbps

**Lower Edge:**

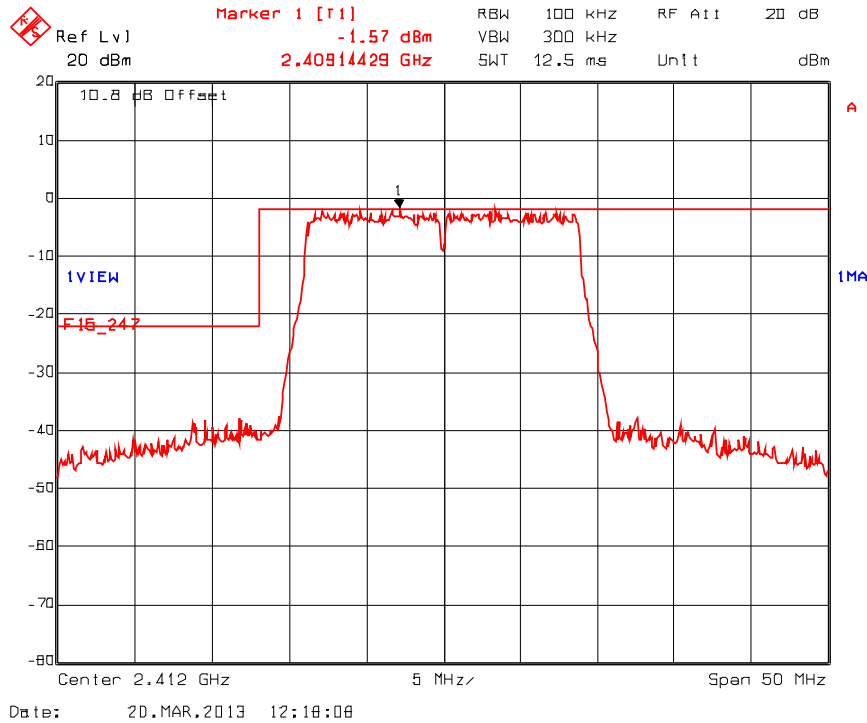

**ULTRATECH GROUP OF LABS**

3000 Bristol Circle, Oakville, Ontario, Canada L6H 6G4  
Tel. #: 905-829-1570, Fax. #: 905-829-8050, Email: [vic@ultratech-labs.com](mailto:vic@ultratech-labs.com), Website: <http://www.ultratech-labs.com>

File #: FLC-007F15C247

March 26, 2013

All test results contained in this engineering test report are traceable to National Institute of Standards and Technology (NIST)

Upper Edge:

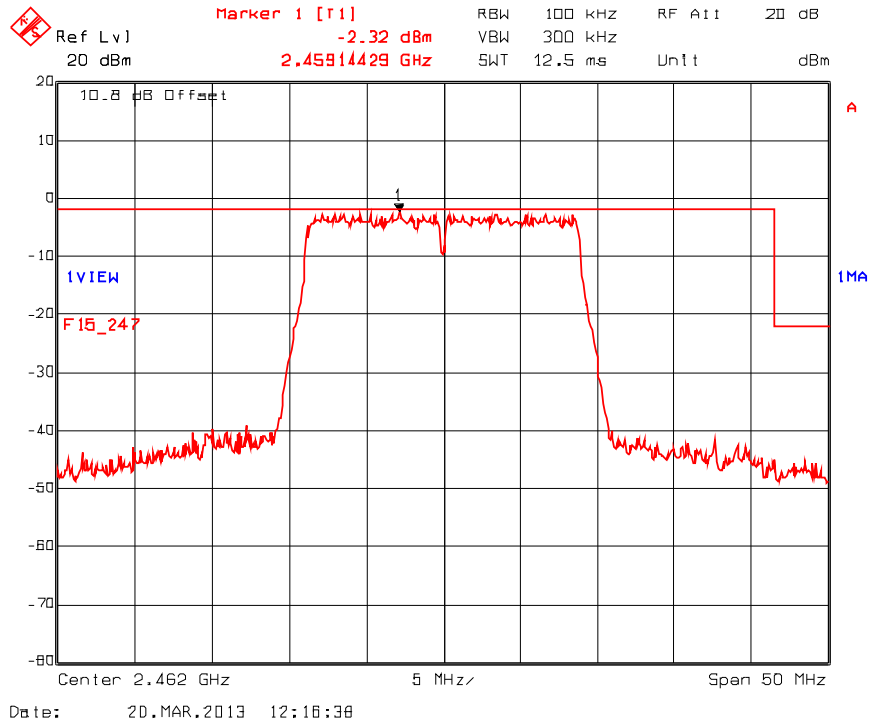

**Plot 5.4.5.1.4. RF Conducted Spurious Emissions at antenna ports**

Test (specified rules):	FCC 15.247 (d) RSS 210 A8.5(a) - RF Conducted Spurious Emissions at antenna ports
Date:	March 18, 2013
Tested by: Name	Hung Trinh
Test method:	KDB 558074 D01 Section 10.1TX Conducted
Comment(s):	2412 MHz 802.11b, CCK 11 Mbps

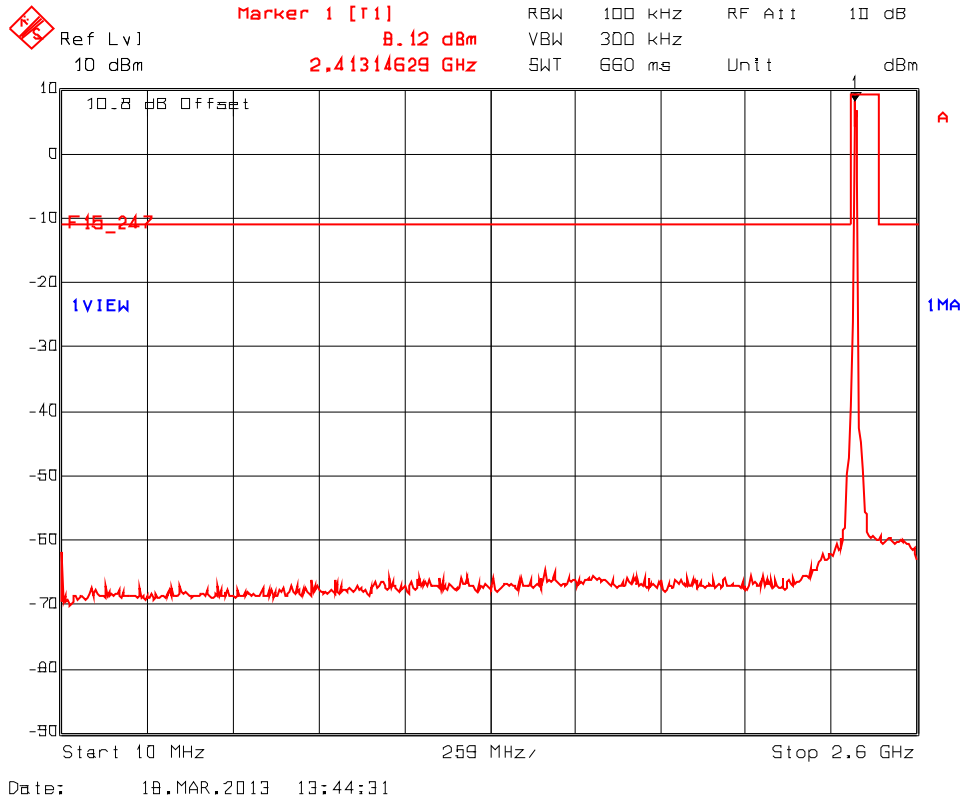

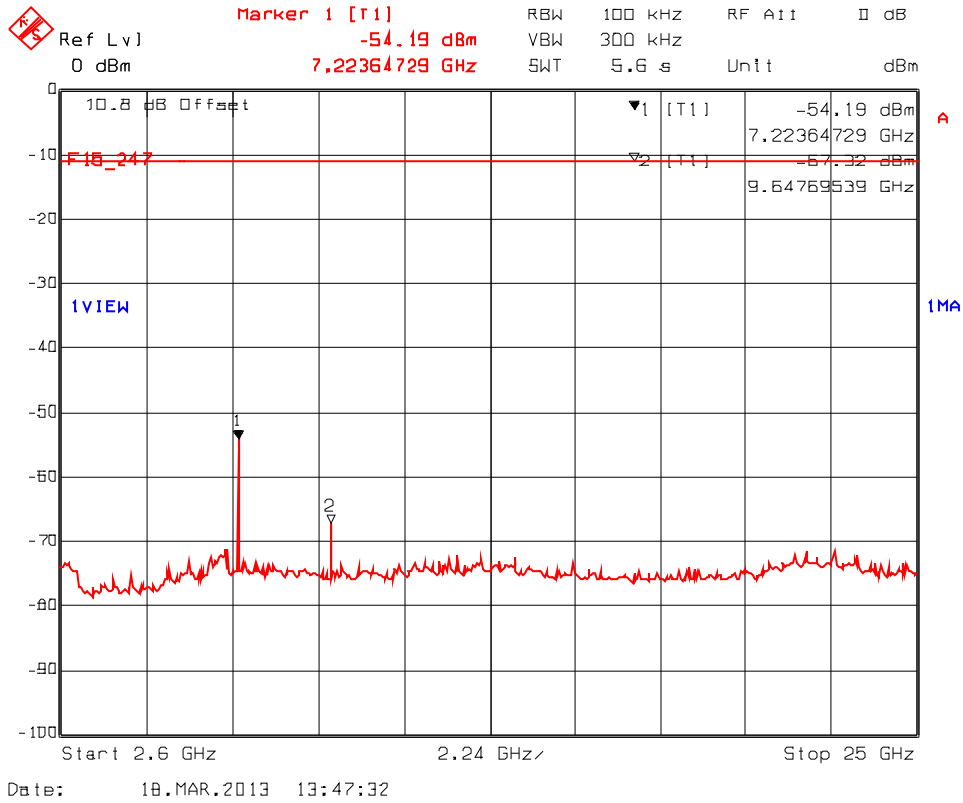

**Plot 5.4.5.1.5. RF Conducted Spurious Emissions at antenna ports**

Test (specified rules):	FCC 15.247 (d) RSS 210 A8.5(a) - RF Conducted Spurious Emissions at antenna ports
Date:	March 18, 2013
Tested by: Name	Hung Trinh
Test method:	KDB 558074 D01 Section 10.1TX Conducted
Comment(s):	2437 MHz 802.11b, CCK 11 Mbps

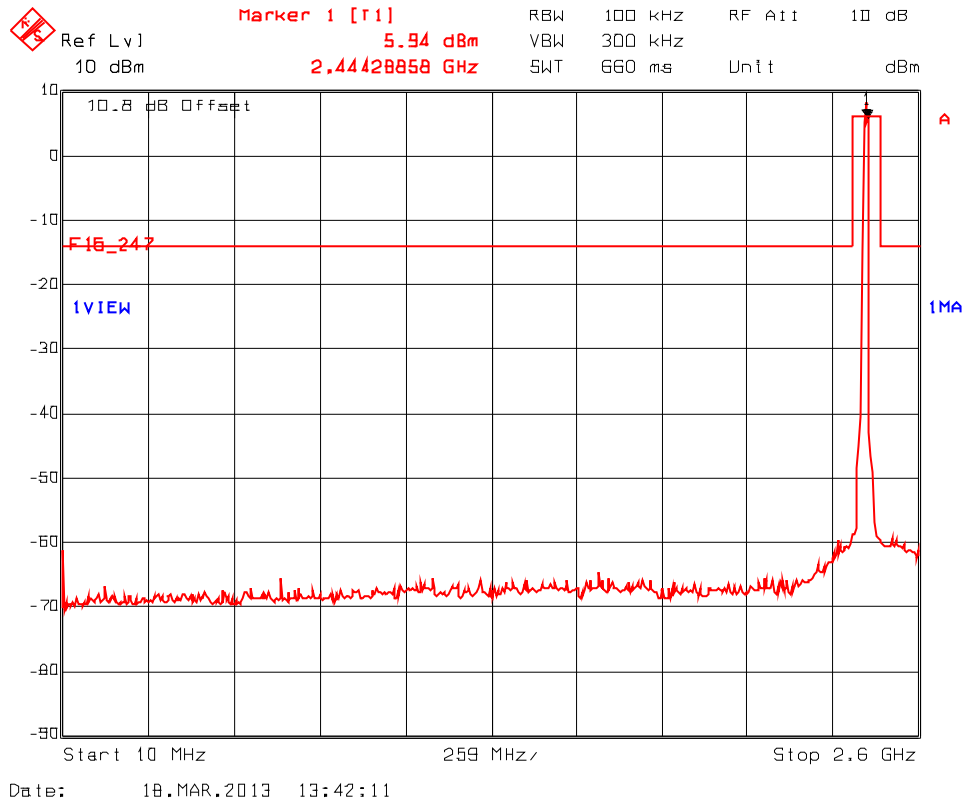



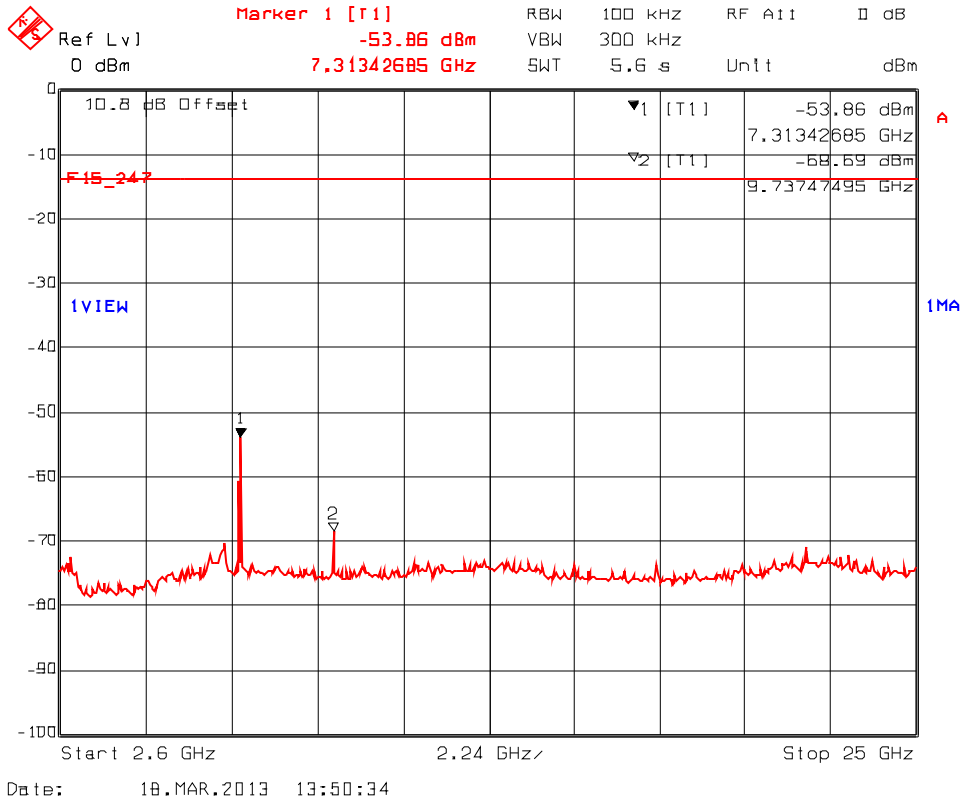

**Plot 5.4.5.1.6. RF Conducted Spurious Emissions at antenna ports**

Test (specified rules):	FCC 15.247 (d) RSS 210 A8.5(a) - RF Conducted Spurious Emissions at antenna ports
Date:	March 18, 2013
Tested by: Name	Hung Trinh
Test method:	KDB 558074 D01 Section 10.1TX Conducted
Comment(s):	2462 MHz 802.11b, CCK 11 Mbps

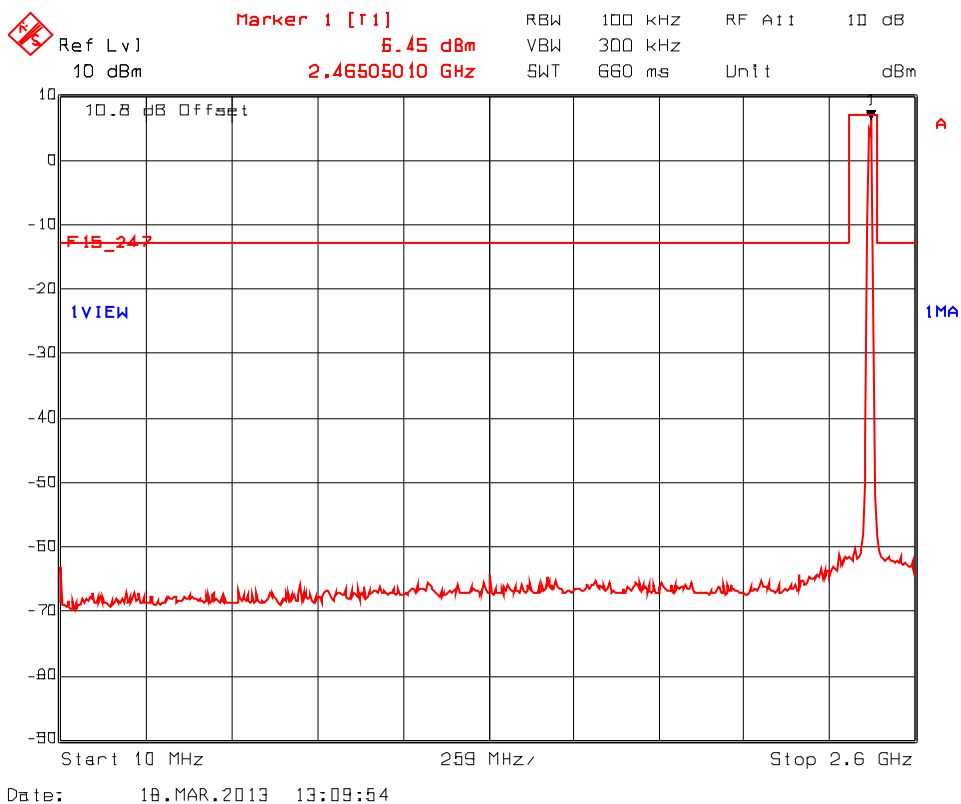

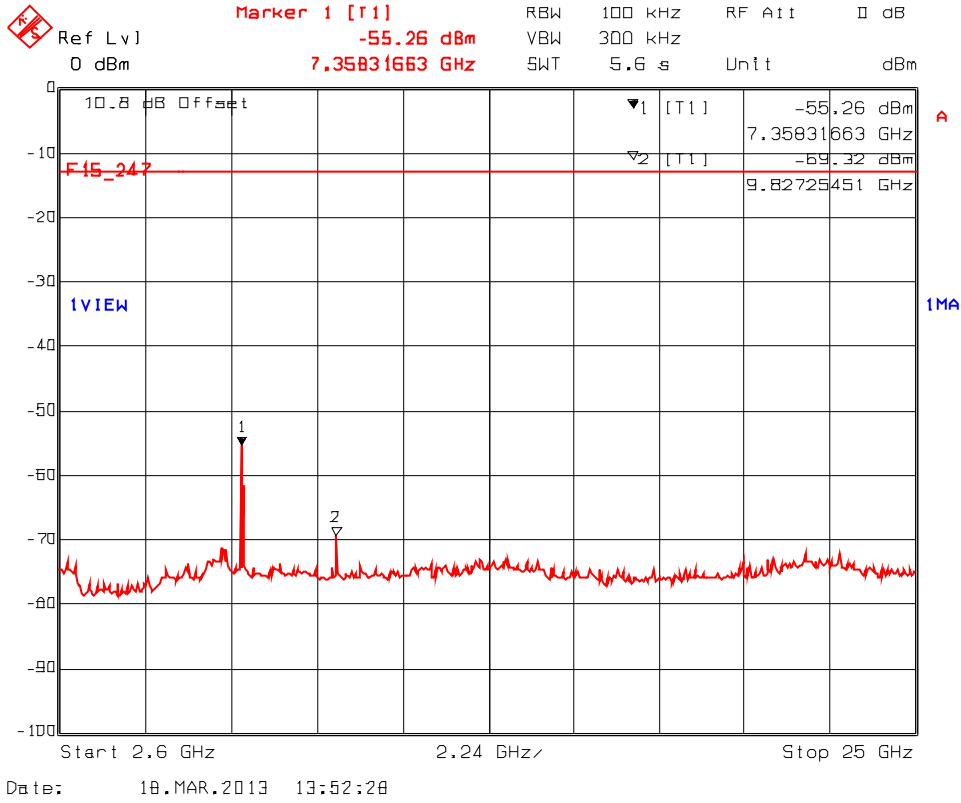

**Plot 5.4.5.1.7. RF Conducted Spurious Emissions at antenna ports**

Test (specified rules):	FCC 15.247 (d) RSS 210 A8.5(a) - RF Conducted Spurious Emissions at antenna ports
Date:	March 20, 2013
Tested by: Name	Hung Trinh
Test method:	KDB 558074 D01 Section 10.1TX Conducted
Comment(s):	2412 MHz 802.11g, 64-QAM 54 Mbps

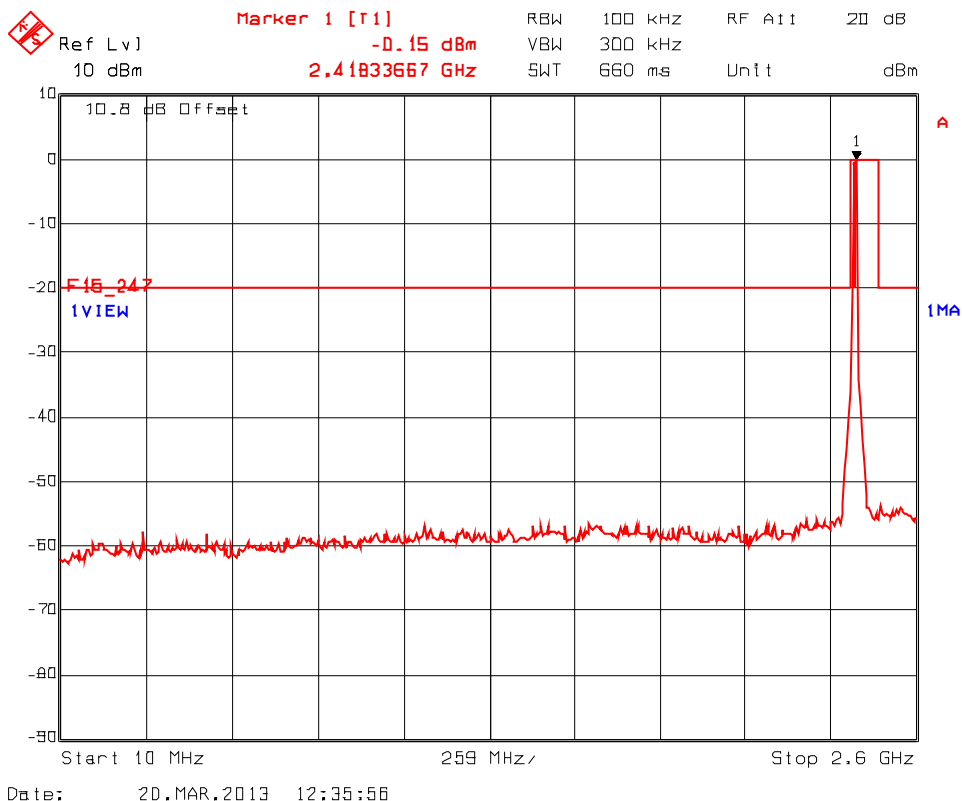

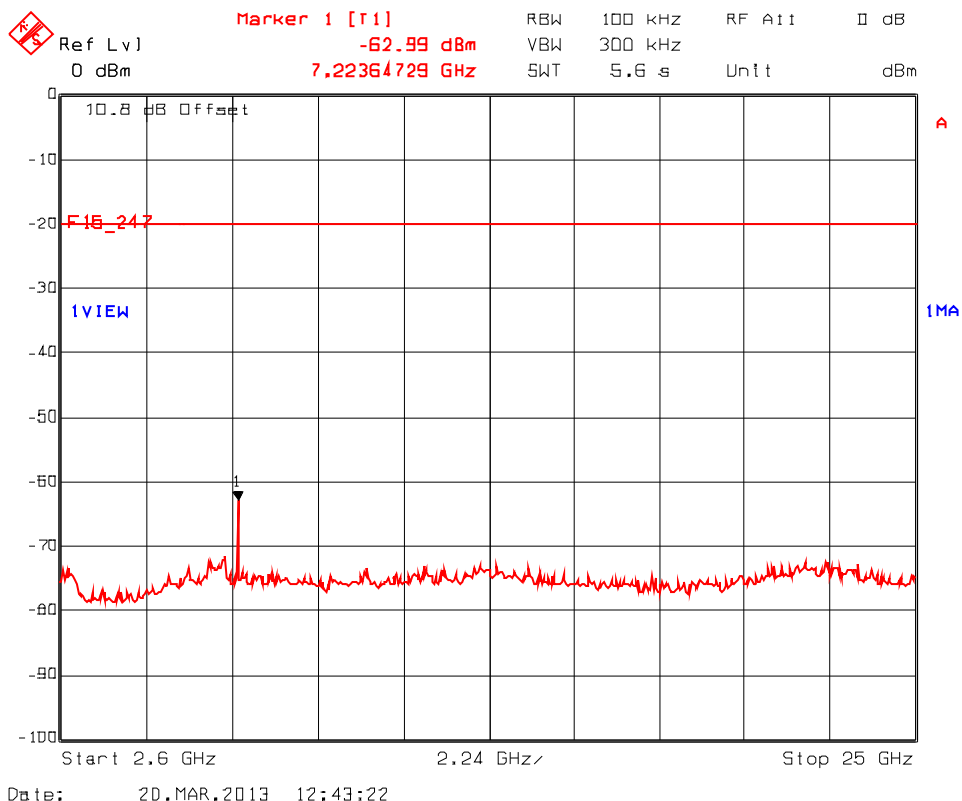

**Plot 5.4.5.1.8. RF Conducted Spurious Emissions at antenna ports**

Test (specified rules):	FCC 15.247 (d) RSS 210 A8.5(a) - RF Conducted Spurious Emissions at antenna ports
Date:	March 20, 2013
Tested by: Name	Hung Trinh
Test method:	KDB 558074 D01 Section 10.1TX Conducted
Comment(s):	2437 MHz 802.11g, 64-QAM 54 Mbps

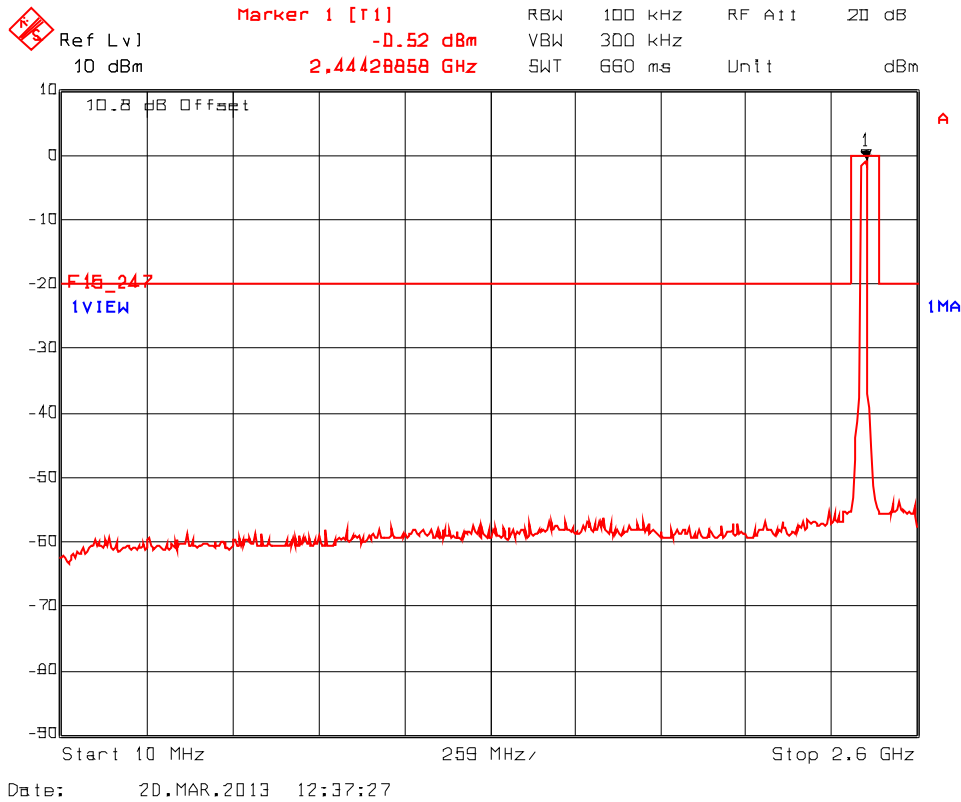

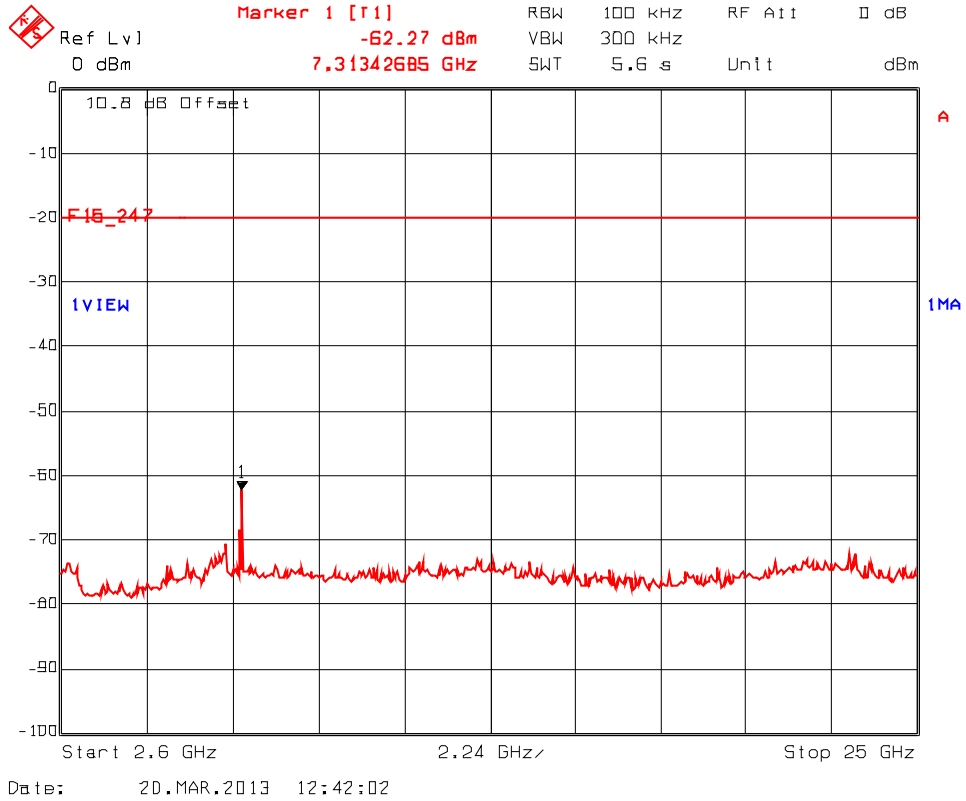

**Plot 5.4.5.1.9. RF Conducted Spurious Emissions at antenna ports**

Test (specified rules):	FCC 15.247 (d) RSS 210 A8.5(a) - RF Conducted Spurious Emissions at antenna ports
Date:	March 20, 2013
Tested by: Name	Hung Trinh
Test method:	KDB 558074 D01 Section 10.1TX Conducted
Comment(s):	2462 MHz 802.11g, 64-QAM 54 Mbps

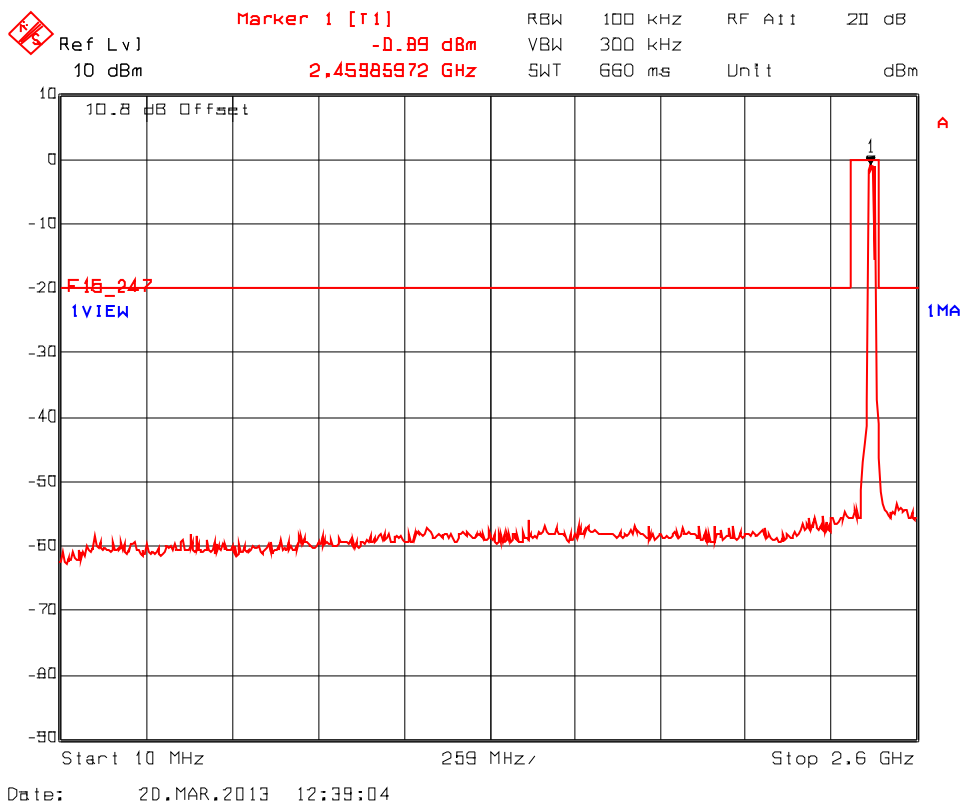



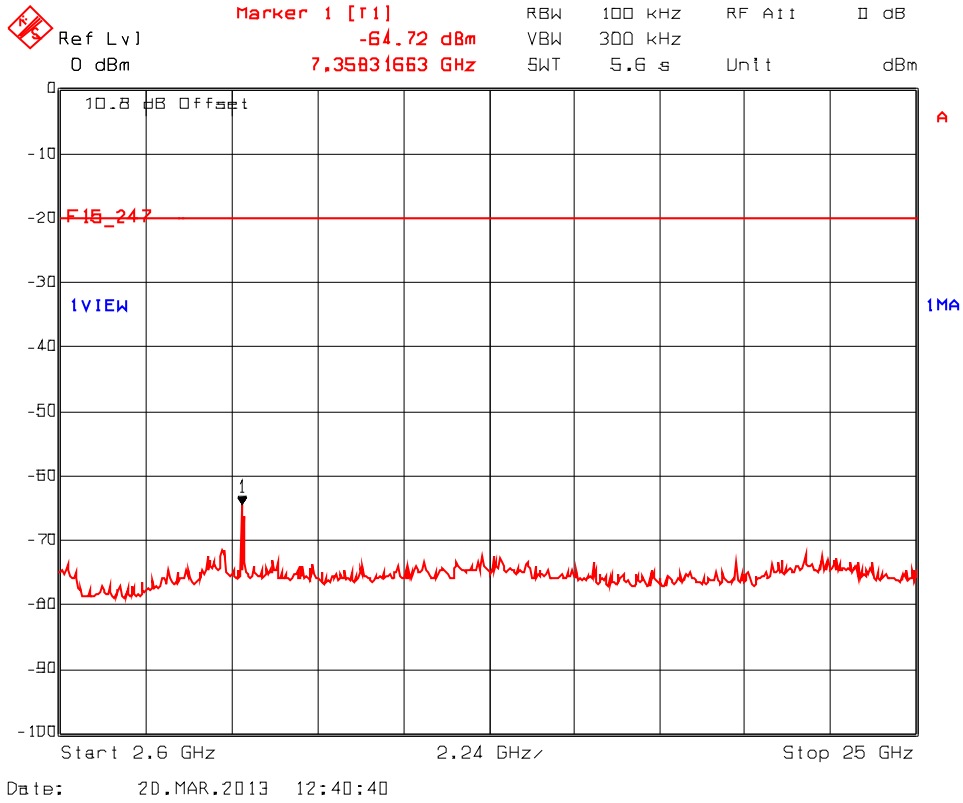

**Plot 5.4.5.1.10. RF Conducted Spurious Emissions at antenna ports**

Test (specified rules):	FCC 15.247 (d) RSS 210 A8.5(a) - RF Conducted Spurious Emissions at antenna ports
Date:	March 20, 2013
Tested by: Name	Hung Trinh
Test method:	KDB 558074 D01 Section 10.1TX Conducted
Comment(s):	2412 MHz 802.11n, 64-QAM 5/6 65 Mbps

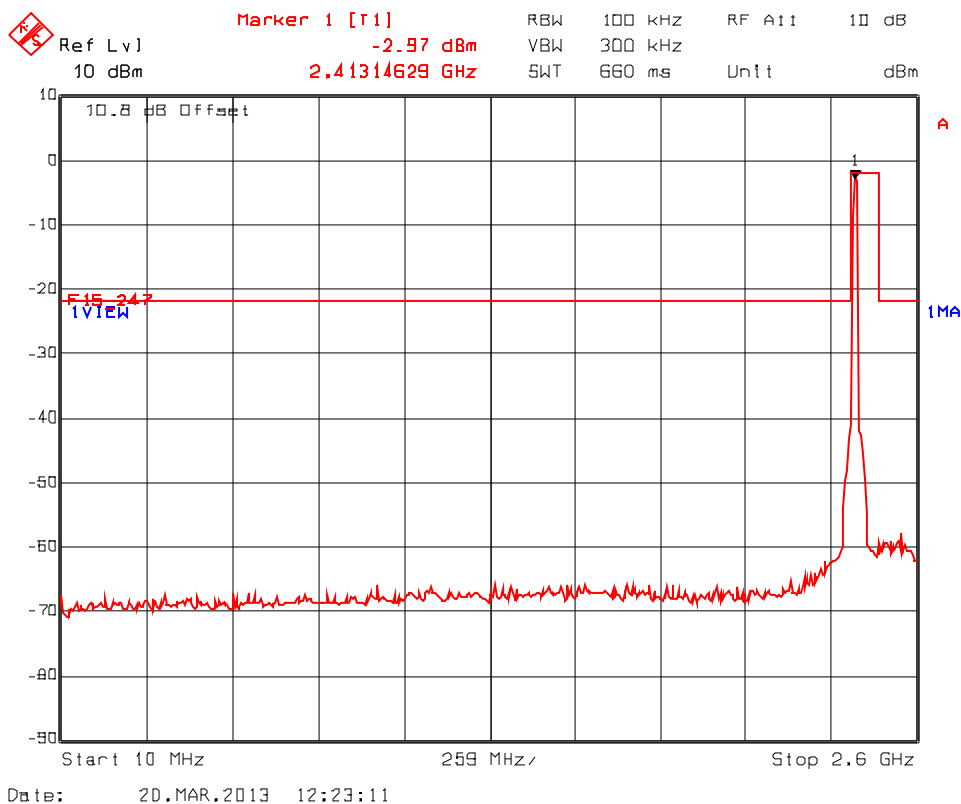

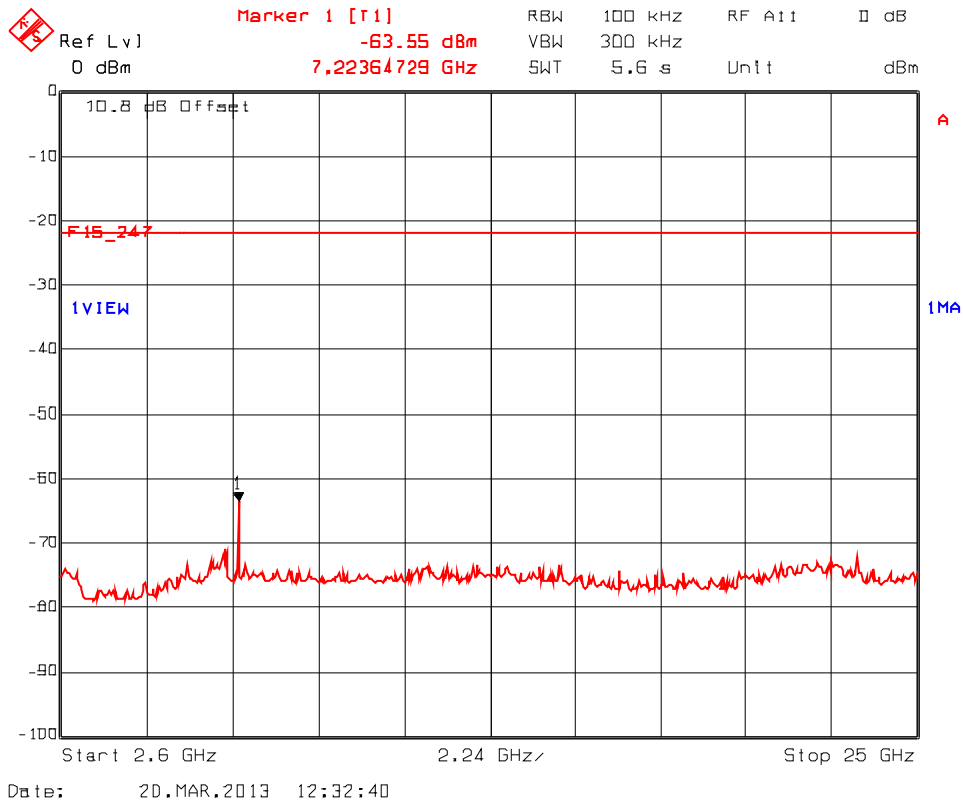

**Plot 5.4.5.1.11. RF Conducted Spurious Emissions at antenna ports**

Test (specified rules):	FCC 15.247 (d) RSS 210 A8.5(a) - RF Conducted Spurious Emissions at antenna ports
Date:	March 20, 2013
Tested by: Name	Hung Trinh
Test method:	KDB 558074 D01 Section 10.1TX Conducted
Comment(s):	2437 MHz 802.11n, 64-QAM 5/6 65 Mbps

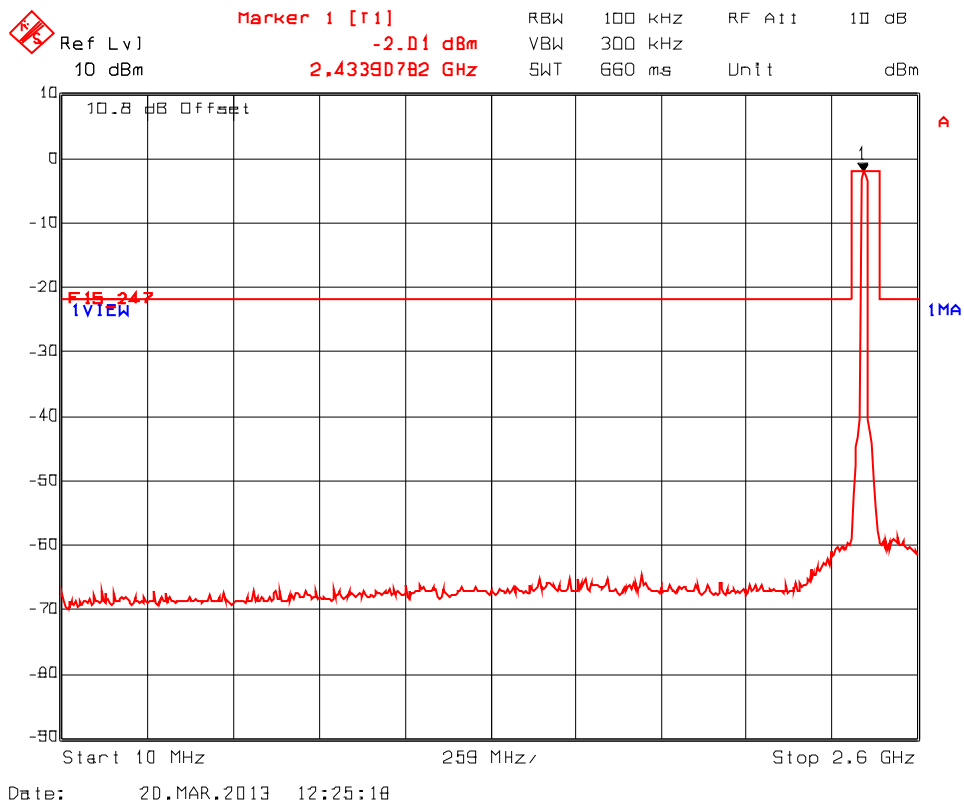

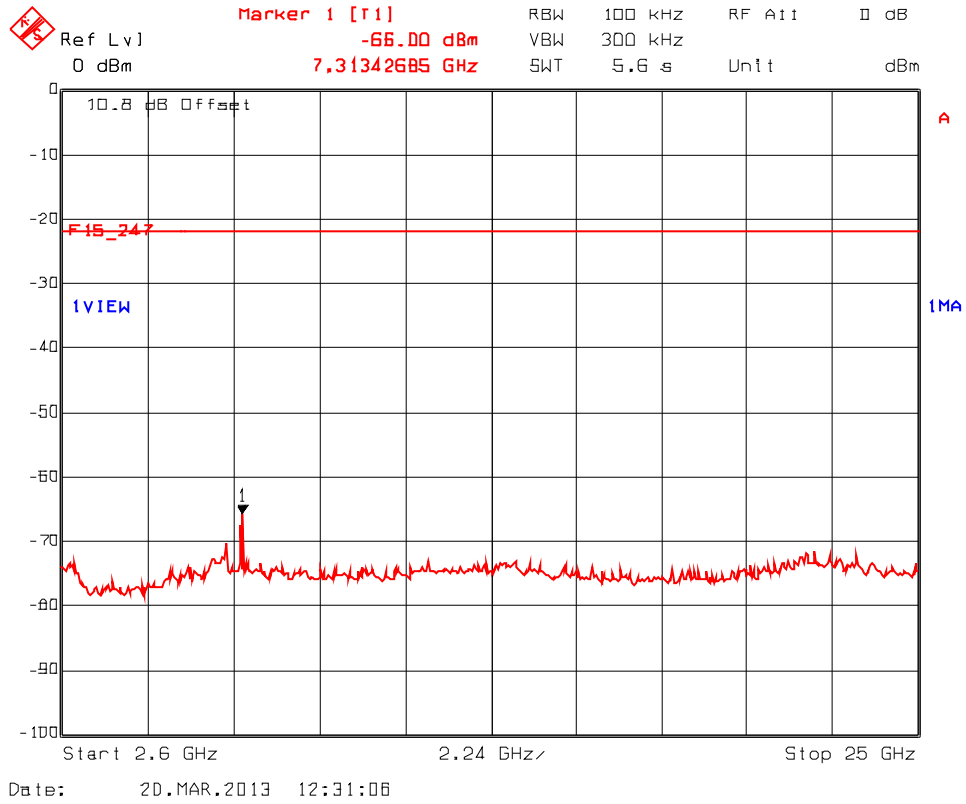

**Plot 5.4.5.1.12. RF Conducted Spurious Emissions at antenna ports**

Test (specified rules):	FCC 15.247 (d) RSS 210 A8.5(a) - RF Conducted Spurious Emissions at antenna ports
Date:	March 20, 2013
Tested by: Name	Hung Trinh
Test method:	KDB 558074 D01 Section 10.1TX Conducted
Comment(s):	2462 MHz 802.11n, 64-QAM 5/6 65 Mbps

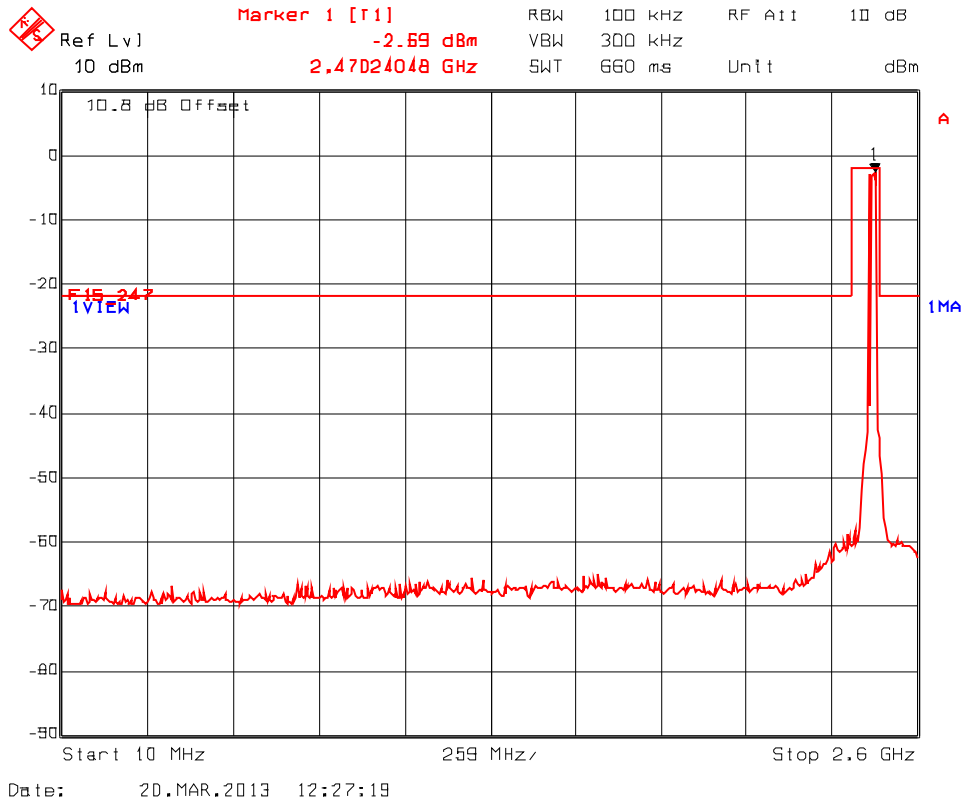

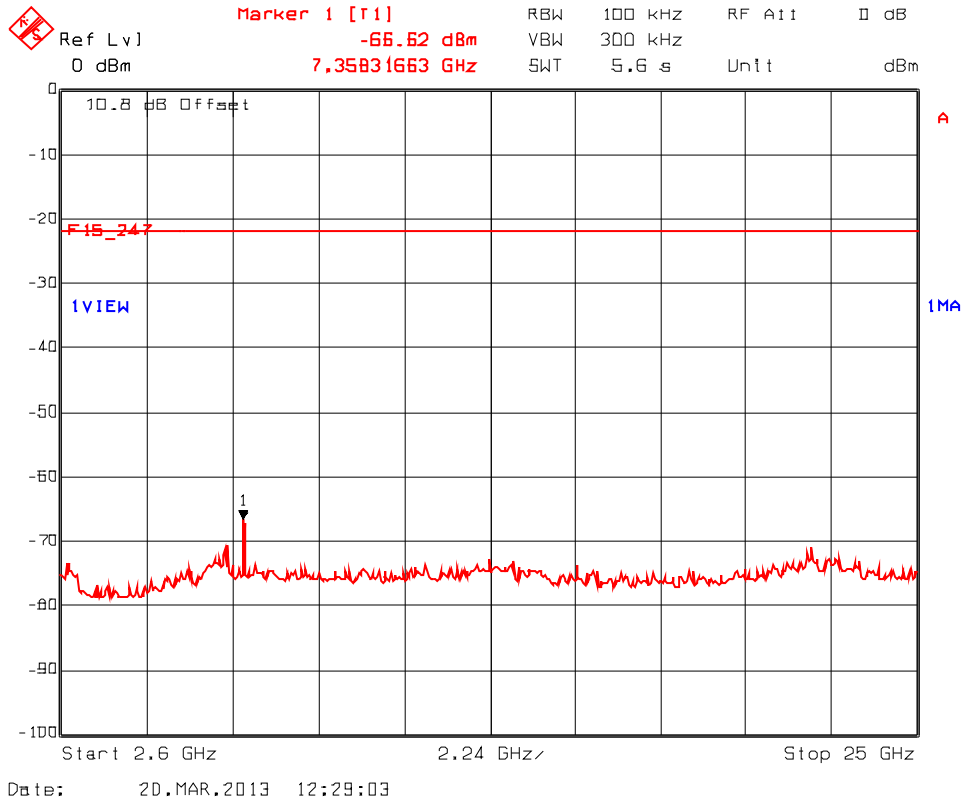

## 5.5. TRANSMITTER RADIATED BAND-EDGE & SPURIOUS RADIATED EMISSIONS AT 3 METERS [§ 15.247(d), 15.209 & 15.205]

### 5.5.1. Limit

**§ 15.247 (d):** In any 100 kHz bandwidth outside the frequency band in which the spread spectrum or digitally modulated intentional radiator is operating, the radio frequency power that is produced by the intentional radiator shall be at least 20 dB below that in the 100 kHz bandwidth within the band that contains the highest level of the desired power, based on either an RF conducted or a radiated measurement, provided the transmitter demonstrates compliance with the peak conducted power limits. If the transmitter complies with the conducted power limits based on the use of RMS averaging over a time interval, as permitted under paragraph (b)(3) of this section, the attenuation required under this paragraph shall be 30 dB instead of 20 dB. Attenuation below the general limits specified in Section 15.209(a) is not required. In addition, radiated emissions which fall in the restricted bands, as defined in Section 15.205(a), must also comply with the radiated emission limits specified in Section 15.209(a) (see Section 15.205(c)).

#### Section 15.205(a) - Restricted Bands of Operation

MHz	MHz	MHz	GHz
0.090–0.110 .....	16.42–16.423	399.9–410	4.5–5.15
<sup>1</sup> 0.495–0.505 .....	16.69475–16.69525	608–614	5.35–5.46
2.1735–2.1905 .....	16.80425–16.80475	960–1240	7.25–7.75
4.125–4.128 .....	25.5–25.67	1300–1427	8.025–8.5
4.17725–4.17775 .....	37.5–38.25	1435–1626.5	9.0–9.2
4.20725–4.20775 .....	73–74.6	1645.5–1646.5	9.3–9.5
6.215–6.218 .....	74.8–75.2	1660–1710	10.6–12.7
6.26775–6.26825 .....	108–121.94	1718.8–1722.2	13.25–13.4
6.31175–6.31225 .....	123–138	2200–2300	14.47–14.5
8.291–8.294 .....	149.9–150.05	2310–2390	15.35–16.2
8.362–8.366 .....	156.52475–156.52525	2483.5–2500	17.7–21.4
8.37625–8.38675 .....	156.7–156.9	2655–2900	22.01–23.12
8.41425–8.41475 .....	162.0125–167.17	3260–3267	23.6–24.0
12.29–12.293 .....	167.72–173.2	3332–3339	31.2–31.8
12.51975–12.52025 .....	240–285	3345.8–3358	36.43–36.5
12.57675–12.57725 .....	322–335.4	3600–4400	( <sup>2</sup> )
13.36–13.41 .....			

<sup>1</sup> Until February 1, 1999, this restricted band shall be 0.490–0.510 MHz.

<sup>2</sup> Above 38.6

#### Section 15.209(a) - Field Strength Limits within Restricted Frequency Bands

Frequency (MHz)	Field Strength (microvolts/meter)	Measurement Distance (meters)
0.009 - 0.490	2,400 / F (kHz)	300
0.490 - 1.705	24,000 / F (kHz)	30
1.705 - 30.0	30	30
30 - 88	100	3
88 - 216	150	3
216 - 960	200	3
Above 960	500	3



### 5.5.2. Method of Measurements

KDB Publication No. 558074 D01: Guidance for Performing Compliance Measurements on Digital Transmission Systems (DTS) Operating Under §15.247.

### 5.5.3. Test Instruments

Test Instruments	Manufacturer	Model No.	Serial No.	Frequency Range	Calibration Due Date
Spectrum Analyzer	Rohde & Schwarz	ESU40	100033	20 Hz – 40 GHz	7 Mar 2014
RF Amplifier	Hewlett Packard	84498	3008A00769	1 – 26.5 GHz	6 Aug 2013
High Pass Filter	K & L	11SH10-4000/T12000	4	Cut off 2.4 GHz	Cal on use
Biconi-Log Antenna	ETS Lindgren	3142B	1575	26 – 3000 MHz	4 May 2013
Horn Antenna	Emco	3155	6570	1 – 18 GHz	2 Apr 2013
Horn Antenna	Emco	3160-09	118385	18 – 26.5 GHz	30 July 2014

### 5.5.4. Test Arrangement

Refer to Annex 1 – Test Setup Photos

**5.5.5. Test Data**

**Remark:** The occupied bandwidths of 802.11b, 802.11g, and 802.11n were found similar. Therefore, the rf signals with the highest data rate of among 802.11b, 802.11g and 802.11n were chosen for testing to represent the worst case of emissions.

**Plot 5.5.5.1.1. Band-Edge RF Radiated Emissions**

Test (specified rules):	FCC 15.247 (d) RSS 210 A8.5(a) Band-Edge Radiated Emissions
Date:	March 19, 2013
Tested by: Name	Hung Trinh
Deviation:	Add 10dB attenuator with amplifier
Comment(s):	802.11b CCK 11 Mbps Band-Edge Radiated Emissions, Horizontal Polarization Trace 1: RBW= 1 MHz, VBW= 3 MHz Trace 2: RBW= 1 MHz, VBW= 10 Hz

**Lower Edge:**

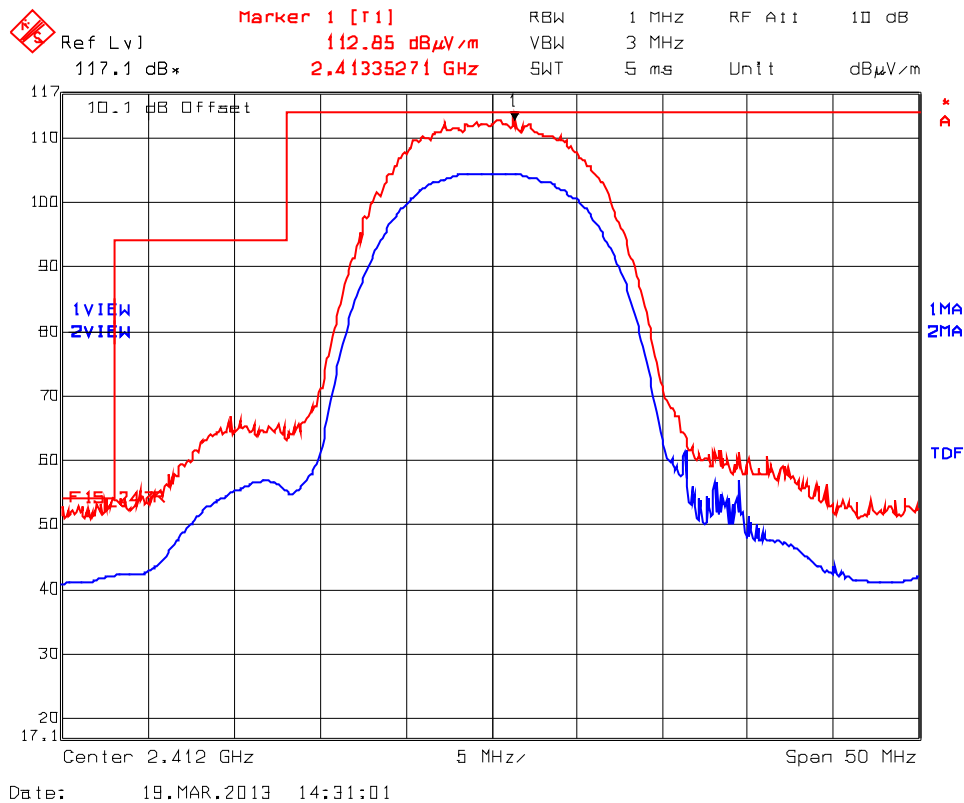

Upper Edge:

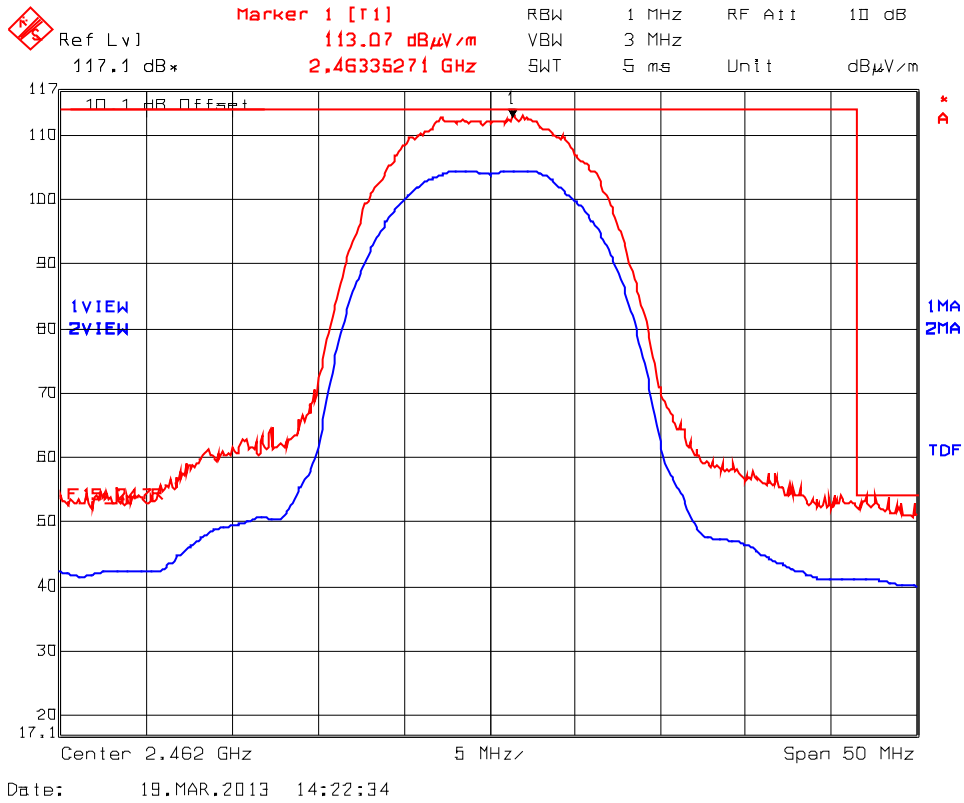

ULTRATECH GROUP OF LABS

3000 Bristol Circle, Oakville, Ontario, Canada L6H 6G4  
Tel. #: 905-829-1570, Fax. #: 905-829-8050, Email: [vic@ultratech-labs.com](mailto:vic@ultratech-labs.com), Website: <http://www.ultratech-labs.com>

File #: FLC-007F15C247

March 26, 2013

All test results contained in this engineering test report are traceable to National Institute of Standards and Technology (NIST)

**Plot 5.5.5.1.2. Band-Edge RF Radiated Emissions**

Test (specified rules):	FCC 15.247 (d) RSS 210 A8.5(a) Band-Edge Radiated Emissions
Date:	March 19, 2013
Tested by: Name	Hung Trinh
Deviation:	Add 10dB attenuator with amplifier
Comment(s):	802.11b CCK 11 Mbps Band-Edge Radiated Emissions, Vertical Polarization Trace 1: RBW= 1 MHz, VBW= 3 MHz Trace 2: RBW= 1 MHz, VBW= 10 Hz

**Lower Edge:**

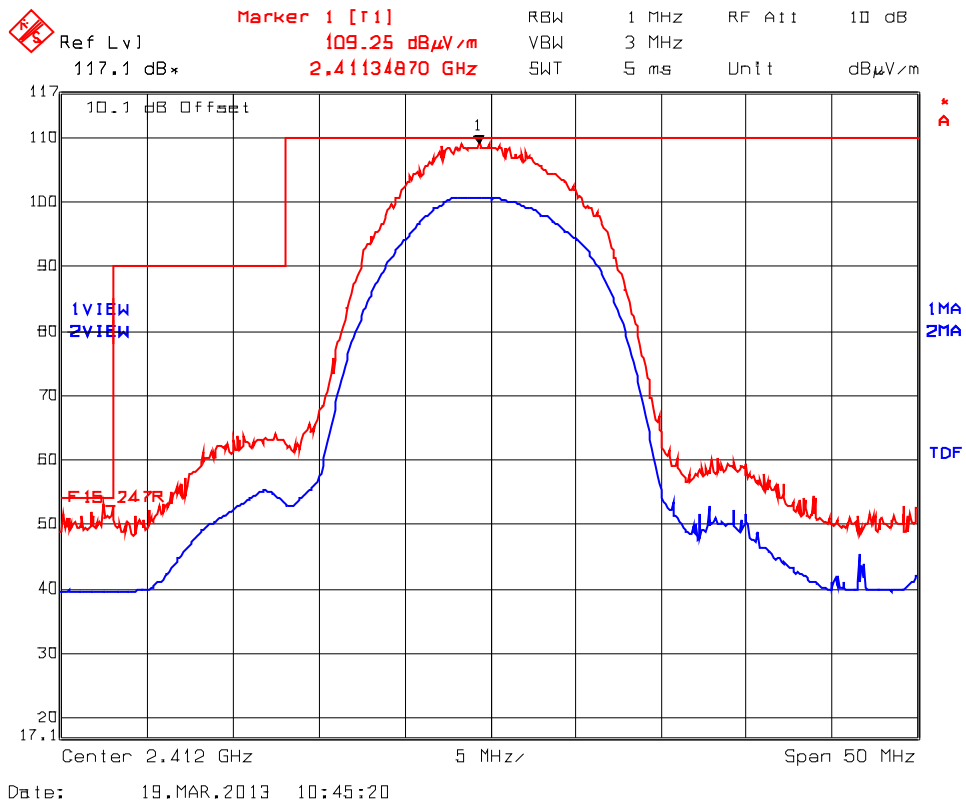

**ULTRATECH GROUP OF LABS**

3000 Bristol Circle, Oakville, Ontario, Canada L6H 6G4  
Tel. #: 905-829-1570, Fax. #: 905-829-8050, Email: [vic@ultratech-labs.com](mailto:vic@ultratech-labs.com), Website: <http://www.ultratech-labs.com>

File #: FLC-007F15C247  
March 26, 2013

All test results contained in this engineering test report are traceable to National Institute of Standards and Technology (NIST)

Upper Edge:

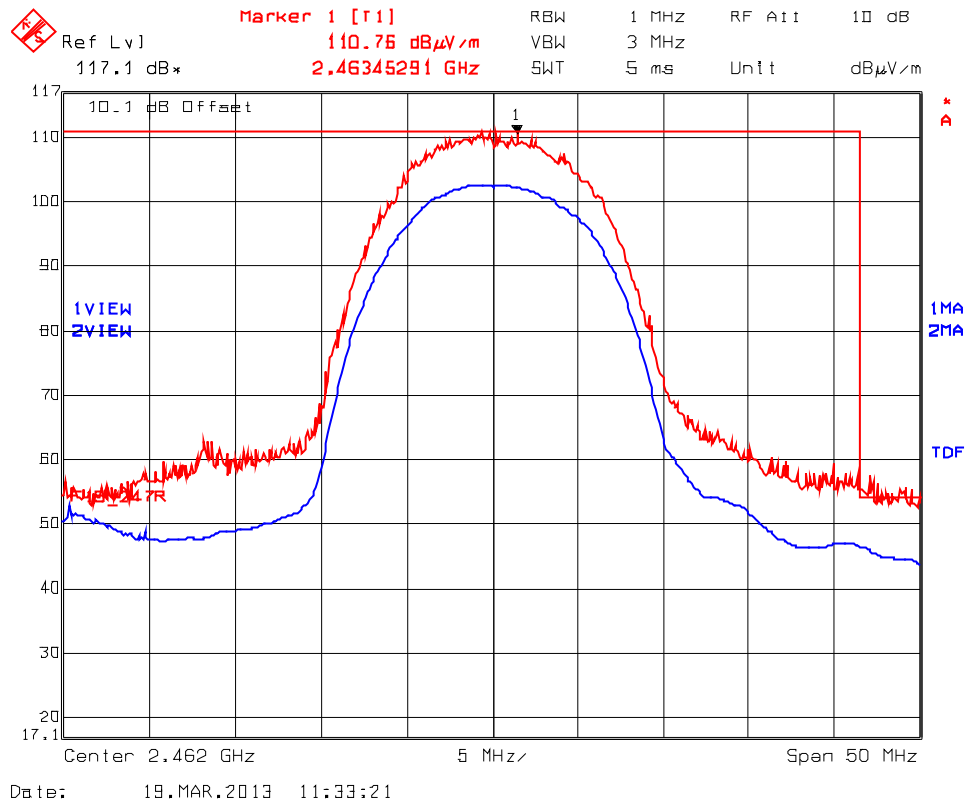

**Plot 5.5.5.1.3. Band-Edge RF Radiated Emissions**

Test (specified rules):	FCC 15.247 (d) RSS 210 A8.5(a) Band-Edge Radiated Emissions
Date:	March 19, 2013
Tested by: Name	Hung Trinh
Deviation:	Add 10dB attenuator with amplifier
Comment(s):	802.11g 64-QAM 54 Mbps Band-Edge Radiated, Horizontal Polarization Trace 1: RBW= 1 MHz, VBW= 3 MHz Trace 2: RBW= 1 MHz, VBW= 10 Hz

**Lower Edge:**

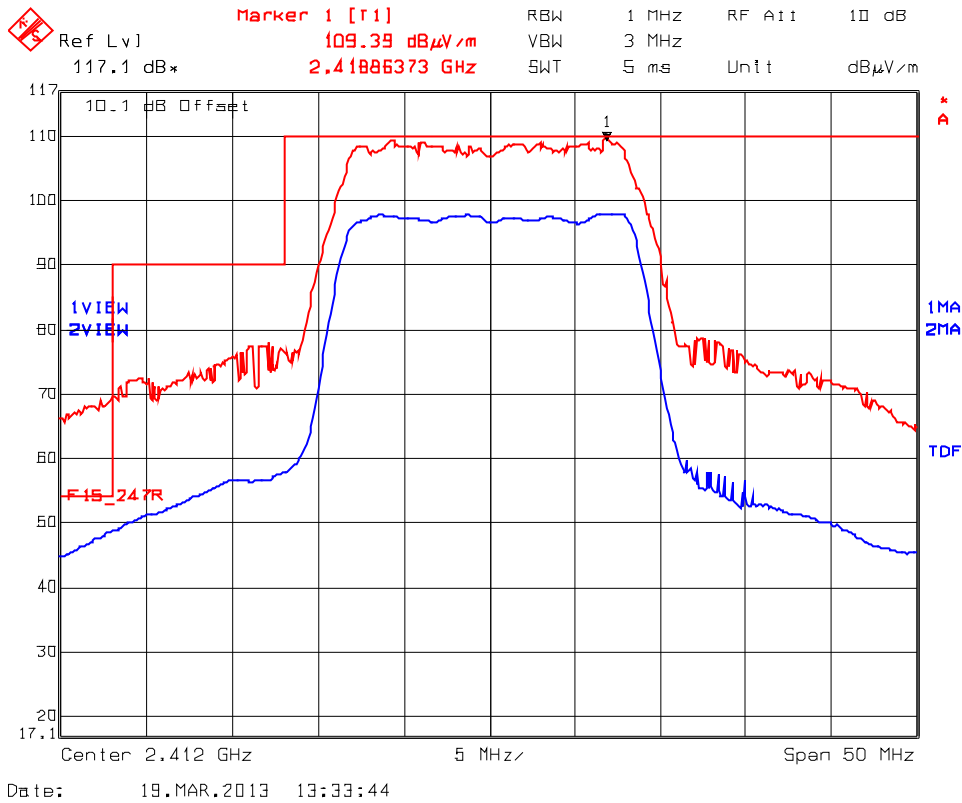

Upper Edge:

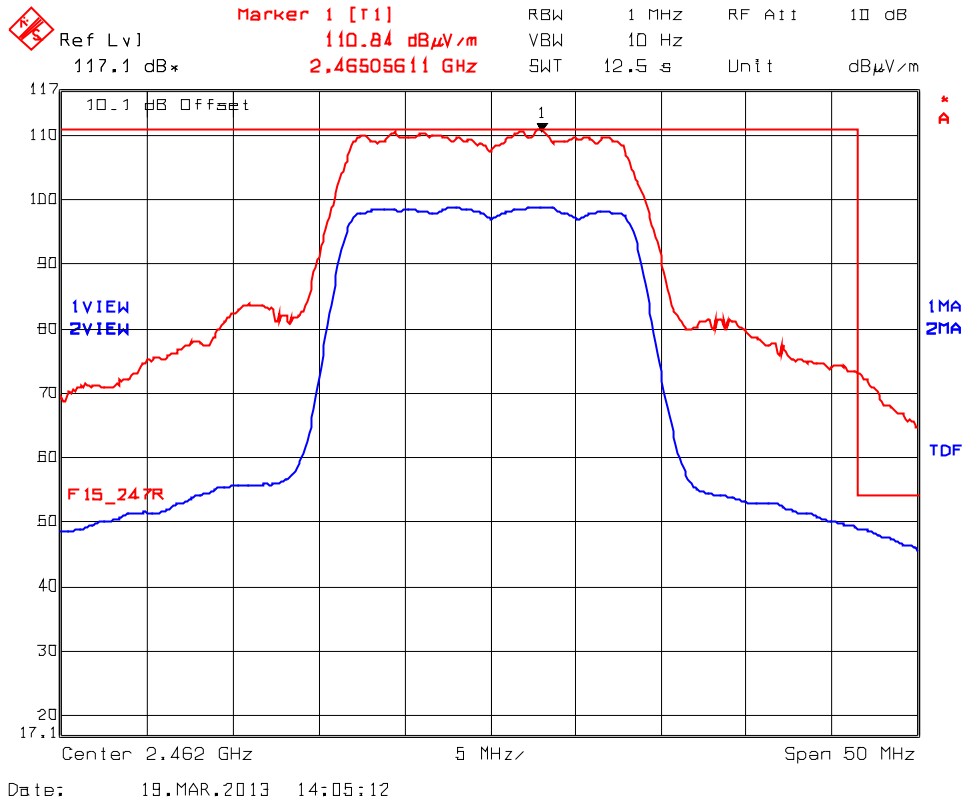

**Plot 5.5.5.1.4. Band-Edge RF Radiated Emissions**

Test (specified rules):	FCC 15.247 (d) RSS 210 A8.5(a) Band-Edge Radiated Emissions
Date:	March 19, 2013
Tested by: Name	Hung Trinh
Deviation:	Add 10dB attenuator with amplifier
Comment(s):	802.11g 64-QAM 54 Mbps Band-Edge Radiated, Vertical Polarization Trace 1: RBW= 1 MHz, VBW= 3 MHz Trace 2: RBW= 1 MHz, VBW= 10 Hz

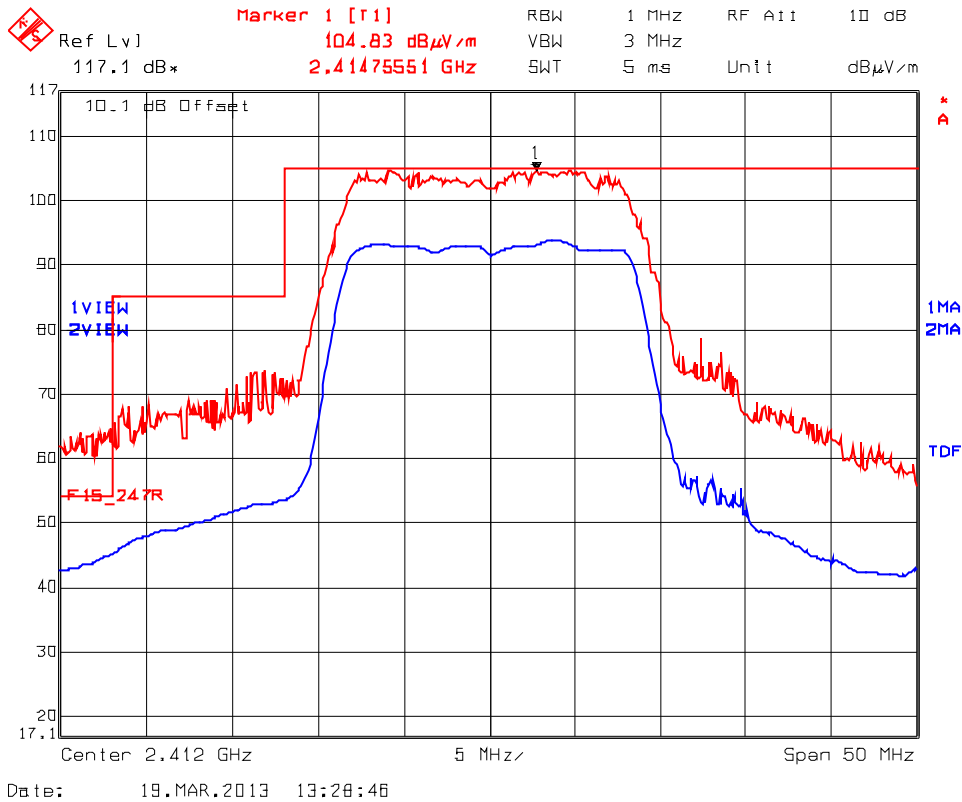

**ULTRATECH GROUP OF LABS**

3000 Bristol Circle, Oakville, Ontario, Canada L6H 6G4  
Tel. #: 905-829-1570, Fax. #: 905-829-8050, Email: [vic@ultratech-labs.com](mailto:vic@ultratech-labs.com), Website: <http://www.ultratech-labs.com>

File #: FLC-007F15C247  
March 26, 2013

All test results contained in this engineering test report are traceable to National Institute of Standards and Technology (NIST)



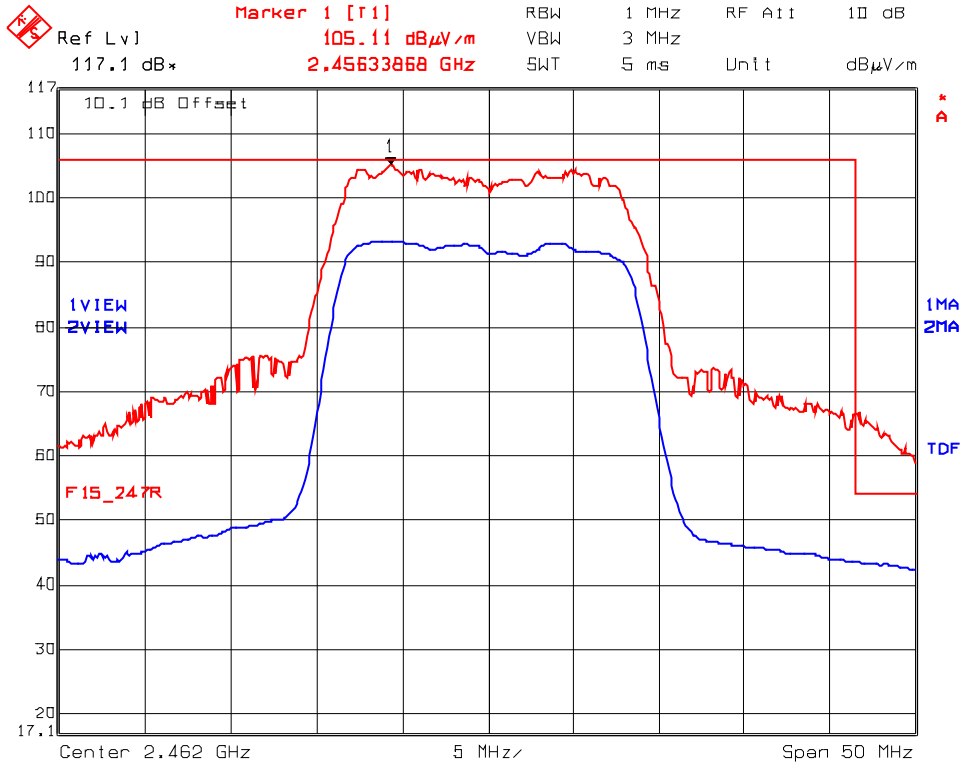

Date: 19.MAR.2013 13:09:17

**Plot 5.5.5.1.5. Band-Edge RF Radiated Emissions**

Test (specified rules):	FCC 15.247 (d) RSS 210 A8.5(a) Band-Edge Radiated Emissions
Date:	March 19, 2013
Tested by: Name	Hung Trinh
Deviation:	Add 10dB attenuator with amplifier
Comment(s):	802.11n 64-QAM 5/6 65 Mbps Band-Edge Radiated, Horizontal Polarization Trace 1: RBW= 1 MHz, VBW= 3 MHz Trace 2: RBW= 1 MHz, VBW= 10 Hz

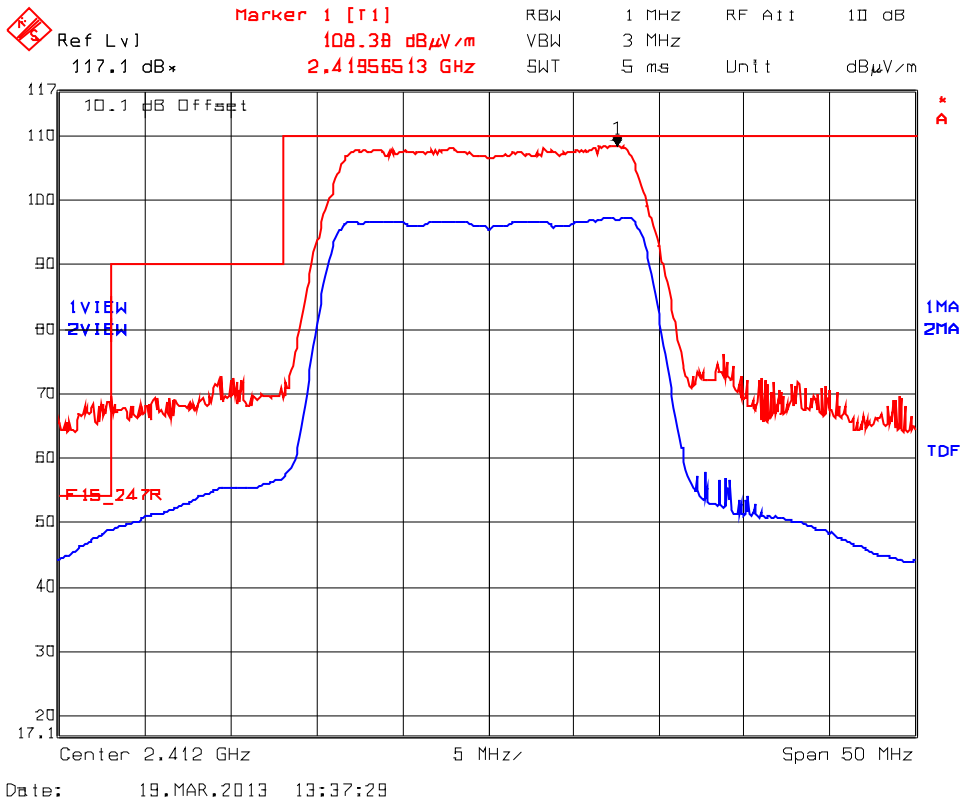

**ULTRATECH GROUP OF LABS**

3000 Bristol Circle, Oakville, Ontario, Canada L6H 6G4  
Tel. #: 905-829-1570, Fax. #: 905-829-8050, Email: [vic@ultratech-labs.com](mailto:vic@ultratech-labs.com), Website: <http://www.ultratech-labs.com>

File #: FLC-007F15C247

March 26, 2013

All test results contained in this engineering test report are traceable to National Institute of Standards and Technology (NIST)

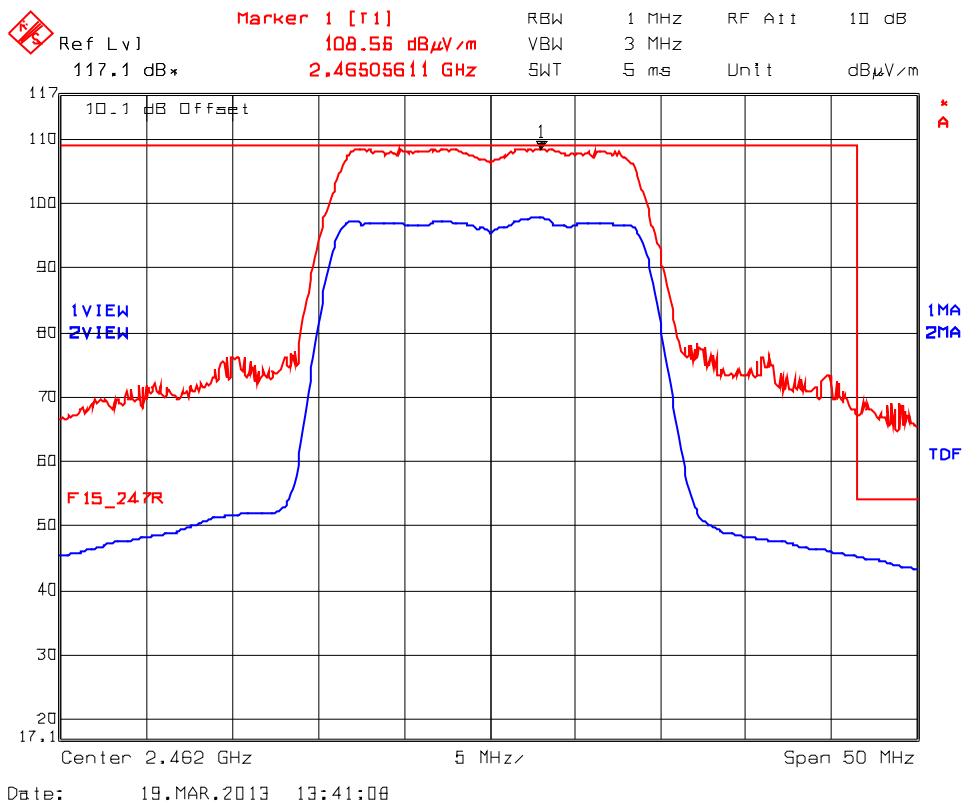

**Plot 5.5.5.1.6. Band-Edge RF Radiated Emissions**

Test (specified rules):	FCC 15.247 (d) RSS 210 A8.5(a) Band-Edge Radiated Emissions
Date:	March 19, 2013
Tested by: Name	Hung Trinh
Deviation:	Add 10dB attenuator with amplifier
Comment(s):	802.11n 64-QAM 5/6 65 Mbps Band-Edge Radiated, Vertical Polarization Trace 1: RBW= 1 MHz, VBW= 3 MHz Trace 2: RBW= 1 MHz, VBW= 10 Hz

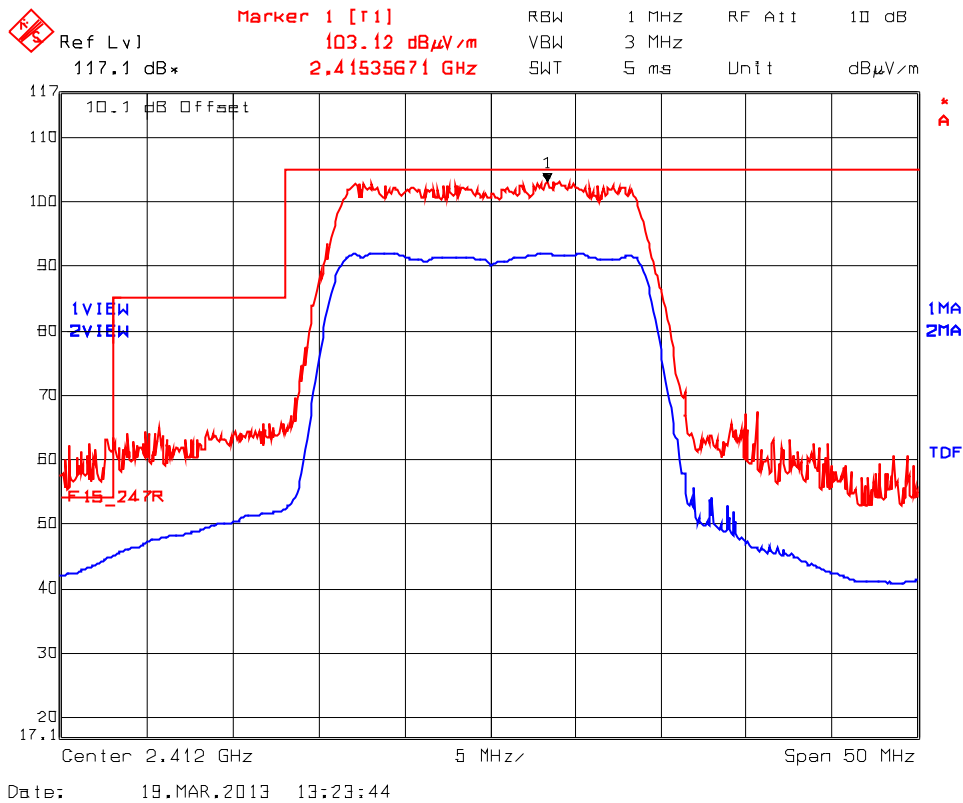

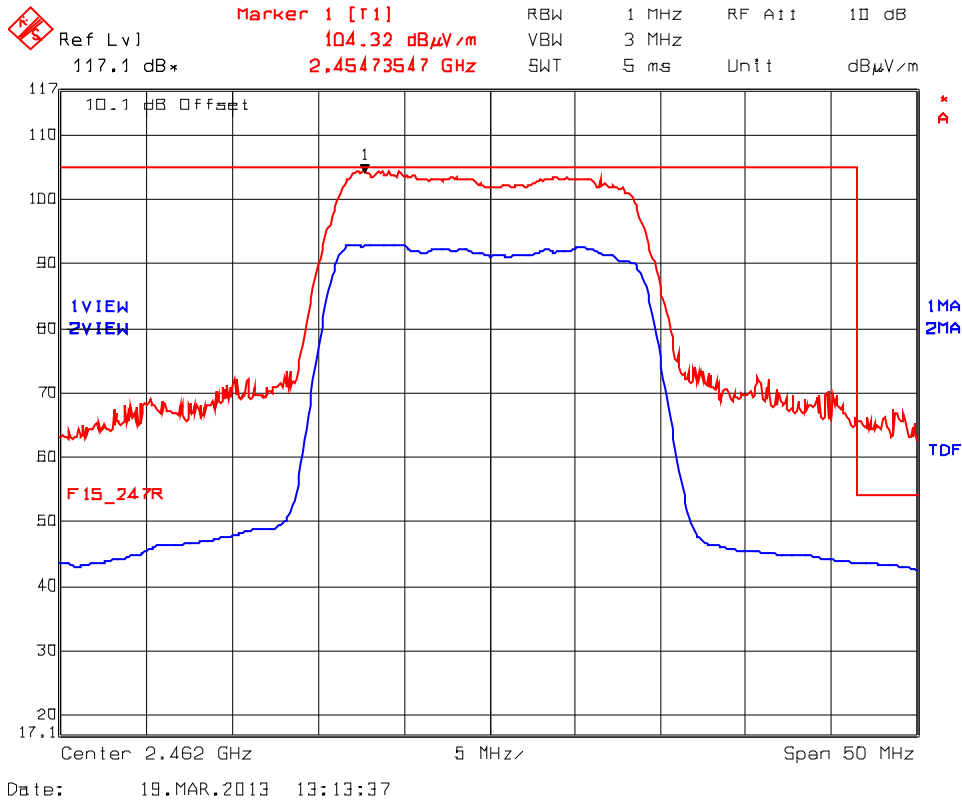

### Transmitter Spurious Radiated Emissions @ 3 meters

**Remark(s):**

- All spurious emissions that are in excess of 20 dB below the specified limit shall be recorded.
- Based on the power measurements and our radiated prescans, the highest power observed in 802.11b, Power setting 17, were selected as the final test configurations to represent the worst-case.

**5.5.5.2. 802.11b Mode**

Product: <b>H840 DEVICE, Model H2G2-42</b>	Test Tech: Mr.Hung Trinh	Date:20 Mar 2013
Configuration: 802.11b, Transmitter mode, Power setting 17		
Analyzer: Rohde & Schwarz		
Amplifier: Pre Amplifier HP8449B		
Voltage input to EUT: DC from USB		
Freq. Range Scanned: 30MHz – 25GHz @ 3 meters		

Fundamental Frequency:		2412 MHz					
Modulation		CCK @ 11 Mbps					
Output Power:		18.05 dBm conducted, 19.95 dBm EIRP					
Frequency Test Range		30 MHz – 25 GHz					
Frequency (MHz)	RF Peak Level (dBµV/m)	RF Avg Level (dBµV/m)	Antenna Plane (H/V)	Limit 15.209 (dBµV/m)	Limit 15.247 (dBµV/m)	Margin (dB)	Pass/Fail
2412	109.25	--	V	--	--	--	--
2412	112.85	--	H	--	--	--	--
4824	49.52	35.47	V	54.0	92.85	-18.53	Pass*
4824	49.01	35.61	H	54.0	92.85	-18.39	Pass*
7236	56.24	44.78	V	54.0	92.85	-9.22	Pass*
7236	54.37	42.31	H	54.0	92.85	-11.69	Pass*

\*Field strength of emissions appearing within restricted frequency bands shall not exceed the limits in § 15.209.

Fundamental Frequency:		2437 MHz					
Modulation		DQPSK @ 2 Mbps					
Output Power:		17.55 dBm conducted, 19.45 dBm EIRP					
Frequency Test Range		30 MHz – 25 GHz					
Frequency (MHz)	RF Peak Level (dBµV/m)	RF Avg Level (dBµV/m)	Antenna Plane (H/V)	Limit 15.209 (dBµV/m)	Limit 15.247 (dBµV/m)	Margin (dB)	Pass/Fail
2437	108.30	--	V	--	--	--	--
2437	113.02	--	H	--	--	--	--
4874	49.67	35.81	V	54.0	93.02	-18.19	Pass*
4874	49.19	36.42	H	54.0	93.02	-17.58	Pass*
7311	57.01	45.41	V	54.0	93.02	-8.59	Pass*
7311	54.41	42.39	H	54.0	93.02	-11.61	Pass*

\*Field strength of emissions appearing within restricted frequency bands shall not exceed the limits in § 15.209.

Fundamental Frequency:		2462 MHz					
Modulation		DQPSK @ 2 Mbps					
Output Power:		17.41 dBm conducted, 19.31 dBm EIRP					
Frequency Test Range		30 MHz – 25 GHz					
Frequency (MHz)	RF Peak Level (dBµV/m)	RF Avg Level (dBµV/m)	Antenna Plane (H/V)	Limit 15.209 (dBµV/m)	Limit 15.247 (dBµV/m)	Margin (dB)	Pass/Fail
2462	110.76	--	V	--	--	--	--
2462	113.07	--	H	--	--	--	--
4924	49.99	36.08	V	54.0	93.07	-17.92	Pass*
4924	49.38	36.51	H	54.0	93.07	-17.49	Pass*
7386	59.85	45.93	V	54.0	93.07	-8.07	Pass*
7386	54.43	42.51	H	54.0	93.07	-11.49	Pass*

\*Field strength of emissions appearing within restricted frequency bands shall not exceed the limits in § 15.209.

**5.5.5.3. 802.11g Mode**

Product: <b>H840 DEVICE, Model H2G2-42</b>	Test Tech: Mr.Hung Trinh	Date:20 Mar 2013
Configuration: 802.11g, Transmitter mode, Power setting 14		
Analyzer: Rohde & Schwarz		
Amplifier: Pre Amplifier HP8449B		
Voltage input to EUT: DC from USB		
Freq. Range Scanned: 30MHz – 25GHz @ 3 meters		

Fundamental Frequency:		2412 MHz					
Modulation		BPSK @ 1 Mbps					
Output Power:		19.89 dBm conducted, 21.79 dBm EIRP					
Frequency Test Range		30 MHz – 25 GHz					
Frequency (MHz)	RF Peak Level (dBµV/m)	RF Avg Level (dBµV/m)	Antenna Plane (H/V)	Limit 15.209 (dBµV/m)	Limit 15.247 (dBµV/m)	Margin (dB)	Pass/Fail
2412	104.83	--	V	--	--	--	--
2412	109.39	--	H	--	--	--	--
30 – 25,000	< 34.0	--	V	54.0	89.39	--	Pass

\*Field strength of emissions appearing within restricted frequency bands shall not exceed the limits in § 15.209.

Fundamental Frequency:		2437 MHz					
Modulation		BPSK @ 1 Mbps					
Output Power:		19.89 dBm conducted, 21.79 dBm EIRP					
Frequency Test Range		30 MHz – 25 GHz					
Frequency (MHz)	RF Peak Level (dBµV/m)	RF Avg Level (dBµV/m)	Antenna Plane (H/V)	Limit 15.209 (dBµV/m)	Limit 15.247 (dBµV/m)	Margin (dB)	Pass/Fail
2437	106.50	--	V	--	--	--	--
2437	110.48	--	H	--	--	--	--
30 – 25,000	< 34.0	--	V	54.0	90.48	--	Pass

\*Field strength of emissions appearing within restricted frequency bands shall not exceed the limits in § 15.209.



Fundamental Frequency:		2462 MHz					
Modulation		BPSK @ 1 Mbps					
Output Power:		20.15 dBm conducted, 22.05 dBm EIRP					
Frequency Test Range		30 MHz – 25 GHz					
Frequency (MHz)	RF Peak Level (dBµV/m)	RF Avg Level (dBµV/m)	Antenna Plane (H/V)	Limit 15.209 (dBµV/m)	Limit 15.247 (dBµV/m)	Margin (dB)	Pass/Fail
2437	105.11	--	V	--	--	--	--
2437	110.84	--	H	--	--	--	--
30 – 25,000	< 34.0	--	V	54.0	90.84	--	Pass

\*Field strength of emissions appearing within restricted frequency bands shall not exceed the limits in § 15.209.

#### 5.5.5.4. 802.11n Mode

Product: <b>H840 DEVICE, Model H2G2-42</b>	Test Tech: Mr.Hung Trinh	Date:20 Mar 2013
Configuration: 802.11n, Transmitter mode, Power setting 13		
Analyzer: Rohde & Schwarz		
Amplifier: Pre Amplifier HP8449B		
Voltage input to EUT: DC from USB		
Freq. Range Scanned: 30MHz – 25GHz @ 3 meters		

Fundamental Frequency:		2412 MHz					
Modulation		BPSK ½ @ 6.5Mbps					
Output Power:		18.39 dBm conducted, 20.29 dBm EIRP					
Frequency Test Range		30 MHz – 25 GHz					
Frequency (MHz)	RF Peak Level (dBµV/m)	RF Avg Level (dBµV/m)	Antenna Plane (H/V)	Limit 15.209 (dBµV/m)	Limit 15.247 (dBµV/m)	Margin (dB)	Pass/Fail
2412	103.12	--	V	--	--	--	--
2412	108.38	--	H	--	--	--	--
30 – 25,000	< 34.0	--	V	54.0	88.27	--	Pass

\*Field strength of emissions appearing within restricted frequency bands shall not exceed the limits in § 15.209.

Fundamental Frequency:		2437 MHz					
Modulation		64-QAM 5/6 @ 65 Mbps					
Output Power:		17.94 dBm conducted, 19.84 dBm EIRP					
Frequency Test Range		30 MHz – 25 GHz					
Frequency (MHz)	RF Peak Level (dBµV/m)	RF Avg Level (dBµV/m)	Antenna Plane (H/V)	Limit 15.209 (dBµV/m)	Limit 15.247 (dBµV/m)	Margin (dB)	Pass/Fail
2437	105.02	--	V	--	--	--	--
2437	108.37	--	H	--	--	--	--
30 – 25,000	< 34.0	--	V	54.0	88.37	--	Pass

\*Field strength of emissions appearing within restricted frequency bands shall not exceed the limits in § 15.209.

Fundamental Frequency:		2462 MHz					
Modulation		BPSK ½ @ 6.5 Mbps					
Output Power:		17.94 dBm conducted, 19.84 dBm EIRP					
Frequency Test Range		30 MHz – 25 GHz					
Frequency (MHz)	RF Peak Level (dBµV/m)	RF Avg Level (dBµV/m)	Antenna Plane (H/V)	Limit 15.209 (dBµV/m)	Limit 15.247 (dBµV/m)	Margin (dB)	Pass/Fail
2437	104.32	--	V	--	--	--	--
2437	108.56	--	H	--	--	--	--
30 – 25,000	< 34.0	--	V	54.0	88.56	--	Pass

\*Field strength of emissions appearing within restricted frequency bands shall not exceed the limits in § 15.209.

## 5.6. POWER SPECTRAL DENSITY [§ 15.247(e)]

### 5.6.1. Limit(s)

For digitally modulated systems, the power spectral density conducted from the intentional radiator to the antenna shall not be greater than 8 dBm in any 3 kHz band during any time interval of continuous transmission.

### 5.6.2. Method of Measurements

KDB Publication No. 558074 D01 Section 5.3.1 Measurement Procedure PKPSD.

### 5.6.3. Test Instruments

Test Instruments	Manufacturer	Model No.	Serial No.	Frequency Range	Calibration Due Date
Spectrum Analyzer	Rohde & Schwarz	FSEK30	100077	20Hz–40 GHz	2 Nov 2013
Attenuator	Pasternack	PE7024-10	4	DC–26.5 GHz	Cal on use
DC Block	Hewlett Packard	11742A	12460	0.045–26.5 GHz	Cal on use
Laptop	Dell	PPL	9321C-12800-8A2-3775	-	-

### 5.6.4. Test Arrangement

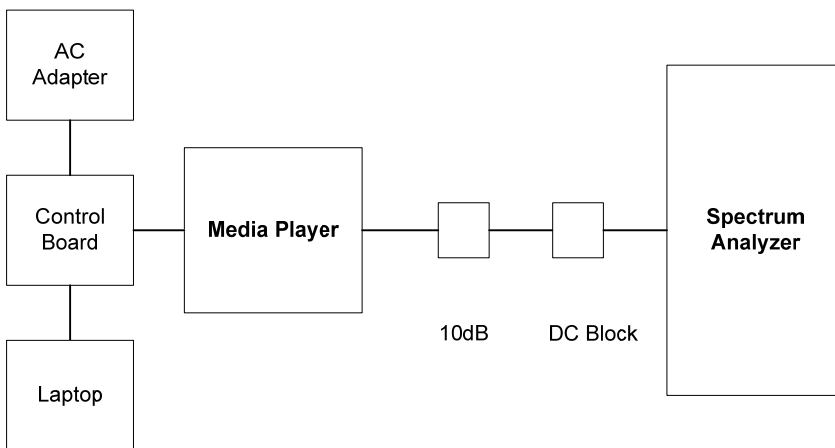

**5.6.5. Test Data**

**Remark:** Measurement method: Section 5.3.1 Measurement Procedure PKPSD

Operation Mode	Frequency (MHz)	Modulation	Data Rate (Mbps)	*PSD in 3 kHz BW (dBm)	Limit (dBm)	Margin (dB)
802.11b	2412	DBPSK	1	-12.28	8	-20.28
		DQPSK	2	-5.21	8	-13.21
		CCK	11	-5.84	8	-13.84
	2437	DBPSK	1	-12.29	8	-20.29
		DQPSK	2	-5.92	8	-13.92
		CCK	11	-6.07	8	-14.07
	2462	DBPSK	1	-12.32	8	-20.32
		DQPSK	2	-5.54	8	-13.54
		CCK	11	-6.29	8	-14.29

Operation Mode	Frequency (MHz)	Modulation	Data Rate (Mbps)	*PSD in 3 kHz BW (dBm)	Limit (dBm)	Margin (dB)
802.11g	2412	BPSK	9	-15.04	8	-23.04
		QPSK	18	-13.10	8	-21.10
		16-QAM	36	-12.18	8	-20.18
		64-QAM	54	-12.56	8	-20.56
	2437	BPSK	9	-14.73	8	-22.73
		QPSK	18	-13.50	8	-21.50
		16-QAM	36	-12.63	8	-20.63
		64-QAM	54	-12.78	8	-20.78
	2462	BPSK	9	-14.95	8	-22.95
		QPSK	18	-14.93	8	-22.93
		16-QAM	36	-14.02	8	-22.02
		64-QAM	54	-14.44	8	-22.44

Operation Mode	Frequency (MHz)	Modulation	Data Rate (Mbps)	*PSD in 3 kHz BW (dBm)	Limit (dBm)	Margin (dB)
802.11n	2412	BPSK 1/2	6.5	-15.30	8	-23.30
		QPSK 3/4	19.5	-14.28	8	-22.28
		16-QAM 3/4	39	-14.37	8	-22.37
		64-QAM 5/6	65	-14.37	8	-22.37
	2437	BPSK 1/2	6.5	-15.45	8	-23.45
		QPSK 3/4	19.5	-14.54	8	-22.54
		16-QAM 3/4	39	-14.70	8	-22.70
		64-QAM 5/6	65	-15.27	8	-23.27
	2462	BPSK 1/2	6.5	-14.14	8	-22.14
		QPSK 3/4	19.5	-14.87	8	-22.87
		16-QAM 3/4	39	-15.28	8	-23.28
		64-QAM 5/6	65	-15.55	8	-23.55

See the following plots for measurement details.

**Plot 5.6.5.1. Power Spectral Density**

Test (specified rules):	FCC 15.247 (e), RSS 210 A8.2(b), Power Spectral Density
Date:	March 18, 2013
Tested by: Name	Hung Trinh
Test method:	KDB 558074 D01 Section 9.1 Maximum PSD Option 1
Comment(s):	2462 MHz, 802.11b, DQPSK 2 Mbps

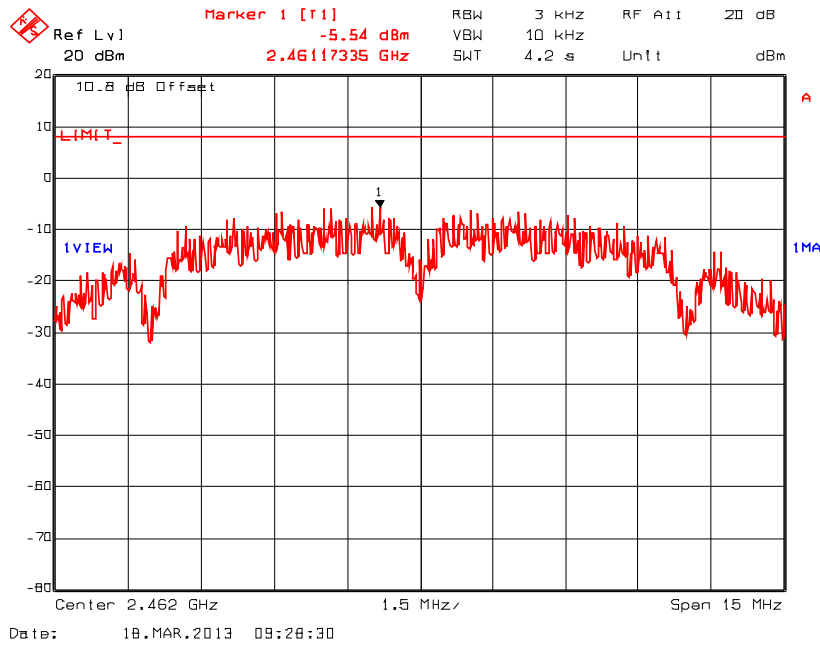

**Plot 5.6.5.2. Power Spectral Density**

Test (specified rules):	FCC 15.247 (e), RSS 210 A8.2(b), Power Spectral Density
Date:	March 18, 2013
Tested by: Name	Hung Trinh
Test method:	KDB 558074 D01 Section 9.1 Maximum PSD Option 1
Comment(s):	2437 MHz, 802.11b, DBPSK 1 Mbps

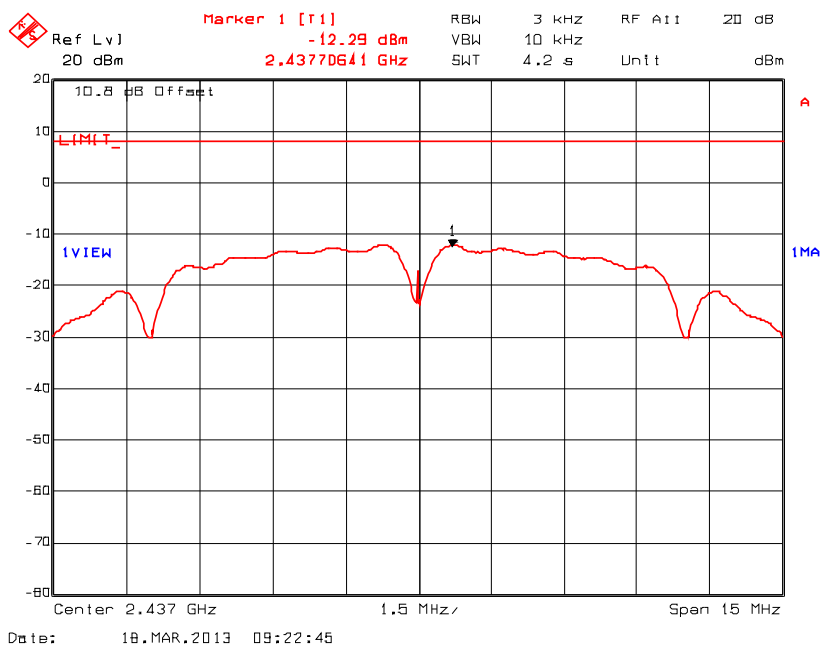

**Plot 5.6.5.3. Power Spectral Density**

Test (specified rules):	FCC 15.247 (e), RSS 210 A8.2(b), Power Spectral Density
Date:	March 18, 2013
Tested by: Name	Hung Trinh
Test method:	KDB 558074 D01 Section 9.1 Maximum PSD Option 1
Comment(s):	2462 MHz, 802.11b, DBPSK 1 Mbps

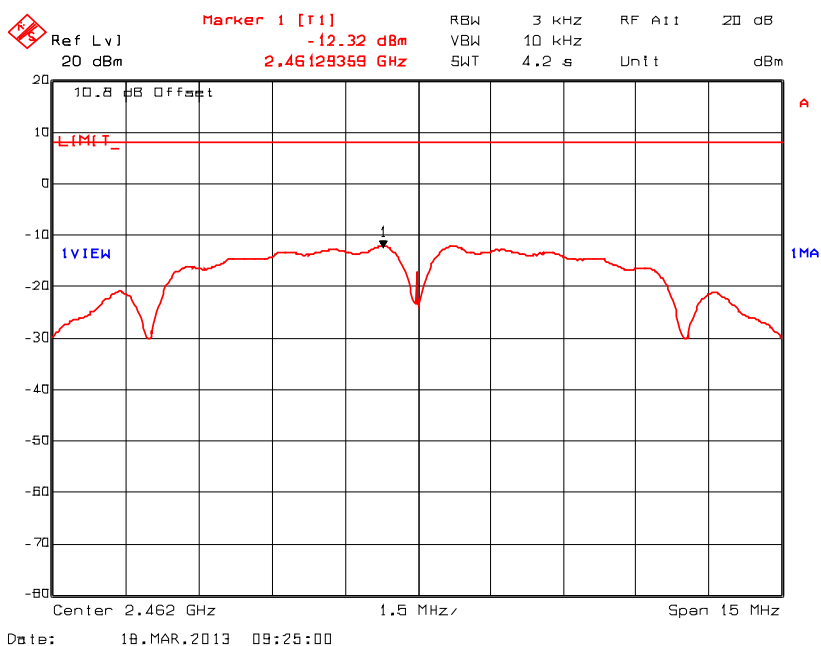

**ULTRATECH GROUP OF LABS**

3000 Bristol Circle, Oakville, Ontario, Canada L6H 6G4  
Tel. #: 905-829-1570, Fax. #: 905-829-8050, Email: [vic@ultratech-labs.com](mailto:vic@ultratech-labs.com), Website: <http://www.ultratech-labs.com>

File #: FLC-007F15C247  
March 26, 2013

All test results contained in this engineering test report are traceable to National Institute of Standards and Technology (NIST)



**Plot 5.6.5.4. Power Spectral Density**

Test (specified rules):	FCC 15.247 (e), RSS 210 A8.2(b), Power Spectral Density
Date:	March 18, 2013
Tested by: Name	Hung Trinh
Test method:	KDB 558074 D01 Section 9.1 Maximum PSD Option 1
Comment(s):	2412 MHz, 802.11b, DQPSK 2 Mbps

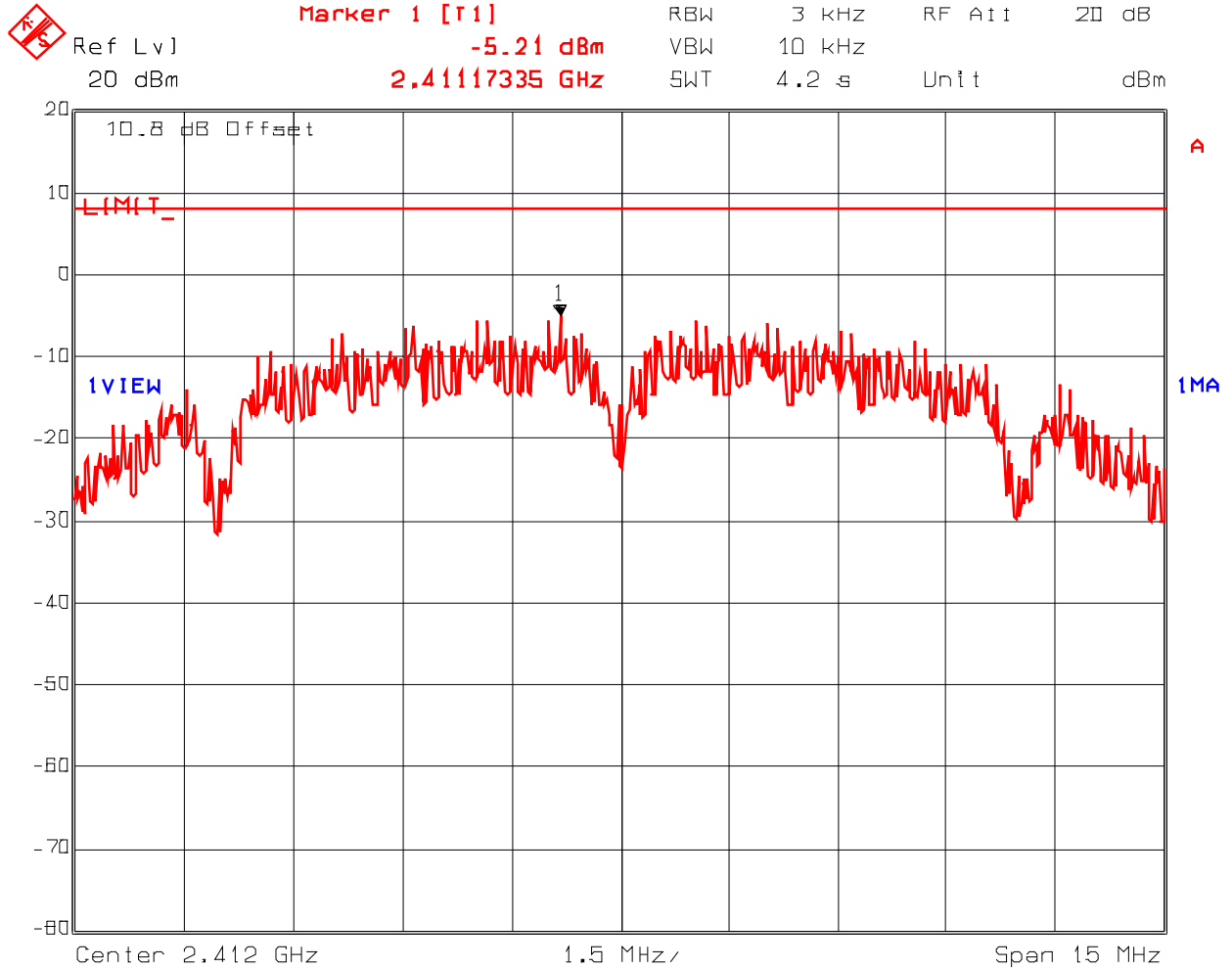

Date: 18.MAR.2013 09:09:35

**ULTRATECH GROUP OF LABS**

3000 Bristol Circle, Oakville, Ontario, Canada L6H 6G4  
Tel. #: 905-829-1570, Fax. #: 905-829-8050, Email: [vic@ultratech-labs.com](mailto:vic@ultratech-labs.com), Website: <http://www.ultratech-labs.com>

File #: FLC-007F15C247

March 26, 2013

All test results contained in this engineering test report are traceable to National Institute of Standards and Technology (NIST)

**Plot 5.6.5.5. Power Spectral Density**

Test (specified rules):	FCC 15.247 (e), RSS 210 A8.2(b), Power Spectral Density
Date:	March 18, 2013
Tested by: Name	Hung Trinh
Test method:	KDB 558074 D01 Section 9.1 Maximum PSD Option 1
Comment(s):	2437 MHz, 802.11b, DQPSK 2 Mbps

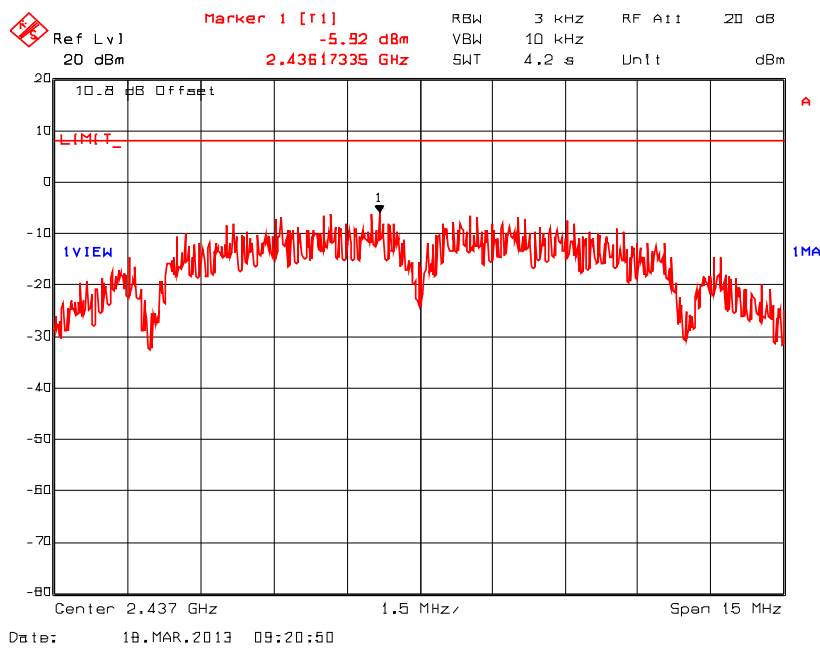

**Plot 5.6.5.6. Power Spectral Density**

Test (specified rules):	FCC 15.247 (e), RSS 210 A8.2(b), Power Spectral Density
Date:	March 18, 2013
Tested by: Name	Hung Trinh
Test method:	KDB 558074 D01 Section 9.1 Maximum PSD Option 1
Comment(s):	2462 MHz, 802.11b, DQPSK 2 Mbps

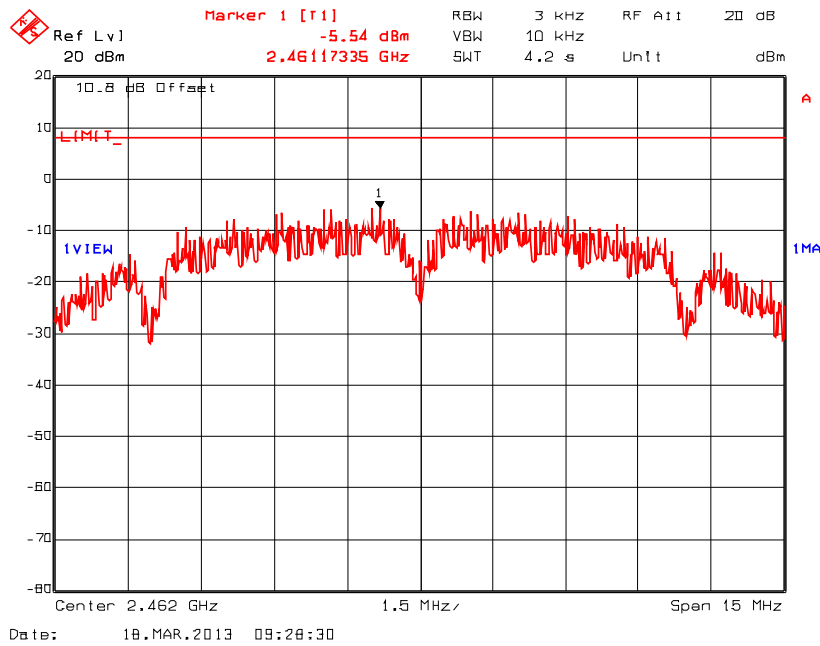

**Plot 5.6.5.7. Power Spectral Density**

Test (specified rules):	FCC 15.247 (e), RSS 210 A8.2(b), Power Spectral Density
Date:	March 18, 2013
Tested by: Name	Hung Trinh
Test method:	KDB 558074 D01 Section 9.1 Maximum PSD Option 1
Comment(s):	2412 MHz, 802.11b, CCK 11 Mbps

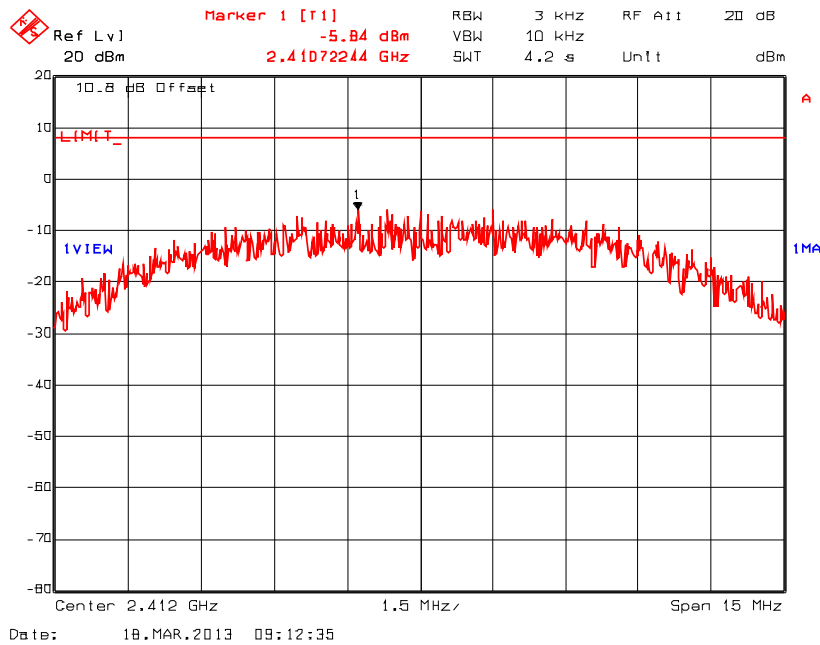

**ULTRATECH GROUP OF LABS**

3000 Bristol Circle, Oakville, Ontario, Canada L6H 6G4  
Tel. #: 905-829-1570, Fax. #: 905-829-8050, Email: [vic@ultratech-labs.com](mailto:vic@ultratech-labs.com), Website: <http://www.ultratech-labs.com>

File #: FLC-007F15C247

March 26, 2013

All test results contained in this engineering test report are traceable to National Institute of Standards and Technology (NIST)

**Plot 5.6.5.8. Power Spectral Density**

Test (specified rules):	FCC 15.247 (e), RSS 210 A8.2(b), Power Spectral Density
Date:	March 18, 2013
Tested by: Name	Hung Trinh
Test method:	KDB 558074 D01 Section 9.1 Maximum PSD Option 1
Comment(s):	2437 MHz, 802.11b, CCK 11 Mbps

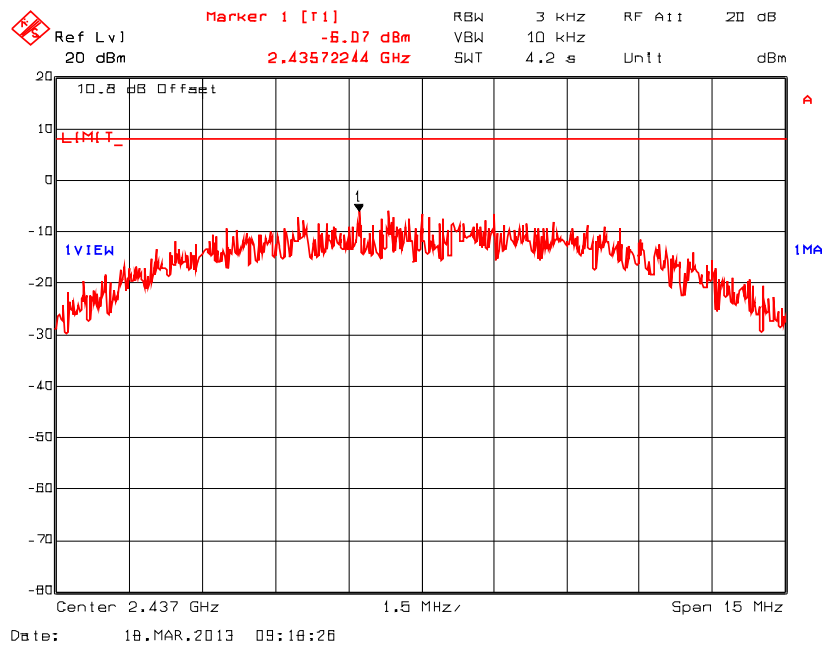

**Plot 5.6.5.9. Power Spectral Density**

Test (specified rules):	FCC 15.247 (e), RSS 210 A8.2(b), Power Spectral Density
Date:	March 18, 2013
Tested by: Name	Hung Trinh
Test method:	KDB 558074 D01 Section 9.1 Maximum PSD Option 1
Comment(s):	2462 MHz, 802.11b, CCK 11 Mbps

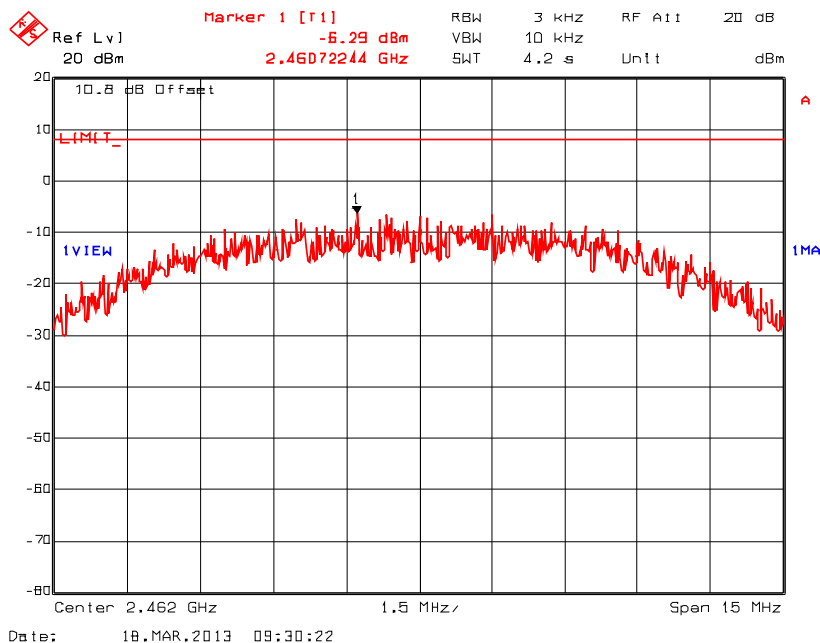

**Plot 5.6.5.10. Power Spectral Density**

Test (specified rules):	FCC 15.247 (e), RSS 210 A8.2(b), Power Spectral Density
Date:	March 20, 2013
Tested by: Name	Hung Trinh
Test method:	KDB 558074 D01 Section 9.1 Maximum PSD Option 1
Comment(s):	2412 MHz, 802.11g, BPSK 9 Mbps

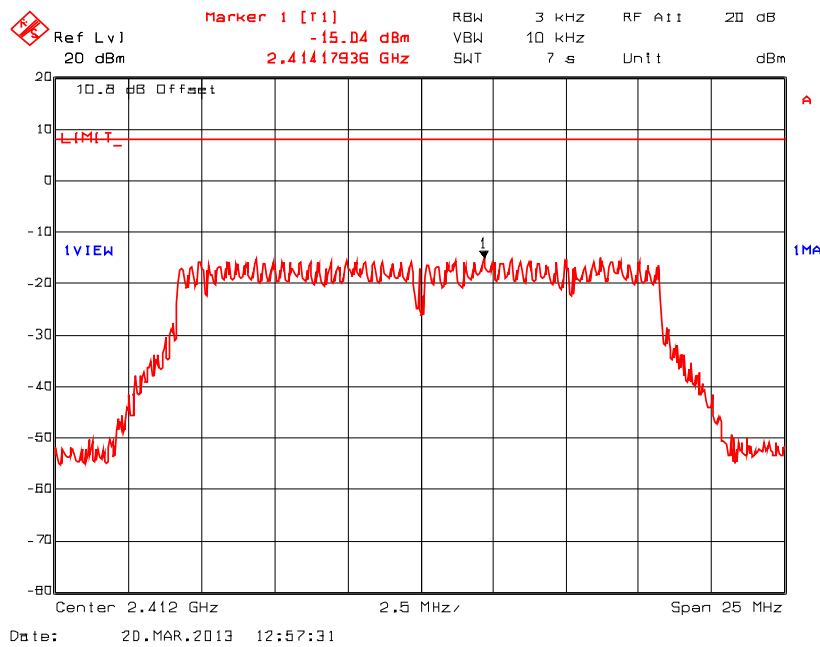

**ULTRATECH GROUP OF LABS**

3000 Bristol Circle, Oakville, Ontario, Canada L6H 6G4  
 Tel. #: 905-829-1570, Fax. #: 905-829-8050, Email: [vic@ultratech-labs.com](mailto:vic@ultratech-labs.com), Website: <http://www.ultratech-labs.com>

File #: FLC-007F15C247

March 26, 2013

*All test results contained in this engineering test report are traceable to National Institute of Standards and Technology (NIST)*

**Plot 5.6.5.11. Power Spectral Density**

Test (specified rules):	FCC 15.247 (e), RSS 210 A8.2(b), Power Spectral Density
Date:	March 20, 2013
Tested by: Name	Hung Trinh
Test method:	KDB 558074 D01 Section 9.1 Maximum PSD Option 1
Comment(s):	2437 MHz, 802.11g, BPSK 9 Mbps

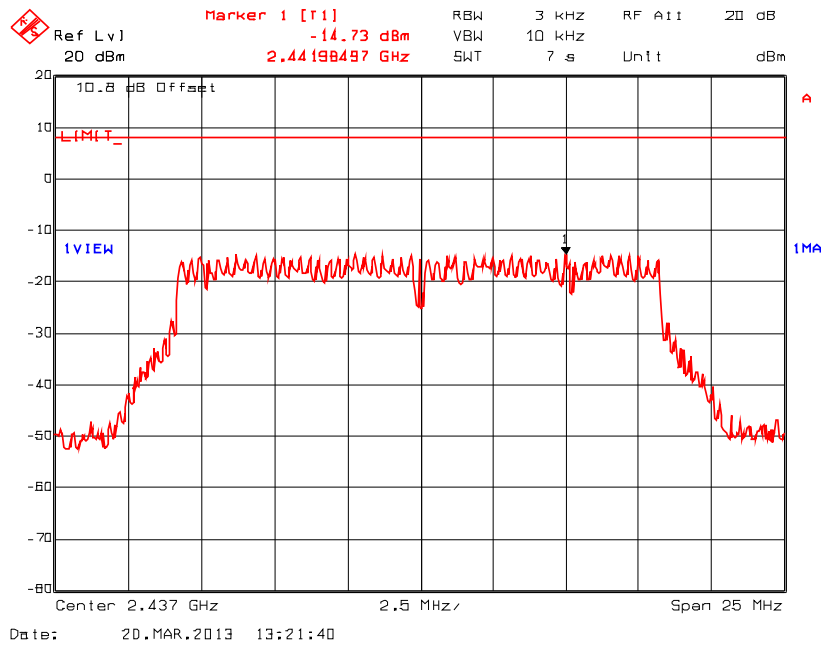



**Plot 5.6.5.12. Power Spectral Density**

Test (specified rules):	FCC 15.247 (e), RSS 210 A8.2(b), Power Spectral Density
Date:	March 20, 2013
Tested by: Name	Hung Trinh
Test method:	KDB 558074 D01 Section 9.1 Maximum PSD Option 1
Comment(s):	2462 MHz, 802.11g, BPSK 9 Mbps

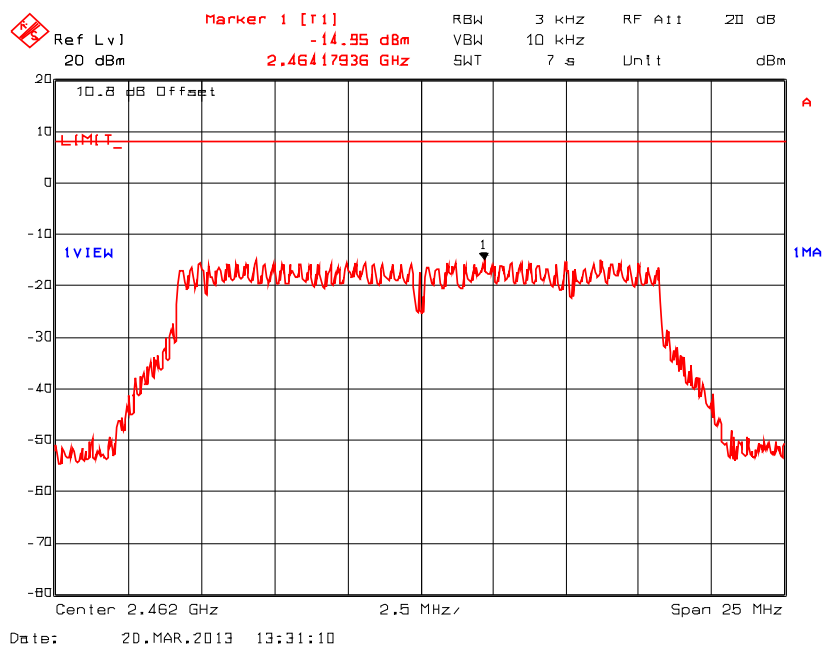

**Plot 5.6.5.13. Power Spectral Density**

Test (specified rules):	FCC 15.247 (e), RSS 210 A8.2(b), Power Spectral Density
Date:	March 20, 2013
Tested by: Name	Hung Trinh
Test method:	KDB 558074 D01 Section 9.1 Maximum PSD Option 1
Comment(s):	2412 MHz, 802.11g, QPSK 18 Mbps

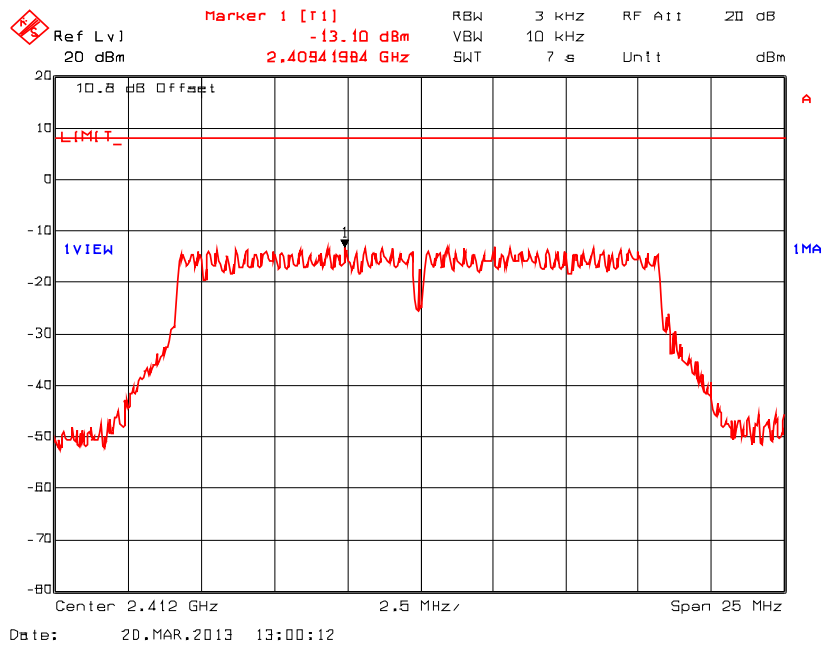

**Plot 5.6.5.14. Power Spectral Density**

Test (specified rules):	FCC 15.247 (e), RSS 210 A8.2(b), Power Spectral Density
Date:	March 20, 2013
Tested by: Name	Hung Trinh
Test method:	KDB 558074 D01 Section 9.1 Maximum PSD Option 1
Comment(s):	2437 MHz, 802.11g, QPSK 18 Mbps

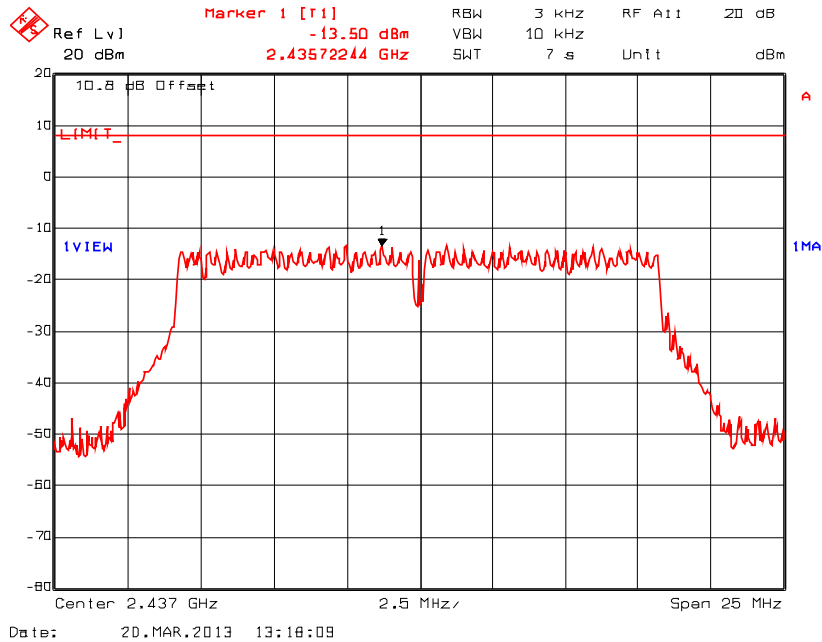

**Plot 5.6.5.15. Power Spectral Density**

Test (specified rules):	FCC 15.247 (e), RSS 210 A8.2(b), Power Spectral Density
Date:	March 20, 2013
Tested by: Name	Hung Trinh
Test method:	KDB 558074 D01 Section 9.1 Maximum PSD Option 1
Comment(s):	2462 MHz, 802.11g, QPSK 18 Mbps

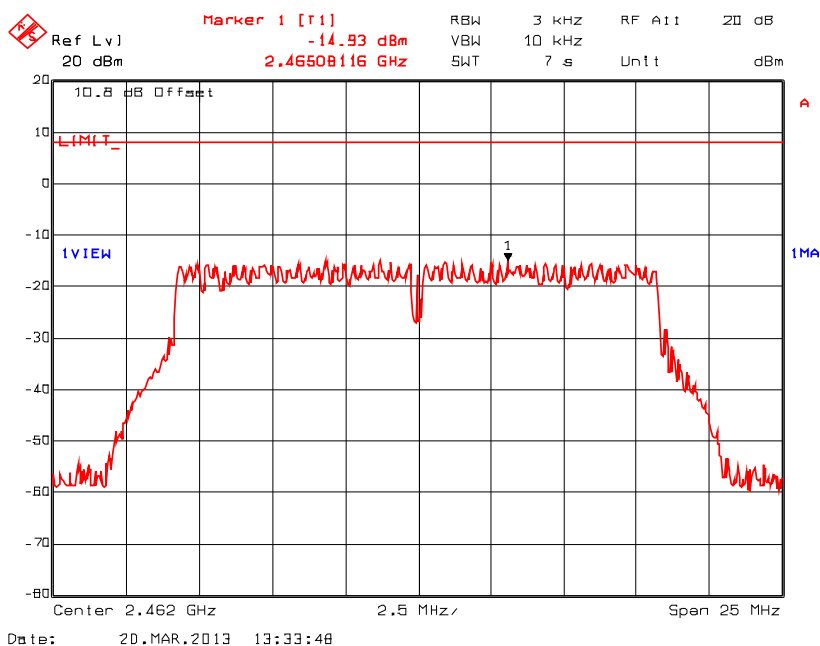

**Plot 5.6.5.16. Power Spectral Density**

Test (specified rules):	FCC 15.247 (e), RSS 210 A8.2(b), Power Spectral Density
Date:	March 20, 2013
Tested by: Name	Hung Trinh
Test method:	KDB 558074 D01 Section 9.1 Maximum PSD Option 1
Comment(s):	2412 MHz, 802.11g, 16-QAM 36 Mbps

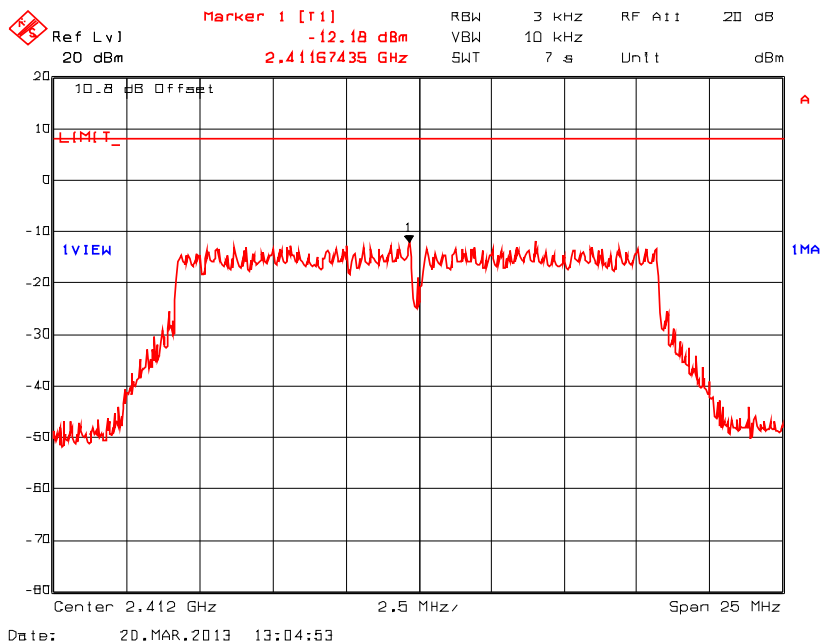

**Plot 5.6.5.17. Power Spectral Density**

Test (specified rules):	FCC 15.247 (e), RSS 210 A8.2(b), Power Spectral Density
Date:	March 20, 2013
Tested by: Name	Hung Trinh
Test method:	KDB 558074 D01 Section 9.1 Maximum PSD Option 1
Comment(s):	2437 MHz, 802.11g, 16-QAM 36 Mbps

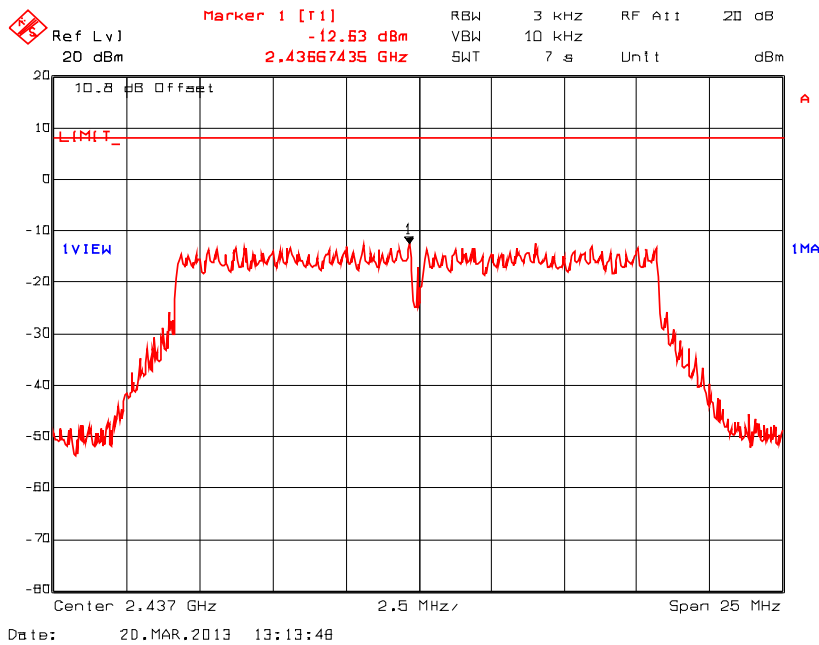

**ULTRATECH GROUP OF LABS**

3000 Bristol Circle, Oakville, Ontario, Canada L6H 6G4  
Tel. #: 905-829-1570, Fax. #: 905-829-8050, Email: [vic@ultratech-labs.com](mailto:vic@ultratech-labs.com), Website: <http://www.ultratech-labs.com>

File #: FLC-007F15C247

March 26, 2013

All test results contained in this engineering test report are traceable to National Institute of Standards and Technology (NIST)

**Plot 5.6.5.18. Power Spectral Density**

Test (specified rules):	FCC 15.247 (e), RSS 210 A8.2(b), Power Spectral Density
Date:	March 20, 2013
Tested by: Name	Hung Trinh
Test method:	KDB 558074 D01 Section 9.1 Maximum PSD Option 1
Comment(s):	2462 MHz, 802.11g, 16-QAM 36 Mbps

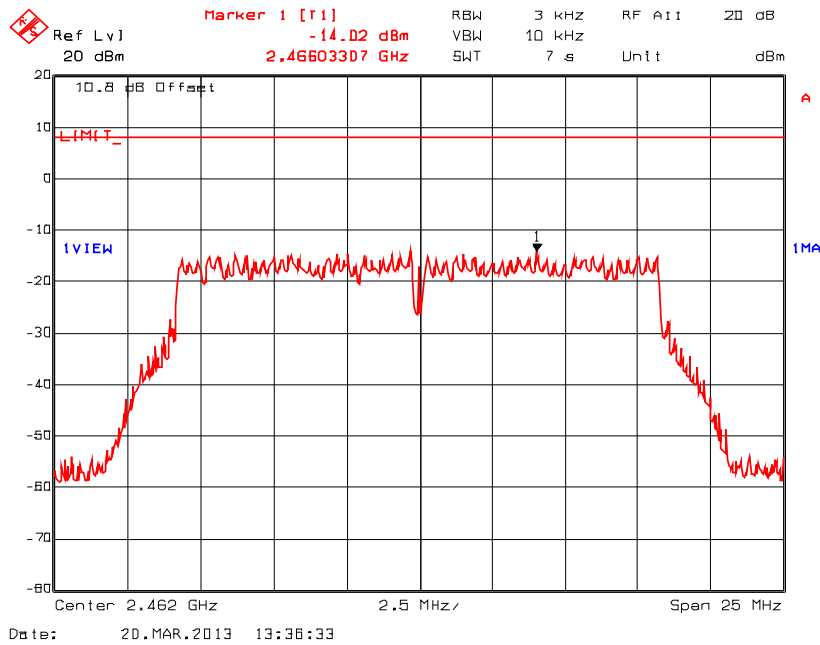

**Plot 5.6.5.19. Power Spectral Density**

Test (specified rules):	FCC 15.247 (e), RSS 210 A8.2(b), Power Spectral Density
Date:	March 20, 2013
Tested by: Name	Hung Trinh
Test method:	KDB 558074 D01 Section 9.1 Maximum PSD Option 1
Comment(s):	2412 MHz, 802.11g, 64-QAM 54 Mbps

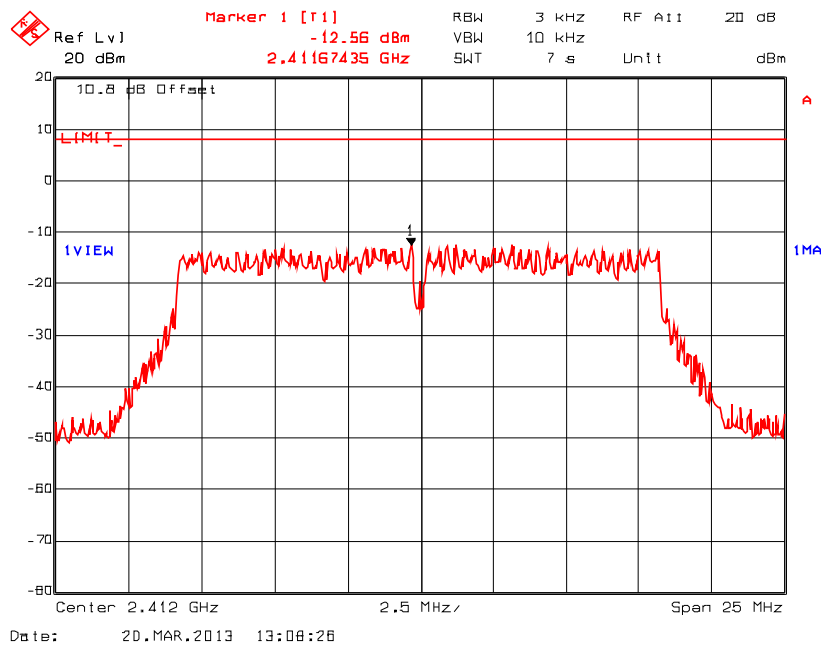

**ULTRATECH GROUP OF LABS**

3000 Bristol Circle, Oakville, Ontario, Canada L6H 6G4  
Tel. #: 905-829-1570, Fax. #: 905-829-8050, Email: [vic@ultratech-labs.com](mailto:vic@ultratech-labs.com), Website: <http://www.ultratech-labs.com>

File #: FLC-007F15C247  
March 26, 2013

All test results contained in this engineering test report are traceable to National Institute of Standards and Technology (NIST)



**Plot 5.6.5.20. Power Spectral Density**

Test (specified rules):	FCC 15.247 (e), RSS 210 A8.2(b), Power Spectral Density
Date:	March 20, 2013
Tested by: Name	Hung Trinh
Test method:	KDB 558074 D01 Section 9.1 Maximum PSD Option 1
Comment(s):	2437 MHz, 802.11g, 64-QAM 54 Mbps

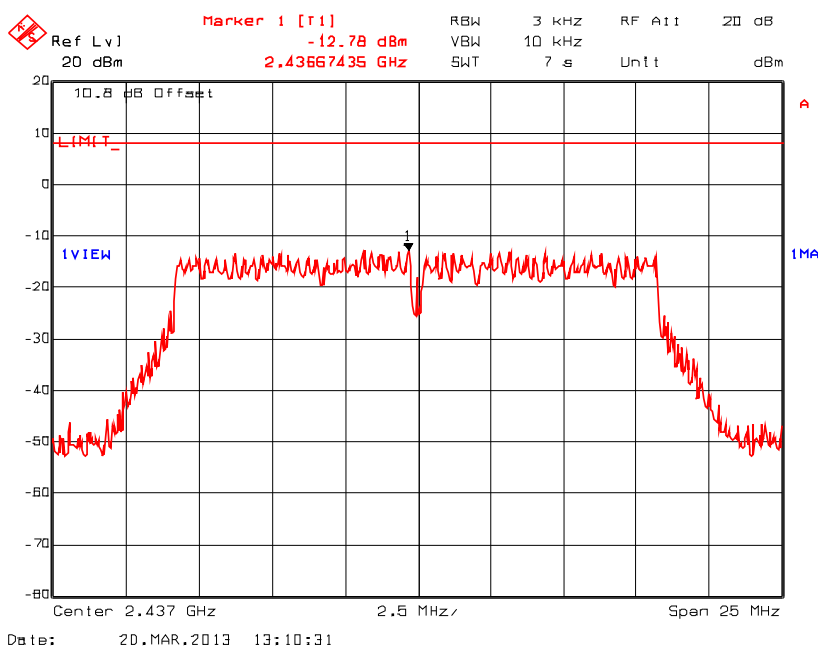

**Plot 5.6.5.21. Power Spectral Density**

Test (specified rules):	FCC 15.247 (e), RSS 210 A8.2(b), Power Spectral Density
Date:	March 20, 2013
Tested by: Name	Hung Trinh
Test method:	KDB 558074 D01 Section 9.1 Maximum PSD Option 1
Comment(s):	2462 MHz, 802.11g, 64-QAM 54 Mbps

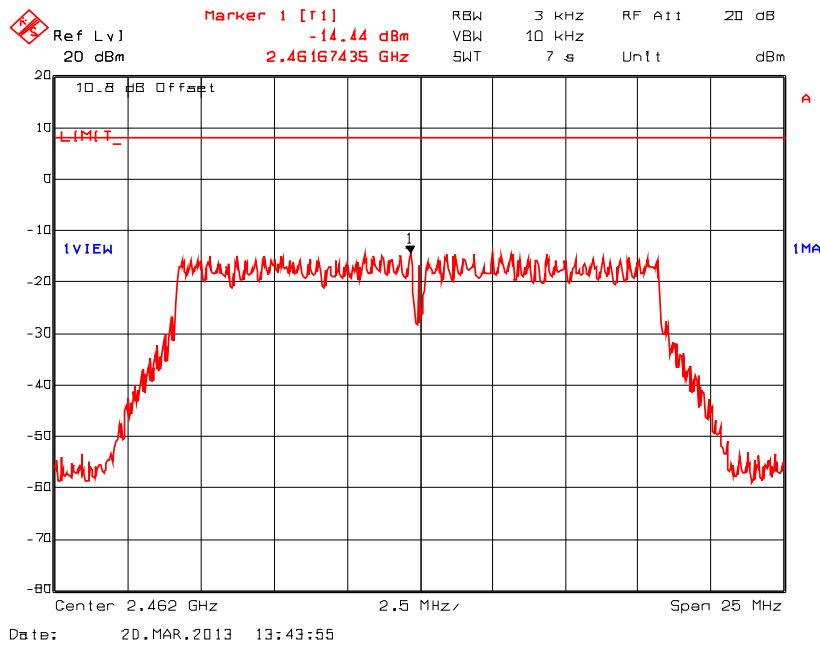

**Plot 5.6.5.22. Power Spectral Density**

Test (specified rules):	FCC 15.247 (e), RSS 210 A8.2(b), Power Spectral Density
Date:	March 20, 2013
Tested by: Name	Hung Trinh
Test method:	KDB 558074 D01 Section 9.1 Maximum PSD Option 1
Comment(s):	2412 MHz, 802.11n, BPSK 1/2 6.5 Mbps

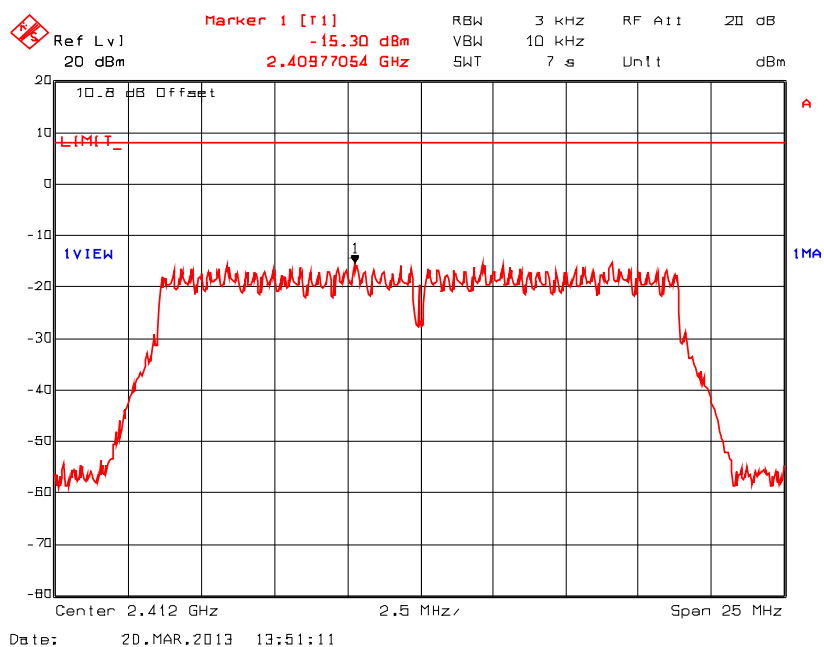

**Plot 5.6.5.23. Power Spectral Density**

Test (specified rules):	FCC 15.247 (e), RSS 210 A8.2(b), Power Spectral Density
Date:	March 20, 2013
Tested by: Name	Hung Trinh
Test method:	KDB 558074 D01 Section 9.1 Maximum PSD Option 1
Comment(s):	2437 MHz, 802.11n, BPSK 1/2 6.5 Mbps

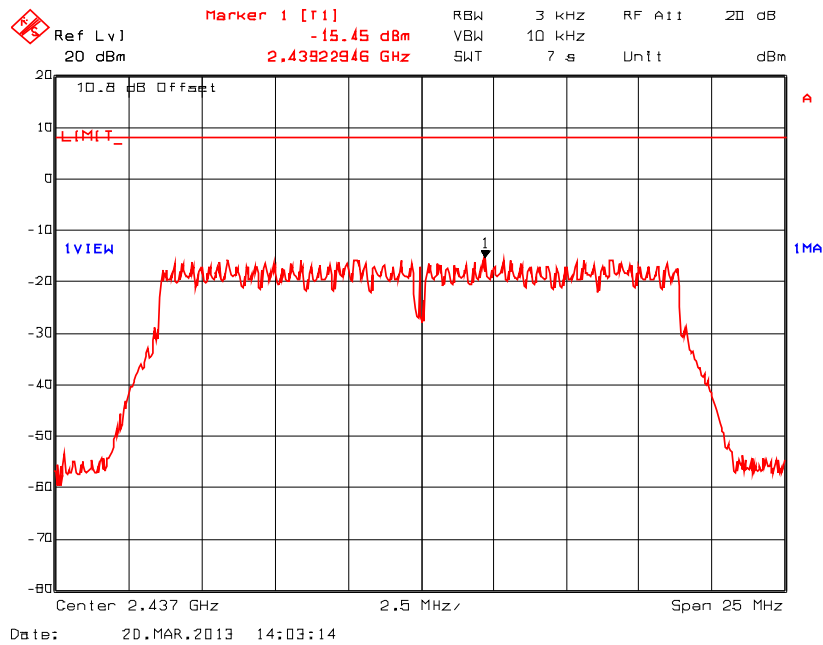

**Plot 5.6.5.24. Power Spectral Density**

Test (specified rules):	FCC 15.247 (e), RSS 210 A8.2(b), Power Spectral Density
Date:	March 20, 2013
Tested by: Name	Hung Trinh
Test method:	KDB 558074 D01 Section 9.1 Maximum PSD Option 1
Comment(s):	2462 MHz, 802.11n, BPSK 1/2 6.5 Mbps

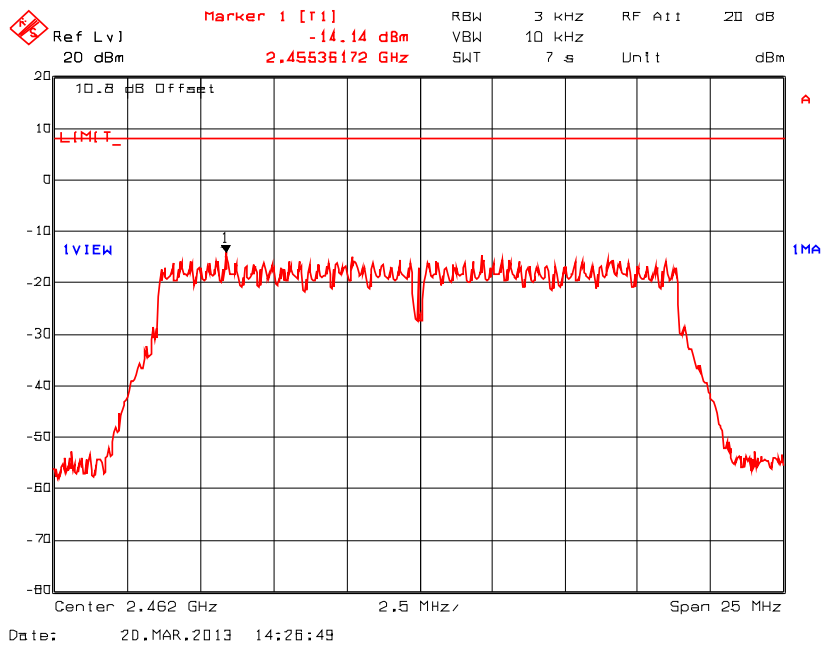

**Plot 5.6.5.25. Power Spectral Density**

Test (specified rules):	FCC 15.247 (e), RSS 210 A8.2(b), Power Spectral Density
Date:	March 20, 2013
Tested by: Name	Hung Trinh
Test method:	KDB 558074 D01 Section 9.1 Maximum PSD Option 1
Comment(s):	2412 MHz, 802.11n, QPSK $\frac{3}{4}$ 19.5 Mbps

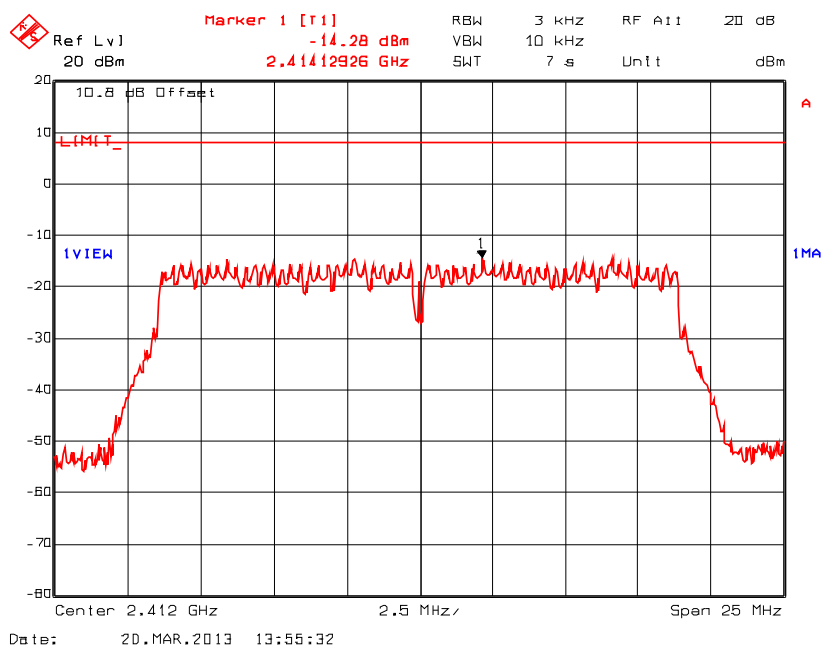

**ULTRATECH GROUP OF LABS**

3000 Bristol Circle, Oakville, Ontario, Canada L6H 6G4  
Tel. #: 905-829-1570, Fax. #: 905-829-8050, Email: [vic@ultratech-labs.com](mailto:vic@ultratech-labs.com), Website: <http://www.ultratech-labs.com>

File #: FLC-007F15C247  
March 26, 2013

All test results contained in this engineering test report are traceable to National Institute of Standards and Technology (NIST)

**Plot 5.6.5.26. Power Spectral Density**

Test (specified rules):	FCC 15.247 (e), RSS 210 A8.2(b), Power Spectral Density
Date:	March 20, 2013
Tested by: Name	Hung Trinh
Test method:	KDB 558074 D01 Section 9.1 Maximum PSD Option 1
Comment(s):	2437 MHz, 802.11n, QPSK 3/4 19.5 Mbps

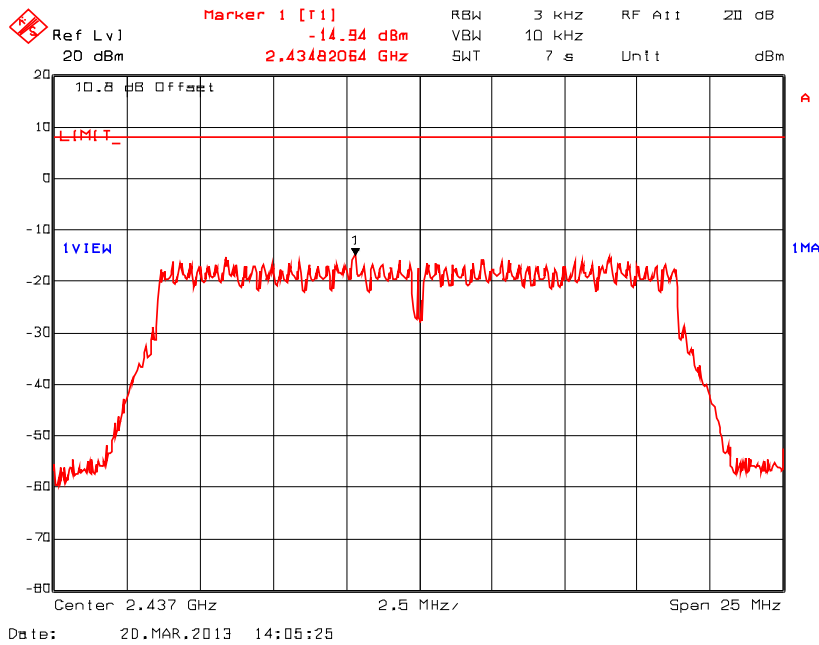

**Plot 5.6.5.27. Power Spectral Density**

Test (specified rules):	FCC 15.247 (e), RSS 210 A8.2(b), Power Spectral Density
Date:	March 20, 2013
Tested by: Name	Hung Trinh
Test method:	KDB 558074 D01 Section 9.1 Maximum PSD Option 1
Comment(s):	2462 MHz, 802.11n, QPSK $\frac{3}{4}$ 19.5 Mbps

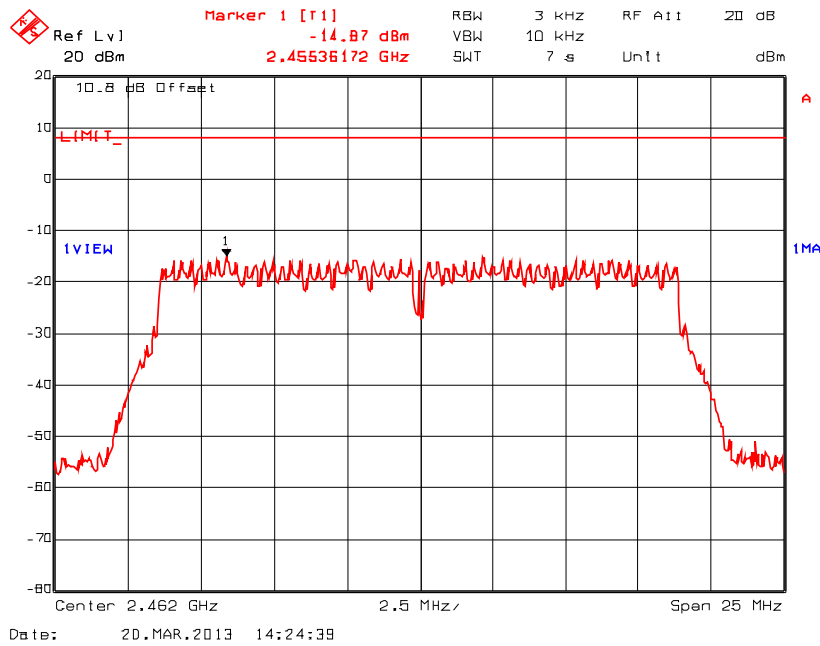



**Plot 5.6.5.28. Power Spectral Density**

Test (specified rules):	FCC 15.247 (e), RSS 210 A8.2(b), Power Spectral Density
Date:	March 20, 2013
Tested by: Name	Hung Trinh
Test method:	KDB 558074 D01 Section 9.1 Maximum PSD Option 1
Comment(s):	2412 MHz, 802.11n, 16-QAM ¼ 39 Mbps

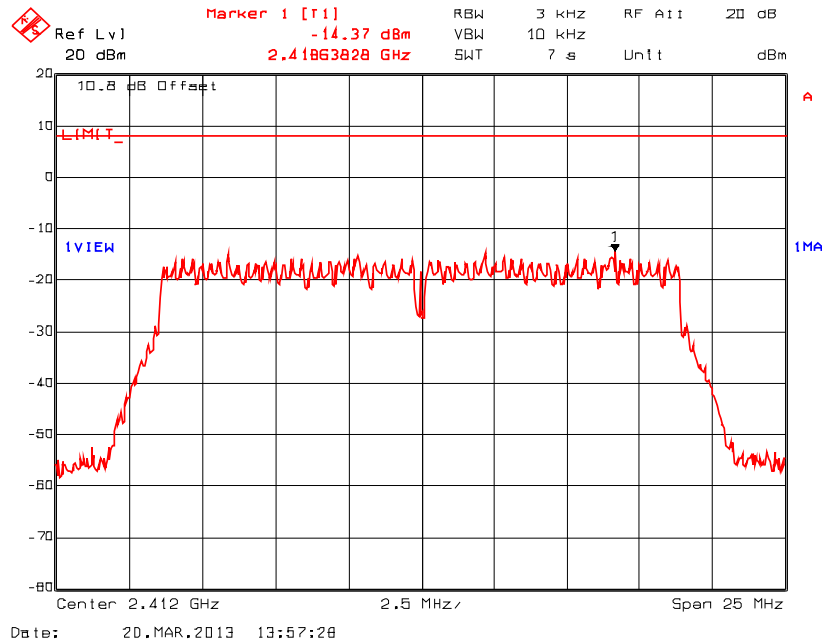

**ULTRATECH GROUP OF LABS**

3000 Bristol Circle, Oakville, Ontario, Canada L6H 6G4  
Tel. #: 905-829-1570, Fax. #: 905-829-8050, Email: [vic@ultratech-labs.com](mailto:vic@ultratech-labs.com), Website: <http://www.ultratech-labs.com>

File #: FLC-007F15C247

March 26, 2013

All test results contained in this engineering test report are traceable to National Institute of Standards and Technology (NIST)

**Plot 5.6.5.29. Power Spectral Density**

Test (specified rules):	FCC 15.247 (e), RSS 210 A8.2(b), Power Spectral Density
Date:	March 20, 2013
Tested by: Name	Hung Trinh
Test method:	KDB 558074 D01 Section 9.1 Maximum PSD Option 1
Comment(s):	2437 MHz, 802.11n, 16-QAM ¼ 39 Mbps

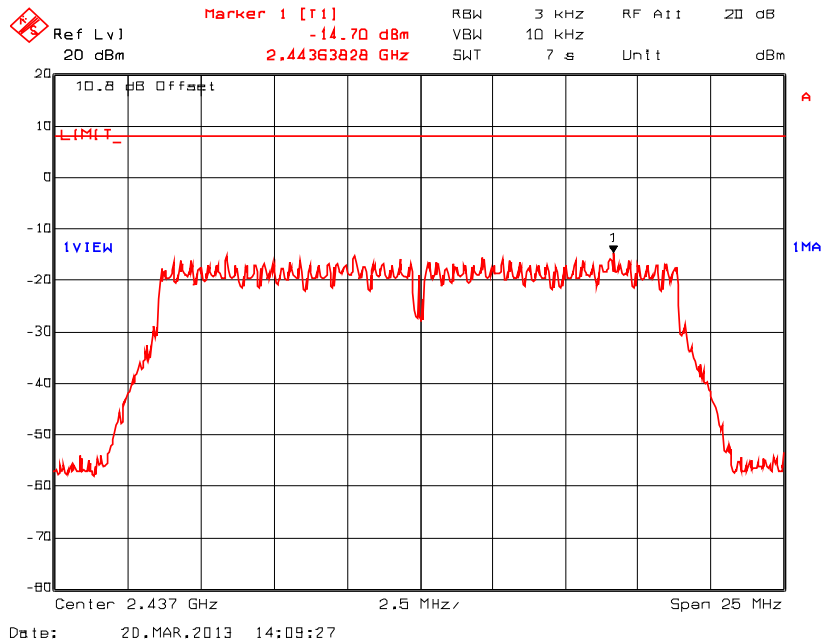

**ULTRATECH GROUP OF LABS**

3000 Bristol Circle, Oakville, Ontario, Canada L6H 6G4  
Tel. #: 905-829-1570, Fax. #: 905-829-8050, Email: [vic@ultratech-labs.com](mailto:vic@ultratech-labs.com), Website: <http://www.ultratech-labs.com>

File #: FLC-007F15C247

March 26, 2013

All test results contained in this engineering test report are traceable to National Institute of Standards and Technology (NIST)

**Plot 5.6.5.30. Power Spectral Density**

Test (specified rules):	FCC 15.247 (e), RSS 210 A8.2(b), Power Spectral Density
Date:	March 20, 2013
Tested by: Name	Hung Trinh
Test method:	KDB 558074 D01 Section 9.1 Maximum PSD Option 1
Comment(s):	2462 MHz, 802.11n, 16-QAM ¾ 39 Mbps

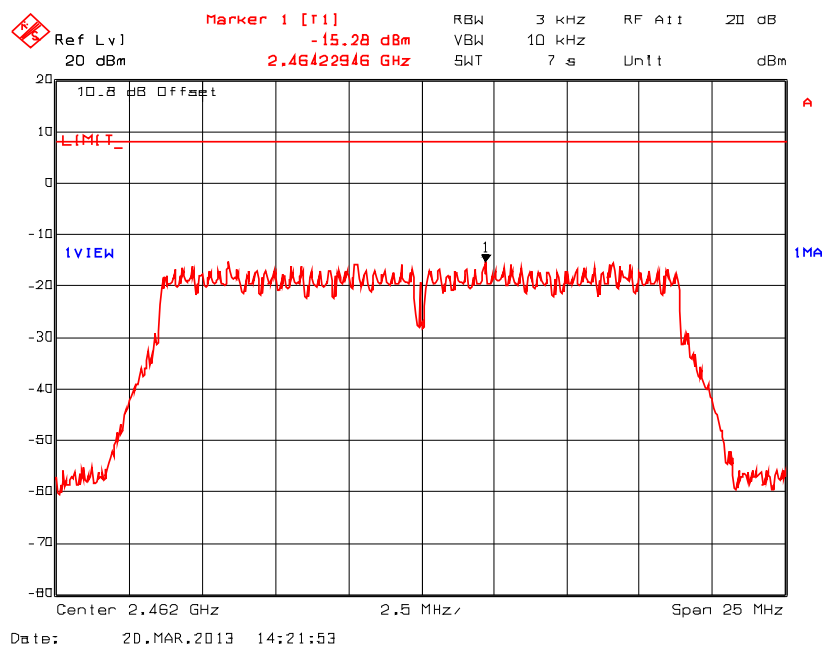

**Plot 5.6.5.31. Power Spectral Density**

Test (specified rules):	FCC 15.247 (e), RSS 210 A8.2(b), Power Spectral Density
Date:	March 20, 2013
Tested by: Name	Hung Trinh
Test method:	KDB 558074 D01 Section 9.1 Maximum PSD Option 1
Comment(s):	2412 MHz, 802.11n, 64-QAM 5/6 65 Mbps

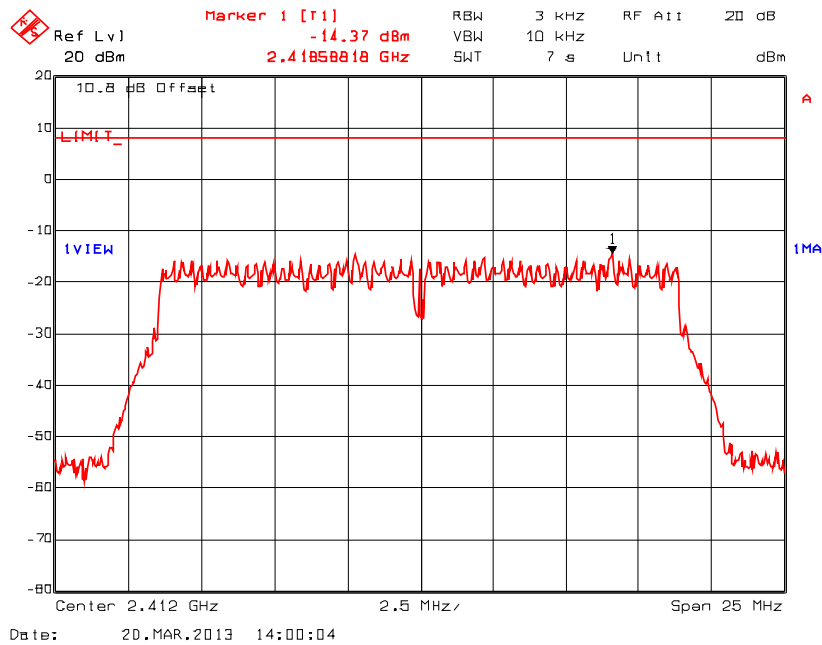

**Plot 5.6.5.32. Power Spectral Density**

Test (specified rules):	FCC 15.247 (e), RSS 210 A8.2(b), Power Spectral Density
Date:	March 20, 2013
Tested by: Name	Hung Trinh
Test method:	KDB 558074 D01 Section 9.1 Maximum PSD Option 1
Comment(s):	2437 MHz, 802.11n, 64-QAM 5/6 65 Mbps

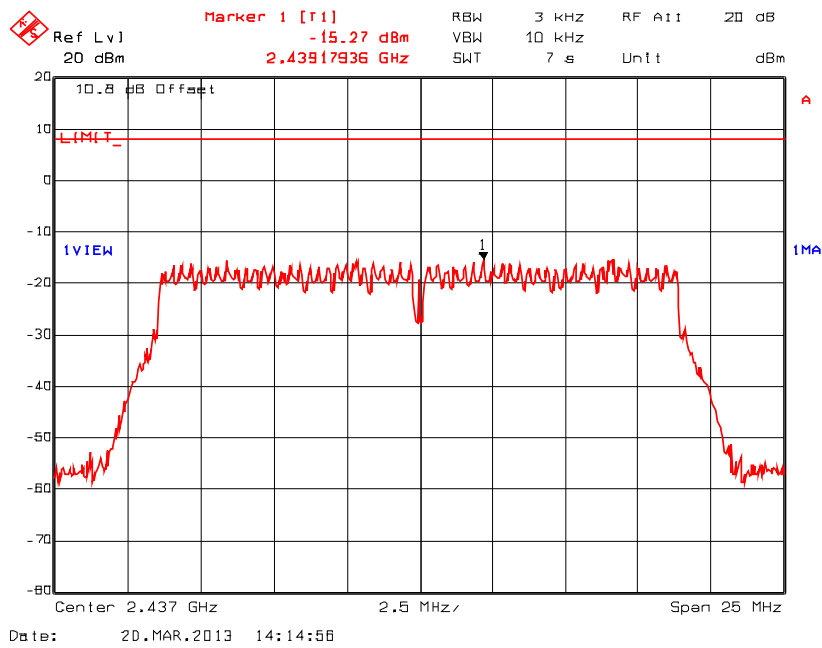

**Plot 5.6.5.33. Power Spectral Density**

Test (specified rules):	FCC 15.247 (e), RSS 210 A8.2(b), Power Spectral Density
Date:	March 20, 2013
Tested by: Name	Hung Trinh
Test method:	KDB 558074 D01 Section 9.1 Maximum PSD Option 1
Comment(s):	2462 MHz, 802.11n, 64-QAM 5/6 65 Mbps

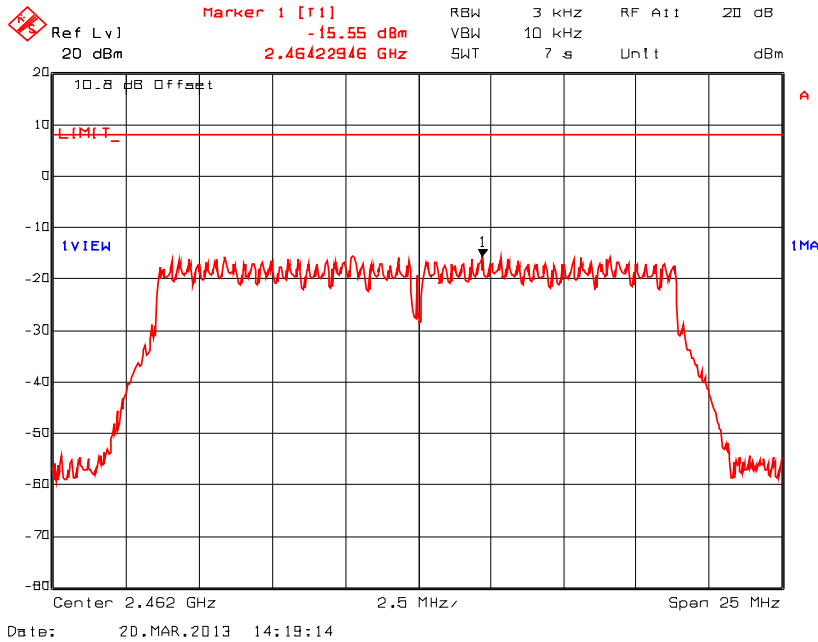

**5.7. RF EXPOSURE REQUIRMENTS [§§ 15.247(b)(5), 1.1310 & 2.1091]**

The criteria listed in the following table shall be used to evaluate the environmental impact of human exposure to radio-frequency (RF) radiation.

**FCC 47 CFR § 1.1310:**

**TABLE 1—LIMITS FOR MAXIMUM PERMISSIBLE EXPOSURE (MPE)**

Frequency range (MHz)	Electric field strength (V/m)	Magnetic field strength (A/m)	Power density (mW/cm <sup>2</sup> )	Averaging time (minutes)
<b>(A) Limits for Occupational/Controlled Exposures</b>				
0.3–3.0 .....	614	1.63	*(100)	6
3.0–30 .....	1842/f	4.89/f	*(900/f <sup>2</sup> )	6
30–300 .....	61.4	0.163	1.0	6
300–1500 .....	.....	.....	f/300	6
1500–100,000 .....	.....	.....	5	6
<b>(B) Limits for General Population/Uncontrolled Exposure</b>				
0.3–1.34 .....	614	1.63	*(100)	30
1.34–30 .....	824/f	2.19/f	*(180/f <sup>2</sup> )	30
30–300 .....	27.5	0.073	0.2	30
300–1500 .....	.....	.....	f/1500	30
1500–100,000 .....	.....	.....	1.0	30

f = frequency in MHz

\* = Plane-wave equivalent power density

NOTE 1 TO TABLE 1: Occupational/controlled limits apply in situations in which persons are exposed as a consequence of their employment provided those persons are fully aware of the potential for exposure and can exercise control over their exposure. Limits for occupational/controlled exposure also apply in situations when an individual is transient through a location where occupational/controlled limits apply provided he or she is made aware of the potential for exposure.

NOTE 2 TO TABLE 1: General population/uncontrolled exposures apply in situations in which the general public may be exposed, or in which persons that are exposed as a consequence of their employment may not be fully aware of the potential for exposure or can not exercise control over their exposure.

**5.7.1. Method of Measurements**

Refer to Sections 1.1310, 2.1091.

In order to demonstrate compliance with MPE requirements (see Section 2.1091), the following information is typically needed:

- (1) Calculation that estimates the minimum separation distance (20 cm or more) between an antenna and persons required to satisfy power density limits defined for free space.
- (2) Antenna installation and device operating instructions for installers (professional/unskilled users), and the parties responsible for ensuring compliance with the RF exposure requirement
- (3) Any caution statements and/or warning labels that are necessary in order to comply with the exposure limits
- (4) Any other RF exposure related issues that may affect MPE compliance

**Calculation Method of RF Safety Distance:**

$$S = \frac{P \cdot G}{4 \cdot \pi \cdot r^2} = \frac{EIRP}{4 \cdot \pi \cdot r^2}$$

Where: P: power input to the antenna in mW  
EIRP: Equivalent (effective) isotropic radiated power  
S: power density mW/cm<sup>2</sup>  
G: numeric gain of antenna relative to isotropic radiator  
r: distance to centre of radiation in cm

**5.7.2. RF Evaluation**

Evaluation of RF Exposure Compliance Requirements	
RF Exposure Requirements	Compliance with FCC Rules
Minimum calculated separation distance between antenna and persons required: <b>3.6 cm (see note)</b>	Manufacturer' instruction for separation distance between antenna and persons required: <b>20 cm.</b>
Antenna installation and device operating instructions for installers (professional/unskilled users), and the parties responsible for ensuring compliance with the RF exposure requirement.	Antenna installation and device operating instructions shall be provided to installers to maintain and ensure compliance with RF exposure requirements.
Caution statements and/or warning labels that are necessary in order to comply with the exposure limits.	Refer to User's Manual for RF Exposure Information.
Any other RF exposure related issues that may affect MPE compliance	None.
<p>NOTE: The minimum separation distance between the antenna and bodies of users are calculated using the following formula:</p> <p>RF Exposure Distance Limits</p> $r = \sqrt{\frac{P \cdot G}{4 \cdot \pi \cdot S}} = \sqrt{\frac{EIRP}{4 \cdot \pi \cdot S}}$ <p>S = 1 mW/cm<sup>2</sup>  EIRP = 22.05 dBm = 160.3 mW (Worst Case)</p> <p><b>(Minimum Safe Distance, r) = <math>\sqrt{\frac{EIRP}{4 \cdot \pi \cdot S}} = \sqrt{\frac{160.3}{4 \cdot \pi \cdot (1)}} \approx 3.6cm</math></b></p> <p>Power density at 20 cm = <math>4 \cdot \pi \cdot r^2 / EIRP = 4 \times (3.1426) \times (1 \times 1) / 160.3 = 0.078 \text{ mW/cm}^2</math></p>	



## EXHIBIT 6. MEASUREMENT UNCERTAINTY

The measurement uncertainties stated were calculated in accordance with the requirements of CISPR 16-4-2 @ IEC:2003 and JCGM 100:2008 (GUM 1995) – Guide to the Expression of Uncertainty in Measurement.

### 6.1. LINE CONDUCTED EMISSION MEASUREMENT UNCERTAINTY

	Line Conducted Emission Measurement Uncertainty (150 kHz – 30 MHz):	Measured	Limit
$u_c$	Combined standard uncertainty: $u_c(y) = \sqrt{\sum_{i=1}^m u_i^2(y)}$	$\pm 1.57$	$\pm 1.8$
$U$	Expanded uncertainty U: $U = 2u_c(y)$	$\pm 3.14$	$\pm 3.6$

### 6.2. RADIATED EMISSION MEASUREMENT UNCERTAINTY

	Radiated Emission Measurement Uncertainty @ 3m, Horizontal (30-1000 MHz):	Measured	Limit
$u_c$	Combined standard uncertainty: $u_c(y) = \sqrt{\sum_{i=1}^m u_i^2(y)}$	$\pm 2.15$	$\pm 2.6$
$U$	Expanded uncertainty U: $U = 2u_c(y)$	$\pm 4.30$	$\pm 5.2$

	Radiated Emission Measurement Uncertainty @ 3m, Vertical (30-1000 MHz):	Measured	Limit
$u_c$	Combined standard uncertainty: $u_c(y) = \sqrt{\sum_{i=1}^m u_i^2(y)}$	$\pm 2.39$	$\pm 2.6$
$U$	Expanded uncertainty U: $U = 2u_c(y)$	$\pm 4.78$	$\pm 5.2$

	Radiated Emission Measurement Uncertainty @ 3 m, Horizontal & Vertical (1 – 26 GHz):	Measured	Limit
$u_c$	Combined standard uncertainty: $u_c(y) = \sqrt{\sum_{i=1}^m u_i^2(y)}$	$\pm 1.87$	Under consideration
$U$	Expanded uncertainty U: $U = 2u_c(y)$	$\pm 3.75$	Under consideration