

FCC Test Report

Report No.: RF190311C07

FCC ID: A4RH2B

Model Name: H2B

Received Date: Mar. 20, 2019

Test Date: Mar. 30, 2019 ~ Apr. 09, 2019

Issued Date: Apr. 26, 2019

Applicant: Google LLC

Address: 1600 Amphitheatre Parkway, Mountain View, CA 94043, USA

Issued By: Bureau Veritas Consumer Products Services (H.K.) Ltd., Taoyuan Branch

Lab Address: No. 47-2, 14th Ling, Chia Pau Vil., Lin Kou Dist., New Taipei City, Taiwan
(R.O.C)

Test Location: No. 19, Hwa Ya 2nd Rd, Wen Hwa Tsuen, Kwei Shan Hsiang, Taoyuan
Hsien 333, Taiwan, R.O.C.

**FCC Registration /
Designation Number:** 788550 / TW0003



This report is for your exclusive use. Any copying or replication of this report to or for any other person or entity, or use of our name or trademark, is permitted only with our prior written permission. This report sets forth our findings solely with respect to the test samples identified herein. The results set forth in this report are not indicative or representative of the quality or characteristics of the lot from which a test sample was taken or any similar or identical product unless specifically and expressly noted. Our report includes all of the tests requested by you and the results thereof based upon the information that you provided to us. You have 60 days from date of issuance of this report to notify us of any material error or omission caused by our negligence, provided, however, that such notice shall be in writing and shall specifically address the issue you wish to raise. A failure to raise such issue within the prescribed time shall constitute your unqualified acceptance of the completeness of this report, the tests conducted and the correctness of the report contents. Unless specific mention, the uncertainty of measurement has been explicitly taken into account to declare the compliance or non-compliance to the specification. The report must not be used by the client to claim product certification, approval, or endorsement by TAF or any government agencies.

Table of Contents

Release Control Record	4
1 Certificate of Conformity	5
2 Summary of Test Results	6
2.1 Measurement Uncertainty	6
2.2 Modification Record	6
3 General Information	7
3.1 General Description of EUT	7
3.2 Description of Test Modes	9
3.2.1 Test Mode Applicability and Tested Channel Detail	11
3.3 Duty Cycle of Test Signal	13
3.4 Description of Support Units	14
3.4.1 Configuration of System under Test	14
3.5 General Description of Applied Standards	14
4 Test Types and Results	15
4.1 Radiated Emission and Bandedge Measurement	15
4.1.1 Limits of Radiated Emission and Bandedge Measurement	15
4.1.2 Limits of Unwanted Emission Out of the Restricted Bands	16
4.1.3 Test Instruments	17
4.1.4 Test Procedures	18
4.1.5 Deviation from Test Standard	19
4.1.6 Test Setup	19
4.1.7 EUT Operating Conditions	20
4.1.8 Test Results	21
4.2 Conducted Emission Measurement	116
4.2.1 Limits of Conducted Emission Measurement	116
4.2.2 Test Instruments	116
4.2.3 Test Procedures	117
4.2.4 Deviation from Test Standard	117
4.2.5 Test Setup	117
4.2.6 EUT Operating Conditions	117
4.2.7 Test Results	118
4.3 Transmit Power Measurement	120
4.3.1 Limits of Transmit Power Measurement	120
4.3.2 Test Setup	120
4.3.3 Test Instruments	121
4.3.4 Test Procedure	121
4.3.5 Deviation from Test Standard	121
4.3.6 EUT Operating Conditions	121
4.3.7 Test Results	122
4.4 Occupied Bandwidth Measurement	128
4.4.1 Test Setup	128
4.4.2 Test Instruments	128
4.4.3 Test Procedure	128
4.4.4 Test Results	129
4.5 Power Spectral Density Measurement	132
4.5.1 Limits of Power Spectral Density Measurement	132
4.5.2 Test Setup	132
4.5.3 Test Instruments	132
4.5.4 Test Procedures	132
4.5.5 Deviation from Test Standard	133
4.5.6 EUT Operating Conditions	133
4.5.7 Test Results	134
4.6 Frequency Stability	139

4.6.1	Limit of Frequency Stability Measurement	139
4.6.2	Test Setup	139
4.6.3	Test Instruments	139
4.6.4	Test Procedure	139
4.6.5	Deviation from Test Standard	139
4.6.6	EUT Operating Condition	139
4.6.7	Test Results	140
4.7	6 dB Bandwidth Measurement.....	141
4.7.1	Limits of 6 dB Bandwidth Measurement.....	141
4.7.2	Test Setup.....	141
4.7.3	Test Instruments	141
4.7.4	Test Procedure	141
4.7.5	Deviation from Test Standard	141
4.7.6	EUT Operating Condition	141
4.7.7	Test Results	142
5	Pictures of Test Arrangements.....	144
	Annex A- Band-edge measurement (For U-NII-1, U-NII-2A, U-NII-2C band).....	145
	Appendix – Information of the Testing Laboratories	178

Release Control Record

Issue No.	Description	Date Issued
RF190311C07	Original Release	Apr. 26, 2019

1 Certificate of Conformity

Product: Media Device

Model Name: H2B

Sample Status: Engineering Sample

Applicant: Google LLC

Test Date: Mar. 30, 2019 ~ Apr. 09, 2019

Standards: 47 CFR FCC Part 15, Subpart E (Section 15.407)
ANSI C63.10:2013

The above equipment has been tested by **Bureau Veritas Consumer Products Services (H.K.) Ltd., Taoyuan Branch**, and found compliance with the requirement of the above standards. The test record, data evaluation & Equipment Under Test (EUT) configurations represented herein are true and accurate accounts of the measurements of the sample's RF characteristics under the conditions specified in this report.

Prepared by : , **Date:** Apr. 26, 2019
Gina Liu / Specialist

Approved by : , **Date:** Apr. 26, 2019
Dylan Chiou / Project Engineer

2 Summary of Test Results

47 CFR FCC Part 15, Subpart E (Section 15.407)			
FCC Clause	Test Item	Result	Remarks
15.407(b)(6)	AC Power Conducted Emissions	Pass	Meet the requirement of limit. Minimum passing margin is -27.95 dB at 0.66633 MHz.
15.407(b) (1/2/3/4(i/ii)/6)	Radiated Emissions & Band Edge Measurement	Pass	Meet the requirement of limit. Minimum passing margin is -1.51 dB at 5149.76 MHz.
15.407(a)(1/2/3)	Max Average Transmit Power	Pass	Meet the requirement of limit.
---	Occupied Bandwidth Measurement	-	Reference only
15.407(a)(1/2/3)	Power Spectral Density	Pass	Meet the requirement of limit.
15.407(e)	6 dB Bandwidth	Pass	Meet the requirement of limit. (U-NII-3 Band only)
15.407(g)	Frequency Stability	Pass	Meet the requirement of limit.
15.203	Antenna Requirement	Pass	Antenna connector is mini murata not a standard connector.

Note:

For U-NII-3 band compliance with rule part 15.407(b)(4)(i), the OOB test plots were recorded in Annex A.

- Determining compliance based on the results of the compliance measurement, not taking into account measurement instrumentation uncertainty.

2.1 Measurement Uncertainty

Where relevant, the following measurement uncertainty levels have been estimated for tests performed on the EUT as specified in CISPR 16-4-2:

Measurement	Frequency	Expanded Uncertainty (k=2) (±)
Conducted Emissions at mains ports	150 kHz ~ 30 MHz	2.44 dB
Radiated Emissions up to 1 GHz	9 kHz ~ 30 MHz	3.04 dB
	30 MHz ~ 200 MHz	2.93 dB
	200 MHz ~ 1000 MHz	2.95 dB
Radiated Emissions above 1 GHz	1 GHz ~ 18 GHz	2.26 dB
	18 GHz ~ 40 GHz	1.94 dB

2.2 Modification Record

There were no modifications required for compliance.

3 General Information

3.1 General Description of EUT

Product	Media Device
Model Name	H2B
Status of EUT	Engineering Sample
Power Supply Rating	3.8 Vdc (Li-ion battery)
Modulation Type	256QAM, 64QAM, 16QAM, QPSK, BPSK
Modulation Technology	OFDM
Transfer Rate	802.11a: 54.0/ 48.0/ 36.0/ 24.0/ 18.0/ 12.0/ 9.0/ 6.0 Mbps 802.11n: up to 150.0 Mbps 802.11ac: up to 433.3 Mbps
Operating Frequency	5180 ~ 5240 MHz, 5260 ~ 5320 MHz, 5500 ~ 5720 MHz, 5745 ~ 5825 MHz
Number of Channel	5180 ~ 5240 MHz: 4 for 802.11a, 802.11n (HT20) 2 for 802.11n (HT40) 1 for 802.11ac (VHT80) 5260 ~ 5320 MHz: 4 for 802.11a, 802.11n (HT20) 2 for 802.11n (HT40) 1 for 802.11ac (VHT80) 5500 ~ 5720 MHz: 12 for 802.11a, 802.11n (HT20) 6 for 802.11n (HT40) 3 for 802.11ac (VHT80) 5745 ~ 5825 MHz: 5 for 802.11a, 802.11n (HT20) 2 for 802.11n (HT40) 1 for 802.11ac (VHT80)
Output Power	62.661 mW for 5180 ~ 5240 MHz 55.463 mW for 5260 ~ 5320 MHz 43.451 mW for 5500 ~ 5720 MHz 46.774 mW for 5745 ~ 5825 MHz
Antenna Type	Loop / Stamped metal antenna with 3.26 dBi gain (5180 ~ 5240 MHz) Loop / Stamped metal antenna with 3.91 dBi gain (5260 ~ 5320 MHz) Loop / Stamped metal antenna with 4.49 dBi gain (5500 ~ 5720 MHz) Loop / Stamped metal antenna with 4.76 dBi gain (5745 ~ 5825 MHz)
Antenna Connector	mini murata
Accessory Device	Refer to Note as below
Data Cable Supplied	Refer to Note as below
HW Version	EVT
SW Version	003.006.006.0049.0121

Note:

1. The EUT provides one completed transmitter and one receiver.

Modulation Mode	Tx Function
802.11a	1TX
802.11n (HT20)	1TX
802.11n (HT40)	1TX
802.11ac (VHT20)	1TX
802.11ac (VHT40)	1TX
802.11ac (VHT80)	1TX

* The modulation and bandwidth are similar for 802.11n mode for HT20 / HT40 and 802.11ac mode for VHT20 / VHT40, therefore investigated worst case to representative mode in test report. (Final test mode refer section 3.2.1)

2. The EUT's accessories list refers to Ext. Pho.
3. The above EUT information is declared by manufacturer and for more detailed features description, please refers to the manufacturer's specifications or user's manual.

3.2 Description of Test Modes

For 5180 ~ 5240 MHz

4 channels are provided for 802.11a, 802.11n (HT20):

Channel	Frequency (MHz)	Channel	Frequency (MHz)
36	5180	44	5220
40	5200	48	5240

2 channels are provided for 802.11n (HT40):

Channel	Frequency (MHz)	Channel	Frequency (MHz)
38	5190	46	5230

1 channel is provided for 802.11ac (VHT80):

Channel	Frequency (MHz)
42	5210

For 5260 ~ 5320 MHz

4 channels are provided for 802.11a, 802.11n (HT20):

Channel	Frequency (MHz)	Channel	Frequency (MHz)
52	5260	60	5300
56	5280	64	5320

2 channels are provided for 802.11n (HT40):

Channel	Frequency (MHz)	Channel	Frequency (MHz)
54	5270	62	5310

1 channel is provided for 802.11ac (VHT80):

Channel	Frequency (MHz)
58	5290

For 5500 ~ 5720 MHz

12 channels are provided for 802.11a, 802.11n (HT20):

Channel	Frequency (MHz)	Channel	Frequency (MHz)
100	5500	124	5620
104	5520	128	5640
108	5540	132	5660
112	5560	136	5680
116	5580	140	5700
120	5600	144	5720

6 channels are provided for 802.11n (HT40):

Channel	Frequency (MHz)	Channel	Frequency (MHz)
102	5510	126	5630
110	5550	134	5670
118	5590	142	5710

3 channels are provided for 802.11ac (VHT80):

Channel	Frequency (MHz)	Channel	Frequency (MHz)
106	5530	138	5690
122	5610		

For 5745 ~ 5825 MHz:

5 channels are provided for 802.11a, 802.11n (HT20):

Channel	Frequency (MHz)	Channel	Frequency (MHz)
149	5745	161	5805
153	5765	165	5825
157	5785		

2 channels are provided for 802.11n (HT40):

Channel	Frequency (MHz)	Channel	Frequency (MHz)
151	5755	159	5795

1 channel is provided for 802.11ac (VHT80):

Channel	Frequency (MHz)
155	5775

3.2.1 Test Mode Applicability and Tested Channel Detail

EUT Configure Mode	Applicable To				Description
	RE \geq 1G	RE $<$ 1G	PLC	APCM	
-	√	√	√	√	-

Where **RE \geq 1G**: Radiated Emission above 1 GHz **RE $<$ 1G**: Radiated Emission below 1 GHz
PLC: Power Line Conducted Emission **APCM**: Antenna Port Conducted Measurement

Note:

1. The EUT had been pre-tested on the positioned of each 3 axis. The worst case was found when positioned on **Z-plane**.
2. "-" means no effect.

Radiated Emission Test (Above 1 GHz):

- Pre-Scan has been conducted to determine the worst-case mode from all possible combinations between available modulations, data rates and antenna ports (if EUT with antenna diversity architecture).
- Following channel(s) was (were) selected for the final test as listed below.

EUT Configure Mode	Frequency Band (MHz)	Mode	Available Channel	Tested Channel	Modulation Technology	Modulation Type	Data Rate (Mbps)
-	5180-5240	802.11a	36 to 48	36, 40, 48	OFDM	BPSK	6.0
-		802.11n (HT20)	36 to 48	36, 40, 48	OFDM	BPSK	6.5
-		802.11n (HT40)	38 to 46	38, 46	OFDM	BPSK	13.5
-		802.11ac (VHT80)	42	42	OFDM	BPSK	29.3
-	5260-5320	802.11a	52 to 64	52, 60, 64	OFDM	BPSK	6.0
-		802.11n (HT20)	52 to 64	52, 60, 64	OFDM	BPSK	6.5
-		802.11n (HT40)	54 to 62	54, 62	OFDM	BPSK	13.5
-		802.11ac (VHT80)	58	58	OFDM	BPSK	29.3
-	5500-5720	802.11a	100 to 144	100, 116, 140, 144	OFDM	BPSK	6.0
-		802.11n (HT20)	100 to 144	100, 116, 140, 144	OFDM	BPSK	6.5
-		802.11n (HT40)	102 to 142	102, 110, 134, 142	OFDM	BPSK	13.5
-		802.11ac (VHT80)	106 to 138	106, 122, 138	OFDM	BPSK	29.3
-	5745-5825	802.11a	149 to 165	149, 157, 165	OFDM	BPSK	6.0
-		802.11n (HT20)	149 to 165	149, 157, 165	OFDM	BPSK	6.5
-		802.11n (HT40)	151 to 159	151, 159	OFDM	BPSK	13.5
-		802.11ac (VHT80)	155	155	OFDM	BPSK	29.3

Radiated Emission Test (Below 1 GHz):

- Pre-Scan has been conducted to determine the worst-case mode from all possible combinations between available modulations, data rates and antenna ports (if EUT with antenna diversity architecture).
- Following channel(s) was (were) selected for the final test as listed below.

EUT Configure Mode	Frequency Band (MHz)	Mode	Available Channel	Tested Channel	Modulation Technology	Modulation Type	Data Rate (Mbps)
-	5180-5240	802.11n (HT20)	36 to 48	40	OFDM	BPSK	6.5

Power Line Conducted Emission Test:

- Pre-Scan has been conducted to determine the worst-case mode from all possible combinations between available modulations, data rates and antenna ports (if EUT with antenna diversity architecture).
- Following channel(s) was (were) selected for the final test as listed below.

EUT Configure Mode	Frequency Band (MHz)	Mode	Available Channel	Tested Channel	Modulation Technology	Modulation Type	Data Rate (Mbps)
-	5180-5240	802.11n (HT20)	36 to 48	40	OFDM	BPSK	6.5

Antenna Port Conducted Measurement:

- This item includes all test value of each mode, but only includes spectrum plot of worst value of each mode.
- Pre-Scan has been conducted to determine the worst-case mode from all possible combinations between available modulations, data rates and antenna ports (if EUT with antenna diversity architecture).
- Following channel(s) was (were) selected for the final test as listed below.

EUT Configure Mode	Frequency Band (MHz)	Mode	Available Channel	Tested Channel	Modulation Technology	Modulation Type	Data Rate (Mbps)
-	5180-5240	802.11a	36 to 48	36, 40, 48	OFDM	BPSK	6.0
-		802.11n (HT20)	36 to 48	36, 40, 48	OFDM	BPSK	6.5
-		802.11n (HT40)	38 to 46	38, 46	OFDM	BPSK	13.5
-		802.11ac (VHT80)	42	42	OFDM	BPSK	29.3
-	5260-5320	802.11a	52 to 64	52, 60, 64	OFDM	BPSK	6.0
-		802.11n (HT20)	52 to 64	52, 60, 64	OFDM	BPSK	6.5
-		802.11n (HT40)	54 to 62	54, 62	OFDM	BPSK	13.5
-		802.11ac (VHT80)	58	58	OFDM	BPSK	29.3
-	5500-5720	802.11a	100 to 144	100, 116, 140, 144	OFDM	BPSK	6.0
-		802.11n (HT20)	100 to 144	100, 116, 140, 144	OFDM	BPSK	6.5
-		802.11n (HT40)	102 to 142	102, 110, 134, 142	OFDM	BPSK	13.5
-		802.11ac (VHT80)	106 to 138	106, 122, 138	OFDM	BPSK	29.3
-	5745-5825	802.11a	149 to 165	149, 157, 165	OFDM	BPSK	6.0
-		802.11n (HT20)	149 to 165	149, 157, 165	OFDM	BPSK	6.5
-		802.11n (HT40)	151 to 159	151, 159	OFDM	BPSK	13.5
-		802.11ac (VHT80)	155	155	OFDM	BPSK	29.3

Test Condition:

Applicable To	Environmental Conditions	Input Power	Tested by
RE \geq 1G	25 deg. C, 65 % RH	120 Vac, 60 Hz	Tim Chen
RE $<$ 1G	25 deg. C, 65 % RH	120 Vac, 60 Hz	Thomas Wei
PLC	25 deg. C, 65 % RH	120 Vac, 60 Hz	Jisyong Wang
APCM	25 deg. C, 65 % RH	3.8 Vdc	Vincent Huang

3.3 Duty Cycle of Test Signal

MODULATION TYPE: BPSK

802.11a: Duty cycle = $1.424/1.529 = 0.931$, Duty factor = $10 * \log(1/0.931) = 0.31$

802.11n (HT20): Duty cycle = $1.334/1.447 = 0.922$, Duty factor = $10 * \log(1/0.922) = 0.35$

802.11n (HT40): Duty cycle = $0.664/0.777 = 0.855$, Duty factor = $10 * \log(1/0.855) = 0.68$

802.11ac (VHT80): Duty cycle = $0.327/0.435 = 0.752$, Duty factor = $10 * \log(1/0.752) = 1.24$

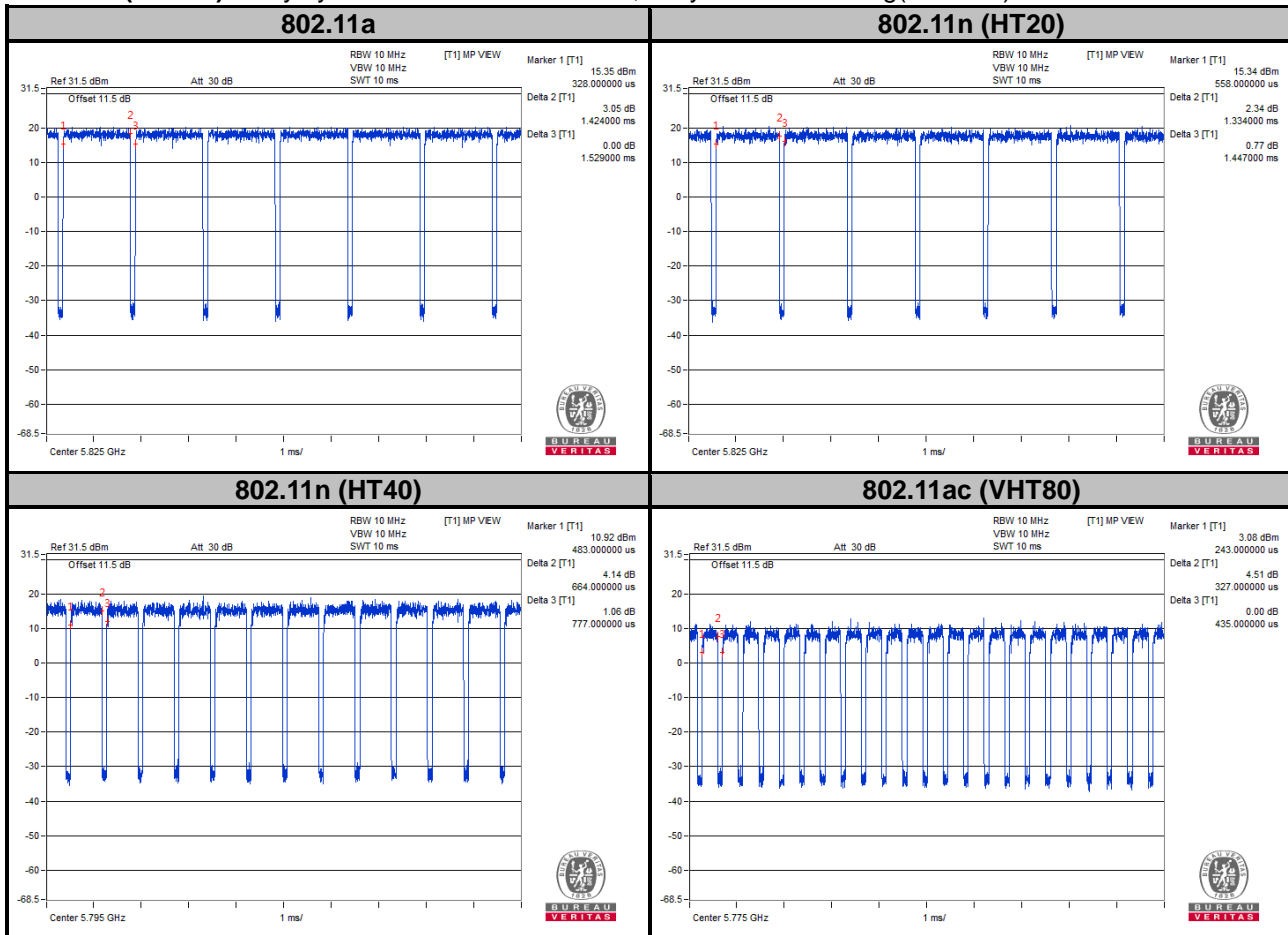

3.4 Description of Support Units

The EUT has been tested as an independent unit.

3.4.1 Configuration of System under Test

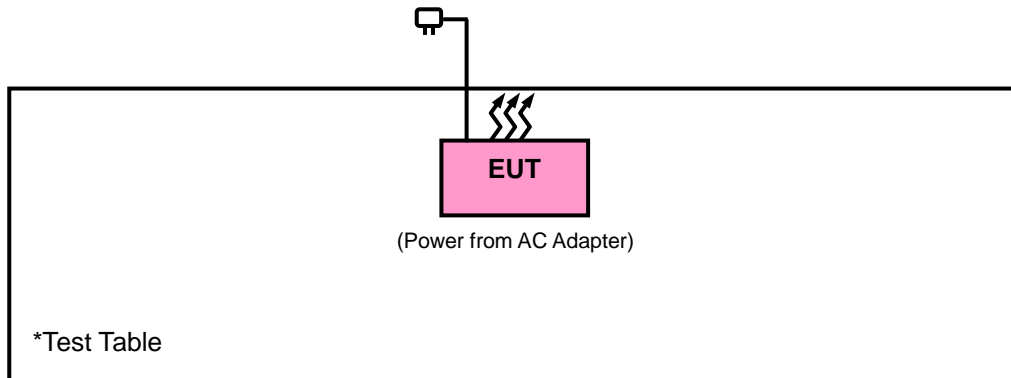

3.5 General Description of Applied Standards

The EUT is a RF Product. According to the specifications of the manufacturer, it must comply with the requirements of the following standards:

FCC Part 15, Subpart E (15.407)

KDB 789033 D02 General UNII Test Procedures New Rules v02r01

ANSI C63.10-2013

All test items have been performed and recorded as per the above standards.

4 Test Types and Results

4.1 Radiated Emission and Bandedge Measurement

4.1.1 Limits of Radiated Emission and Bandedge Measurement

Radiated emissions which fall in the restricted bands must comply with the radiated emission limits specified as below table.

Frequencies (MHz)	Field Strength (microvolts/meter)	Measurement Distance (meters)
0.009 ~ 0.490	2400/F (kHz)	300
0.490 ~ 1.705	24000/F (kHz)	30
1.705 ~ 30.0	30	30
30 ~ 88	100	3
88 ~ 216	150	3
216 ~ 960	200	3
Above 960	500	3

Note:

1. The lower limit shall apply at the transition frequencies.
2. Emission level (dBuV/m) = 20 log Emission level (uV/m).
3. For frequencies above 1000 MHz, the field strength limits are based on average detector, however, the peak field strength of any emission shall not exceed the maximum permitted average limits, specified above by more than 20 dB under any condition of modulation.

4.1.2 Limits of Unwanted Emission Out of the Restricted Bands

Applicable To		Limit	
789033 D02 General UNII Test Procedures New Rules v02r01		Field Strength at 3 m	
		PK: 74 (dBµV/m)	AV: 54 (dBµV/m)
Frequency Band	Applicable To	EIRP Limit	Equivalent Field Strength at 3 m
5150~5250 MHz	15.407(b)(1)	PK: -27 (dBm/MHz)	PK: 68.2 (dBµV/m)
5250~5350 MHz	15.407(b)(2)		
5470~5725 MHz	15.407(b)(3)		
5725~5850 MHz	15.407(b)(4)(i)	PK:-27 (dBm/MHz) ^{*1} PK:10 (dBm/MHz) ^{*2} PK:15.6 (dBm/MHz) ^{*3} PK:27 (dBm/MHz) ^{*4}	PK: 68.2 (dBµV/m) ^{*1} PK:105.2 (dBµV/m) ^{*2} PK: 110.8 (dBµV/m) ^{*3} PK:122.2 (dBµV/m) ^{*4}
	15.407(b)(4)(ii)	Emission limits in section 15.247(d)	
^{*1} beyond 75 MHz or more above of the band edge. ^{*2} below the band edge increasing linearly to 10 dBm/MHz at 25 MHz above. ^{*3} below the band edge increasing linearly to a level of 15.6 dBm/MHz at 5 MHz above. ^{*4} from 5 MHz above or below the band edge increasing linearly to a level of 27 dBm/MHz at the band edge.			

Note:

The following formula is used to convert the equipment isotropic radiated power (eirp) to field strength:

$$E = \frac{1000000\sqrt{30P}}{3} \mu\text{V/m, where P is the eirp (Watts).$$

4.1.3 Test Instruments

Description & Manufacturer	Model No.	Serial No.	Date of Calibration	Due Date of Calibration
Test Receiver Agilent	N9038A	MY51210203	Mar. 18, 2019	Mar. 17, 2020
Spectrum Analyzer Agilent	N9010A	MY52220314	Dec. 13, 2018	Dec. 12, 2019
Spectrum Analyzer ROHDE & SCHWARZ	FSU43	100115	Jan. 21, 2019	Jan. 20, 2020
BILOG Antenna SCHWARZBECK	VULB 9168	9168-472	Nov. 23, 2018	Nov. 22, 2019
Horn Antenna SCHWARZBECK	BBHA 9120D	9120D-969	Nov. 25, 2018	Nov. 24, 2019
HORN Antenna SCHWARZBECK	BBHA 9170	9170-480	Nov. 25, 2018	Nov. 24, 2019
Loop Antenna	HLA 6121	45745	Jun. 14, 2018	May 18, 2019
Preamplifier EMCI	EMC 012645	980115	Oct. 12, 2018	Oct. 11, 2019
Preamplifier EMCI	EMC 184045	980116	Oct. 12, 2018	Oct. 11, 2019
Preamplifier EMCI	EMC 330H	980112	Oct. 12, 2018	Oct. 11, 2019
Preamplifier EMCI	EMC001340	980201	Oct. 12, 2018	Oct. 11, 2019
RF Coaxial Cable HUBER+SUHNNER	EMC104-SM-SM-8 000&3000	140811+170717	Oct. 12, 2018	Oct. 11, 2019
Power Meter Anritsu	ML2495A	1012010	Sep. 05, 2018	Sep. 04, 2019
Power Sensor Anritsu	MA2411B	1315050	Sep. 04, 2018	Sep. 03, 2019
RF Coaxial Cable HUBER+SUHNNER	SUCOFLEX 104	EMC104-SM-SM- 1000(140807)	Oct. 12, 2018	Oct. 11, 2019
RF Coaxial Cable WOKEN	8D-FB	Cable-Ch10-01	Oct. 12, 2018	Oct. 11, 2019
Software BV ADT	E3 6.120103	NA	NA	NA
Antenna Tower MF	MFA-440H	NA	NA	NA
Turn Table MF	MFT-201SS	NA	NA	NA
Antenna Tower & Turn Table Controller MF	MF-7802	NA	NA	NA

- Note: 1. The calibration interval of the above test instruments is 12 months and the calibrations are traceable to NML/ROC and NIST/USA.
2. The test was performed in HwaYa Chamber 10.
3. The horn antenna and preamplifier (model: EMC 184045) are used only for the measurement of emission frequency above 1 GHz if tested.
4. The IC Site Registration No. is 7450F-10.

4.1.4 Test Procedures

For Radiated Emission below 30 MHz

- a. The EUT was placed on the top of a rotating table 0.8 meters above the ground at a 3 meter chamber room. The table was rotated 360 degrees to determine the position of the highest radiation.
- b. The EUT was set 3 meters away from the interference-receiving antenna, which was mounted on the top of a variable-height antenna tower.
- c. Both Parallel, perpendicular, and ground-parallel orientations of the antenna are set to make the measurement.
- d. For each suspected emission, the EUT was arranged to its worst case and the rotatable table was turned from 0 degrees to 360 degrees to find the maximum reading.
- e. The test-receiver system was set to Quasi-Peak Detect Function and Specified Bandwidth with Maximum Hold Mode.

Note:

1. The resolution bandwidth and video bandwidth of test receiver/spectrum analyzer is 9 kHz at frequency below 30 MHz.

For Radiated Emission above 30 MHz

- a. The EUT was placed on the top of a rotating table 0.8 meters (for 30 MHz ~ 1 GHz) / 1.5 meters (for above 1 GHz) above the ground at 3 meter chamber room for test. The table was rotated 360 degrees to determine the position of the highest radiation.
- b. The EUT was set 3 meters away from the interference-receiving antenna, which was mounted on the top of a variable-height antenna tower.
- c. The height of antenna is varied from one meter to four meters above the ground to determine the maximum value of the field strength. Both horizontal and vertical polarizations of the antenna are set to make the measurement.
- d. For each suspected emission, the EUT was arranged to its worst case and then the antenna was tuned to heights from 1 meter to 4 meters and the rotatable table was turned from 0 degrees to 360 degrees to find the maximum reading.
- e. The test-receiver system was set to quasi-peak detect function and specified bandwidth with maximum hold mode when the test frequency is below 1 GHz.
- f. The test-receiver system was set to peak and average detected function and specified bandwidth with maximum hold mode when the test frequency is above 1 GHz. If the peak reading value also meets average limit, measurement with the average detector is unnecessary.

Note:

1. The resolution bandwidth and video bandwidth of test receiver/spectrum analyzer is 120 kHz for Quasi-peak detection (QP) or Peak detection (PK) at frequency below 1 GHz.
2. The resolution bandwidth of test receiver/spectrum analyzer is 1 MHz and the video bandwidth is 3 MHz for Peak detection (PK) at frequency above 1 GHz.
3. The resolution bandwidth of test receiver/spectrum analyzer is 1 MHz and the video bandwidth is $\geq 1/T$ (Duty cycle < 98 %) or 10 Hz (Duty cycle ≥ 98 %) for Average detection (AV) at frequency above 1 GHz.
(11a: RBW = 1 MHz, VBW = 1 kHz ; 11n (HT20): RBW = 1 MHz, VBW = 1 kHz ;
11n (HT40): RBW = 1 MHz, VBW = 3 kHz ; 11ac (VHT80): RBW = 1 MHz, VBW = 10 kHz)
4. All modes of operation were investigated and the worst-case emissions are reported.

4.1.5 Deviation from Test Standard

No deviation.

4.1.6 Test Setup

<Radiated Emission below 30 MHz>

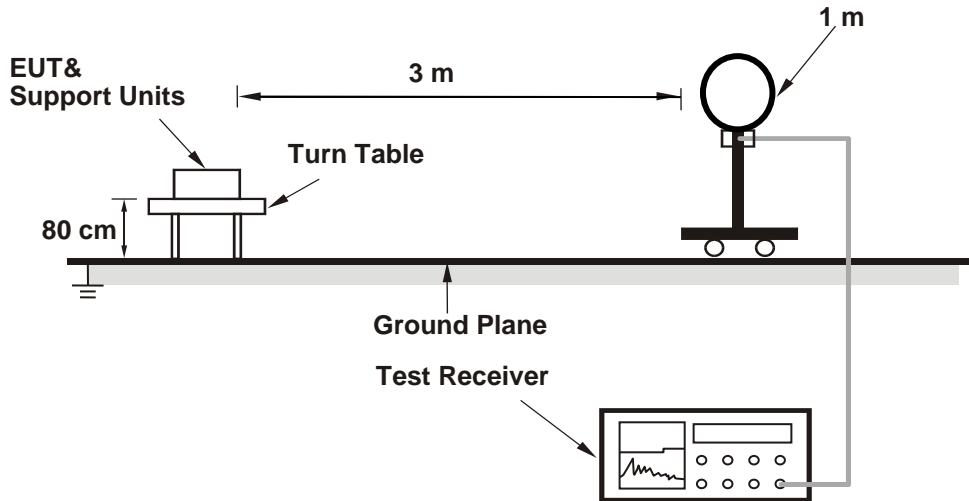

<Radiated Emission 30 MHz to 1 GHz>

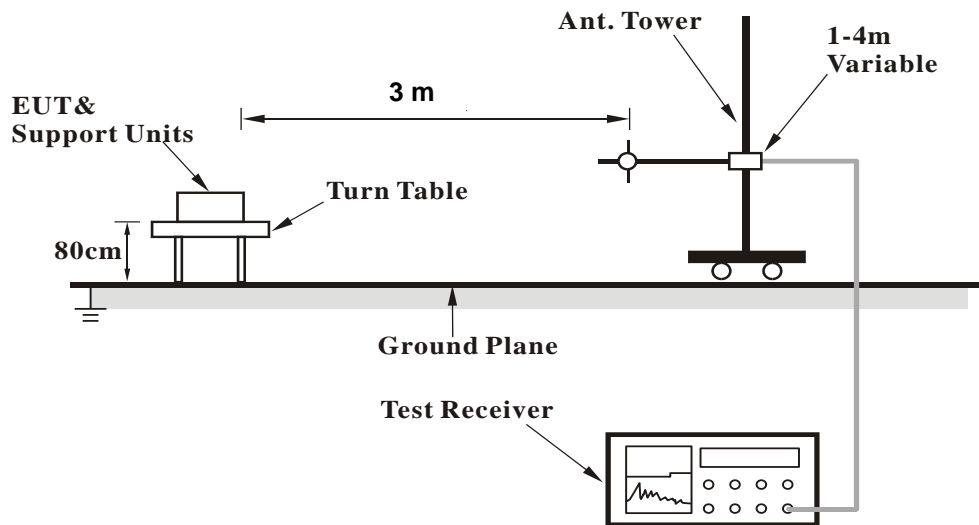

<Radiated Emission above 1 GHz>

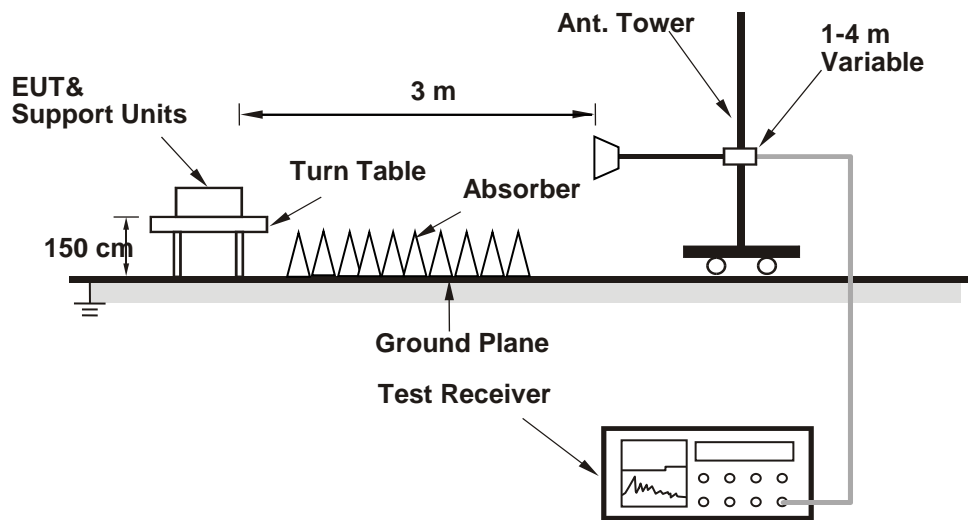

For the actual test configuration, please refer to the attached file (Test Setup Photo).

4.1.7 EUT Operating Conditions

- a. Placed the EUT on a testing table.
- b. Use the software to control the EUT under transmission condition continuously at specific channel frequency.

4.1.8 Test Results
 Above 1 GHz Data :
 802.11a

EUT Test Condition		Measurement Detail	
Channel	Channel 36	Frequency Range	1 GHz ~ 40 GHz
Input Power	120 Vac, 60 Hz	Detector Function	Peak (PK) Average (AV)
Environmental Conditions	25 deg. C, 65 % RH	Tested By	Tim Chen

Horizontal

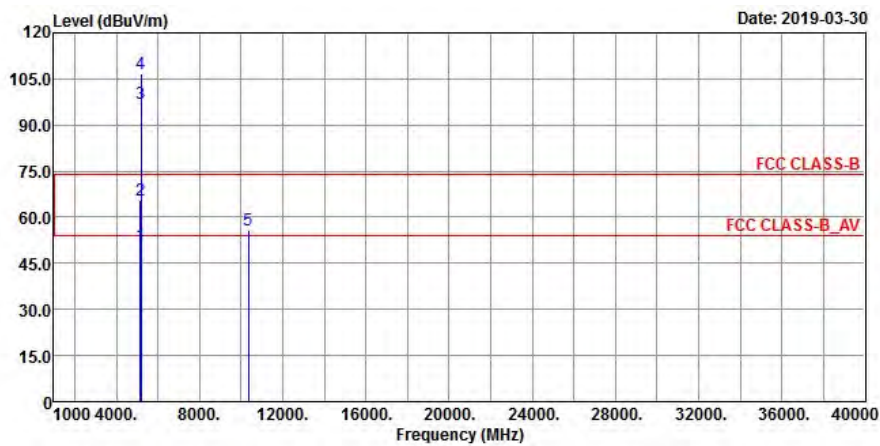

Vertical

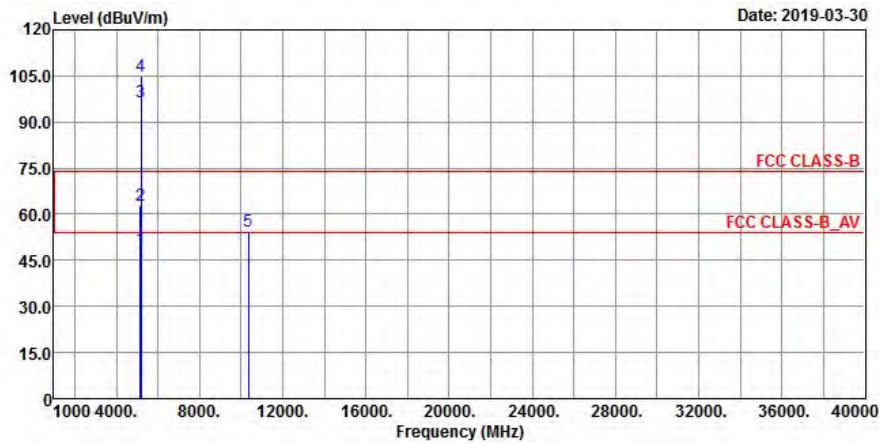

Antenna Polarity & Test Distance: Horizontal at 3 m

Frequency (MHz)	Emission Level (dBuV/m)	Read Level (dBuV)	Factor (dB/m)	Limit (dBuV/m)	Margin (dB)	Antenna Height (cm)	Table Angle (Degree)	Remark
5149.94	50.91	49.38	1.53	54	-3.09	173	342	Average
5149.94	65.67	64.14	1.53	74	-8.33	173	342	Peak
5180	96.99	95.46	1.53			173	342	Average
5180	106.61	105.08	1.53			173	342	Peak
*10360	55.94	58.78	-2.84	68.2	-12.26	167	224	Peak

Antenna Polarity & Test Distance: Vertical at 3 m

Frequency (MHz)	Emission Level (dBuV/m)	Read Level (dBuV)	Factor (dB/m)	Limit (dBuV/m)	Margin (dB)	Antenna Height (cm)	Table Angle (Degree)	Remark
5149.22	48.75	47.22	1.53	54	-5.25	211	104	Average
5149.22	63.09	61.56	1.53	74	-10.91	211	104	Peak
5180	96.51	94.98	1.53			211	104	Average
5180	105.16	103.63	1.53			211	104	Peak
*10360	54.66	57.5	-2.84	68.2	-13.54	131	147	Peak

Remarks:

- Emission Level = Read Level + Factor
Margin value = Emission level – Limit value
- 5180 MHz: Fundamental Frequency
- *: Out of Restricted Band
- The emission levels of other frequencies were very low against the limit

EUT Test Condition		Measurement Detail	
Channel	Channel 40	Frequency Range	1 GHz ~ 40 GHz
Input Power	120 Vac, 60 Hz	Detector Function	Peak (PK) Average (AV)
Environmental Conditions	25 deg. C, 65 % RH	Tested By	Tim Chen

Horizontal

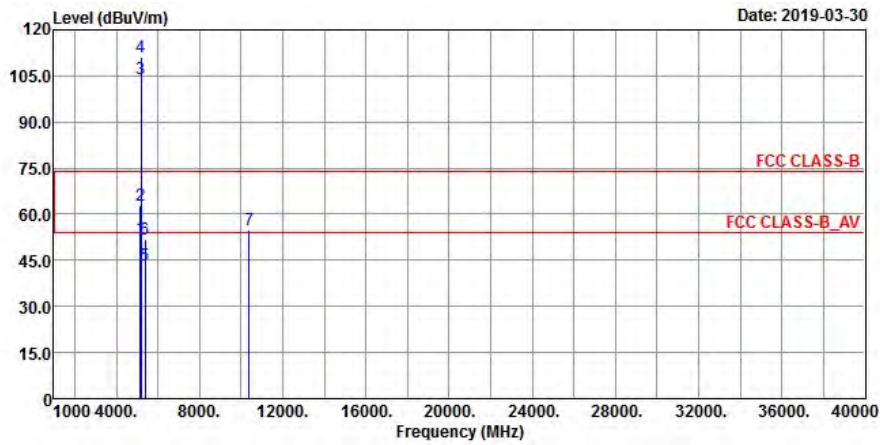

Vertical

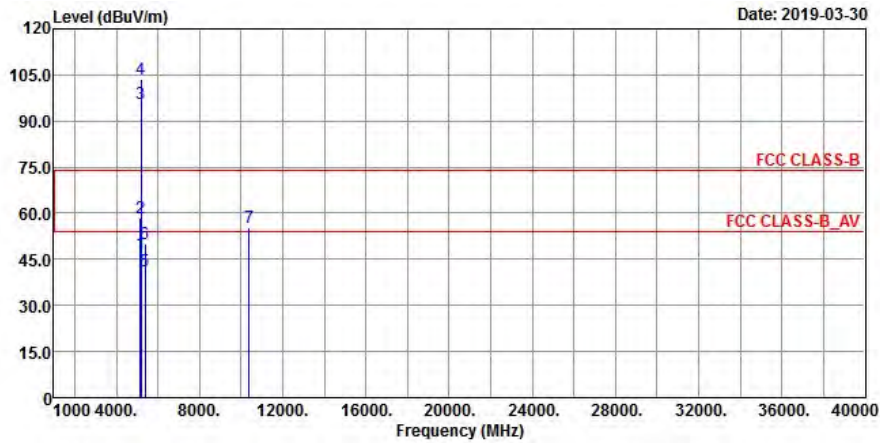

Antenna Polarity & Test Distance: Horizontal at 3 m

Frequency (MHz)	Emission Level (dBuV/m)	Read Level (dBuV)	Factor (dB/m)	Limit (dBuV/m)	Margin (dB)	Antenna Height (cm)	Table Angle (Degree)	Remark
5149.22	52.12	50.59	1.53	54	-1.88	191	342	Average
5149.22	62.72	61.19	1.53	74	-11.28	191	342	Peak
5200	104.06	102.53	1.53			191	342	Average
5200	111.25	109.72	1.53			191	342	Peak
5400.05	43.43	41.76	1.67	54	-10.57	191	342	Average
5400.05	51.93	50.26	1.67	74	-22.07	191	342	Peak
*10400	54.9	57.79	-2.89	68.2	-13.3	118	236	Peak

Antenna Polarity & Test Distance: Vertical at 3 m

Frequency (MHz)	Emission Level (dBuV/m)	Read Level (dBuV)	Factor (dB/m)	Limit (dBuV/m)	Margin (dB)	Antenna Height (cm)	Table Angle (Degree)	Remark
5149.94	46.98	45.45	1.53	54	-7.02	124	324	Average
5149.94	58.66	57.13	1.53	74	-15.34	124	324	Peak
5200	95.64	94.11	1.53			124	324	Average
5200	103.55	102.02	1.53			124	324	Peak
5399.94	41.02	39.35	1.67	54	-12.98	124	324	Average
5399.94	50.1	48.43	1.67	74	-23.9	124	324	Peak
*10400	55.52	58.41	-2.89	68.2	-12.68	165	307	Peak

Remarks:

- Emission Level = Read Level + Factor
Margin value = Emission level – Limit value
- 5200 MHz: Fundamental Frequency
- *: Out of Restricted Band
- The emission levels of other frequencies were very low against the limit

EUT Test Condition		Measurement Detail	
Channel	Channel 48	Frequency Range	1 GHz ~ 40 GHz
Input Power	120 Vac, 60 Hz	Detector Function	Peak (PK) Average (AV)
Environmental Conditions	25 deg. C, 65 % RH	Tested By	Tim Chen

Horizontal

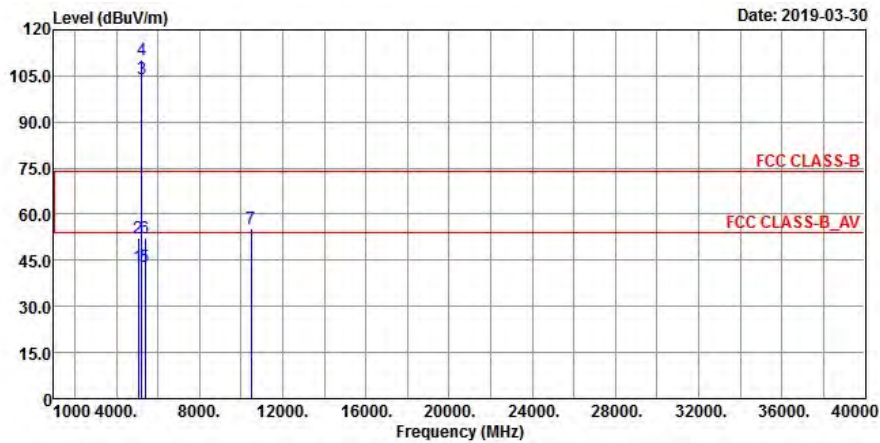

Vertical

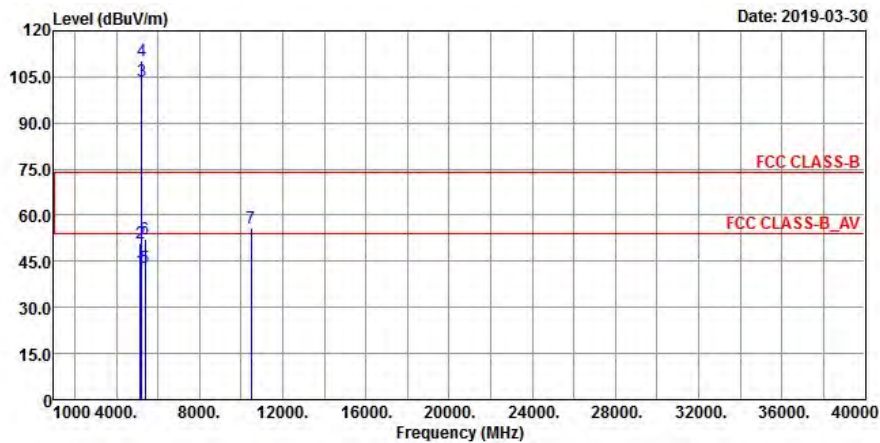

Antenna Polarity & Test Distance: Horizontal at 3 m

Frequency (MHz)	Emission Level (dBuV/m)	Read Level (dBuV)	Factor (dB/m)	Limit (dBuV/m)	Margin (dB)	Antenna Height (cm)	Table Angle (Degree)	Remark
5052.92	42.95	41.41	1.54	54	-11.05	198	344	Average
5052.92	52.22	50.68	1.54	74	-21.78	198	344	Peak
5240	104.21	102.83	1.38			198	344	Average
5240	110.14	108.76	1.38			198	344	Peak
5390.7	43.09	41.49	1.6	54	-10.91	198	344	Average
5390.7	52.43	50.83	1.6	74	-21.57	198	344	Peak
*10480	55.45	58.18	-2.73	68.2	-12.75	136	227	Peak

Antenna Polarity & Test Distance: Vertical at 3 m

Frequency (MHz)	Emission Level (dBuV/m)	Read Level (dBuV)	Factor (dB/m)	Limit (dBuV/m)	Margin (dB)	Antenna Height (cm)	Table Angle (Degree)	Remark
5149.22	41.94	40.41	1.53	54	-12.06	196	99	Average
5149.22	50.95	49.42	1.53	74	-23.05	196	99	Peak
5240	103.71	102.33	1.38			196	99	Average
5240	110.11	108.73	1.38			196	99	Peak
5390.59	42.94	41.34	1.6	54	-11.06	196	99	Average
5390.59	52.37	50.77	1.6	74	-21.63	196	99	Peak
*10480	55.88	58.61	-2.73	68.2	-12.32	145	106	Peak

Remarks:

- Emission Level = Read Level + Factor
Margin value = Emission level – Limit value
- 5240 MHz: Fundamental Frequency
- *: Out of Restricted Band
- The emission levels of other frequencies were very low against the limit

EUT Test Condition		Measurement Detail	
Channel	Channel 52	Frequency Range	1 GHz ~ 40 GHz
Input Power	120 Vac, 60 Hz	Detector Function	Peak (PK) Average (AV)
Environmental Conditions	25 deg. C, 65 % RH	Tested By	Tim Chen

Horizontal

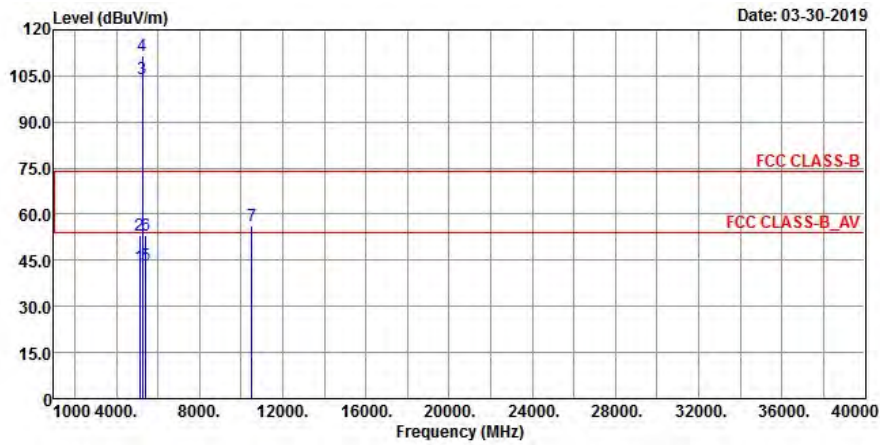

Vertical

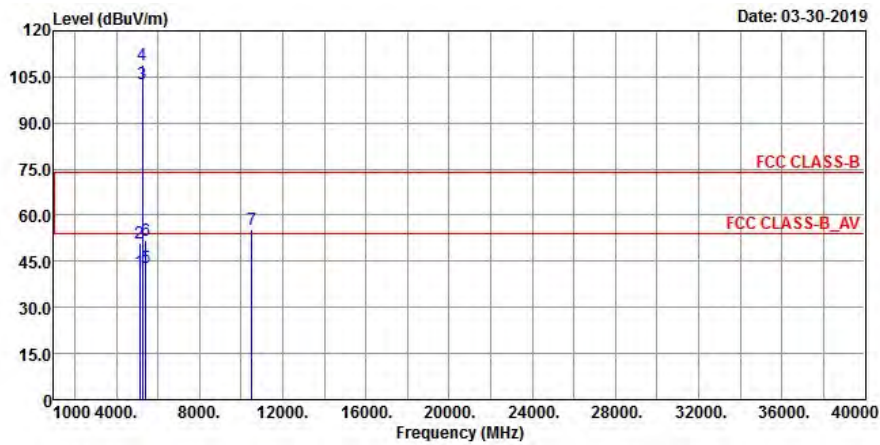

Antenna Polarity & Test Distance: Horizontal at 3 m

Frequency (MHz)	Emission Level (dBuV/m)	Read Level (dBuV)	Factor (dB/m)	Limit (dBuV/m)	Margin (dB)	Antenna Height (cm)	Table Angle (Degree)	Remark
5111.24	43.11	41.64	1.47	54	-10.89	216	343	Average
5111.24	52.92	51.45	1.47	74	-21.08	216	343	Peak
5260	104.18	102.87	1.31			216	343	Average
5260	111.65	110.34	1.31			216	343	Peak
5408.3	43.59	41.92	1.67	54	-10.41	216	343	Average
5408.3	52.99	51.32	1.67	74	-21.01	216	343	Peak
*10520	56.02	58.74	-2.72	68.2	-12.18	146	131	Peak

Antenna Polarity & Test Distance: Vertical at 3 m

Frequency (MHz)	Emission Level (dBuV/m)	Read Level (dBuV)	Factor (dB/m)	Limit (dBuV/m)	Margin (dB)	Antenna Height (cm)	Table Angle (Degree)	Remark
5111.42	41.8	40.33	1.47	54	-12.2	206	112	Average
5111.42	50.75	49.28	1.47	74	-23.25	206	112	Peak
5260	102.59	101.28	1.31			206	112	Average
5260	109.13	107.82	1.31			206	112	Peak
5408.3	42.8	41.13	1.67	54	-11.2	206	112	Average
5408.3	51.98	50.31	1.67	74	-22.02	206	112	Peak
*10520	55.5	58.22	-2.72	68.2	-12.7	142	257	Peak

Remarks:

- Emission Level = Read Level + Factor
Margin value = Emission level – Limit value
- 5260 MHz: Fundamental Frequency
- *: Out of Restricted Band
- The emission levels of other frequencies were very low against the limit

EUT Test Condition		Measurement Detail	
Channel	Channel 60	Frequency Range	1 GHz ~ 40 GHz
Input Power	120 Vac, 60 Hz	Detector Function	Peak (PK) Average (AV)
Environmental Conditions	25 deg. C, 65 % RH	Tested By	Thomas Wei

Horizontal

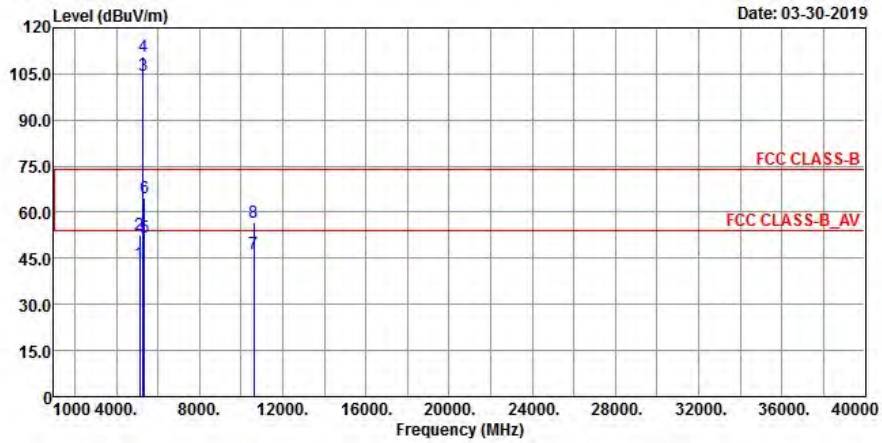

Vertical

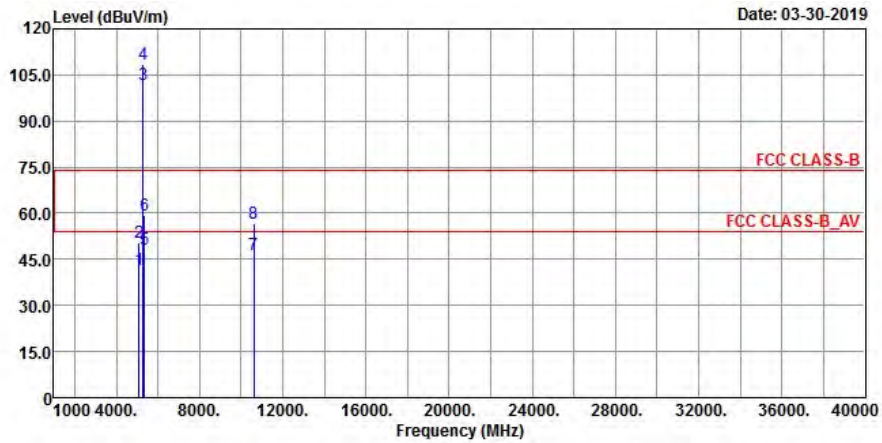

Antenna Polarity & Test Distance: Horizontal at 3 m

Frequency (MHz)	Emission Level (dBuV/m)	Read Level (dBuV)	Factor (dB/m)	Limit (dBuV/m)	Margin (dB)	Antenna Height (cm)	Table Angle (Degree)	Remark
5111.6	43.49	42.02	1.47	54	-10.51	214	342	Average
5111.6	52.65	51.18	1.47	74	-21.35	214	342	Peak
5300	104.35	103.04	1.31			214	342	Average
5300	110.63	109.32	1.31			214	342	Peak
5350.11	51.91	50.45	1.46	54	-2.09	214	342	Average
5350.11	64.64	63.18	1.46	74	-9.36	214	342	Peak
10600	46.38	49.29	-2.91	54	-7.62	143	281	Average
10600	56.82	59.73	-2.91	74	-17.18	143	281	Peak

Antenna Polarity & Test Distance: Vertical at 3 m

Frequency (MHz)	Emission Level (dBuV/m)	Read Level (dBuV)	Factor (dB/m)	Limit (dBuV/m)	Margin (dB)	Antenna Height (cm)	Table Angle (Degree)	Remark
5110.52	41.79	40.32	1.47	54	-12.21	206	114	Average
5110.52	50.6	49.13	1.47	74	-23.4	206	114	Peak
5300	101.82	100.51	1.31			206	114	Average
5300	108.55	107.24	1.31			206	114	Peak
5350	48.33	46.87	1.46	54	-5.67	206	114	Average
5350	59.52	58.06	1.46	74	-14.48	206	114	Peak
10600	46.65	49.56	-2.91	54	-7.35	151	203	Average
10600	56.67	59.58	-2.91	74	-17.33	151	203	Peak

Remarks:

- Emission Level = Read Level + Factor
Margin value = Emission level – Limit value
- 5300 MHz: Fundamental Frequency
- *: Out of Restricted Band
- The emission levels of other frequencies were very low against the limit

EUT Test Condition		Measurement Detail	
Channel	Channel 64	Frequency Range	1 GHz ~ 40 GHz
Input Power	120 Vac, 60 Hz	Detector Function	Peak (PK) Average (AV)
Environmental Conditions	25 deg. C, 65 % RH	Tested By	Thomas Wei

Horizontal

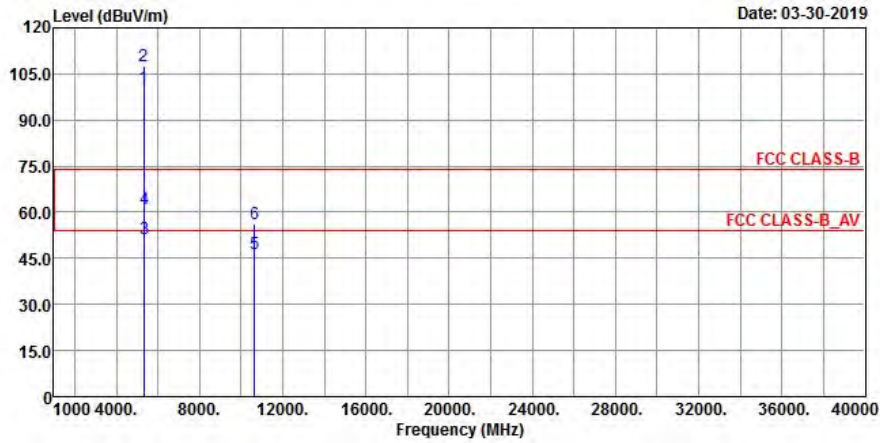

Vertical

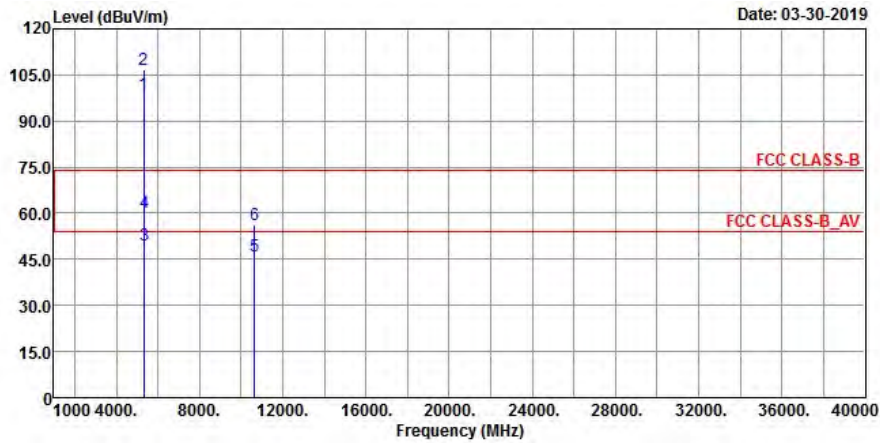

Antenna Polarity & Test Distance: Horizontal at 3 m

Frequency (MHz)	Emission Level (dBuV/m)	Read Level (dBuV)	Factor (dB/m)	Limit (dBuV/m)	Margin (dB)	Antenna Height (cm)	Table Angle (Degree)	Remark
5320	100.65	99.29	1.36			202	346	Average
5320	107.75	106.39	1.36			202	346	Peak
5350	51.26	49.8	1.46	54	-2.74	202	346	Average
5350	61.2	59.74	1.46	74	-12.8	202	346	Peak
10640	46.5	49.39	-2.89	54	-7.5	172	103	Average
10640	56.26	59.15	-2.89	74	-17.74	172	103	Peak

Antenna Polarity & Test Distance: Vertical at 3 m

Frequency (MHz)	Emission Level (dBuV/m)	Read Level (dBuV)	Factor (dB/m)	Limit (dBuV/m)	Margin (dB)	Antenna Height (cm)	Table Angle (Degree)	Remark
5320	98.86	97.5	1.36			204	110	Average
5320	106.58	105.22	1.36			204	110	Peak
5350	49.44	47.98	1.46	54	-4.56	204	110	Average
5350	60.14	58.68	1.46	74	-13.86	204	110	Peak
10640	46.04	48.93	-2.89	54	-7.96	168	215	Average
10640	56.25	59.14	-2.89	74	-17.75	168	215	Peak

Remarks:

- Emission Level = Read Level + Factor
Margin value = Emission level – Limit value
- 5320 MHz: Fundamental Frequency
- *: Out of Restricted Band
- The emission levels of other frequencies were very low against the limit

EUT Test Condition		Measurement Detail	
Channel	Channel 100	Frequency Range	1 GHz ~ 40 GHz
Input Power	120 Vac, 60 Hz	Detector Function	Peak (PK) Average (AV)
Environmental Conditions	25 deg. C, 65 % RH	Tested By	Thomas Wei

Horizontal

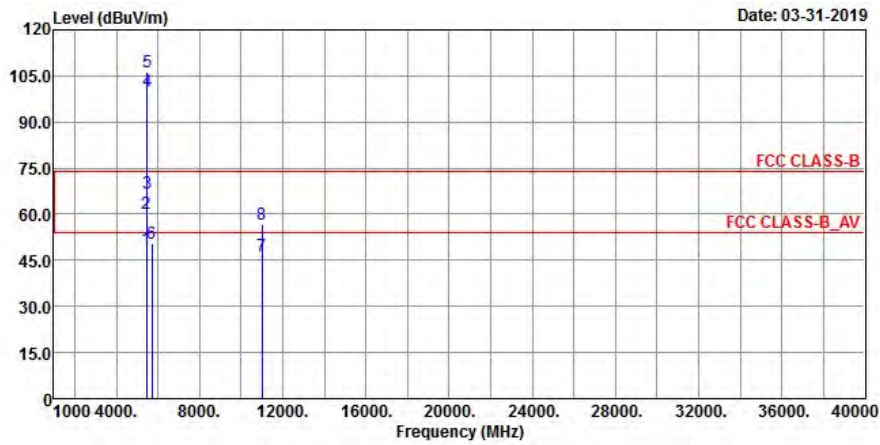

Vertical

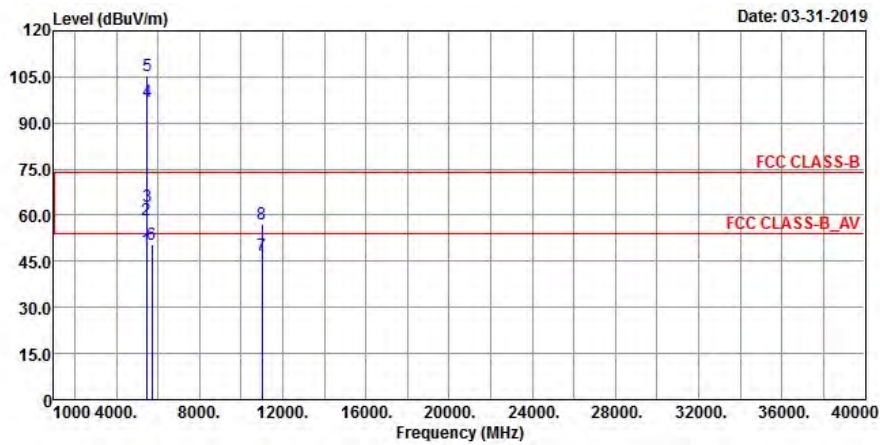

Antenna Polarity & Test Distance: Horizontal at 3 m

Frequency (MHz)	Emission Level (dBuV/m)	Read Level (dBuV)	Factor (dB/m)	Limit (dBuV/m)	Margin (dB)	Antenna Height (cm)	Table Angle (Degree)	Remark
5459.6	48.87	47	1.87	54	-5.13	166	342	Average
5459.6	60.43	58.56	1.87	74	-13.57	166	342	Peak
*5470	66.68	64.82	1.86	68.2	-1.52	166	342	Peak
5500	100.2	98.33	1.87			166	342	Average
5500	106.13	104.26	1.87			166	342	Peak
*5725	50.29	48.53	1.76	68.2	-17.91	166	342	Peak
11000	46.6	48.91	-2.31	54	-7.4	137	154	Average
11000	56.78	59.09	-2.31	74	-17.22	137	154	Peak

Antenna Polarity & Test Distance: Vertical at 3 m

Frequency (MHz)	Emission Level (dBuV/m)	Read Level (dBuV)	Factor (dB/m)	Limit (dBuV/m)	Margin (dB)	Antenna Height (cm)	Table Angle (Degree)	Remark
5460	48.87	47	1.87	54	-5.13	200	100	Average
5460	58.28	56.41	1.87	74	-15.72	200	100	Peak
*5470	62.87	61.01	1.86	68.2	-5.33	200	100	Peak
5500	97.01	95.14	1.87			200	100	Average
5500	105.25	103.38	1.87			200	100	Peak
*5725	50.33	48.57	1.76	68.2	-17.87	200	100	Peak
11000	46.95	49.26	-2.31	54	-7.05	168	231	Average
11000	57.03	59.34	-2.31	74	-16.97	168	231	Peak

Remarks:

- Emission Level = Read Level + Factor
Margin value = Emission level – Limit value
- 5500 MHz: Fundamental Frequency
- *: Out of Restricted Band
- The emission levels of other frequencies were very low against the limit

EUT Test Condition		Measurement Detail	
Channel	Channel 116	Frequency Range	1 GHz ~ 40 GHz
Input Power	120 Vac, 60 Hz	Detector Function	Peak (PK) Average (AV)
Environmental Conditions	25 deg. C, 65 % RH	Tested By	Thomas Wei

Horizontal

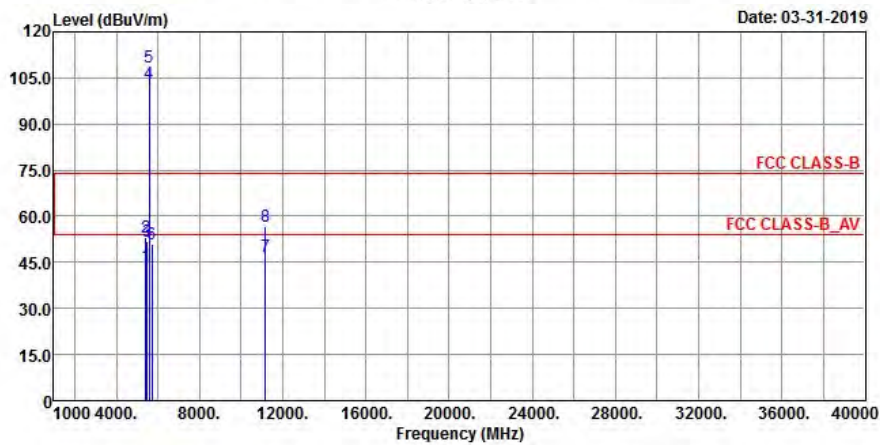
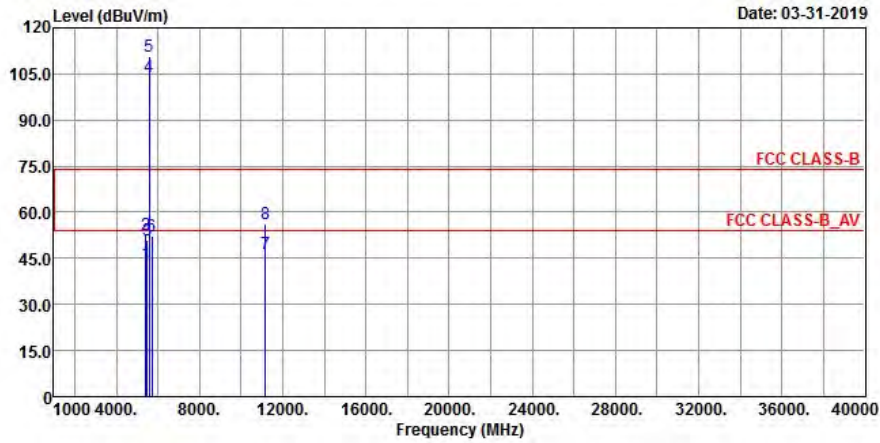

Vertical

Antenna Polarity & Test Distance: Horizontal at 3 m

Frequency (MHz)	Emission Level (dBuV/m)	Read Level (dBuV)	Factor (dB/m)	Limit (dBuV/m)	Margin (dB)	Antenna Height (cm)	Table Angle (Degree)	Remark
5431.6	43.57	41.79	1.78	54	-10.43	187	360	Average
5431.6	52.55	50.77	1.78	74	-21.45	187	360	Peak
*5470	50.98	49.12	1.86	68.2	-17.22	187	360	Peak
5580	104.17	102.35	1.82			187	360	Average
5580	110.8	108.98	1.82			187	360	Peak
*5725	52.16	50.4	1.76	68.2	-16.04	187	360	Peak
11160	46.68	49.23	-2.55	54	-7.32	146	251	Average
11160	56.36	58.91	-2.55	74	-17.64	146	251	Peak

Antenna Polarity & Test Distance: Vertical at 3 m

Frequency (MHz)	Emission Level (dBuV/m)	Read Level (dBuV)	Factor (dB/m)	Limit (dBuV/m)	Margin (dB)	Antenna Height (cm)	Table Angle (Degree)	Remark
5429.52	43.8	42.02	1.78	54	-10.2	192	100	Average
5429.52	53.08	51.3	1.78	74	-20.92	192	100	Peak
*5470	51.71	49.85	1.86	68.2	-16.49	192	100	Peak
5580	103.1	101.28	1.82			192	100	Average
5580	108.29	106.47	1.82			192	100	Peak
*5725	51.02	49.26	1.76	68.2	-17.18	192	100	Peak
11160	46.77	49.32	-2.55	54	-7.23	161	205	Average
11160	56.49	59.04	-2.55	74	-17.51	161	205	Peak

Remarks:

- Emission Level = Read Level + Factor
Margin value = Emission level – Limit value
- 5580 MHz: Fundamental Frequency
- *: Out of Restricted Band
- The emission levels of other frequencies were very low against the limit

EUT Test Condition		Measurement Detail	
Channel	Channel 140	Frequency Range	1 GHz ~ 40 GHz
Input Power	120 Vac, 60 Hz	Detector Function	Peak (PK) Average (AV)
Environmental Conditions	25 deg. C, 65 % RH	Tested By	Thomas Wei

Horizontal

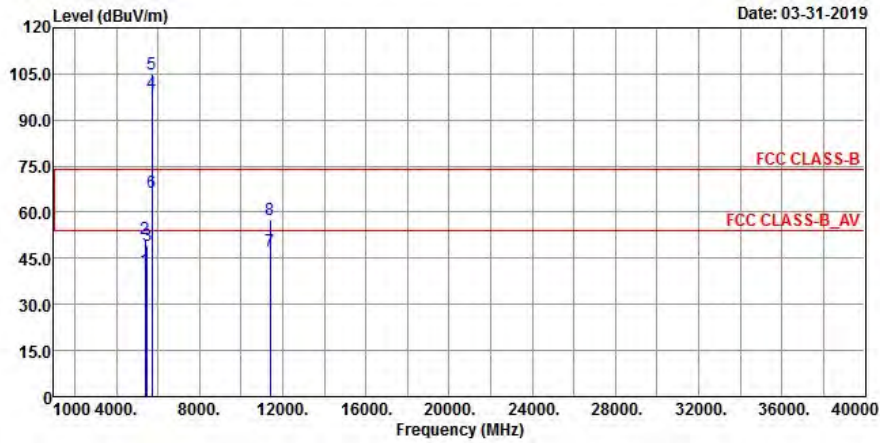

Vertical

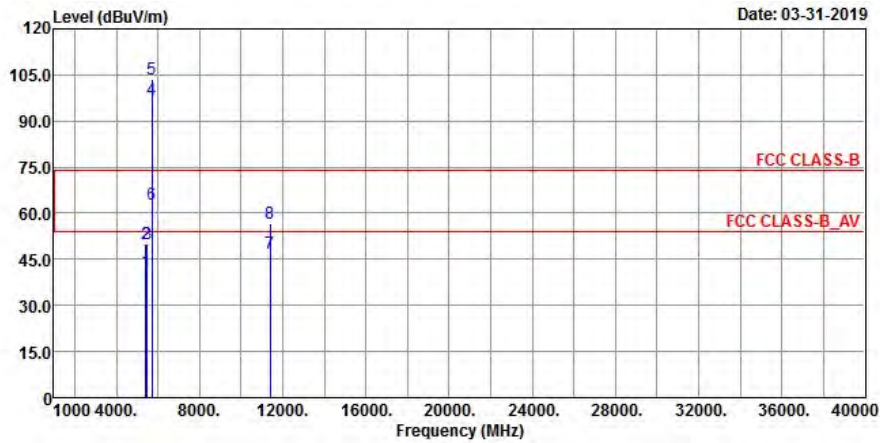

Antenna Polarity & Test Distance: Horizontal at 3 m

Frequency (MHz)	Emission Level (dBuV/m)	Read Level (dBuV)	Factor (dB/m)	Limit (dBuV/m)	Margin (dB)	Antenna Height (cm)	Table Angle (Degree)	Remark
5402.8	41.09	39.42	1.67	54	-12.91	170	4	Average
5402.8	51.48	49.81	1.67	74	-22.52	170	4	Peak
*5470	49.13	47.27	1.86	68.2	-19.07	170	4	Peak
5700	98.66	97.07	1.59			170	4	Average
5700	104.74	103.15	1.59			170	4	Peak
*5725	66.42	64.66	1.76	68.2	-1.78	170	4	Peak
11400	47.31	49.54	-2.23	54	-6.69	182	259	Average
11400	57.36	59.59	-2.23	74	-16.64	182	259	Peak

Antenna Polarity & Test Distance: Vertical at 3 m

Frequency (MHz)	Emission Level (dBuV/m)	Read Level (dBuV)	Factor (dB/m)	Limit (dBuV/m)	Margin (dB)	Antenna Height (cm)	Table Angle (Degree)	Remark
5425.2	41	39.24	1.76	54	-13	196	103	Average
5425.2	50.25	48.49	1.76	74	-23.75	196	103	Peak
*5470	49.96	48.1	1.86	68.2	-18.24	196	103	Peak
5700	96.82	95.23	1.59			196	103	Average
5700	103.62	102.03	1.59			196	103	Peak
*5725	62.98	61.22	1.76	68.2	-5.22	196	103	Peak
11400	46.97	49.2	-2.23	54	-7.03	171	203	Average
11400	56.73	58.96	-2.23	74	-17.27	171	203	Peak

Remarks:

- Emission Level = Read Level + Factor
Margin value = Emission level – Limit value
- 5700 MHz: Fundamental Frequency
- *: Out of Restricted Band
- The emission levels of other frequencies were very low against the limit

EUT Test Condition		Measurement Detail	
Channel	Channel 144	Frequency Range	1 GHz ~ 40 GHz
Input Power	120 Vac, 60 Hz	Detector Function	Peak (PK) Average (AV)
Environmental Conditions	25 deg. C, 65 % RH	Tested By	Thomas Wei

Horizontal

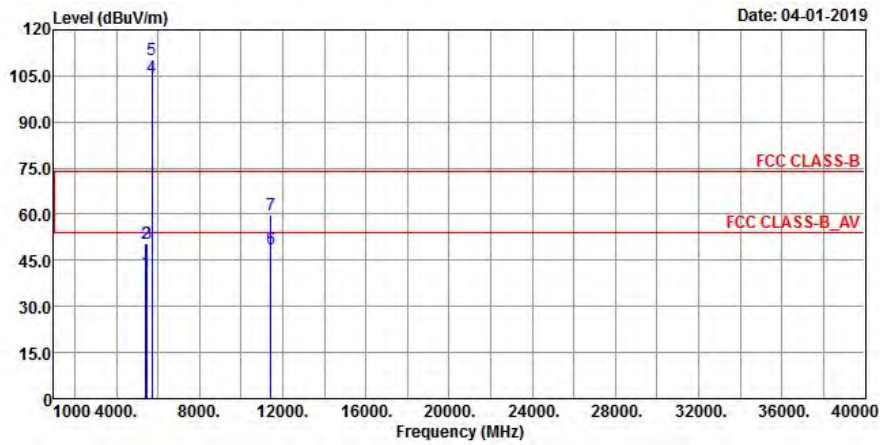

Vertical

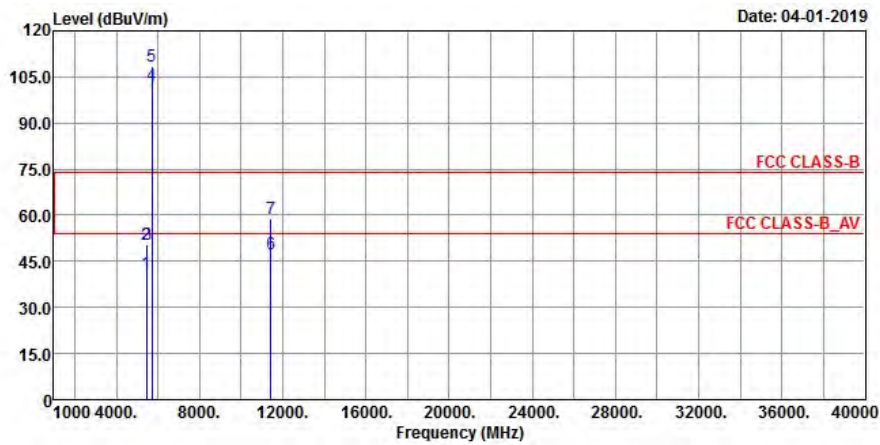

Antenna Polarity & Test Distance: Horizontal at 3 m

Frequency (MHz)	Emission Level (dBuV/m)	Read Level (dBuV)	Factor (dB/m)	Limit (dBuV/m)	Margin (dB)	Antenna Height (cm)	Table Angle (Degree)	Remark
5428.08	41	39.24	1.76	54	-13	171	5	Average
5428.08	50.38	48.62	1.76	74	-23.62	171	5	Peak
*5470	50.26	48.4	1.86	68.2	-17.94	171	5	Peak
5720	104.6	65.41	39.19			171	5	Average
5720	110.35	71.16	39.19			171	5	Peak
11440	48.78	51	-2.22	54	-5.22	120	269	Average
11440	59.81	62.03	-2.22	74	-14.19	120	269	Peak

Antenna Polarity & Test Distance: Vertical at 3 m

Frequency (MHz)	Emission Level (dBuV/m)	Read Level (dBuV)	Factor (dB/m)	Limit (dBuV/m)	Margin (dB)	Antenna Height (cm)	Table Angle (Degree)	Remark
5455.44	40.97	39.1	1.87	54	-13.03	195	101	Average
5455.44	50.38	48.51	1.87	74	-23.62	195	101	Peak
*5470	50.5	48.64	1.86	68.2	-17.7	195	101	Peak
5720	102.19	100.43	1.76			195	101	Average
5720	108.3	106.54	1.76			195	101	Peak
11440	47.48	49.7	-2.22	54	-6.52	221	330	Average
11440	58.82	61.04	-2.22	74	-15.18	221	330	Peak

Remarks:

- Emission Level = Read Level + Factor
Margin value = Emission level – Limit value
- 5720 MHz: Fundamental Frequency
- *: Out of Restricted Band
- The emission levels of other frequencies were very low against the limit

EUT Test Condition		Measurement Detail	
Channel	Channel 149	Frequency Range	1 GHz ~ 40 GHz
Input Power	120 Vac, 60 Hz	Detector Function	Peak (PK) Average (AV)
Environmental Conditions	25 deg. C, 65 % RH	Tested By	Thomas Wei

**<Spurious Emission>
Horizontal**

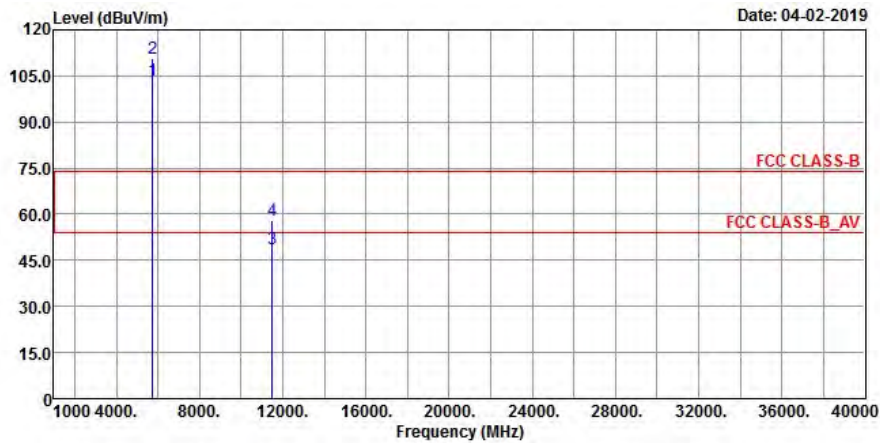

Vertical

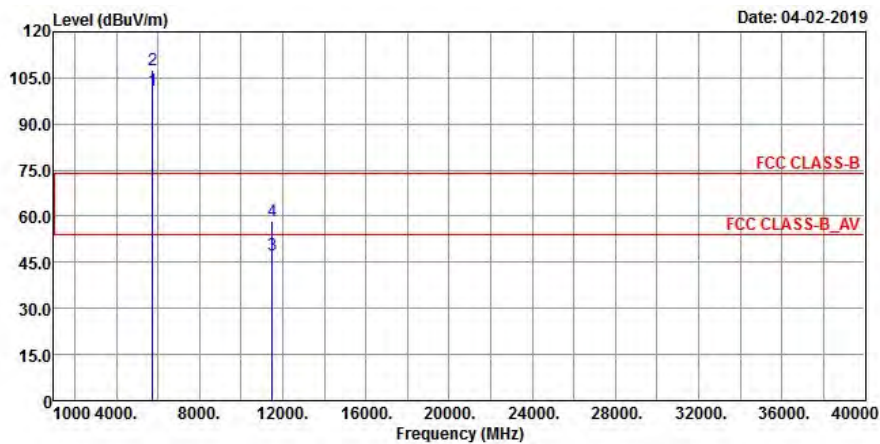

**<Out of Band Emission (OOBE)>
Horizontal**

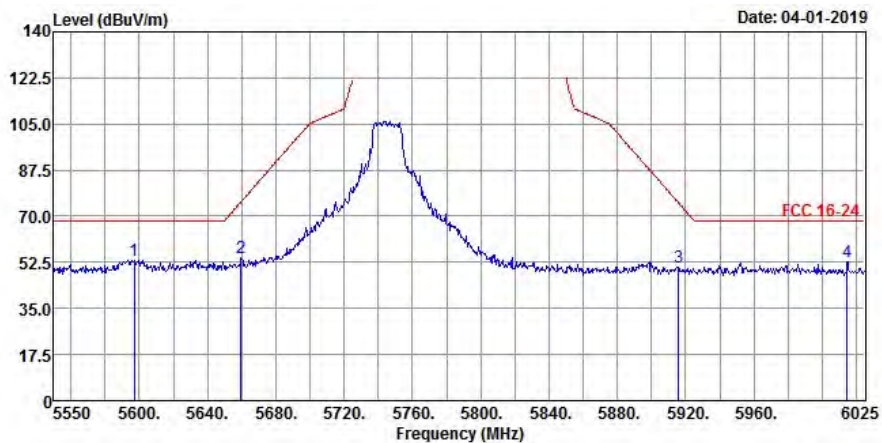

Vertical

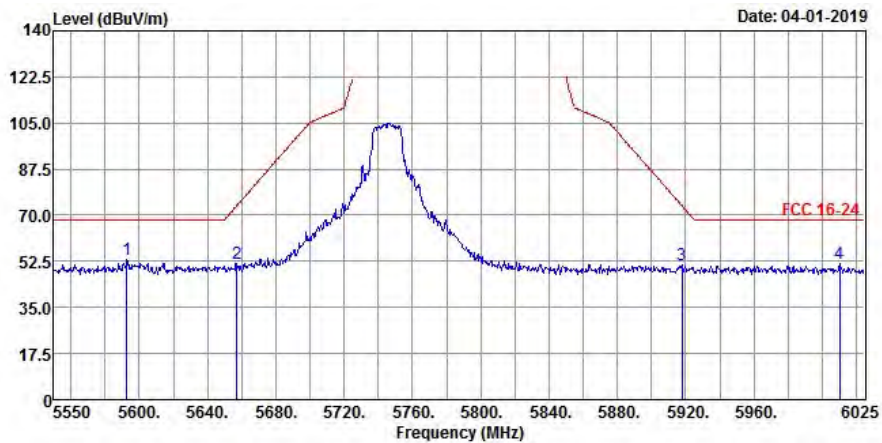

<Spurious Emission>

Antenna Polarity & Test Distance: Horizontal at 3 m								
Frequency (MHz)	Emission Level (dBuV/m)	Read Level (dBuV)	Factor (dB/m)	Limit (dBuV/m)	Margin (dB)	Antenna Height (cm)	Table Angle (Degree)	Remark
5745	103.8	101.98	1.82			201	5	Average
5745	110.77	108.95	1.82			201	5	Peak
11490	48.8	51	-2.2	54	-5.2	120	269	Average
11490	58.08	60.28	-2.2	74	-15.92	120	269	Peak
Antenna Polarity & Test Distance: Vertical at 3 m								
Frequency (MHz)	Emission Level (dBuV/m)	Read Level (dBuV)	Factor (dB/m)	Limit (dBuV/m)	Margin (dB)	Antenna Height (cm)	Table Angle (Degree)	Remark
5745	100.91	99.09	1.82			190	102	Average
5745	107.55	105.73	1.82			190	102	Peak
11490	47.58	49.78	-2.2	54	-6.42	121	328	Average
11490	58.6	60.8	-2.2	74	-15.4	121	328	Peak

<Out of Band Emission (OOBE)>

Antenna Polarity & Test Distance: Horizontal at 3 m								
Frequency (MHz)	Emission Level (dBuV/m)	Read Level (dBuV)	Factor (dB/m)	Limit (dBuV/m)	Margin (dB)	Antenna Height (cm)	Table Angle (Degree)	Remark
5597.025	53.21	51.34	1.87	68.2	-14.99	201	5	Peak
5659.725	54.17	52.32	1.85	75.42	-21.25	201	5	Peak
5915.75	50.81	48.5	2.31	75.02	-24.21	201	5	Peak
6014.55	52.59	50.19	2.4	68.2	-15.61	201	5	Peak
Antenna Polarity & Test Distance: Vertical at 3 m								
Frequency (MHz)	Emission Level (dBuV/m)	Read Level (dBuV)	Factor (dB/m)	Limit (dBuV/m)	Margin (dB)	Antenna Height (cm)	Table Angle (Degree)	Remark
5592.75	52.98	51.11	1.87	68.2	-15.22	190	102	Peak
5657.35	51.82	49.97	1.85	73.66	-21.84	190	102	Peak
5917.65	51.03	48.72	2.31	73.62	-22.59	190	102	Peak
6010.275	51.6	49.21	2.39	68.2	-16.6	190	102	Peak

Remarks:

- Emission Level = Read Level + Factor
Margin value = Emission level – Limit value
- 5745 MHz: Fundamental Frequency
- *: Out of Restricted Band
- The emission levels of other frequencies were very low against the limit

EUT Test Condition		Measurement Detail	
Channel	Channel 157	Frequency Range	1 GHz ~ 40 GHz
Input Power	120 Vac, 60 Hz	Detector Function	Peak (PK) Average (AV)
Environmental Conditions	25 deg. C, 65 % RH	Tested By	Thomas Wei

**<Spurious Emission>
Horizontal**

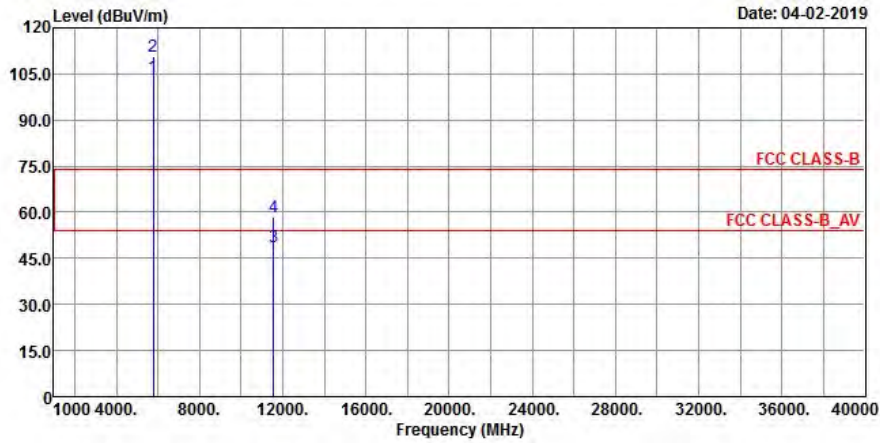

Vertical

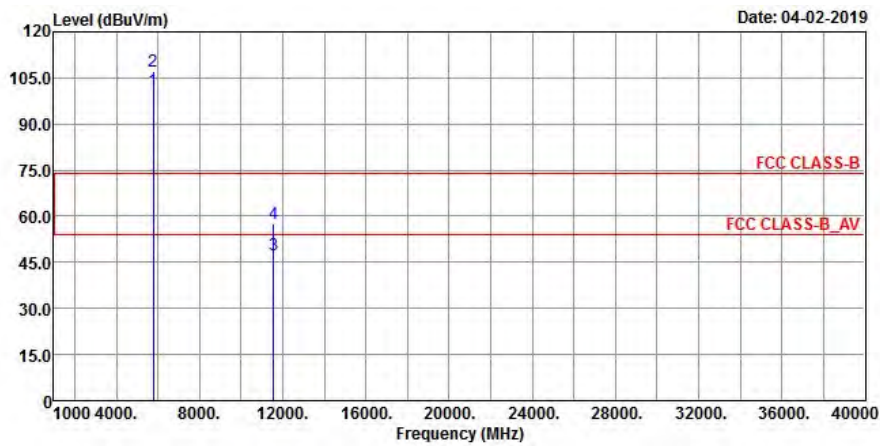

<Out of Band Emission (OOBE)> Horizontal

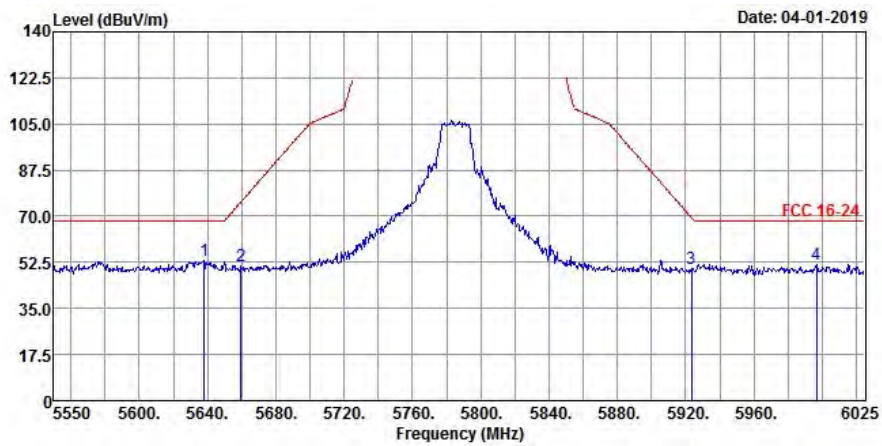

Vertical

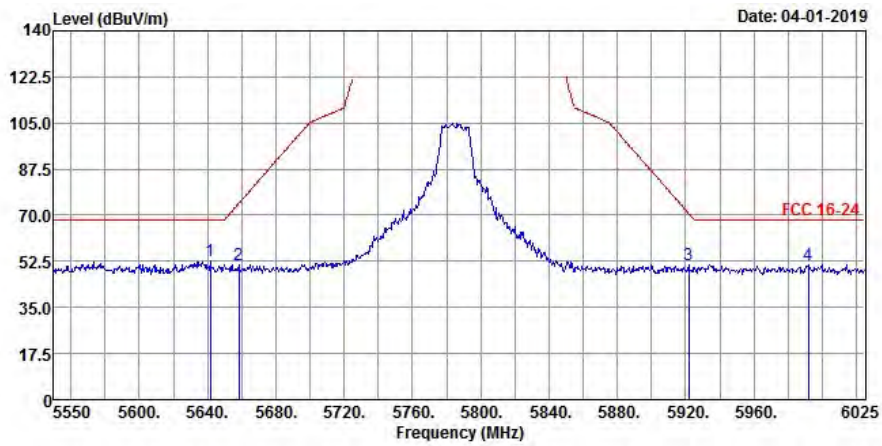

<Spurious Emission>

Antenna Polarity & Test Distance: Horizontal at 3 m								
Frequency (MHz)	Emission Level (dBuV/m)	Read Level (dBuV)	Factor (dB/m)	Limit (dBuV/m)	Margin (dB)	Antenna Height (cm)	Table Angle (Degree)	Remark
5785	104.22	102.3	1.92			182	7	Average
5785	110.7	108.78	1.92			182	7	Peak
11570	48.89	51.09	-2.2	54	-5.11	122	263	Average
11570	58.28	60.48	-2.2	74	-15.72	122	263	Peak
Antenna Polarity & Test Distance: Vertical at 3 m								
Frequency (MHz)	Emission Level (dBuV/m)	Read Level (dBuV)	Factor (dB/m)	Limit (dBuV/m)	Margin (dB)	Antenna Height (cm)	Table Angle (Degree)	Remark
5785	100.79	98.87	1.92			191	98	Average
5785	107.12	105.2	1.92			191	98	Peak
11570	47.5	49.7	-2.2	54	-6.5	124	332	Average
11570	57.68	59.88	-2.2	74	-16.32	124	332	Peak

<Out of Band Emission (OOBE)>

Antenna Polarity & Test Distance: Horizontal at 3 m								
Frequency (MHz)	Emission Level (dBuV/m)	Read Level (dBuV)	Factor (dB/m)	Limit (dBuV/m)	Margin (dB)	Antenna Height (cm)	Table Angle (Degree)	Remark
5637.875	53.03	51.15	1.88	68.2	-15.17	182	7	Peak
5659.725	51.34	49.49	1.85	75.42	-24.08	182	7	Peak
5923.35	50.04	47.74	2.3	69.42	-19.38	182	7	Peak
5996.5	51.8	49.44	2.36	68.2	-16.4	182	7	Peak
Antenna Polarity & Test Distance: Vertical at 3 m								
Frequency (MHz)	Emission Level (dBuV/m)	Read Level (dBuV)	Factor (dB/m)	Limit (dBuV/m)	Margin (dB)	Antenna Height (cm)	Table Angle (Degree)	Remark
5641.675	52.45	50.57	1.88	68.2	-15.75	191	98	Peak
5658.3	50.92	49.07	1.85	74.36	-23.44	191	98	Peak
5921.925	51.21	48.91	2.3	70.47	-19.26	191	98	Peak
5991.75	51.35	48.99	2.36	68.2	-16.85	191	98	Peak

Remarks:

1. Emission Level = Read Level + Factor
Margin value = Emission level – Limit value
2. 5785 MHz: Fundamental Frequency
3. *: Out of Restricted Band
4. The emission levels of other frequencies were very low against the limit

EUT Test Condition		Measurement Detail	
Channel	Channel 165	Frequency Range	1 GHz ~ 40 GHz
Input Power	120 Vac, 60 Hz	Detector Function	Peak (PK) Average (AV)
Environmental Conditions	25 deg. C, 65 % RH	Tested By	Thomas Wei

**<Spurious Emission>
Horizontal**

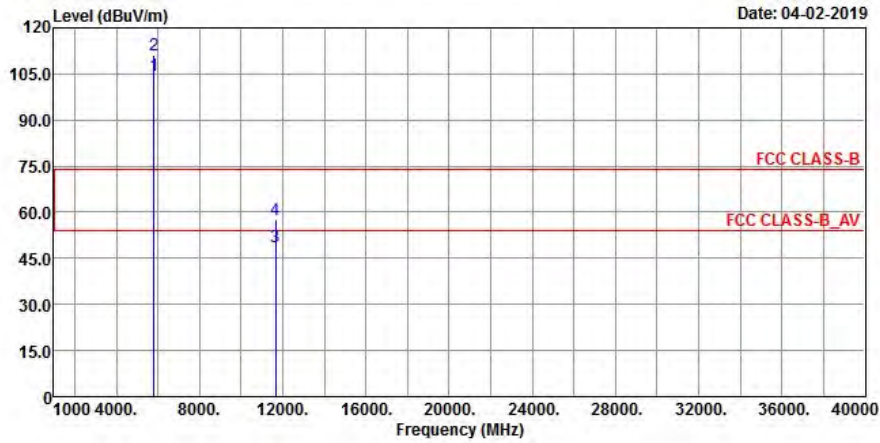

Vertical

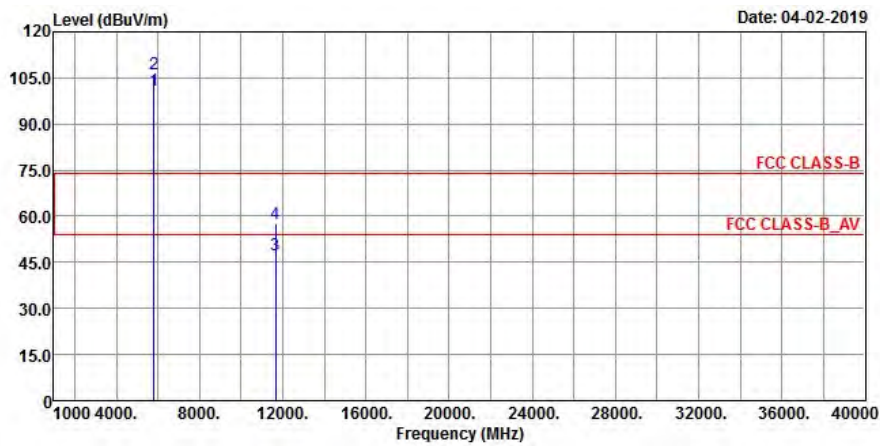

**<Out of Band Emission (OOBE)>
Horizontal**

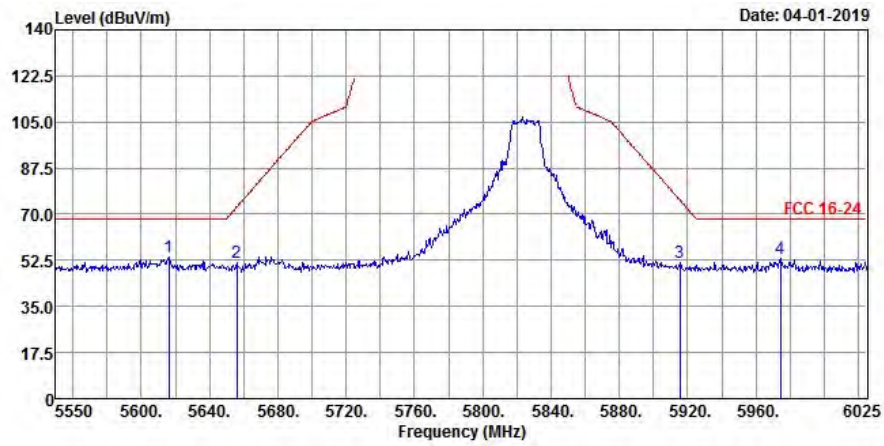

Vertical

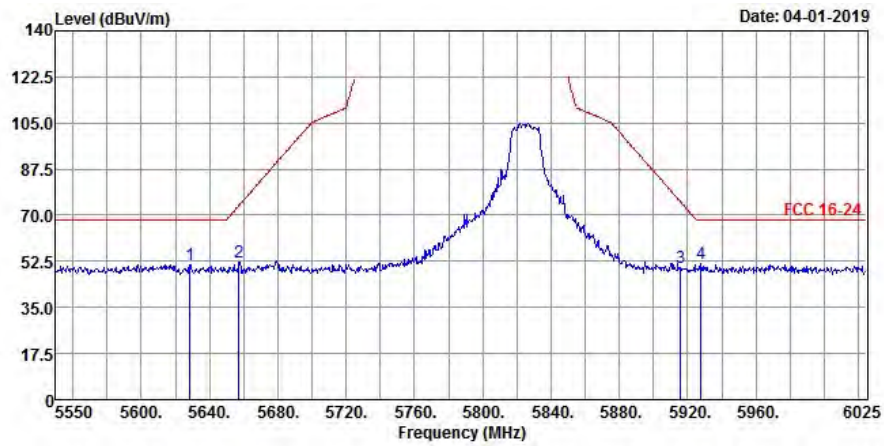

<Spurious Emission>

Antenna Polarity & Test Distance: Horizontal at 3 m								
Frequency (MHz)	Emission Level (dBuV/m)	Read Level (dBuV)	Factor (dB/m)	Limit (dBuV/m)	Margin (dB)	Antenna Height (cm)	Table Angle (Degree)	Remark
5825	104.4	102.32	2.08			171	5	Average
5825	111.04	108.96	2.08			171	5	Peak
11650	48.59	50.98	-2.39	54	-5.41	122	279	Average
11650	57.42	59.81	-2.39	74	-16.58	122	279	Peak
Antenna Polarity & Test Distance: Vertical at 3 m								
Frequency (MHz)	Emission Level (dBuV/m)	Read Level (dBuV)	Factor (dB/m)	Limit (dBuV/m)	Margin (dB)	Antenna Height (cm)	Table Angle (Degree)	Remark
5825	100.77	98.69	2.08			187	100	Average
5825	106.47	104.39	2.08			187	100	Peak
11650	47.25	49.64	-2.39	54	-6.75	128	314	Average
11650	57.67	60.06	-2.39	74	-16.33	128	314	Peak

<Out of Band Emission (OOBE)>

Antenna Polarity & Test Distance: Horizontal at 3 m								
Frequency (MHz)	Emission Level (dBuV/m)	Read Level (dBuV)	Factor (dB/m)	Limit (dBuV/m)	Margin (dB)	Antenna Height (cm)	Table Angle (Degree)	Remark
5616.025	53.54	51.64	1.9	68.2	-14.66	171	5	Peak
5655.925	51.62	49.77	1.85	72.6	-20.98	171	5	Peak
5915.275	51.84	49.53	2.31	75.37	-23.53	171	5	Peak
5974.175	53.38	51.05	2.33	68.2	-14.82	171	5	Peak
Antenna Polarity & Test Distance: Vertical at 3 m								
Frequency (MHz)	Emission Level (dBuV/m)	Read Level (dBuV)	Factor (dB/m)	Limit (dBuV/m)	Margin (dB)	Antenna Height (cm)	Table Angle (Degree)	Remark
5628.375	51.36	49.52	1.84	68.2	-16.84	187	100	Peak
5657.35	52.22	50.37	1.85	73.66	-21.44	187	100	Peak
5915.75	50.1	47.79	2.31	75.02	-24.92	187	100	Peak
5927.625	51.47	49.17	2.3	68.2	-16.73	187	100	Peak

Remarks:

1. Emission Level = Read Level + Factor
Margin value = Emission level – Limit value
2. 5825 MHz: Fundamental Frequency
3. *: Out of Restricted Band
4. The emission levels of other frequencies were very low against the limit

802.11n (HT20)

EUT Test Condition		Measurement Detail	
Channel	Channel 36	Frequency Range	1 GHz ~ 40 GHz
Input Power	120 Vac, 60 Hz	Detector Function	Peak (PK) Average (AV)
Environmental Conditions	25 deg. C, 65 % RH	Tested By	Tim Chen

Horizontal

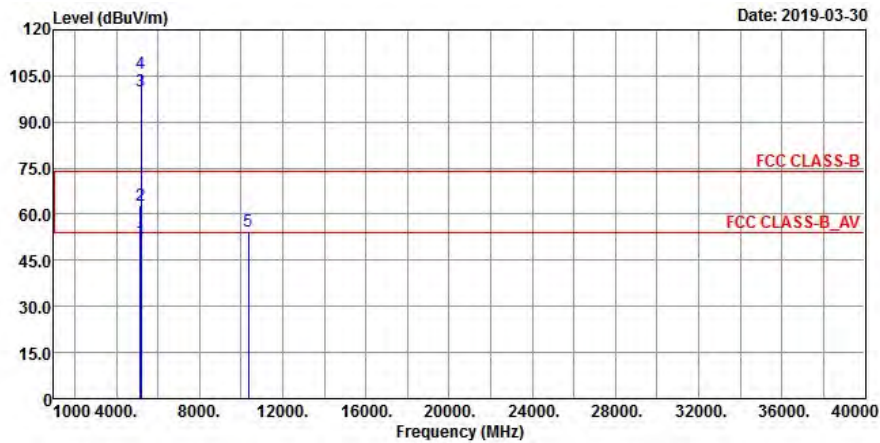

Vertical

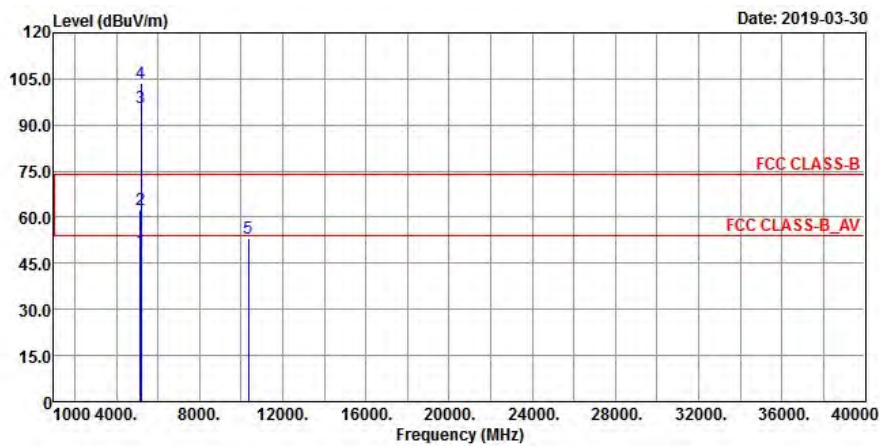

Antenna Polarity & Test Distance: Horizontal at 3 m

Frequency (MHz)	Emission Level (dBuV/m)	Read Level (dBuV)	Factor (dB/m)	Limit (dBuV/m)	Margin (dB)	Antenna Height (cm)	Table Angle (Degree)	Remark
5149.58	51.22	49.69	1.53	54	-2.78	192	344	Average
5149.58	62.67	61.14	1.53	74	-11.33	192	344	Peak
5180	99.88	98.35	1.53			192	344	Average
5180	105.65	104.12	1.53			192	344	Peak
*10360	54.46	57.3	-2.84	68.2	-13.74	137	102	Peak

Antenna Polarity & Test Distance: Vertical at 3 m

Frequency (MHz)	Emission Level (dBuV/m)	Read Level (dBuV)	Factor (dB/m)	Limit (dBuV/m)	Margin (dB)	Antenna Height (cm)	Table Angle (Degree)	Remark
5149.94	48.98	47.45	1.53	54	-5.02	185	106	Average
5149.94	62.44	60.91	1.53	74	-11.56	185	106	Peak
5180	95.78	94.25	1.53			185	106	Average
5180	103.64	102.11	1.53			185	106	Peak
*10360	53.06	55.9	-2.84	68.2	-15.14	166	352	Peak

Remarks:

- Emission Level = Read Level + Factor
Margin value = Emission level – Limit value
- 5180 MHz: Fundamental Frequency
- *: Out of Restricted Band
- The emission levels of other frequencies were very low against the limit

EUT Test Condition		Measurement Detail	
Channel	Channel 40	Frequency Range	1 GHz ~ 40 GHz
Input Power	120 Vac, 60 Hz	Detector Function	Peak (PK) Average (AV)
Environmental Conditions	25 deg. C, 65 % RH	Tested By	Tim Chen

Horizontal

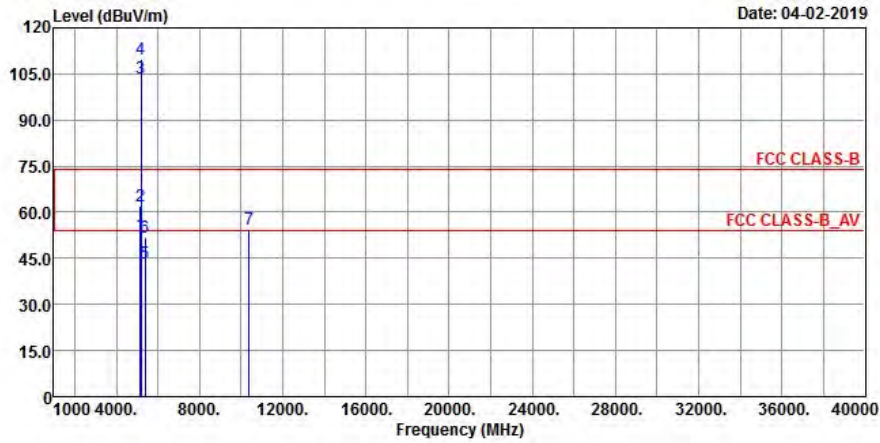

Vertical

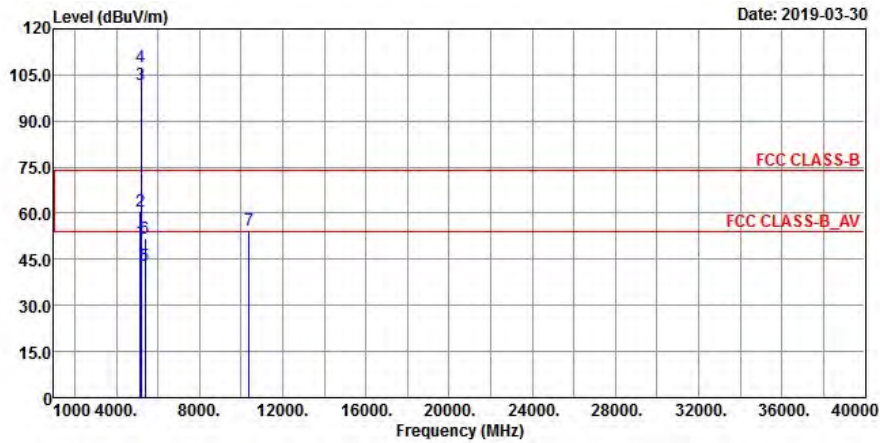

Antenna Polarity & Test Distance: Horizontal at 3 m

Frequency (MHz)	Emission Level (dBuV/m)	Read Level (dBuV)	Factor (dB/m)	Limit (dBuV/m)	Margin (dB)	Antenna Height (cm)	Table Angle (Degree)	Remark
5149.76	52.49	50.96	1.53	54	-1.51	192	344	Average
5149.76	61.78	60.25	1.53	74	-12.22	192	344	Peak
5200	103.71	102.18	1.53			192	344	Average
5200	109.97	108.44	1.53			192	344	Peak
5400.93	43.28	41.61	1.67	54	-10.72	192	344	Average
5400.93	51.9	50.23	1.67	74	-22.1	192	344	Peak
10400	54.68	57.57	-2.89	74	-19.32	127	178	Peak

Antenna Polarity & Test Distance: Vertical at 3 m

Frequency (MHz)	Emission Level (dBuV/m)	Read Level (dBuV)	Factor (dB/m)	Limit (dBuV/m)	Margin (dB)	Antenna Height (cm)	Table Angle (Degree)	Remark
5149.76	50.82	49.29	1.53	54	-3.18	185	106	Average
5149.76	60.58	59.05	1.53	74	-13.42	185	106	Peak
5200	101.69	100.16	1.53			185	106	Average
5200	107.7	106.17	1.53			185	106	Peak
5400.6	42.85	41.18	1.67	54	-11.15	185	106	Average
5400.6	51.79	50.12	1.67	74	-22.21	185	106	Peak
10400	54.4	57.29	-2.89	74	-19.6	231	166	Peak

Remarks:

- Emission Level = Read Level + Factor
Margin value = Emission level – Limit value
- 5200 MHz: Fundamental Frequency
- *: Out of Restricted Band
- The emission levels of other frequencies were very low against the limit

EUT Test Condition		Measurement Detail	
Channel	Channel 48	Frequency Range	1 GHz ~ 40 GHz
Input Power	120 Vac, 60 Hz	Detector Function	Peak (PK) Average (AV)
Environmental Conditions	25 deg. C, 65 % RH	Tested By	Tim Chen

Horizontal

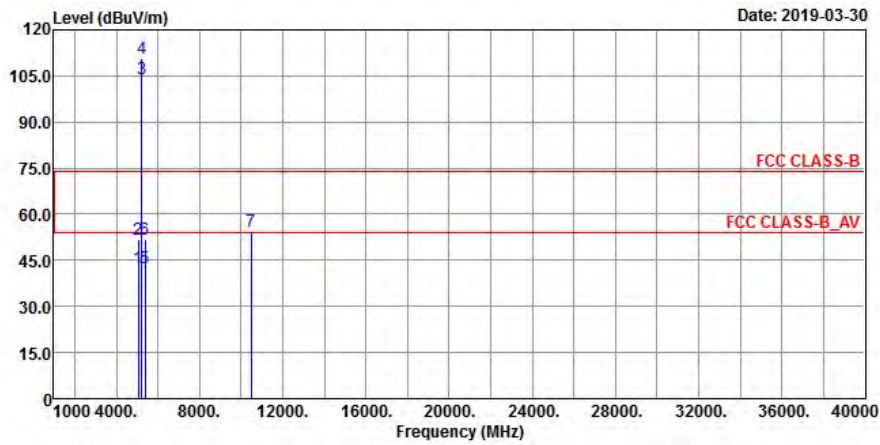

Vertical

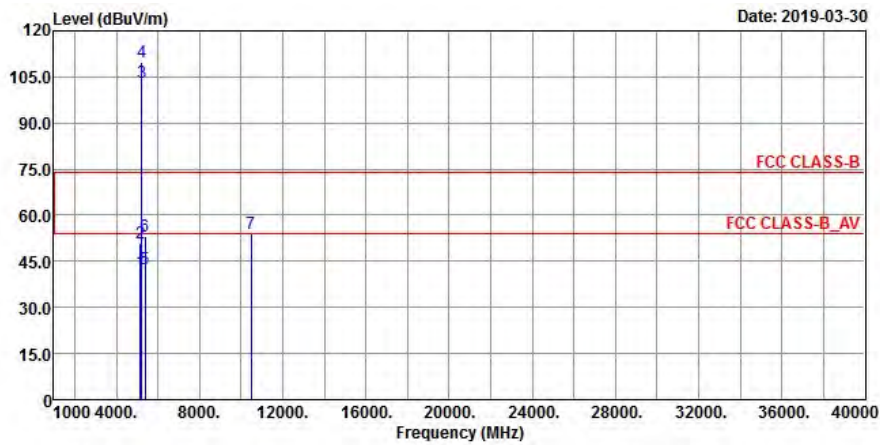

Antenna Polarity & Test Distance: Horizontal at 3 m

Frequency (MHz)	Emission Level (dBuV/m)	Read Level (dBuV)	Factor (dB/m)	Limit (dBuV/m)	Margin (dB)	Antenna Height (cm)	Table Angle (Degree)	Remark
5054	42.69	41.15	1.54	54	-11.31	198	336	Average
5054	51.85	50.31	1.54	74	-22.15	198	336	Peak
5240	104.18	102.8	1.38			198	336	Average
5240	110.69	109.31	1.38			198	336	Peak
5389.05	42.67	41.07	1.6	54	-11.33	198	336	Average
5389.05	51.98	50.38	1.6	74	-22.02	198	336	Peak
*10480	54.51	57.24	-2.73	68.2	-13.69	128	69	Peak

Antenna Polarity & Test Distance: Vertical at 3 m

Frequency (MHz)	Emission Level (dBuV/m)	Read Level (dBuV)	Factor (dB/m)	Limit (dBuV/m)	Margin (dB)	Antenna Height (cm)	Table Angle (Degree)	Remark
5149.94	41.73	40.2	1.53	54	-12.27	196	100	Average
5149.94	50.73	49.2	1.53	74	-23.27	196	100	Peak
5240	103.26	101.88	1.38			196	100	Average
5240	109.63	108.25	1.38			196	100	Peak
5388.94	42.6	41	1.6	54	-11.4	196	100	Average
5388.94	52.94	51.34	1.6	74	-21.06	196	100	Peak
*10480	53.99	56.72	-2.73	68.2	-14.21	152	134	Peak

Remarks:

- Emission Level = Read Level + Factor
Margin value = Emission level – Limit value
- 5240 MHz: Fundamental Frequency
- *: Out of Restricted Band
- The emission levels of other frequencies were very low against the limit

EUT Test Condition		Measurement Detail	
Channel	Channel 52	Frequency Range	1 GHz ~ 40 GHz
Input Power	120 Vac, 60 Hz	Detector Function	Peak (PK) Average (AV)
Environmental Conditions	25 deg. C, 65 % RH	Tested By	Thomas Wei

Horizontal

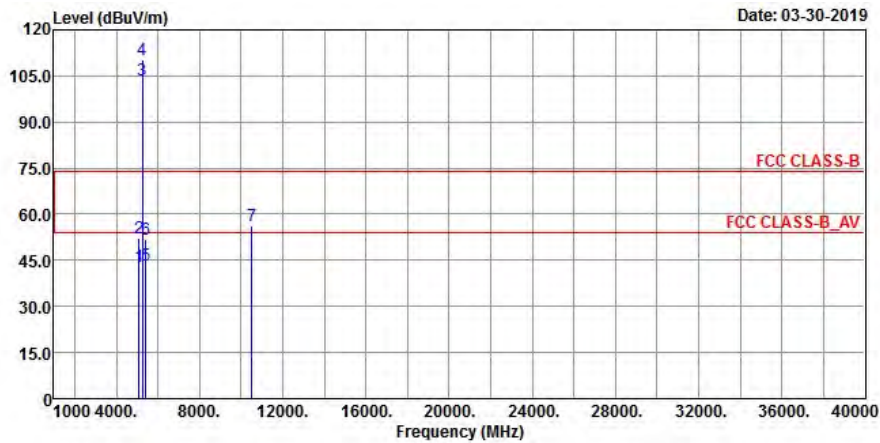

Vertical

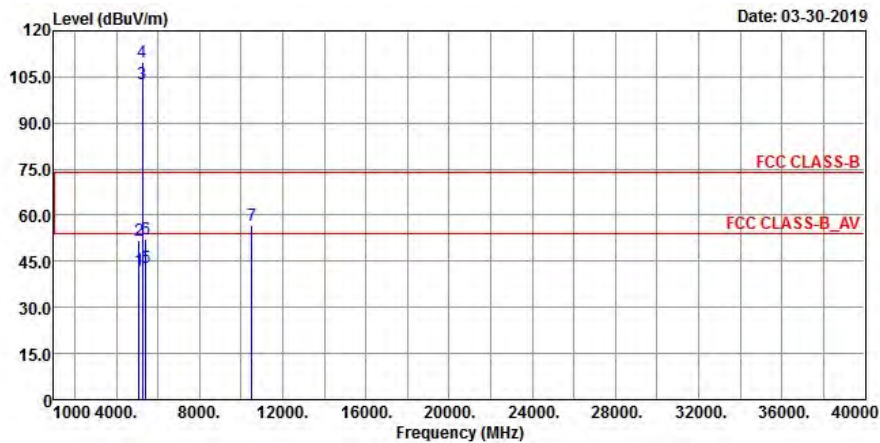

Antenna Polarity & Test Distance: Horizontal at 3 m

Frequency (MHz)	Emission Level (dBuV/m)	Read Level (dBuV)	Factor (dB/m)	Limit (dBuV/m)	Margin (dB)	Antenna Height (cm)	Table Angle (Degree)	Remark
5109.26	42.99	41.52	1.47	54	-11.01	215	346	Average
5109.26	52.21	50.74	1.47	74	-21.79	215	346	Peak
5260	103.44	102.13	1.31			215	346	Average
5260	110.45	109.14	1.31			215	346	Peak
5410.72	43.37	41.7	1.67	54	-10.63	215	346	Average
5410.72	52.02	50.35	1.67	74	-21.98	215	346	Peak
*10520	56.22	58.94	-2.72	68.2	-11.98	176	200	Peak

Antenna Polarity & Test Distance: Vertical at 3 m

Frequency (MHz)	Emission Level (dBuV/m)	Read Level (dBuV)	Factor (dB/m)	Limit (dBuV/m)	Margin (dB)	Antenna Height (cm)	Table Angle (Degree)	Remark
5108.72	41.97	40.5	1.47	54	-12.03	206	109	Average
5108.72	51.68	50.21	1.47	74	-22.32	206	109	Peak
5260	102.68	101.37	1.31			206	109	Average
5260	109.67	108.36	1.31			206	109	Peak
5406.87	42.98	41.31	1.67	54	-11.02	206	109	Average
5406.87	52.19	50.52	1.67	74	-21.81	206	109	Peak
*10520	56.78	59.5	-2.72	68.2	-11.42	158	235	Peak

Remarks:

- Emission Level = Read Level + Factor
Margin value = Emission level – Limit value
- 5260 MHz: Fundamental Frequency
- *: Out of Restricted Band
- The emission levels of other frequencies were very low against the limit

EUT Test Condition		Measurement Detail	
Channel	Channel 60	Frequency Range	1 GHz ~ 40 GHz
Input Power	120 Vac, 60 Hz	Detector Function	Peak (PK) Average (AV)
Environmental Conditions	25 deg. C, 65 % RH	Tested By	Thomas Wei

Horizontal

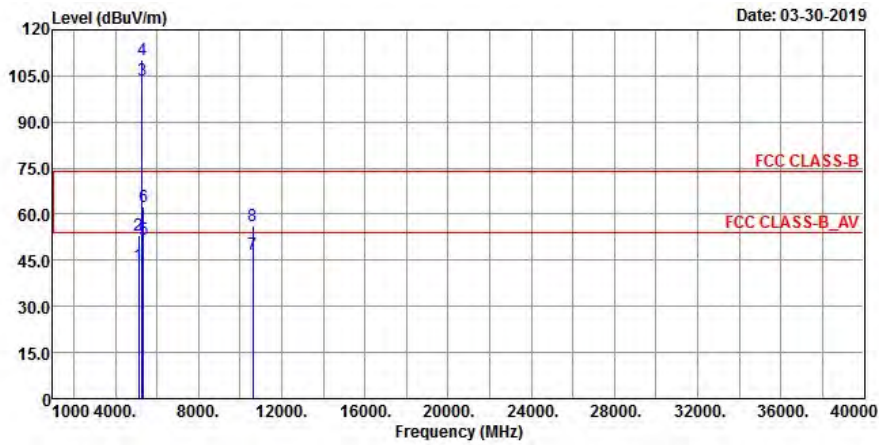

Vertical

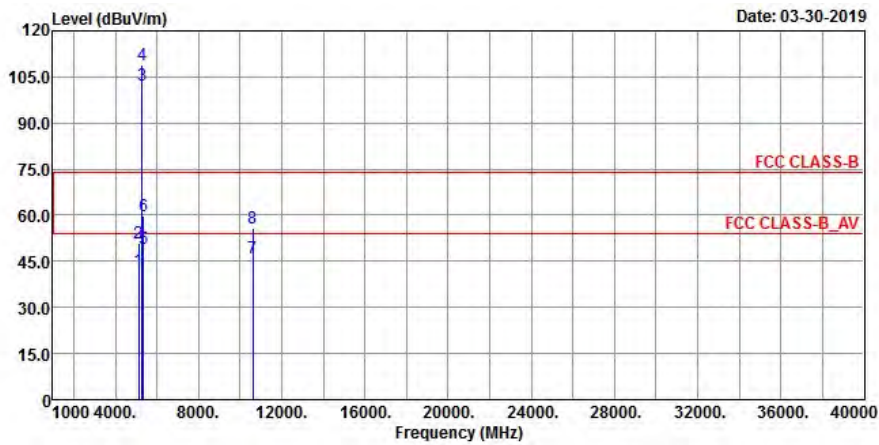

Antenna Polarity & Test Distance: Horizontal at 3 m

Frequency (MHz)	Emission Level (dBuV/m)	Read Level (dBuV)	Factor (dB/m)	Limit (dBuV/m)	Margin (dB)	Antenna Height (cm)	Table Angle (Degree)	Remark
5111.96	43.31	41.84	1.47	54	-10.69	204	345	Average
5111.96	53.08	51.61	1.47	74	-20.92	204	345	Peak
5300	103.74	102.43	1.31			204	345	Average
5300	110.14	108.83	1.31			204	345	Peak
5350.11	51.7	50.24	1.46	54	-2.3	204	345	Average
5350.11	62.53	61.07	1.46	74	-11.47	204	345	Peak
10600	46.77	49.68	-2.91	54	-7.23	152	171	Average
10600	56.06	58.97	-2.91	74	-17.94	152	171	Peak

Antenna Polarity & Test Distance: Vertical at 3 m

Frequency (MHz)	Emission Level (dBuV/m)	Read Level (dBuV)	Factor (dB/m)	Limit (dBuV/m)	Margin (dB)	Antenna Height (cm)	Table Angle (Degree)	Remark
5111.96	41.9	40.43	1.47	54	-12.1	204	111	Average
5111.96	51.05	49.58	1.47	74	-22.95	204	111	Peak
5300	102.08	100.77	1.31			204	111	Average
5300	109.15	107.84	1.31			204	111	Peak
5350.11	49.27	47.81	1.46	54	-4.73	204	111	Average
5350.11	59.9	58.44	1.46	74	-14.1	204	111	Peak
10600	46.13	49.04	-2.91	54	-7.87	160	237	Average
10600	56	58.91	-2.91	74	-18	160	237	Peak

Remarks:

- Emission Level = Read Level + Factor
Margin value = Emission level – Limit value
- 5300 MHz: Fundamental Frequency
- *: Out of Restricted Band
- The emission levels of other frequencies were very low against the limit

EUT Test Condition		Measurement Detail	
Channel	Channel 64	Frequency Range	1 GHz ~ 40 GHz
Input Power	120 Vac, 60 Hz	Detector Function	Peak (PK) Average (AV)
Environmental Conditions	25 deg. C, 65 % RH	Tested By	Thomas Wei

Horizontal

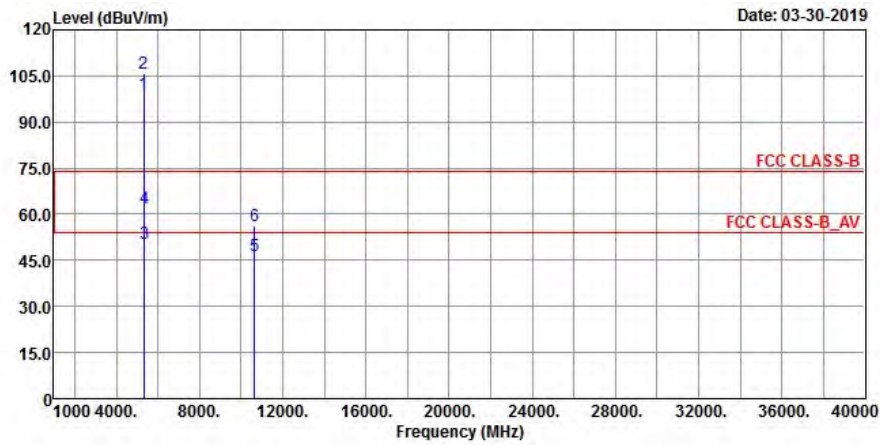

Vertical

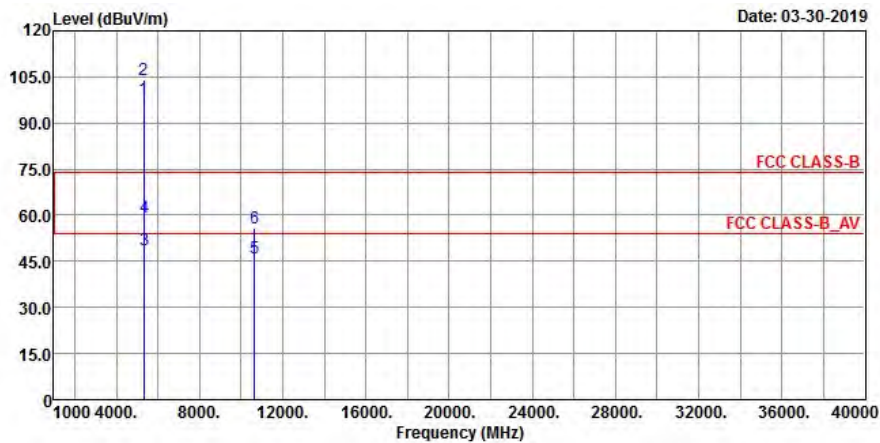

Antenna Polarity & Test Distance: Horizontal at 3 m

Frequency (MHz)	Emission Level (dBuV/m)	Read Level (dBuV)	Factor (dB/m)	Limit (dBuV/m)	Margin (dB)	Antenna Height (cm)	Table Angle (Degree)	Remark
5320	99.17	97.81	1.36			208	346	Average
5320	106.02	104.66	1.36			208	346	Peak
5350.66	50.3	48.84	1.46	54	-3.7	208	346	Average
5350.66	62.21	60.75	1.46	74	-11.79	208	346	Peak
10640	46.38	49.27	-2.89	54	-7.62	179	206	Average
10640	56.39	59.28	-2.89	74	-17.61	179	206	Peak

Antenna Polarity & Test Distance: Vertical at 3 m

Frequency (MHz)	Emission Level (dBuV/m)	Read Level (dBuV)	Factor (dB/m)	Limit (dBuV/m)	Margin (dB)	Antenna Height (cm)	Table Angle (Degree)	Remark
5320	97.84	96.48	1.36			212	110	Average
5320	104.18	102.82	1.36			212	110	Peak
5350	48.49	47.03	1.46	54	-5.51	212	110	Average
5350	59.13	57.67	1.46	74	-14.87	212	110	Peak
10640	45.88	48.77	-2.89	54	-8.12	185	236	Average
10640	55.83	58.72	-2.89	74	-18.17	185	236	Peak

Remarks:

- Emission Level = Read Level + Factor
Margin value = Emission level – Limit value
- 5320 MHz: Fundamental Frequency
- *: Out of Restricted Band
- The emission levels of other frequencies were very low against the limit

EUT Test Condition		Measurement Detail	
Channel	Channel 100	Frequency Range	1 GHz ~ 40 GHz
Input Power	120 Vac, 60 Hz	Detector Function	Peak (PK) Average (AV)
Environmental Conditions	25 deg. C, 65 % RH	Tested By	Thomas Wei

Horizontal

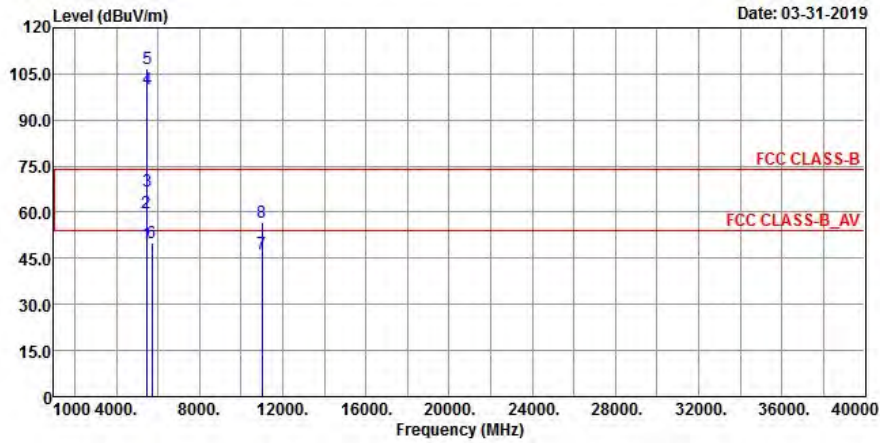

Vertical

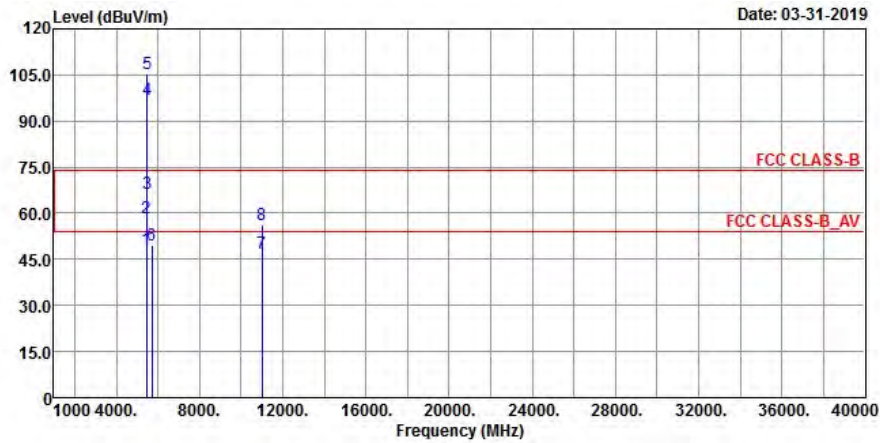

Antenna Polarity & Test Distance: Horizontal at 3 m

Frequency (MHz)	Emission Level (dBuV/m)	Read Level (dBuV)	Factor (dB/m)	Limit (dBuV/m)	Margin (dB)	Antenna Height (cm)	Table Angle (Degree)	Remark
5458.32	49.43	47.56	1.87	54	-4.57	185	343	Average
5458.32	59.85	57.98	1.87	74	-14.15	185	343	Peak
*5470	66.68	64.82	1.86	68.2	-1.52	185	343	Peak
5500	100.06	98.19	1.87			185	343	Average
5500	106.55	104.68	1.87			185	343	Peak
*5725	49.97	48.21	1.76	68.2	-18.23	185	343	Peak
11000	46.48	48.79	-2.31	54	-7.52	129	301	Average
11000	56.85	59.16	-2.31	74	-17.15	129	301	Peak

Antenna Polarity & Test Distance: Vertical at 3 m

Frequency (MHz)	Emission Level (dBuV/m)	Read Level (dBuV)	Factor (dB/m)	Limit (dBuV/m)	Margin (dB)	Antenna Height (cm)	Table Angle (Degree)	Remark
5459.76	48.4	46.53	1.87	54	-5.6	195	102	Average
5459.76	58.58	56.71	1.87	74	-15.42	195	102	Peak
*5470	66.6	64.74	1.86	68.2	-1.6	195	102	Peak
5500	97.17	95.3	1.87			195	102	Average
5500	105.34	103.47	1.87			195	102	Peak
*5725	49.74	47.98	1.76	68.2	-18.46	195	102	Peak
11000	46.74	49.05	-2.31	54	-7.26	172	231	Average
11000	56.42	58.73	-2.31	74	-17.58	172	231	Peak

Remarks:

- Emission Level = Read Level + Factor
Margin value = Emission level – Limit value
- 5500 MHz: Fundamental Frequency
- *: Out of Restricted Band
- The emission levels of other frequencies were very low against the limit

EUT Test Condition		Measurement Detail	
Channel	Channel 116	Frequency Range	1 GHz ~ 40 GHz
Input Power	120 Vac, 60 Hz	Detector Function	Peak (PK) Average (AV)
Environmental Conditions	25 deg. C, 65 % RH	Tested By	Thomas Wei

Horizontal

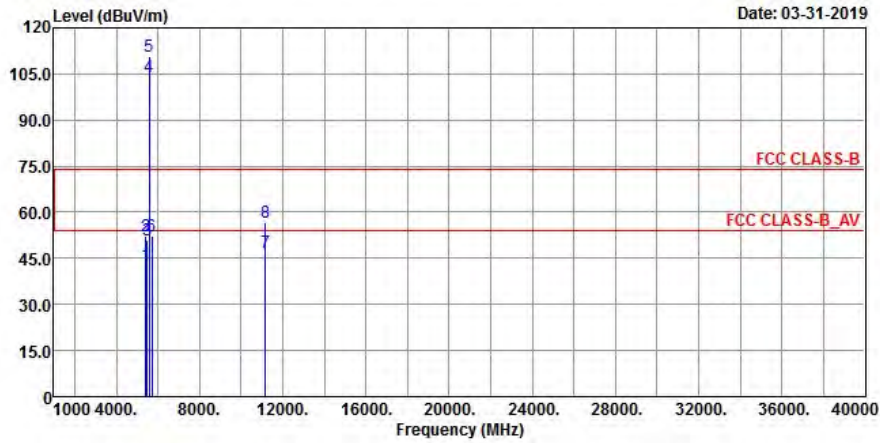

Vertical

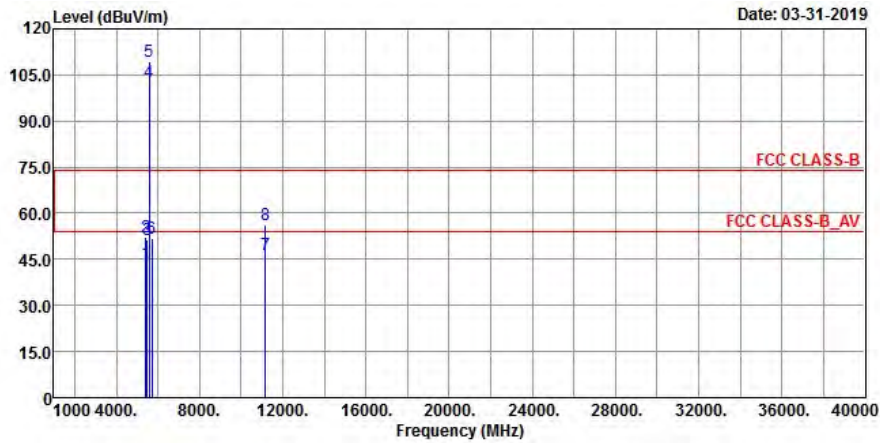

Antenna Polarity & Test Distance: Horizontal at 3 m

Frequency (MHz)	Emission Level (dBuV/m)	Read Level (dBuV)	Factor (dB/m)	Limit (dBuV/m)	Margin (dB)	Antenna Height (cm)	Table Angle (Degree)	Remark
5428.24	42.98	41.22	1.76	54	-11.02	172	12	Average
5428.24	52.03	50.27	1.76	74	-21.97	172	12	Peak
*5470	50.98	49.12	1.86	68.2	-17.22	172	12	Peak
5580	104.05	102.23	1.82			172	12	Average
5580	110.71	108.89	1.82			172	12	Peak
*5725	52.23	50.47	1.76	68.2	-15.97	172	12	Peak
11160	46.73	49.28	-2.55	54	-7.27	197	326	Average
11160	56.49	59.04	-2.55	74	-17.51	197	326	Peak

Antenna Polarity & Test Distance: Vertical at 3 m

Frequency (MHz)	Emission Level (dBuV/m)	Read Level (dBuV)	Factor (dB/m)	Limit (dBuV/m)	Margin (dB)	Antenna Height (cm)	Table Angle (Degree)	Remark
5428.88	43.71	41.93	1.78	54	-10.29	192	101	Average
5428.88	52.36	50.58	1.78	74	-21.64	192	101	Peak
*5470	51.18	49.32	1.86	68.2	-17.02	192	101	Peak
5580	102.82	101	1.82			192	101	Average
5580	109.17	107.35	1.82			192	101	Peak
*5725	51.98	50.22	1.76	68.2	-16.22	192	101	Peak
11160	46.54	49.09	-2.55	54	-7.46	213	136	Average
11160	56.29	58.84	-2.55	74	-17.71	213	136	Peak

Remarks:

- Emission Level = Read Level + Factor
Margin value = Emission level – Limit value
- 5580 MHz: Fundamental Frequency
- *: Out of Restricted Band
- The emission levels of other frequencies were very low against the limit

EUT Test Condition		Measurement Detail	
Channel	Channel 140	Frequency Range	1 GHz ~ 40 GHz
Input Power	120 Vac, 60 Hz	Detector Function	Peak (PK) Average (AV)
Environmental Conditions	25 deg. C, 65 % RH	Tested By	Thomas Wei

Horizontal

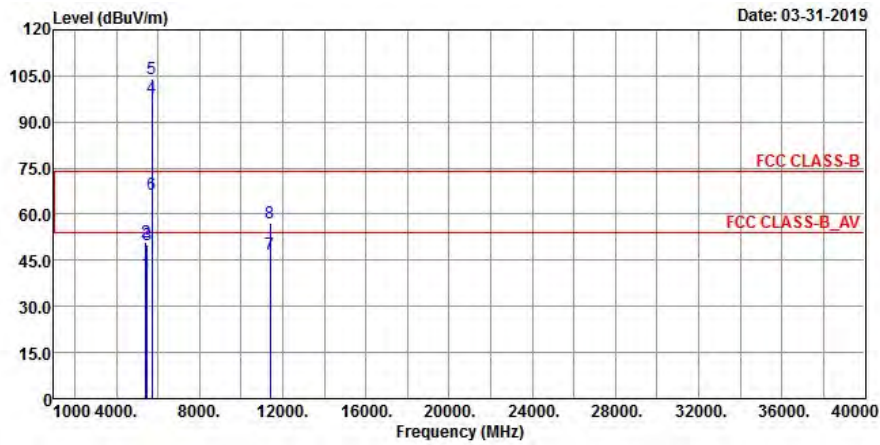

Vertical

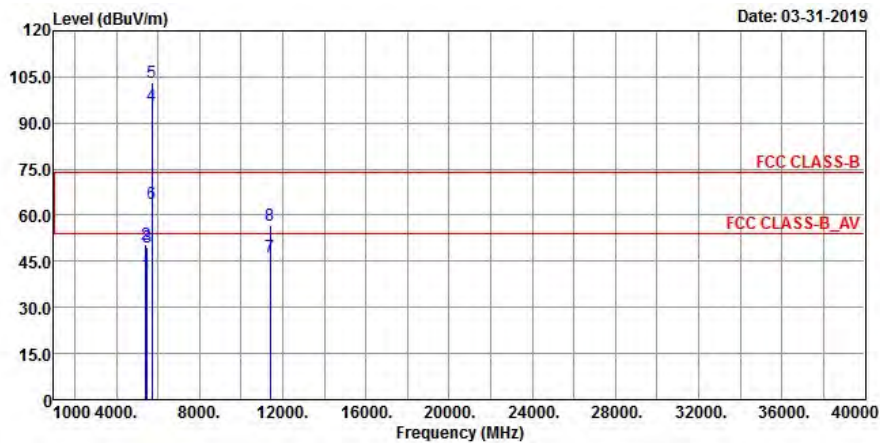

Antenna Polarity & Test Distance: Horizontal at 3 m

Frequency (MHz)	Emission Level (dBuV/m)	Read Level (dBuV)	Factor (dB/m)	Limit (dBuV/m)	Margin (dB)	Antenna Height (cm)	Table Angle (Degree)	Remark
5434.16	40.92	39.14	1.78	54	-13.08	175	5	Average
5434.16	51.05	49.27	1.78	74	-22.95	175	5	Peak
*5470	49.86	48	1.86	68.2	-18.34	175	5	Peak
5700	98	96.41	1.59			175	5	Average
5700	103.98	102.39	1.59			175	5	Peak
*5725	66.63	64.87	1.76	68.2	-1.57	175	5	Peak
11400	46.94	49.17	-2.23	54	-7.06	179	186	Average
11400	57.21	59.44	-2.23	74	-16.79	179	186	Peak

Antenna Polarity & Test Distance: Vertical at 3 m

Frequency (MHz)	Emission Level (dBuV/m)	Read Level (dBuV)	Factor (dB/m)	Limit (dBuV/m)	Margin (dB)	Antenna Height (cm)	Table Angle (Degree)	Remark
5430.48	40.94	39.16	1.78	54	-13.06	189	103	Average
5430.48	50.58	48.8	1.78	74	-23.42	189	103	Peak
*5470	49.71	47.85	1.86	68.2	-18.49	189	103	Peak
5700	95.57	93.98	1.59			189	103	Average
5700	103.19	101.6	1.59			189	103	Peak
*5725	63.59	61.83	1.76	68.2	-4.61	189	103	Peak
11400	46.46	48.69	-2.23	54	-7.54	164	149	Average
11400	56.61	58.84	-2.23	74	-17.39	164	149	Peak

Remarks:

- Emission Level = Read Level + Factor
Margin value = Emission level – Limit value
- 5700 MHz: Fundamental Frequency
- *: Out of Restricted Band
- The emission levels of other frequencies were very low against the limit

EUT Test Condition		Measurement Detail	
Channel	Channel 144	Frequency Range	1 GHz ~ 40 GHz
Input Power	120 Vac, 60 Hz	Detector Function	Peak (PK) Average (AV)
Environmental Conditions	25 deg. C, 65 % RH	Tested By	Thomas Wei

Horizontal

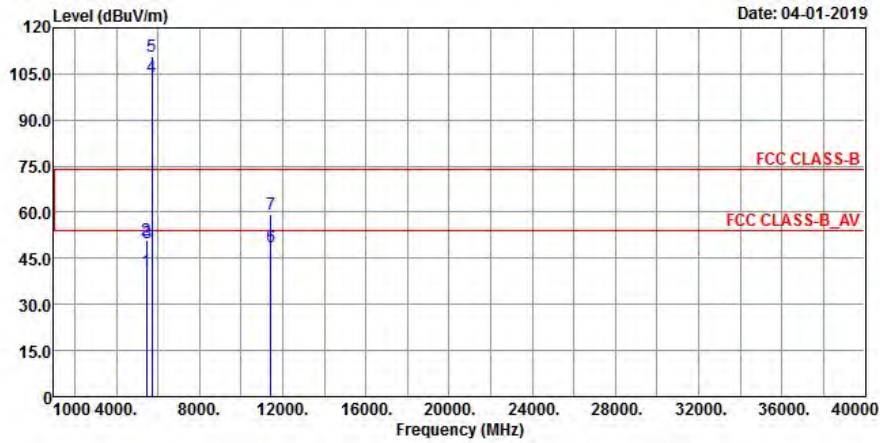

Vertical

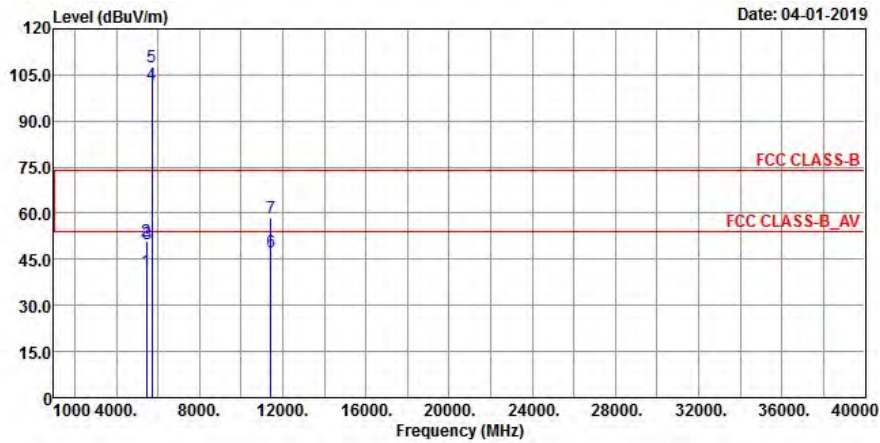

Antenna Polarity & Test Distance: Horizontal at 3 m

Frequency (MHz)	Emission Level (dBuV/m)	Read Level (dBuV)	Factor (dB/m)	Limit (dBuV/m)	Margin (dB)	Antenna Height (cm)	Table Angle (Degree)	Remark
5455.76	40.89	39.02	1.87	54	-13.11	177	5	Average
5455.76	50.87	49	1.87	74	-23.13	177	5	Peak
*5470	49.94	48.08	1.86	68.2	-18.26	177	5	Peak
5720	104.08	102.32	1.76			177	5	Average
5720	110.55	108.79	1.76			177	5	Peak
11440	48.67	50.89	-2.22	54	-5.33	121	271	Average
11440	59.33	61.55	-2.22	74	-14.67	121	271	Peak

Antenna Polarity & Test Distance: Vertical at 3 m

Frequency (MHz)	Emission Level (dBuV/m)	Read Level (dBuV)	Factor (dB/m)	Limit (dBuV/m)	Margin (dB)	Antenna Height (cm)	Table Angle (Degree)	Remark
5444.24	41.03	39.25	1.78	54	-12.97	195	100	Average
5444.24	50.72	48.94	1.78	74	-23.28	195	100	Peak
*5470	50.17	48.31	1.86	68.2	-18.03	195	100	Peak
5720	101.85	100.09	1.76			195	100	Average
5720	107.73	105.97	1.76			195	100	Peak
11440	47.3	49.52	-2.22	54	-6.7	146	318	Average
11440	58.59	60.81	-2.22	74	-15.41	146	318	Peak

Remarks:

- Emission Level = Read Level + Factor
Margin value = Emission level – Limit value
- 5720 MHz: Fundamental Frequency
- *: Out of Restricted Band
- The emission levels of other frequencies were very low against the limit

EUT Test Condition		Measurement Detail	
Channel	Channel 149	Frequency Range	1 GHz ~ 40 GHz
Input Power	120 Vac, 60 Hz	Detector Function	Peak (PK) Average (AV)
Environmental Conditions	25 deg. C, 65 % RH	Tested By	Thomas Wei

**<Spurious Emission>
Horizontal**

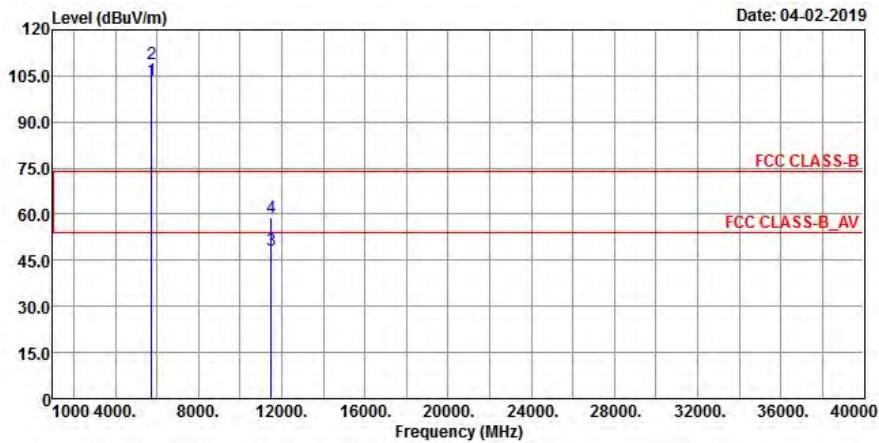

Vertical

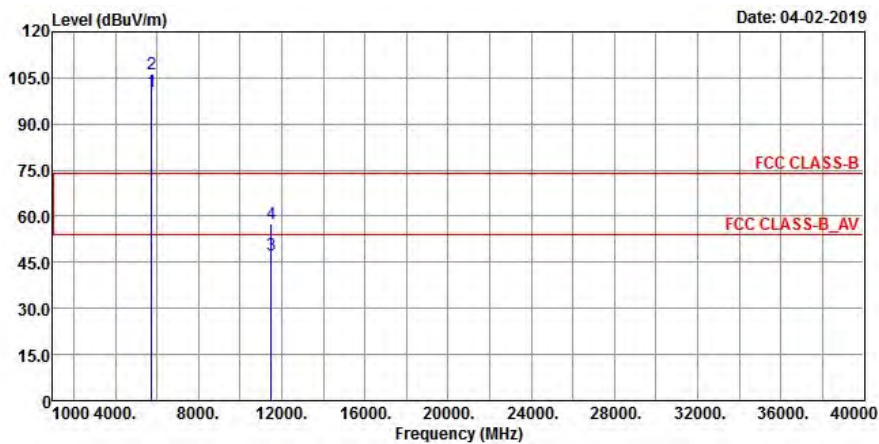

**<Out of Band Emission (OOBE)>
Horizontal**

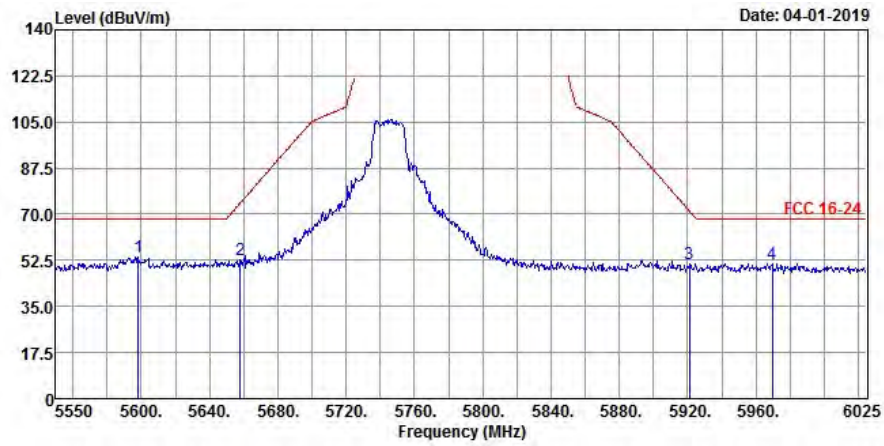

Vertical

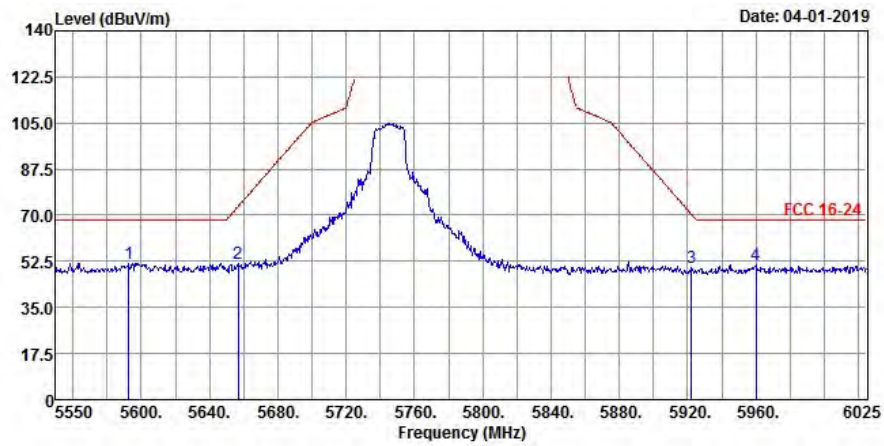

<Spurious Emission>

Antenna Polarity & Test Distance: Horizontal at 3 m								
Frequency (MHz)	Emission Level (dBuV/m)	Read Level (dBuV)	Factor (dB/m)	Limit (dBuV/m)	Margin (dB)	Antenna Height (cm)	Table Angle (Degree)	Remark
5745	103.52	101.7	1.82			201	5	Average
5745	109.01	107.19	1.82			201	5	Peak
11490	48.3	50.5	-2.2	54	-5.7	120	270	Average
11490	58.87	61.07	-2.2	74	-15.13	120	270	Peak
Antenna Polarity & Test Distance: Vertical at 3 m								
Frequency (MHz)	Emission Level (dBuV/m)	Read Level (dBuV)	Factor (dB/m)	Limit (dBuV/m)	Margin (dB)	Antenna Height (cm)	Table Angle (Degree)	Remark
5745	100.51	98.69	1.82			190	99	Average
5745	106.14	104.32	1.82			190	99	Peak
11490	47.54	49.74	-2.2	54	-6.46	124	309	Average
11490	57.45	59.65	-2.2	74	-16.55	124	309	Peak

<Out of Band Emission (OOBE)>

Antenna Polarity & Test Distance: Horizontal at 3 m								
Frequency (MHz)	Emission Level (dBuV/m)	Read Level (dBuV)	Factor (dB/m)	Limit (dBuV/m)	Margin (dB)	Antenna Height (cm)	Table Angle (Degree)	Remark
5598.45	53.95	52.08	1.87	68.2	-14.25	201	5	Peak
5657.825	52.91	51.06	1.85	74.01	-21.1	201	5	Peak
5920.975	51.27	48.96	2.31	71.17	-19.9	201	5	Peak
5969.425	51.3	49	2.3	68.2	-16.9	201	5	Peak
Antenna Polarity & Test Distance: Vertical at 3 m								
Frequency (MHz)	Emission Level (dBuV/m)	Read Level (dBuV)	Factor (dB/m)	Limit (dBuV/m)	Margin (dB)	Antenna Height (cm)	Table Angle (Degree)	Remark
5592.75	51.89	50.02	1.87	68.2	-16.31	190	99	Peak
5656.875	51.69	49.84	1.85	73.31	-21.62	190	99	Peak
5922.4	49.89	47.59	2.3	70.12	-20.23	190	99	Peak
5959.925	51.11	48.81	2.3	68.2	-17.09	190	99	Peak

Remarks:

- Emission Level = Read Level + Factor
Margin value = Emission level – Limit value
- 5745 MHz: Fundamental Frequency
- *: Out of Restricted Band
- The emission levels of other frequencies were very low against the limit

EUT Test Condition		Measurement Detail	
Channel	Channel 157	Frequency Range	1 GHz ~ 40 GHz
Input Power	120 Vac, 60 Hz	Detector Function	Peak (PK) Average (AV)
Environmental Conditions	25 deg. C, 65 % RH	Tested By	Thomas Wei

**<Spurious Emission>
Horizontal**

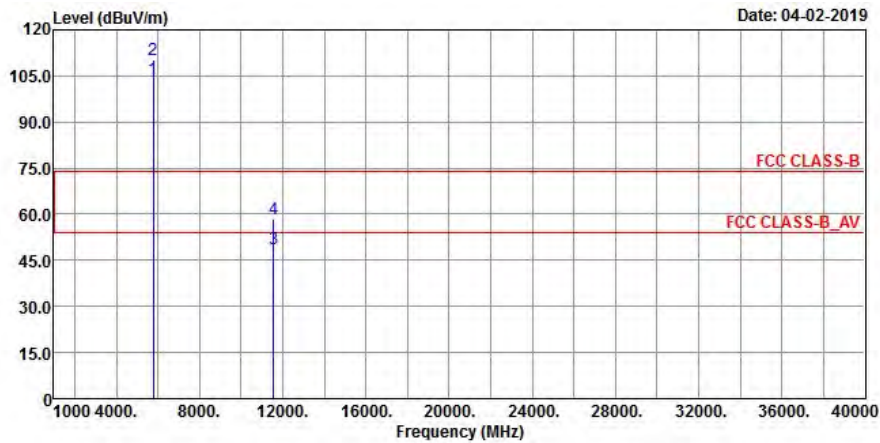

Vertical

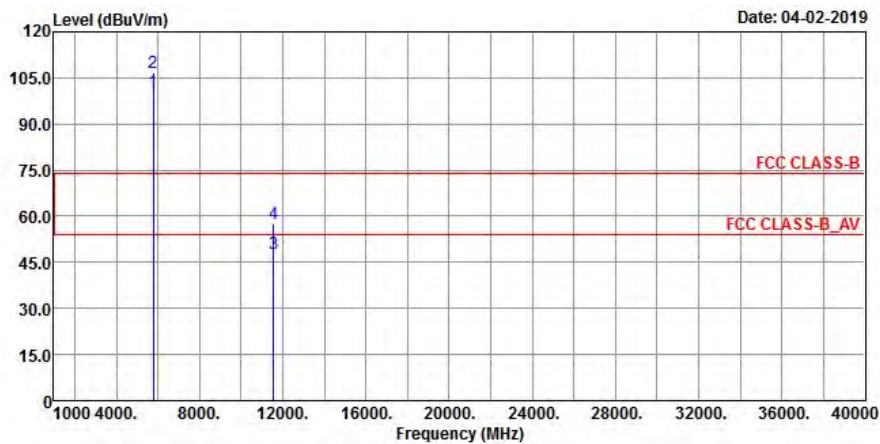

**<Out of Band Emission (OOBE)>
Horizontal**

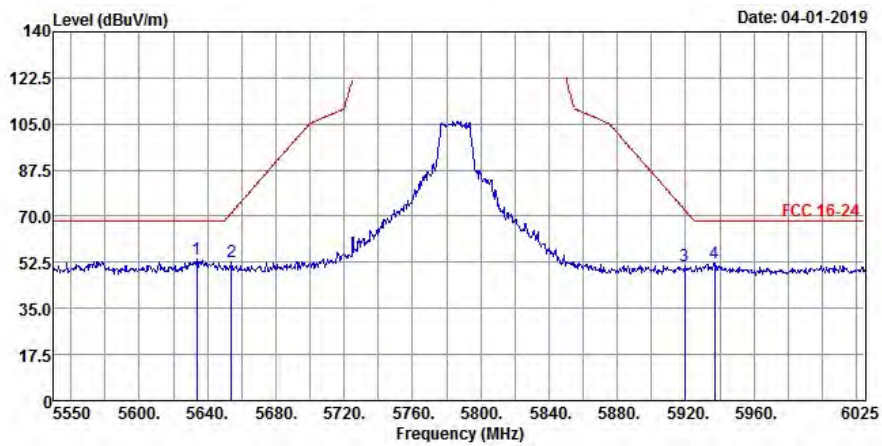

Vertical

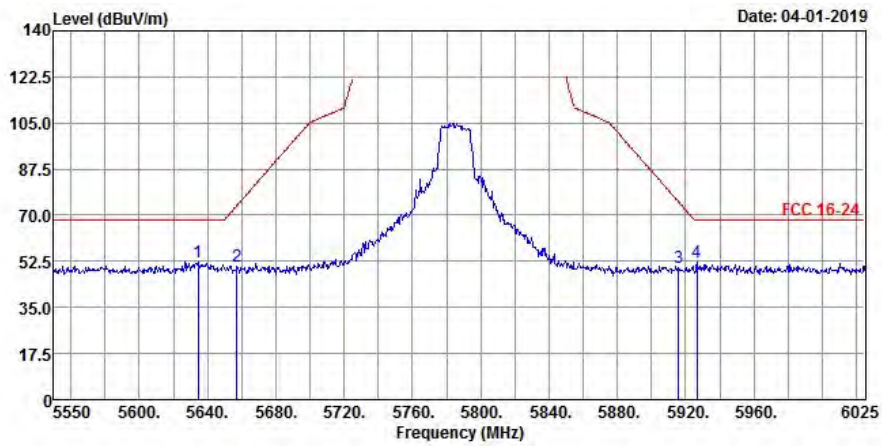

<Spurious Emission>

Antenna Polarity & Test Distance: Horizontal at 3 m								
Frequency (MHz)	Emission Level (dBuV/m)	Read Level (dBuV)	Factor (dB/m)	Limit (dBuV/m)	Margin (dB)	Antenna Height (cm)	Table Angle (Degree)	Remark
5785	104.06	102.14	1.92			182	7	Average
5785	110.39	108.47	1.92			182	7	Peak
11570	48.52	50.72	-2.2	54	-5.48	126	263	Average
11570	58.54	60.74	-2.2	74	-15.46	126	263	Peak
Antenna Polarity & Test Distance: Vertical at 3 m								
Frequency (MHz)	Emission Level (dBuV/m)	Read Level (dBuV)	Factor (dB/m)	Limit (dBuV/m)	Margin (dB)	Antenna Height (cm)	Table Angle (Degree)	Remark
5785	100.71	98.79	1.92			191	104	Average
5785	106.52	104.6	1.92			191	104	Peak
11570	47.66	49.86	-2.2	54	-6.34	126	317	Average
11570	57.6	59.8	-2.2	74	-16.4	126	317	Peak

<Out of Band Emission (OOBE)>

Antenna Polarity & Test Distance: Horizontal at 3 m								
Frequency (MHz)	Emission Level (dBuV/m)	Read Level (dBuV)	Factor (dB/m)	Limit (dBuV/m)	Margin (dB)	Antenna Height (cm)	Table Angle (Degree)	Remark
5633.6	53.61	51.73	1.88	68.2	-14.59	182	7	Peak
5654.025	52.62	50.77	1.85	71.19	-18.57	182	7	Peak
5919.55	51.11	48.8	2.31	72.22	-21.11	182	7	Peak
5937.125	52.08	49.78	2.3	68.2	-16.12	182	7	Peak
Antenna Polarity & Test Distance: Vertical at 3 m								
Frequency (MHz)	Emission Level (dBuV/m)	Read Level (dBuV)	Factor (dB/m)	Limit (dBuV/m)	Margin (dB)	Antenna Height (cm)	Table Angle (Degree)	Remark
5634.55	51.97	50.09	1.88	68.2	-16.23	191	104	Peak
5657.35	50.73	48.88	1.85	73.66	-22.93	191	104	Peak
5915.75	50.18	47.87	2.31	75.02	-24.84	191	104	Peak
5926.675	52.38	50.08	2.3	68.2	-15.82	191	104	Peak

Remarks:

1. Emission Level = Read Level + Factor
Margin value = Emission level – Limit value
2. 5785 MHz: Fundamental Frequency
3. *: Out of Restricted Band
4. The emission levels of other frequencies were very low against the limit

EUT Test Condition		Measurement Detail	
Channel	Channel 165	Frequency Range	1 GHz ~ 40 GHz
Input Power	120 Vac, 60 Hz	Detector Function	Peak (PK) Average (AV)
Environmental Conditions	25 deg. C, 65 % RH	Tested By	Thomas Wei

**<Spurious Emission>
Horizontal**

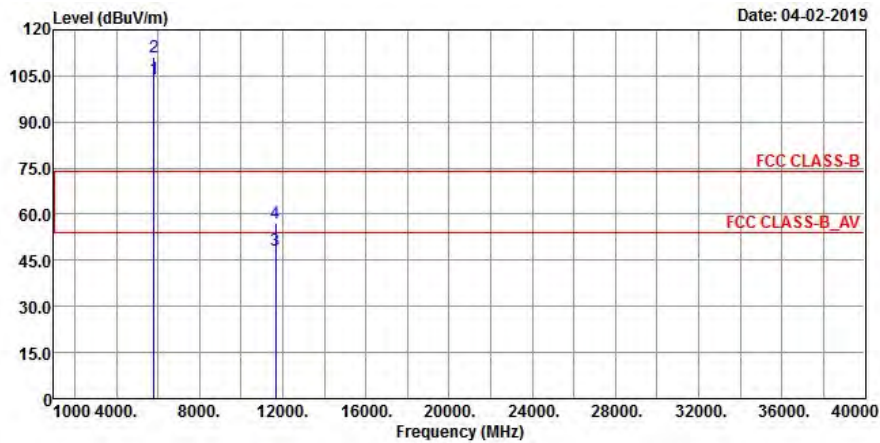

Vertical

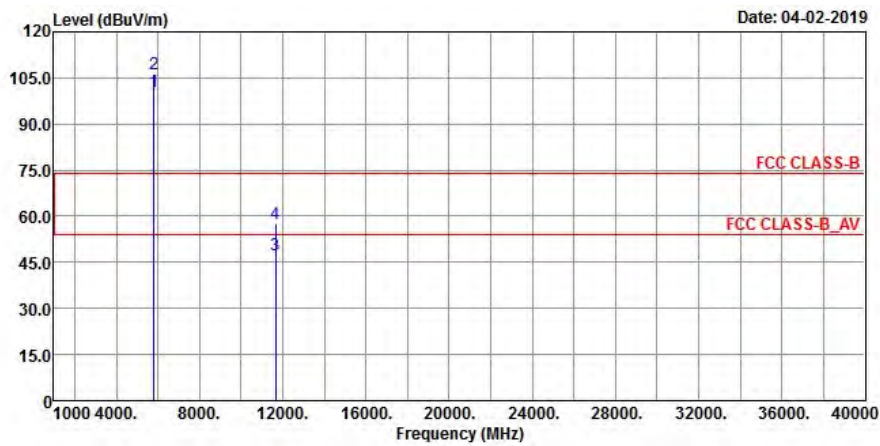

**<Out of Band Emission (OOBE)>
Horizontal**

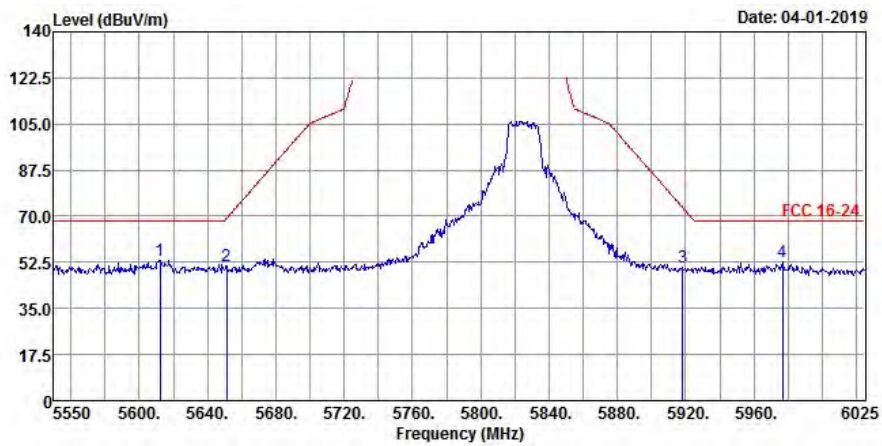

Vertical

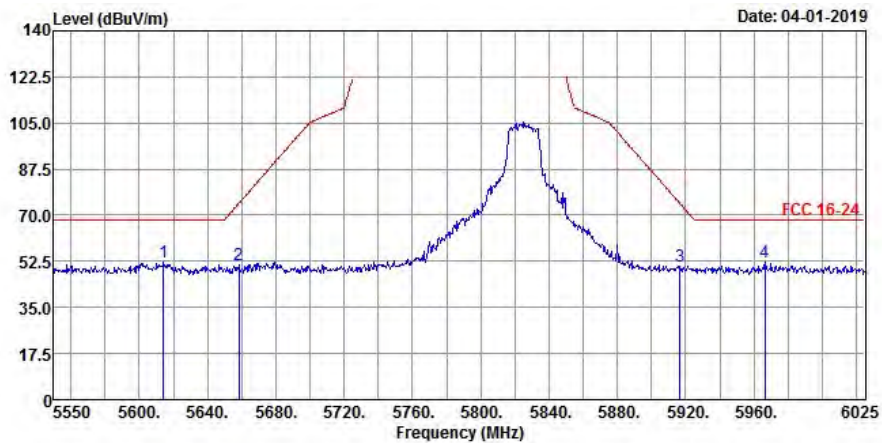

<Spurious Emission>

Antenna Polarity & Test Distance: Horizontal at 3 m								
Frequency (MHz)	Emission Level (dBuV/m)	Read Level (dBuV)	Factor (dB/m)	Limit (dBuV/m)	Margin (dB)	Antenna Height (cm)	Table Angle (Degree)	Remark
5825	103.92	101.84	2.08			163	8	Average
5825	111.06	108.98	2.08			163	8	Peak
11650	48.27	50.66	-2.39	54	-5.73	128	256	Average
11650	57.32	59.71	-2.39	74	-16.68	128	256	Peak
Antenna Polarity & Test Distance: Vertical at 3 m								
Frequency (MHz)	Emission Level (dBuV/m)	Read Level (dBuV)	Factor (dB/m)	Limit (dBuV/m)	Margin (dB)	Antenna Height (cm)	Table Angle (Degree)	Remark
5825	100.46	98.38	2.08			187	99	Average
5825	106.49	104.41	2.08			187	99	Peak
11650	47.45	49.84	-2.39	54	-6.55	126	330	Average
11650	57.71	60.1	-2.39	74	-16.29	126	330	Peak

<Out of Band Emission (OOBE)>

Antenna Polarity & Test Distance: Horizontal at 3 m								
Frequency (MHz)	Emission Level (dBuV/m)	Read Level (dBuV)	Factor (dB/m)	Limit (dBuV/m)	Margin (dB)	Antenna Height (cm)	Table Angle (Degree)	Remark
5612.225	53.46	51.59	1.87	68.2	-14.74	163	8	Peak
5651.175	51.18	49.27	1.91	69.07	-17.89	163	8	Peak
5918.125	50.6	48.29	2.31	73.27	-22.67	163	8	Peak
5976.55	52.52	50.19	2.33	68.2	-15.68	163	8	Peak
Antenna Polarity & Test Distance: Vertical at 3 m								
Frequency (MHz)	Emission Level (dBuV/m)	Read Level (dBuV)	Factor (dB/m)	Limit (dBuV/m)	Margin (dB)	Antenna Height (cm)	Table Angle (Degree)	Remark
5614.125	52.18	50.31	1.87	68.2	-16.02	187	99	Peak
5658.3	51.01	49.16	1.85	74.36	-23.35	187	99	Peak
5916.7	50.65	48.34	2.31	74.32	-23.67	187	99	Peak
5966.575	52.35	50.05	2.3	68.2	-15.85	187	99	Peak

Remarks:

1. Emission Level = Read Level + Factor
Margin value = Emission level – Limit value
2. 5825 MHz: Fundamental Frequency
3. *: Out of Restricted Band
4. The emission levels of other frequencies were very low against the limit

802.11n (HT40)

EUT Test Condition		Measurement Detail	
Channel	Channel 38	Frequency Range	1 GHz ~ 40 GHz
Input Power	120 Vac, 60 Hz	Detector Function	Peak (PK) Average (AV)
Environmental Conditions	25 deg. C, 65 % RH	Tested By	Tim Chen

Horizontal

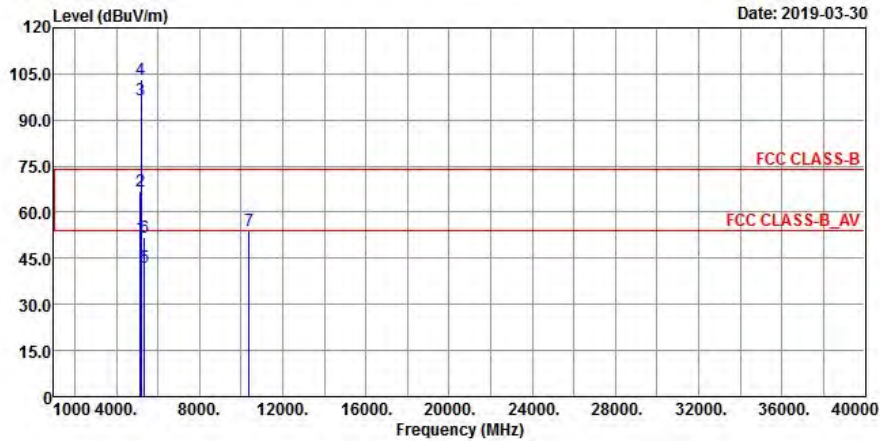

Vertical

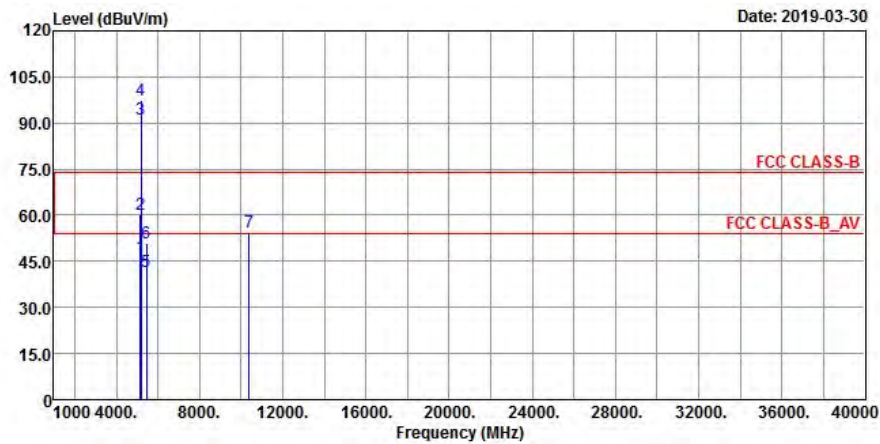

Antenna Polarity & Test Distance: Horizontal at 3 m

Frequency (MHz)	Emission Level (dBuV/m)	Read Level (dBuV)	Factor (dB/m)	Limit (dBuV/m)	Margin (dB)	Antenna Height (cm)	Table Angle (Degree)	Remark
5148.35	51.9	50.37	1.53	54	-2.1	215	341	Average
5148.35	66.95	65.42	1.53	74	-7.05	215	341	Peak
5190	96.52	94.99	1.53			215	341	Average
5190	103.1	101.57	1.53			215	341	Peak
5353.41	41.9	40.44	1.46	54	-12.1	215	341	Average
5353.41	51.78	50.32	1.46	74	-22.22	215	341	Peak
*10380	54.24	57.11	-2.87	68.2	-13.96	131	241	Peak

Antenna Polarity & Test Distance: Vertical at 3 m

Frequency (MHz)	Emission Level (dBuV/m)	Read Level (dBuV)	Factor (dB/m)	Limit (dBuV/m)	Margin (dB)	Antenna Height (cm)	Table Angle (Degree)	Remark
5149.25	46.28	44.75	1.53	54	-7.72	124	312	Average
5149.25	60.27	58.74	1.53	74	-13.73	124	312	Peak
5190	91.02	89.49	1.53			124	312	Average
5190	97.2	95.67	1.53			124	312	Peak
5456.04	41.48	39.61	1.87	54	-12.52	124	312	Average
5456.04	51.07	49.2	1.87	74	-22.93	124	312	Peak
*10380	54.58	57.45	-2.87	68.2	-13.62	167	209	Peak

Remarks:

- Emission Level = Read Level + Factor
Margin value = Emission level – Limit value
- 5190 MHz: Fundamental Frequency
- *: Out of Restricted Band
- The emission levels of other frequencies were very low against the limit

EUT Test Condition		Measurement Detail	
Channel	Channel 46	Frequency Range	1 GHz ~ 40 GHz
Input Power	120 Vac, 60 Hz	Detector Function	Peak (PK) Average (AV)
Environmental Conditions	25 deg. C, 65 % RH	Tested By	Tim Chen

Horizontal

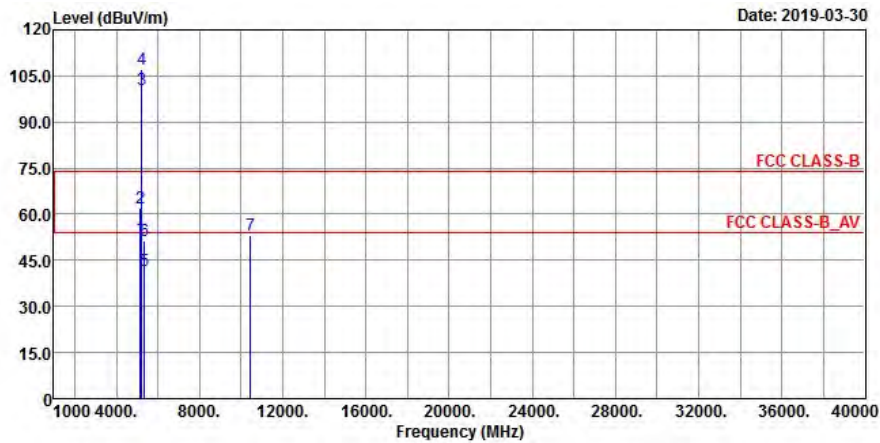

Vertical

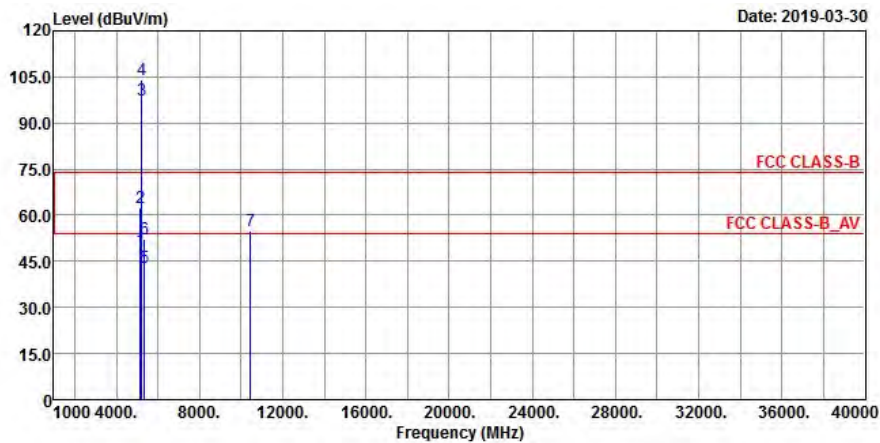

Antenna Polarity & Test Distance: Horizontal at 3 m

Frequency (MHz)	Emission Level (dBuV/m)	Read Level (dBuV)	Factor (dB/m)	Limit (dBuV/m)	Margin (dB)	Antenna Height (cm)	Table Angle (Degree)	Remark
5149.55	52.23	50.7	1.53	54	-1.77	204	342	Average
5149.55	62	60.47	1.53	74	-12	204	342	Peak
5230	100.54	99.16	1.38			204	342	Average
5230	106.99	105.61	1.38			204	342	Peak
5360.89	41.48	39.95	1.53	54	-12.52	204	342	Average
5360.89	51.24	49.71	1.53	74	-22.76	204	342	Peak
*10460	52.92	55.71	-2.79	68.2	-15.28	131	59	Peak

Antenna Polarity & Test Distance: Vertical at 3 m

Frequency (MHz)	Emission Level (dBuV/m)	Read Level (dBuV)	Factor (dB/m)	Limit (dBuV/m)	Margin (dB)	Antenna Height (cm)	Table Angle (Degree)	Remark
5148.65	48.77	47.24	1.53	54	-5.23	205	113	Average
5148.65	62.4	60.87	1.53	74	-11.6	205	113	Peak
5230	97.39	96.01	1.38			205	113	Average
5230	104.24	102.86	1.38			205	113	Peak
5361.99	43.1	41.57	1.53	54	-10.9	205	113	Average
5361.99	52.11	50.58	1.53	74	-21.89	205	113	Peak
*10460	54.95	57.74	-2.79	68.2	-13.25	173	269	Peak

Remarks:

- Emission Level = Read Level + Factor
Margin value = Emission level – Limit value
- 5230 MHz: Fundamental Frequency
- *: Out of Restricted Band
- The emission levels of other frequencies were very low against the limit

EUT Test Condition		Measurement Detail	
Channel	Channel 54	Frequency Range	1 GHz ~ 40 GHz
Input Power	120 Vac, 60 Hz	Detector Function	Peak (PK) Average (AV)
Environmental Conditions	25 deg. C, 65 % RH	Tested By	Tim Chen

Horizontal

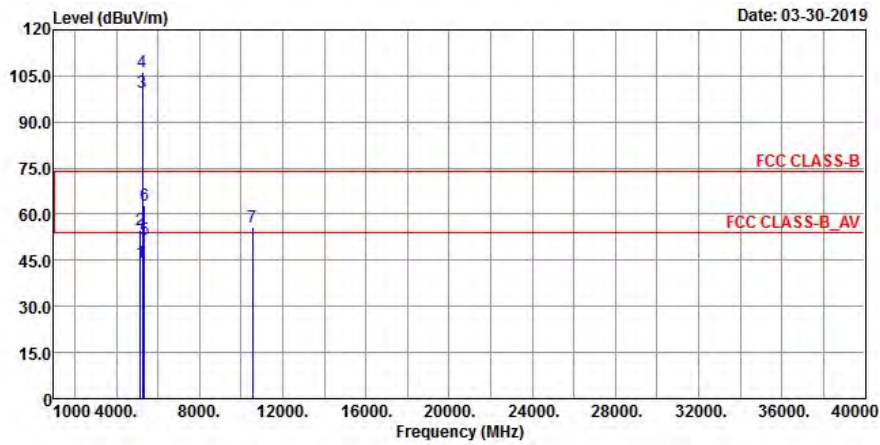

Vertical

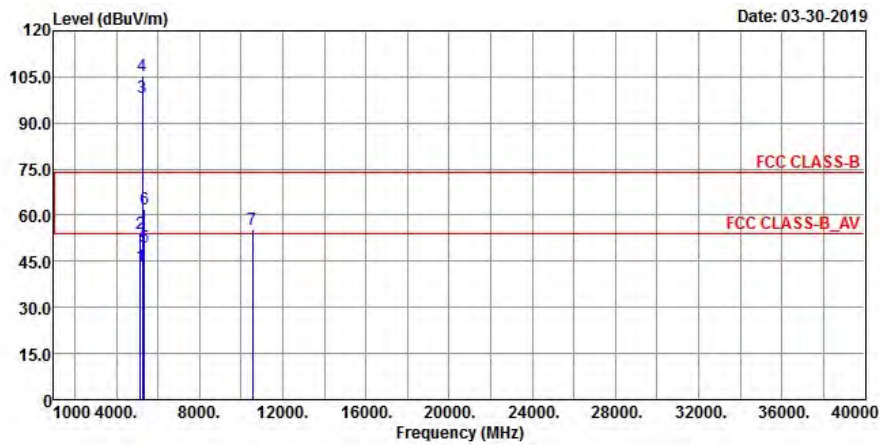

Antenna Polarity & Test Distance: Horizontal at 3 m

Frequency (MHz)	Emission Level (dBuV/m)	Read Level (dBuV)	Factor (dB/m)	Limit (dBuV/m)	Margin (dB)	Antenna Height (cm)	Table Angle (Degree)	Remark
5149.4	44.43	42.9	1.53	54	-9.57	217	344	Average
5149.4	55.03	53.5	1.53	74	-18.97	217	344	Peak
5270	99.73	98.42	1.31			217	344	Average
5270	106.44	105.13	1.31			217	344	Peak
5350.11	51.78	50.32	1.46	54	-2.22	217	344	Average
5350.11	62.69	61.23	1.46	74	-11.31	217	344	Peak
*10540	55.87	58.64	-2.77	68.2	-12.33	141	256	Peak

Antenna Polarity & Test Distance: Vertical at 3 m

Frequency (MHz)	Emission Level (dBuV/m)	Read Level (dBuV)	Factor (dB/m)	Limit (dBuV/m)	Margin (dB)	Antenna Height (cm)	Table Angle (Degree)	Remark
5147.6	43.33	41.8	1.53	54	-10.67	204	110	Average
5147.6	53.85	52.32	1.53	74	-20.15	204	110	Peak
5270	98.31	97	1.31			204	110	Average
5270	105.31	104	1.31			204	110	Peak
5350	49.79	48.33	1.46	54	-4.21	204	110	Average
5350	61.94	60.48	1.46	74	-12.06	204	110	Peak
*10540	55.53	58.3	-2.77	68.2	-12.67	164	113	Peak

Remarks:

- Emission Level = Read Level + Factor
Margin value = Emission level – Limit value
- 5270 MHz: Fundamental Frequency
- *: Out of Restricted Band
- The emission levels of other frequencies were very low against the limit

EUT Test Condition		Measurement Detail	
Channel	Channel 62	Frequency Range	1 GHz ~ 40 GHz
Input Power	120 Vac, 60 Hz	Detector Function	Peak (PK) Average (AV)
Environmental Conditions	25 deg. C, 65 % RH	Tested By	Tim Chen

Horizontal

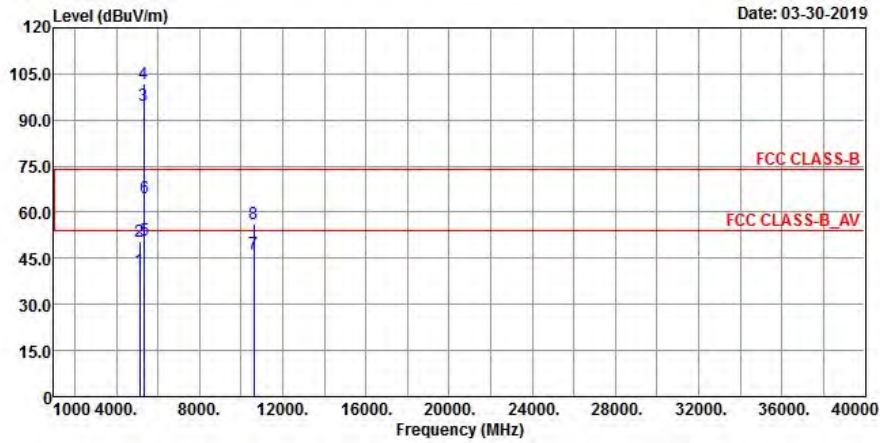

Vertical

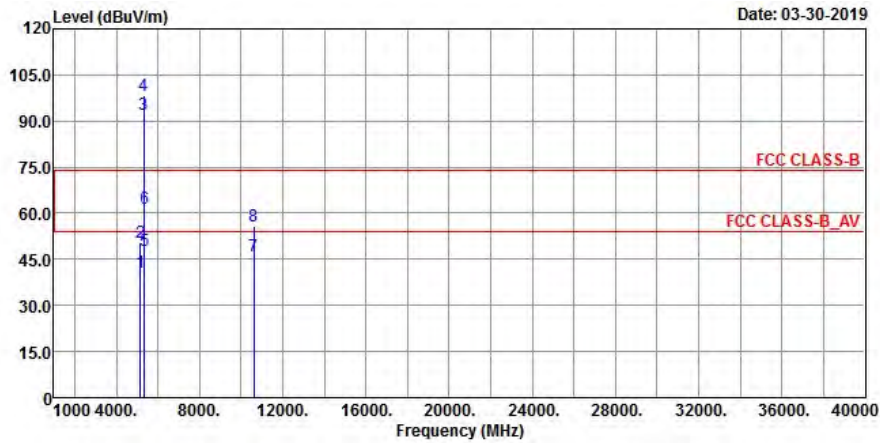

Antenna Polarity & Test Distance: Horizontal at 3 m

Frequency (MHz)	Emission Level (dBuV/m)	Read Level (dBuV)	Factor (dB/m)	Limit (dBuV/m)	Margin (dB)	Antenna Height (cm)	Table Angle (Degree)	Remark
5138.06	41.13	39.64	1.49	54	-12.87	212	346	Average
5138.06	50.49	49	1.49	74	-23.51	212	346	Peak
5310	94.81	93.45	1.36			212	346	Average
5310	101.68	100.32	1.36			212	346	Peak
5350.11	51.03	49.57	1.46	54	-2.97	212	346	Average
5350.11	64.49	63.03	1.46	74	-9.51	212	346	Peak
10620	46.56	49.45	-2.89	54	-7.44	158	261	Average
10620	56.13	59.02	-2.89	74	-17.87	158	261	Peak

Antenna Polarity & Test Distance: Vertical at 3 m

Frequency (MHz)	Emission Level (dBuV/m)	Read Level (dBuV)	Factor (dB/m)	Limit (dBuV/m)	Margin (dB)	Antenna Height (cm)	Table Angle (Degree)	Remark
5149.76	40.88	39.35	1.53	54	-13.12	208	114	Average
5149.76	50.54	49.01	1.53	74	-23.46	208	114	Peak
5310	92.17	90.81	1.36			208	114	Average
5310	98.17	96.81	1.36			208	114	Peak
5350.11	47.96	46.5	1.46	54	-6.04	208	114	Average
5350.11	61.41	59.95	1.46	74	-12.59	208	114	Peak
10620	45.92	48.81	-2.89	54	-8.08	192	103	Average
10620	55.58	58.47	-2.89	74	-18.42	192	103	Peak

Remarks:

- Emission Level = Read Level + Factor
Margin value = Emission level – Limit value
- 5310 MHz: Fundamental Frequency
- *: Out of Restricted Band
- The emission levels of other frequencies were very low against the limit

EUT Test Condition		Measurement Detail	
Channel	Channel 102	Frequency Range	1 GHz ~ 40 GHz
Input Power	120 Vac, 60 Hz	Detector Function	Peak (PK) Average (AV)
Environmental Conditions	25 deg. C, 65 % RH	Tested By	Thomas Wei

Horizontal

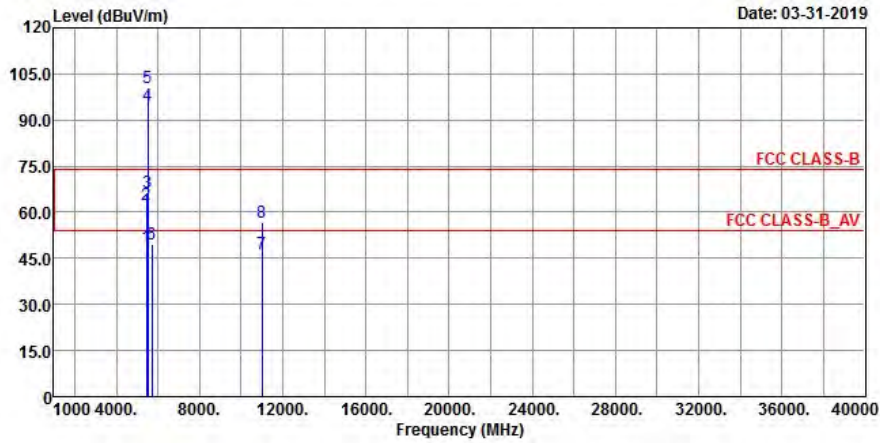

Vertical

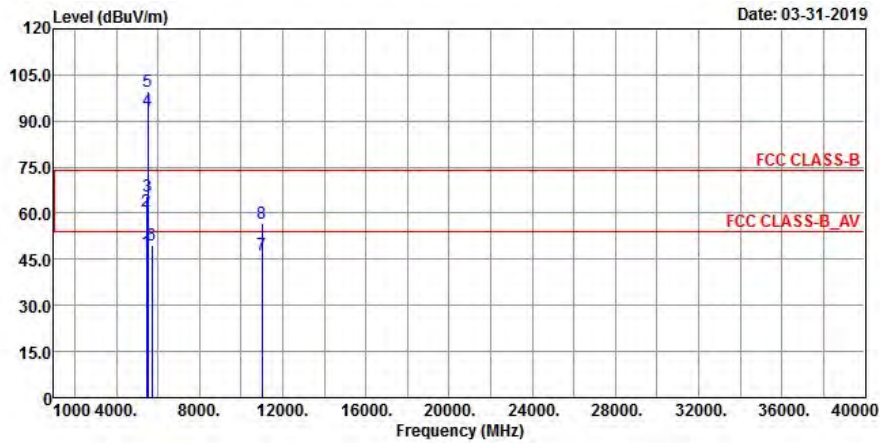

Antenna Polarity & Test Distance: Horizontal at 3 m

Frequency (MHz)	Emission Level (dBuV/m)	Read Level (dBuV)	Factor (dB/m)	Limit (dBuV/m)	Margin (dB)	Antenna Height (cm)	Table Angle (Degree)	Remark
5456.08	48.88	47.01	1.87	54	-5.12	188	342	Average
5456.08	62.47	60.6	1.87	74	-11.53	188	342	Peak
*5470	66.55	64.69	1.86	68.2	-1.65	188	342	Peak
5510	94.75	92.91	1.84			188	342	Average
5510	100.63	98.79	1.84			188	342	Peak
*5725	49.6	47.84	1.76	68.2	-18.6	188	342	Peak
11020	46.32	48.66	-2.34	54	-7.68	150	199	Average
11020	56.67	59.01	-2.34	74	-17.33	150	199	Peak

Antenna Polarity & Test Distance: Vertical at 3 m

Frequency (MHz)	Emission Level (dBuV/m)	Read Level (dBuV)	Factor (dB/m)	Limit (dBuV/m)	Margin (dB)	Antenna Height (cm)	Table Angle (Degree)	Remark
5460	47.25	45.38	1.87	54	-6.75	187	100	Average
5460	60.59	58.72	1.87	74	-13.41	187	100	Peak
*5470	65.48	63.62	1.86	68.2	-2.72	187	100	Peak
5510	93.28	91.44	1.84			187	100	Average
5510	99.52	97.68	1.84			187	100	Peak
*5725	49.72	47.96	1.76	68.2	-18.48	187	100	Peak
11020	46.42	48.76	-2.34	54	-7.58	137	255	Average
11020	56.48	58.82	-2.34	74	-17.52	137	255	Peak

Remarks:

- Emission Level = Read Level + Factor
Margin value = Emission level – Limit value
- 5510 MHz: Fundamental Frequency
- *: Out of Restricted Band
- The emission levels of other frequencies were very low against the limit

EUT Test Condition		Measurement Detail	
Channel	Channel 110	Frequency Range	1 GHz ~ 40 GHz
Input Power	120 Vac, 60 Hz	Detector Function	Peak (PK) Average (AV)
Environmental Conditions	25 deg. C, 65 % RH	Tested By	Thomas Wei

Horizontal

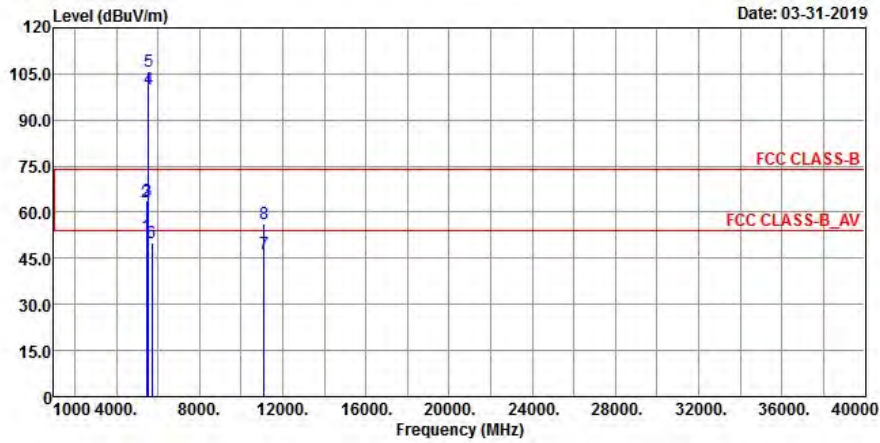

Vertical

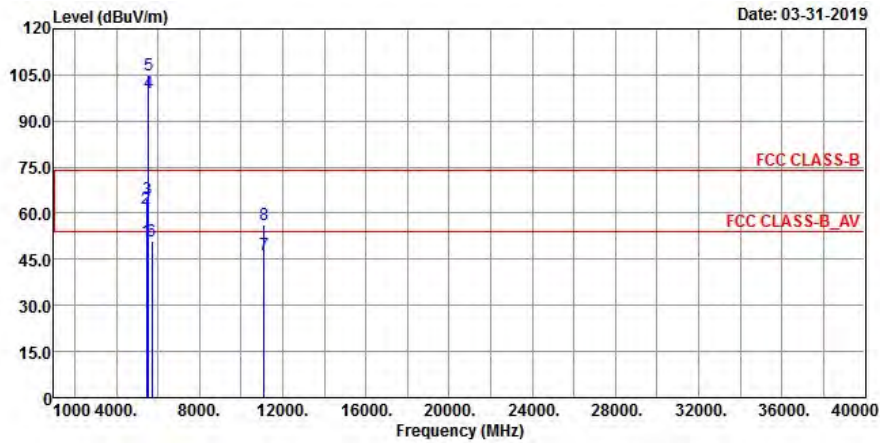

Antenna Polarity & Test Distance: Horizontal at 3 m

Frequency (MHz)	Emission Level (dBuV/m)	Read Level (dBuV)	Factor (dB/m)	Limit (dBuV/m)	Margin (dB)	Antenna Height (cm)	Table Angle (Degree)	Remark
5460	52.11	50.24	1.87	54	-1.89	183	343	Average
5460	63.36	61.49	1.87	74	-10.64	183	343	Peak
*5470	63.68	61.82	1.86	68.2	-4.52	183	343	Peak
5550	99.97	98.14	1.83			183	343	Average
5550	105.84	104.01	1.83			183	343	Peak
*5725	50.11	48.35	1.76	68.2	-18.09	183	343	Peak
11100	46.52	48.98	-2.46	54	-7.48	185	103	Average
11100	56.45	58.91	-2.46	74	-17.55	185	103	Peak

Antenna Polarity & Test Distance: Vertical at 3 m

Frequency (MHz)	Emission Level (dBuV/m)	Read Level (dBuV)	Factor (dB/m)	Limit (dBuV/m)	Margin (dB)	Antenna Height (cm)	Table Angle (Degree)	Remark
5460	50.94	49.07	1.87	54	-3.06	194	99	Average
5460	61.39	59.52	1.87	74	-12.61	194	99	Peak
*5470	64.6	62.74	1.86	68.2	-3.6	194	99	Peak
5550	99.35	97.52	1.83			194	99	Average
5550	105.05	103.22	1.83			194	99	Peak
*5725	51	49.24	1.76	68.2	-17.2	194	99	Peak
11100	46.63	49.09	-2.46	54	-7.37	175	216	Average
11100	56.22	58.68	-2.46	74	-17.78	175	216	Peak

Remarks:

- Emission Level = Read Level + Factor
Margin value = Emission level – Limit value
- 5550 MHz: Fundamental Frequency
- *: Out of Restricted Band
- The emission levels of other frequencies were very low against the limit