

EMC Test Report

Application for FCC Grant of Equipment Authorization Canada Certification

Innovation, Science and Economic Development Canada RSS-Gen Issue 4 / RSS 247 Issue 2 FCC Part 15, Subpart E

Model: H0A

IC CERTIFICATION #: 10395A-H0A
FCC ID: A4RH0A

APPLICANT: Google Inc.
1600 Amphitheatre Pky
Mountain View, CA 94043

TEST SITE(S): National Technical Systems - Silicon Valley
41039 Boyce Road.
Fremont, CA. 94538-2435

IC SITE REGISTRATION #: 2845B-7

REPORT DATE: August 14, 2017

REVISION DATE: August 25, 2017

FINAL TEST DATES: June 28 and 29, July 5, 6, 12, 19, 20 and 21,
2017

TOTAL NUMBER OF PAGES: 134



National Technical Systems - Silicon Valley is accredited by the A2LA, certificate number 0214.26, to perform the test(s) listed in this report, except where noted otherwise. This report and the information contained herein represent the results of testing test articles identified and selected by the client performed to specifications and/or procedures selected by the client. National Technical Systems (NTS) makes no representations, expressed or implied, that such testing is adequate (or inadequate) to demonstrate efficiency, performance, reliability, or any other characteristic of the articles being tested, or similar products. This report should not be relied upon as an endorsement or certification by NTS of the equipment tested, nor does it represent any statement whatsoever as to its merchantability or fitness of the test article, or similar products, for a particular purpose. This report shall not be reproduced except in full

VALIDATING SIGNATORIES**PROGRAM MGR**

Mark E Hill
Staff Engineer

TECHNICAL REVIEWER:

Mark E Hill
Staff Engineer

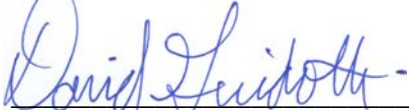
FINAL REPORT PREPARER:

David Guidotti
Senior Technical Writer

QUALITY ASSURANCE DELEGATE

Gary Izard
Technical Writer



REVISION HISTORY

Rev#	Date	Comments	Modified By
-	August 14, 2017	First release	
1.0	August 25, 2017	Removed detailed product information for confidentiality	MEH

TABLE OF CONTENTS

VALIDATING SIGNATORIES	2
REVISION HISTORY	3
TABLE OF CONTENTS	4
SCOPE.....	5
OBJECTIVE	5
STATEMENT OF COMPLIANCE	6
DEVIATIONS FROM THE STANDARDS	6
TEST RESULTS SUMMARY.....	7
UNII / LELAN DEVICES	7
MEASUREMENT UNCERTAINTIES	12
EQUIPMENT UNDER TEST (EUT) DETAILS	13
GENERAL.....	13
ANTENNA SYSTEM.....	13
ENCLOSURE	13
MODIFICATIONS	13
SUPPORT EQUIPMENT	13
EUT INTERFACE PORTS	14
EUT OPERATION	14
TEST SITE.....	15
GENERAL INFORMATION	15
CONDUCTED EMISSIONS CONSIDERATIONS	15
RADIATED EMISSIONS CONSIDERATIONS	15
MEASUREMENT INSTRUMENTATION	16
RECEIVER SYSTEM	16
INSTRUMENT CONTROL COMPUTER	16
LINE IMPEDANCE STABILIZATION NETWORK (LISN)	16
FILTERS/ATTENUATORS.....	17
ANTENNAS	17
ANTENNA MAST AND EQUIPMENT TURNTABLE	17
INSTRUMENT CALIBRATION.....	17
TEST PROCEDURES.....	18
EUT AND CABLE PLACEMENT.....	18
CONDUCTED EMISSIONS	18
RADIATED EMISSIONS	18
CONDUCTED EMISSIONS FROM ANTENNA PORT	22
BANDWIDTH MEASUREMENTS	22
SPECIFICATION LIMITS AND SAMPLE CALCULATIONS	23
CONDUCTED EMISSIONS SPECIFICATION LIMITS: FCC 15.207; FCC 15.107(A), RSS GEN	23
GENERAL TRANSMITTER RADIATED EMISSIONS SPECIFICATION LIMITS	24
FCC 15.407 (A) OUTPUT POWER LIMITS	24
OUTPUT POWER LIMITS –LELAN DEVICES	25
SPURIOUS EMISSIONS LIMITS –UNII AND LELAN DEVICES	25
SAMPLE CALCULATIONS - CONDUCTED EMISSIONS	26
SAMPLE CALCULATIONS - RADIATED EMISSIONS	26
SAMPLE CALCULATIONS - FIELD STRENGTH TO EIRP CONVERSION	27
APPENDIX A TEST EQUIPMENT CALIBRATION DATA.....	28
APPENDIX B TEST DATA.....	31
END OF REPORT.....	134

SCOPE

An electromagnetic emissions test has been performed on the Google Inc. model H0A, pursuant to the following rules:

RSS-Gen Issue 4 “ General Requirements for Compliance of Radio Apparatus”
RSS 247 Issue 2 “Digital Transmission Systems (DTSs), Frequency Hopping Systems (FHSS) and Licence-Exempt Local Area Network (LE-LAN) Devices”
FCC Part 15, Subpart E requirements for UNII Devices

Conducted and radiated emissions data has been collected, reduced, and analyzed within this report in accordance with measurement guidelines set forth in the following reference standards and as outlined in National Technical Systems - Silicon Valley test procedures:

FCC General UNII Test Procedures KDB789033

The intentional radiator above has been tested in a simulated typical installation to demonstrate compliance with the relevant Industry Canada performance and procedural standards.

Final system data was gathered in a mode that tended to maximize emissions by varying orientation of EUT, orientation of power and I/O cabling, antenna search height, and antenna polarization.

Every practical effort was made to perform an impartial test using appropriate test equipment of known calibration. All pertinent factors have been applied to reach the determination of compliance.

OBJECTIVE

The primary objective of the manufacturer is compliance with the regulations outlined in the previous section.

Prior to marketing in the USA, all unlicensed transmitters and transceivers require certification. Receive-only devices operating between 30 MHz and 960 MHz are subject to either certification or a manufacturer’s declaration of conformity, with all other receive-only devices exempt from the technical requirements.

Prior to marketing in Canada, Class I transmitters, receivers and transceivers require certification. Class II devices are required to meet the appropriate technical requirements but are exempt from certification requirements.

Certification is a procedure where the manufacturer submits test data and technical information to a certification body and receives a certificate or grant of equipment authorization upon successful completion of the certification body's review of the submitted documents. Once the equipment authorization has been obtained, the label indicating compliance must be attached to all identical units, which are subsequently manufactured.

Maintenance of compliance is the responsibility of the manufacturer. Any modification of the product which may result in increased emissions should be checked to ensure compliance has been maintained (i.e., printed circuit board layout changes, different line filter, different power supply, harnessing or I/O cable changes, etc.).

STATEMENT OF COMPLIANCE

The tested sample of Google Inc. model H0A complied with the requirements of the following regulations:

RSS 247 Issue 2 "Digital Transmission Systems (DTSs), Frequency Hopping Systems (FHSS) and Licence-Exempt Local Area Network (LE-LAN) Devices"
FCC Part 15, Subpart E requirements for UNII Devices

Maintenance of compliance is the responsibility of the manufacturer. Any modifications to the product should be assessed to determine their potential impact on the compliance status of the device with respect to the standards detailed in this test report.

The test results recorded herein are based on a single type test of Google Inc. model H0A and therefore apply only to the tested sample. The sample was selected and prepared by Dominik Mente of Google Inc..

DEVIATIONS FROM THE STANDARDS

No deviations were made from the published requirements listed in the scope of this report.

TEST RESULTS SUMMARY
UNII / LELAN DEVICES
OPERATION IN THE 5.15 – 5.25 GHZ BAND – MOBILE AND PORTABLE CLIENT DEVICE

FCC Rule Part	RSS Rule Part	Description	Measured Value / Comments	Limit / Requirement	Result
15.407 (a) (1) (iv)		Output Power	a: 15.9dBm (38.9mW) n20:15.9dBm (38.9mW) n40: 15.9dBm (38.9mW) ac80: 9.1dBm (8.1mW) (Max eirp: 92mW)	24 dBm (250 mW)	Complies
15.407 (a) (1) (iv)		Power Spectral Density	a: 3.2dBm/MHz n20: 3.0dBm/MHz n40: -0.5dBm/MHz ac80: -10.5dBm/MHz	11 dBm/MHz	Complies
15.407(b) (1) / 15.209		Spurious Emissions above 1GHz	52.2 dBμV/m @ 5149.9 MHz (-1.8 dB)	Refer to the limits section (p24) for restricted bands, all others -27 dBm/MHz EIRP	Complies

OPERATION IN THE 5.15 – 5.25 GHZ BAND

	RSS Rule Part	Description	Measured Value / Comments	Limit / Requirement	Result
	RSS-247 6.2.1	Indoor operation only	Refer to user's manual	N/A	Complies
	RSS-247 6.2.1.1	99% Bandwidth	a: 17.3MHz n20: 18.4MHz n40: 36.6MHz ac80: 76.2 MHz	N/A – limits output power if < 20MHz	N/A
	RSS-247 6.2.1.1	EIRP Output Power	a: 19.6dBm (91.8mW) n20: 19.6dBm (91.6mW) n40: 19.6dBm (91.6mW) ac80: 12.8dBm (19.2mW)	23 dBm (200 mW)	Complies
	RSS-247 6.2.1.1	Power Spectral Density	a: 6.9dBm/MHz n20: 6.7dBm/MHz n40: 3.2dBm/MHz ac80: -6.8dBm/MHz	10 dBm/MHz	Complies
	RSS-247 6.2.1.2	Spurious Emissions above 1GHz	52.2 dBμV/m @ 5149.9 MHz (-1.8 dB)	Refer to the limits section (p24) for restricted bands, all others -27 dBm/MHz EIRP 26 dBc in 5.25-5.35 GHz band	Complies

OPERATION IN THE 5.25 – 5.35 GHZ BAND

FCC Rule Part	RSS Rule Part	Description	Measured Value / Comments	Limit / Requirement	Result (margin)
15.407(a) (2)		26dB Bandwidth	> 20MHz for all modes	N/A – limits output power if < 20MHz	N/A
	RSS-247 6.2.2.1	99% Bandwidth	a: 17.3MHz n20: 18.4MHz n40: 36.6MHz ac80: 76.2MHz	N/A – limits power if < 20MHz	N/A
15.407(a) (2)	RSS-247 6.2.2.1	Output Power	a: 15.8dBm (38.0mW) n20: 15.8dBm (38.0mW) n40: 15.6dBm (36.3mW) ac80: 9.8dBm (9.5mW) (Max eirp: 19.5dBm (89.7mW))	24 dBm (250 mW) EIRP <= 1W	Complies
15.407(a) (2)	RSS-247 6.2.2.1	Power Spectral Density	a: 2.9dBm/MHz n20: 2.6dBm/MHz n40: -0.3dBm/MHz ac80: -9.5dBm/MHz	11 dBm/MHz	Complies
15.407(b) (2) / 15.209	RSS-247 6.2.2.2	Spurious Emissions above 1GHz	52.1 dBμV/m @ 5363.7 MHz (-1.9 dB)	Refer to the limits section (p24) for restricted bands, all others -27 dBm/MHz EIRP	Complies
-	RSS-247 6.2.2.3	EIRP Above Horizon	-	Depends on angle	N/A

OPERATION IN THE 5.47 – 5.725 GHZ BAND

FCC Rule Part	RSS Rule Part	Description	Measured Value / Comments	Limit / Requirement	Result (margin)
15.407(a) (2)		26dB Bandwidth	> 20MHz for all modes	N/A – limits output power if < 20MHz	N/A
	RSS-247 6.2.3.1	99% Bandwidth	a: 17.4MHz n20: 18.4MHz n40: 36.7MHz ac80: 76.2MHz	N/A – limits power if < 20MHz	N/A
15.407(a) (2)		Output Power	a: 16.0dBm (40.1mW) n20: 16.1dBm (40.9mW) n40: 16.0dBm (40.0mW) ac80: 16.0dBm (40.1mW) (Max eirp: 19.8dBm (95.9mW))	24 dBm (250 mW) EIRP <= 1W	Complies
	RSS-247 6.2.3.1	Output Power	a: 16.0dBm (40.1mW) n20: 16.1dBm (40.9mW) n40: 16.0dBm (40.0mW) ac80: 10.7dBm (11.8mW) (Max eirp: 19.8dBm (95.9mW))	24 dBm (250 mW) EIRP <= 1W	Complies
15.407(a) (2)	RSS-247 6.2.3.1	Power Spectral Density	a: 2.5dBm/MHz n20: 3.0dBm/MHz n40: -0.2dBm/MHz ac80: -3.6dBm/MHz	11 dBm/MHz	Complies
15.407(b) (3) / 15.209	RSS-247 6.2.3.2	Spurious Emissions above 1GHz	52.4 dBμV/m @ 5725.2 MHz (-1.6 dB)	Refer to the limits section (p24) for restricted bands, all others -27 dBm/MHz EIRP	Complies
	RSS-247 6.2.3.2	Non-operation in 5600 – 5650 MHz sub band	Device cannot operate in the 5600 – 5650 MHz band –refer to Operational Description		Complies

OPERATION IN THE 5.725 – 5.85 GHZ BAND

FCC Rule Part	RSS Rule Part	Description	Measured Value / Comments	Limit / Requirement	Result (margin)
15.407(e)	RSS-247 6.2.4.1	6dB Bandwidth	>16MHz for all modes	<= 500 kHz	Complies
15.407(a) (3)	RSS-247 6.2.4.1	Output Power (multipoint systems)	a: 18.8dBm (76.3mW) n20: 18.7dBm (74.4mW) n40: 17.8dBm (60.7mW) ac80: 14.8dBm (30.4mW) (Max eirp: 22.5dBm (178.9mW))	30 dBm (1 W) EIRP <= 4W	Complies
15.407(a) (3)	RSS-247 6.2.4.1	Power Spectral Density	a: 6.4dBm/MHz n20: 5.7dBm/MHz n40: 2.5dBm/MHz ac80: -0.3dBm/MHz	30 dBm / 500 kHz	Complies
15.407(b) (4) / 15.209	RSS-247 6.2.4.2	Spurious Emissions above 1GHz	66.6 dBμV/m @ 5644.7 MHz (-1.7 dB)	Refer to the limits section (p24) for restricted bands, all others -17 dBm/MHz EIRP bandedge and -27 dBm/MHz EIRP	Complies

REQUIREMENTS FOR ALL U-NII/LELAN BANDS

FCC Rule Part	RSS Rule Part	Description	Measured Value / Comments	Limit / Requirement	Result
15.407	RSS-247 6.1	Modulation	Digital Modulation is used	Digital modulation is required	Complies
15.31 (m)	RSS-247 6.4.1 RSS-Gen 6.8	Channel Selection	Emissions tested at outermost and middle channels in each band	Device was tested on the top, bottom and center channels in each band	N/A
15.407 (c)	RSS-247 6.4.2	Operation in the absence of information to transmit	Operation is discontinued in the absence of information	Device shall automatically discontinue operation in the absence of information to transmit	Complies
15.407 (g)		Frequency Stability	Refer to results	Signal shall remain within the allocated band	Complies
15.407 (h1)	RSS-247 6.2.2 (1) 6.2.3 (1)	Transmit Power Control	TPC is not required as the device operates at below 500mW eirp	The U-NII device shall have the capability to operate with a mean EIRP value lower than 24dBm (250mW)	Complies
15.407 (h2)	RSS-247 6.3	Dynamic frequency Selection (device without radar detection)	Refer to separate test report, reference R105539	Channel move time < 10s Channel closing transmission time < 260ms	Complies
	RSS-247 6.4.5	User manual information	Refer to manual for details	Warning regarding Tilt angle for EIRP compliance, Indoor use for 5150-5250 MHz band and Radar are primary user of some bands	Complies

GENERAL REQUIREMENTS APPLICABLE TO ALL BANDS

FCC Rule Part	RSS Rule part	Description	Measured Value / Comments	Limit / Requirement	Result (margin)
15.203	-	RF Connector	Antennas are internal	Unique or integral antenna required	Complies
15.407 (b) (6)	RSS-Gen Table 3	AC Conducted Emissions	27.7 dBμV @ 0.823 MHz (-18.3 dB)	Refer to page 23	Complies
15.247 (i) 15.407 (f)	RSS 102	RF Exposure Requirements	Refer to MPE calculations in separate exhibit, RSS 102 declaration and User Manual statements.	Refer to OET 65, FCC Part 1 and RSS 102	Complies

MEASUREMENT UNCERTAINTIES

ISO/IEC 17025 requires that an estimate of the measurement uncertainties associated with the emissions test results be included in the report. The measurement uncertainties given below are based on a 95% confidence level and were calculated in accordance with UKAS document LAB 34.

Measurement Type	Measurement Unit	Frequency Range	Expanded Uncertainty
RF power, conducted (power meter)	dBm	25 to 7000 MHz	± 0.52 dB
RF power, conducted (Spectrum analyzer)	dBm	25 to 7000 MHz	± 0.7 dB
Conducted emission of transmitter	dBm	25 to 26500 MHz	± 0.7 dB
Conducted emission of receiver	dBm	25 to 26500 MHz	± 0.7 dB
Radiated emission (substitution method)	dBm	25 to 26500 MHz	± 2.5 dB
Radiated emission (field strength)	dB μ V/m	25 to 1000 MHz	± 3.6 dB
		1000 to 40000 MHz	± 6.0 dB
Conducted Emissions (AC Power)	dB μ V	0.15 to 30 MHz	± 2.4 dB

EQUIPMENT UNDER TEST (EUT) DETAILS

GENERAL

The Google Inc. model H0A is an interactive media streaming device. Since the EUT would be placed on a tabletop during operation, the EUT was treated as tabletop equipment during testing to simulate the end-user environment. The electrical rating of the EUT is 100-240 Volts, 50-60Hz Hz, 0.4 Amps.

The sample was received on June 28, 2017 and tested on June 28 and 29, July 5, 6, 12, 19, 20 and 21, 2017. The EUT consisted of the following component(s):

Company	Model	Description	Serial Number	FCC ID
Google	H0A	Streaming Media Device (RF Radiated and AC Conducted)	Prototype Sample #2	A4RH0A
Google	H0A	Streaming Media Device (RF Conducted)	Prototype Sample #1	A4RH0A
Chicony	W17-009N1X	AC-DC Adapter	N/A	N/A

ANTENNA SYSTEM

Two internal antennas: 4.0dBi and 3.4dBi @ 2.4GHz, 3.7dBi and 3.5dBi @ 5GHz
Tx/Rx diversity

ENCLOSURE

The EUT enclosure is primarily constructed of uncoated plastic.

MODIFICATIONS

No modifications were made to the EUT during the time the product was at NTS Silicon Valley.

SUPPORT EQUIPMENT

The following equipment was used as support equipment for testing:

Company	Model	Description	Serial Number	FCC ID
Dell	Latitude	Laptop	-	-
-	-	Laptop Power Supply	-	-

Note: The laptop was used to configure the radio operation and then was removed from the setup.

EUT INTERFACE PORTS

The I/O cabling configuration during testing was as follows:

Port	Connected To	Description	Cable(s)	
			Shielded or Unshielded	Length(m)
EUT DC Power	External Power Supply	Multiwire	Shielded	2
AC In (external supply)	AC Mains	Direct plug in	-	-
USB	USB splitter	Multiwire	Shielded	0.3

EUT OPERATION

The EUT was configured to transmit continuously at the maximum output power setting. Specifics for the channel and mode are described in the test data.

TEST SITE

GENERAL INFORMATION

Final test measurements were taken at the test sites listed below. Pursuant to section 2.948 of the FCC's Rules and section 3.3 of RSP-100, construction, calibration, and equipment data has been filed with the Commission and with industry Canada.

Site	Designation / Registration Numbers		Location
	FCC	Canada	
Chamber 4	US0027	2845B-4	41039 Boyce Road Fremont, CA 94538-2435
Chamber 7	US0027	2845B-7	

ANSI C63.4 recommends that ambient noise at the test site be at least 6 dB below the allowable limits. Ambient levels are below this requirement. The test site(s) contain separate areas for radiated and conducted emissions testing. Considerable engineering effort has been expended to ensure that the facilities conform to all pertinent requirements of ANSI C63.4.

CONDUCTED EMISSIONS CONSIDERATIONS

Conducted emissions testing is performed in conformance with ANSI C63.10. Measurements are made with the EUT connected to the public power network through a nominal, standardized RF impedance, which is provided by a line impedance stabilization network, known as a LISN. A LISN is inserted in series with each current-carrying conductor in the EUT power cord.

RADIATED EMISSIONS CONSIDERATIONS

The FCC has determined that radiation measurements made in a shielded enclosure are not suitable for determining levels of radiated emissions. Radiated measurements are performed in an open field environment or in a semi-anechoic chamber. The test sites are maintained free of conductive objects within the CISPR defined elliptical area incorporated in ANSI C63.4 guidelines and meet the Normalized Site Attenuation (NSA) requirements of ANSI C63.4.

MEASUREMENT INSTRUMENTATION

RECEIVER SYSTEM

An EMI receiver as specified in CISPR 16-1-1 is used for emissions measurements. The receivers used can measure over the frequency range of 9 kHz up to 2000 MHz. These receivers allow both ease of measurement and high accuracy to be achieved. The receivers have Peak, Average, and CISPR (Quasi-peak) detectors built into their design so no external adapters are necessary. The receiver automatically sets the required bandwidth for the CISPR detector used during measurements. If the repetition frequency of the signal being measured is below 20Hz, peak measurements are made in lieu of Quasi-Peak measurements.

For measurements above the frequency range of the receivers, a spectrum analyzer is utilized because it provides visibility of the entire spectrum along with the precision and versatility required to support engineering analysis. Average measurements above 1000MHz are performed on the spectrum analyzer using the linear-average method with a resolution bandwidth of 1 MHz and a video bandwidth of 10 Hz, unless the signal is pulsed in which case the average (or video) bandwidth of the measuring instrument is reduced to onset of pulse desensitization and then increased.

INSTRUMENT CONTROL COMPUTER

Software is used to view and convert receiver measurements to the field strength at an antenna or voltage developed at the LISN measurement port, which is then compared directly with the appropriate specification limit. This provides faster, more accurate readings by performing the conversions described under Sample Calculations within the Test Procedures section of this report. Results are printed in a graphic and/or tabular format, as appropriate. A personal computer is used to record all measurements made with the receivers. The software used for radiated and conducted emissions measurements is NTS EMI Test Software (rev 2.10)

LINE IMPEDANCE STABILIZATION NETWORK (LISN)

Line conducted measurements utilize a fifty microhenry Line Impedance Stabilization Network as the monitoring point. The LISN used also contains a 250 uH CISPR adapter. This network provides for calibrated radio frequency noise measurements by the design of the internal low pass and high pass filters on the EUT and measurement ports, respectively.

FILTERS/ATTENUATORS

External filters and precision attenuators are often connected between the receiving antenna or LISN and the receiver. This eliminates saturation effects and non-linear operation due to high amplitude transient events.

ANTENNAS

A loop antenna is used below 30 MHz. For the measurement range 30 MHz to 1000 MHz either a combination of a biconical antenna and a log periodic or a bi-log antenna is used. Above 1000 MHz, horn antennas are used. The antenna calibration factors to convert the received voltage to an electric field strength are included with appropriate cable loss and amplifier gain factors to determine an overall site factor, which is then programmed into the test receivers or incorporated into the test software.

ANTENNA MAST AND EQUIPMENT TURNTABLE

The antennas used to measure the radiated electric field strength are mounted on a non-conductive antenna mast equipped with a motor-drive to vary the antenna height. Measurements below 30 MHz are made with the loop antenna at a fixed height of 1m above the ground plane.

ANSI C63.10 specifies that the test height above ground for table mounted devices shall be 80 centimeters for measurements below 1GHz and 1.5m for measurements above 1GHz. Floor mounted equipment shall be placed on the ground plane if the device is normally used on a conductive floor or separated from the ground plane by insulating material from 3 to 12 mm if the device is normally used on a non-conductive floor as specified in ANSI C63.4. During radiated measurements, the EUT is positioned on a motorized turntable in conformance with this requirement.

INSTRUMENT CALIBRATION

All test equipment is regularly checked to ensure that performance is maintained in accordance with the manufacturer's specifications. All antennas are calibrated at regular intervals with respect to tuned half-wave dipoles. An exhibit of this report contains the list of test equipment used and calibration information.

TEST PROCEDURES

EUT AND CABLE PLACEMENT

The regulations require that interconnecting cables be connected to the available ports of the unit and that the placement of the unit and the attached cables simulate the worst case orientation that can be expected from a typical installation, so far as practicable. To this end, the position of the unit and associated cabling is varied within the guidelines of ANSI C63.10, and the worst-case orientation is used for final measurements.

CONDUCTED EMISSIONS

Conducted emissions are measured at the plug end of the power cord supplied with the EUT. Excess power cord length is wrapped in a bundle between 30 and 40 centimeters in length near the center of the cord. Preliminary measurements are made to determine the highest amplitude emission relative to the specification limit for all the modes of operation. Placement of system components and varying of cable positions are performed in each mode. A final peak mode scan is then performed in the position and mode for which the highest emission was noted on all current carrying conductors of the power cord.

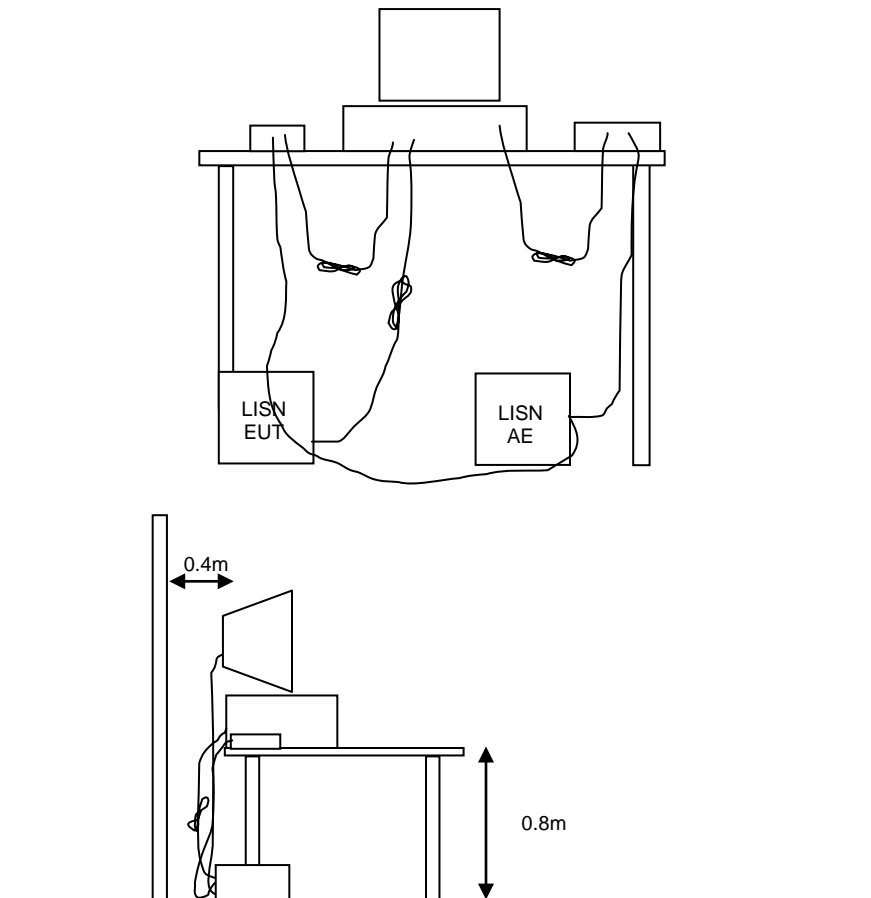

Figure 1 Typical Conducted Emissions Test Configuration

RADIATED EMISSIONS

A preliminary scan of the radiated emissions is performed in which all significant EUT frequencies are identified with the system in a nominal configuration. At least two scans are performed, one scan for each antenna polarization (horizontal and vertical; loop parallel and perpendicular to the EUT). During the preliminary scans, the EUT is rotated through 360°, the antenna height is varied (for measurements above 30 MHz) and cable positions are varied to determine the highest emission relative to the limit. Preliminary scans may be performed in a fully anechoic chamber for the purposes of identifying the frequencies of the highest emissions from the EUT.

A speaker is provided in the receiver to aid in discriminating between EUT and ambient emissions. Other methods used during the preliminary scan for EUT emissions involve scanning with near field magnetic loops, monitoring I/O cables with RF current clamps, and cycling power to the EUT.

Final maximization is a phase in which the highest amplitude emissions identified in the spectral search are viewed while the EUT azimuth angle is varied from 0 to 360 degrees relative to the receiving antenna. The azimuth, which results in the highest emission is then maintained while varying the antenna height from one to four meters (for measurements above 30 MHz, measurements below 30 MHz are made with the loop antenna at a fixed height of 1m). The result is the identification of the highest amplitude for each of the highest peaks. Each recorded level is corrected in the receiver using appropriate factors for cables, connectors, antennas, and preamplifier gain.

When testing above 18 GHz, the receive antenna is located at 1meter from the EUT and the antenna height is restricted to a maximum of 2.5 meters.

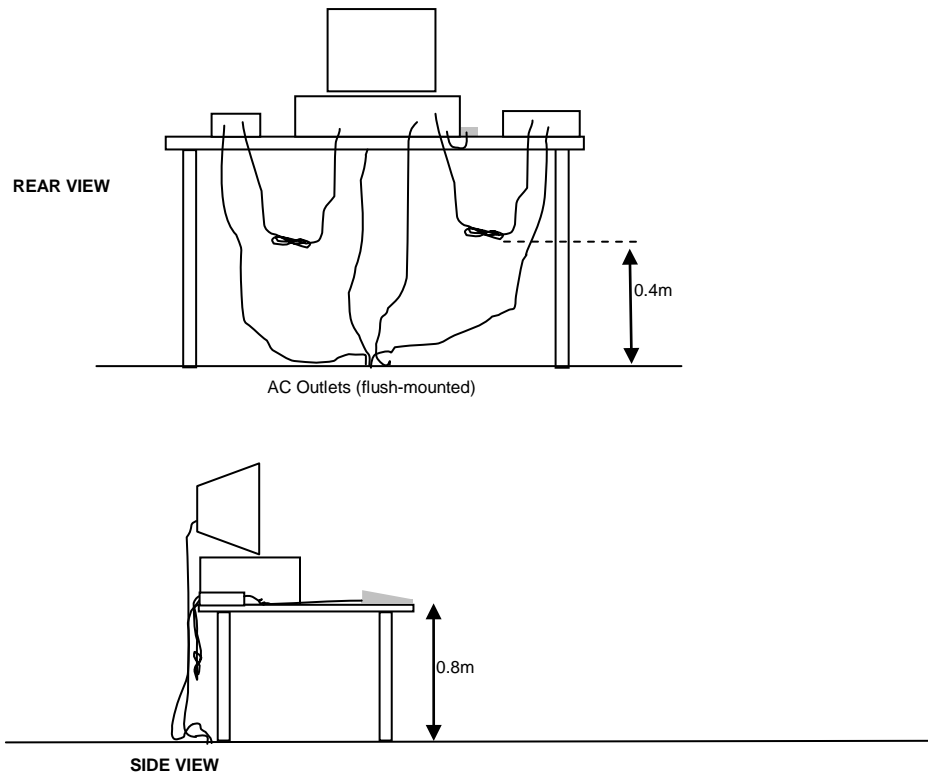

Typical Test Configuration for Radiated Field Strength Measurements

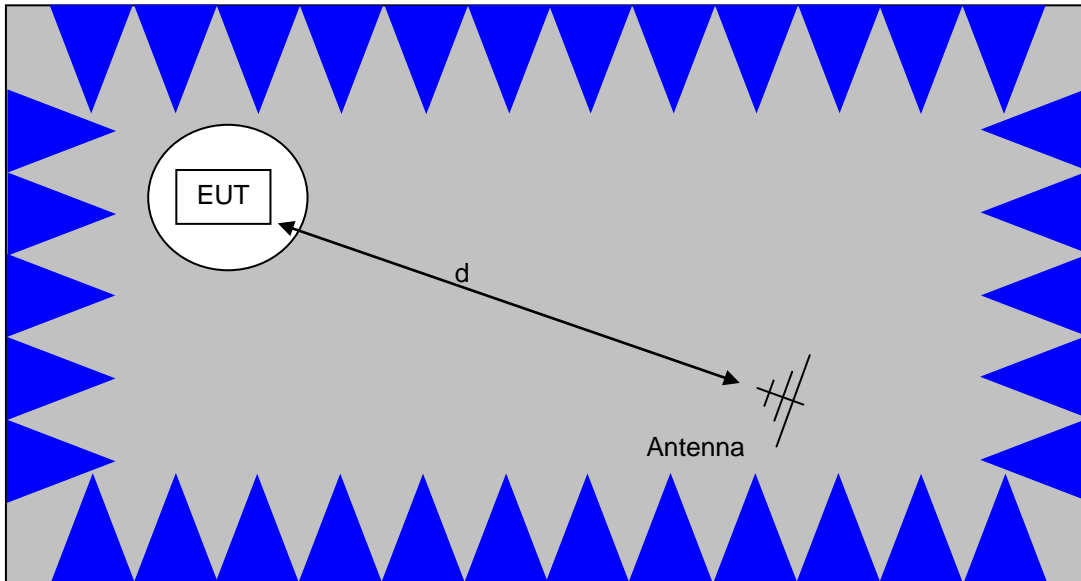

The anechoic materials on the walls and ceiling ensure compliance with the normalized site attenuation requirements of CISPR 16 / CISPR 22 / ANSI C63.4 for an alternate test site at the measurement distances used.

Floor-standing equipment is placed on the floor with insulating supports between the unit and the ground plane.

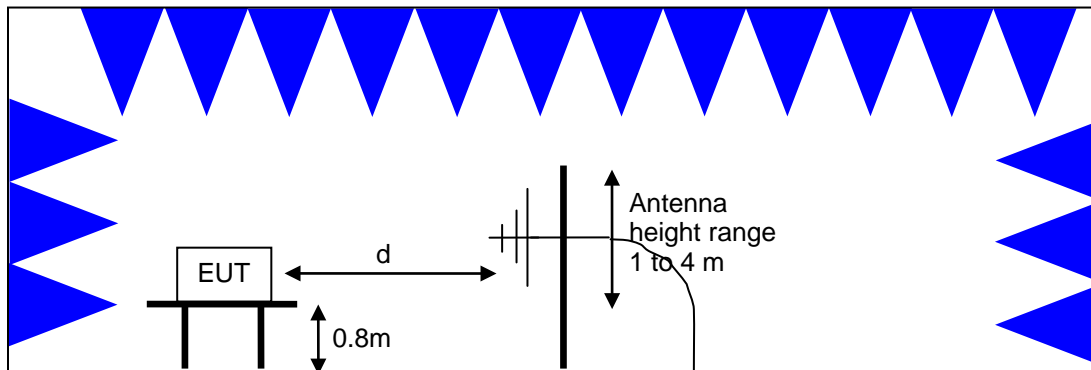

Test Configuration for Radiated Field Strength Measurements
Semi-Anechoic Chamber, Plan and Side Views

CONDUCTED EMISSIONS FROM ANTENNA PORT

Direct measurements of power, bandwidth and power spectral density are performed, where possible, with the antenna port of the EUT connected to either the power meter or spectrum analyzer via a suitable attenuator and/or filter. These are used to ensure that the front end of the measurement instrument is not overloaded by the fundamental transmission.

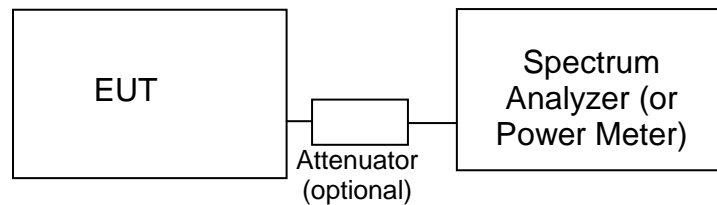
Test Configuration for Antenna Port Measurements

Measurement bandwidths (video and resolution) are set in accordance with the relevant standards and NTS Silicon Valley's test procedures for the type of radio being tested. When power measurements are made using a resolution bandwidth less than the signal bandwidth the power is calculated by summing the power across the signal bandwidth using either the analyzer channel power function or by capturing the trace data and calculating the power using software. In both cases the summed power is corrected to account for the equivalent noise bandwidth (ENBW) of the resolution bandwidth used.

If power averaging is used (typically for certain digital modulation techniques), the EUT is configured to transmit continuously. Power averaging is performed using either the built-in function of the analyzer or, if the analyzer does not feature power averaging, using external software. In both cases the average power is calculated over a number of sweeps (typically 100). When the EUT cannot be configured to continuously transmit then either the analyzer is configured to perform a gated sweep to ensure that the power is averaged over periods that the device is transmitting or power averaging is disabled and a max-hold feature is used.

If a power meter is used to make output power measurements the sensor head type (peak or average) is stated in the test data table.

BANDWIDTH MEASUREMENTS

The 6dB, 20dB, 26dB and/or 99% signal bandwidth are measured using the bandwidths recommended by ANSI C63.10 and RSS GEN.

SPECIFICATION LIMITS AND SAMPLE CALCULATIONS

The limits for conducted emissions are given in units of microvolts, and the limits for radiated emissions are given in units of microvolts per meter at a specified test distance. Data is measured in the logarithmic form of decibels relative to one microvolt, or dB microvolts (dBuV). For radiated emissions, the measured data is converted to the field strength at the antenna in dB microvolts per meter (dBuV/m). The results are then converted to the linear forms of uV and uV/m for comparison to published specifications.

For reference, converting the specification limits from linear to decibel form is accomplished by taking the base ten logarithm, then multiplying by 20. These limits in both linear and logarithmic form are as follows:

CONDUCTED EMISSIONS SPECIFICATION LIMITS: FCC 15.207; FCC 15.107(a), RSS GEN

The table below shows the limits for the emissions on the AC power line from an intentional radiator and a receiver.

Frequency (MHz)	Average Limit (dBuV)	Quasi Peak Limit (dBuV)
0.150 to 0.500	Linear decrease on logarithmic frequency axis between 56.0 and 46.0	Linear decrease on logarithmic frequency axis between 66.0 and 56.0
0.500 to 5.000	46.0	56.0
5.000 to 30.000	50.0	60.0

GENERAL TRANSMITTER RADIATED EMISSIONS SPECIFICATION LIMITS

The table below shows the limits for the spurious emissions from transmitters that fall in restricted bands¹.

Frequency Range (MHz)	Limit (uV/m)	Limit (dBuV/m @ 3m)
0.009-0.490	2400/F _{KHz} @ 300m	67.6-20*log ₁₀ (F _{KHz}) @ 300m
0.490-1.705	24000/F _{KHz} @ 30m	87.6-20*log ₁₀ (F _{KHz}) @ 30m
1.705 to 30	30 @ 30m	29.5 @ 30m
30 to 88	100 @ 3m	40 @ 3m
88 to 216	150 @ 3m	43.5 @ 3m
216 to 960	200 @ 3m	46.0 @ 3m
Above 960	500 @ 3m	54.0 @ 3m

FCC 15.407 (a) OUTPUT POWER LIMITS

The table below shows the limits for output power and output power density. For the 5250-5350 and 5470-5725 MHz bands, where the signal bandwidth is less than 20 MHz the maximum output power is reduced to the power spectral density limit plus 10 times the log of the bandwidth (in MHz).

Operating Frequency (MHz)	Output Power	Power Spectral Density
5150 – 5250	250 mW (24 dBm)	11 dBm/MHz
5250 – 5350 and 5470-5725	250 mW (24 dBm)	11 dBm/MHz
5725 – 5825	1 Watt (30 dBm)	30 dBm/500kHz

For system using antennas with gains exceeding 6dBi, the output power and power spectral density limits are reduced by 1dB for every dB the antenna gain exceeds 6dBi.

¹ The restricted bands are detailed in FCC 15.205 and RSS-Gen Table 6

OUTPUT POWER LIMITS –LELAN DEVICES

The table below shows the limits for output power and output power density defined by RSS 247. Where the signal bandwidth is less than 20 MHz the maximum output power is reduced to the power spectral density limit plus 10 times the log of the bandwidth (in MHz).

Operating Frequency (MHz)	Output Power	Power Spectral Density
5150 – 5250	200mW (23 dBm) eirp	10 dBm/MHz eirp
5250 – 5350 and 5470 - 5725	250 mW (24 dBm) ² 1W (30dBm) eirp	11 dBm/MHz
5725 – 5825	1 Watt (30 dBm) 4W eirp	30 dBm/500kHz

SPURIOUS EMISSIONS LIMITS –UNII and LELAN DEVICES

The spurious emissions limits for signals below 1GHz are the FCC/RSS-Gen general limits. For emissions above 1GHz, signals in restricted bands are subject to the FCC/RSS-Gen general limits. All other signals have a limit of –27dBm/MHz, which is field strength of 68.3dBuV/m/MHz at a distance of 3m. For devices operating in the 5725-5850 MHz bands under the LELAN/UNII rules, the limit within 10MHz of the allocated band is increased to –17dBm/MHz.

² If EIRP exceeds 500mW the device must employ TPC

SAMPLE CALCULATIONS - CONDUCTED EMISSIONS

Receiver readings are compared directly to the conducted emissions specification limit (decibel form) as follows:

$$R_r - S = M$$

where:

R_r = Receiver Reading in dBuV

S = Specification Limit in dBuV

M = Margin to Specification in +/- dB

SAMPLE CALCULATIONS - RADIATED EMISSIONS

Receiver readings are compared directly to the specification limit (decibel form). The receiver internally corrects for cable loss, preamplifier gain, and antenna factor. The calculations are in the reverse direction of the actual signal flow, thus cable loss is added and the amplifier gain is subtracted. The Antenna Factor converts the voltage at the antenna coaxial connector to the field strength at the antenna elements.

A distance factor, when used for electric field measurements above 30MHz, is calculated by using the following formula:

$$F_d = 20 * \text{LOG}_{10} (D_m/D_s)$$

where:

F_d = Distance Factor in dB

D_m = Measurement Distance in meters

D_s = Specification Distance in meters

For electric field measurements below 30MHz the extrapolation factor is either determined by making measurements at multiple distances or a theoretical value is calculated using the formula:

$$F_d = 40 * \text{LOG}_{10} (D_m/D_s)$$

Measurement Distance is the distance at which the measurements were taken and Specification Distance is the distance at which the specification limits are based. The antenna factor converts the voltage at the antenna coaxial connector to the field strength at the antenna elements.

The margin of a given emission peak relative to the limit is calculated as follows:

$$R_c = R_r + F_d$$

and

$$M = R_c - L_s$$

where:

R_r = Receiver Reading in dBuV/m

F_d = Distance Factor in dB

R_c = Corrected Reading in dBuV/m

L_s = Specification Limit in dBuV/m

M = Margin in dB Relative to Spec

SAMPLE CALCULATIONS - FIELD STRENGTH TO EIRP CONVERSION

Where the radiated electric field strength is expressed in terms of the equivalent isotropic radiated power (eirp), or where a field strength measurement of output power is made in lieu of a direct measurement, the following formula is used to convert between eirp and field strength at a distance of d (meters) from the equipment under test:

$$E = \frac{1000000 \sqrt{30 P}}{d} \text{ microvolts per meter}$$

where P is the eirp (Watts)

For a measurement at 3m the conversion from a logarithmic value for field strength (dBuV/m) to an eirp power (dBm) is -95.3dB.

Appendix A Test Equipment Calibration Data

<u>Manufacturer</u>	<u>Description</u>	<u>Model</u>	<u>Asset #</u>	<u>Calibrated</u>	<u>Cal Due</u>
Radiated Spurious Emissions, Bandedges, 1 - 6.5 GHz, 28-Jun-17					
National Technical Systems	NTS EMI Software (rev 2.10)	N/A	0		N/A
EMCO	Antenna, Horn, 1-18 GHz	3115	786	12/21/2015	12/21/2017
Rohde & Schwarz	EMI Test Receiver, 20 Hz-7 GHz	ESIB 7	1538	2/11/2017	2/11/2018
Radiated Spurious Emissions, Bandedges, 1 - 6.5 GHz, 29-Jun-17					
National Technical Systems	NTS EMI Software (rev 2.10)	N/A	0		N/A
EMCO	Antenna, Horn, 1-18 GHz	3115	786	12/21/2015	12/21/2017
Rohde & Schwarz	EMI Test Receiver, 20 Hz-7 GHz	ESIB 7	1538	2/11/2017	2/11/2018
Radiated Emissions, 1000 - 25,000 MHz, 30-Jun-17					
EMCO	Antenna, Horn, 1-18 GHz	3115	786	12/21/2015	12/21/2017
Hewlett Packard	High Pass filter, 8.2 GHz	P/N 84300-80039	1156	5/10/2017	5/10/2018
HP / Miteq	SA40 P Head HF preAmplifier, 18-40 GHz (w/2415)	TTA1840-45-5P-HG-S	1772	9/12/2016	N/A
A. H. Systems	Spare System Horn, 18-40GHz	SAS-574, p/n: 2581	2162	7/29/2015	7/29/2017
Hewlett Packard	Microwave Preamplifier, 1-26.5GHz	8449B	2199	9/30/2016	9/30/2017
Micro-Tronics	Band Reject Filter, 2400-2500 MHz 18GHz	BRM50702-02	2238	5/17/2017	5/17/2018
Hewlett Packard	Spectrum Analyzer (SA40) Purple 9 kHz - 40 GHz,	8564E (84125C)	2415	3/1/2017	3/1/2018
Radiated Emissions, 1000 - 12,000 MHz, 5-Jul-17					
EMCO	Antenna, Horn, 1-18 GHz	3115	786	12/21/2015	12/21/2017
Hewlett Packard	Microwave Preamplifier, 1-26.5GHz	8449B	2199	9/30/2016	9/30/2017
Micro-Tronics	Band Reject Filter, 2400-2500 MHz 18GHz	BRM50702-02	2238	5/17/2017	5/17/2018
Hewlett Packard	Spectrum Analyzer (SA40) Purple 9 kHz - 40 GHz,	8564E (84125C)	2415	3/1/2017	3/1/2018
Micro-Tronics	Band Reject Filter, 5470-5725 MHz	BRC50704-02	2240	9/20/2016	9/20/2017
Micro-Tronics	Band Reject Filter, 5725-5875 MHz	BRC50705-02	2241	9/20/2016	9/20/2017
Micro-Tronics	Band Reject Filter, 5150-5350 MHz	BRC50703-02	2251	9/19/2016	9/19/2017
Radiated Spurious Emissions, 12 - 40 GHz, 06-Jul-17					
National Technical Systems	NTS EMI Software (rev 2.10)	N/A	0		N/A
Hewlett Packard	Microwave Preamplifier, 1-26.5GHz	8449B	785	10/5/2016	10/5/2017
Narda West	High Pass Filter, 8 GHz	HPF 180	821	2/7/2017	2/7/2018
EMCO	Antenna, Horn, 1-18 GHz (SA40-Red)	3115	1142	9/29/2016	9/29/2018
HP / Miteq	SA40 R Head HF preAmplifier, 18-40 GHz (w/1148)	TTA1840-45-5P-HG-S	1145	8/24/2016	8/24/2017
Hewlett Packard	Spectrum Analyzer (SA40) Red 30 Hz -40 GHz	8564E (84125C)	1148	10/31/2016	11/1/2017
Radiated Emissions, 1000 - 18,000 MHz, 6-Jul-17					
EMCO	Antenna, Horn, 1-18 GHz (SA40-Red)	3115	1142	9/29/2016	9/29/2018
Hewlett Packard	Microwave Preamplifier, 1-26.5GHz	8449B	785	10/5/2016	10/5/2017



<u>Manufacturer</u>	<u>Description</u>	<u>Model</u>	<u>Asset #</u>	<u>Calibrated</u>	<u>Cal Due</u>
Micro-Tronics	Band Reject Filter, 2400-2500 MHz 18GHz	BRM50702-02	2238	5/17/2017	5/17/2018
Hewlett Packard	Spectrum Analyzer (SA40) Red 30 Hz -40 GHz	8564E (84125C)	1148	10/31/2016	11/1/2017
Micro-Tronics	Band Reject Filter, 5470-5725 MHz	BRC50704-02	2240	9/20/2016	9/20/2017
Micro-Tronics	Band Reject Filter, 5725-5875 MHz	BRC50705-02	2241	9/20/2016	9/20/2017
Micro-Tronics	Band Reject Filter, 5150-5350 MHz	BRC50703-02	2251	9/19/2016	9/19/2017
Narda West	High Pass Filter, 8 GHz	HPF 180	821	2/7/2017	2/7/2018
Radiated Emissions, 1000 - 40,000 MHz, 07-Jul-17					
EMCO	Antenna, Horn, 1-18 GHz	3115	786	12/21/2015	12/21/2017
Narda West	High Pass Filter, 8 GHz	HPF 180	821	2/7/2017	2/7/2018
HP / Miteq	SA40 P Head HF preAmplifier, 18-40 GHz (w/2415)	TTA1840-45-5P-HG-S	1772	9/12/2016	N/A
A. H. Systems	Spare System Horn, 18-40GHz	SAS-574, p/n: 2581	2162	7/29/2015	7/29/2017
Hewlett Packard	Microwave Preamplifier, 1-26.5GHz	8449B	2199	9/30/2016	9/30/2017
Micro-Tronics	Band Reject Filter, 2400-2500 MHz 18GHz	BRM50702-02	2238	5/17/2017	5/17/2018
Micro-Tronics	Band Reject Filter, 5150-5350 MHz	BRC50703-02	2251	9/19/2016	9/19/2017
Hewlett Packard	Spectrum Analyzer (SA40) Purple 9 kHz - 40 GHz,	8564E (84125C)	2415	3/1/2017	3/1/2018
Radiated Spurious Emissions, 1000 - 6,500 MHz, 12-Jul-17					
National Technical Systems	NTS EMI Software (rev 2.10)	N/A	0		N/A
Rohde & Schwarz	EMI Test Receiver, 20 Hz-7 GHz	ESIB 7	1756	6/29/2016	7/29/2017
EMCO	Antenna, Horn, 1-18 GHz	3115	2870	8/31/2015	8/31/2017
Radiated Emissions, 30 - 1,000 MHz, 18-Jul-17					
Sunol Sciences	Biconilog, 30-3000 MHz	JB3	1548	10/12/2016	10/12/2018
Com-Power	Preamplifier, 30-1000 MHz	PA-103	1632	3/8/2017	3/8/2018
Rohde & Schwarz	EMI Test Receiver, 20 Hz-7 GHz	ESIB 7	1756	7/8/2017	7/8/2018
Micro-Tronics	Band Reject Filter, 2400-2500 MHz 18GHz	BRM50702-02	2238	5/17/2017	5/17/2018
Micro-Tronics	Band Reject Filter, 5150-5350 MHz	BRC50703-02	2251	9/19/2016	9/19/2017
Radiated Emissions, 1000 - 12,000 MHz, 18-Jul-17					
EMCO	Antenna, Horn, 1-18 GHz	3115	786	12/21/2015	12/21/2017
Hewlett Packard	Microwave Preamplifier, 1-26.5GHz	8449B	2199	9/30/2016	9/30/2017
Micro-Tronics	Band Reject Filter, 2400-2500 MHz 18GHz	BRM50702-02	2238	5/17/2017	5/17/2018
Hewlett Packard	Spectrum Analyzer (SA40) Purple 9 kHz - 40 GHz,	8564E (84125C)	2415	3/1/2017	3/1/2018
Radio Antenna Port (Power and Spurious Emissions), 19-Jul-17					
Rohde & Schwarz	Signal Analyzer 20 Hz - 26.5 GHz	FSQ26	2327	6/24/2017	6/24/2018
Radio Antenna Port (Power and Spurious Emissions), 20-Jul-17					
Rohde & Schwarz	Signal Analyzer 20 Hz - 26.5 GHz	FSQ26	2327	6/24/2017	6/24/2018
Radio Antenna Port (Power and Spurious Emissions), 21-Jul-17					
Agilent Technologies	3Hz -44GHz PSA Spectrum Analyzer	E4446A	2796	5/22/2017	5/22/2018



<u>Manufacturer</u>	<u>Description</u>	<u>Model</u>	<u>Asset #</u>	<u>Calibrated</u>	<u>Cal Due</u>
Radiated Emissions, 1000 - 40,000 MHz, 21-Jul-17					
EMCO	Antenna, Horn, 1-18 GHz	3115	786	12/21/2015	12/21/2017
Hewlett Packard	High Pass filter, 8.2 GHz	P/N 84300-80039	1156	5/10/2017	5/10/2018
HP / Miteq	SA40 P Head HF preAmplifier, 18-40 GHz (w/2415)	TTA1840-45-5P-HG-S	1772	9/12/2016	N/A
A. H. Systems	Spare System Horn, 18-40GHz	SAS-574, p/n: 2581	2162	7/29/2015	8/29/2017
Hewlett Packard	Microwave Preamplifier, 1-26.5GHz	8449B	2199	9/30/2016	9/30/2017
Hewlett Packard	Spectrum Analyzer (SA40) Purple 9 kHz - 40 GHz,	8564E (84125C)	2415	3/1/2017	3/1/2018
Micro-Tronics	Band Reject Filter, 5725-5875 MHz	BRC50705-01	2738	10/7/2016	10/7/2017
Conducted Emissions - AC Power Ports, 21-Jul-17					
EMCO	LISN, 10 kHz-100 MHz	3825/2	1292	8/1/2016	8/1/2017
Rohde & Schwarz	Pulse Limiter	ESH3 Z2	1401	2/3/2017	2/3/2018
Rohde & Schwarz	EMI Test Receiver, 20 Hz-7 GHz	ESIB 7	1756	7/8/2017	7/8/2018
Radio Antenna Port (Power and Spurious Emissions), 24-Jul-17					
Rohde & Schwarz	Power Meter, Single Channel	NRVS	1422	3/10/2017	3/10/2018
Rohde & Schwarz	Attenuator, 20 dB, 10W, DC-18 GHz	20dB, 10W, Type N	1795	7/21/2016	8/21/2017
Rohde & Schwarz	Power Sensor 100 uW - 10 Watts	NRV-Z53	1796	7/21/2016	8/21/2017



Appendix B Test Data

T104956 Pages 32 - 133



EMC Test Data

Client:	Google Inc.	Job Number:	JD104891
Product:	Model H0A	T-Log Number:	T104956
System Configuration:	-	Project Manager:	Deepa Shetty
Contact:	Dominik Mente	Project Coordinator:	-
Emissions Standard(s):	FCC 15.247 / 15.407 / RSS-247	Class:	B
Immunity Standard(s):	-	Environment:	-

EMC Test Data

For The

Google Inc.

Product

Model H0A

Date of Last Test: 7/24/2017

Client:	Google Inc.	Job Number:	JD104891
Model:	Model H0A	T-Log Number:	T104956
Contact:	Dominik Mente	Project Manager:	Deepa Shetty
Standard:	FCC 15.247 / 15.407 / RSS-247	Project Coordinator:	-
		Class:	N/A

RSS-247 and FCC 15.407 (UNII) Radiated Spurious Emissions

Test Specific Details

Objective: The objective of this test session is to perform final qualification testing of the EUT with respect to the specification listed above.

General Test Configuration

The EUT and all local support equipment were located on the turntable for radiated spurious emissions testing. For radiated emissions testing the measurement antenna was located 3 meters from the EUT, unless otherwise noted.

Ambient Conditions:

Temperature: 25 °C
Rel. Humidity: 38 %

Summary of Results

Run #	Mode	Channel	Target Power (dBm)	Passing Power Setting	Test Performed	Limit	Result / Margin
20MHz Bandwith Modes							
1	a	36 - 5180MHz	-	15	Restricted Band Edge at 5150 MHz	15.209	49.9 dBµV/m @ 5150.0 MHz (-4.1 dB)
2	a	64 - 5320MHz	-	16	Restricted Band Edge at 5350 MHz	15.209	51.1 dBµV/m @ 5350.0 MHz (-2.9 dB)
3	a	100 - 5500MHz	-	15	Restricted Band Edge at 5460 MHz	15.209	46.9 dBµV/m @ 5427.9 MHz (-7.1 dB)
	a	100 - 5500MHz	-	15	Band Edge 5460 - 5470 MHz	15E	51.2 dBµV/m @ 5470.0 MHz (-2.8 dB)
	a	140 - 5700MHz	-	14	Band Edge 5725MHz	15E	51.1 dBµV/m @ 5725.0 MHz (-2.9 dB)
4	a	149 - 5745MHz	-	21	Band Edge 5725 MHz	15E	62.4 dBµV/m @ 5649.8 MHz (-5.9 dB)
	a	165 - 5825MHz	-	21	Band Edge 5850MHz	15E	62.0 dBµV/m @ 5931.9 MHz (-6.3 dB)



EMC Test Data

Client:	Google Inc.	Job Number:	JD104891
Model:	Model H0A	T-Log Number:	T104956
		Project Manager:	Deepa Shetty
Contact:	Dominik Mente	Project Coordinator:	-
Standard:	FCC 15.247 / 15.407 / RSS-247	Class:	N/A

Run #	Mode	Channel	Target Power (dBm)	Passing Power Setting	Test Performed	Limit	Result / Margin
20MHz Bandwith Modes							
5	n20	36 - 5180MHz	-	15	Restricted Band Edge at 5150 MHz	15.209	51.8 dBµV/m @ 5150.0 MHz (-2.2 dB)
6	n20	64 - 5320MHz	-	16	Restricted Band Edge at 5350 MHz	15.209	51.9 dBµV/m @ 5350.0 MHz (-2.1 dB)
7	n20	100 - 5500MHz	-	15	Restricted Band Edge at 5460 MHz	15.209	46.1 dBµV/m @ 5427.9 MHz (-7.9 dB)
	n20	100 - 5500MHz	-	15	Band Edge 5460 - 5470 MHz	15E	50.5 dBµV/m @ 5470.0 MHz (-3.5 dB)
	n20	140 - 5700MHz	-	13	Band Edge 5725MHz	15E	49.8 dBµV/m @ 5725.0 MHz (-4.2 dB)
8	n20	149 - 5745MHz	-	21	Band Edge 5725 MHz	15E	66.6 dBµV/m @ 5644.7 MHz (-1.7 dB)
	n20	165 - 5825MHz	-	21	Band Edge 5850MHz	15E	65.2 dBµV/m @ 5928.6 MHz (-3.1 dB)
40MHz Bandwith Modes							
9	n40	38 - 5190MHz	-	13	Restricted Band Edge at 5150 MHz	15.209	52.2 dBµV/m @ 5149.9 MHz (-1.8 dB)
10	n40	62 - 5310MHz	-	13	Restricted Band Edge at 5350 MHz	15.209	52.0 dBµV/m @ 5350.1 MHz (-2.0 dB)
11	n40	102 - 5510MHz	-	12	Restricted Band Edge at 5460 MHz	15.209	46.6 dBµV/m @ 5460.0 MHz (-7.4 dB)
	n40	102 - 5510MHz	-	12	Band Edge 5460 - 5470 MHz	15E	52.3 dBµV/m @ 5470.0 MHz (-1.7 dB)
	n40	134 - 5670MHz	-	15	Band Edge 5725MHz	15E	52.4 dBµV/m @ 5725.2 MHz (-1.6 dB)
12	n40	151 - 5755MHz	-	16	Band Edge 5725 MHz	15E	64.9 dBµV/m @ 5646.4 MHz (-3.4 dB)
	n40	159 - 5795MHz	-	17	Band Edge 5850MHz	15E	66.4 dBµV/m @ 5646.0 MHz (-1.9 dB)



EMC Test Data

Client: Google Inc.	Job Number: JD104891
Model: Model H0A	T-Log Number: T104956
	Project Manager: Deepa Shetty
Contact: Dominik Mente	Project Coordinator: -
Standard: FCC 15.247 / 15.407 / RSS-247	Class: N/A

Run #	Mode	Channel	Target Power (dBm)	Passing Power Setting	Test Performed	Limit	Result / Margin
80MHz Bandwith Modes							
13	ac80	42 - 5210MHz	-	9	Restricted Band Edge at 5150 MHz	15.209	51.6 dBµV/m @ 5140.5 MHz (-2.4 dB)
14	ac80	58 - 5290MHz	-	10	Restricted Band Edge at 5350 MHz	15.209	52.1 dBµV/m @ 5363.7 MHz (-1.9 dB)
15	ac80	106 - 5530MHz	-	8	Restricted Band Edge at 5460 MHz	15.209	49.2 dBµV/m @ 5457.4 MHz (-4.8 dB)
	ac80	106 - 5530MHz	-	8	Band Edge 5460 - 5470 MHz	15E	48.8 dBµV/m @ 5460.1 MHz (-5.2 dB)
16	ac80	155 - 5775MHz	-	14	Band Edge 5725 MHz	15E	66.5 dBµV/m @ 5642.5 MHz (-1.8 dB)
	ac80	155 - 5775MHz	-	14	Band Edge 5850MHz	15E	60.2 dBµV/m @ 5943.9 MHz (-8.1 dB)
17	ac80	138 - 5690MHz	-	16	Band Edge 5850MHz	15.209	51.7 dBµV/m @ 5867.7 MHz (-2.3 dB)

Client:	Google Inc.	Job Number:	JD104891
Model:	Model H0A	T-Log Number:	T104956
		Project Manager:	Deepa Shetty
Contact:	Dominik Mente	Project Coordinator:	-
Standard:	FCC 15.247 / 15.407 / RSS-247	Class:	N/A

Modifications Made During Testing

No modifications were made to the EUT during testing

Deviations From The Standard

No deviations were made from the requirements of the standard.

Procedure Comments:

Measurements performed in accordance with FCC KDB 789033

Peak measurements performed with: RBW=1MHz, VBW=3MHz, peak detector, max hold, auto sweep time

Unless otherwise stated/noted, emission has duty cycle $\geq 98\%$ and was measured using RBW=1MHz, VBW=10Hz, peak detector, linear average mode, auto sweep time, max hold 50 traces. (method VB of KDB 789033)

Mode	Data Rate	Duty Cycle (x)	Constant DC?	T (ms)	Pwr Cor Factor*	Lin Volt Cor Factor**	Min VBW for FS (Hz)
11a	6MB/s	0.99	Yes	2.157	0	0	10
11n20	MCS0	0.99	Yes	2.928	0	0	10
11n40	MCS0	0.981	Yes	2.335	0	0	10
ac80	VHT0	0.984	Yes	2.228	0	0	10

Sample Notes

Sample S/N: Engineering Radiated Sample #2

Driver: -

Antenna: internal

Measurement Specific Notes:

Note 1:	For emissions outside of the restricted bands the limit is -27dBm/MHz eirp (68.3dBuV/m). The measurement method required is a peak measurement (RB=1MHz, VB \geq 3MHz, peak detector). Per KDB 789033 2) c) (i), compliance can be demonstrated by meeting the average and peak limits of 15.209, as an alternative.
---------	--

Note: All testing performed on the Antenna 2 port (wifi set to 10 2 2), as this was worse case from preliminary measurements.



EMC Test Data

Client: Google Inc.	Job Number: JD104891
Model: Model H0A	T-Log Number: T104956
	Project Manager: Deepa Shetty
Contact: Dominik Mente	Project Coordinator: -
Standard: FCC 15.247 / 15.407 / RSS-247	Class: N/A

Run #1: Radiated Bandedge Measurements, 5150-5250MHz

Date of Test: 6/28/2017 0:00
 Test Engineer: Rafael Varelas
 Test Location: FT Chamber #7

Config. Used: 1
 Config Change: None
 EUT Voltage: USB

Channel: 36 - 5180 MHz
 Tx Chain: See below
 Mode: a
 Data Rate: 6MB/s

5150 MHz Band Edge Signal Radiated Field Strength

Frequency MHz	Level dB μ V/m	Pol v/h	FCC 15.209		Detector Pk/QP/Avg	Azimuth degrees	Height meters	Comments
			Limit	Margin				
Antenna 1								
Power setting = 15								
5150.000	49.9	H	54.0	-4.1	AVG	329	1.6	POS; RB 1 MHz; VB: 10 Hz
5147.230	64.7	H	74.0	-9.3	PK	329	1.6	POS; RB 1 MHz; VB: 3 MHz
5150.000	45.6	V	54.0	-8.4	AVG	156	2.2	POS; RB 1 MHz; VB: 10 Hz
5149.440	60.5	V	74.0	-13.5	PK	156	2.2	POS; RB 1 MHz; VB: 3 MHz
Antenna 2								
Power setting = 15								
5150.000	48.4	H	54.0	-5.6	AVG	102	1.2	POS; RB 1 MHz; VB: 10 Hz
5147.760	63.6	H	74.0	-10.4	PK	102	1.2	POS; RB 1 MHz; VB: 3 MHz
5150.000	44.5	V	54.0	-9.5	AVG	324	1.4	POS; RB 1 MHz; VB: 10 Hz
5146.070	59.0	V	74.0	-15.0	PK	324	1.4	POS; RB 1 MHz; VB: 3 MHz

Client: Google Inc.	Job Number: JD104891
Model: Model H0A	T-Log Number: T104956
Contact: Dominik Mentel	Project Manager: Deepa Shetty
Standard: FCC 15.247 / 15.407 / RSS-247	Project Coordinator: -
	Class: N/A

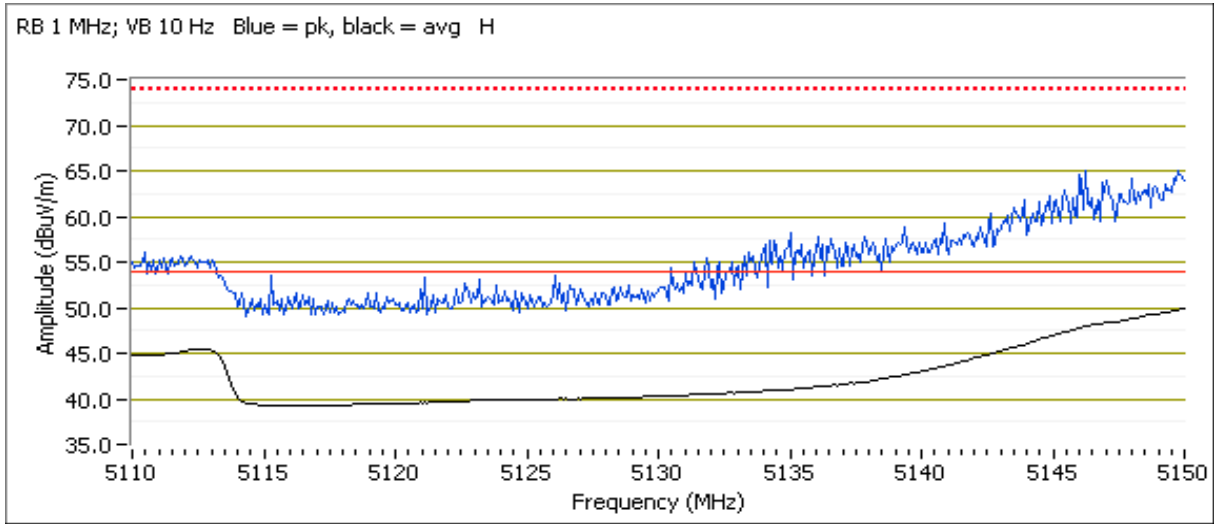



EMC Test Data

Client: Google Inc.	Job Number: JD104891
Model: Model H0A	T-Log Number: T104956
Contact: Dominik Mente	Project Manager: Deepa Shetty
Standard: FCC 15.247 / 15.407 / RSS-247	Project Coordinator: -
	Class: N/A

Date of Test: 7/12/2017 0:00
 Test Engineer: John Caizzi
 Test Location: FT Chamber #7

Config. Used: 1
 Config Change: None
 EUT Voltage: USB

Channel: 64 - 5320MHz
 Tx Chain: Antenna 2 (worse case based on preliminary measurements)
 Mode: a
 Data Rate: 6MB/s

5350 MHz Band Edge Signal Radiated Field Strength

Frequency	Level	Pol	FCC 15.209		Detector	Azimuth	Height	Comments
MHz	dB μ V/m	v/h	Limit	Margin	Pk/QP/Avg	degrees	meters	
5350.000	51.1	H	54.0	-2.9	AVG	8	1.19	Pwr setting = 16
5350.410	70.3	H	74.0	-3.7	PK	8	1.19	Pwr setting = 16

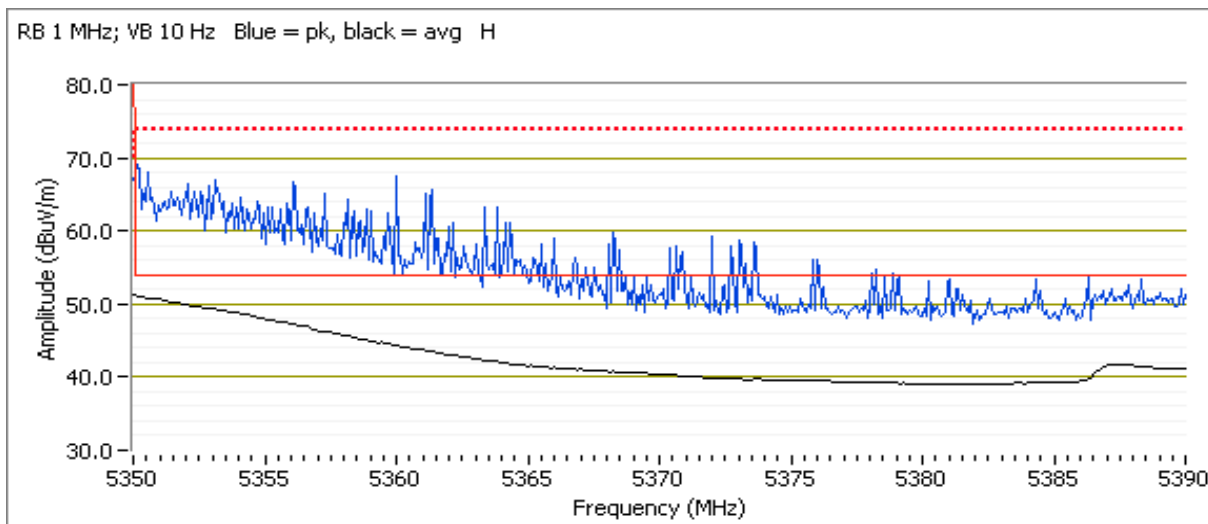



EMC Test Data

Client: Google Inc.	Job Number: JD104891
Model: Model H0A	T-Log Number: T104956
Contact: Dominik Mente	Project Manager: Deepa Shetty
Standard: FCC 15.247 / 15.407 / RSS-247	Project Coordinator: -
	Class: N/A

Run #3: Radiated Bandedge Measurements, 5470-5725MHz

Date of Test: 7/12/2017 0:00
 Test Engineer: John Caizzi
 Test Location: FT Chamber #7

Config. Used: 1
 Config Change: None
 EUT Voltage: USB

Channel: 100 - 5500MHz
 Tx Chain: Antenna 1 (worse case based on preliminary measurements)
 Mode: a
 Data Rate: 6MB/s

5460 MHz Band Edge Signal Radiated Field Strength

Frequency	Level	Pol	FCC 15.209		Detector	Azimuth	Height	Comments
MHz	dB μ V/m	v/h	Limit	Margin	Pk/QP/Avg	degrees	meters	
5427.860	46.9	H	54.0	-7.1	AVG	310	1.1	POS; RB 1 MHz; VB: 10 Hz
5457.520	60.8	H	74.0	-13.2	PK	310	1.1	POS; RB 1 MHz; VB: 3 MHz

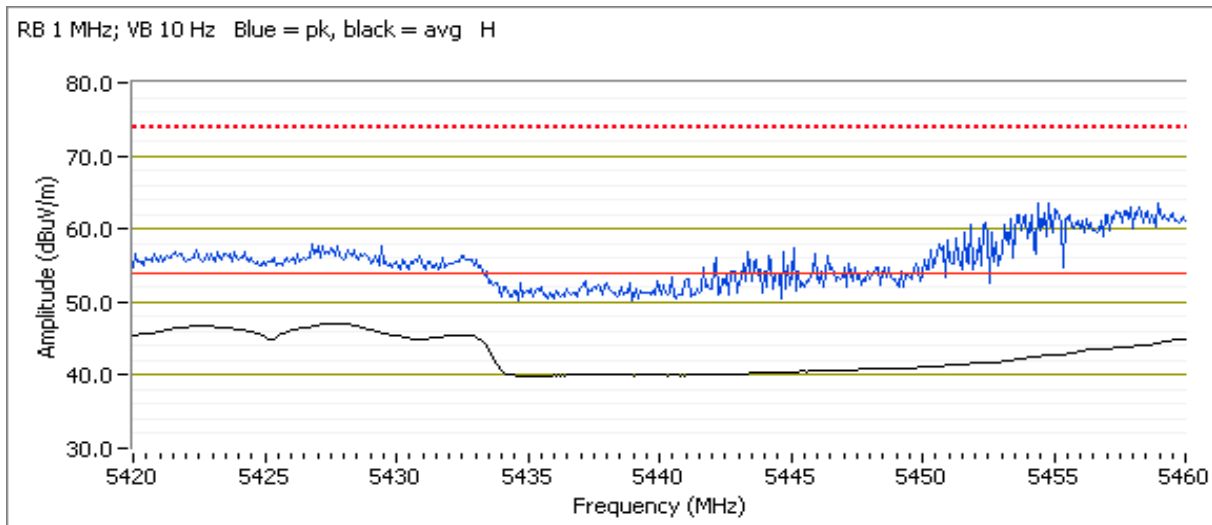

Client: Google Inc.	Job Number: JD104891
Model: Model H0A	T-Log Number: T104956
Contact: Dominik Mentel	Project Manager: Deepa Shetty
Standard: FCC 15.247 / 15.407 / RSS-247	Project Coordinator: -
	Class: N/A

5470 MHz Band Edge Signal Radiated Field Strength

Frequency MHz	Level dB μ V/m	Pol v/h	15.E		Detector Pk/QP/Avg	Azimuth degrees	Height meters	Comments
			Limit	Margin				
5469.980	51.2	H	54.0	-2.8	AVG	316	1.28	Pwr setting = 15
5466.890	66.8	H	74.0	-7.2	PK	316	1.28	Pwr setting = 15

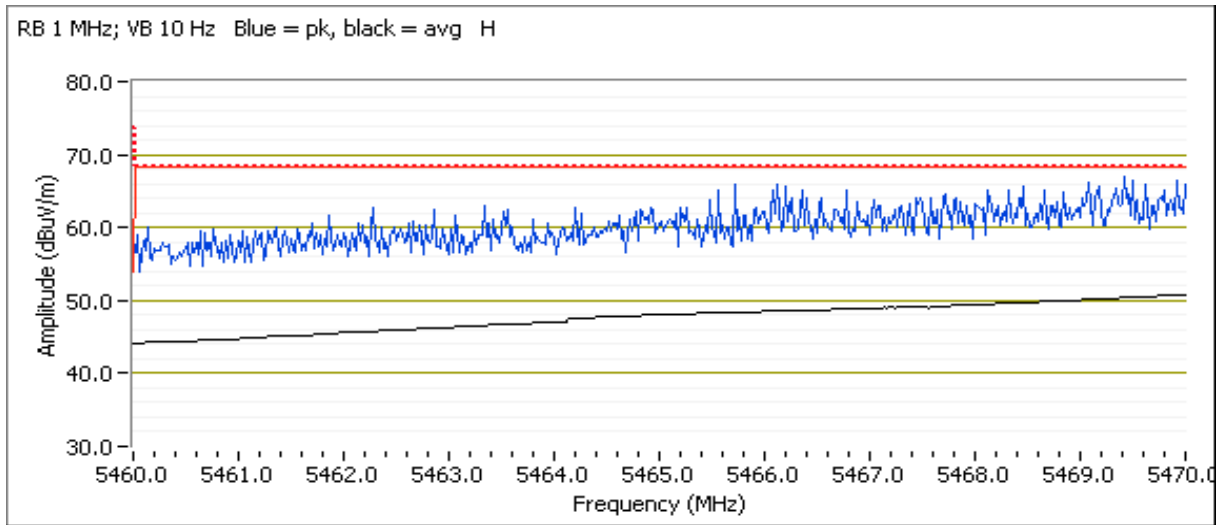

Client: Google Inc.	Job Number: JD104891
Model: Model H0A	T-Log Number: T104956
Contact: Dominik Mente	Project Manager: Deepa Shetty
Standard: FCC 15.247 / 15.407 / RSS-247	Project Coordinator: -
	Class: N/A

Channel: 140 - 5700MHz
 Tx Chain: See below
 Mode: a
 Data Rate: 6MB/s

5725 MHz Band Edge Signal Radiated Field Strength

Frequency	Level	Pol	15.E		Detector	Azimuth	Height	Comments
MHz	dB μ V/m	v/h	Limit	Margin	Pk/QP/Avg	degrees	meters	
Antenna 1								
Power setting = 14								
5725.000	50.2	H	54.0	-3.8	AVG	297	1.2	POS; RB 1 MHz; VB: 10 Hz
5726.440	68.3	H	74.0	-5.7	PK	297	1.2	POS; RB 1 MHz; VB: 3 MHz
Antenna 2								
Power setting = 14								
5725.000	51.1	H	54.0	-2.9	AVG	42	1.0	POS; RB 1 MHz; VB: 10 Hz
5727.160	70.0	H	74.0	-4.0	PK	42	1.0	POS; RB 1 MHz; VB: 3 MHz

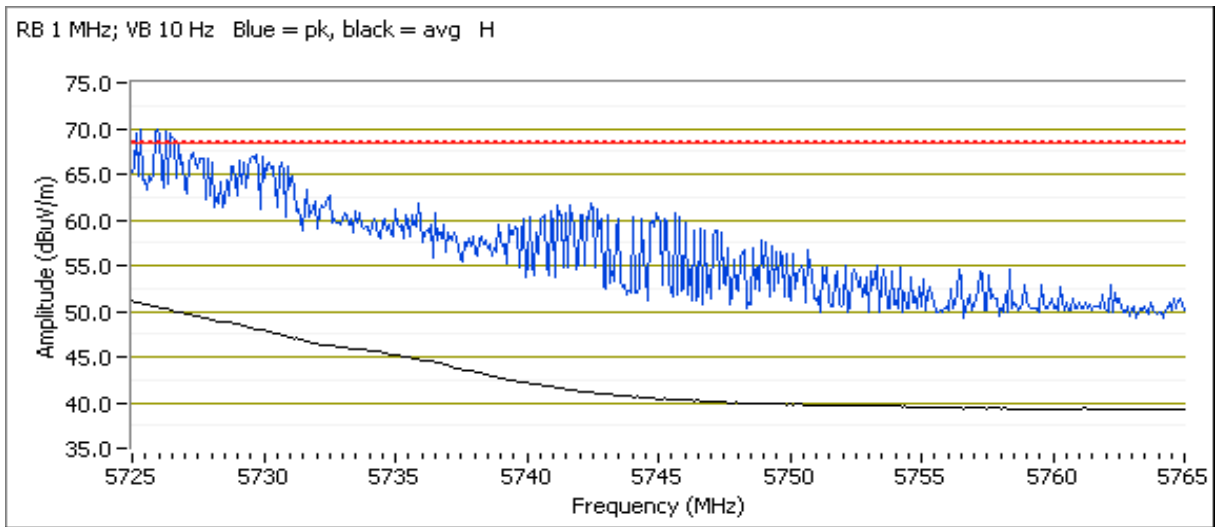



EMC Test Data

Client: Google Inc.	Job Number: JD104891
Model: Model H0A	T-Log Number: T104956
Contact: Dominik Mente	Project Manager: Deepa Shetty
Standard: FCC 15.247 / 15.407 / RSS-247	Project Coordinator: -
	Class: N/A

Run #4: Radiated Bandedge Measurements, 5725-5850MHz

Date of Test: 6/28/2017 0:00
 Test Engineer: Rafael Varelas
 Test Location: FT Chamber #7

Config. Used: 1
 Config Change: None
 EUT Voltage: USB

Channel: 149 - 5745MHz
 Tx Chain: See below
 Mode: a
 Data Rate: 6MB/s

5725 MHz Band Edge Signal Radiated Field Strength

Frequency	Level	Pol	15.E		Detector	Azimuth	Height	Comments
MHz	dB μ V/m	v/h	Limit	Margin	PK/QP/Avg	degrees	meters	
Antenna 1								
Power setting = 21								
5647.240	61.6	H	68.3	-6.7	PK	296	1.3	POS; RB 1 MHz; VB: 3 MHz
Antenna 2								
Power setting = 21								
5649.800	62.4	H	68.3	-5.9	PK	52	1.0	POS; RB 1 MHz; VB: 3 MHz

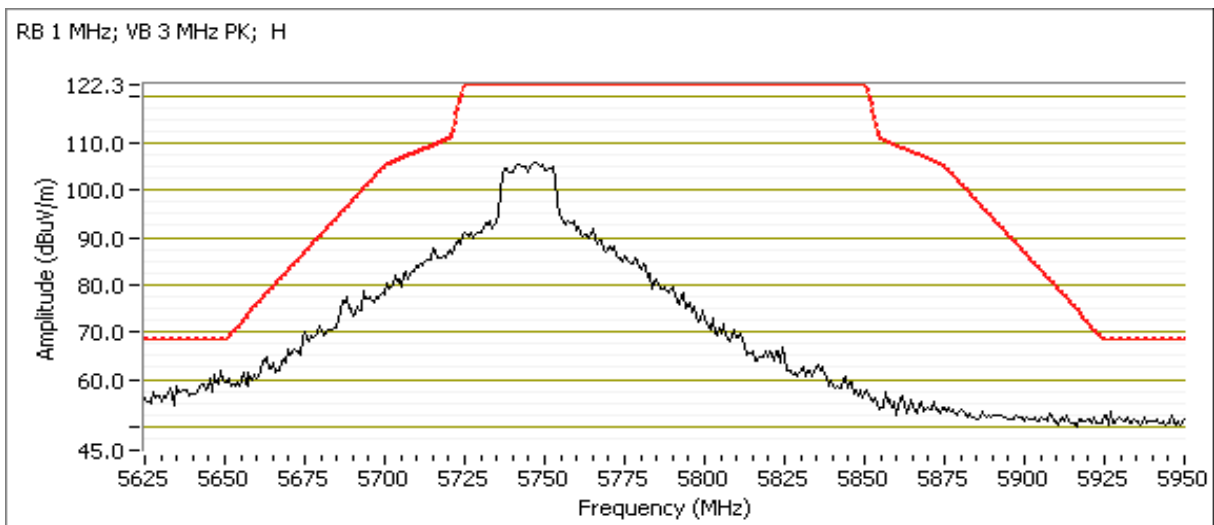

Client:	Google Inc.	Job Number:	JD104891
Model:	Model H0A	T-Log Number:	T104956
Contact:	Dominik Mente	Project Manager:	Deepa Shetty
Standard:	FCC 15.247 / 15.407 / RSS-247	Project Coordinator:	-
		Class:	N/A

Channel: 165 - 5825MHz
 Tx Chain: See below
 Mode: a
 Data Rate: 6MB/s

5850 MHz Band Edge Signal Radiated Field Strength

Frequency	Level	Pol	15.E		Detector	Azimuth	Height	Comments
MHz	dB μ V/m	v/h	Limit	Margin	Pk/QP/Avg	degrees	meters	
Antenna 1								
Power setting = 21								
5930.560	59.9	H	68.3	-8.4	PK	297	1.5	POS; RB 1 MHz; VB: 3 MHz
Antenna 2								
Power setting = 21								
5931.860	62.0	H	68.3	-6.3	PK	44	1.1	POS; RB 1 MHz; VB: 3 MHz

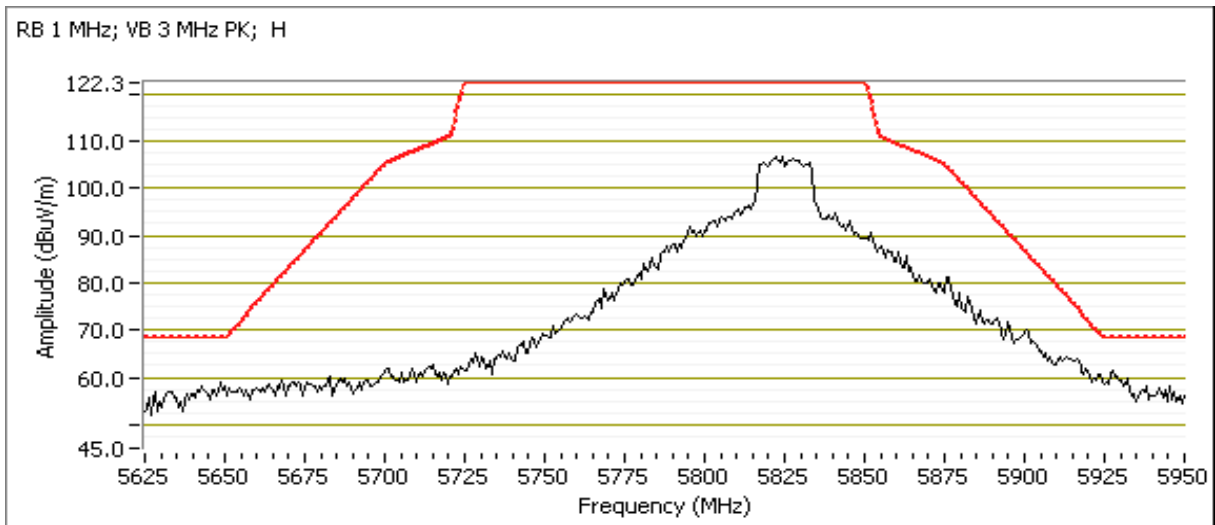

Client: Google Inc.	Job Number: JD104891
Model: Model H0A	T-Log Number: T104956
	Project Manager: Deepa Shetty
Contact: Dominik Mente	Project Coordinator: -
Standard: FCC 15.247 / 15.407 / RSS-247	Class: N/A

Run #5: Radiated Bandedge Measurements, 5150-5250MHz

Date of Test: 6/29/2017 0:00
 Test Engineer: Rafael Varelas
 Test Location: FT Chamber #7

Config. Used: 1
 Config Change: None
 EUT Voltage: USB

Channel: 36 - 5180 MHz
 Tx Chain: Antenna 2 (worse case based on preliminary measurements)
 Mode: n20
 Data Rate: MCS0

5150 MHz Band Edge Signal Radiated Field Strength

Frequency	Level	Pol	FCC 15.209		Detector	Azimuth	Height	Comments
MHz	dB μ V/m	v/h	Limit	Margin	Pk/QP/Avg	degrees	meters	
Antenna 2								
Power setting = 15								
5150.000	51.8	H	54.0	-2.2	AVG	15	1.2	POS; RB 1 MHz; VB: 10 Hz
5144.530	68.7	H	74.0	-5.3	PK	15	1.2	POS; RB 1 MHz; VB: 3 MHz

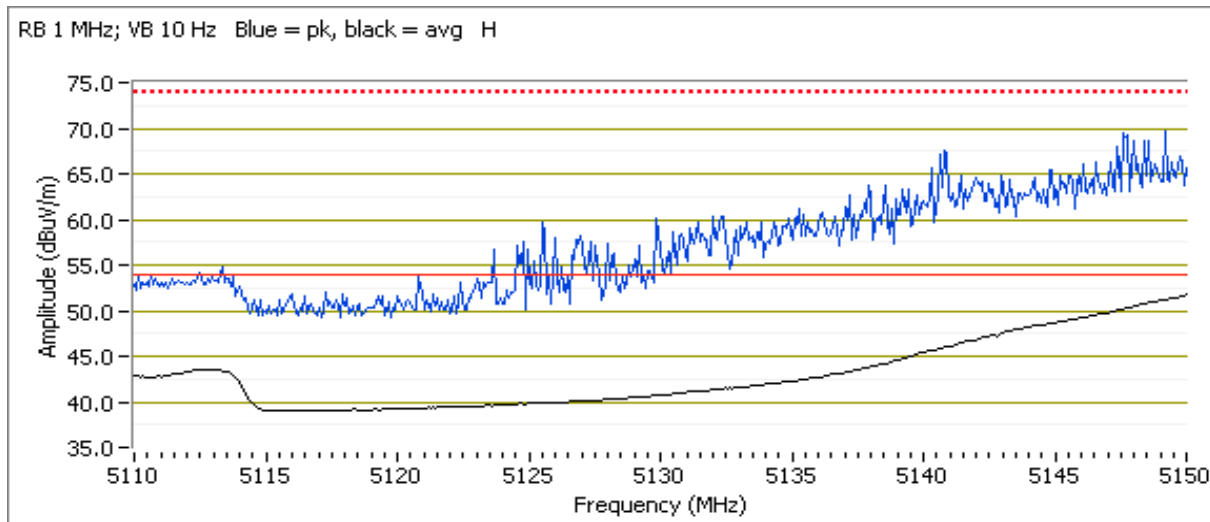



EMC Test Data

Client: Google Inc.	Job Number: JD104891
Model: Model H0A	T-Log Number: T104956
Contact: Dominik Mente	Project Manager: Deepa Shetty
Standard: FCC 15.247 / 15.407 / RSS-247	Project Coordinator: -
	Class: N/A

Run #6: Radiated Bandedge Measurements, 5250-5350MHz

Date of Test: 6/29/2017 0:00
 Test Engineer: Rafael Varelas
 Test Location: FT Chamber #7

Config. Used: 1
 Config Change: None
 EUT Voltage: USB

Channel: 64 - 5320MHz
 Tx Chain: See below
 Mode: n20
 Data Rate: MCS0

5350 MHz Band Edge Signal Radiated Field Strength

Frequency	Level	Pol	FCC 15.209		Detector	Azimuth	Height	Comments
MHz	dB μ V/m	v/h	Limit	Margin	Pk/QP/Avg	degrees	meters	
Antenna 1								
Power setting = 16								
5350.030	51.9	H	54.0	-2.1	AVG	321	1.0	POS; RB 1 MHz; VB: 10 Hz
5351.290	70.1	H	74.0	-3.9	PK	321	1.0	POS; RB 1 MHz; VB: 3 MHz
Antenna 2								
Power setting = 16								
5350.000	51.7	H	54.0	-2.3	AVG	140	1.0	POS; RB 1 MHz; VB: 10 Hz
5350.330	70.4	H	74.0	-3.6	PK	140	1.0	POS; RB 1 MHz; VB: 3 MHz

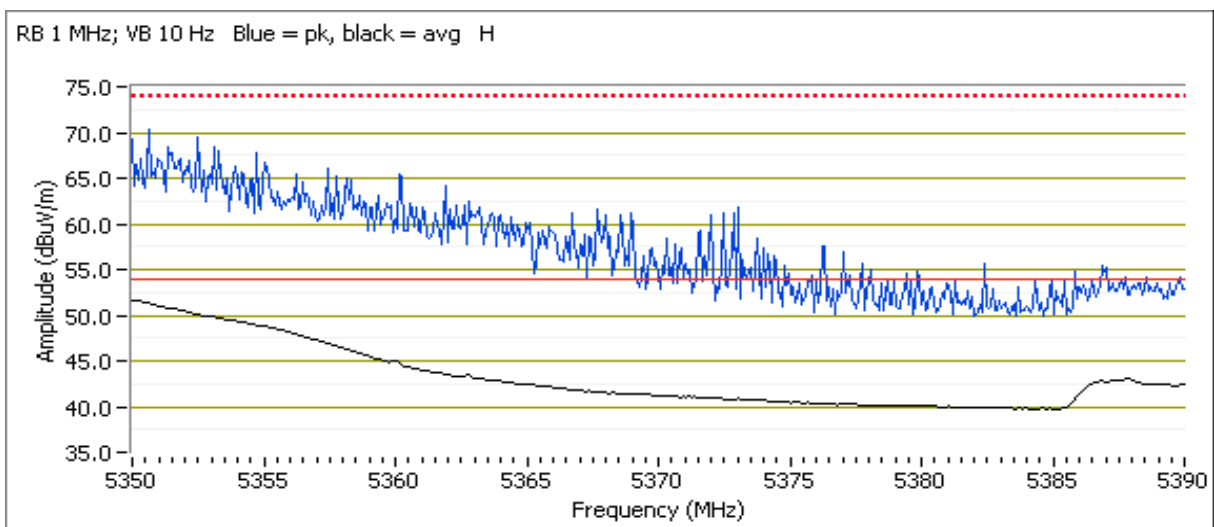



EMC Test Data

Client: Google Inc.	Job Number: JD104891
Model: Model H0A	T-Log Number: T104956
Contact: Dominik Mente	Project Manager: Deepa Shetty
Standard: FCC 15.247 / 15.407 / RSS-247	Project Coordinator: -
	Class: N/A

Run #7: Radiated Bandedge Measurements, 5470-5725MHz

Date of Test: 7/12/2017 0:00
 Test Engineer: Rafael Varelas
 Test Location: FT Chamber #7

Config. Used: 1
 Config Change: None
 EUT Voltage: USB

Channel: 100 - 5500MHz
 Tx Chain: Antenna 2 (worse case based on preliminary measurements)
 Mode: n20
 Data Rate: MCS0

5460 MHz Band Edge Signal Radiated Field Strength

Frequency	Level	Pol	FCC 15.209		Detector	Azimuth	Height	Comments
MHz	dB μ V/m	v/h	Limit	Margin	Pk/QP/Avg	degrees	meters	
Antenna 2								
Power setting = 15								
5427.860	46.1	H	54.0	-7.9	AVG	10	1.6	POS; RB 1 MHz; VB: 10 Hz
5453.110	63.3	H	74.0	-10.7	PK	10	1.6	POS; RB 1 MHz; VB: 3 MHz

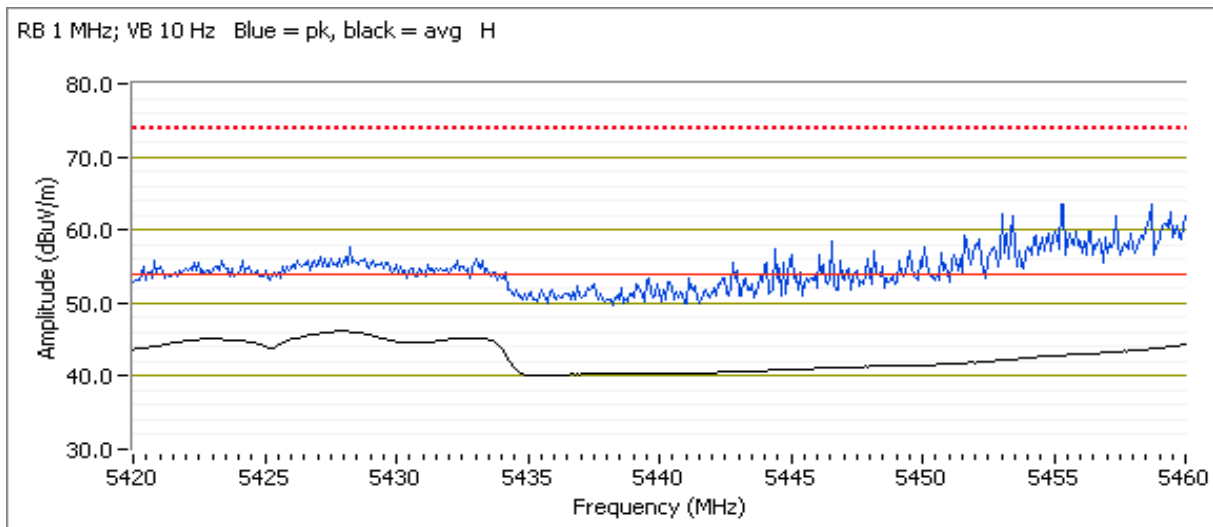



EMC Test Data

Client: Google Inc.	Job Number: JD104891
Model: Model H0A	T-Log Number: T104956
Contact: Dominik Mentel	Project Manager: Deepa Shetty
Standard: FCC 15.247 / 15.407 / RSS-247	Project Coordinator: -
	Class: N/A

5470 MHz Band Edge Signal Radiated Field Strength

Frequency MHz	Level dB μ V/m	Pol v/h	15.E		Detector Pk/QP/Avg	Azimuth degrees	Height meters	Comments
			Limit	Margin				
Antenna 2								
Power setting = 15								
5470.000	50.5	H	54.0	-3.5	AVG	0	1.6	POS; RB 1 MHz; VB: 10 Hz
5467.900	67.5	H	74.0	-6.5	PK	0	1.6	POS; RB 1 MHz; VB: 3 MHz

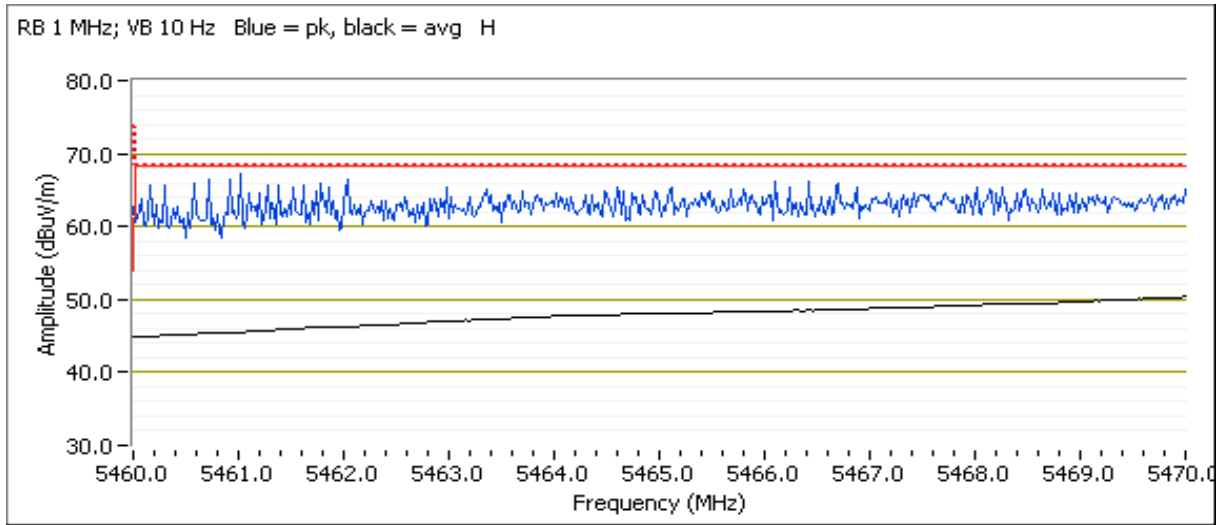



EMC Test Data

Client: Google Inc.	Job Number: JD104891
Model: Model H0A	T-Log Number: T104956
Contact: Dominik Mente	Project Manager: Deepa Shetty
Standard: FCC 15.247 / 15.407 / RSS-247	Project Coordinator: -
	Class: N/A

Date of Test: 7/12/2017 0:00
 Test Engineer: Rafael Varelas
 Test Location: FT Chamber #7

Config. Used: 1
 Config Change: None
 EUT Voltage: USB

Channel: 140 - 5700MHz
 Tx Chain: Antenna 2 (worse case based on preliminary measurements)
 Mode: n20
 Data Rate: MCS0

5725 MHz Band Edge Signal Radiated Field Strength

Frequency	Level	Pol	15.E		Detector	Azimuth	Height	Comments
MHz	dB μ V/m	v/h	Limit	Margin	Pk/QP/Avg	degrees	meters	
Antenna 2								
Power setting = 13								
5725.000	49.8	H	54.0	-4.2	AVG	64	1.4	POS; RB 1 MHz; VB: 10 Hz
5732.050	69.3	H	74.0	-4.7	PK	64	1.4	POS; RB 1 MHz; VB: 3 MHz

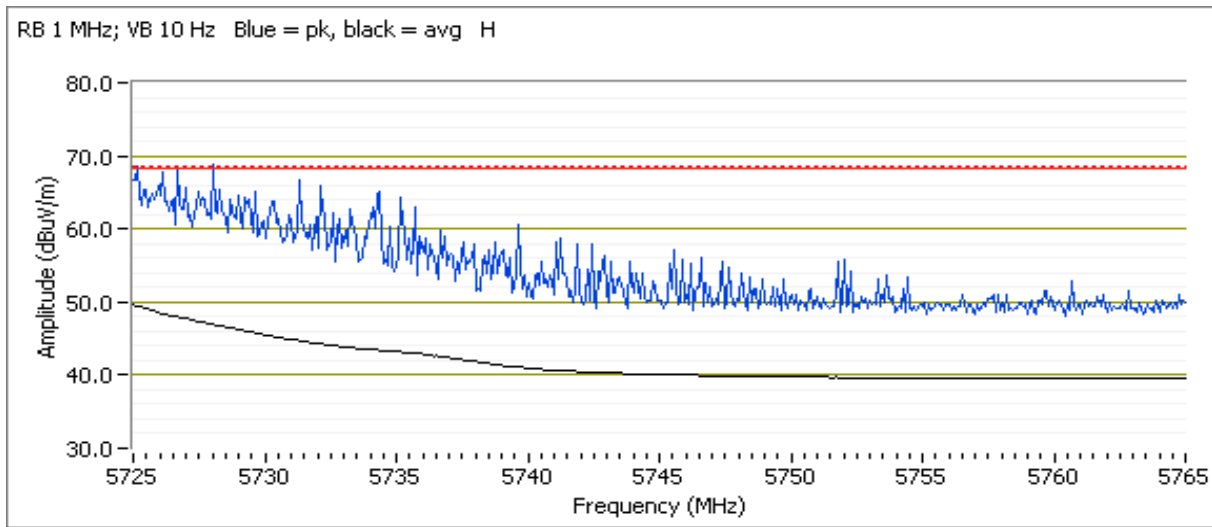



EMC Test Data

Client: Google Inc.	Job Number: JD104891
Model: Model H0A	T-Log Number: T104956
Contact: Dominik Mente	Project Manager: Deepa Shetty
Standard: FCC 15.247 / 15.407 / RSS-247	Project Coordinator: -
	Class: N/A

Run #8: Radiated Bandedge Measurements, 5725-5850MHz

Date of Test: 6/29/2017 0:00
 Test Engineer: Rafael Varelas
 Test Location: FT Chamber #7

Config. Used: 1
 Config Change: None
 EUT Voltage: USB

Channel: 149 - 5745MHz
 Tx Chain: Antenna 2 (worse case based on preliminary measurements)
 Mode: n20
 Data Rate: MCS0

5725 MHz Band Edge Signal Radiated Field Strength

Frequency	Level	Pol	15.E		Detector	Azimuth	Height	Comments
MHz	dB μ V/m	v/h	Limit	Margin	Pk/QP/Avg	degrees	meters	
5644.690	66.6	H	68.3	-1.7	PK	49	1.2	POS; RB 1 MHz; VB: 3 MHz
5932.620	64.7	H	68.3	-3.6	PK	49	1.2	POS; RB 1 MHz; VB: 3 MHz

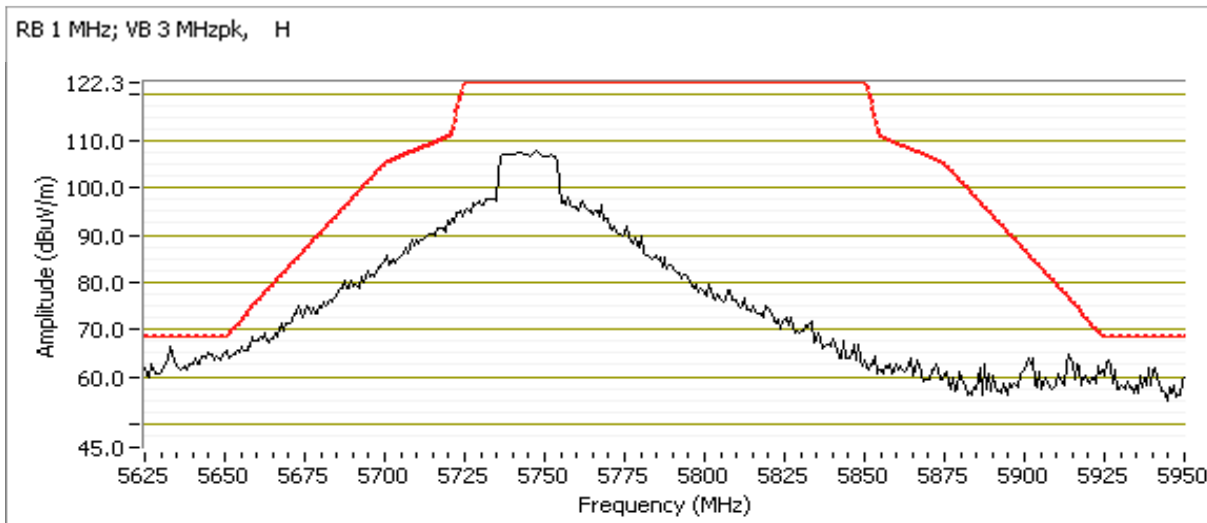

Client:	Google Inc.	Job Number:	JD104891
Model:	Model H0A	T-Log Number:	T104956
Contact:	Dominik Mente	Project Manager:	Deepa Shetty
Standard:	FCC 15.247 / 15.407 / RSS-247	Project Coordinator:	-
		Class:	N/A

Channel: 165 - 5825MHz
 Tx Chain: Antenna 2 (worse case based on preliminary measurements)
 Mode: n20
 Data Rate: MCS0

5850 MHz Band Edge Signal Radiated Field Strength

Frequency	Level	Pol	15.E		Detector	Azimuth	Height	Comments
MHz	dB μ V/m	v/h	Limit	Margin	Pk/QP/Avg	degrees	meters	
5928.560	65.2	H	68.3	-3.1	PK	117	1.0	POS; RB 1 MHz; VB: 3 MHz
5631.860	64.7	H	68.3	-3.6	PK	117	1.0	POS; RB 1 MHz; VB: 3 MHz

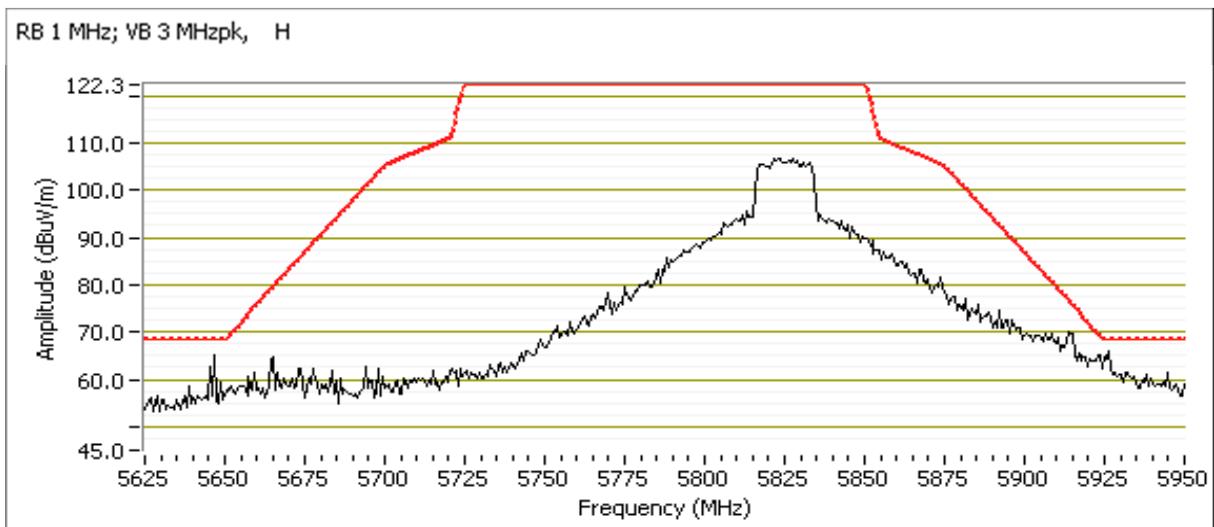



EMC Test Data

Client: Google Inc.	Job Number: JD104891
Model: Model H0A	T-Log Number: T104956
Contact: Dominik Mente	Project Manager: Deepa Shetty
Standard: FCC 15.247 / 15.407 / RSS-247	Project Coordinator: -
	Class: N/A

Run #9: Radiated Bandedge Measurements, 5150-5250MHz

Date of Test: 7/12/2017 0:00
 Test Engineer: Rafael Varelas
 Test Location: FT Chamber #7

Config. Used: 1
 Config Change: None
 EUT Voltage: USB

Channel: 38 - 5190 MHz
 Tx Chain: Antenna 2 (worse case based on preliminary measurements)
 Mode: n40
 Data Rate: MCS0

5150 MHz Band Edge Signal Radiated Field Strength

Frequency	Level	Pol	FCC 15.209		Detector	Azimuth	Height	Comments
MHz	dB μ V/m	v/h	Limit	Margin	Pk/QP/Avg	degrees	meters	
Power setting = 13								
5149.920	52.2	H	54.0	-1.8	AVG	27	1.0	POS; RB 1 MHz; VB: 10 Hz
5147.110	70.0	H	74.0	-4.0	PK	27	1.0	POS; RB 1 MHz; VB: 3 MHz

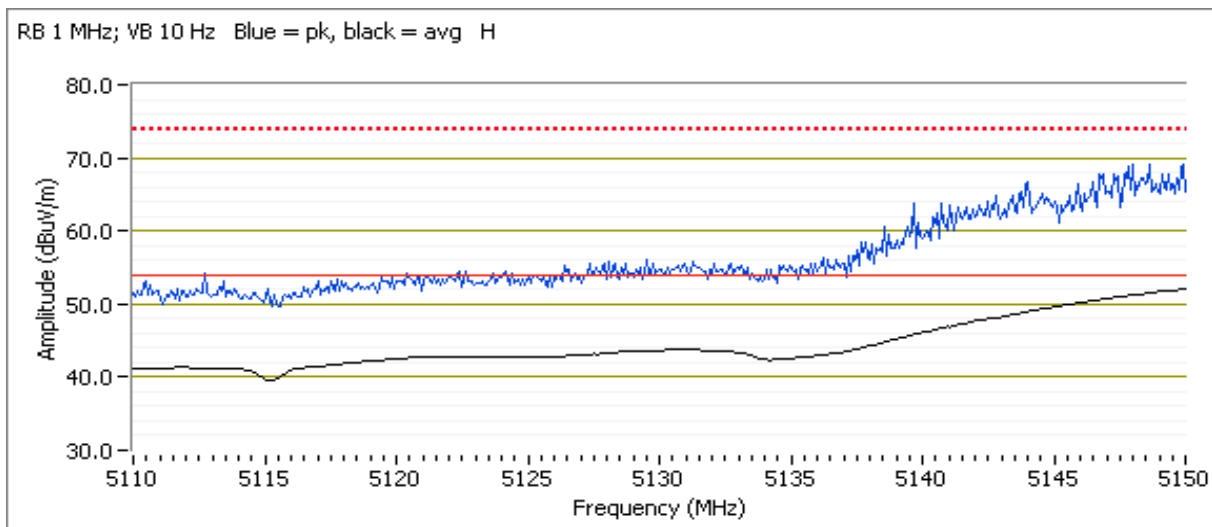



EMC Test Data

Client: Google Inc.	Job Number: JD104891
Model: Model H0A	T-Log Number: T104956
	Project Manager: Deepa Shetty
Contact: Dominik Mente	Project Coordinator: -
Standard: FCC 15.247 / 15.407 / RSS-247	Class: N/A

Run #10: Radiated Bandedge Measurements, 5250-5350MHz

Date of Test: 7/12/2017 0:00
 Test Engineer: Rafael Varelas
 Test Location: FT Chamber #7

Config. Used: 1
 Config Change: None
 EUT Voltage: USB

Channel: 62 - 5310MHz
 Tx Chain: Antenna 2 (worse case based on preliminary measurements)
 Mode: n40
 Data Rate: MCS0

5350 MHz Band Edge Signal Radiated Field Strength

Frequency	Level	Pol	FCC 15.209		Detector	Azimuth	Height	Comments
MHz	dB μ V/m	v/h	Limit	Margin	Pk/QP/Avg	degrees	meters	
Power setting = 13								
5350.080	52.0	H	54.0	-2.0	AVG	108	1.2	POS; RB 1 MHz; VB: 10 Hz
5352.240	68.0	H	74.0	-6.0	PK	108	1.2	POS; RB 1 MHz; VB: 3 MHz

Plot not available



EMC Test Data

Client: Google Inc.	Job Number: JD104891
Model: Model H0A	T-Log Number: T104956
Contact: Dominik Mente	Project Manager: Deepa Shetty
Standard: FCC 15.247 / 15.407 / RSS-247	Project Coordinator: -
	Class: N/A

Run #11: Radiated Bandedge Measurements, 5470-5725MHz

Date of Test: 7/12/2017 0:00
 Test Engineer: Rafael Varelas
 Test Location: FT Chamber #7

Config. Used: 1
 Config Change: None
 EUT Voltage: USB

Channel: 102 - 5510MHz
 Tx Chain: Antenna 2 (worse case based on preliminary measurements)
 Mode: n40
 Data Rate: MCS0

5460 MHz Band Edge Signal Radiated Field Strength

Frequency	Level	Pol	FCC 15.209		Detector	Azimuth	Height	Comments
MHz	dB μ V/m	v/h	Limit	Margin	Pk/QP/Avg	degrees	meters	
Power setting = 12								
5460.000	46.6	H	54.0	-7.4	AVG	18	1.8	POS; RB 1 MHz; VB: 10 Hz
5457.600	61.2	H	74.0	-12.8	PK	18	1.8	POS; RB 1 MHz; VB: 3 MHz

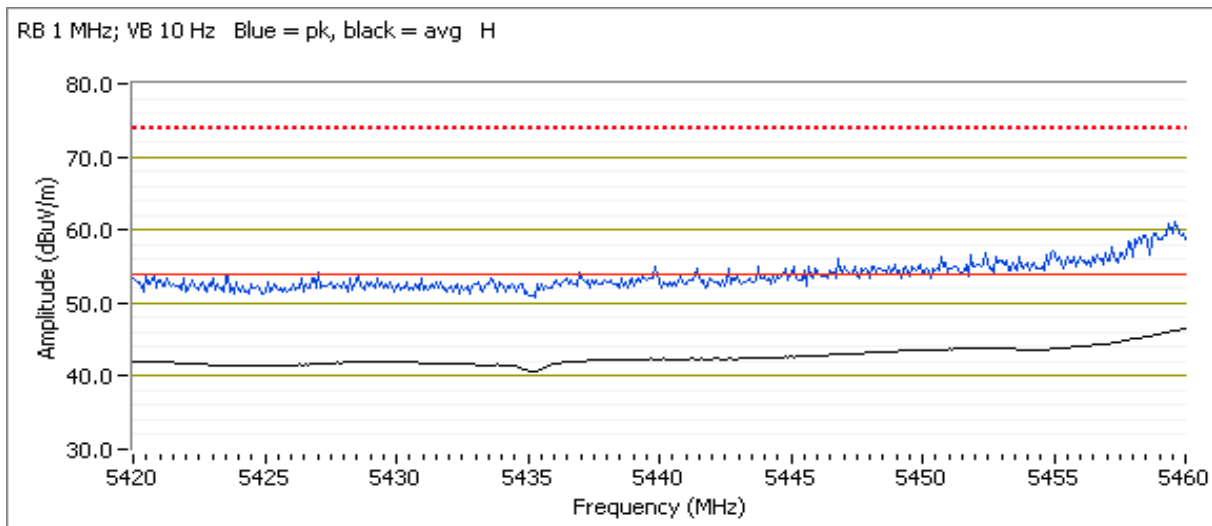

Client: Google Inc.	Job Number: JD104891
Model: Model H0A	T-Log Number: T104956
Contact: Dominik Mente	Project Manager: Deepa Shetty
Standard: FCC 15.247 / 15.407 / RSS-247	Project Coordinator: -
	Class: N/A

5470 MHz Band Edge Signal Radiated Field Strength

Frequency	Level	Pol	15.E		Detector	Azimuth	Height	Comments
MHz	dB μ V/m	v/h	Limit	Margin	Pk/QP/Avg	degrees	meters	
Power setting = 12								
5470.000	52.3	H	54.0	-1.7	AVG	12	1.6	POS; RB 1 MHz; VB: 10 Hz
5469.320	69.5	H	74.0	-4.5	PK	12	1.6	POS; RB 1 MHz; VB: 3 MHz

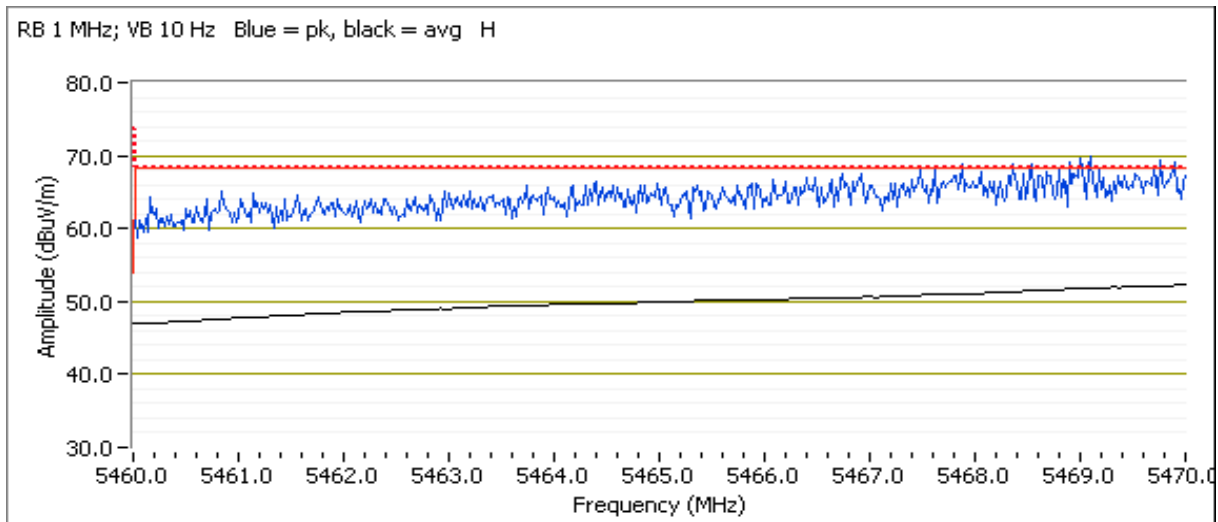



EMC Test Data

Client: Google Inc.	Job Number: JD104891
Model: Model H0A	T-Log Number: T104956
Contact: Dominik Mente	Project Manager: Deepa Shetty
Standard: FCC 15.247 / 15.407 / RSS-247	Project Coordinator: -
	Class: N/A

Date of Test: 7/12/2017 0:00
 Test Engineer: Rafael Varelas
 Test Location: FT Chamber #7

Config. Used: 1
 Config Change: None
 EUT Voltage: USB

Channel: 134 - 5670MHz
 Tx Chain: Antenna 2 (worse case based on preliminary measurements)
 Mode: n40
 Data Rate: MCS0

5725 MHz Band Edge Signal Radiated Field Strength

Frequency	Level	Pol	15.E		Detector	Azimuth	Height	Comments
MHz	dB μ V/m	v/h	Limit	Margin	Pk/QP/Avg	degrees	meters	
Power setting = 15								
5725.160	52.4	H	54.0	-1.6	AVG	54	1.1	POS; RB 1 MHz; VB: 10 Hz
5732.050	71.0	H	74.0	-3.0	PK	54	1.1	POS; RB 1 MHz; VB: 3 MHz

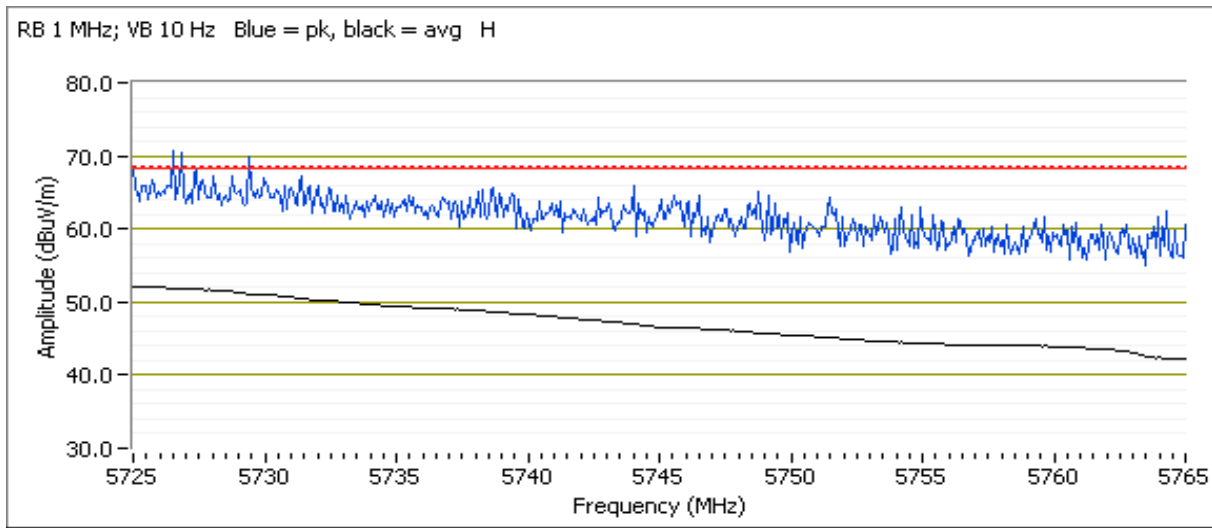



EMC Test Data

Client: Google Inc.	Job Number: JD104891
Model: Model H0A	T-Log Number: T104956
Contact: Dominik Mente	Project Manager: Deepa Shetty
Standard: FCC 15.247 / 15.407 / RSS-247	Project Coordinator: -
	Class: N/A

Run #12: Radiated Bandedge Measurements, 5725-5850MHz

Date of Test: 6/29/2017 0:00
 Test Engineer: Rafael Varelas
 Test Location: FT Chamber #7

Config. Used: 1
 Config Change: None
 EUT Voltage: USB

Channel: 151 - 5755MHz
 Tx Chain: Antenna 2 (worse case based on preliminary measurements)
 Mode: n40
 Data Rate: MCS0

5725 MHz Band Edge Signal Radiated Field Strength

Frequency	Level	Pol	15.E		Detector	Azimuth	Height	Comments
MHz	dB μ V/m	v/h	Limit	Margin	Pk/QP/Avg	degrees	meters	
5646.440	64.9	H	68.3	-3.4	PK	46	1.0	POS; RB 1 MHz; VB: 3 MHz

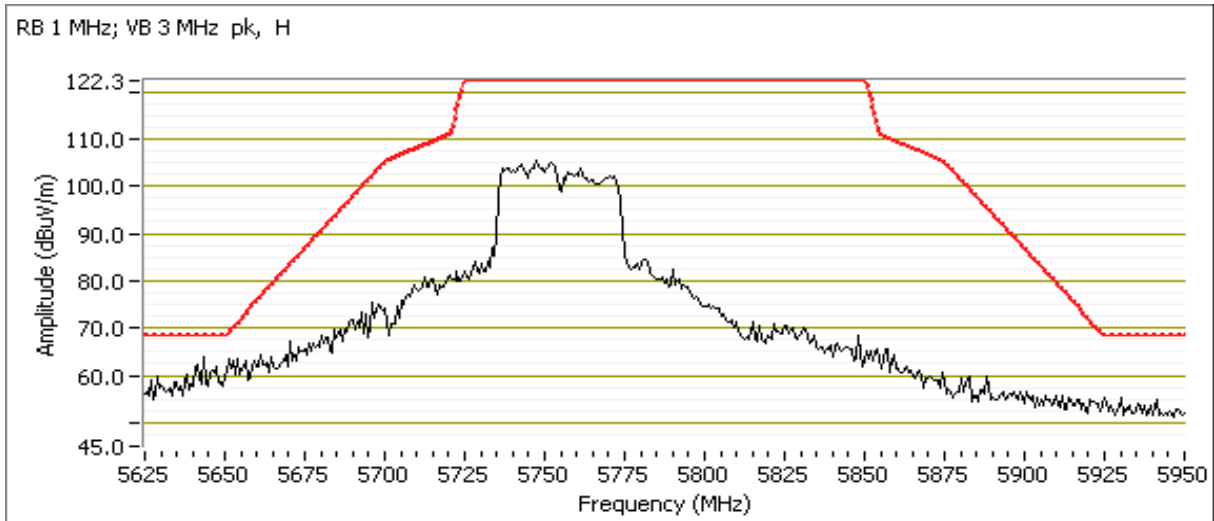

Client: Google Inc.	Job Number: JD104891
Model: Model H0A	T-Log Number: T104956
Contact: Dominik Mente	Project Manager: Deepa Shetty
Standard: FCC 15.247 / 15.407 / RSS-247	Project Coordinator: -
	Class: N/A

Channel: 159 - 5795MHz
 Tx Chain: Antenna 2 (worse case based on preliminary measurements)
 Mode: n40
 Data Rate: MCS0

5850 MHz Band Edge Signal Radiated Field Strength

Frequency	Level	Pol	15.E		Detector	Azimuth	Height	Comments
MHz	dB μ V/m	v/h	Limit	Margin	Pk/QP/Avg	degrees	meters	
5645.990	66.4	H	68.3	-1.9	PK	51	1.1	POS; RB 1 MHz; VB: 3 MHz
5948.900	63.2	H	68.3	-5.1	PK	51	1.1	POS; RB 1 MHz; VB: 3 MHz

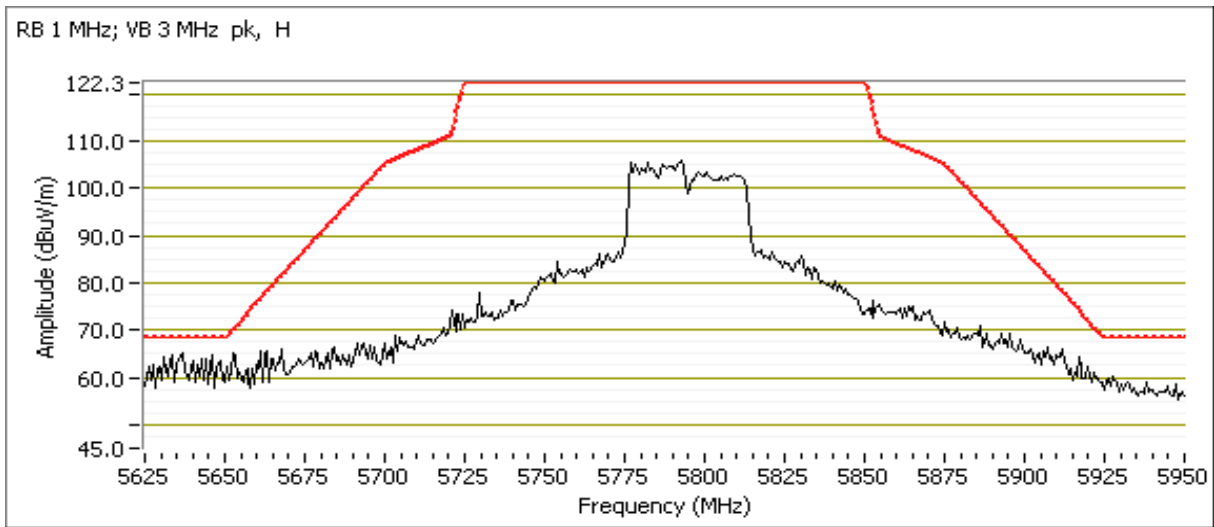



EMC Test Data

Client: Google Inc.	Job Number: JD104891
Model: Model H0A	T-Log Number: T104956
Contact: Dominik Mente	Project Manager: Deepa Shetty
Standard: FCC 15.247 / 15.407 / RSS-247	Project Coordinator: -
	Class: N/A

Run #13: Radiated Bandedge Measurements, 5150-5250MHz

Date of Test: 6/29/2017 0:00
 Test Engineer: Rafael Varelas
 Test Location: FT Chamber #7

Config. Used: 1
 Config Change: None
 EUT Voltage: USB

Channel: 42 - 5210MHz
 Tx Chain: Antenna 2 (worse case based on preliminary measurements)
 Mode: ac80
 Data Rate: VHT0

5150 MHz Band Edge Signal Radiated Field Strength

Frequency	Level	Pol	FCC 15.209		Detector	Azimuth	Height	Comments
MHz	dB μ V/m	v/h	Limit	Margin	Pk/QP/Avg	degrees	meters	
5140.500	51.6	H	54.0	-2.4	AVG	330	2.1	POS; RB 1 MHz; VB: 10 Hz
5130.640	66.0	H	74.0	-8.0	PK	330	2.1	POS; RB 1 MHz; VB: 3 MHz

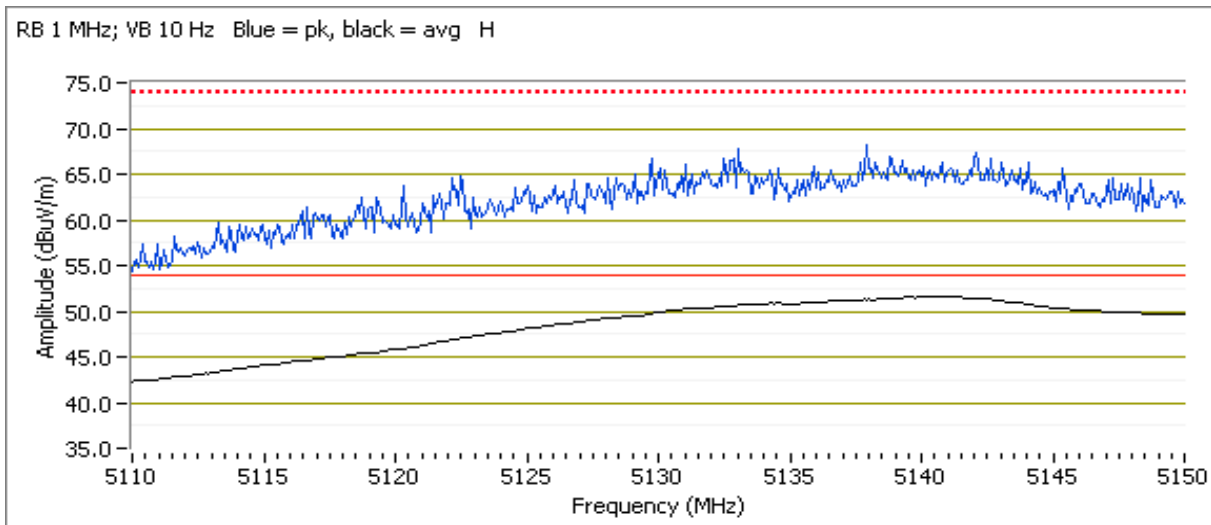



EMC Test Data

Client: Google Inc.	Job Number: JD104891
Model: Model H0A	T-Log Number: T104956
Contact: Dominik Mente	Project Manager: Deepa Shetty
Standard: FCC 15.247 / 15.407 / RSS-247	Project Coordinator: -
	Class: N/A

Run #14: Radiated Bandedge Measurements, 5250-5350MHz

Date of Test: 6/29/2017 0:00
 Test Engineer: Rafael Varelas
 Test Location: FT Chamber #7

Config. Used: 1
 Config Change: None
 EUT Voltage: USB

Channel: 58 - 5290MHz
 Tx Chain: Antenna 2 (worse case based on preliminary measurements)
 Mode: ac80
 Data Rate: VHT0

5350 MHz Band Edge Signal Radiated Field Strength

Frequency	Level	Pol	FCC 15.209		Detector	Azimuth	Height	Comments
MHz	dB μ V/m	v/h	Limit	Margin	Pk/QP/Avg	degrees	meters	
5363.730	52.1	H	54.0	-1.9	AVG	330	1.3	POS; RB 1 MHz; VB: 10 Hz
5362.420	68.8	H	74.0	-5.2	PK	330	1.3	POS; RB 1 MHz; VB: 3 MHz

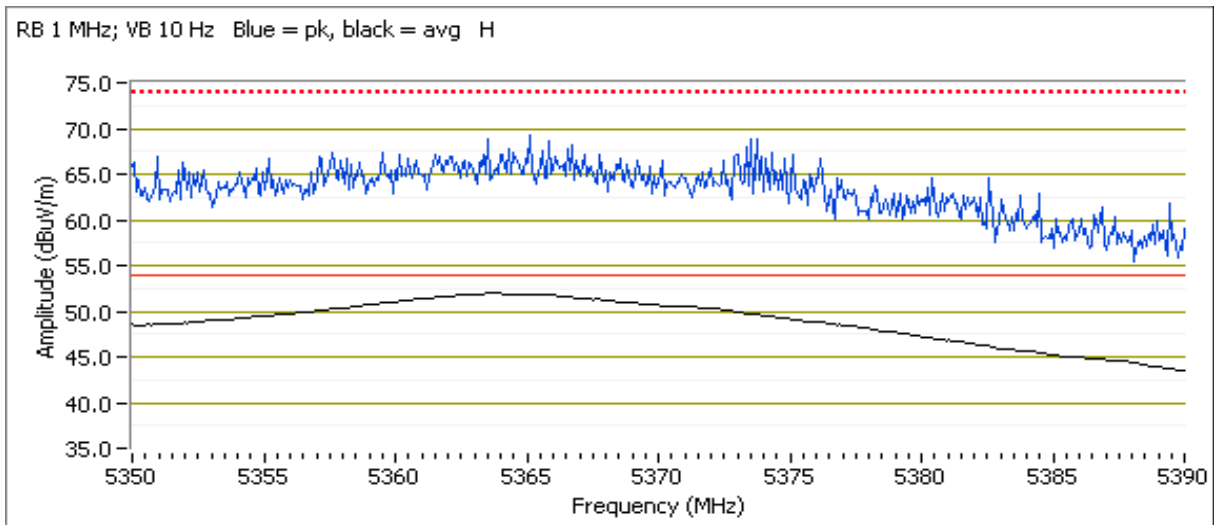



EMC Test Data

Client: Google Inc.	Job Number: JD104891
Model: Model H0A	T-Log Number: T104956
Contact: Dominik Mente	Project Manager: Deepa Shetty
Standard: FCC 15.247 / 15.407 / RSS-247	Project Coordinator: -
	Class: N/A

Run #15: Radiated Bandedge Measurements, 5470-5725MHz

Date of Test: 7/12/2017 0:00
 Test Engineer: Rafael Varelas
 Test Location: FT Chamber #7

Config. Used: 1
 Config Change: None
 EUT Voltage: USB

Channel: 106 - 5530MHz
 Tx Chain: Antenna 2 (worse case based on preliminary measurements)
 Mode: ac80
 Data Rate: VHT0

5460 MHz Band Edge Signal Radiated Field Strength

Frequency	Level	Pol	FCC 15.209		Detector	Azimuth	Height	Comments
MHz	dB μ V/m	v/h	Limit	Margin	Pk/QP/Avg	degrees	meters	
Power setting = 8								
5457.440	49.2	H	54.0	-4.8	AVG	4	1.1	POS; RB 1 MHz; VB: 10 Hz
5456.310	64.1	H	74.0	-9.9	PK	4	1.1	POS; RB 1 MHz; VB: 3 MHz

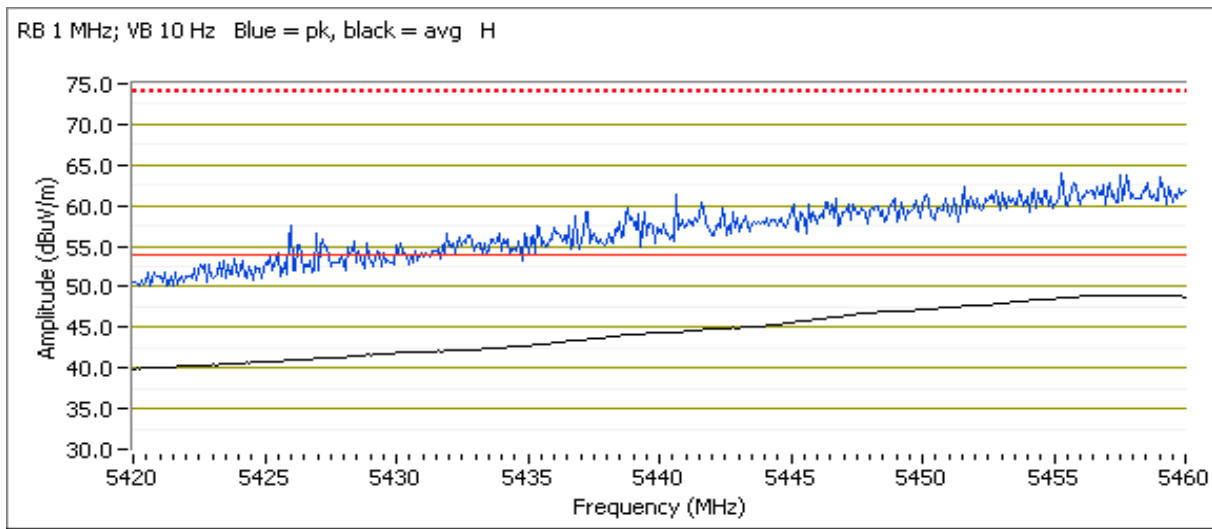

Client: Google Inc.	Job Number: JD104891
Model: Model H0A	T-Log Number: T104956
Contact: Dominik Mentel	Project Manager: Deepa Shetty
Standard: FCC 15.247 / 15.407 / RSS-247	Project Coordinator: -
	Class: N/A

5470 MHz Band Edge Signal Radiated Field Strength

Frequency MHz	Level dB μ V/m	Pol v/h	15.E		Detector Pk/QP/Avg	Azimuth degrees	Height meters	Comments
			Limit	Margin				
Power setting = 8								
5460.100	48.8	H	54.0	-5.2	AVG	4	1.1	POS; RB 1 MHz; VB: 10 Hz
5461.200	63.6	H	74.0	-10.4	PK	4	1.1	POS; RB 1 MHz; VB: 3 MHz

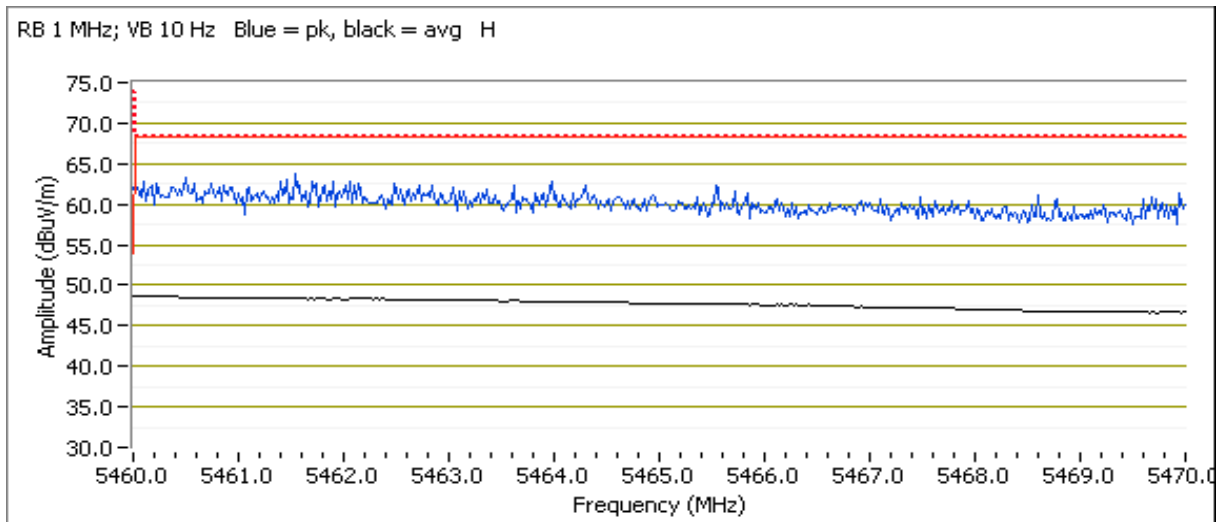



EMC Test Data

Client: Google Inc.	Job Number: JD104891
Model: Model H0A	T-Log Number: T104956
Contact: Dominik Mente	Project Manager: Deepa Shetty
Standard: FCC 15.247 / 15.407 / RSS-247	Project Coordinator: -
	Class: N/A

Run #16: Radiated Bandedge Measurements, 5725-5850MHz

Date of Test: 6/29/2017 0:00
 Test Engineer: Rafael Varelas
 Test Location: FT Chamber #7

Config. Used: 1
 Config Change: None
 EUT Voltage: USB

Channel: 155 - 5775MHz
 Tx Chain: Antenna 2 (worse case based on preliminary measurements)
 Mode: ac80
 Data Rate: VHT0

5725 MHz Band Edge Signal Radiated Field Strength

Frequency	Level	Pol	15.E		Detector	Azimuth	Height	Comments
MHz	dB μ V/m	v/h	Limit	Margin	Pk/QP/Avg	degrees	meters	
5642.540	66.5	H	68.3	-1.8	PK	31	1.0	POS; RB 1 MHz; VB: 3 MHz

5850 MHz Band Edge Signal Radiated Field Strength

Frequency	Level	Pol	15.E		Detector	Azimuth	Height	Comments
MHz	dB μ V/m	v/h	Limit	Margin	Pk/QP/Avg	degrees	meters	
5943.890	60.2	H	68.3	-8.1	PK	31	1.0	POS; RB 1 MHz; VB: 3 MHz

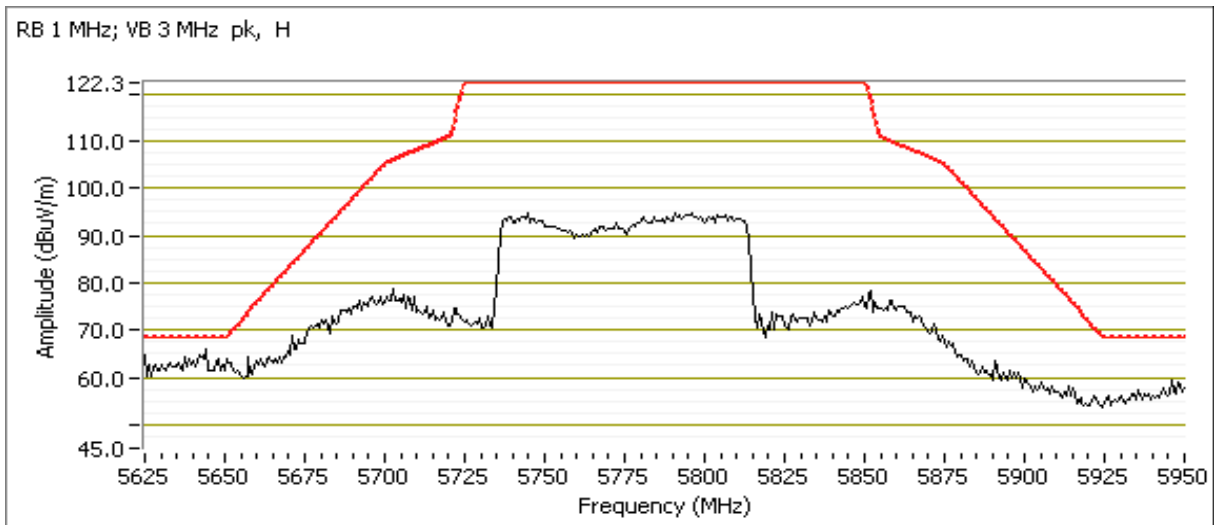



EMC Test Data

Client: Google Inc.	Job Number: JD104891
Model: Model H0A	T-Log Number: T104956
Contact: Dominik Mente	Project Manager: Deepa Shetty
Standard: FCC 15.247 / 15.407 / RSS-247	Project Coordinator: -
	Class: N/A

Run #17: Radiated Bandedge Measurements, 5470-5725MHz

Date of Test: 7/12/2017 0:00
 Test Engineer: Rafael Varelas
 Test Location: FT Chamber #7

Config. Used: 1
 Config Change: None
 EUT Voltage: USB

Channel: 138 - 5690MHz
 Tx Chain: Antenna 2 (worse case based on preliminary measurements)
 Mode: ac80
 Data Rate: VHT0

5850 MHz Band Edge Signal Radiated Field Strength

Frequency	Level	Pol	15.209		Detector	Azimuth	Height	Comments
MHz	dB μ V/m	v/h	Limit	Margin	Pk/QP/Avg	degrees	meters	
5859.800	51.0	H	54.0	-3.0	AVG	32	1.3	POS; RB 1 MHz; VB: 10 Hz
5859.500	67.8	H	74.0	-6.2	PK	32	1.3	POS; RB 1 MHz; VB: 3 MHz

5860 MHz Band Edge Signal Radiated Field Strength

Frequency	Level	Pol	15.209		Detector	Azimuth	Height	Comments
MHz	dB μ V/m	v/h	Limit	Margin	Pk/QP/Avg	degrees	meters	
5867.700	51.7	H	54.0	-2.3	AVG	32	1.3	POS; RB 1 MHz; VB: 10 Hz
5867.940	70.2	H	74.0	-3.8	PK	32	1.3	POS; RB 1 MHz; VB: 3 MHz

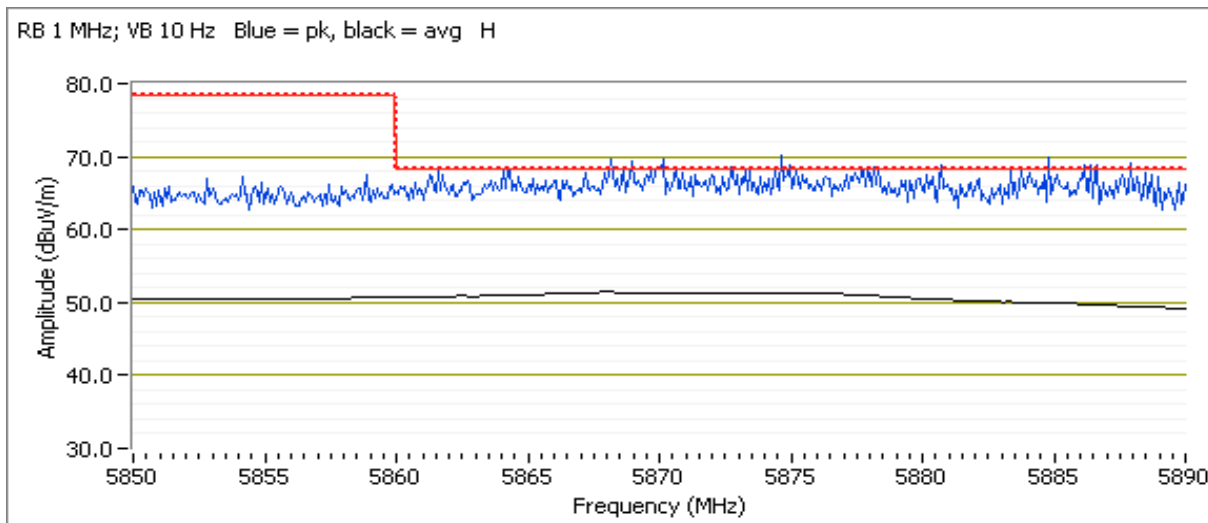



EMC Test Data

Client: Google Inc.	Job Number: JD104891
Model: Model H0A	T-Log Number: T104956
	Project Manager: Deepa Shetty
Contact: Dominik Mente	Project Coordinator: -
Standard: FCC 15.247 / 15.407 / RSS-247	Class: N/A

RSS-247 and FCC 15.407 (UNII) Radiated Spurious Emissions

Test Specific Details

Objective: The objective of this test session is to perform final qualification testing of the EUT with respect to the specification listed above.

General Test Configuration

The EUT and all local support equipment were located on the turntable for radiated spurious emissions testing. For radiated emissions testing the measurement antenna was located 3 meters from the EUT, unless otherwise noted.

Ambient Conditions:

Temperature: 22.6 °C
Rel. Humidity: 39 %

Summary of Results

Run #	Mode	Channel	Target Power (dBm)	Passing Power Setting	Test Performed	Limit	Result / Margin
Scans on "center" channel in all OFDM modes to determine the worst case mode.							
1	a	40 - 5200MHz	16	16	Radiated Emissions, 1 - 40 GHz	FCC 15.209 / 15 E	refer to test run - no EUT emissions found
	n20	40 - 5200MHz		16			refer to test run - no EUT emissions found
	n40	38 - 5190MHz		16			refer to test run - no EUT emissions found
	ac80	42 - 5210MHz		16			refer to test run - no EUT emissions found
Measurements on low and high channels in worst-case OFDM mode.							
2	11a	36 - 5180MHz	16	16	Radiated Emissions, 1 - 40 GHz	FCC 15.209 / 15 E	55.4 dBµV/m @ 10363.1 MHz (-12.9 dB)
		48 - 5240MHz		16			54.8 dBµV/m @ 10481.7 MHz (-13.5 dB)



EMC Test Data

Client: Google Inc.	Job Number: JD104891
Model: Model H0A	T-Log Number: T104956
	Project Manager: Deepa Shetty
Contact: Dominik Mente	Project Coordinator: -
Standard: FCC 15.247 / 15.407 / RSS-247	Class: N/A

Scans on "center" channel in all OFDM modes to determine the worst case mode.

3	a	60 - 5300MHz	16	16	Radiated Emissions, 1 - 40 GHz	FCC 15.209 / 15 E	42.1 dBµV/m @ 10604 MHz (-11.9 dB)	
	n20	60 - 5300MHz					16	42.0 dBµV/m @ 10604 MHz (-12.0 dB)
	n40	54 - 5270MHz					16	42.1 dBµV/m @ 10541 MHz (-11.9 dB)
	ac80	58 - 5290MHz					16	41.8 dBµV/m @ 10576 MHz (-12.2 dB)

Measurements on low and high channels in worst-case OFDM mode.

4	11a	52 - 5260MHz	16	16	Radiated Emissions, 1 - 40 GHz	FCC 15.209 / 15 E	54.2 dBµV/m @ 10518.0 MHz (-14.1 dB)
		64 - 5320MHz					16

Scans on "center" channel in all OFDM modes to determine the worst case mode.

5	a	116 - 5580MHz	16	16	Radiated Emissions, 1 - 40 GHz	FCC 15.209 / 15 E	42.0 dBµV/m @ 11156 MHz (-12.0 dB)	
	n20	116 - 5580MHz					16	42.0 dBµV/m @ 11159 MHz (-12.0 dB)
	n40	110 - 5550MHz					16	42.3 dBµV/m @ 11097 MHz (-11.7 dB)
	ac80	106 - 5530MHz					16	42.5 dBµV/m @ 11062 MHz (-11.5 dB)

Measurements on low and high channels in worst-case OFDM mode.

6	11a	100- 5500MHz	16	16	Radiated Emissions, 1 - 40 GHz	FCC 15.209 / 15 E	41.5 dBµV/m @ 11376.5 MHz (-12.5 dB)
	11a	144- 5720MHz					16

Scans on "center" channel in all OFDM modes to determine the worst case mode.

9	a	157 - 5785MHz	16	21	Radiated Emissions, 1 - 40 GHz	FCC 15.209 / 15 E	43.0 dBµV/m @ 11576.8 MHz (-11.0 dB)
	n20	157 - 5785MHz		21			63.9 dBµV/m @ 5598.6 MHz (-4.4 dB)
	n40	159 - 5795MHz		21			43.0 dBµV/m @ 11591.8 MHz (-11.0 dB)
	ac80	155 - 5775MHz		16			42.7 dBµV/m @ 11545.8 MHz (-11.3 dB)

Measurements on low and high channels in worst-case OFDM mode.

10	n20	149 - 5745MHz	16	21	Radiated Emissions, 1 - 40 GHz	FCC 15.209 / 15 E	42.6 dBµV/m @ 11490.7 MHz (-11.4 dB)
	n20	165- 5825MHz		21			43.5 dBµV/m @ 11659.1 MHz (-10.5 dB)

Client: Google Inc.	Job Number: JD104891
Model: Model H0A	T-Log Number: T104956
	Project Manager: Deepa Shetty
Contact: Dominik Mentel	Project Coordinator: -
Standard: FCC 15.247 / 15.407 / RSS-247	Class: N/A

Modifications Made During Testing

No modifications were made to the EUT during testing

Deviatio

ns From

No deviations were made from the requirements of the standard.

Procedure Comments:

Measurements performed in accordance with FCC KDB 789033

Peak measurements performed with: RBW=1MHz, VBW=3MHz, peak detector, max hold, auto sweep time

Unless otherwise stated/noted, emission has duty cycle $\geq 98\%$ and was measured using RBW=1MHz, VBW=10Hz, peak detector, linear average mode, auto sweep time, max hold 50 traces. (method VB of KDB 789033)

Mode	Data Rate	Duty Cycle (x)	Constant DC?	T (ms)	Pwr Cor Factor*	Lin Volt Cor Factor**	Min VBW for FS (Hz)
11a	6MB/s	0.99	Yes	2.157	0	0	10
11n20	MCS0	0.99	Yes	2.928	0	0	10
11n40	MCS0	0.981	Yes	2.335	0	0	10
ac80	VHT0	0.984	Yes	2.228	0	0	10

Sample Notes

Sample S/N: Engineering Radiated Sample #2

Driver: -

Antenna: internal

Measurement Specific Notes:

Note 1	For emissions in restricted bands, the limit of 15.209 was used which requires average and peak measurements.
Note 2	For emissions outside of the restricted bands the limit is -27dBm/MHz eirp (68.3dBuV/m). The measurement method required is a peak measurement (RB=1MHz, VB \geq 3MHz, peak detector). Per KDB 789033 2) c) (i), compliance can be demonstrated by meeting the average and peak limits of 15.209, as an alternative.



EMC Test Data

Client: Google Inc.	Job Number: JD104891
Model: Model H0A	T-Log Number: T104956
Contact: Dominik Mente	Project Manager: Deepa Shetty
Standard: FCC 15.247 / 15.407 / RSS-247	Project Coordinator: -
	Class: N/A

Run #1, Radiated Spurious Emissions, 1,000 - 40,000 MHz. Operation in the 5150-5250 MHz Band

Date of Test: 7/5/17 & 7/6/17
 Test Engineer: John Caizzi
 Test Location: Chamber 7

Config. Used: 1
 Config Change: none
 EUT Voltage: 120V/60Hz

Run #1a: Center Channel

Channel: 40 Mode: a
 Antenna 1 Data Rate: 6MB/s

Frequency MHz	Level dB μ V/m	Pol v/h	15.209 / 15E		Detector PK/QP/Avg	Azimuth degrees	Height meters	Comments
			Limit	Margin				
1331.730	31.7	V	54.0	-22.3	AVG	202	1.00	Not a radio signal.
1329.730	59.4	V	74.0	-14.6	PK	202	1.00	
2144.670	37.7	V	54.0	-16.3	AVG	164	1.00	Not a radio signal.
2178.270	54.9	V	74.0	-19.1	PK	164	1.00	
2178.270	54.9	V	68.3	-13.4	PK	164	1.00	
2665.940	30.8	V	54.0	-23.2	AVG	227	1.00	Not a radio signal.
2662.200	56.9	V	74.0	-17.1	PK	227	1.00	
2662.200	56.9	V	68.3	-11.4	PK	227	1.00	

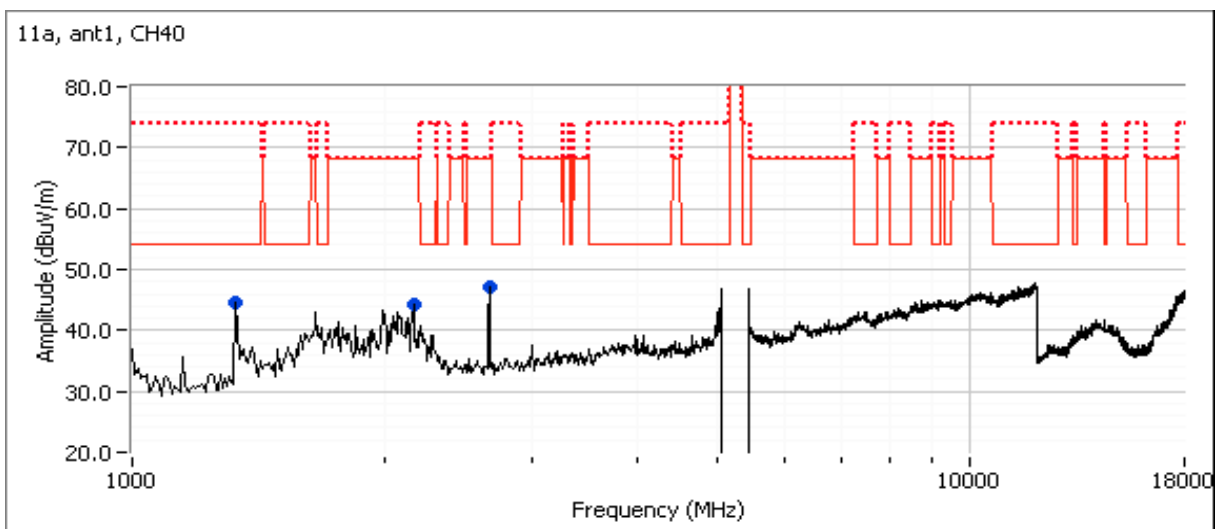

Client: Google Inc.	Job Number: JD104891
Model: Model H0A	T-Log Number: T104956
	Project Manager: Deepa Shetty
Contact: Dominik Mente	Project Coordinator: -
Standard: FCC 15.247 / 15.407 / RSS-247	Class: N/A

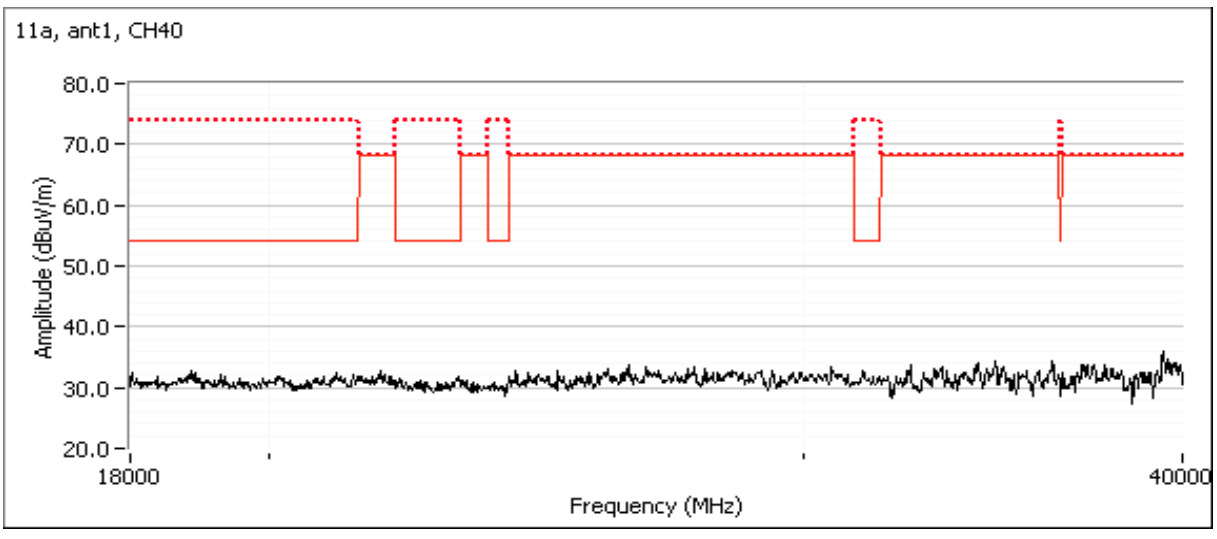



EMC Test Data

Client: Google Inc.	Job Number: JD104891
Model: Model H0A	T-Log Number: T104956
Contact: Dominik Mente	Project Manager: Deepa Shetty
Standard: FCC 15.247 / 15.407 / RSS-247	Project Coordinator: -
	Class: N/A

Run #1a: Center Channel

Channel: 40 Mode: a
 Antenna 2 Data Rate: 6MB/s

Frequency MHz	Level dB μ V/m	Pol v/h	15.209 / 15E		Detector Pk/QP/Avg	Azimuth degrees	Height meters	Comments
			Limit	Margin				
1325.000	47.1	V	54.0	-6.9	Peak	40	1.0	Not a radio signal. See ant1 run.
2666.670	42.2	V	68.3	-26.1	Peak	281	1.0	Not a radio signal. See ant1 run.
3971.800	31.6	V	54.0	-22.4	AVG	111	1.0	Not a radio signal.
3994.470	56.0	V	74.0	-18.0	PK	111	1.0	
4662.270	31.7	V	54.0	-22.3	AVG	199	1.00	Not a radio signal.
4652.400	52.1	V	74.0	-21.9	PK	199	1.00	

Note 1: There was no difference in the level of radio signals between antenna 1 & antenna 2. Antenna 2 was chosen for all subsequent tests.

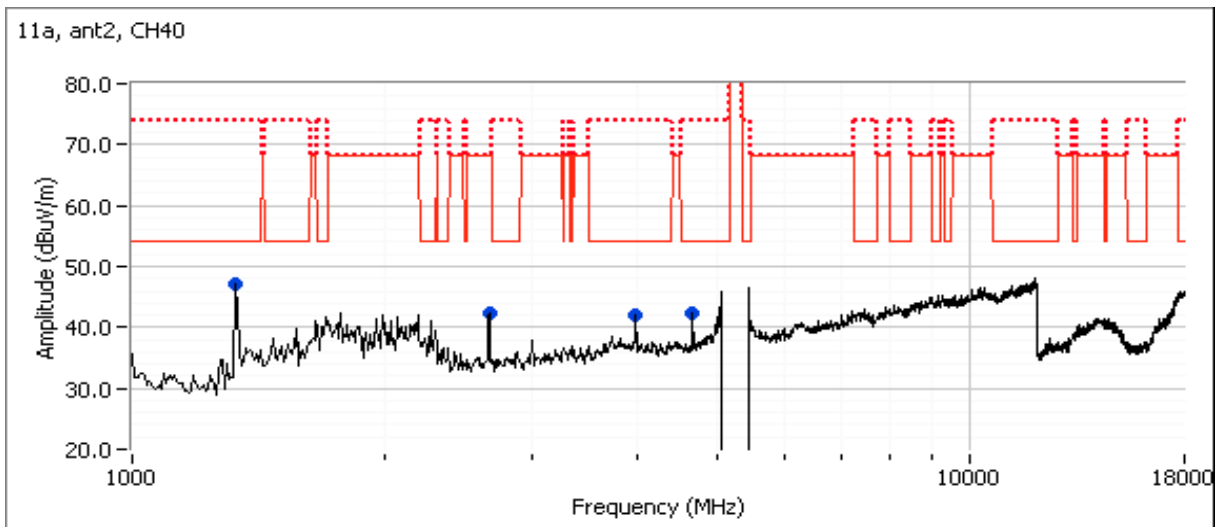

Client: Google Inc.	Job Number: JD104891
Model: Model H0A	T-Log Number: T104956
	Project Manager: Deepa Shetty
Contact: Dominik Mentel	Project Coordinator: -
Standard: FCC 15.247 / 15.407 / RSS-247	Class: N/A

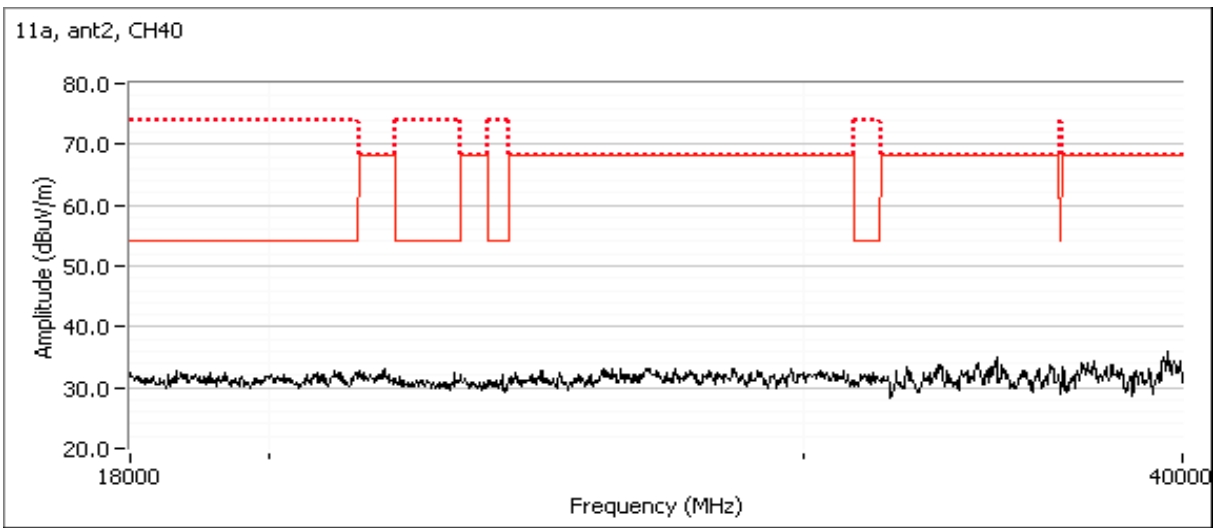



EMC Test Data

Client: Google Inc.	Job Number: JD104891
Model: Model H0A	T-Log Number: T104956
Contact: Dominik Mentel	Project Manager: Deepa Shetty
Standard: FCC 15.247 / 15.407 / RSS-247	Project Coordinator: -
	Class: N/A

Run #1b: Center Channel

Channel: 40 Mode: 11n20
 Antenna 2 Data Rate: MCS0

Frequency MHz	Level dB μ V/m	Pol v/h	15.209 / 15E		Detector Pk/QP/Avg	Azimuth degrees	Height meters	Comments
			Limit	Margin				
1325.000	44.0	V	54.0	-10.0	Peak	215	1.0	Not a radio signal. See run 1a.
1997.140	35.3	V	54.0	-18.7	AVG	174	1.00	Not a radio signal.
1993.270	58.3	V	74.0	-15.7	PK	174	1.00	
1993.270	58.3	V	68.3	-10.0	PK	174	1.00	
2658.330	44.0	H	68.3	-24.3	Peak	100	1.5	Not a radio signal. See run 1a.
3991.670	40.5	H	54.0	-13.5	Peak	122	1.5	Not a radio signal. See run 1a.
4658.330	40.7	V	54.0	-13.3	Peak	199	1.0	Not a radio signal. See run 1a.

Note: Scans made between 18 - 40 GHz with the measurement antenna moved around the EUT and its antennas, 20-50cm from the device, indicated there were no significant emissions in this frequency range

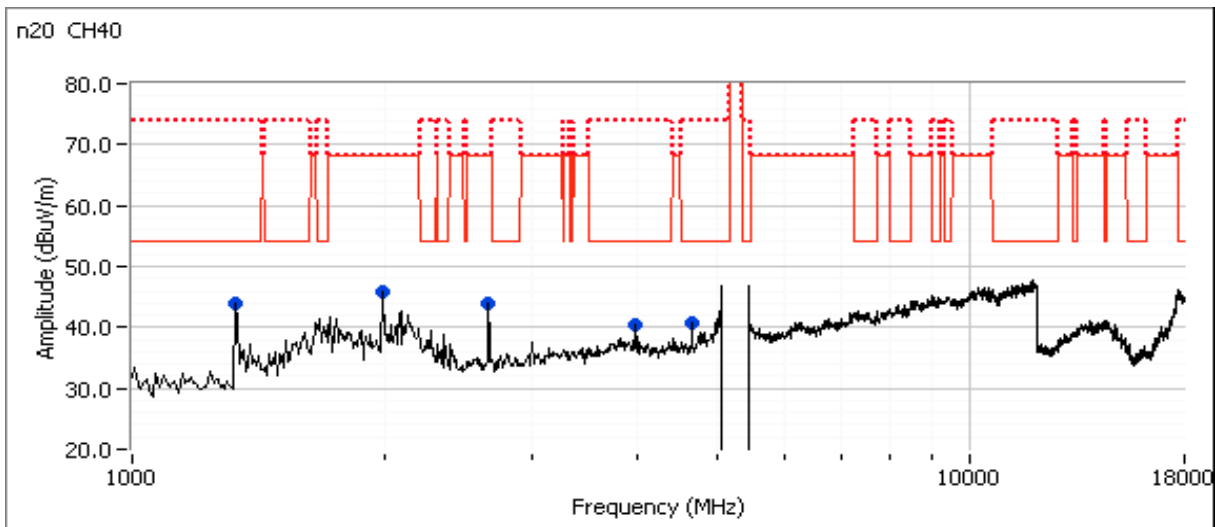

Client: Google Inc.	Job Number: JD104891
Model: Model H0A	T-Log Number: T104956
Contact: Dominik Mente	Project Manager: Deepa Shetty
Standard: FCC 15.247 / 15.407 / RSS-247	Project Coordinator: -
	Class: N/A

Run #1c: Center Channel

Channel: 38 Mode: 11n40
 Antenna 2 Data Rate: MCS0

Frequency MHz	Level dB μ V/m	Pol v/h	15.209 / 15E		Detector Pk/QP/Avg	Azimuth degrees	Height meters	Comments
			Limit	Margin				
1333.330	45.0	V	54.0	-9.0	Peak	119	2.5	Not a radio signal. See run 1a.
1991.670	43.4	V	68.3	-24.9	Peak	170	1.0	Not a radio signal. See run 1b.
2071.200	32.8	V	54.0	-21.2	AVG	156	1.1	Not a radio signal.
2080.800	55.6	V	74.0	-18.4	PK	156	1.1	
2080.800	55.6	V	68.3	-12.7	PK	156	1.1	

Note: Scans made between 18 - 40 GHz with the measurement antenna moved around the EUT and its antennas, 20-50cm from the device, indicated there were no significant emissions in this frequency range

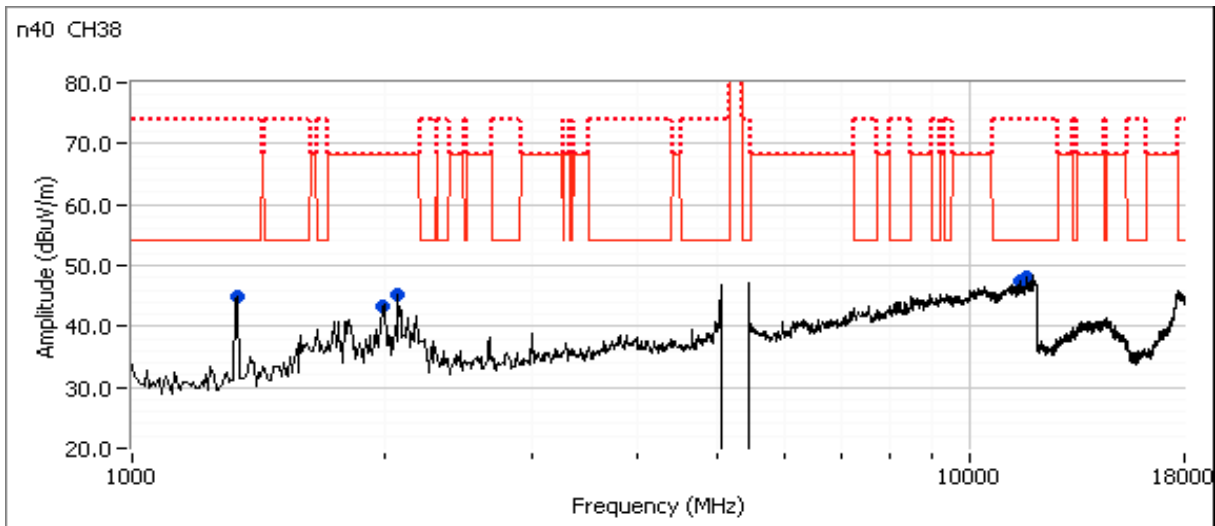

Client: Google Inc.	Job Number: JD104891
Model: Model H0A	T-Log Number: T104956
Contact: Dominik Mente	Project Manager: Deepa Shetty
Standard: FCC 15.247 / 15.407 / RSS-247	Project Coordinator: -
	Class: N/A

Run #1d: Center Channel

Channel: 42 Mode: ac80
 Antenna 2 Data Rate: VHT0

Frequency MHz	Level dB μ V/m	Pol v/h	15.209 / 15E		Detector PK/QP/Avg	Azimuth degrees	Height meters	Comments
			Limit	Margin				
1325.000	45.3	V	54.0	-8.7	Peak	134	1.5	Not a radio signal. See run 1a.
2658.330	41.6	V	68.3	-26.7	Peak	120	1.0	Not a radio signal. See run 1a.
2991.100	32.6	V	54.0	-21.4	AVG	167	1.00	Not a radio signal.
2991.070	47.2	V	74.0	-26.8	PK	167	1.00	
2991.070	47.2	V	68.3	-21.1	PK	167	1.00	
5041.670	-	H	-	-	Peak	-	-	Captured during bandedge measurements.
5425.000	-	H	-	-	Peak	-	-	Captured during bandedge measurements.

Note: Scans made between 18 - 40 GHz with the measurement antenna moved around the EUT and its antennas, 20-50cm from the device, indicated there were no significant emissions in this frequency range

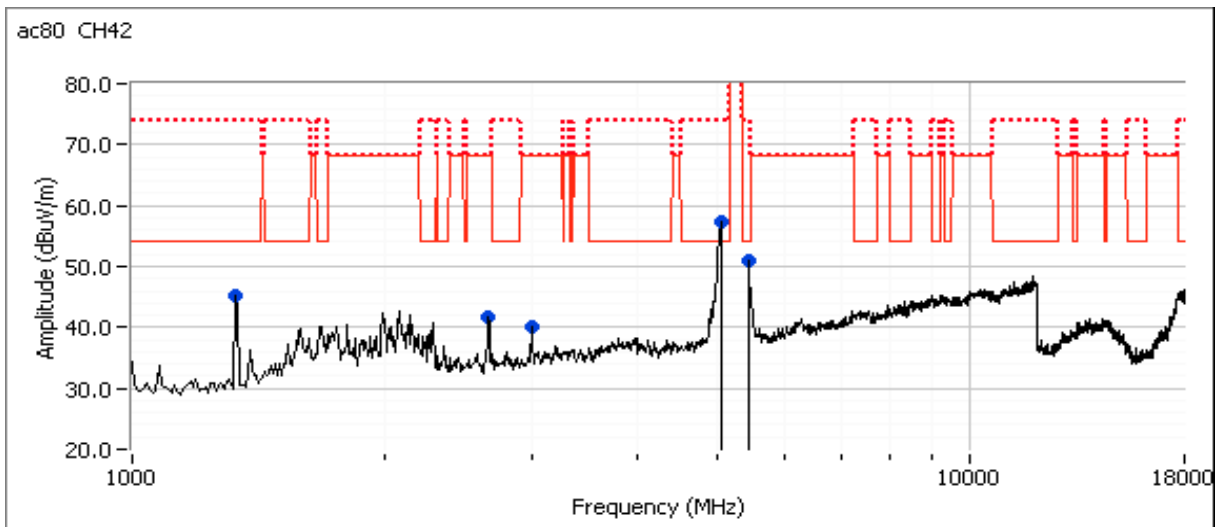



EMC Test Data

Client: Google Inc.	Job Number: JD104891
Model: Model H0A	T-Log Number: T104956
Contact: Dominik Mente	Project Manager: Deepa Shetty
Standard: FCC 15.247 / 15.407 / RSS-247	Project Coordinator: -
	Class: N/A

Run #2: Radiated Spurious Emissions, 1,000 - 40000 MHz. Operating Mode: Worse case from Run #1

Date of Test: 7/6/2017
 Test Engineer: Rafael Varelas
 Test Location: Chamber 7

Config. Used: 1
 Config Change: none
 EUT Voltage: 120V/60Hz

Run #2a: Low Channel

Channel: 36 Mode: 11a
 Antenna 2 Data Rate: 6 Mbps

Frequency MHz	Level dB μ V/m	Pol v/h	15.209 / 15E		Detector PK/QP/Avg	Azimuth degrees	Height meters	Comments
			Limit	Margin				
10363.120	55.4	V	68.3	-12.9	PK	26	2.2	RB 1 MHz;VB 3 MHz;Peak
1333.330	41.9	V	54.0	-12.1	Peak	174	2.0	Not a radio signal. See run 1a.
1991.670	47.2	V	68.3	-21.1	Peak	155	1.0	Not a radio signal. See run 1b.
2658.330	45.4	V	68.3	-22.9	Peak	80	1.0	Not a radio signal. See run 1a.
3983.330	43.1	H	54.0	-10.9	Peak	131	1.0	Not a radio signal. See run 1d.

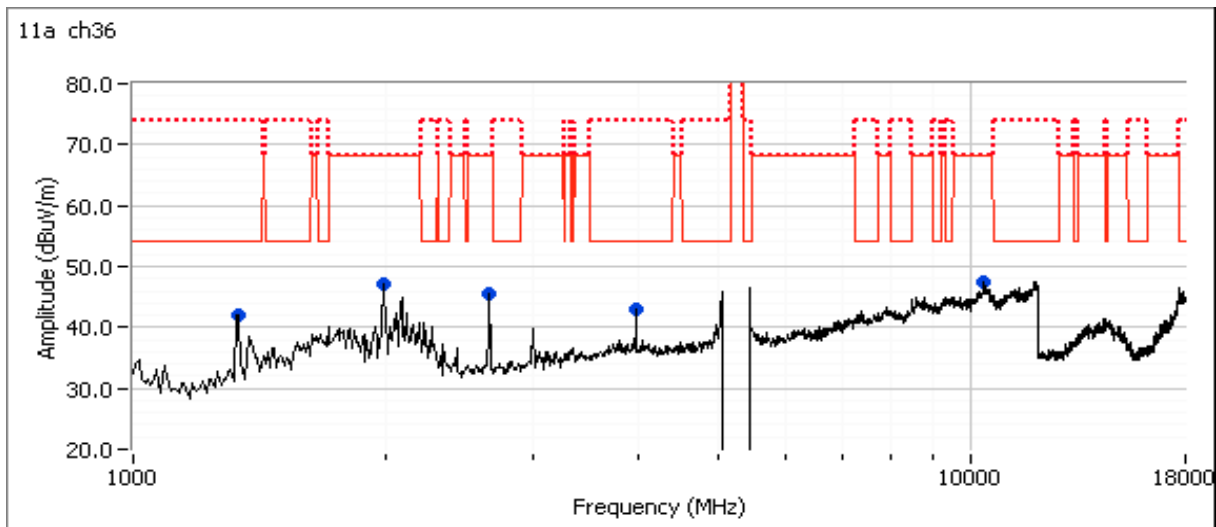

Client: Google Inc.	Job Number: JD104891
Model: Model H0A	T-Log Number: T104956
Contact: Dominik Mente	Project Manager: Deepa Shetty
Standard: FCC 15.247 / 15.407 / RSS-247	Project Coordinator: -
	Class: N/A

Run #2b: High Channel

Channel: 48 Mode: 11a
 Antenna 2 Data Rate: 6 Mbps

Frequency	Level	Pol	15.209 / 15E		Detector	Azimuth	Height	Comments
MHz	dB μ V/m	v/h	Limit	Margin	Pk/QP/Avg	degrees	meters	
10481.670	54.8	H	68.3	-13.5	PK	4	1.0	RB 1 MHz;VB 3 MHz;Peak
1325.000	41.8	V	54.0	-12.2	Peak	25	1.0	Not a radio signal. See run 1a.
1991.670	42.2	V	68.3	-26.1	Peak	101	1.5	Not a radio signal. See run 1b.
2658.330	41.2	V	68.3	-27.1	Peak	289	2.0	Not a radio signal. See run 1a.

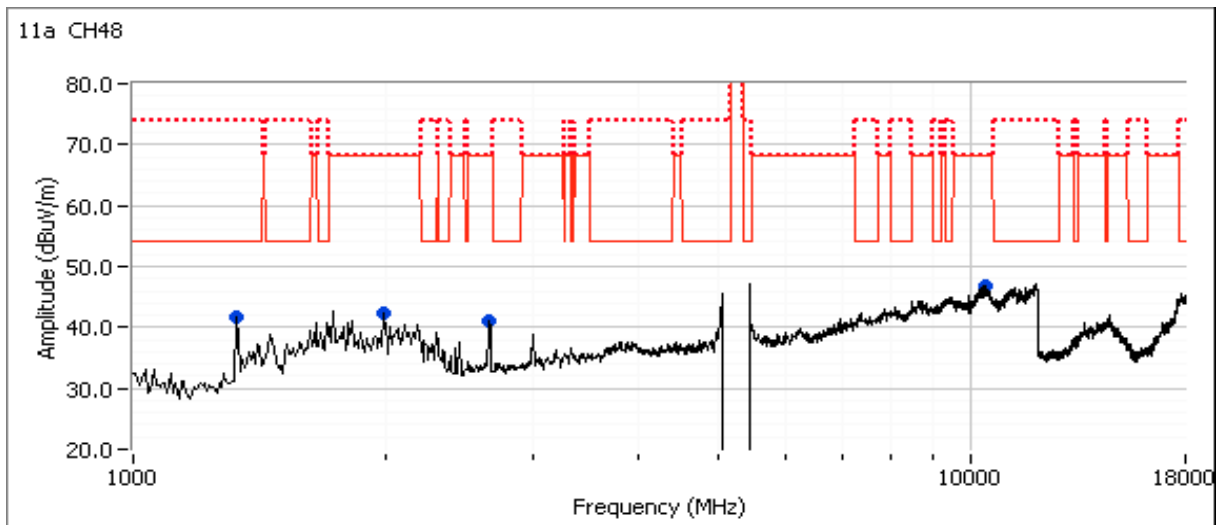



EMC Test Data

Client: Google Inc.	Job Number: JD104891
Model: Model H0A	T-Log Number: T104956
	Project Manager: Deepa Shetty
Contact: Dominik Mente	Project Coordinator: -
Standard: FCC 15.247 / 15.407 / RSS-247	Class: N/A

Run #3, Radiated Spurious Emissions, 1,000 - 40,000 MHz. Operation in the 5250-5350 MHz Band

Date of Test: 7/5/17 & 7/6/17
 Test Engineer: John Caizzi
 Test Location: Chamber 7

Config. Used: 1
 Config Change: none
 EUT Voltage: 120V/60Hz

Run #3a: Center Channel

Channel: 60 Mode: a
 Antenna 2 Data Rate: 6MB/s

Frequency MHz	Level dB μ V/m	Pol v/h	15.209 / 15E		Detector PK/QP/Avg	Azimuth degrees	Height meters	Comments
			Limit	Margin				
1325.000	43.1	V	54.0	-10.9	Peak	150	1.0	Not a radio signal. See run 1a.
2000.000	43.2	V	68.3	-25.1	Peak	125	1.0	Not a radio signal. See run 1b.
2658.330	42.0	V	68.3	-26.3	Peak	114	1.0	Not a radio signal. See run 1a.
2993.470	32.2	V	54.0	-21.8	AVG	172	1.04	Not a radio signal. See run 1d.
2995.940	46.4	V	74.0	-27.6	PK	172	1.04	
2995.940	46.4	V	68.3	-21.9	PK	172	1.0	
10604.590	42.1	H	54.0	-11.9	AVG	283	1.0	
10601.900	55.3	H	74.0	-18.7	PK	283	1.0	

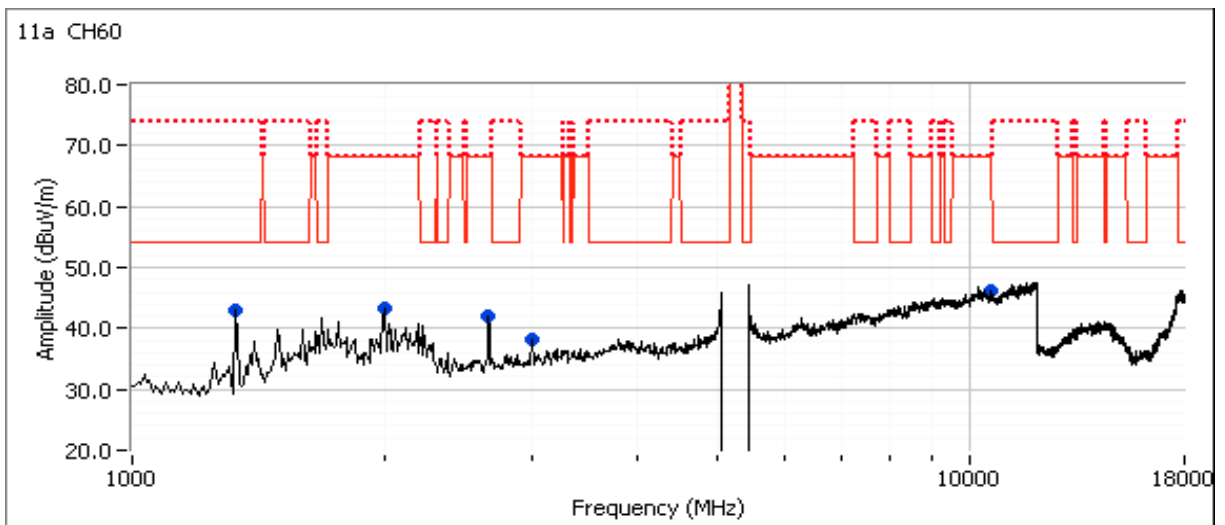

Client: Google Inc.	Job Number: JD104891
Model: Model H0A	T-Log Number: T104956
	Project Manager: Deepa Shetty
Contact: Dominik Mente	Project Coordinator: -
Standard: FCC 15.247 / 15.407 / RSS-247	Class: N/A

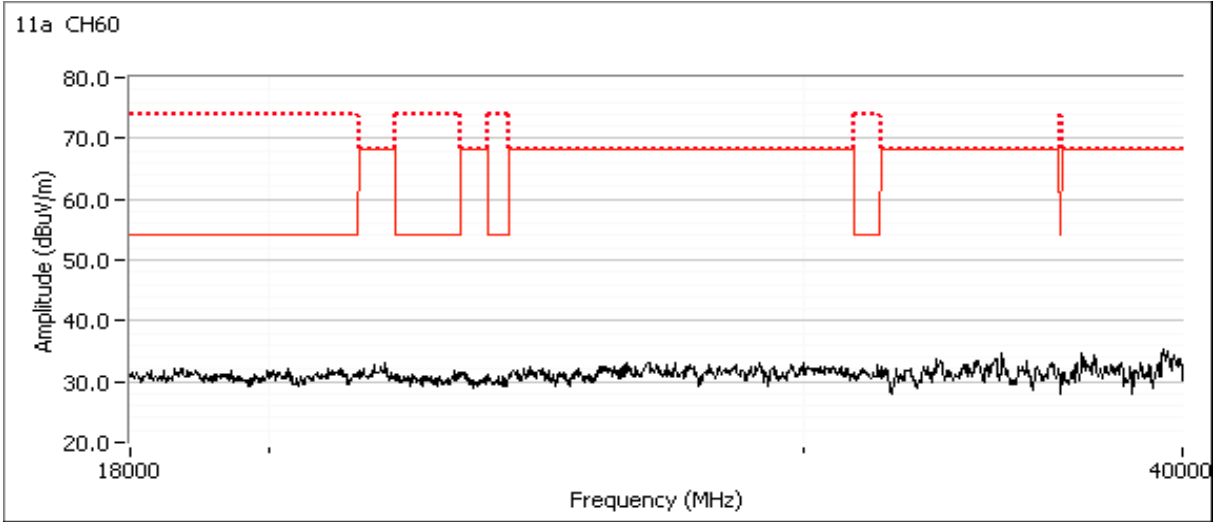

Client: Google Inc.	Job Number: JD104891
Model: Model H0A	T-Log Number: T104956
Contact: Dominik Mente	Project Manager: Deepa Shetty
Standard: FCC 15.247 / 15.407 / RSS-247	Project Coordinator: -
	Class: N/A

Run #3b: Center Channel

Date of Test: 7/5/17 & 7/6/17
 Test Engineer: Rafael Varelas, John Caizzi
 Test Location: Chamber 7

Config. Used: 1
 Config Change: none
 EUT Voltage: 120V/60Hz

Channel: 60 Mode: 11n20
 Antenna 2 Data Rate: MCS0

Frequency MHz	Level dB μ V/m	Pol v/h	15.209 / 15E		Detector Pk/QP/Avg	Azimuth degrees	Height meters	Comments
			Limit	Margin				
1333.330	43.4	V	54.0	-10.6	Peak	305	1.5	Not a radio signal
1991.670	41.9	V	68.3	-26.4	Peak	146	1.0	Not a radio signal
2650.000	43.4	V	68.3	-24.9	Peak	108	1.0	Not a radio signal
10604.860	42.0	H	54.0	-12.0	AVG	244	1.0	RB 1 MHz;VB 10 Hz;Peak
10605.310	54.5	H	74.0	-19.5	PK	244	1.0	RB 1 MHz;VB 3 MHz;Peak

Note: Scans made between 18 - 40 GHz with the measurement antenna moved around the EUT and its antennas, 20-50cm from the device, indicated there were no significant emissions in this frequency range

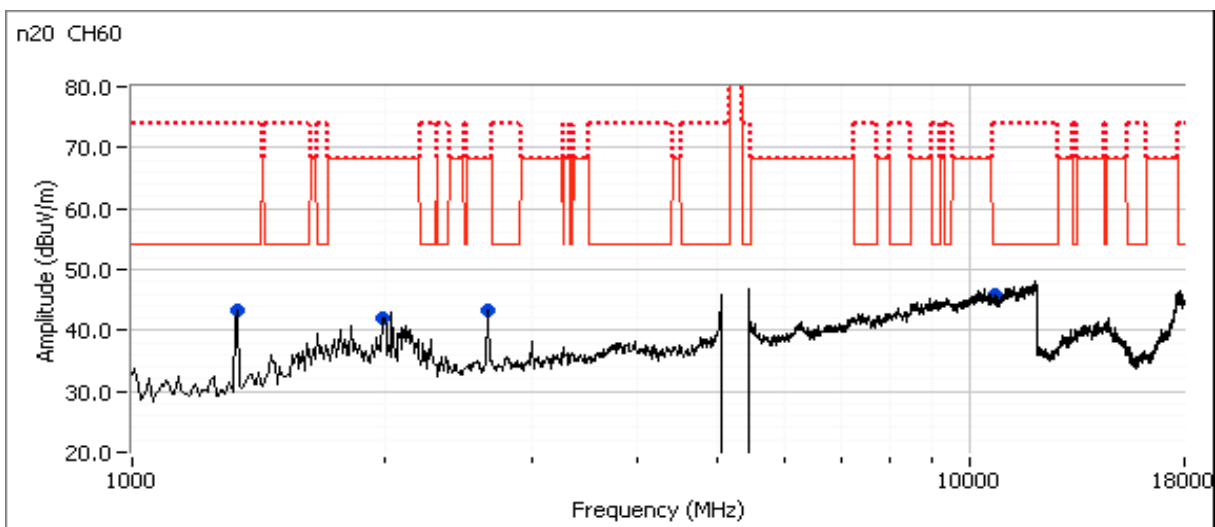

Client: Google Inc.	Job Number: JD104891
Model: Model H0A	T-Log Number: T104956
Contact: Dominik Mente	Project Manager: Deepa Shetty
Standard: FCC 15.247 / 15.407 / RSS-247	Project Coordinator: -
	Class: N/A

Run #3c: Center Channel

Channel: 54 Mode: 11n40
 Antenna 2 Data Rate: MCS0

Frequency MHz	Level dB μ V/m	Pol v/h	15.209 / 15E		Detector Pk/QP/Avg	Azimuth degrees	Height meters	Comments
			Limit	Margin				
1333.330	44.9	V	54.0	-9.1	Peak	71	1.5	Not a radio signal
1991.670	42.2	V	68.3	-26.1	Peak	104	1.0	Not a radio signal
2658.330	43.5	H	68.3	-24.8	Peak	212	1.5	Not a radio signal
10541.020	42.1	V	54.0	-11.9	AVG	160	1.0	RB 1 MHz;VB 10 Hz;Peak
10542.630	54.3	V	74.0	-19.7	PK	160	1.0	RB 1 MHz;VB 3 MHz;Peak
10542.630	54.3	V	68.3	-14.0	PK	160	1.0	RB 1 MHz;VB 3 MHz;Peak

Note: Scans made between 18 - 40 GHz with the measurement antenna moved around the EUT and its antennas, 20-50cm from the device, indicated there were no significant emissions in this frequency range

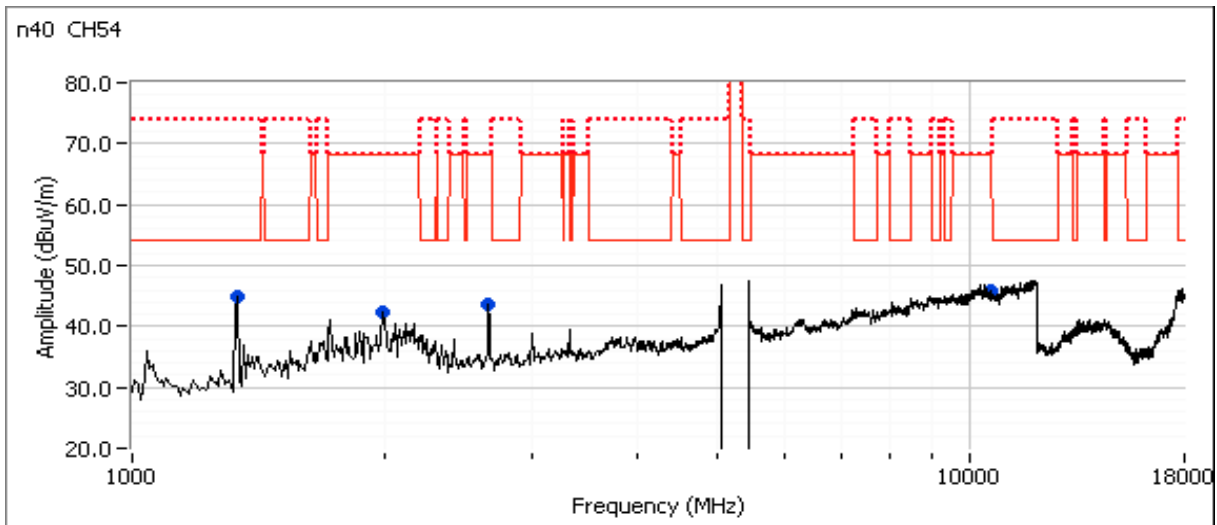

Client: Google Inc.	Job Number: JD104891
Model: Model H0A	T-Log Number: T104956
Contact: Dominik Mente	Project Manager: Deepa Shetty
Standard: FCC 15.247 / 15.407 / RSS-247	Project Coordinator: -
	Class: N/A

Run #3d: Center Channel

Channel: 58 Mode: ac80
 Antenna 2 Data Rate: VHT0

Frequency MHz	Level dB μ V/m	Pol v/h	15.209 / 15E		Detector Pk/QP/Avg	Azimuth degrees	Height meters	Comments
			Limit	Margin				
1333.330	46.0	V	54.0	-8.0	Peak	193	1.0	Not a radio signal
1991.670	41.5	V	68.3	-26.8	Peak	144	1.0	Not a radio signal
2666.670	46.5	V	68.3	-21.8	Peak	82	1.0	Not a radio signal
5433.330	-	H	54.0	-	Peak	16	1.5	measured at BE - refer to BE data
10576.000	41.8	V	54.0	-12.2	AVG	135	1.0	RB 1 MHz;VB 10 Hz;Peak
10581.650	54.2	V	74.0	-19.8	PK	135	1.0	RB 1 MHz;VB 3 MHz;Peak
10581.650	54.2	V	68.3	-14.1	PK	135	1.0	RB 1 MHz;VB 3 MHz;Peak

Note: Scans made between 18 - 40 GHz with the measurement antenna moved around the EUT and its antennas, 20-50cm from the device, indicated there were no significant emissions in this frequency range

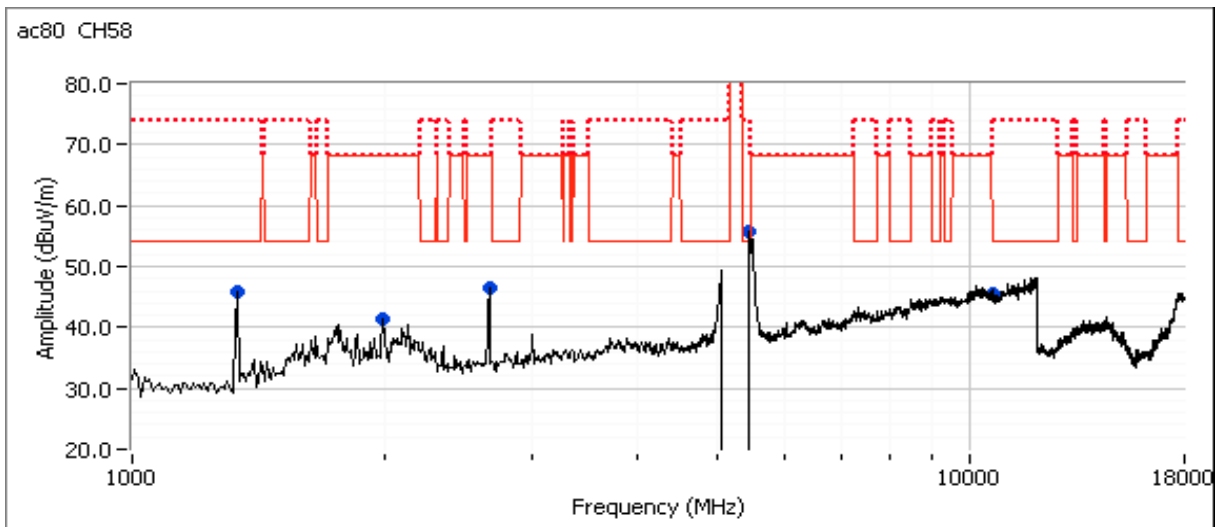



EMC Test Data

Client: Google Inc.	Job Number: JD104891
Model: Model H0A	T-Log Number: T104956
Contact: Dominik Mente	Project Manager: Deepa Shetty
Standard: FCC 15.247 / 15.407 / RSS-247	Project Coordinator: -
	Class: N/A

Run #4: Radiated Spurious Emissions, 1,000 - 40000 MHz. Operating Mode: Worse case from Run #3

Date of Test: 7/6/2017
 Test Engineer: Rafael Varelas
 Test Location: Chamber 7

Config. Used: 1
 Config Change: none
 EUT Voltage: 120V/60Hz

Run #4a: Low Channel

Channel: 52 Mode: 11a
 Antenna 2 Data Rate: 6 Mbps

Frequency MHz	Level dB μ V/m	Pol v/h	15.209 / 15E		Detector PK/QP/Avg	Azimuth degrees	Height meters	Comments
			Limit	Margin				
10517.970	54.2	H	68.3	-14.1	PK	11	1.0	RB 1 MHz;VB 3 MHz;Peak
1325.000	51.2	V	54.0	-2.8	Peak	41	1.0	Not a radio signal
1991.670	43.0	H	68.3	-25.3	Peak	49	1.5	Not a radio signal
2658.330	45.7	V	68.3	-22.6	Peak	104	1.0	Not a radio signal

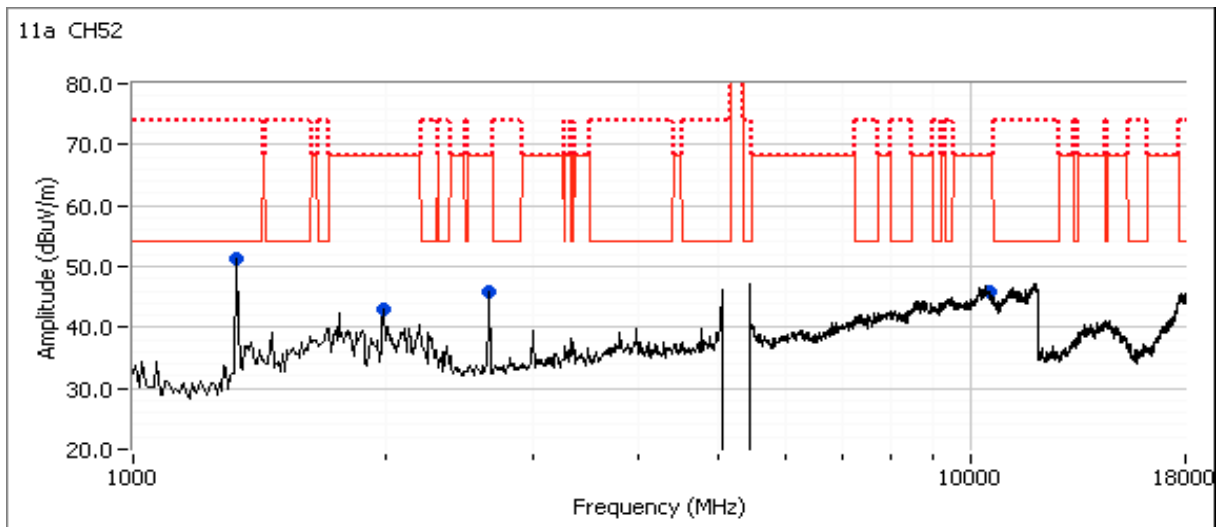



EMC Test Data

Client: Google Inc.	Job Number: JD104891
Model: Model H0A	T-Log Number: T104956
Contact: Dominik Mente	Project Manager: Deepa Shetty
Standard: FCC 15.247 / 15.407 / RSS-247	Project Coordinator: -
	Class: N/A

Run #4b: High Channel

Channel: 64 Mode: 11a
 Antenna 2 Data Rate: 6 Mbps

Frequency MHz	Level dB μ V/m	Pol v/h	15.209 / 15E		Detector Pk/QP/Avg	Azimuth degrees	Height meters	Comments
			Limit	Margin				
10640.080	41.3	V	54.0	-12.7	AVG	280	1.0	RB 1 MHz;VB 10 Hz;Peak
10642.450	53.5	V	74.0	-20.5	PK	280	1.0	RB 1 MHz;VB 3 MHz;Peak
1325.000	46.5	V	54.0	-7.5	Peak	176	1.0	Not a radio signal
2008.330	40.4	V	68.3	-27.9	Peak	166	1.0	Not a radio signal
2650.000	43.7	H	68.3	-24.6	Peak	125	1.0	Not a radio signal

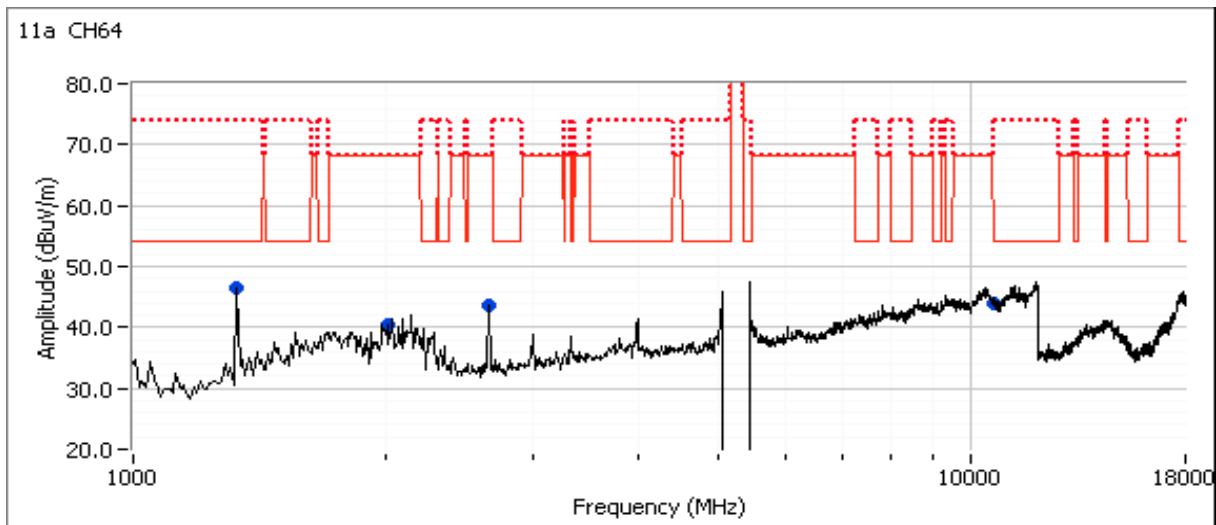

Client: Google Inc.	Job Number: JD104891
Model: Model H0A	T-Log Number: T104956
	Project Manager: Deepa Shetty
Contact: Dominik Mente	Project Coordinator: -
Standard: FCC 15.247 / 15.407 / RSS-247	Class: N/A

Run #5, Radiated Spurious Emissions, 1,000 - 40,000 MHz. Operation in the 5470-5725 MHz Band

Date of Test: 7/5/17 & 7/6/17	Config. Used: 1
Test Engineer: Rafael Varelas, John Caizzi	Config Change: none
Test Location: Chamber 7	EUT Voltage: 120V/60Hz

Run #5a: Center Channel

Channel: 116	Mode: a
Antenna 2	Data Rate: 6MB/s

Frequency MHz	Level dB μ V/m	Pol v/h	15.209 / 15E		Detector Pk/QP/Avg	Azimuth degrees	Height meters	Comments
			Limit	Margin				
1333.330	43.4	V	54.0	-10.6	Peak	160	1.0	Not a radio signal
1991.670	41.7	V	68.3	-26.6	Peak	155	1.0	Not a radio signal
2658.330	40.6	H	68.3	-27.7	Peak	110	1.6	Not a radio signal
11156.920	42.0	V	54.0	-12.0	AVG	246	1.1	RB 1 MHz;VB 10 Hz;Peak
11155.400	54.8	V	74.0	-19.2	PK	246	1.1	RB 1 MHz;VB 3 MHz;Peak

Note: Scans made between 18 - 40 GHz with the measurement antenna moved around the EUT and its antennas, 20-50cm from the device, indicated there were no significant emissions in this frequency range

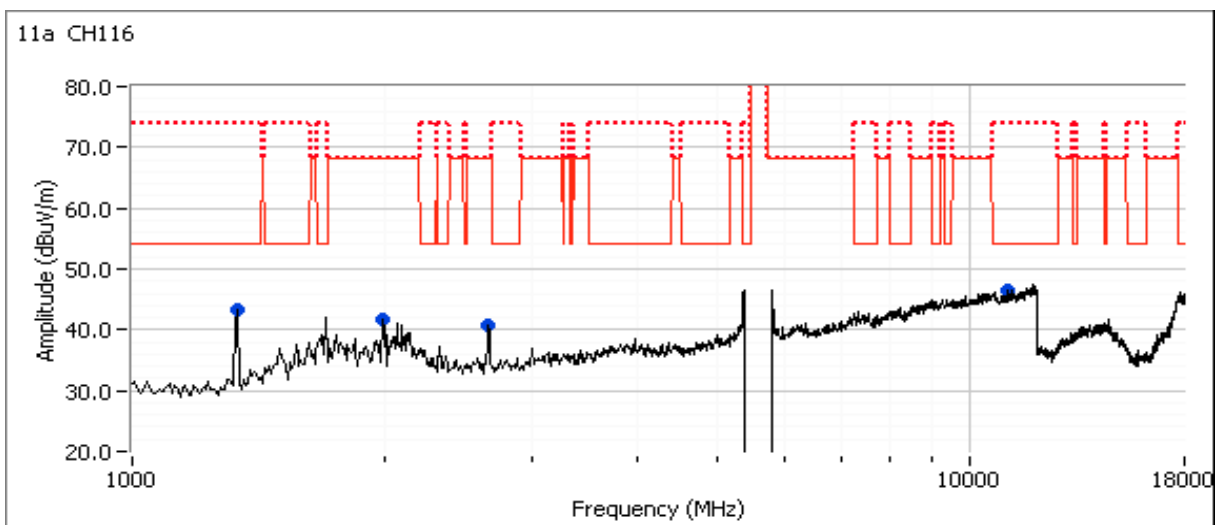

Client: Google Inc.	Job Number: JD104891
Model: Model H0A	T-Log Number: T104956
Contact: Dominik Mente	Project Manager: Deepa Shetty
Standard: FCC 15.247 / 15.407 / RSS-247	Project Coordinator: -
	Class: N/A

Run #5b: Center Channel

Channel: 116 Mode: 11n20
 Antenna 2 Data Rate: MCS0

Frequency MHz	Level dB μ V/m	Pol v/h	15.209 / 15E		Detector Pk/QP/Avg	Azimuth degrees	Height meters	Comments
			Limit	Margin				
1325.000	43.1	V	54.0	-10.9	Peak	61	1.0	Not a radio signal
2000.000	41.9	V	68.3	-26.4	Peak	166	1.6	Not a radio signal
2666.670	43.4	H	68.3	-24.9	Peak	132	1.0	Not a radio signal
11159.450	42.0	V	54.0	-12.0	AVG	239	1.0	RB 1 MHz;VB 10 Hz;Peak
11155.470	54.7	V	74.0	-19.3	PK	239	1.0	RB 1 MHz;VB 3 MHz;Peak

Note: Scans made between 18 - 40 GHz with the measurement antenna moved around the EUT and its antennas, 20-50cm from the device, indicated there were no significant emissions in this frequency range

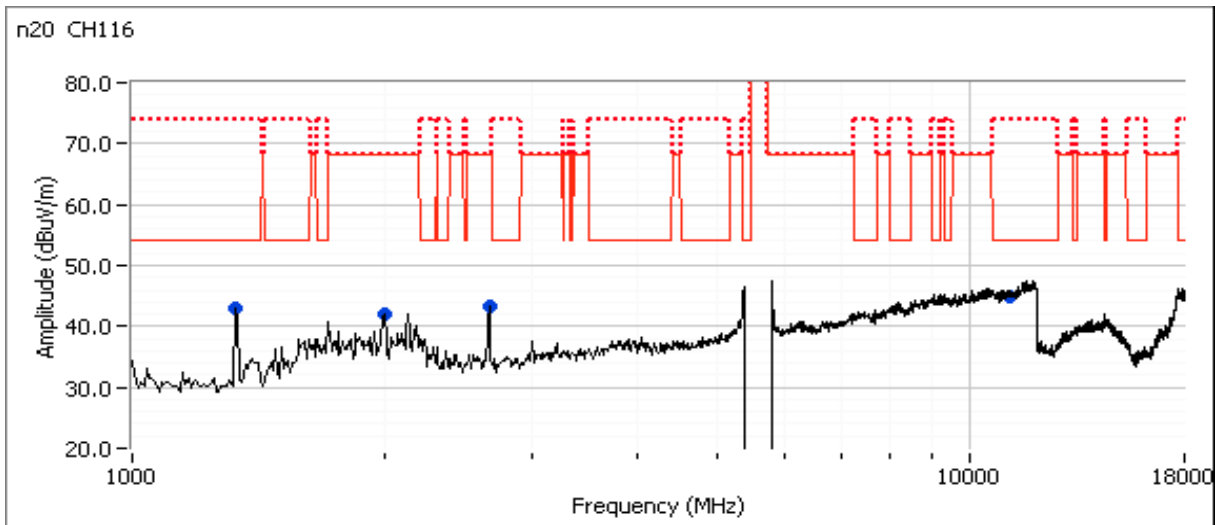



EMC Test Data

Client: Google Inc.	Job Number: JD104891
Model: Model H0A	T-Log Number: T104956
Contact: Dominik Mente	Project Manager: Deepa Shetty
Standard: FCC 15.247 / 15.407 / RSS-247	Project Coordinator: -
	Class: N/A

Run #5c: Center Channel

Channel: 110 Mode: 11n40
 Antenna 2 Data Rate: MCS0

Frequency MHz	Level dB μ V/m	Pol v/h	15.209 / 15E		Detector Pk/QP/Avg	Azimuth degrees	Height meters	Comments
			Limit	Margin				
1325.000	41.7	V	54.0	-12.3	Peak	70	1.0	Not a radio signal
2008.330	40.9	V	68.3	-27.4	Peak	152	1.0	Not a radio signal
2666.670	40.9	H	68.3	-27.4	Peak	74	2.5	Not a radio signal
11097.350	42.3	V	54.0	-11.7	AVG	4	1.0	RB 1 MHz;VB 10 Hz;Peak
11102.620	55.0	V	74.0	-19.0	PK	4	1.0	RB 1 MHz;VB 3 MHz;Peak

Note: Scans made between 18 - 40 GHz with the measurement antenna moved around the EUT and its antennas, 20-50cm from the device, indicated there were no significant emissions in this frequency range

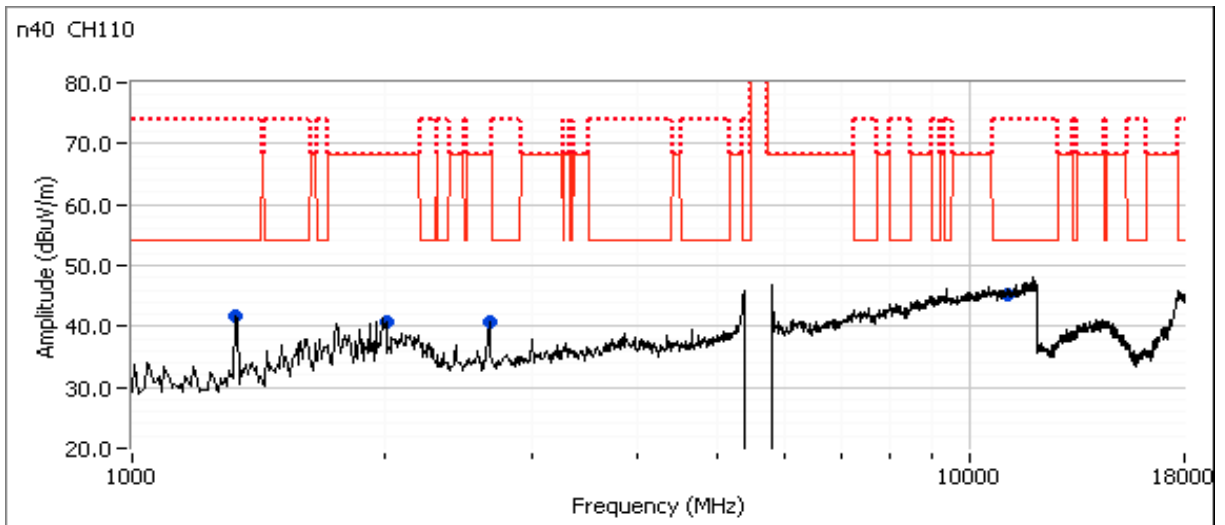

Client: Google Inc.	Job Number: JD104891
Model: Model H0A	T-Log Number: T104956
Contact: Dominik Mente	Project Manager: Deepa Shetty
Standard: FCC 15.247 / 15.407 / RSS-247	Project Coordinator: -
	Class: N/A

Run #5d: Low Channel

Channel: 106 Mode: ac80
 Antenna 2 Data Rate: VHT0

Frequency MHz	Level dB μ V/m	Pol v/h	15.209 / 15E		Detector Pk/QP/Avg	Azimuth degrees	Height meters	Comments
			Limit	Margin				
1333.330	44.4	V	54.0	-9.6	Peak	154	1.6	Not a radio signal
1991.670	41.5	V	68.3	-26.8	Peak	147	1.0	Not a radio signal
2658.330	41.5	H	68.3	-26.8	Peak	109	1.3	Not a radio signal
5341.670	-	H	68.3	-	Peak	4	2.2	measured at BE - refer to BE data
11062.650	42.5	H	54.0	-11.5	AVG	74	1.0	RB 1 MHz;VB 10 Hz;Peak
11060.220	54.8	H	74.0	-19.2	PK	74	1.0	RB 1 MHz;VB 3 MHz;Peak

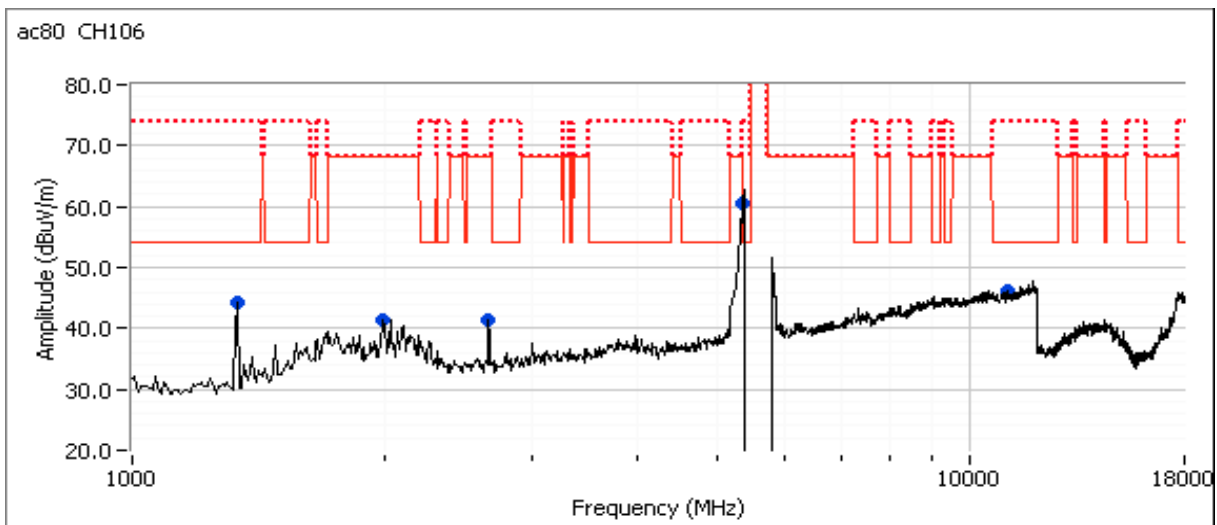

Client: Google Inc.	Job Number: JD104891
Model: Model H0A	T-Log Number: T104956
	Project Manager: Deepa Shetty
Contact: Dominik Mentel	Project Coordinator: -
Standard: FCC 15.247 / 15.407 / RSS-247	Class: N/A

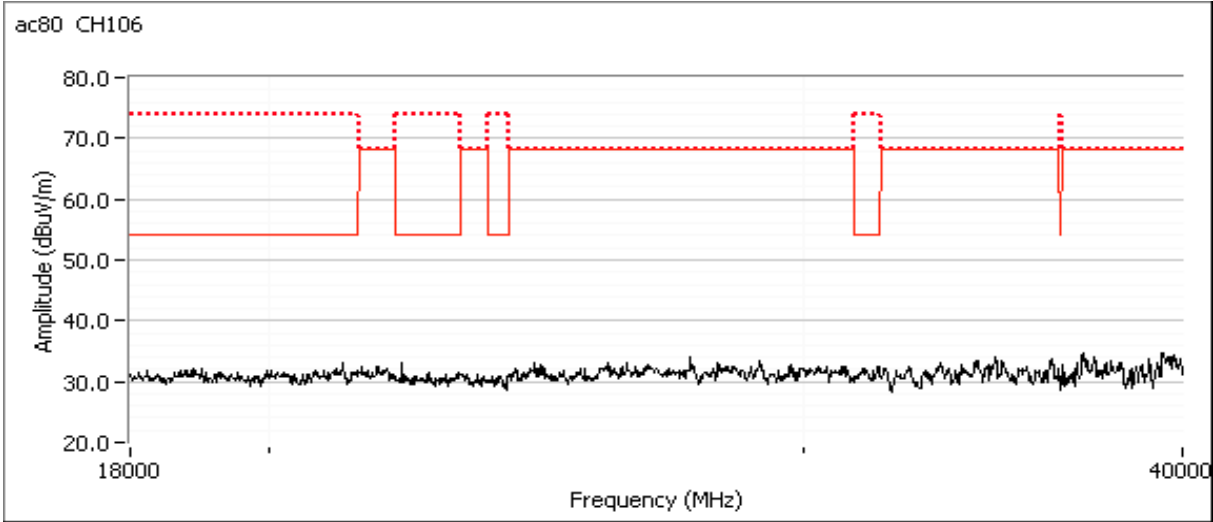



EMC Test Data

Client: Google Inc.	Job Number: JD104891
Model: Model H0A	T-Log Number: T104956
	Project Manager: Deepa Shetty
Contact: Dominik Mentel	Project Coordinator: -
Standard: FCC 15.247 / 15.407 / RSS-247	Class: N/A

Run #6: Radiated Spurious Emissions, 1,000 - 40000 MHz. Operating Mode: worst case from Run #5

Date of Test: 7/6/2017
 Test Engineer: Rafael Varelas
 Test Location: Chamber 7

Config. Used: 1
 Config Change: none
 EUT Voltage: 120V/60Hz

Run #6a: Low Channel

Channel: 100 Mode: ac80
 Antenna 2 Data Rate: VHT0

Frequency MHz	Level dB μ V/m	Pol v/h	15.209 / 15E		Detector Pk/QP/Avg	Azimuth degrees	Height meters	Comments
			Limit	Margin				
1325.000	43.4	V	54.0	-10.6	Peak	32	1.0	Not a radio signal
1991.670	48.0	V	68.3	-20.3	Peak	150	1.0	Not a radio signal
2658.330	44.7	V	68.3	-23.6	Peak	81	1.0	Not a radio signal
11376.530	41.5	V	54.0	-12.5	AVG	133	1.0	RB 1 MHz;VB 10 Hz;Peak
11379.100	53.9	V	74.0	-20.1	PK	133	1.0	RB 1 MHz;VB 3 MHz;Peak



EMC Test Data

Client: Google Inc.	Job Number: JD104891
Model: Model H0A	T-Log Number: T104956
Contact: Dominik Mente	Project Manager: Deepa Shetty
Standard: FCC 15.247 / 15.407 / RSS-247	Project Coordinator: -
	Class: N/A

Run #6b: High Channel

Channel: 144 Mode: 11a
 Antenna 2 Data Rate: 6 Mbps

Frequency MHz	Level dB μ V/m	Pol v/h	15.209 / 15E		Detector Pk/QP/Avg	Azimuth degrees	Height meters	Comments
			Limit	Margin				
11442.070	41.7	V	54.0	-12.3	AVG	317	2.0	RB 1 MHz;VB 10 Hz;Peak
11443.070	53.8	V	74.0	-20.2	PK	317	2.0	RB 1 MHz;VB 3 MHz;Peak
1325.000	43.1	V	54.0	-10.9	Peak	230	1.5	Not a radio signal
1991.670	44.0	V	68.3	-24.3	Peak	117	1.0	Not a radio signal
2658.330	42.1	V	68.3	-26.2	Peak	117	1.0	Not a radio signal

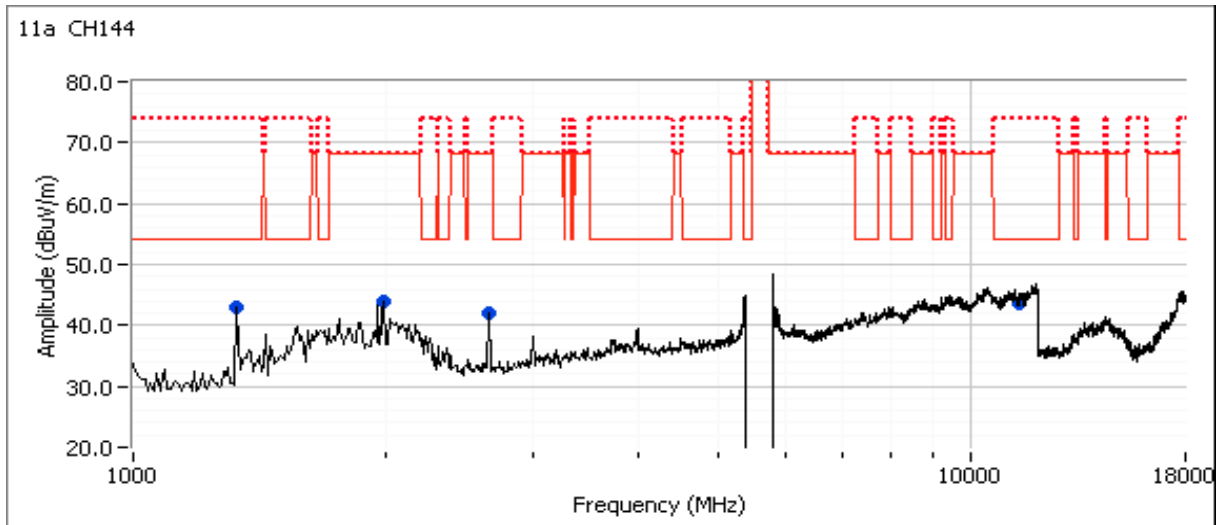



EMC Test Data

Client: Google Inc.	Job Number: JD104891
Model: Model H0A	T-Log Number: T104956
Contact: Dominik Mente	Project Manager: Deepa Shetty
Standard: FCC 15.247 / 15.407 / RSS-247	Project Coordinator: -
	Class: N/A

Run #9, Radiated Spurious Emissions, 1,000 - 40,000 MHz. Operation in the 5725-5850 MHz Band

Date of Test: 7/21/2017
 Test Engineer: Rafael Varelas
 Test Location: Chamber 7

Config. Used: 1
 Config Change: none
 EUT Voltage: 120V/60Hz

Run #9a: Center Channel

Channel: 157 Mode: a
 Antenna 2 Data Rate: 6MB/s

Frequency MHz	Level dB μ V/m	Pol v/h	15.209 / 15E		Detector Pk/QP/Avg	Azimuth degrees	Height meters	Comments
			Limit	Margin				
11576.830	43.0	H	54.0	-11.0	AVG	24	1.0	RB 1 MHz;VB 10 Hz;Peak
11560.100	54.9	H	74.0	-19.1	PK	24	1.0	RB 1 MHz;VB 3 MHz;Peak

Note: Scans made between 18 - 40 GHz with the measurement antenna moved around the EUT and its antennas, 20-50cm from the device, indicated there were no significant emissions in this frequency range

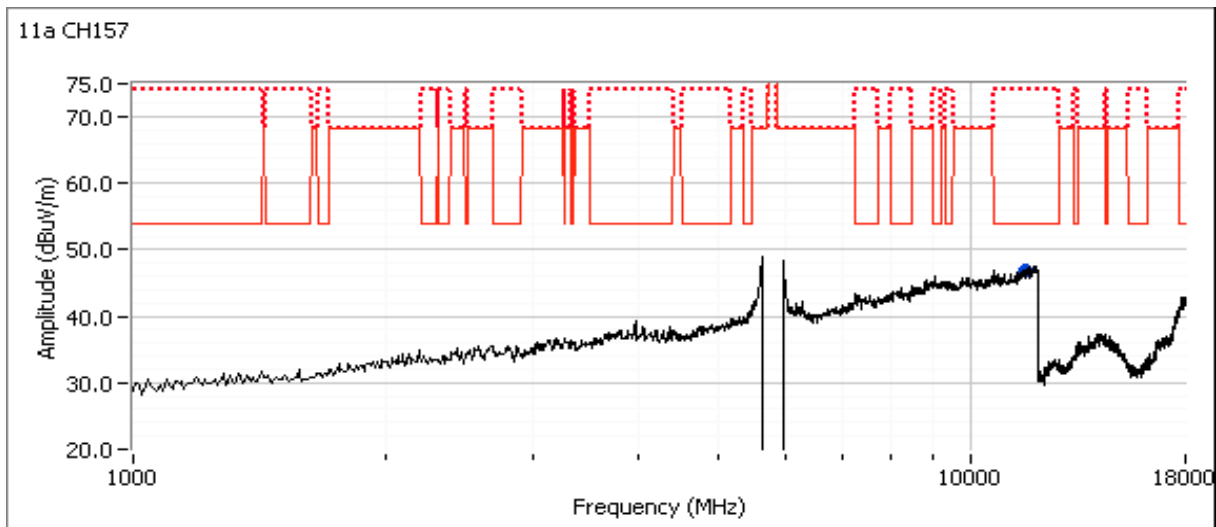

Client: Google Inc.	Job Number: JD104891
Model: Model H0A	T-Log Number: T104956
Contact: Dominik Mente	Project Manager: Deepa Shetty
Standard: FCC 15.247 / 15.407 / RSS-247	Project Coordinator: -
	Class: N/A

Run #9b: Center Channel

Channel: 157 Mode: 11n20
 Antenna 2 Data Rate: MCS0

Frequency MHz	Level dB μ V/m	Pol v/h	15.209 / 15E		Detector Pk/QP/Avg	Azimuth degrees	Height meters	Comments
			Limit	Margin				
5598.580	63.9	H	68.3	-4.4	PK	294	1.1	RB 1 MHz;VB 3 MHz;Peak
11568.630	43.0	V	54.0	-11.0	AVG	293	1.0	RB 1 MHz;VB 10 Hz;Peak
11565.050	55.1	V	74.0	-18.9	PK	293	1.0	RB 1 MHz;VB 3 MHz;Peak

Note: Scans made between 18 - 40 GHz with the measurement antenna moved around the EUT and its antennas, 20-50cm from the device, indicated there were no significant emissions in this frequency range

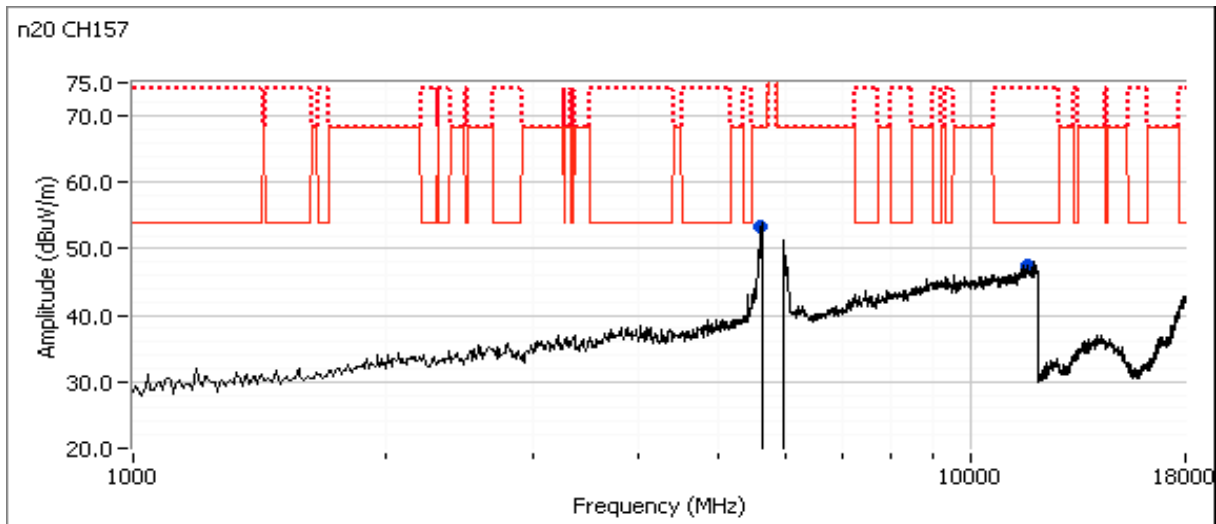



EMC Test Data

Client: Google Inc.	Job Number: JD104891
Model: Model H0A	T-Log Number: T104956
Contact: Dominik Mente	Project Manager: Deepa Shetty
Standard: FCC 15.247 / 15.407 / RSS-247	Project Coordinator: -
	Class: N/A

Run #9c: Center Channel

Channel: 159 Mode: 11n40
 Antenna 2 Data Rate: MCS0

Frequency MHz	Level dB μ V/m	Pol v/h	15.209 / 15E		Detector Pk/QP/Avg	Azimuth degrees	Height meters	Comments
			Limit	Margin				
11591.830	43.0	V	54.0	-11.0	AVG	347	1.0	RB 1 MHz;VB 10 Hz;Peak
11588.220	55.0	V	74.0	-19.0	PK	347	1.0	RB 1 MHz;VB 3 MHz;Peak
5608.330	-	H	68.3	-	Peak	359	1.0	measured at BE - refer to BE data
5975.000	-	H	68.3	-	Peak	335	1.0	measured at BE - refer to BE data

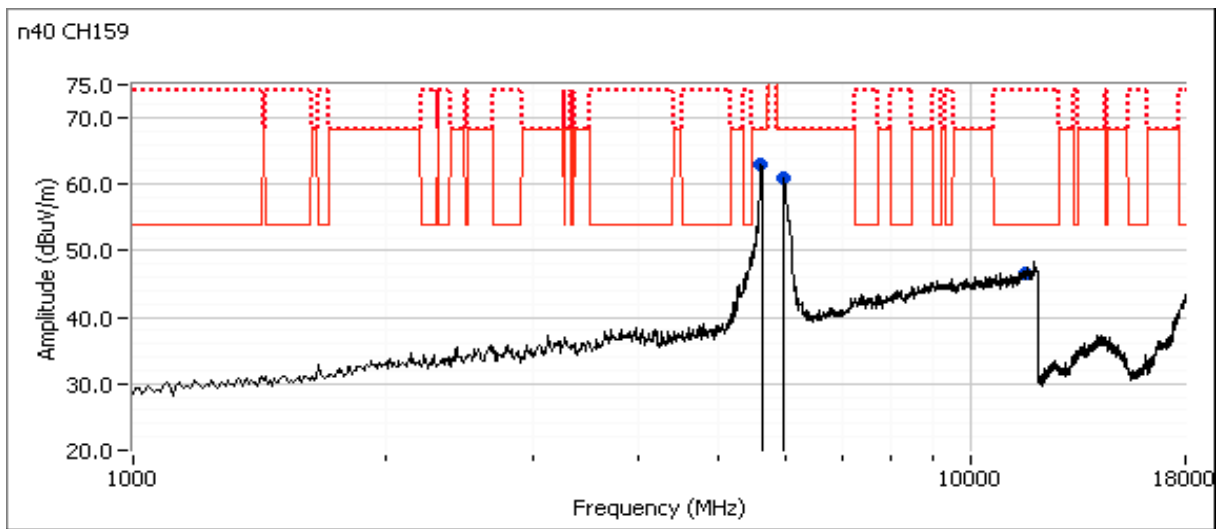

Client: Google Inc.	Job Number: JD104891
Model: Model H0A	T-Log Number: T104956
Contact: Dominik Mentel	Project Manager: Deepa Shetty
Standard: FCC 15.247 / 15.407 / RSS-247	Project Coordinator: -
	Class: N/A

Run #9d: Center Channel

Channel: 155 Mode: ac80
 Antenna 2 Data Rate: VHT0

Frequency MHz	Level dB μ V/m	Pol v/h	15.209 / 15E		Detector PK/QP/Avg	Azimuth degrees	Height meters	Comments
			Limit	Margin				
1333.330	44.8	V	54.0	-9.2	Peak	39	1.0	Not a radio signal
2000.000	43.2	V	68.3	-25.1	Peak	192	1.0	Not a radio signal
2658.330	45.3	V	68.3	-23.0	Peak	98	1.3	Not a radio signal
5608.330	-	H	68.3	-	Peak	46	1.0	measured at BE - refer to BE data
5975.000	-	H	68.3	-	Peak	30	1.0	measured at BE - refer to BE data
11545.830	42.7	V	54.0	-11.3	AVG	237	1.1	RB 1 MHz;VB 10 Hz;Peak
11554.950	55.2	V	74.0	-18.8	PK	237	1.1	RB 1 MHz;VB 3 MHz;Peak

Note: Scans made between 18 - 40 GHz with the measurement antenna moved around the EUT and its antennas, 20-50cm from the device, indicated there were no significant emissions in this frequency range

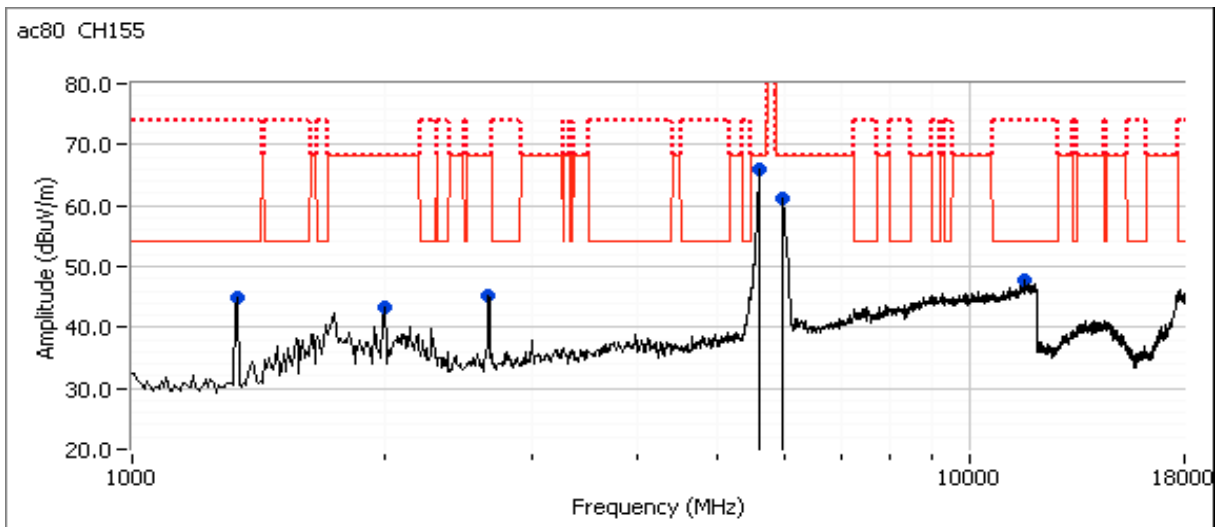



EMC Test Data

Client: Google Inc.	Job Number: JD104891
Model: Model H0A	T-Log Number: T104956
Contact: Dominik Mente	Project Manager: Deepa Shetty
Standard: FCC 15.247 / 15.407 / RSS-247	Project Coordinator: -
	Class: N/A

Run #10: Radiated Spurious Emissions, 1,000 - 40000 MHz. Operating Mode: Worst case from Run #9.

Date of Test: 7/21/2017
 Test Engineer: Rafael Varelas
 Test Location: Chamber #4

Config. Used: 1
 Config Change: none
 EUT Voltage: 120V/60Hz

Run #10a: Low Channel

Channel: 149 Mode: 11n20
 Antenna 2 Data Rate: MCS0

Frequency MHz	Level dB μ V/m	Pol v/h	15.209 / 15E		Detector Pk/QP/Avg	Azimuth degrees	Height meters	Comments
			Limit	Margin				
11490.730	42.6	H	54.0	-11.4	AVG	103	1.3	RB 1 MHz;VB 10 Hz;Peak
11490.270	54.1	H	74.0	-19.9	PK	103	1.3	RB 1 MHz;VB 3 MHz;Peak
5608.330	-	H	68.3	-	Peak	45	1.9	measured at BE - refer to BE data

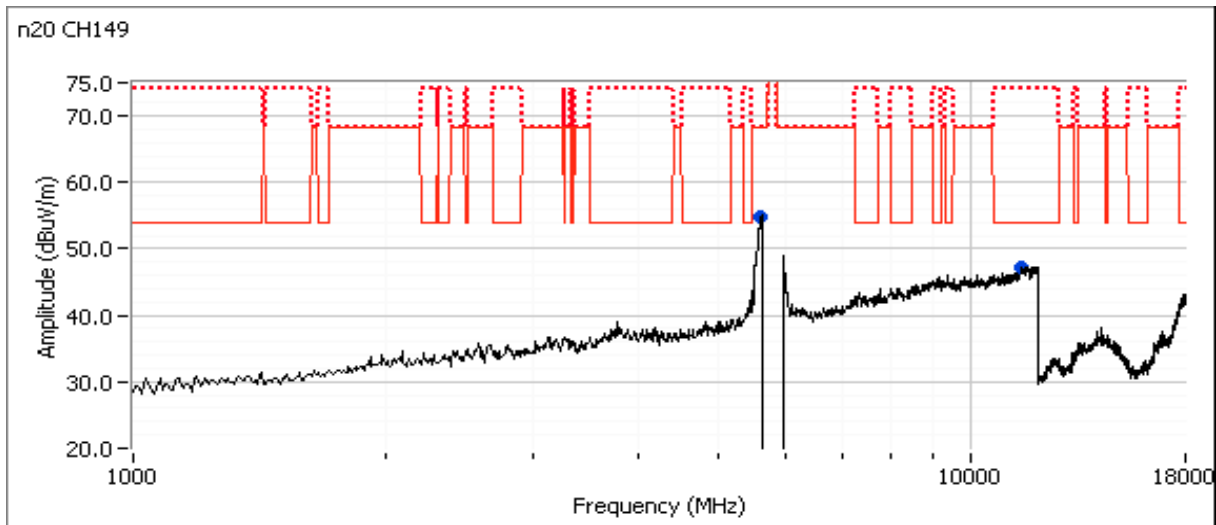

Client: Google Inc.	Job Number: JD104891
Model: Model H0A	T-Log Number: T104956
Contact: Dominik Mentel	Project Manager: Deepa Shetty
Standard: FCC 15.247 / 15.407 / RSS-247	Project Coordinator: -
	Class: N/A

Run #10b: High Channel

Channel: 165 Mode: 11n20
 Antenna 2 Data Rate: MCS0

Frequency	Level	Pol	15.209 / 15E		Detector	Azimuth	Height	Comments
MHz	dB μ V/m	v/h	Limit	Margin	Pk/QP/Avg	degrees	meters	
11659.070	43.5	V	54.0	-10.5	AVG	97	1.0	RB 1 MHz;VB 10 Hz;Peak
11658.610	55.1	V	74.0	-18.9	PK	97	1.0	RB 1 MHz;VB 3 MHz;Peak
5983.330	-	H	68.3	-	Peak	241	1.3	measured at BE - refer to BE data

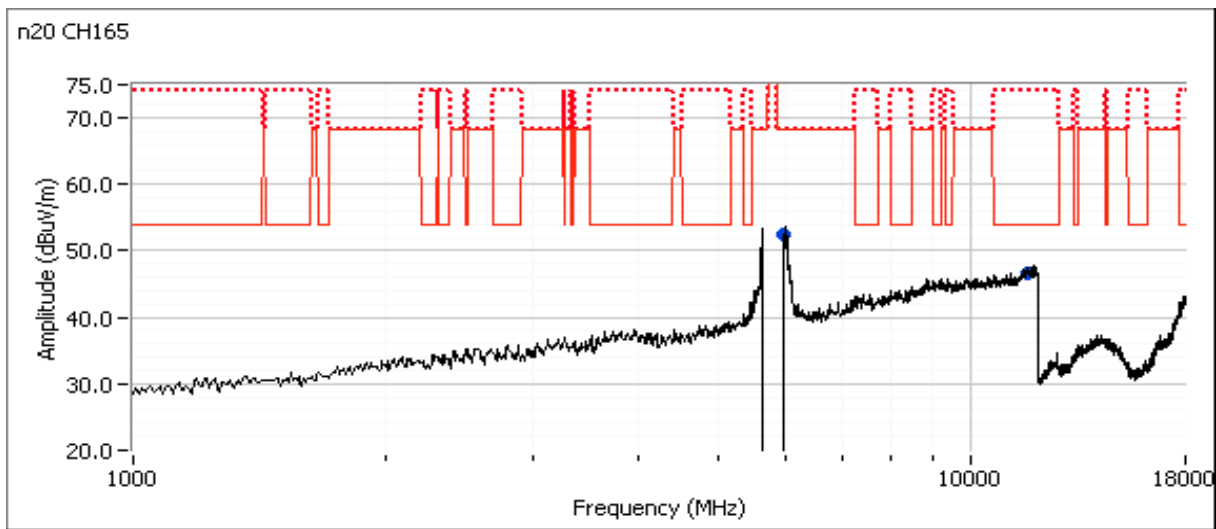

Client:	Google Inc.	Job Number:	JD104891
Model:	Model H0A	T-Log Number:	T104956
		Project Manager:	Deepa Shetty
Contact:	Dominik Mente	Project Coordinator:	-
Standard:	FCC 15.247 / 15.407 / RSS-247	Class:	N/A

RSS-247 (LELAN) and FCC 15.407(UNII) Antenna Port Measurements Power, PSD, Bandwidth and Spurious Emissions

Test Specific Details

Objective: The objective of this test session is to perform final qualification testing of the EUT with respect to the specification listed above.

Summary of Results

Run #	Test Performed	Limit	Pass / Fail	Result / Margin
1	Power, 5150 - 5250MHz	15.407(a) (1) (iv), RSS-247 6.2	Pass	a: 15.9dBm (38.9 mW) n20: 15.9dBm (38.9 mW) n40: 15.9dBm (38.9 mW) ac80: 9.1dBm (8.1 mW)
1	PSD, 5150 - 5250MHz	15.407(a) (1) (iv), RSS-247 6.2	Pass	a: 3.2dBm/MHz n20: 3.0dBm/MHz n40: -0.5dBm/MHz ac80: -10.5dBm/MHz
1	Power, 5250 - 5350MHz	15.407(a) (2), RSS-247 6.2	Pass	a: 15.8dBm (38.0mW) n20: 15.8dBm (38.0mW) n40: 15.6dBm (36.3mW) ac80: 9.8dBm (9.5mW)
1	PSD, 5250 - 5350MHz	15.407(a) (2), RSS-247 6.2	Pass	a: 2.9dBm/MHz n20: 2.6dBm/MHz n40: -0.3dBm/MHz ac80: -9.5dBm/MHz
1	Max EIRP 5250 - 5350MHz	TPC required if EIRP ≥ 500mW (27dBm). EIRP ≥ 200mW (23dBm) DFS threshold = -64dBm.	Pass	EIRP = 19.5 dBm (89.7 mW)
1	Power, 5470 - 5725MHz	15.407(a) (2)	Pass	a: 16.0dBm (40.1mW) n20: 16.1dBm (40.9mW) n40: 16.0dBm (40.0mW) ac80: 16.0dBm (40.1mW)
1	PSD, 5470 - 5725MHz	15.407(a) (2)	Pass	a: 2.5dBm/MHz n20: 3.0dBm/MHz n40: -0.2dBm/MHz ac80: -3.6dBm/MHz

Client: Google Inc.	Job Number: JD104891
Model: Model H0A	T-Log Number: T104956
	Project Manager: Deepa Shetty
Contact: Dominik Mentel	Project Coordinator: -
Standard: FCC 15.247 / 15.407 / RSS-247	Class: N/A

Run #	Test Performed	Limit	Pass / Fail	Result / Margin
1	Power, 5470 - 5725MHz	RSS-247 6.2	Pass	a: 16.0dBm (40.1mW) n20: 16.1dBm (40.9mW) n40: 16.0dBm (40.0mW) ac80: 10.7dBm (11.8mW)
1	PSD, 5470 - 5725MHz	RSS-247 6.2	Pass	a: 2.5dBm/MHz n20: 3.0dBm/MHz n40: -0.2dBm/MHz ac80: -3.6dBm/MHz
1	Max EIRP 5470 - 5725MHz	TPC required if EIRP ≥ 500mW (27dBm). EIRP ≥ 200mW (23dBm) DFS threshold = -64dBm.	Pass	EIRP = 19.8 dBm (95.9 mW)
1	Power, 5725 - 5850MHz	15.407(a) (3), RSS-247 6.2	Pass	a: 18.8dBm (76.3mW) n20: 18.7dBm (74.4mW) n40: 17.8dBm (60.7mW) ac80: 14.8dBm (30.4mW)
1	PSD, 5725 - 5850MHz	15.407(a) (3), RSS-247 6.2	Pass	a: 6.4dBm/MHz n20: 5.7dBm/MHz n40: 2.5dBm/MHz ac80: -0.3dBm/MHz
1	26dB Bandwidth	15.407 (Information only)	-	> 16MHz for all modes
1	99% Bandwidth	RSS 210 (Information only)	N/A	a: 34.4 MHz n20: 34.4 MHz n40: 81.6 MHz ac80: 152.0 MHz
2	Antenna Conducted - Out of Band Spurious	15.407(b) -27dBm/MHz	Pass	All emissions below the -27dBm/MHz limit

General Test Configuration

When measuring the conducted emissions from the EUT's antenna port, the antenna port of the EUT was connected to the spectrum analyzer or power meter via a suitable attenuator to prevent overloading the measurement system. All measurements are corrected to allow for the external attenuators and cables used.

Ambient Conditions: Temperature: 22-24 °C
 Rel. Humidity: 41-43 %



EMC Test Data

Client:	Google Inc.	Job Number:	JD104891
Model:	Model H0A	T-Log Number:	T104956
		Project Manager:	Deepa Shetty
Contact:	Dominik Mente	Project Coordinator:	-
Standard:	FCC 15.247 / 15.407 / RSS-247	Class:	N/A

Modifications Made During Testing

No modifications were made to the EUT during testing

Deviations From The Standard

No deviations were made from the requirements of the standard.

Procedure Comments:

Measurements performed in accordance with FCC KDB 789033

Mode	Data Rate	Duty Cycle (x)	Constant DC?	T (ms)	Pwr Cor Factor*	Lin Volt Cor Factor**	Min VBW for FS (Hz)
11a	6 Mbps	99.4%	yes		0	0	10
11n20	MCS 0	99.6%	yes		0	0	10
11n40	MCS 0	99.6%	yes		0	0	10
ac80	MCS 0	99.2%	yes		0	0	10

Sample Notes

Sample S/N: Eng conducted sample #1

Driver: -



EMC Test Data

Client: Google Inc.	Job Number: JD104891
Model: Model H0A	T-Log Number: T104956
	Project Manager: Deepa Shetty
Contact: Dominik Mente	Project Coordinator: -
Standard: FCC 15.247 / 15.407 / RSS-247	Class: N/A

Run #1: Bandwidth, Output Power and Power Spectral Density - MIMO Systems
 Date of Test: 07/20/17 Config. Used: 1
 Test Engineer: M. Birgani / R. Varelas Config Change: None
 Test Location: FT Lab #4B EUT Voltage: USB

- Note 1: Power measured with an average power meter. $EIRP (dBm) = \text{Conducted power (dBm)} + \text{antenna gain (dBi)}$
- Note 2: Duty Cycle $\geq 98\%$. PSD measured using a spectrum analyzer (see plots below). $RBW=1MHz$, $VB=3 MHz$, $\text{Span} > \text{OBW}$, # of points in sweep $\geq 2 * \text{span} / \text{RBW}$, auto sweep, RMS detector, power averaging on (transmitted signal was continuous, duty cycle $\geq 98\%$) (method SA-1 of ANSI C63.10).
- Note 3: For RSS-247 the limit for the 5150 - 5250 MHz band accounts for the antenna gain as the maximum eirp allowed is 10dBm/MHz. The limits are also corrected for instances where the highest measured value of the PSD exceeds the average PSD (calculated from the measured power divided by the measured 99% bandwidth) by more than 3dB by the amount that the measured value exceeds the average by more than 3dB.
- Note 4: 99% Bandwidth measured in accordance with C63.10 - RB between 1-5 % of OBW and $VB \geq 3 * RB$, Span between 1.5 and 5 times OBW.
- Note 5: For MIMO systems the total output power and total PSD are calculated from the sum of the powers of the individual chains (in linear terms). The antenna gain used to determine the EIRP and limits for PSD/Output power depends on the operating mode of the MIMO device. If the signals are not coherent between the transmit chains, then the gain used to determine the limits is the highest gain of the individual chains and the EIRP is the sum of the products of gain and power on each chain. If the signals are coherent, then the effective antenna gain is the sum (in linear terms) of the gains for each chain and the EIRP is the product of the effective gain and total power.
- Note 6: Both ports were evaluated and results showed both ports close to each other. Port 1 used for final measurements.

FCC UNII-1 Limits		Pwr	PSD	
	Outdoor AP	30	17	FCC only
	Indoor AP	30	17	
X	Station (e.g. Client)	24	11	EIRP
	Outdoor AP (>30° Elv.)	21	-	



EMC Test Data

Client: Google Inc.	Job Number: JD104891
Model: Model H0A	T-Log Number: T104956
Contact: Dominik Mente	Project Manager: Deepa Shetty
Standard: FCC 15.247 / 15.407 / RSS-247	Project Coordinator: -
	Class: N/A

SISO Device - 5150-5250 MHz Band - FCC

Antenna Gain (dBi): 3.7 Max EIRP: 91.8 mW 19.6 dBm

Frequency (MHz)	Software Setting	26dB BW (MHz)	Duty Cycle %	Output Power ¹ dBm			PSD ² dBm/MHz			Result
				Measured	Calculated	Limit	Measured	Calculated	Limit	
802.11a										
5180	15		99.4	15.0	15.0	24.0	2.4	2.4	11.0	Pass
5200	16		99.4	15.9	15.9	24.0	3.2	3.2	11.0	Pass
5240	16		99.4	15.7	15.7	24.0	3.0	3.0	11.0	Pass
802.11n 20MHz										
5180	15		99.6	14.9	14.9	24.0	2.0	2.0	11.0	Pass
5200	16		99.6	15.9	15.9	24.0	3.0	3.0	11.0	Pass
5240	16		99.6	15.6	15.6	24.0	2.7	2.7	11.0	Pass
802.11n 40MHz										
5190	13		99.6	13.1	13.1	24.0	-3.0	-3.0	11.0	Pass
5230	16		99.6	15.9	15.9	24.0	-0.5	-0.5	11.0	Pass
802.11ac 80MHz										
5210	9		99.2	9.1	9.1	24.0	-10.5	-10.5	11.0	Pass

SISO Device - 5150-5250 MHz Band - Industry Canada

Antenna Gain (dBi): 3.7 Max EIRP: 91.8 mW 19.6 dBm

Frequency (MHz)	Software Setting	99% BW (MHz)	Duty Cycle %	Output Power ¹ dBm (EIRP)			PSD ² dBm/MHz (EIRP)			Result
				Measured	Calculated	Limit	Measured	Calculated	Limit ³	
802.11a										
5180	15	17.3	99.4	18.7	18.7	22.4	6.1	6.1	10.0	Pass
5200	16	17.3	99.4	19.6	19.6	22.4	6.9	6.9	10.0	Pass
5240	16	17.3	99.4	19.4	19.4	22.4	6.7	6.7	10.0	Pass
802.11n 20MHz										
5180	15	18.4	99.6	18.6	18.6	22.6	5.7	5.7	10.0	Pass
5200	16	18.4	99.6	19.6	19.6	22.6	6.7	6.7	10.0	Pass
5240	16	18.4	99.6	19.3	19.3	22.6	6.4	6.4	10.0	Pass
802.11n 40MHz										
5190	13	36.5	99.6	16.8	16.8	23.0	0.7	0.7	10.0	Pass
5230	16	36.6	99.6	19.6	19.6	23.0	3.2	3.2	10.0	Pass
802.11ac 80MHz										
5210	9	76.2	99.2	12.8	12.8	23.0	-6.8	-6.8	10.0	Pass

Client: Google Inc.	Job Number: JD104891
Model: Model H0A	T-Log Number: T104956
Contact: Dominik Mente	Project Manager: Deepa Shetty
Standard: FCC 15.247 / 15.407 / RSS-247	Project Coordinator: -
	Class: N/A

Plots of PSD and 99%BW, worse case for each mode.

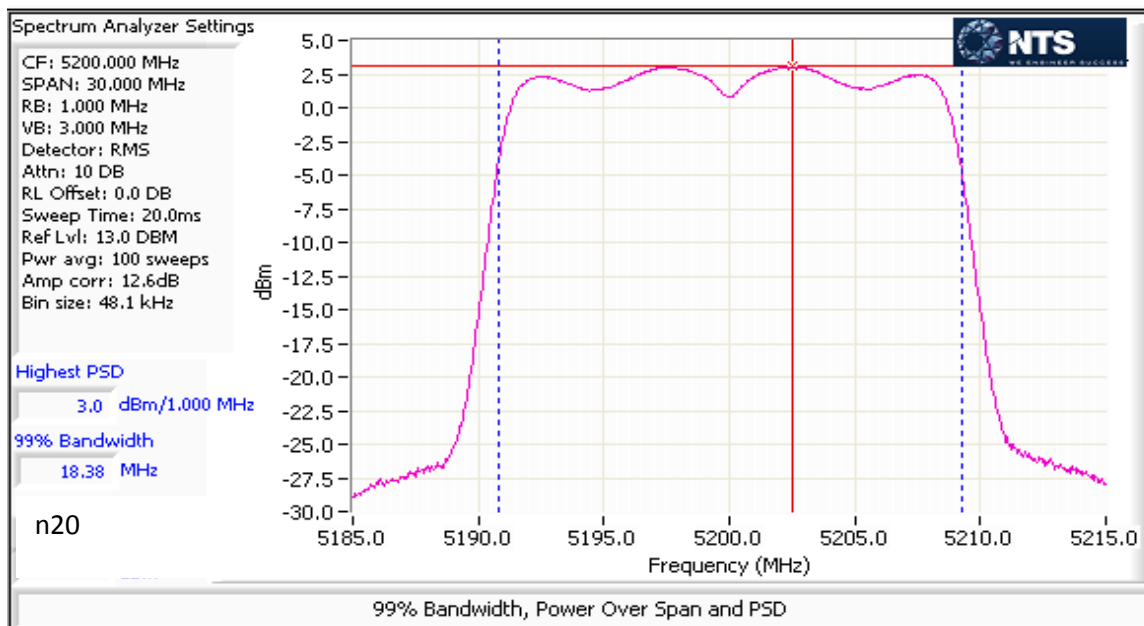
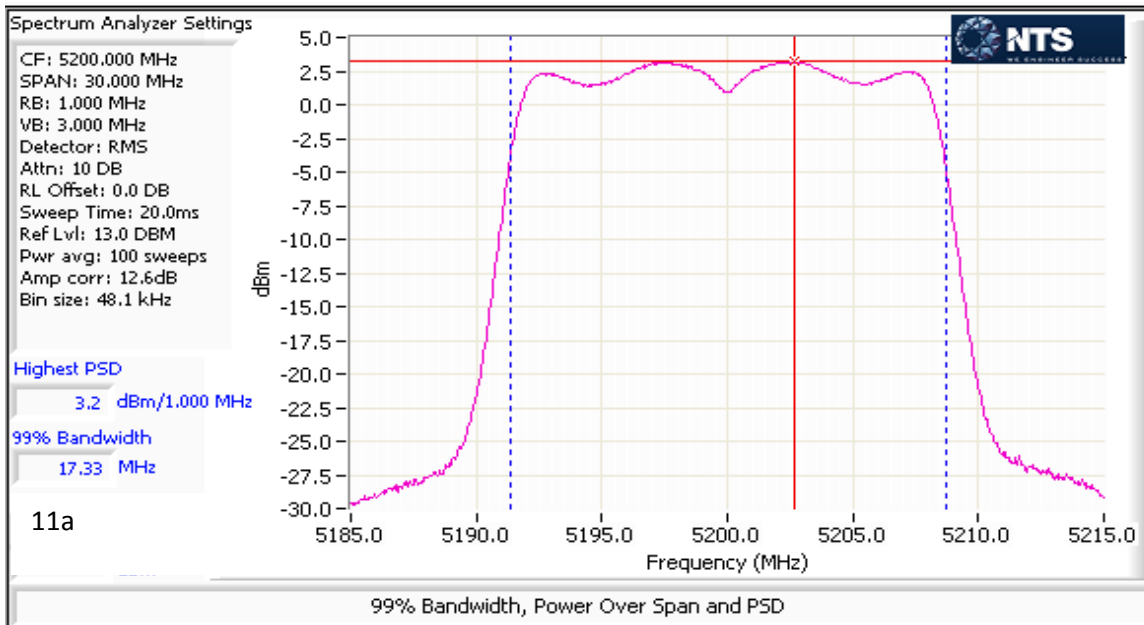

Client: Google Inc.	Job Number: JD104891
Model: Model H0A	T-Log Number: T104956
Contact: Dominik Mente	Project Manager: Deepa Shetty
Standard: FCC 15.247 / 15.407 / RSS-247	Project Coordinator: -
	Class: N/A

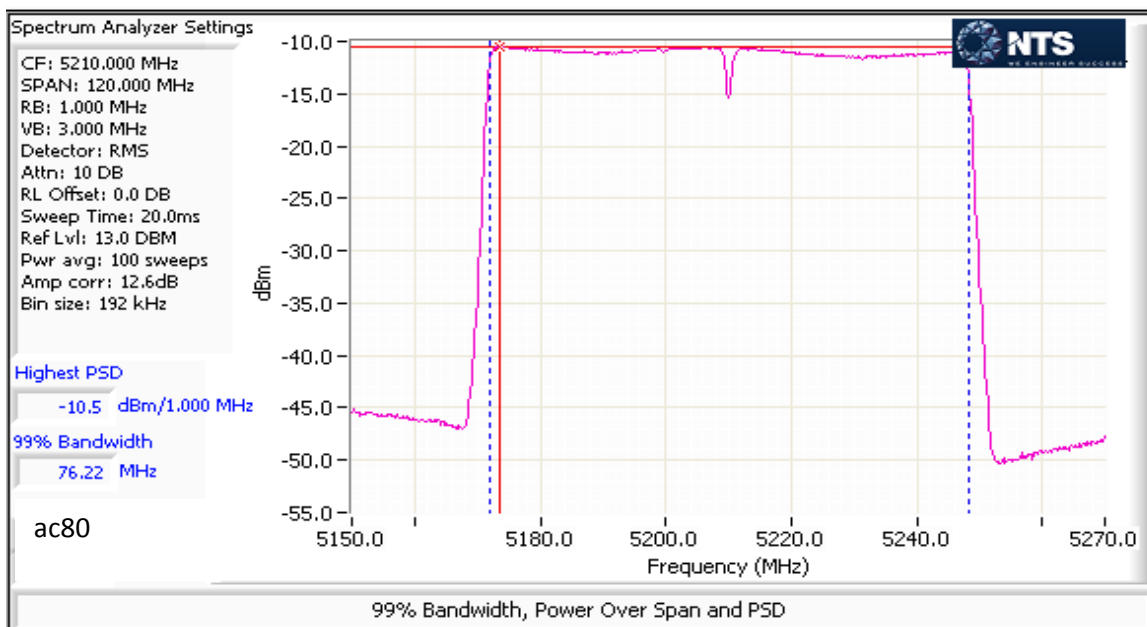
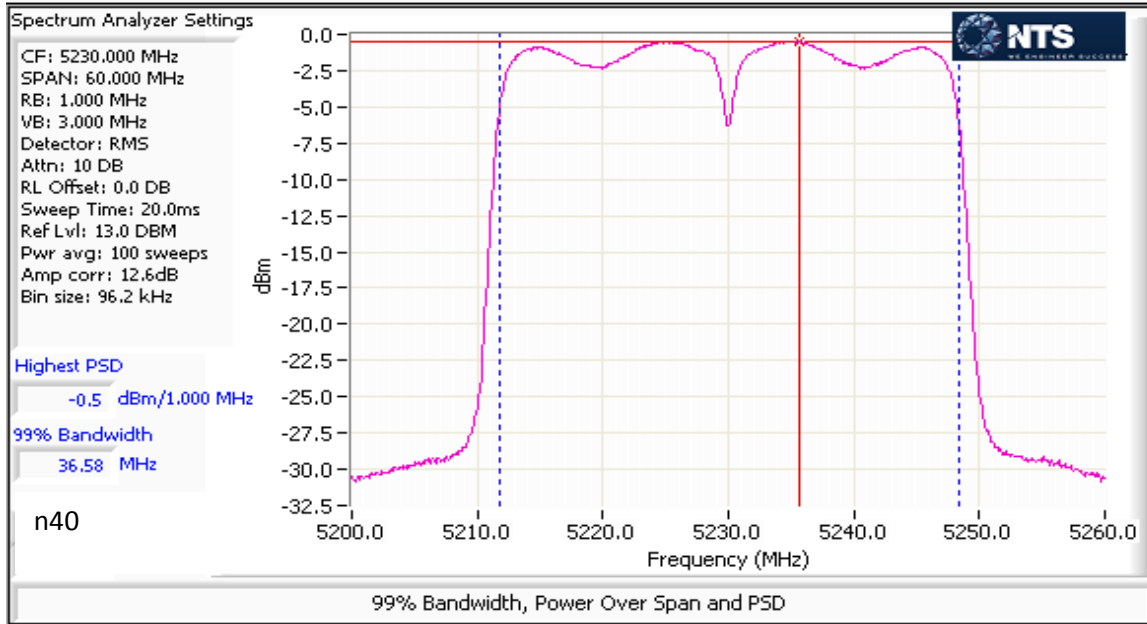



EMC Test Data

Client: Google Inc.	Job Number: JD104891
Model: Model H0A	T-Log Number: T104956
Contact: Dominik Mente	Project Manager: Deepa Shetty
Standard: FCC 15.247 / 15.407 / RSS-247	Project Coordinator: -
	Class: N/A

SISO Device - 5250-5350 MHz Band - FCC

Antenna Gain (dBi): 3.7 Max EIRP: 89.7 mW 19.5 dBm

Frequency (MHz)	Software Setting	26dB BW (MHz)	Duty Cycle %	Output Power ¹ dBm			PSD ² dBm/MHz			Result
				Measured	Calculated	Limit	Measured	Calculated	Limit	
802.11a										
5260	16	26.4	99.4	15.8	15.8	24.0	2.9	2.9	11.0	Pass
5300	16	28.3	99.4	15.7	15.7	24.0	2.8	2.8	11.0	Pass
5320	16	27.6	99.4	15.5	15.5	24.0	2.6	2.6	11.0	Pass
802.11n 20MHz										
5260	16	32.4	99.6	15.8	15.8	24.0	2.5	2.5	11.0	Pass
5300	16	30.7	99.6	15.7	15.7	24.0	2.6	2.6	11.0	Pass
5320	16	32.3	99.6	15.6	15.6	24.0	2.4	2.4	11.0	Pass
802.11n 40MHz										
5270	16	70.5	99.6	15.6	15.6	24.0	-0.3	-0.3	11.0	Pass
5310	13	44.2	99.6	12.7	12.7	24.0	-3.4	-3.4	11.0	Pass
802.11ac 80MHz										
5290	10	117.3	99.2	9.8	9.8	24.0	-9.5	-9.5	11.0	Pass

SISO Device - 5250-5350 MHz Band - Industry Canada

Antenna Gain (dBi): 3.7 Max EIRP: 89.7 mW 19.5 dBm

Frequency (MHz)	Software Setting	99% BW (MHz)	Duty Cycle %	Output Power ¹ dBm			PSD ² dBm/MHz			Result
				Measured	Calculated	Limit	Measured	Calculated	Limit ³	
802.11a										
5260	16	17.3	99.4	15.8	15.8	23.4	2.9	2.9	11.0	Pass
5300	16	17.3	99.4	15.7	15.7	23.4	2.8	2.8	11.0	Pass
5320	16	17.3	99.4	15.5	15.5	23.4	2.6	2.6	11.0	Pass
802.11n 20MHz										
5260	16	18.4	99.6	15.8	15.8	23.6	2.5	2.5	11.0	Pass
5300	16	18.4	99.6	15.7	15.7	23.6	2.6	2.6	11.0	Pass
5320	16	18.4	99.6	15.6	15.6	23.6	2.4	2.4	11.0	Pass
802.11n 40MHz										
5270	16	36.6	99.6	15.6	15.6	24.0	-0.3	-0.3	11.0	Pass
5310	13	36.6	99.6	12.7	12.7	24.0	-3.4	-3.4	11.0	Pass
802.11ac 80MHz										
5290	10	76.2	99.2	9.8	9.8	24.0	-9.5	-9.5	11.0	Pass

Client: Google Inc.	Job Number: JD104891
Model: Model H0A	T-Log Number: T104956
Contact: Dominik Mente	Project Manager: Deepa Shetty
Standard: FCC 15.247 / 15.407 / RSS-247	Project Coordinator: -
	Class: N/A

Plot of worst case 26dB BW

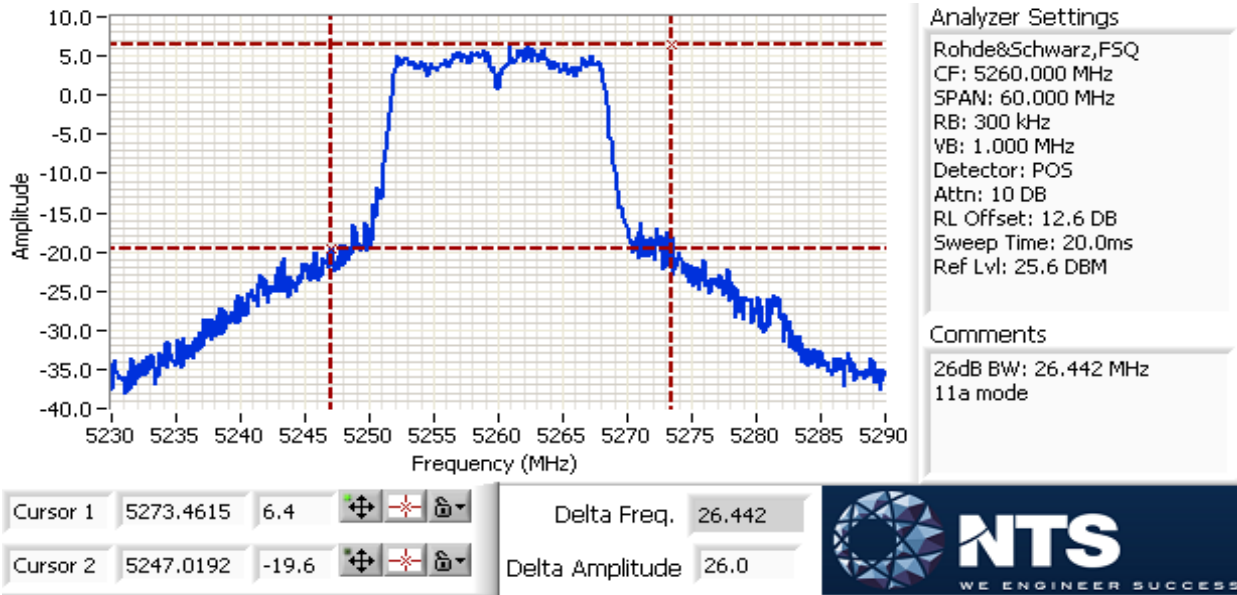

Plots of PSD and 99%BW, worst case for each mode.

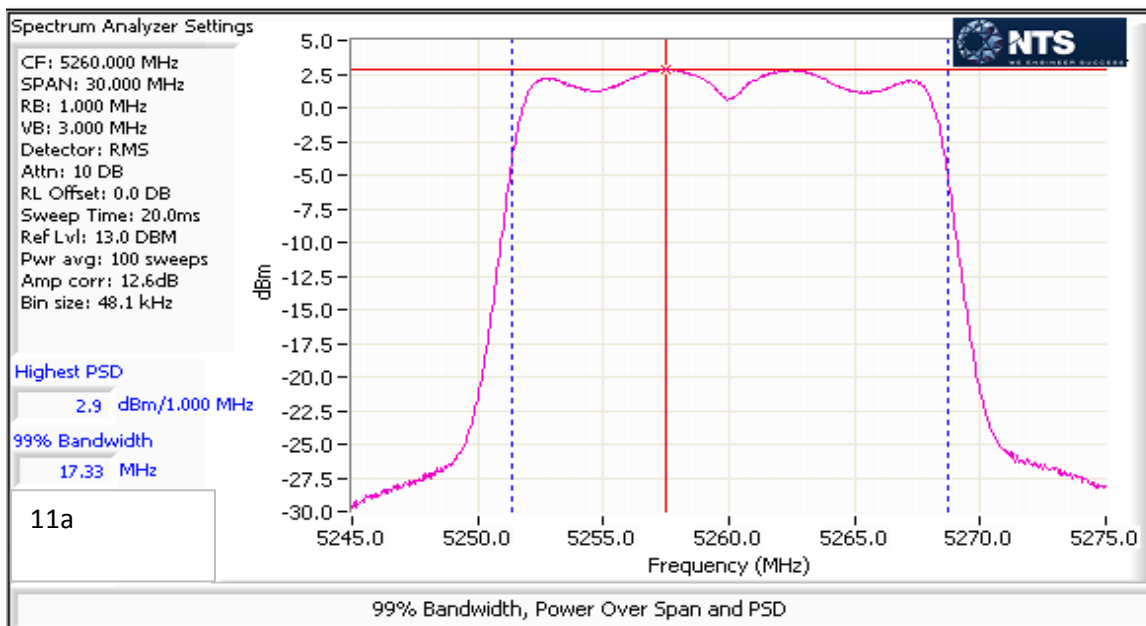

Client: Google Inc.	Job Number: JD104891
Model: Model H0A	T-Log Number: T104956
Contact: Dominik Mente	Project Manager: Deepa Shetty
Standard: FCC 15.247 / 15.407 / RSS-247	Project Coordinator: -
	Class: N/A

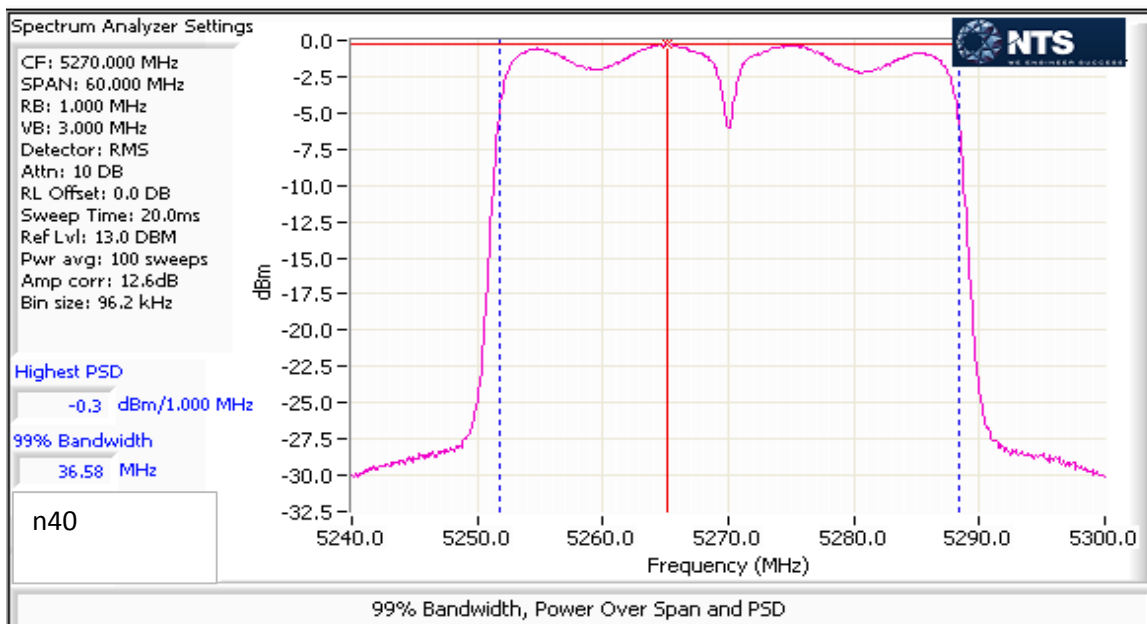
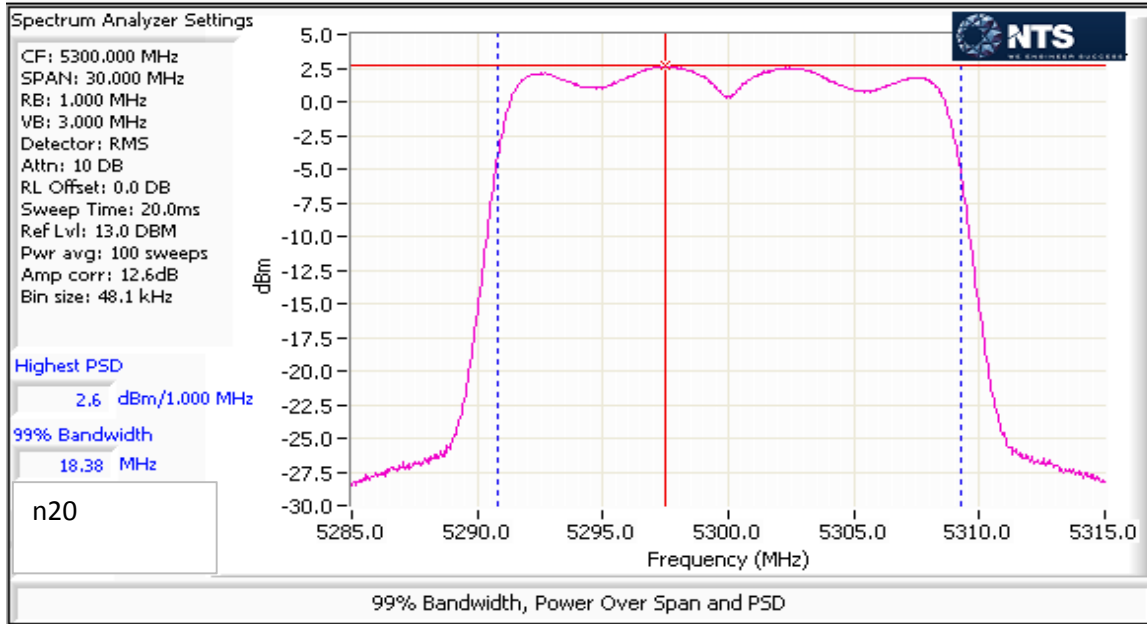

Client: Google Inc.	Job Number: JD104891
Model: Model H0A	T-Log Number: T104956
	Project Manager: Deepa Shetty
Contact: Dominik Mente	Project Coordinator: -
Standard: FCC 15.247 / 15.407 / RSS-247	Class: N/A

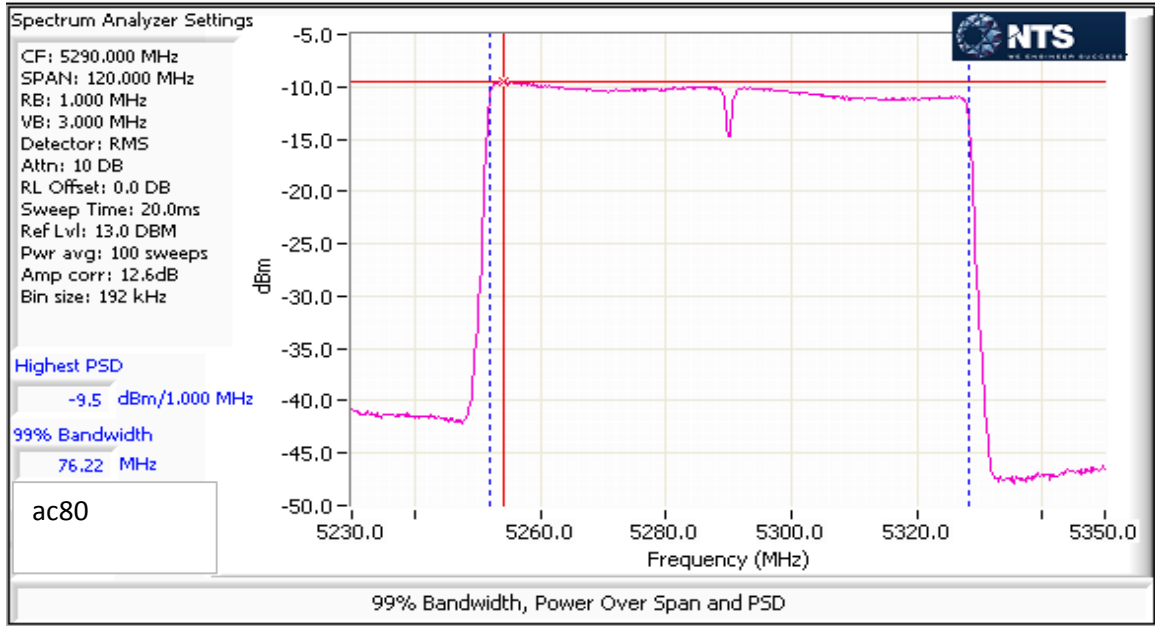



EMC Test Data

Client: Google Inc.	Job Number: JD104891
Model: Model H0A	T-Log Number: T104956
Contact: Dominik Mente	Project Manager: Deepa Shetty
Standard: FCC 15.247 / 15.407 / RSS-247	Project Coordinator: -
	Class: N/A

SISO Device - 5470-5725 MHz Band - FCC

Antenna Gain (dBi): 3.7

Max EIRP: 95.9 mW

19.8 dBm

Frequency (MHz)	Software Setting	26dB BW (MHz)	Duty Cycle %	Output Power ¹ dBm			PSD ² dBm/MHz			Result
				Measured	Calculated	Limit	Measured	Calculated	Limit	
802.11a										
5500	15	25.8	99.4	15.2	15.2	24.0	2.5	2.5	11.0	Pass
5580	16	35.2	99.4	15.8	15.8	24.0	2.5	2.5	11.0	Pass
5700	14	21.9	99.4	14.0	14.0	24.0	1.3	1.3	11.0	Pass
5720	16	23.1	99.4	16.0	16.0	24.0	3.2	3.2	11.0	Pass
Portion within 5725-5850 MHz band (UNII-3)										
5720	16	13.5	99.4	-	-	30.0	2.7	2.7	30.0	Pass
802.11n 20MHz										
5500	15	31.8	99.6	15.1	15.1	24.0	2.1	2.1	11.0	Pass
5580	16	38.9	99.6	15.7	15.7	24.0	2.2	2.2	11.0	Pass
5700	13	30.1	99.6	14.0	14.0	24.0	-0.1	-0.1	11.0	Pass
5720	16	25.6	99.6	16.1	16.1	24.0	3.0	3.0	11.0	Pass
Portion within 5725-5850 MHz band (UNII-3)										
5720	16	14.6	99.6	-	-	30.0	2.7	2.7	30.0	Pass
802.11n 40MHz										
5510	12	40.4	99.6	12.2	12.2	24.0	-3.6	-3.6	11.0	Pass
5550	16	85.7	99.6	15.8	15.8	24.0	-0.3	-0.3	11.0	Pass
5670	15	75.0	99.6	15.0	15.0	24.0	-1.0	-1.0	11.0	Pass
5710	16	57.1	99.6	16.0	16.0	24.0	-0.2	-0.2	11.0	Pass
Portion within 5725-5850 MHz band (UNII-3)										
5710	16	26.7	99.6	-	-	30.0	-0.4	-0.4	30.0	Pass
802.11ac 80MHz										
5530	8	146.6	99.2	8.9	8.9	24.0	-12.0	-12.0	11.0	Pass
5610	16	253.4	99.2	15.8	15.8	24.0	-4.1	-4.1	11.0	Pass
5690	16	139.8	99.2	16.0	16.0	24.0	-3.6	-3.6	11.0	Pass
Portion within 5725-5850 MHz band (UNII-3)										
5690	16	70.3	99.2	-	-	30.0	-4.4	-4.4	30.0	Pass



EMC Test Data

Client: Google Inc.	Job Number: JD104891
Model: Model H0A	T-Log Number: T104956
Contact: Dominik Mente	Project Manager: Deepa Shetty
Standard: FCC 15.247 / 15.407 / RSS-247	Project Coordinator: -
	Class: N/A

SISO Device - 5470-5725 MHz Band - Industry Canada

Antenna Gain (dBi): 3.7 Max EIRP: 95.6 mW 19.8 dBm

Frequency (MHz)	Software Setting	99% BW (MHz)	Duty Cycle %	Output Power ¹ dBm			PSD ² dBm/MHz			Result
				Measured	Calculated	Limit	Measured	Calculated	Limit ³	
802.11a										
5500	15	17.3	99.4	15.2	15.2	23.4	2.5	2.5	11.0	Pass
5580	16	17.4	99.4	15.8	15.8	23.4	2.5	2.5	11.0	Pass
5700	14	17.3	99.4	14.0	14.0	23.4	1.3	1.3	11.0	Pass
5720	16	13.7	99.4	16.0	16.0	22.4	3.2	3.2	11.0	Pass
Portion within 5725-5850 MHz band (UNII-3)										
5720	16	4.7	99.4	-	-	30.0	2.7	2.7	30.0	Pass
802.11n 20MHz										
5500	15	18.4	99.6	15.1	15.1	23.6	2.1	2.1	11.0	Pass
5580	16	18.4	99.6	15.7	15.7	23.6	2.2	2.2	11.0	Pass
5700	13	18.4	99.6	14.0	14.0	23.6	-0.1	-0.1	11.0	Pass
5720	16	14.2	99.9	16.1	16.1	22.5	3.0	3.0	11.0	Pass
Portion within 5725-5850 MHz band (UNII-3)										
5720	16	5.0	99.9	-	-	30.0	2.7	2.7	30.0	Pass
802.11n 40MHz										
5510	12	36.5	99.6	12.2	12.2	24.0	-3.6	-3.6	11.0	Pass
5550	16	36.7	99.6	15.8	15.8	24.0	-0.3	-0.3	11.0	Pass
5670	15	36.7	99.6	15.0	15.0	24.0	-1.0	-1.0	11.0	Pass
5710	16	33.3	99.6	16.0	16.0	24.0	-0.2	-0.2	11.0	Pass
Portion within 5725-5850 MHz band (UNII-3)										
5710	16	10.8	99.6	-	-	30.0	-0.4	-0.4	30.0	Pass
802.11ac 80MHz										
5530	8	76.2	99.2	8.9	8.9	24.0	-12.0	-12.0	11.0	Pass
5690	11	73.0	99.2	10.7	10.7	24.0	-3.6	-3.6	11.0	Pass
Portion within 5725-5850 MHz band (UNII-3)										
5690	16	21.9	99.2	-	-	30.0	-4.4	-4.4	30.0	Pass

Client: Google Inc.	Job Number: JD104891
Model: Model H0A	T-Log Number: T104956
Contact: Dominik Mente	Project Manager: Deepa Shetty
Standard: FCC 15.247 / 15.407 / RSS-247	Project Coordinator: -
	Class: N/A

Plot of worse case 26dB BW

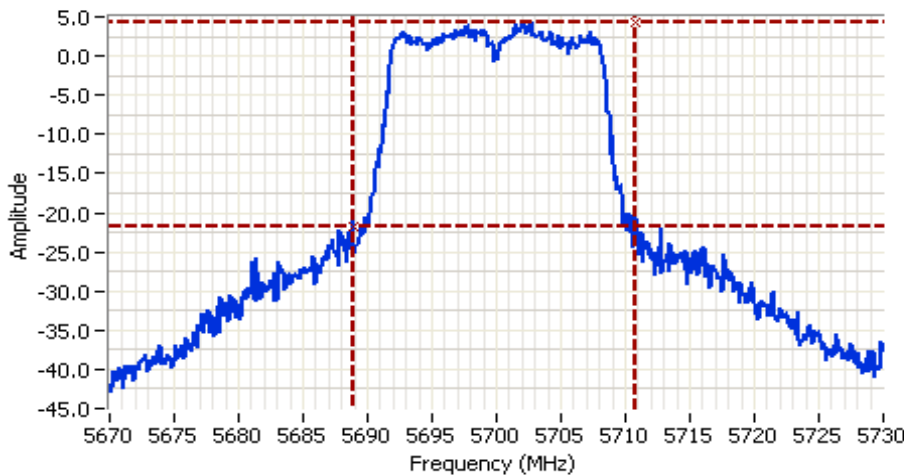

Analyzer Settings
 Rohde&Schwarz,FSQ
 CF: 5700.000 MHz
 SPAN: 60.000 MHz
 RB: 300 kHz
 VB: 1.000 MHz
 Detector: POS
 Attn: 10 DB
 RL Offset: 12.6 DB
 Sweep Time: 20.0ms
 Ref Lvl: 25.6 DBM

Comments
 26dB BW: 21.923 MHz
 11a mode

Cursor 1 5710.7692 4.2  Delta Freq. 21.923
 Cursor 2 5688.8462 -21.8  Delta Amplitude 26.0



Plot of 26dB BW at 5725MHz bandedge

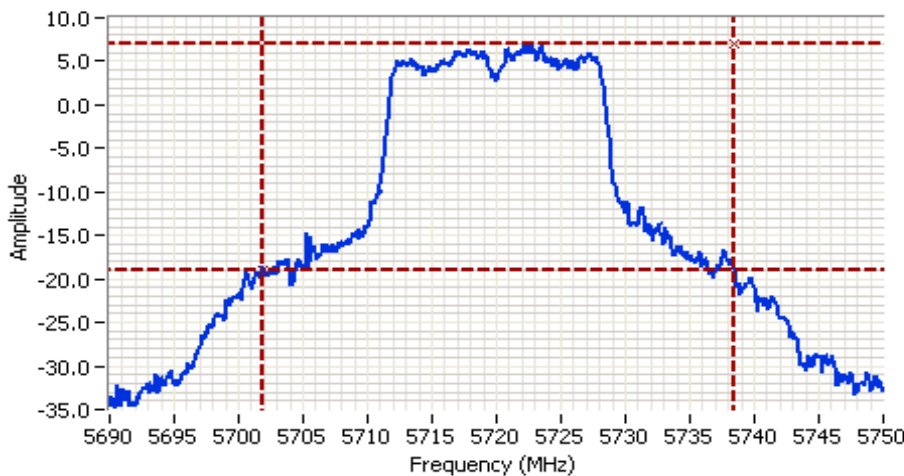

Analyzer Settings
 Rohde&Schwarz,FSQ
 CF: 5720.000 MHz
 SPAN: 60.000 MHz
 RB: 300 kHz
 VB: 1.000 MHz
 Detector: POS
 Attn: 10 DB
 RL Offset: 12.6 DB
 Sweep Time: 20.0ms
 Ref Lvl: 25.6 DBM

Comments
 26dB BW: 36.538 MHz
 UNII-2C = 23.1 MHz
 UNII-3 = 13.5 MHz
 11a mode

Cursor 1 5738.4615 7.0  Delta Freq. 36.538
 Cursor 2 5701.9231 -19.0  Delta Amplitude 26.0



Client: Google Inc.	Job Number: JD104891
Model: Model H0A	T-Log Number: T104956
Contact: Dominik Mente	Project Manager: Deepa Shetty
Standard: FCC 15.247 / 15.407 / RSS-247	Project Coordinator: -
	Class: N/A

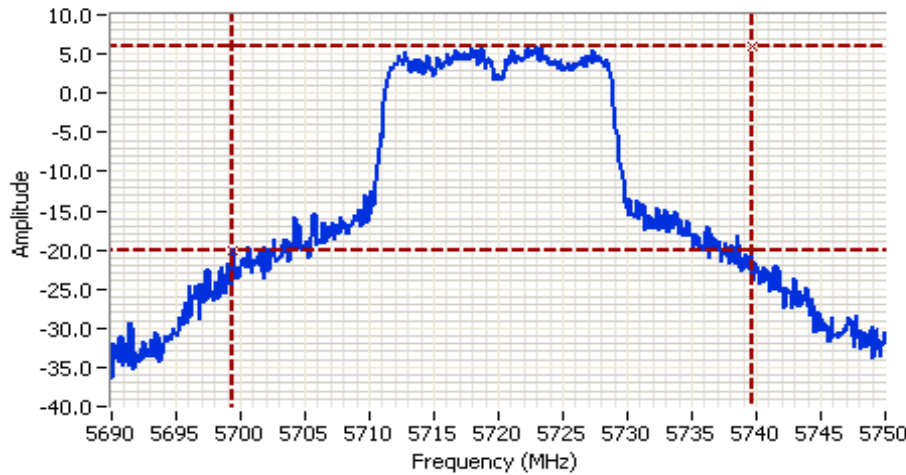

Analyzer Settings
 Rohde&Schwarz,FSQ
 CF: 5720.000 MHz
 SPAN: 60.000 MHz
 RB: 300 kHz
 VB: 1.000 MHz
 Detector: POS
 Attn: 10 DB
 RL Offset: 12.6 DB
 Sweep Time: 20.0ms
 Ref Lvl: 25.6 DBM

Comments
 26dB BW: 40.192 MHz
 UNII-2C = 25.6 MHz
 UNII-3 = 14.6 MHz
 n20 mode

Cursor 1 5739.6154 5.9 

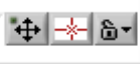
Cursor 2 5699.4231 -20.1 

Delta Freq. 40.192

Delta Amplitude 26.0

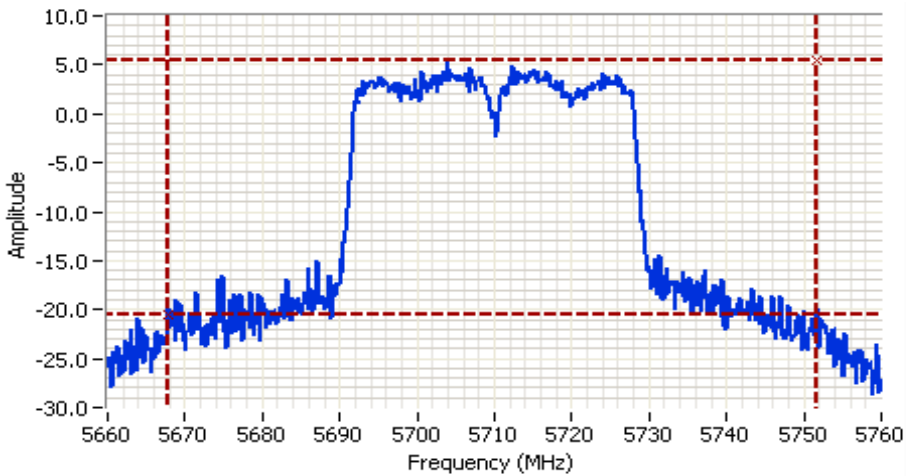

Analyzer Settings
 Rohde&Schwarz,FSQ
 CF: 5710.000 MHz
 SPAN: 100.000 MHz
 RB: 500 kHz
 VB: 2.000 MHz
 Detector: POS
 Attn: 10 DB
 RL Offset: 12.6 DB
 Sweep Time: 20.0ms
 Ref Lvl: 25.6 DBM

Comments
 26dB BW: 83.814 MHz
 UNII-2C = 57.1 MHz
 UNII-3 = 26.7 MHz
 n40 mode

Cursor 1 5751.6667 5.5 

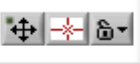
Cursor 2 5667.8526 -20.5 

Delta Freq. 83.814

Delta Amplitude 26.0



Client: Google Inc.	Job Number: JD104891
Model: Model H0A	T-Log Number: T104956
Contact: Dominik Mente	Project Manager: Deepa Shetty
Standard: FCC 15.247 / 15.407 / RSS-247	Project Coordinator: -
	Class: N/A

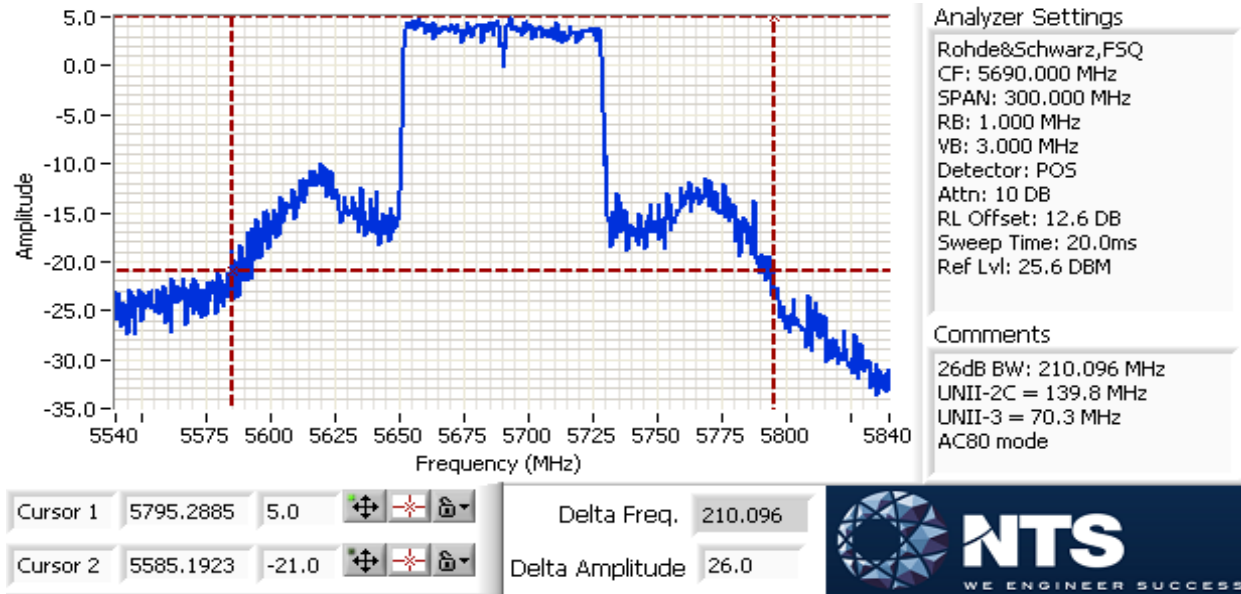

Plots of PSD and 99%BW, worse case for each mode.

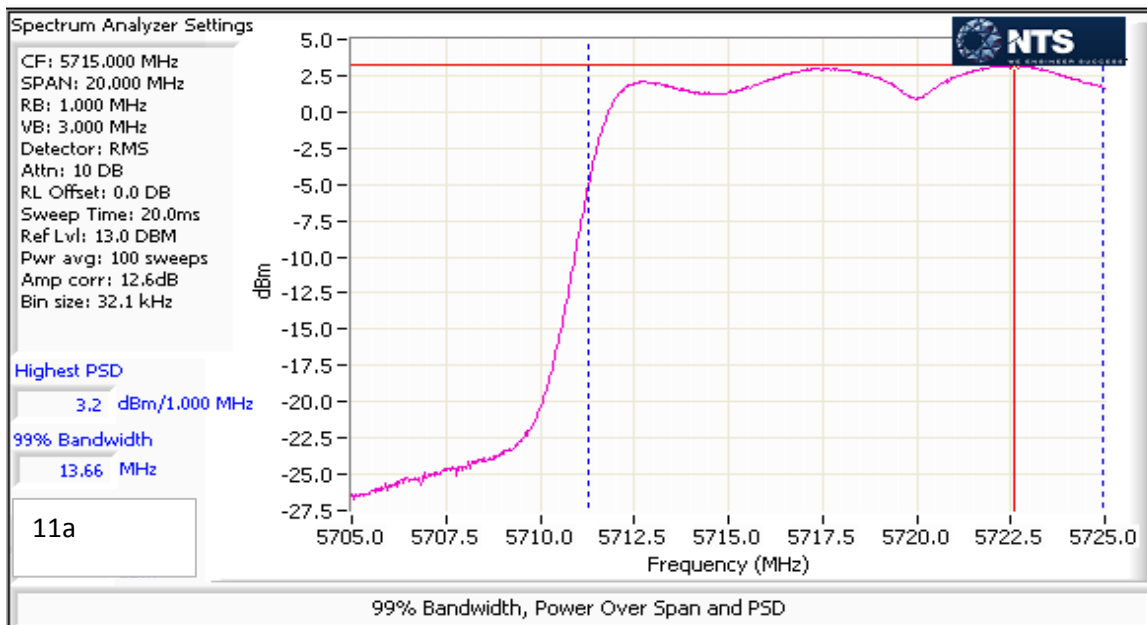

Client: Google Inc.	Job Number: JD104891
Model: Model H0A	T-Log Number: T104956
Contact: Dominik Mente	Project Manager: Deepa Shetty
Standard: FCC 15.247 / 15.407 / RSS-247	Project Coordinator: -
	Class: N/A

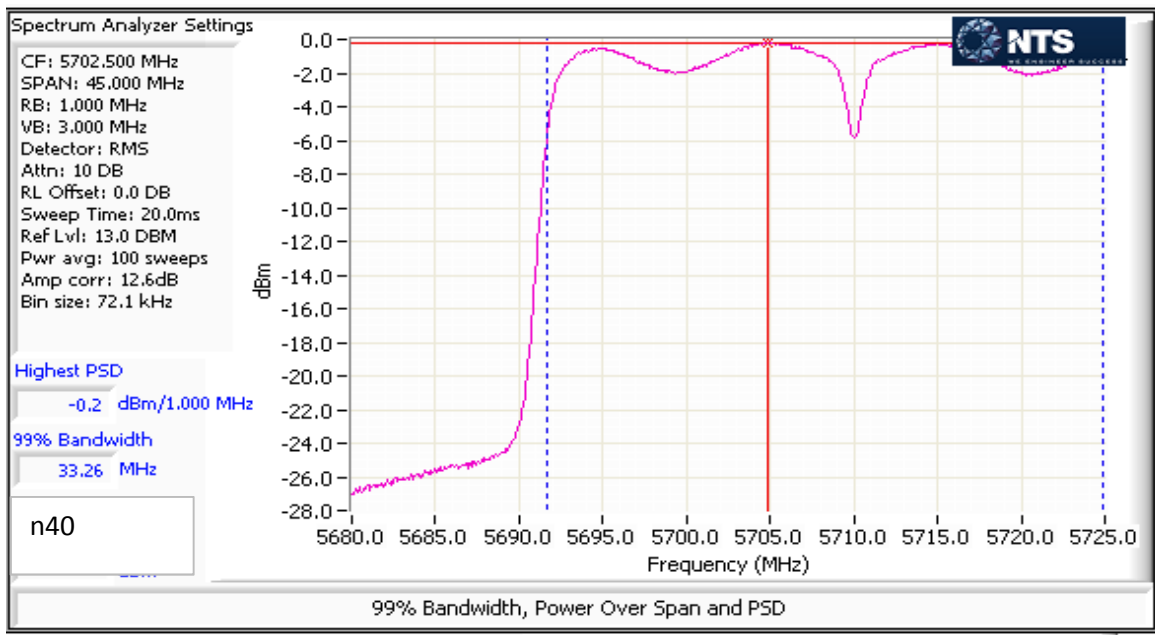
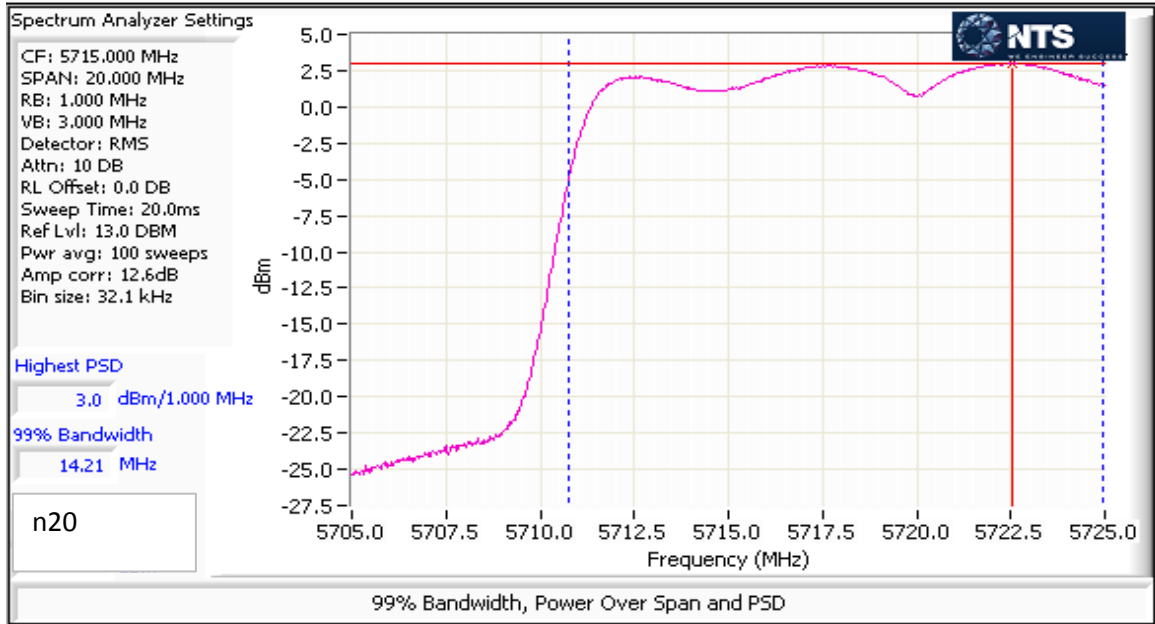

Client: Google Inc.	Job Number: JD104891
Model: Model H0A	T-Log Number: T104956
	Project Manager: Deepa Shetty
Contact: Dominik Mente	Project Coordinator: -
Standard: FCC 15.247 / 15.407 / RSS-247	Class: N/A

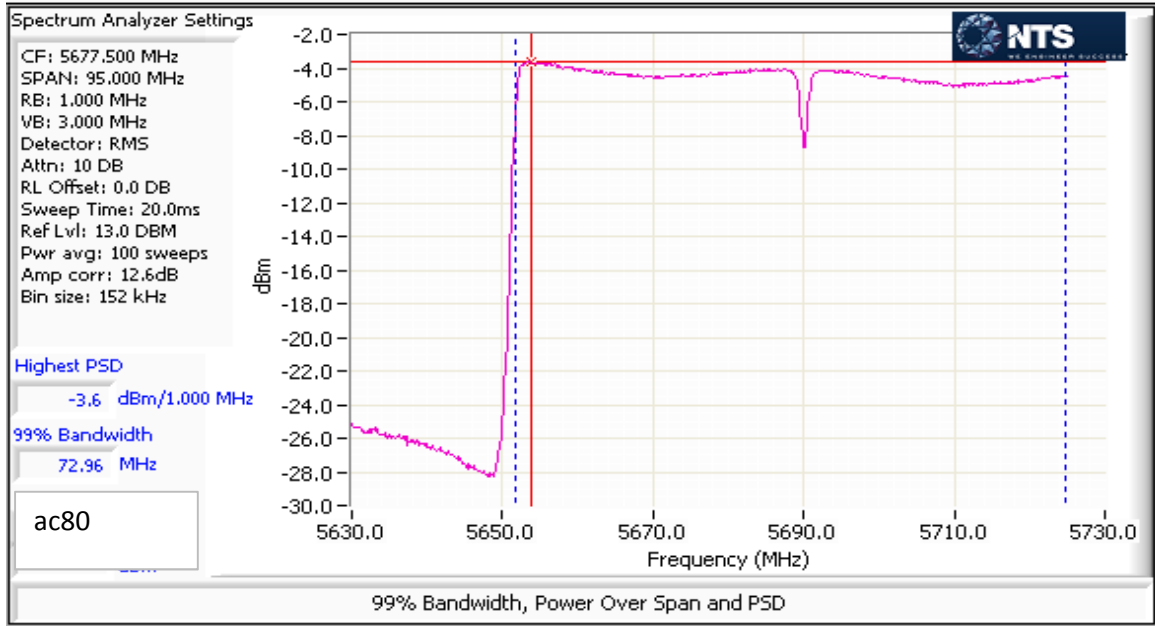



EMC Test Data

Client: Google Inc.	Job Number: JD104891
Model: Model H0A	T-Log Number: T104956
Contact: Dominik Mente	Project Manager: Deepa Shetty
Standard: FCC 15.247 / 15.407 / RSS-247	Project Coordinator: -
	Class: N/A

SISO Device - 5725-5850 MHz Band - FCC

Antenna Gain (dBi): 3.7 Max EIRP: 178.9 mW 22.5 dBm

Frequency (MHz)	Software Setting	26dB BW (MHz)	Duty Cycle %	Output Power ¹ dBm			PSD ² dBm/MHz			Result
				Measured	Calculated	Limit	Measured	Calculated	Limit	
802.11a										
5745	21	74.4	99.4	18.8	18.8	30.0	6.4	6.4	17.0	Pass
5785	21	70.7	99.4	18.5	18.5	30.0	5.9	5.9	17.0	Pass
5825	21	78.2	99.4	18.5	18.5	30.0	5.6	5.6	17.0	Pass
802.11n 20MHz										
5745	21	78.0	99.6	18.7	18.7	30.0	5.7	5.7	17.0	Pass
5785	21	77.9	99.6	18.7	18.7	30.0	5.6	5.6	17.0	Pass
5825	21	78.4	99.6	18.6	18.6	30.0	5.5	5.5	17.0	Pass
802.11n 40MHz										
5755	16	87.5	99.2	16.8	16.8	30.0	2.5	2.5	17.0	Pass
5795	17	142.6	99.2	17.8	17.8	30.0	2.1	2.1	17.0	Pass
802.11ac 80MHz										
5775	14	207.5	99.2	14.8	14.8	30.0	-0.3	-0.3	17.0	Pass

SISO Device - 5725-5850 MHz Band - Industry Canada

Antenna Gain (dBi): 3.7 Max EIRP: 178.9 mW 22.5 dBm

Frequency (MHz)	Software Setting	99% BW (MHz)	Duty Cycle %	Output Power ¹ dBm			PSD ² dBm/MHz			Result
				Measured	Calculated	Limit	Measured	Calculated	Limit ³	
802.11a										
5745	21	34.4	99.4	18.8	18.8	30.0	6.4	6.4	17.0	Pass
5785	21	30.6	99.4	18.5	18.5	30.0	5.9	5.9	17.0	Pass
5825	21	32.8	99.4	18.5	18.5	30.0	5.6	5.6	17.0	Pass
802.11n 20MHz										
5745	21	34.4	99.6	18.7	18.7	30.0	5.7	5.7	17.0	Pass
5785	21	30.9	99.6	18.7	18.7	30.0	5.6	5.6	17.0	Pass
5825	21	33.0	99.6	18.6	18.6	30.0	5.5	5.5	17.0	Pass
802.11n 40MHz										
5755	16	56.4	99.2	16.8	16.8	30.0	2.5	2.5	17.0	Pass
5795	17	96.0	99.2	17.8	17.8	30.0	2.1	2.1	17.0	Pass
802.11ac 80MHz										
5775	14	152.0	99.2	14.8	14.8	30.0	-0.3	-0.3	17.0	Pass

Client: Google Inc.	Job Number: JD104891
Model: Model H0A	T-Log Number: T104956
Contact: Dominik Mente	Project Manager: Deepa Shetty
Standard: FCC 15.247 / 15.407 / RSS-247	Project Coordinator: -
	Class: N/A

Plots of PSD and 99%BW, worse case for each mode.

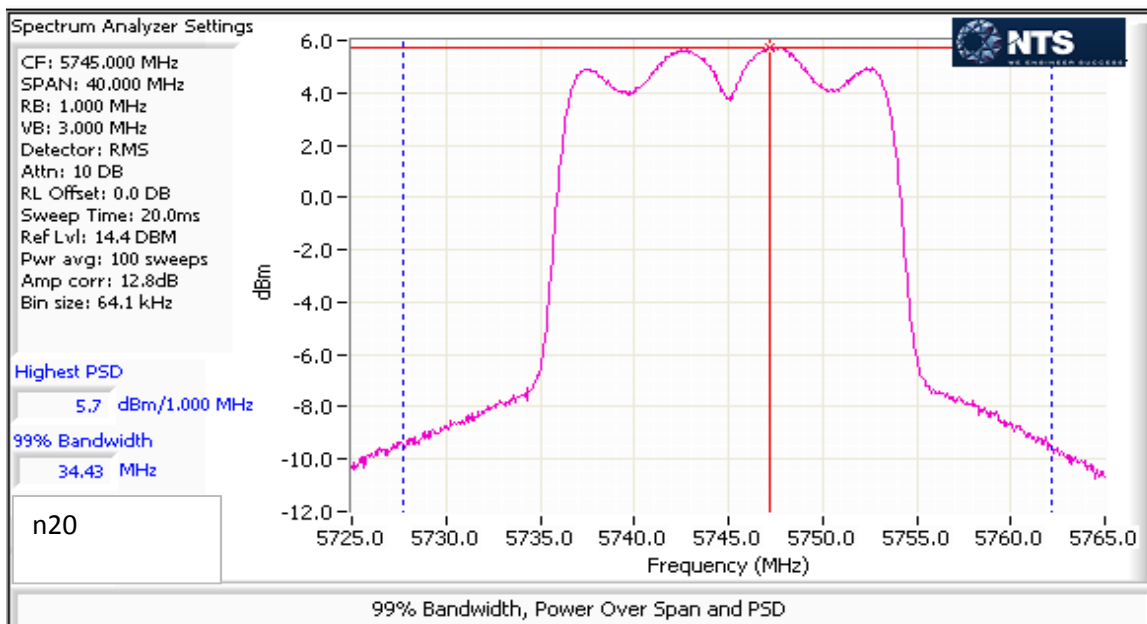
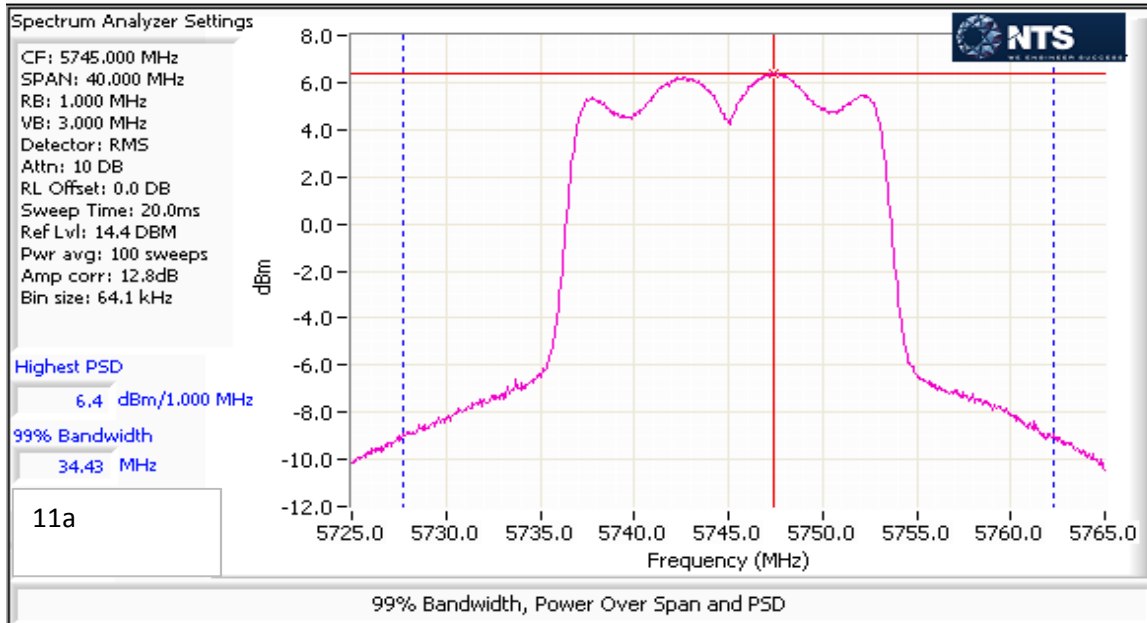

Client: Google Inc.	Job Number: JD104891
Model: Model H0A	T-Log Number: T104956
Contact: Dominik Mente	Project Manager: Deepa Shetty
Standard: FCC 15.247 / 15.407 / RSS-247	Project Coordinator: -
	Class: N/A

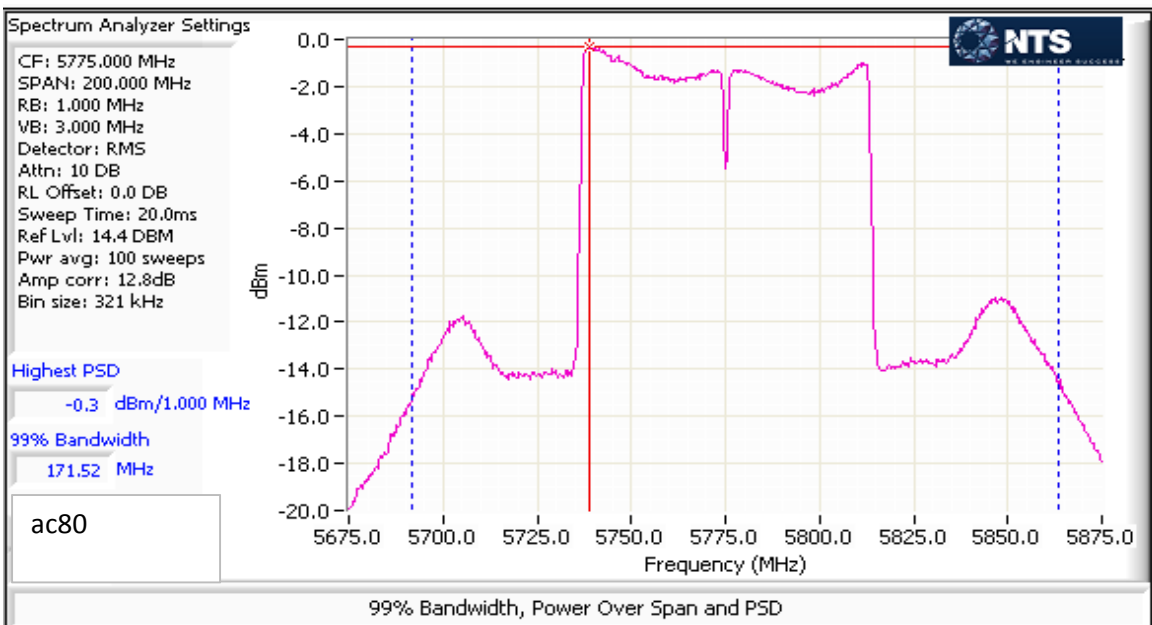
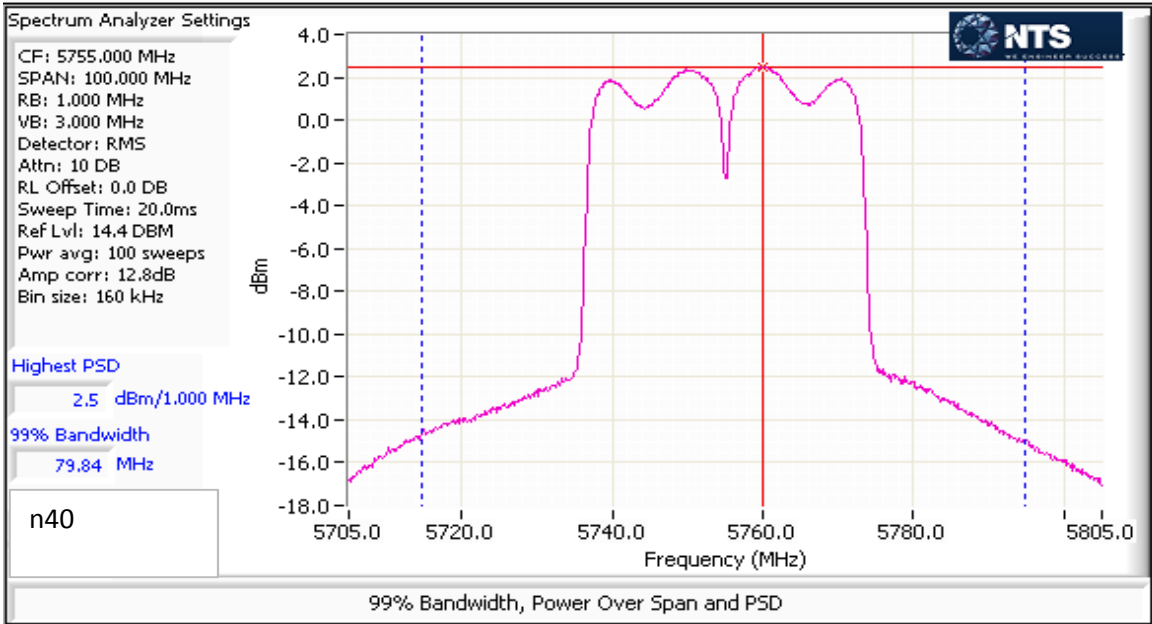



EMC Test Data

Client: Google Inc.	Job Number: JD104891
Model: Model H0A	T-Log Number: T104956
Contact: Dominik Mente	Project Manager: Deepa Shetty
Standard: FCC 15.247 / 15.407 / RSS-247	Project Coordinator: -
	Class: N/A

Run #2: Bandwidth, 5725-5850MHz

Date of Test: 07/20/17

Test Location: Lab 4

Test Engineer: M. Birgani

EUT Voltage: USB

Mode: 11a

Power Setting	Frequency (MHz)	Bandwidth (MHz)		RBW Setting (kHz)	
		6dB		6dB	
21	5745	16.1		100	
21	5785	16.0		100	
21	5825	16.3		100	

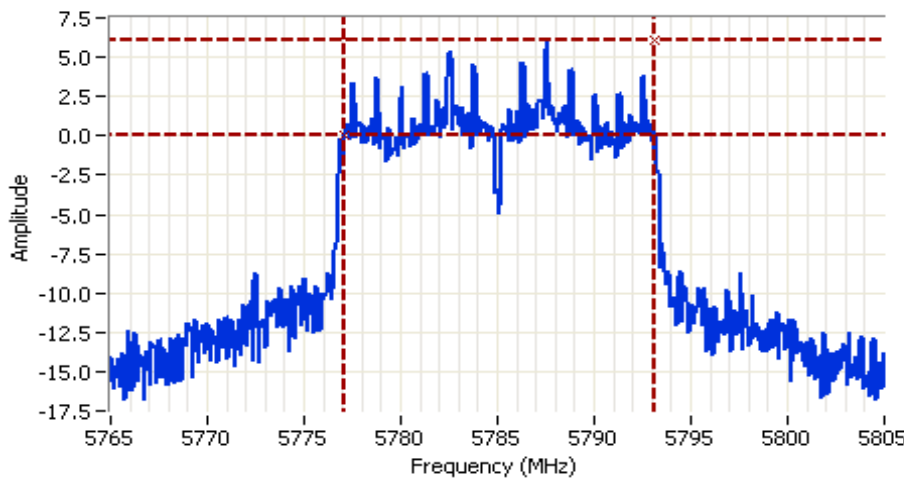

Analyzer Settings

Rohde&Schwarz,F5Q
 CF: 5785.000 MHz
 SPAN: 40.000 MHz
 RB: 100 kHz
 VB: 300 kHz
 Detector: POS
 Attn: 10 DB
 RL Offset: 11.8 DB
 Sweep Time: 20.0ms
 Ref Lvl: 20.0 DBM

Comments

802.11a
 6dB BW: 16.0 MHz

Cursor 1	5793.1410	6.1	
Cursor 2	5777.1154	0.1	

Delta Freq. 16.026

Delta Amplitude 6.0



Client: Google Inc.	Job Number: JD104891
Model: Model H0A	T-Log Number: T104956
Contact: Dominik Mente	Project Manager: Deepa Shetty
Standard: FCC 15.247 / 15.407 / RSS-247	Project Coordinator: -
	Class: N/A

Run #2: Bandwidth on channels adjacent to 5600-5650MHz

Date of Test: 07/19/17

Test Location: Lab 4

Test Engineer: M. Birgani

EUT Voltage: USB

Mode: 11a

Power Setting	Center Frequency (MHz)	99% BW (MHz)	
		Fl	Fh
16	5580	5571.264	5588.864
16	5660	5651.072	5669.44

Note 1: 99% BW: RBW=1.5% of 99%BW, VBW ≥ 3*RBW, peak detector, max hold, auto sweep time. Span 1.5-5 times OBW.

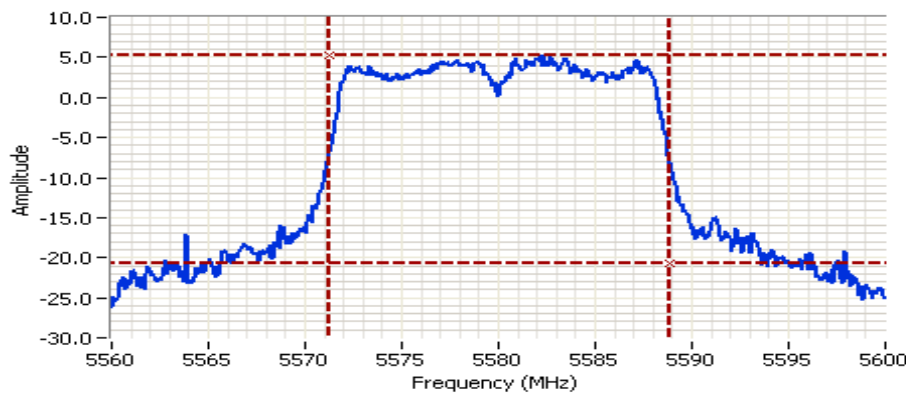

Analyzer Settings

Rohde&Schwarz,FSQ
 CF: 5580.000 MHz
 SPAN: 40.000 MHz
 RB: 300 kHz
 VB: 1.000 MHz
 Detector: POS
 Attn: 10 DB
 RL Offset: 11.8 DB
 Sweep Time: 20.0ms
 Ref Lvl: 21.8 DBM

Comments

802.11a
 99% BW: 17.6 MHz
 FH: 5580.864 MHz

Cursor 1	5571.2640	5.2	
Cursor 2	5588.8640	-20.8	

Delta Freq. 17.600

Delta Amplitude 26.0

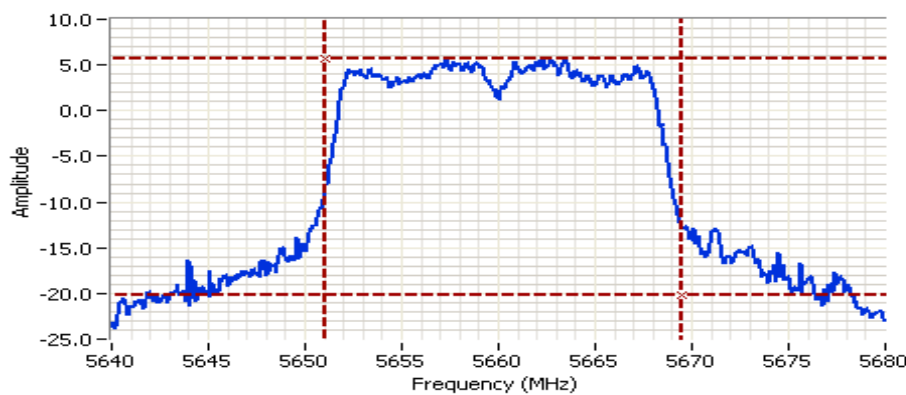

Analyzer Settings

Rohde&Schwarz,FSQ
 CF: 5660.000 MHz
 SPAN: 40.000 MHz
 RB: 300 kHz
 VB: 1.000 MHz
 Detector: POS
 Attn: 10 DB
 RL Offset: 11.8 DB
 Sweep Time: 20.0ms
 Ref Lvl: 21.8 DBM

Comments

802.11a
 99% BW: 18.4 MHz
 FL: 5651.072 MHz

Cursor 1	5651.0720	5.7	
Cursor 2	5669.4400	-20.3	

Delta Freq. 18.368

Delta Amplitude 26.0



Client: Google Inc.	Job Number: JD104891
Model: Model H0A	T-Log Number: T104956
Contact: Dominik Mente	Project Manager: Deepa Shetty
Standard: FCC 15.247 / 15.407 / RSS-247	Project Coordinator: -
	Class: N/A

Mode: n20

Power Setting	Center Frequency (MHz)	99% BW (MHz)	
		Fl	Fh
16	5580	5570.688	5589.504
15	5660	5650.944	5669.184

Note 1: 99% BW: RBW=1-5% of 99%BW, VBW ≥ 3*RBW, peak detector, max hold, auto sweep time. Span 1.5-5 times OBW.

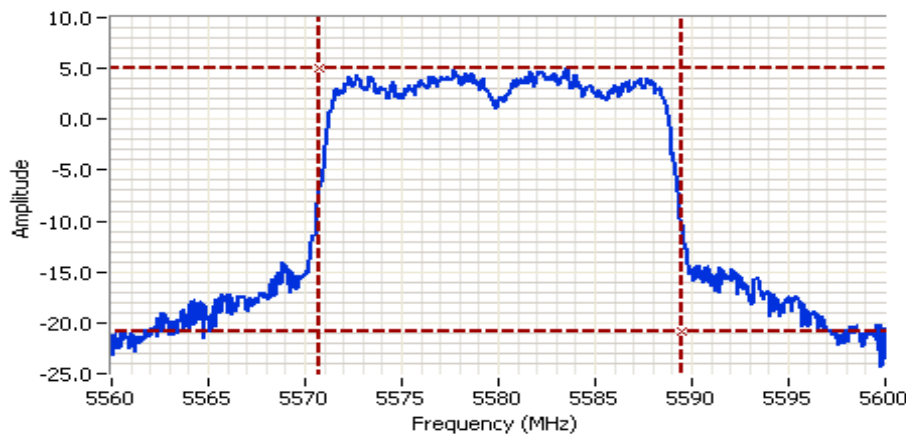

Analyzer Settings

Rohde&Schwarz,FSQ
 CF: 5580.000 MHz
 SPAN: 40.000 MHz
 RB: 300 kHz
 VB: 1.000 MHz
 Detector: POS
 Attn: 10 DB
 RL Offset: 11.8 DB
 Sweep Time: 20.0ms
 Ref Lvl: 21.8 DBM

Comments

802.11n 20
 99% BW: 18.8 MHz
 FH: 5580.864 MHz

Cursor 1	5570.6880	5.1	
Cursor 2	5589.5040	-20.9	

Delta Freq. 18.816
 Delta Amplitude 26.0

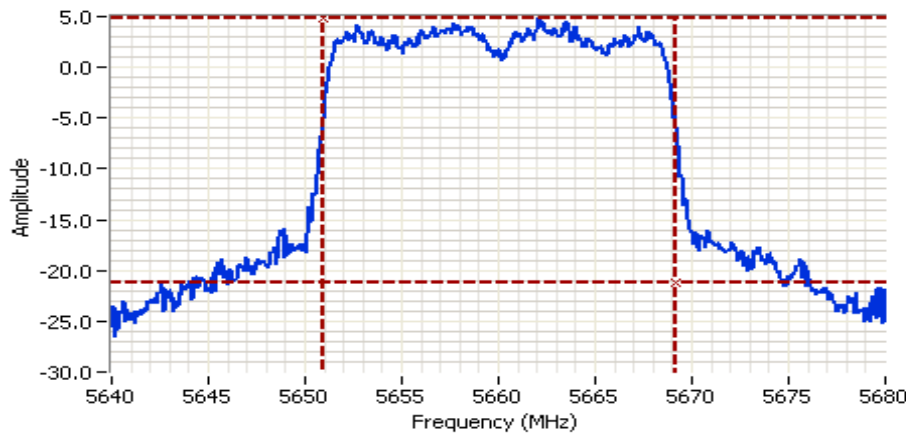

Analyzer Settings

Rohde&Schwarz,FSQ
 CF: 5660.000 MHz
 SPAN: 40.000 MHz
 RB: 300 kHz
 VB: 1.000 MHz
 Detector: POS
 Attn: 10 DB
 RL Offset: 11.8 DB
 Sweep Time: 20.0ms
 Ref Lvl: 21.8 DBM

Comments

802.11n 20
 99% BW: 18.2 MHz
 FL: 5650.944 MHz

Cursor 1	5650.9440	4.8	
Cursor 2	5669.1840	-21.2	

Delta Freq. 18.240
 Delta Amplitude 26.0



Client: Google Inc.	Job Number: JD104891
Model: Model H0A	T-Log Number: T104956
Contact: Dominik Mentel	Project Manager: Deepa Shetty
Standard: FCC 15.247 / 15.407 / RSS-247	Project Coordinator: -
	Class: N/A

Mode: n40

Power Setting	Center Frequency (MHz)	99% BW (MHz)	
		Fl	Fh
15	5550	5531.632	5568.496
15	5670	5651.504	5688.624

Note 1: 99% BW: RBW=1-5% of 99%BW, VBW ≥ 3*RBW, peak detector, max hold, auto sweep time. Span 1.5-5 times OBW.

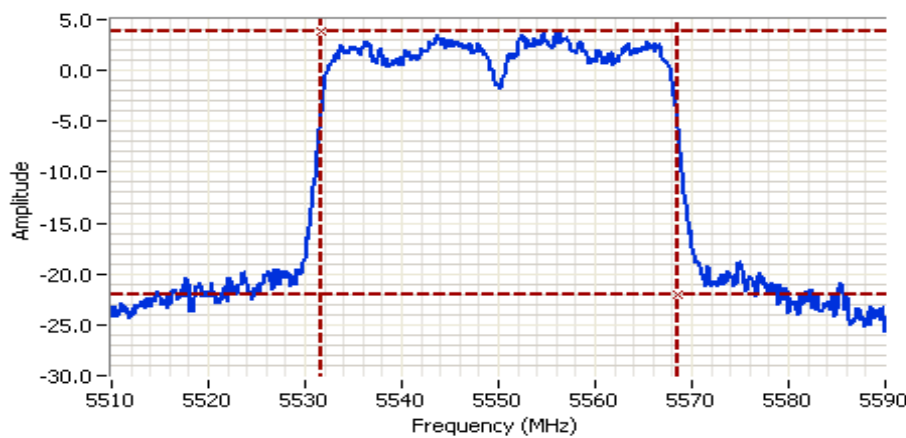

Analyzer Settings
 Rohde&Schwarz,FSQ
 CF: 5550.000 MHz
 SPAN: 80.000 MHz
 RB: 500 kHz
 VB: 2.000 MHz
 Detector: POS
 Attn: 10 DB
 RL Offset: 11.8 DB
 Sweep Time: 20.0ms
 Ref Lvl: 21.8 DBM

Comments
 802.11n 40
 99% BW: 36.9 MHz
 FH: 5568.496 MHz

Cursor 1	5531.6320	3.9		Delta Freq.	36.864
Cursor 2	5568.4960	-22.1		Delta Amplitude	26.0

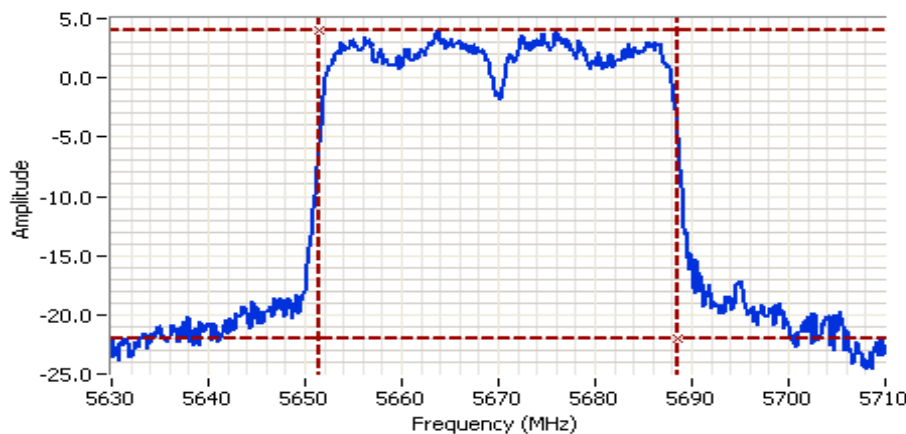

Analyzer Settings
 Rohde&Schwarz,FSQ
 CF: 5670.000 MHz
 SPAN: 80.000 MHz
 RB: 500 kHz
 VB: 2.000 MHz
 Detector: POS
 Attn: 10 DB
 RL Offset: 11.8 DB
 Sweep Time: 20.0ms
 Ref Lvl: 21.8 DBM

Comments
 802.11n 40
 99% BW: 37.1 MHz
 FL: 5651.504 MHz

Cursor 1	5651.5040	3.9		Delta Freq.	37.120
Cursor 2	5688.6240	-22.1		Delta Amplitude	26.0



Client: Google Inc.	Job Number: JD104891
Model: Model H0A	T-Log Number: T104956
Contact: Dominik Mente	Project Manager: Deepa Shetty
Standard: FCC 15.247 / 15.407 / RSS-247	Project Coordinator: -
	Class: N/A

Mode: ac80

Power Setting	Center Frequency (MHz)	99% BW (MHz)	
		Fl	Fh
8	5530	5491.500	5568.780
11	5690	5650.800	5729.200

Note 1: 99% BW: RBW=1-5% of 99%BW, VBW ≥ 3*RBW, peak detector, max hold, auto sweep time. Span 1.5-5 times OBW.

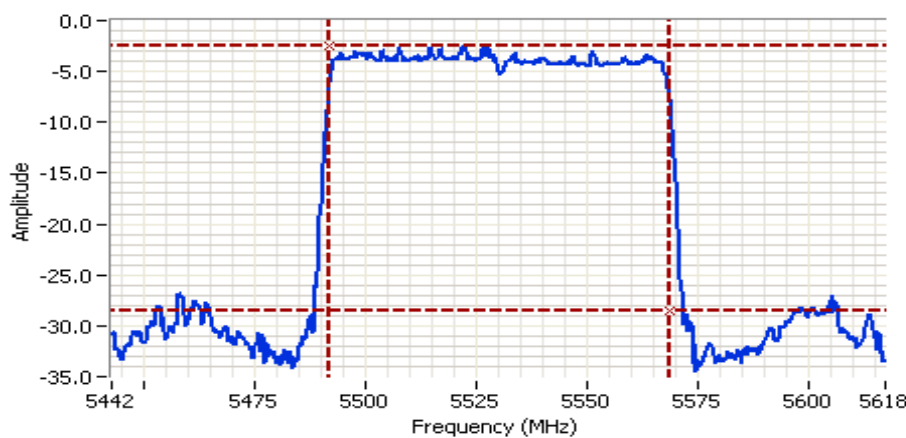

Analyzer Settings

Rohde&Schwarz,FSQ
 CF: 5530.000 MHz
 SPAN: 175.000 MHz
 RB: 1.000 MHz
 VB: 3.000 MHz
 Detector: POS
 Attn: 10 DB
 RL Offset: 11.8 DB
 Sweep Time: 20.0ms
 Ref Lvl: 21.8 DBM

Comments

802.11ac 80
 99% BW: 77.3 MHz
 FH: 5568.780 MHz

Cursor 1 5491.5000 -2.5
 Cursor 2 5568.7800 -28.5
 Delta Freq. 77.280
 Delta Amplitude 26.0

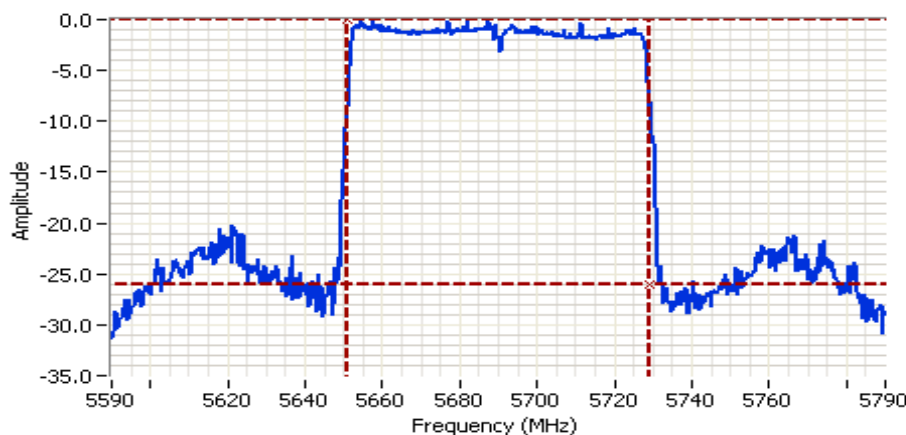

Analyzer Settings

Rohde&Schwarz,FSQ
 CF: 5690.000 MHz
 SPAN: 200.000 MHz
 RB: 1.000 MHz
 VB: 3.000 MHz
 Detector: POS
 Attn: 10 DB
 RL Offset: 11.8 DB
 Sweep Time: 20.0ms
 Ref Lvl: 21.8 DBM

Comments

802.11ac 80
 99% BW: 78.4 MHz
 FL: 5650.800 MHz

Cursor 1 5650.8000 -0.1
 Cursor 2 5729.2000 -26.1
 Delta Freq. 78.400
 Delta Amplitude 26.0





EMC Test Data

Client: Google Inc.	Job Number: JD104891
Model: Model H0A	T-Log Number: T104956
	Project Manager: Deepa Shetty
Contact: Dominik Mente	Project Coordinator: -
Standard: FCC 15.247 / 15.407 / RSS-247	Class: N/A

RSS-247, FCC 15.247, 15.407 Radiated Spurious Emissions

Test Specific Details

Objective: The objective of this test session is to perform final qualification testing of the EUT with respect to the specification listed above.

General Test Configuration

The EUT and all local support equipment were located on the turntable for radiated spurious emissions testing.

For radiated emissions testing the measurement antenna was located 3 meters from the EUT, unless otherwise noted.

Ambient Conditions:		7/7/2017	7/18/2017
	Temperature:	23.4 °C	22.8 °C
	Rel. Humidity:	41 %	40 %

Summary of Results - Device Operating in the 2400-2483.5 MHz Band

Run #	Mode	Channel	Target Power (dBm)	Passing Power Setting	Test Performed	Limit	Result / Margin
1	BLE + 11b	2402MHz	6	6	Radiated Emissions, 30-1000MHz	FCC Part 15.209 / 15.247 / 15.407	27.6 dBµV/m @ 125.06 MHz (-15.9 dB)
		2462MHz	16	19			
	BLE + 11b	2402MHz	6	6	Radiated Emissions, 1 - 25 GHz	FCC Part 15.209 / 15.247 / 15.407	46.1 dBµV/m @ 4924.0 MHz (-7.9 dB)
		2462MHz	16	19			
2	BLE + 11a	2480MHz	6	6	Radiated Emissions, 30-1000MHz	FCC Part 15.209 / 15.247 / 15.407	38.7 dBµV/m @ 960.04 MHz (-15.3 dB)
		5180MHz	16	16			
	BLE + 11a	2480MHz	6	6	Radiated Emissions, 1 - 40 GHz	FCC Part 15.209 / 15.247 / 15.407	42.8 dBµV/m @ 4952.9 MHz (-11.2 dB)
		5180MHz	16	16			

Modifications Made During Testing

No modifications were made to the EUT during testing

Deviations From The Standard

No deviations were made from the requirements of the standard.



EMC Test Data

Client:	Google Inc.	Job Number:	JD104891
Model:	Model H0A	T-Log Number:	T104956
		Project Manager:	Deepa Shetty
Contact:	Dominik Mente	Project Coordinator:	-
Standard:	FCC 15.247 / 15.407 / RSS-247	Class:	N/A

Sample Notes

Sample S/N: Engineering Radiated Sample #2
 Driver: -
 Antenna: Internal

Procedure Comments:

Measurements performed in accordance with FCC KDB 558074
 Peak measurements performed with: RBW=1MHz, VBW=3MHz, peak detector, max hold, auto sweep time
 Unless otherwise stated/noted, emission has duty cycle $\geq 98\%$ and was measured using RBW=1MHz, VBW=10Hz, peak detector, linear average mode, auto sweep time, max hold.
 2.4GHz band reject filter used

Mode	Data Rate	Duty Cycle (x)	Constant DC?	T (ms)	Pwr Cor Factor*	Lin Volt Cor Factor**	Min VBW for FS (Hz)
11b	1 Mb/s	> .99	Yes	-	0	0	10
11a	6MB/s	0.99	Yes	2.157	0	0	10
BLE	1Mb/s	0.62	Yes	0.387	2.1	4.1	2584

Measurement Specific Notes:

Note 1:	Emission in non-restricted band, but limit of 15.209 used.
Note 2:	Emission in non-restricted band, the limit was set 30dB below the level of the fundamental and measured in 100kHz.
Note 4:	Emission has constant duty cycle < 98%, average measurement performed: RBW=1MHz, VBW>1/T but not less than 10Hz, peak detector, linear averaging, auto sweep, trace average 100 traces, measurement corrected by Linear voltage correction factor
Note 6:	Emission has non constant duty cycle < 98%, average measurement performed: RBW=1MHz, VBW> 1/T, peak detector, linear average mode, sweep time auto, max hold. Max hold for 50*(1/DC) traces



EMC Test Data

Client: Google Inc.	Job Number: JD104891
Model: Model H0A	T-Log Number: T104956
Contact: Dominik Mente	Project Manager: Deepa Shetty
Standard: FCC 15.247 / 15.407 / RSS-247	Project Coordinator: -
	Class: N/A

Run #1: Radiated Spurious Emissions, 30MHz - 25GHz.
 Date of Test: 7/18/2017 0:00
 Test Engineer: Rafael Varelas
 Test Location: FT Chamber #4
 Config. Used: 1
 Config Change: None
 EUT Voltage: 120V/60Hz

Channel: 2462 MHz Mode: b
 Antenna 2 Data Rate: 1 Mb/s

Channel: 2402 MHz Mode: BLE
 Antenna 2 Data Rate: 1 Mb/s

Run #1a: 30-1000MHz

Frequency MHz	Level dB μ V/m	Pol v/h	15.209 / 15.247		Detector Pk/QP/Avg	Azimuth degrees	Height meters	Comments
			Limit	Margin				
125.057	27.6	H	43.5	-15.9	QP	84	2.0	QP (1.00s)
37.813	24.1	V	40.0	-15.9	QP	306	1.0	QP (1.00s)
240.018	27.8	H	46.0	-18.2	QP	282	1.3	QP (1.00s)
167.180	24.8	V	43.5	-18.7	QP	238	1.0	QP (1.00s)
960.036	34.9	H	54.0	-19.1	QP	70	1.4	QP (1.00s)

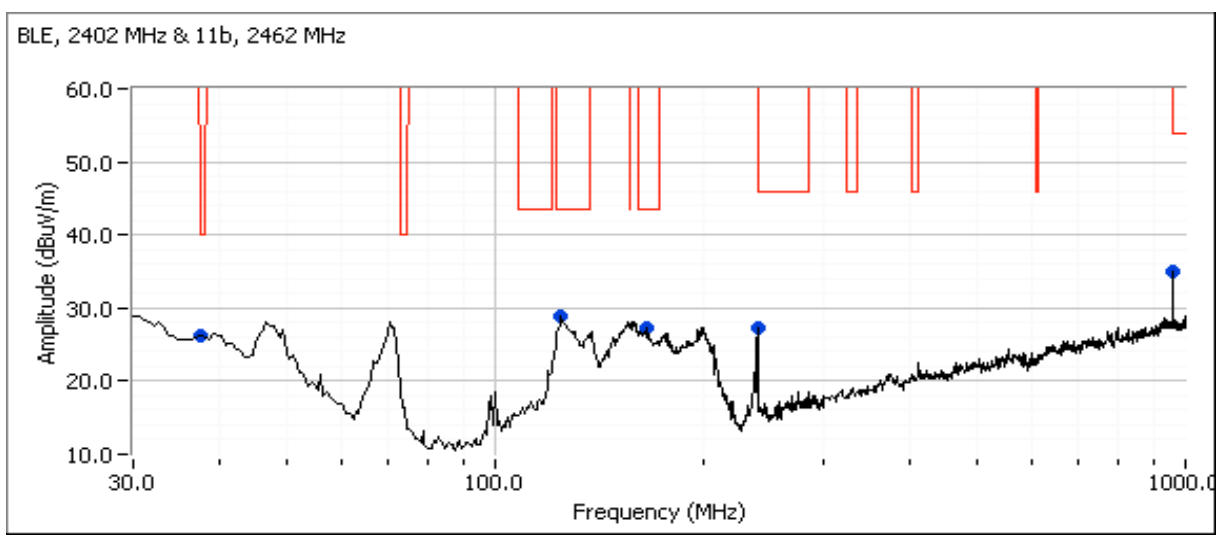



EMC Test Data

Client: Google Inc.	Job Number: JD104891
Model: Model H0A	T-Log Number: T104956
Contact: Dominik Mente	Project Manager: Deepa Shetty
Standard: FCC 15.247 / 15.407 / RSS-247	Project Coordinator: -
	Class: N/A

Run #1b: 1000-25000MHz

Date of Test: 7/7/2017 0:00
 Test Engineer: Rafael Varelas
 Test Location: FT Chamber #7

Config. Used: 1
 Config Change: None
 EUT Voltage: 120V/60Hz

Frequency	Level	Pol	15.209 / 15.247		Detector	Azimuth	Height	Comments
MHz	dB μ V/m	v/h	Limit	Margin	Pk/QP/Avg	degrees	meters	
4923.980	46.1	H	54.0	-7.9	AVG	18	1.0	RB 1 MHz;VB 10 Hz;Peak
4923.950	51.4	H	74.0	-22.6	PK	18	1.0	RB 1 MHz;VB 3 MHz;Peak
3282.680	38.8	H	54.0	-15.2	AVG	352	1.5	RB 1 MHz;VB 10 Hz;Peak
3282.760	46.0	H	74.0	-28.0	PK	352	1.5	RB 1 MHz;VB 3 MHz;Peak
1325.000	42.6	V	54.0	-11.4	Peak	81	1.0	Not a radio signal.
1991.670	44.0	H	70.0	-26.0	Peak	127	2.5	Not a radio signal.

Note: Scans made between 18 - 25 GHz with the measurement antenna moved around the card and its antennas 20-50cm from the device indicated there were no significant emissions in this frequency range

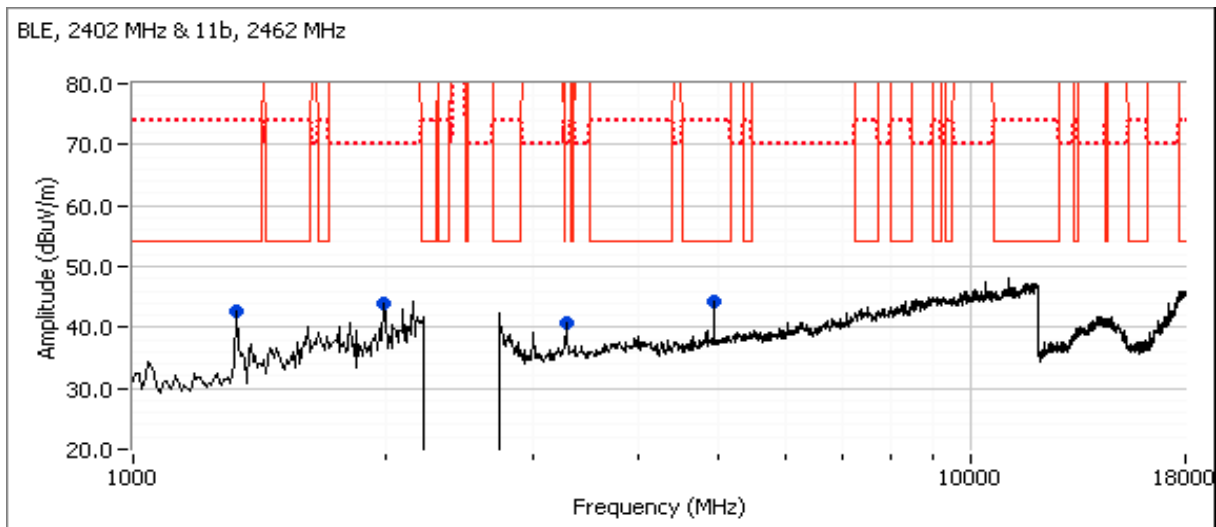



EMC Test Data

Client: Google Inc.	Job Number: JD104891
Model: Model H0A	T-Log Number: T104956
Contact: Dominik Mente	Project Manager: Deepa Shetty
Standard: FCC 15.247 / 15.407 / RSS-247	Project Coordinator: -
	Class: N/A

Run #2: Radiated Spurious Emissions, 30MHz - 40GHz.
 Date of Test: 7/18/2017 0:00
 Test Engineer: Rafael Varelas
 Test Location: FT Chamber #4
 Config. Used: 1
 Config Change: None
 EUT Voltage: 120V/60Hz

Channel: 5180 MHz Mode: a
 Antenna 2 Data Rate: 6MB/s

Channel: 2480 MHz Mode: BLE
 Antenna 2 Data Rate: 1 Mb/s

Run #2a: 30-1000MHz

Frequency MHz	Level dB μ V/m	Pol v/h	15.209 / 15.247		Detector Pk/QP/Avg	Azimuth degrees	Height meters	Comments
			Limit	Margin				
960.036	38.7	H	54.0	-15.3	QP	122	1.5	QP (1.00s)
37.778	23.9	V	40.0	-16.1	QP	266	1.0	QP (1.00s)
126.832	27.2	H	43.5	-16.3	QP	97	1.9	QP (1.00s)
164.920	25.4	V	43.5	-18.1	QP	210	1.0	QP (1.00s)
240.018	26.6	H	46.0	-19.4	QP	266	1.0	QP (1.00s)

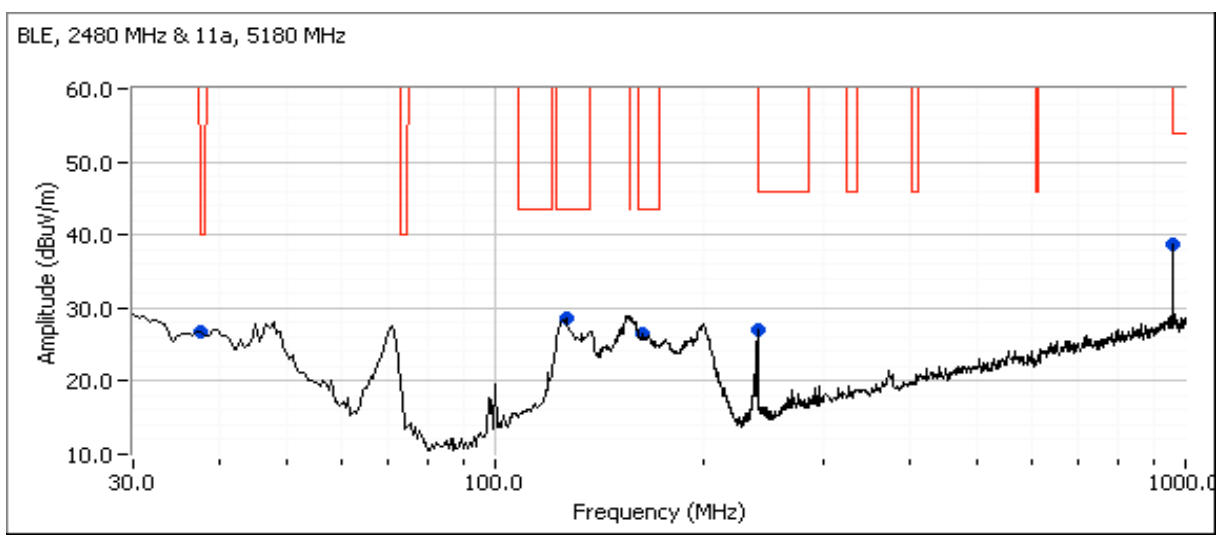



EMC Test Data

Client: Google Inc.	Job Number: JD104891
Model: Model H0A	T-Log Number: T104956
Contact: Dominik Mente	Project Manager: Deepa Shetty
Standard: FCC 15.247 / 15.407 / RSS-247	Project Coordinator: -
	Class: N/A

Run #2b: 1000-4000MHz

Date of Test: 7/7/2017 0:00
 Test Engineer: Rafael Varelas
 Test Location: FT Chamber #7

Config. Used: 1
 Config Change: None
 EUT Voltage: 120V/60Hz

Frequency	Level	Pol	15.209 / 15.247		Detector	Azimuth	Height	Comments
MHz	dB μ V/m	v/h	Limit	Margin	Pk/QP/Avg	degrees	meters	
4952.930	42.8	H	54.0	-11.2	Avg	11	1.3	RB 1 MHz;VB 3 kHz note 4
4952.680	50.9	H	74.0	-23.1	PK	11	1.3	RB 1 MHz;VB 3 MHz;Peak
1333.330	46.4	V	54.0	-7.6	Peak	124	1.0	Not a radio signal.

Note: Scans made between 18 - 40 GHz with the measurement antenna moved around the card and its antennas 20-50cm from the device indicated there were no significant emissions in this frequency range

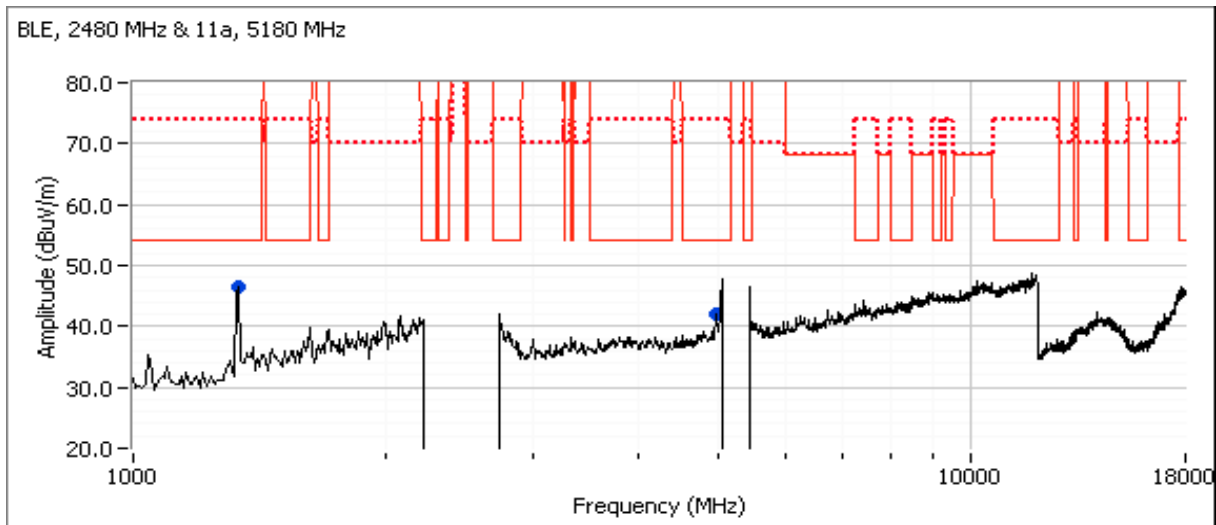



EMC Test Data

Client: Google Inc.	Job Number: JD104891
Model: Model H0A	T-Log Number: T104956
	Project Manager: Deepa Shetty
Contact: Dominik Mente	Project Coordinator: -
Standard: FCC 15.247 / 15.407 / RSS-247	Class: B

Conducted Emissions

(NTS Silicon Valley, Fremont Facility, Semi-Anechoic Chamber)

Test Specific Details

Objective: The objective of this test session is to perform final qualification testing of the EUT with respect to the specification listed above.

Date of Test: 7/21/2017	Config. Used: 1
Test Engineer: Rafael Varelas	Config Change: none
Test Location: FT Chamber #4	EUT Voltage: 120V/60Hz

General Test Configuration

For tabletop equipment, the EUT was located on a wooden table inside the semi-anechoic chamber, 40 cm from a vertical coupling plane and 80cm from the LISN.

Ambient Conditions:	Temperature: 23.4 °C
	Rel. Humidity: 41 %

Summary of Results

Run #	Test Performed	Limit	Result	Margin
1	CE, AC Power, 120V/60Hz	15.207	Pass	27.7 dB μ V @ 0.823 MHz (-18.3 dB)

Modifications Made During Testing

No modifications were made to the EUT during testing

Deviations From The Standard

No deviations were made from the requirements of the standard.

Channel: 5180 MHz	Mode: a
Antenna 2	Data Rate: 6MB/s
Channel: 2480 MHz	Mode: BLE
Antenna 2	Data Rate: 1MB/s

Client: Google Inc.	Job Number: JD104891
Model: Model H0A	T-Log Number: T104956
Contact: Dominik Mente	Project Manager: Deepa Shetty
Standard: FCC 15.247 / 15.407 / RSS-247	Project Coordinator: -
	Class: B

Run #1: AC Power Port Conducted Emissions, 0.15 - 30MHz, 120V/60Hz

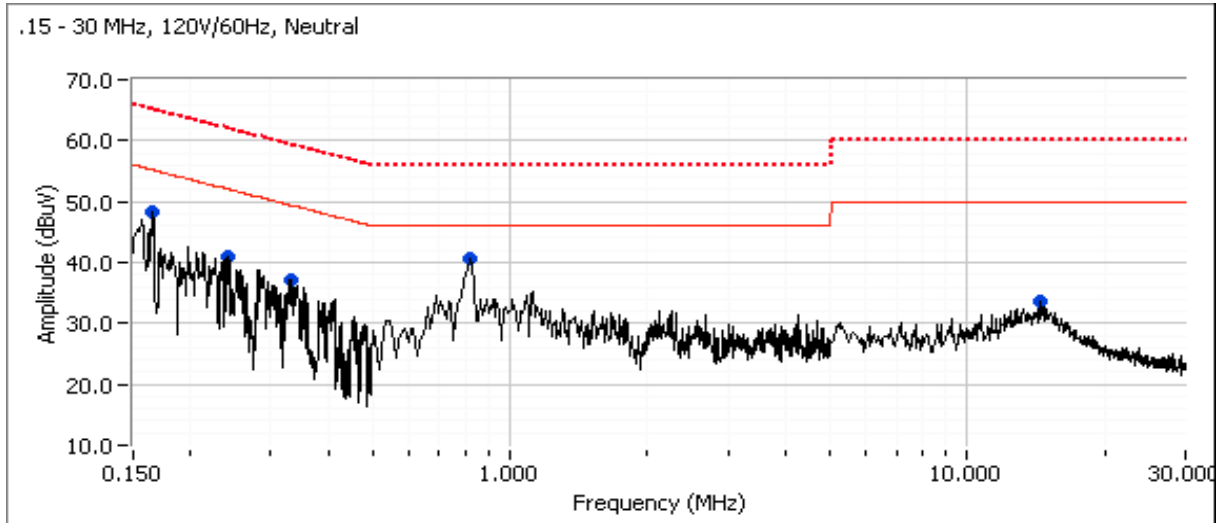
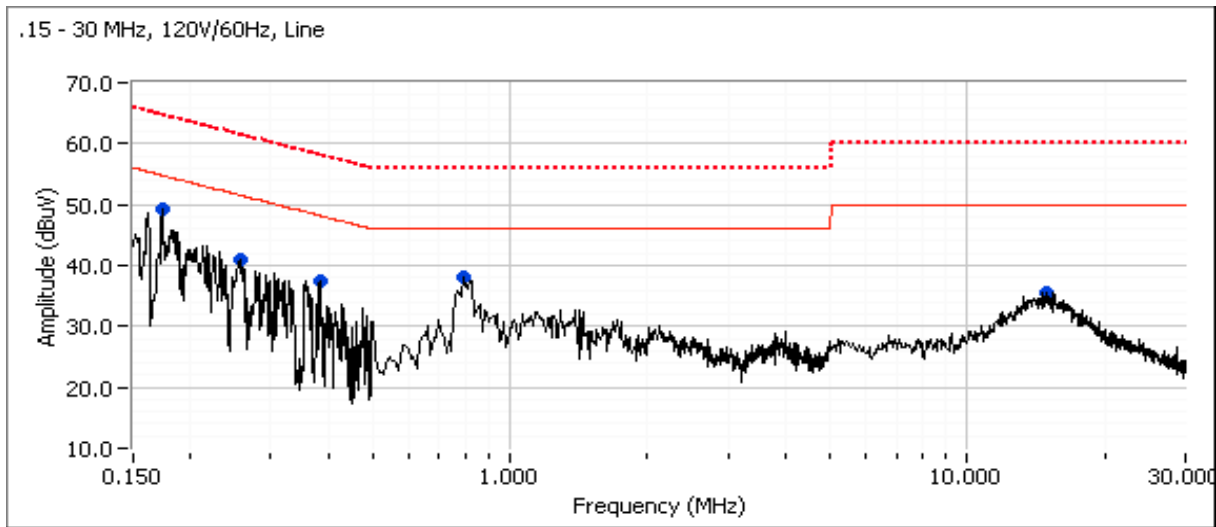



EMC Test Data

Client: Google Inc.	Job Number: JD104891
Model: Model H0A	T-Log Number: T104956
	Project Manager: Deepa Shetty
Contact: Dominik Mentel	Project Coordinator: -
Standard: FCC 15.247 / 15.407 / RSS-247	Class: B

Preliminary peak readings captured during pre-scan (peak readings vs. average limit)

Frequency MHz	Level dB μ V	AC Line	15.207		Detector QP/Ave	Comments
			Limit	Margin		
0.172	49.2	Line 1	54.8	-5.6	Peak	
0.257	40.9	Line 1	51.5	-10.6	Peak	
0.383	37.4	Line 1	48.2	-10.8	Peak	
0.800	38.2	Line 1	46.0	-7.8	Peak	
14.888	35.6	Line 1	50.0	-14.4	Peak	
0.165	48.3	Neutral	55.2	-6.9	Peak	
0.240	41.0	Neutral	52.1	-11.1	Peak	
0.330	37.1	Neutral	49.4	-12.3	Peak	
0.823	40.6	Neutral	46.0	-5.4	Peak	
14.437	33.5	Neutral	50.0	-16.5	Peak	

Final quasi-peak and average readings

Frequency MHz	Level dB μ V	AC Line	15.207		Detector QP/Ave	Comments
			Limit	Margin		
0.823	27.7	Neutral	46.0	-18.3	AVG	AVG (0.10s)
0.823	37.3	Neutral	56.0	-18.7	QP	QP (1.00s)
0.800	24.6	Line 1	46.0	-21.4	AVG	AVG (0.10s)
0.800	34.2	Line 1	56.0	-21.8	QP	QP (1.00s)
0.172	42.0	Line 1	64.9	-22.9	QP	QP (1.00s)
0.165	41.5	Neutral	65.2	-23.7	QP	QP (1.00s)
0.257	36.5	Line 1	61.5	-25.0	QP	QP (1.00s)
0.330	34.3	Neutral	59.5	-25.2	QP	QP (1.00s)
14.888	23.5	Line 1	50.0	-26.5	AVG	AVG (0.10s)
0.383	31.3	Line 1	58.2	-26.9	QP	QP (1.00s)
14.437	22.7	Neutral	50.0	-27.3	AVG	AVG (0.10s)
0.240	34.2	Neutral	62.1	-27.9	QP	QP (1.00s)
14.888	30.9	Line 1	60.0	-29.1	QP	QP (1.00s)
0.330	18.7	Neutral	49.5	-30.8	AVG	AVG (0.10s)
0.257	20.6	Line 1	51.5	-30.9	AVG	AVG (0.10s)
0.383	16.9	Line 1	48.2	-31.3	AVG	AVG (0.10s)
14.437	27.9	Neutral	60.0	-32.1	QP	QP (1.00s)
0.172	22.4	Line 1	54.9	-32.5	AVG	AVG (0.10s)
0.240	18.5	Neutral	52.1	-33.6	AVG	AVG (0.10s)
0.165	20.1	Neutral	55.2	-35.1	AVG	AVG (0.10s)



EMC Test Data

Client: Google Inc.	Job Number: JD104891
Model: Model H0A	T-Log Number: T104956
	Project Manager: Deepa Shetty
Contact: Dominik Mente	Project Coordinator: -
Standard: FCC 15.247 / 15.407 / RSS-247	Class: N/A

FCC Part 15 Frequency Stability

Test Specific Details

Objective: The objective of this test session is to perform final qualification testing of the EUT with respect to the specification listed above.

General Test Configuration

All measurements are made with the EUT's rf port connected to the measurement instrument via an attenuator. All amplitude measurements are adjusted to account for the attenuation between EUT and measuring instrument. For frequency stability measurements the EUT was placed inside an environmental chamber.

Ambient Conditions:
 Temperature: 24 °C
 Rel. Humidity: 38 %

Run #	Test Performed	Limit	Pass / Fail
1	Frequency Stability	Stays in band	Pass

Modifications Made During Testing

No modifications were made to the EUT during testing

Deviations From The Standard

No deviations were made from the requirements of the standard.



EMC Test Data

Client: Google Inc.	Job Number: JD104891
Model: Model H0A	T-Log Number: T104956
	Project Manager: Deepa Shetty
Contact: Dominik Mente	Project Coordinator: -
Standard: FCC 15.247 / 15.407 / RSS-247	Class: N/A

Run #1: Frequency Stability

Date of Test: 7/20/2017
 Test Engineer: Mehran Birgani
 Test Location: Lab#4

Config. Used: 1
 Config Change: none
 EUT Voltage: 120V/60Hz

Nominal Frequency: 5180 MHz

Frequency Stability Over Temperature

The EUT was soaked at each temperature for a minimum of 30 minutes prior to starting the transmitter and making the measurements to ensure the EUT and chamber had stabilized at that temperature.

Temperature (Celsius)	Frequency Measured (MHz)	Drift	
		(Hz)	(ppm)
0	5179.8540	-146000	-28.2
10	5179.8420	-158000	-30.5
20	5179.8370	-163000	-31.5
30	5179.8230	-177000	-34.2
40	5179.8190	-181000	-34.9
50	5179.8240	-176000	-34.0
Worst case:		-181000	-34.9

Frequency Stability Over Input Voltage

Nominal Voltage is 120Vac.

Voltage (DC)	Frequency Measured (MHz)	Drift	
		(Hz)	(ppm)
102.00	5179.837000	-163000	-31.5
138.00	5179.833000	-167000	-32.2
Worst case:		-167000	-32.2

End of Report

This page is intentionally blank and marks the last page of this test report.