



# FCC RADIO TEST REPORT

FCC ID : A4RG9BQD  
Equipment : Phone  
Model Name : G9BQD  
Applicant : Google LLC  
1600 Amphitheatre Parkway,  
Mountain View, California, 94043 USA  
Standard : FCC Part 15 Subpart C §15.247

The product was received on Feb. 06, 2023 and testing was performed from Feb. 20, 2023 to May 16, 2023. We, Sporton International Inc. Wensan Laboratory, would like to declare that the tested sample has been evaluated in accordance with the test procedures and has been in compliance with the applicable technical standards.

The test results in this report apply exclusively to the tested model / sample. Without written approval from Sporton International Inc. Wensan Laboratory, the test report shall not be reproduced except in full.

Approved by: Louis Wu

**Sporton International Inc. Wensan Laboratory**

No.58, Aly. 75, Ln. 564, Wenhua 3rd, Rd., Guishan Dist., Taoyuan City 333010, Taiwan (R.O.C.)



## Table of Contents

|   |           |
|---|-----------|
| History of this test report.....                                | 3         |
| Summary of Test Result.....                                     | 4         |
| <b>1 General Description.....</b>                               | <b>5</b>  |
| 1.1 Product Feature of Equipment Under Test.....                | 5         |
| 1.2 Product Specification of Equipment Under Test.....          | 6         |
| 1.3 Modification of EUT .....                                   | 8         |
| 1.4 Testing Location .....                                      | 8         |
| 1.5 Applicable Standards.....                                   | 8         |
| <b>2 Test Configuration of Equipment Under Test.....</b>        | <b>9</b>  |
| 2.1 Carrier Frequency Channel .....                             | 9         |
| 2.2 Test Mode.....  | 10        |
| 2.3 Connection Diagram of Test System.....                      | 12        |
| 2.4 Support Unit used in test configuration and system .....    | 13        |
| 2.5 EUT Operation Test Setup .....                              | 13        |
| 2.6 Measurement Results Explanation Example.....                | 13        |
| <b>3 Test Result.....</b>                                       | <b>14</b> |
| 3.1 Number of Channel Measurement .....                         | 14        |
| 3.2 Hopping Channel Separation Measurement .....                | 15        |
| 3.3 Dwell Time Measurement.....                                 | 16        |
| 3.4 20dB and 99% Bandwidth Measurement .....                    | 17        |
| 3.5 Output Power Measurement.....                               | 18        |
| 3.6 Conducted Band Edges Measurement.....                       | 19        |
| 3.7 Conducted Spurious Emission Measurement .....               | 20        |
| 3.8 Radiated Band Edges and Spurious Emission Measurement ..... | 21        |
| 3.9 AC Conducted Emission Measurement.....                      | 25        |
| 3.10 Antenna Requirements.....                                  | 27        |
| <b>4 List of Measuring Equipment .....</b>                      | <b>28</b> |
| <b>5 Measurement Uncertainty .....</b>                          | <b>29</b> |
| <b>Appendix A. Conducted Test Results</b>                       |           |
| <b>Appendix B. AC Conducted Emission Test Result</b>            |           |
| <b>Appendix C. Radiated Spurious Emission</b>                   |           |
| <b>Appendix D. Radiated Spurious Emission Plots</b>             |           |
| <b>Appendix E. Duty Cycle Plots</b>                             |           |
| <b>Appendix F. Setup Photographs</b>                            |           |



### History of this test report

| Report No.   | Version | Description  | Issue Date    |
|--------------|---------|--|---------------|
| FR2D0208-07A | 01      | Initial issue of report  | Jun. 19, 2023 |
| FR2D0208-07A | 02      | Revise Section 1.2 and summary remark<br>This report is an updated version, replacing the report issued on Jun. 19, 2023.                                | Jun. 28, 2023 |
| FR2D0208-07A | 03      | Revise Appendix C<br>This report is an updated version, replacing the report issued on Jun. 28, 2023.  | Jul. 07, 2023 |
| FR2D0208-07A | 04      | Revise Appendix A1-1, Appendix A1-2, Appendix A1-3 and Appendix A1-4<br>This report is an updated version, replacing the report issued on Jul. 07, 2023. | Jul. 18, 2023 |
|              |         |  |               |
|              |         |  |               |
|              |         |  |               |
|              |         |  |               |
|              |         |  |               |
|              |         |  |               |
|              |         |  |               |
|              |         |  |               |
|              |         |  |               |
|              |         |  |               |
|              |         |  |               |
|              |         |  |               |
|              |         |  |               |
|              |         |  |               |
|              |         |  |               |
|              |         |  |               |



### Summary of Test Result

| Report Clause | Ref Std. Clause              | Test Items   | Result (PASS/FAIL) | Remark                                  |
|---------------|------------------------------|--|--------------------|---|
| 3.1           | 15.247(a)(1)                 | Number of Channels                                 | Pass               | -                                       |
| 3.2           | 15.247(a)(1)                 | Hopping Channel Separation                         | Pass               | -                                       |
| 3.3           | 15.247(a)(1)                 | Dwell Time of Each Channel                         | Pass               | -                                       |
| 3.4           | 15.247(a)(1)                 | 20dB Bandwidth                                     | Pass               | -                                       |
| 3.4           | 2.1049                       | 99% Occupied Bandwidth                             | Reporting only     | -                                       |
| 3.5           | 15.247(b)(1)<br>15.247(b)(4) | Peak Output Power                                  | Pass               | -                                       |
| 3.6           | 15.247(d)                    | Conducted Band Edges                               | Pass               | -                                       |
| 3.7           | 15.247(d)                    | Conducted Spurious Emission                        | Pass               | -                                       |
| 3.8           | 15.247(d)                    | Radiated Band Edges and Radiated Spurious Emission | Pass               | 18.09 dB under the limit at 2485.56 MHz |
| 3.9           | 15.207                       | AC Conducted Emission                              | Pass               | 14.38 dB under the limit at 1.39 MHz    |
| 3.10          | 15.203                       | Antenna Requirement                                | Pass               | -                                       |

**Conformity Assessment Condition:**

- The test results (PASS/FAIL) with all measurement uncertainty excluded are presented against the regulation limits or in accordance with the requirements stipulated by the applicant/manufacturer who shall bear all the risks of non-compliance that may potentially occur if measurement uncertainty is taken into account.
- The measurement uncertainty please refer to each test result in the section "Measurement Uncertainty".

**Disclaimer:**

The product specifications of the EUT presented in the test report that may affect the test assessments are declared by the manufacturer who shall take full responsibility for the authenticity.

**Reviewed by: William Chen**  
**Report Producer: Cindy Fang**



# 1 General Description

## 1.1 Product Feature of Equipment Under Test

| Product Feature                 |  |
|---------------------------------|--|
| Equipment                       | Phone  |
| Model Name                      | G9BQD  |
| FCC ID                          | A4RG9BQD   |
| EUT supports Radios application | GSM/EGPRS/WCDMA/HSPA/LTE/5G NR/NFC/GNSS/WPT<br>WLAN 11b/g/n HT20<br>WLAN 11a/n HT20/HT40<br>WLAN 11ac VHT20/VHT40/VHT80/VHT160<br>WLAN 11ax HE20/HE40/HE80/HE160<br>WLAN 11be EHT20/EHT40/EHT80/EHT160<br>Bluetooth BR/EDR/LE/HR |

**Remark:** The EUT's information above is declared by manufacturer. Please refer to Disclaimer in report summary.

| EUT Information List |                            |
|----------------------|----------------------------|
| S/N                  | Performed Test Item        |
| 31051FDJH0006A       | RF Conducted Measurement   |
| 33241FDJH0004A       | Radiated Spurious Emission |



### 1.2 Product Specification of Equipment Under Test

| Product Specification is subject to this standard |  |
|---|--|
| <b>Tx/Rx Frequency Range</b>                      | 2402 MHz ~ 2480 MHz  |
| <b>Number of Channels</b>                         | 79   |
| <b>Carrier Frequency of Each Channel</b>          | 2402+n*1 MHz; n=0~78   |
| <b>Maximum Output Power to Antenna</b>            | <p><b>&lt;BR+EDR&gt;</b></p> <p><b>&lt;Ant. 3&gt;</b><br/> Bluetooth BR (1Mbps): 20.26 dBm / 0.1062 W<br/> Bluetooth EDR (2Mbps): 20.88dBm / 0.1225 W<br/> Bluetooth EDR (3Mbps): 20.89 dBm / 0.1227 W</p> <p><b>&lt;Ant. 4&gt;</b><br/> Bluetooth BR (1Mbps): 20.37 dBm / 0.1089 W<br/> Bluetooth EDR (2Mbps): 20.69 dBm / 0.1172 W<br/> Bluetooth EDR (3Mbps): 20.85 dBm / 0.1216 W</p> <p><b>&lt;HR&gt;</b></p> <p><b>&lt;Ant. 3&gt;</b><br/> Bluetooth HR(2Mbps): 20.60 dBm / 0.1148 W</p> <p><b>&lt;Ant. 4&gt;</b><br/> Bluetooth HR(2Mbps): 20.85 dBm / 0.1216 W</p> <p><b>&lt;TX BF Modes&gt;&lt;BR+EDR&gt;</b></p> <p><b>&lt;Ant. 3+4&gt;</b><br/> Bluetooth BR(1Mbps): 20.11 dBm / 0.1026 W<br/> Bluetooth EDR (2Mbps): 20.03 dBm / 0.1007 W<br/> Bluetooth EDR (3Mbps): 20.60 dBm / 0.1148 W</p> <p><b>&lt;TX BF Modes&gt;&lt;HR&gt;</b></p> <p><b>&lt;Ant. 3+4&gt;</b><br/> Bluetooth HR(2Mbps): 20.26 dBm (0.1062 W)</p> |



| Product Specification is subject to this standard |  |        |  |        |        |           |   |   |                |   |   |              |   |   |                   |   |   |
|---|--|--------|--|--------|--------|-----------|---|---|----------------|---|---|--------------|---|---|-------------------|---|---|
| 99% Occupied Bandwidth                            | <p><b>&lt;BR+EDR&gt;</b><br/> <b>&lt;Ant. 3&gt;</b><br/>           Bluetooth BR (1Mbps): 0.949MHz<br/>           Bluetooth EDR (2Mbps): 1.191 MHz<br/>           Bluetooth EDR (3Mbps): 1.167 MHz<br/> <b>&lt;Ant. 4&gt;</b><br/>           Bluetooth BR (1Mbps): 0.953 MHz<br/>           Bluetooth EDR (2Mbps): 1.191 MHz<br/>           Bluetooth EDR (3Mbps): 1.167 MHz<br/> <b>&lt;HR&gt;</b><br/> <b>&lt;Ant. 3&gt;</b><br/>           Bluetooth HR(2Mbps): 1.199 MHz<br/> <b>&lt;Ant. 4&gt;</b><br/>           Bluetooth HR(2Mbps): 1.197 MHz<br/> <b>&lt;TX BF Modes&gt;&lt;BR+EDR&gt;</b><br/> <b>&lt;Ant. 3&gt;</b><br/>           Bluetooth BR(1Mbps): 0.951 MHz<br/>           Bluetooth EDR (2Mbps): 1.191 MHz<br/>           Bluetooth EDR (3Mbps): 1.167 MHz<br/> <b>&lt;TX BF Modes&gt;&lt;BR+EDR&gt;</b><br/> <b>&lt;Ant. 4&gt;</b><br/>           Bluetooth BR(1Mbps): 0.949 MHz<br/>           Bluetooth EDR (2Mbps): 1.191 MHz<br/>           Bluetooth EDR (3Mbps): 1.167 MHz<br/> <b>&lt;TX BF Modes&gt;&lt;HR&gt;</b><br/> <b>&lt;Ant. 3&gt;</b><br/>           Bluetooth HR(2Mbps): 1.199 MHz<br/> <b>&lt;Ant. 4&gt;</b><br/>           Bluetooth HR(2Mbps): 1.199 MHz</p> |        |  |        |        |           |   |   |                |   |   |              |   |   |                   |   |   |
| Antenna Type / Gain                               | <p><b>&lt;Ant. 3&gt;</b>: Loop Antenna with gain -2.20 dBi<br/> <b>&lt;Ant. 4&gt;</b>: Monopole Antenna with gain -0.60 dBi</p>  |        |  |        |        |           |   |   |                |   |   |              |   |   |                   |   |   |
| Type of Modulation                                | <p>Bluetooth BR (1Mbps) : GFSK<br/>           Bluetooth EDR (2Mbps) : <math>\pi/4</math>-DQPSK<br/>           Bluetooth EDR (3Mbps) : 8-DPSK<br/>           Bluetooth HR (2Mbps) : 8PSK</p>  |        |  |        |        |           |   |   |                |   |   |              |   |   |                   |   |   |
| Antenna Function Description                      | <table border="1"> <thead> <tr> <th></th> <th>Ant. 3</th> <th>Ant. 4</th> </tr> </thead> <tbody> <tr> <td>Bluetooth</td> <td>V</td> <td>V</td> </tr> <tr> <td>Bluetooth TXBF</td> <td>V</td> <td>V</td> </tr> <tr> <td>Bluetooth HR</td> <td>V</td> <td>V</td> </tr> <tr> <td>Bluetooth HR TXBF</td> <td>V</td> <td>V</td> </tr> </tbody> </table>   |        |  | Ant. 3 | Ant. 4 | Bluetooth | V | V | Bluetooth TXBF | V | V | Bluetooth HR | V | V | Bluetooth HR TXBF | V | V |
|   | Ant. 3   | Ant. 4 |  |        |        |           |   |   |                |   |   |              |   |   |                   |   |   |
| Bluetooth   | V  | V      |  |        |        |           |   |   |                |   |   |              |   |   |                   |   |   |
| Bluetooth TXBF                                    | V  | V      |  |        |        |           |   |   |                |   |   |              |   |   |                   |   |   |
| Bluetooth HR                                      | V  | V      |  |        |        |           |   |   |                |   |   |              |   |   |                   |   |   |
| Bluetooth HR TXBF                                 | V  | V      |  |        |        |           |   |   |                |   |   |              |   |   |                   |   |   |

**Remark:** The EUT's information above is declared by manufacturer. Please refer to Disclaimer in report summary.



### 1.3 Modification of EUT

No modifications made to the EUT during the testing.

### 1.4 Testing Location

|                           |   |
|---------------------------|---|
| <b>Test Site</b>          | Sporton International Inc. EMC & Wireless Communications Laboratory   |
| <b>Test Site Location</b> | No.52, Huaya 1st Rd., Guishan Dist.,<br>Taoyuan City 333, Taiwan (R.O.C.)<br>TEL: +886-3-327-3456<br>FAX: +886-3-328-4978 |
| <b>Test Site No.</b>      | <b>Sporton Site No.</b><br>CO05-HY (TAF Code: 1190)   |
| <b>Remark</b>             | The AC Conducted Emission test item subcontracted to Sporton International Inc. EMC & Wireless Communications Laboratory  |

**Note:** The test site complies with ANSI C63.4 2014 requirement.

|                           |  |
|---------------------------|--|
| <b>Test Site</b>          | Sporton International Inc. Wensan Laboratory   |
| <b>Test Site Location</b> | No.58, Aly. 75, Ln. 564, Wenhua 3rd, Rd., Guishan Dist.,<br>Taoyuan City 333010, Taiwan (R.O.C.)<br>TEL: +886-3-327-0868<br>FAX: +886-3-327-0855 |
| <b>Test Site No.</b>      | <b>Sporton Site No.</b><br>TH05-HY, 03CH16-HY  |

**Note:** The test site complies with ANSI C63.4 2014 requirement.

FCC designation No.: TW1190 and TW3786

### 1.5 Applicable Standards

According to the specifications declared by the manufacturer, the EUT must comply with the requirements of the following standards:

- ♦ FCC Part 15 Subpart C §15.247
- ♦ FCC KDB Publication No. 558074 D01 15.247 Meas Guidance v05r02
- ♦ FCC KDB 414788 D01 Radiated Test Site v01r01
- ♦ FCC KDB 662911 D01 Multiple Transmitter Output v02r01.
- ♦ ANSI C63.10-2013

**Remark:**

1. All the test items were validated and recorded in accordance with the standards without any modification during the testing.
2. The TAF code is not including all the FCC KDB listed without accreditation.





## 2 Test Configuration of Equipment Under Test

### 2.1 Carrier Frequency Channel

| Frequency Band  | Channel | Freq. (MHz) | Channel | Freq. (MHz) | Channel | Freq. (MHz) |
|-----------------|---------|-------------|---------|-------------|---------|-------------|
| 2400-2483.5 MHz | 0       | 2402        | 27      | 2429        | 54      | 2456        |
|                 | 1       | 2403        | 28      | 2430        | 55      | 2457        |
|                 | 2       | 2404        | 29      | 2431        | 56      | 2458        |
|                 | 3       | 2405        | 30      | 2432        | 57      | 2459        |
|                 | 4       | 2406        | 31      | 2433        | 58      | 2460        |
|                 | 5       | 2407        | 32      | 2434        | 59      | 2461        |
|                 | 6       | 2408        | 33      | 2435        | 60      | 2462        |
|                 | 7       | 2409        | 34      | 2436        | 61      | 2463        |
|                 | 8       | 2410        | 35      | 2437        | 62      | 2464        |
|                 | 9       | 2411        | 36      | 2438        | 63      | 2465        |
|                 | 10      | 2412        | 37      | 2439        | 64      | 2466        |
|                 | 11      | 2413        | 38      | 2440        | 65      | 2467        |
|                 | 12      | 2414        | 39      | 2441        | 66      | 2468        |
|                 | 13      | 2415        | 40      | 2442        | 67      | 2469        |
|                 | 14      | 2416        | 41      | 2443        | 68      | 2470        |
|                 | 15      | 2417        | 42      | 2444        | 69      | 2471        |
|                 | 16      | 2418        | 43      | 2445        | 70      | 2472        |
|                 | 17      | 2419        | 44      | 2446        | 71      | 2473        |
|                 | 18      | 2420        | 45      | 2447        | 72      | 2474        |
|                 | 19      | 2421        | 46      | 2448        | 73      | 2475        |
|                 | 20      | 2422        | 47      | 2449        | 74      | 2476        |
|                 | 21      | 2423        | 48      | 2450        | 75      | 2477        |
|                 | 22      | 2424        | 49      | 2451        | 76      | 2478        |
|                 | 23      | 2425        | 50      | 2452        | 77      | 2479        |
|                 | 24      | 2426        | 51      | 2453        | 78      | 2480        |
|                 | 25      | 2427        | 52      | 2454        | -       | -           |
|                 | 26      | 2428        | 53      | 2455        | -       | -           |



## **2.2 Test Mode**

- a. The EUT has been associated with peripherals and configuration operated in a manner tended to maximize its emission characteristics in a typical application. Frequency range investigated: conduction emission (150 kHz to 30 MHz), radiation emission (9 kHz to the 10th harmonic of the highest fundamental frequency or to 40 GHz, whichever is lower). For radiated measurement, the measured emission level of the EUT was maximized by rotating the EUT on a turntable, adjusting the orientation of the EUT and EUT antenna in three orthogonal axis (X: flat, Y: portrait, Z: landscape), and accessory (Adapter or Earphone) and adjusting the measurement antenna orientation, following C63.10 exploratory test procedures and only the worst plane, and the worst mode of radiated spurious emissions is Bluetooth BR/EDR 3Mbps \ HR 2Mbps mode, and recorded in this report.
  
- b. AC power line Conducted Emission was tested under maximum output power.



The following summary table is showing all test modes to demonstrate in compliance with the standard.

| Summary table of Test Cases   |   |   |                                   |
|---|---|---|-----------------------------------|
| Test Item   | Data Rate / Modulation  |   |                                   |
| <b>Conducted Test Cases</b>   | <b>Bluetooth BR 1Mbps GFSK</b>  | <b>Bluetooth EDR 2Mbps <math>\pi/4</math>-DQPSK</b> | <b>Bluetooth EDR 3Mbps 8-DPSK</b> |
|   | Mode 1: CH00_2402 MHz   | Mode 4: CH00_2402 MHz                               | Mode 7: CH00_2402 MHz             |
|   | Mode 2: CH39_2441 MHz   | Mode 5: CH39_2441 MHz                               | Mode 8: CH39_2441 MHz             |
|   | Mode 3: CH78_2480 MHz   | Mode 6: CH78_2480 MHz                               | Mode 9: CH78_2480 MHz             |
|   | <b>Bluetooth HR 2Mbps 8PSK</b>  |   |                                   |
|   | Mode 1: CH00_2402 MHz<br>Mode 2: CH39_2441 MHz<br>Mode 3: CH78_2480 MHz                             |   |                                   |
| <b>Radiated Test Cases</b>  | <b>Bluetooth EDR 3Mbps 8-DPSK / HR 2Mbps 8PSK</b>   |   |                                   |
|   | Mode 1: CH00_2402 MHz<br>Mode 2: CH39_2441 MHz<br>Mode 3: CH78_2480 MHz                             |   |                                   |
| <b>AC Conducted Emission</b>  | Mode 1 : GSM 850 Idle + WLAN (2.4G) Link + Bluetooth Link + USB-C Cable 1 (Charging from Adapter 2) |   |                                   |
| <b>Remark:</b>  |   |   |                                   |
| <ol style="list-style-type: none"> <li>For Radiated Test Cases, the worst mode data rate BR/EDR 3Mbps \ HR 2Mbps was reported only since the highest RF output power in the preliminary tests. The conducted spurious emissions and conducted band edge measurement for other data rates were not worse than BR/EDR 3Mbps \ HR 2Mbps, and no other significantly frequencies found in conducted spurious emission.</li> <li>For Radiated Test Cases, the tests were performed with Adapter 2 and USB Cable 2.</li> <li>During the preliminary test, both charging modes (Adapter mode and WPT mode) were verified. It is determined that the adaptor mode is the worst case for official test.</li> </ol> |   |   |                                   |

## 2.3 Connection Diagram of Test System

<AC Conducted Emission Mode>

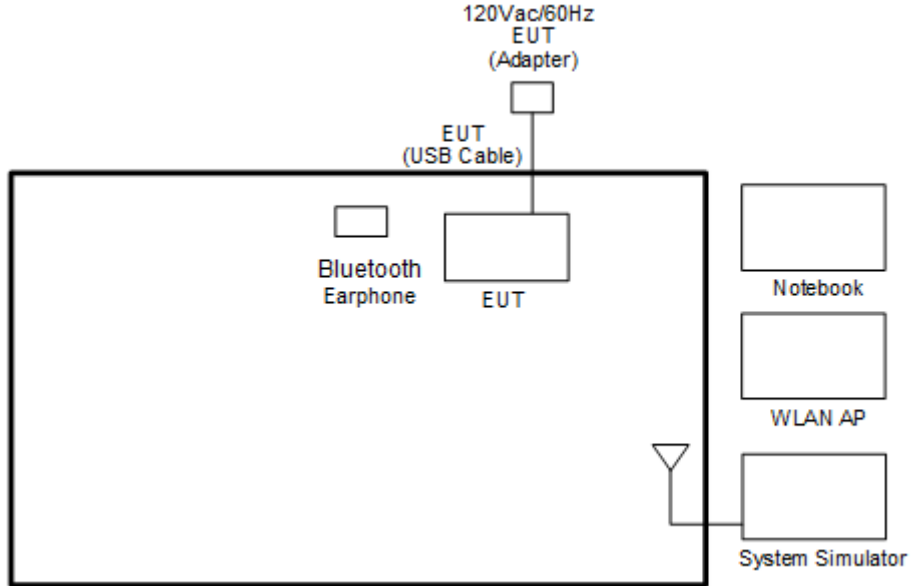

<Bluetooth Tx Mode>

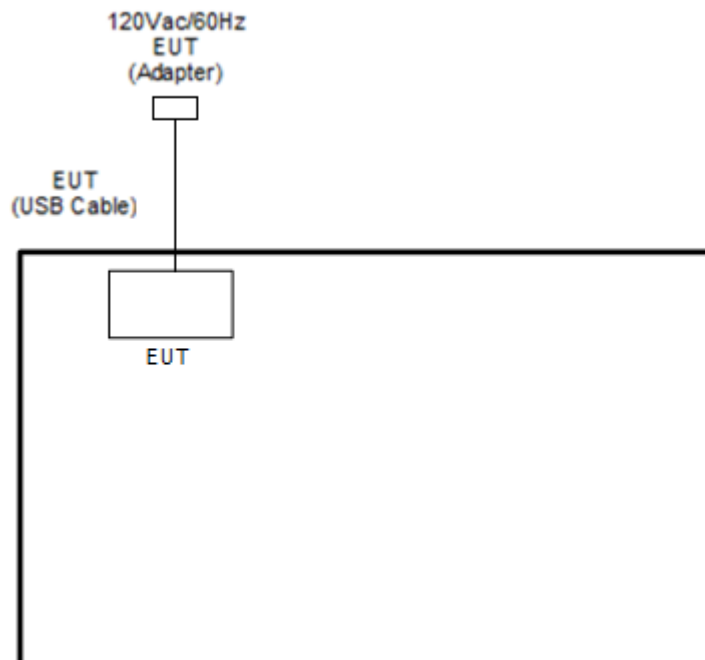



## 2.4 Support Unit used in test configuration and system

| Item | Equipment          | Brand Name | Model Name   | FCC ID                | Data Cable | Power Cord   |
|------|--------------------|------------|--------------|-----------------------|------------|--|
| 1.   | System Simulator   | Anritsu    | MT8820C      | N/A                   | N/A        | Unshielded, 1.8 m  |
| 2.   | WLAN AP            | ASUS       | RT-AC66U     | MSQ-RTAC66U           | N/A        | Unshielded, 1.8 m  |
| 3.   | Notebook           | DELL       | Latitude3420 | FCC DoC               | N/A        | AC I/P:<br>Unshielded, 1.2 m<br>DC O/P:<br>Shielded, 1.8 m |
| 4.   | Wireless Earphone  | Google     | G1007/G1008  | A4RG1007/<br>A4RG1008 | N/A        | N/A  |
| 5.   | Bluetooth Earphone | Sony       | SBH20        | PY7-RD0010            | N/A        | N/A  |

## 2.5 EUT Operation Test Setup

The RF test items, utility "cmd 10.0.19042.1526" was installed in Notebook which was programmed in order to make the EUT get into the engineering modes to provide channel selection, power level, data rate and the application type and for continuous transmitting signals.

## 2.6 Measurement Results Explanation Example

**For all conducted test items:**

The offset level is set in the spectrum analyzer to compensate the RF cable loss and attenuator factor between EUT conducted output port and spectrum analyzer. With the offset compensation, the spectrum analyzer reading level is exactly the EUT RF output level.

Example:

The spectrum analyzer offset is derived from RF cable loss and attenuator factor.

*Offset = RF cable loss + attenuator factor.*

Following shows an offset computation example with cable loss 4.2 dB and 10 dB attenuator.

$$\begin{aligned} \text{Offset(dB)} &= \text{RF cable loss(dB)} + \text{attenuator factor(dB)}. \\ &= 4.2 + 10 = 14.2 \text{ (dB)} \end{aligned}$$

### 3 Test Result

#### 3.1 Number of Channel Measurement

##### 3.1.1 Limits of Number of Hopping Frequency

Frequency hopping systems in the 2400-2483.5 MHz band shall use at least 15 channels.

##### 3.1.2 Measuring Instruments

Please refer to the measuring equipment list in this test report.

##### 3.1.3 Test Procedure

1. The testing follows ANSI C63.10-2013 clause 7.8.3.
2. The RF output of EUT is connected to the spectrum analyzer by RF cable and attenuator. The path loss is compensated to the results for each measurement.
3. Set the maximum power setting and enable the EUT to transmit continuously.
4. Enable the EUT hopping function.
5. Use the following spectrum analyzer settings: Span = the frequency band of operation; RBW = 300 kHz; VBW  $\geq$  RBW; Sweep = auto; Detector function = peak; Trace = max hold.
6. The number of hopping frequency used is defined as the number of total channel.
7. Record the measurement data derived from spectrum analyzer.

##### 3.1.4 Test Setup

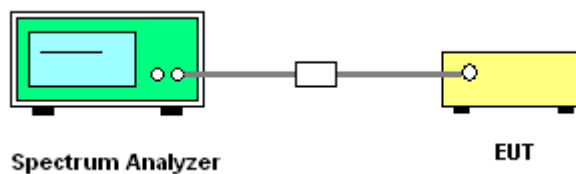

##### 3.1.5 Test Result of Number of Hopping Frequency

Please refer to Appendix A.

## 3.2 Hopping Channel Separation Measurement

### 3.2.1 Limit of Hopping Channel Separation

Frequency hopping systems operating in the 2400-2483.5 MHz band may have hopping channel carrier frequencies that are separated by 25 kHz or two-thirds of the 20 dB bandwidth of the hopping channel, whichever is greater.

### 3.2.2 Measuring Instruments

Please refer to the measuring equipment list in this test report.

### 3.2.3 Test Procedures

1. The testing follows ANSI C63.10-2013 clause 7.8.2.
2. The RF output of EUT is connected to the spectrum analyzer by RF cable and attenuator. The path loss is compensated to the results for each measurement.
3. Set the maximum power setting and enable the EUT to transmit continuously.
4. Enable the EUT hopping function.
5. Use the following spectrum analyzer settings:  
Span = wide enough to capture the peaks of two adjacent channels;  
RBW = 300 kHz; VBW  $\geq$  RBW; Sweep = auto; Detector function = peak; Trace = max hold.
6. Measure and record the results in the test report.

### 3.2.4 Test Setup

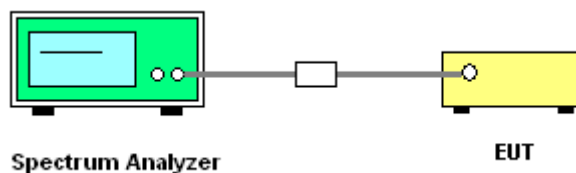

### 3.2.5 Test Result of Hopping Channel Separation

Please refer to Appendix A.

### 3.3 Dwell Time Measurement

#### 3.3.1 Limit of Dwell Time

The average time of occupancy on any channel shall not be greater than 0.4 seconds within a period of 0.4 seconds multiplied by the number of hopping channels employed.

#### 3.3.2 Measuring Instruments

Please refer to the measuring equipment list in this test report.

#### 3.3.3 Test Procedures

1. The testing follows ANSI C63.10-2013 clause 7.8.4.
2. The RF output of EUT is connected to the spectrum analyzer by RF cable and attenuator. The path loss is compensated to the results for each measurement.
3. Set the maximum power setting and enable the EUT to transmit continuously.
4. Enable the EUT hopping function.
5. Use the following spectrum analyzer settings: Span = zero span, centered on a hopping channel; RBW = 1 MHz; VBW  $\geq$  RBW; Sweep = as necessary to capture the entire dwell time per hopping channel; Detector function = peak; Trace = max hold.
6. Measure and record the results in the test report.

#### 3.3.4 Test Setup

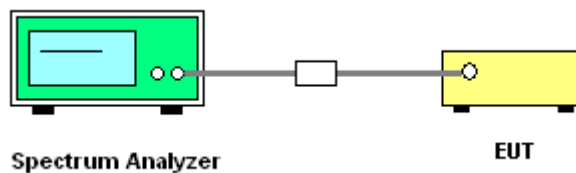

#### 3.3.5 Test Result of Dwell Time

Please refer to Appendix A.



### 3.4 20dB and 99% Bandwidth Measurement

#### 3.4.1 Limit of 20dB and 99% Bandwidth

Reporting only

#### 3.4.2 Measuring Instruments

Please refer to the measuring equipment list in this test report.

#### 3.4.3 Test Procedures

1. The testing follows ANSI C63.10-2013 clause 6.9.2 and 6.9.3.
2. The RF output of EUT is connected to the spectrum analyzer by RF cable and attenuator. The path loss is compensated to the results for each measurement.
3. Set the maximum power setting and enable the EUT to transmit continuously.
4. Use the following spectrum analyzer settings for 20 dB Bandwidth measurement.  
Span = approximately 2 to 5 times the 20 dB bandwidth, centered on a hopping channel;  
RBW  $\geq$  1% of the 20 dB bandwidth; VBW  $\geq$  RBW; Sweep = auto; Detector function = peak;  
Trace = max hold.
5. Use the following spectrum analyzer settings for 99 % Bandwidth measurement.  
Span = approximately 1.5 to 5 times the 99% bandwidth, centered on a hopping channel;  
RBW  $\geq$  1-5% of the 99% bandwidth; VBW  $\geq$  3 \* RBW; Sweep = auto; Detector function = peak;  
Trace = max hold.
6. Measure and record the results in the test report.

#### 3.4.4 Test Setup

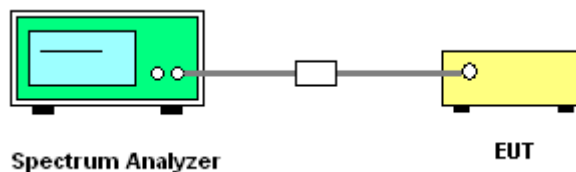

#### 3.4.5 Test Result of 20dB Bandwidth

Please refer to Appendix A.

#### 3.4.6 Test Result of 99% Occupied Bandwidth

Please refer to Appendix A.

## 3.5 Output Power Measurement

### 3.5.1 Limit of Output Power

The maximum peak conducted output power of the intentional radiator shall not exceed the following: For frequency hopping systems operating in the 2400-2483.5 MHz band employing at least 75 non-overlapping hopping channels, and all frequency hopping systems in the 5725-5850 MHz band: 1 watt. For all other frequency hopping systems in the 2400-2483.5 MHz band 0.125 watts. If directional gain of transmitting antennas is greater than 6 dBi, the power shall be reduced by the same level in dB comparing to gain minus 6 dBi.

### 3.5.2 Measuring Instruments

Please refer to the measuring equipment list in this test report.

### 3.5.3 Test Procedures

1. The testing follows ANSI C63.10-2013 clause 7.8.5.
2. The RF output of EUT is connected to the power meter by RF cable and attenuator. The path loss is compensated to the results for each measurement.
3. Set the maximum power setting and enable the EUT to transmit continuously.
4. Measure the conducted output power with cable loss and record the results in the test report.
5. Measure and record the results in the test report.

### 3.5.4 Test Setup

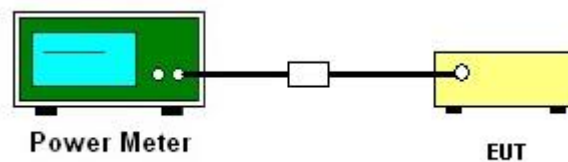

### 3.5.5 Test Result of Peak Output Power

Please refer to Appendix A.

### 3.5.6 Test Result of Average Output Power (Reporting Only)

Please refer to Appendix A.

## 3.6 Conducted Band Edges Measurement

### 3.6.1 Limit of Band Edges

In any 100 kHz bandwidth outside the intentional radiation frequency band, the radio frequency power shall be at least 20 dB below the highest level of the radiated power. In addition, radiated emissions which fall in the restricted bands must also comply with the radiated emission limits.

### 3.6.2 Measuring Instruments

Please refer to the measuring equipment list in this test report.

### 3.6.3 Test Procedures

1. The testing follows ANSI C63.10-2013 clause 7.8.6.
2. Set the maximum power setting and enable the EUT to transmit continuously.
3. Set RBW = 100 kHz, VBW = 300 kHz. Band edge emissions must be at least 20 dB down from the highest emission level within the authorized band as measured with a 100 kHz RBW. The attenuation shall be 30 dB instead of 20 dB when RMS conducted output power procedure is used.
4. Enable hopping function of the EUT and then repeat step 2 and 3.
5. Measure and record the results in the test report.

### 3.6.4 Test Setup



### 3.6.5 Test Result of Conducted Band Edges

Please refer to Appendix A.

### 3.6.6 Test Result of Conducted Hopping Mode Band Edges

Please refer to Appendix A.

## 3.7 Conducted Spurious Emission Measurement

### 3.7.1 Limit of Spurious Emission Measurement

In any 100 kHz bandwidth outside the intentional radiation frequency band, the radio frequency power shall be at least 20 dB below the highest level of the radiated power. In addition, radiated emissions which fall in the restricted bands must also comply with the radiated emission limits.

### 3.7.2 Measuring Instruments

Please refer to the measuring equipment list in this test report.

### 3.7.3 Test Procedure

1. The testing follows ANSI C63.10-2013 clause 7.8.8.
2. The RF output of EUT is connected to the spectrum analyzer by RF cable and attenuator. The path loss is compensated to the results for each measurement.
3. Set the maximum power setting and enable the EUT to transmit continuously.
4. Set RBW = 100 kHz, VBW = 300 kHz, scan up through 10th harmonic. All harmonics / spurious must be at least 20 dB down from the highest emission level within the authorized band as measured with a 100 kHz RBW.
5. Measure and record the results in the test report.
6. The RF fundamental frequency should be excluded against the limit line in the operating frequency band.

### 3.7.4 Test Setup



### 3.7.5 Test Result of Conducted Spurious Emission

Please refer to Appendix A.



### 3.8 Radiated Band Edges and Spurious Emission Measurement

#### 3.8.1 Limit of Radiated Band Edges and Spurious Emission

In any 100 kHz bandwidth outside the intentional radiator frequency band, all harmonics / spurious must be at least 20 dB below the highest emission level within the authorized band. In addition, radiated emissions which fall in the restricted bands must also comply with the limits as below.

| Frequency (MHz) | Field Strength (microvolts/meter) | Measurement Distance (meters) |
|-----------------|-----------------------------------|-------------------------------|
| 0.009 – 0.490   | 2400/F(kHz)                       | 300                           |
| 0.490 – 1.705   | 24000/F(kHz)                      | 30                            |
| 1.705 – 30.0    | 30                                | 30                            |
| 30 – 88         | 100                               | 3                             |
| 88 – 216        | 150                               | 3                             |
| 216 - 960       | 200                               | 3                             |
| Above 960       | 500                               | 3                             |

#### 3.8.2 Measuring Instruments

Please refer to the measuring equipment list in this test report.



### 3.8.3 Test Procedures

1. The EUT is placed on a turntable with 0.8 meter for frequency below 1 GHz and 1.5 meter for frequency above 1 GHz respectively above ground.
2. The EUT is set 3 meters away from the receiving antenna, which is mounted on the top of a variable height antenna tower.
3. For each suspected emission, the EUT is arranged to its worst case and then tune the Antenna tower (from 1 m to 4 m) and turntable (from 0 degree to 360 degrees) to find the maximum reading. A pre-amp and a high pass filter are used for the test in order to get better signal level to comply with the guidelines.
4. Set the maximum power setting and enable the EUT to transmit continuously.
5. Use the following spectrum analyzer settings:
  - (1) Span shall wide enough to fully capture the emission being measured;
  - (2) Set RBW = 100 kHz for  $f < 1$  GHz, RBW = 1 MHz for  $f > 1$  GHz ; VBW  $\geq$  RBW; Sweep = auto; Detector function = peak; Trace = max hold for peak
  - (3) For average measurement: use duty cycle correction factor method per 15.35(c).  
Duty cycle = On time/100 milliseconds  
On time =  $N_1 * L_1 + N_2 * L_2 + \dots + N_{n-1} * L_{n-1} + N_n * L_n$   
Where  $N_1$  is number of type 1 pulses,  $L_1$  is length of type 1 pulses, etc.  
Average Emission Level = Peak Emission Level +  $20 * \log$  (Duty cycle)
6. Corrected Reading: Antenna Factor + Cable Loss + Read Level - Preamp Factor = Level
7. Radiated testing below 1 GHz is performed by adjusting the antenna tower from 1 m to 4 m and by rotating the turn table from 0 degree to 360 degrees to find the peak maximum hold reading. When there is no suspected emission found and the emission level is with at least 6 dB margin against QP limit line, the position is marked as “-“.
8. Radiated testing above 1 GHz is performed by adjusting the antenna tower from 1 m to 4 m and by rotating the turn table from 0 degree to 360 degrees to find the peak maximum hold reading for scanning all frequencies. When there is no suspected emission found and the harmonic emission level is with at least 6 dB margin against average limit line, the position is marked as “-“.

Note: The average levels are calculated from the peak level corrected with duty cycle correction factor (BR +EDR -24.76dB, TXBF HR 2Mbps and HR 2Mbps -24.67dB, TXBF BR+EDR -24.79dB) derived from  $20 \log$  (dwell time/100ms). This correction is only for signals that hop with the fundamental signal, such as band-edge and harmonic. Other spurious signals that are independent of the hopping signal would not use this correction.

### 3.8.4 Test Setup

For radiated test below 30MHz

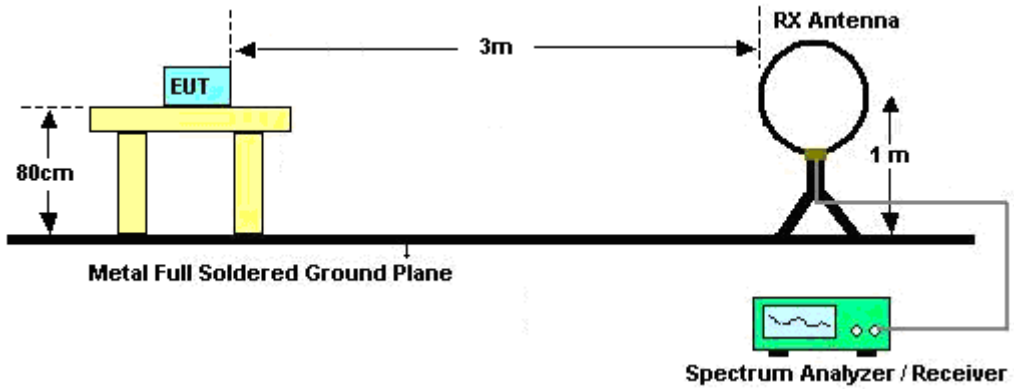

For radiated test from 30MHz to 1GHz

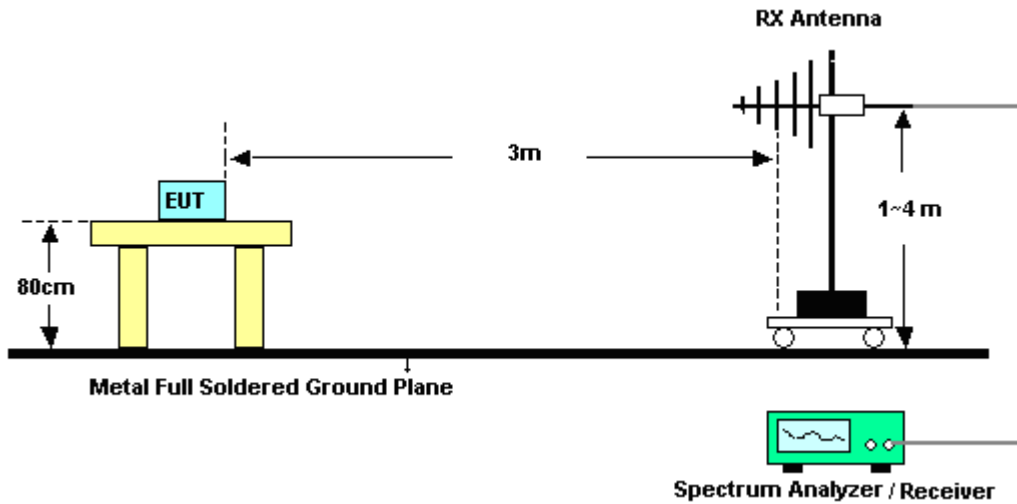

For radiated test from 1GHz to 18GHz

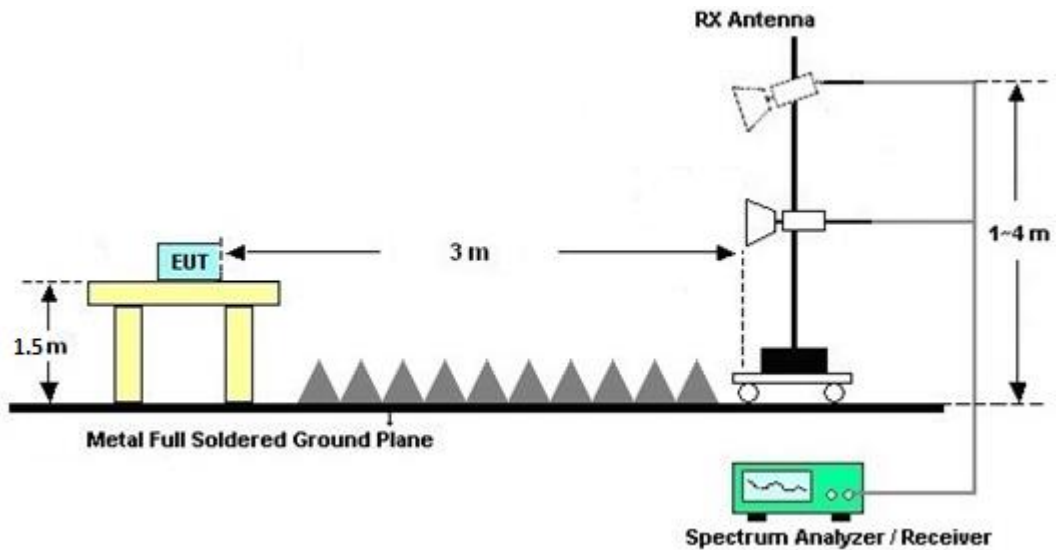

For radiated test above 18GHz

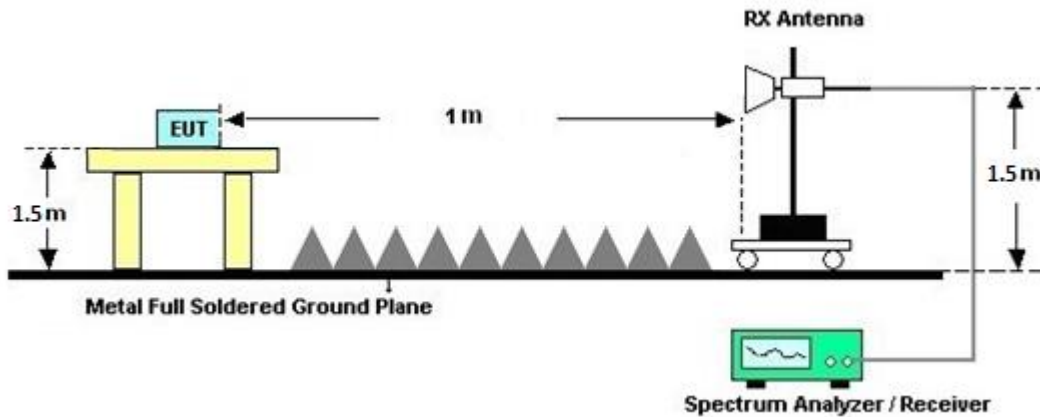

### 3.8.5 Test Results of Radiated Spurious Emissions (9 kHz ~ 30 MHz)

The low frequency, which starts from 9 kHz to 30 MHz, is pre-scanned and the result which is 20 dB lower than the limit line is not reported.

There is adequate comparison measurement of both open-field test site and alternative test site - semi-Anechoic chamber according to 414788 D01 Radiated Test Site v01r01, and the result comes out very similar.

### 3.8.6 Test Result of Radiated Spurious at Band Edges

Please refer to Appendix C and D.

### 3.8.7 Duty Cycle

Please refer to Appendix E.

### 3.8.8 Test Result of Radiated Spurious Emission (30MHz ~ 10<sup>th</sup> Harmonic)

Please refer to Appendix C and D.





### 3.9 AC Conducted Emission Measurement

#### 3.9.1 Limit of AC Conducted Emission

For equipment that is designed to be connected to the public utility (AC) power line, the radio frequency voltage that is conducted back onto the AC power line on any frequency or frequencies within the band 150 kHz to 30 MHz shall not exceed the limits in the following table.

| Frequency of emission (MHz) | Conducted limit (dB $\mu$ V) |           |
|-----------------------------|------------------------------|-----------|
|                             | Quasi-peak                   | Average   |
| 0.15-0.5                    | 66 to 56*                    | 56 to 46* |
| 0.5-5                       | 56                           | 46        |
| 5-30                        | 60                           | 50        |

\*Decreases with the logarithm of the frequency.

#### 3.9.2 Measuring Instruments

Please refer to the measuring equipment list in this test report.

#### 3.9.3 Test Procedures

1. The EUT is placed 0.4 meter away from the conducting wall of the shielding room, and is kept at least 80 centimeters from any other grounded conducting surface.
2. Connect EUT to the power mains through a line impedance stabilization network (LISN).
3. All the support units are connecting to the other LISN.
4. The LISN provides 50 ohm coupling impedance for the measuring instrument.
5. The FCC states that a 50 ohm, 50 microhenry LISN shall be used.
6. Both Line and Neutral shall be tested in order to find out the maximum conducted emission.
7. The frequency range from 150 kHz to 30 MHz is scanned.
8. Set the test-receiver system to Peak Detect Function and specified bandwidth (IF Bandwidth = 9 kHz) with Maximum Hold Mode. Then measurement is also conducted by Average Detector and Quasi-Peak Detector Function respectively.

### 3.9.4 Test Setup

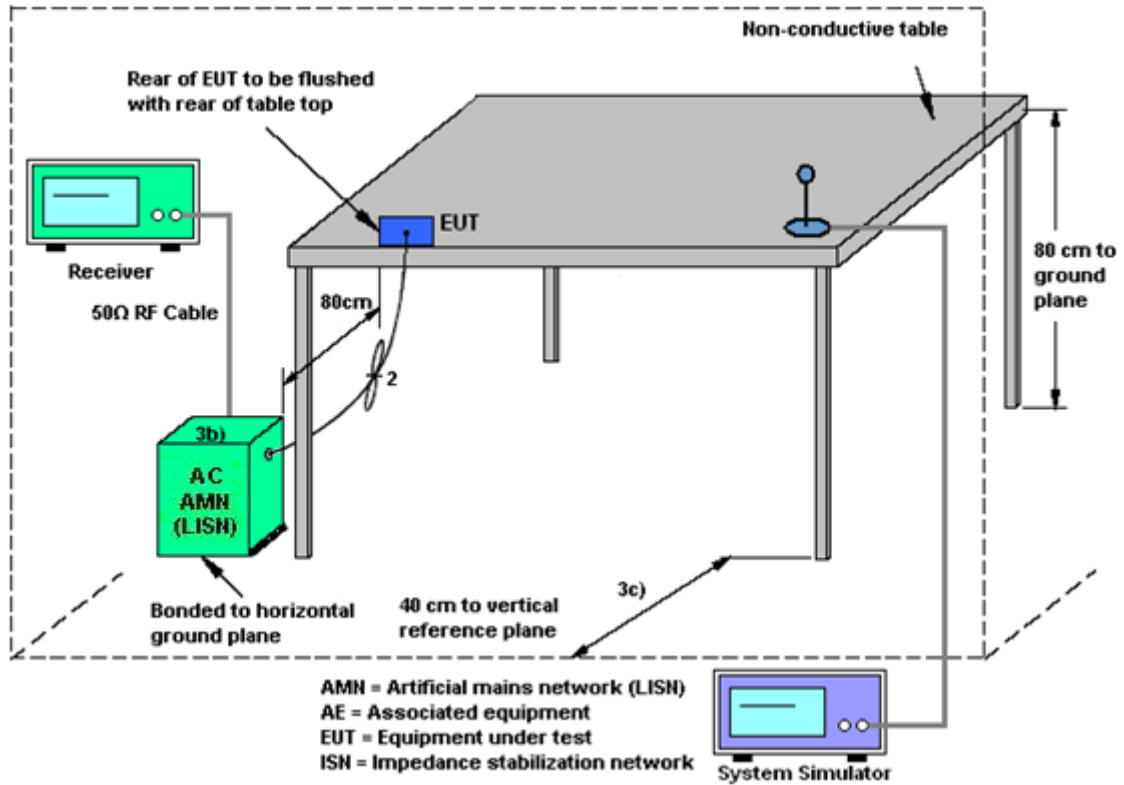

### 3.9.5 Test Result of AC Conducted Emission

Please refer to Appendix B.



## **3.10 Antenna Requirements**

### **3.10.1 Standard Applicable**

The use of a permanently attached antenna or of an antenna that uses a unique coupling to the intentional radiator shall be considered sufficient to comply with the rule.

### **3.10.2 Antenna Anti-Replacement Construction**

An embedded-in antenna design is used.



## 4 List of Measuring Equipment

| Instrument           | Brand Name      | Model No.                     | Serial No.     | Characteristics               | Calibration Date | Test Date                      | Due Date      | Remark                   |
|----------------------|-----------------|-------------------------------|----------------|-------------------------------|------------------|--------------------------------|---------------|--------------------------|
| Horn Antenna         | SCHWARZBECK     | BBHA 9120 D                   | 9120D-1522     | 1GHz~18GHz                    | Mar. 23, 2023    | Apr. 11, 2023~<br>May 05, 2023 | Mar. 22, 2024 | Radiation<br>(03CH16-HY) |
| SHF-EHF Horn Antenna | SCHWARZBECK     | BBHA9170                      | 00993          | 18GHz-40GHz                   | Nov. 24, 2022    | Apr. 11, 2023~<br>May 05, 2023 | Nov. 23, 2023 | Radiation<br>(03CH16-HY) |
| Bilog Antenna        | TESEQ           | CBL 6111D &<br>00802N1D01N-06 | 47020 & 06     | 30MHz~1GHz                    | Oct. 08, 2022    | Apr. 11, 2023~<br>May 05, 2023 | Oct. 07, 2023 | Radiation<br>(03CH16-HY) |
| Loop Antenna         | Rohde & Schwarz | HFH2-Z2                       | 100488         | 9 kHz~30 MHz                  | Sep. 20, 2022    | Apr. 11, 2023~<br>May 05, 2023 | Sep. 19, 2023 | Radiation<br>(03CH16-HY) |
| Preamplifier         | EMEC            | EM18G40G                      | 060801         | 18GHz~40GHz                   | Jun. 28, 2022    | Apr. 11, 2023~<br>May 05, 2023 | Jun. 27, 2023 | Radiation<br>(03CH16-HY) |
| Preamplifier         | EMEC            | EM1G18G                       | 060812         | 1GHz~18GHz                    | Dec. 26, 2022    | Apr. 11, 2023~<br>May 05, 2023 | Dec. 25, 2023 | Radiation<br>(03CH16-HY) |
| Preamplifier         | Keysight        | 83017A                        | MY53270264     | 1GHz~26.5GHz                  | Dec. 09, 2022    | Apr. 11, 2023~<br>May 05, 2023 | Dec. 08, 2023 | Radiation<br>(03CH16-HY) |
| Amplifier            | SONOMA          | 310N                          | 371607         | 9kHz~1GHz                     | Jul. 04, 2022    | Apr. 11, 2023~<br>May 05, 2023 | Jul. 03, 2023 | Radiation<br>(03CH16-HY) |
| EMI Test Receiver    | Keysight        | N9038A(MXE)                   | MY57290111     | 3Hz~26.5GHz                   | Dec. 15, 2022    | Apr. 11, 2023~<br>May 05, 2023 | Dec. 14, 2023 | Radiation<br>(03CH16-HY) |
| RF Cable             | HUBER + SUHNER  | SUCOFLEX 104                  | 805935/4       | N/A                           | Aug. 09, 2022    | Apr. 11, 2023~<br>May 05, 2023 | Aug. 08, 2023 | Radiation<br>(03CH16-HY) |
| RF Cable             | HUBER + SUHNER  | SUCOFLEX 104                  | 802434/4       | N/A                           | Aug. 09, 2022    | Apr. 11, 2023~<br>May 05, 2023 | Aug. 08, 2023 | Radiation<br>(03CH16-HY) |
| RF Cable             | HUBER + SUHNER  | SUCOFLEX 102                  | EC-A5-300-5757 | N/A                           | Aug. 09, 2022    | Apr. 11, 2023~<br>May 05, 2023 | Aug. 08, 2023 | Radiation<br>(03CH16-HY) |
| Software             | Audix           | E3 6.2009-8-24                | RK-001136      | N/A                           | N/A              | Apr. 11, 2023~<br>May 05, 2023 | N/A           | Radiation<br>(03CH16-HY) |
| Controller           | ChainTek        | 3000-1                        | N/A            | Control Turn table & Ant Mast | N/A              | Apr. 11, 2023~<br>May 05, 2023 | N/A           | Radiation<br>(03CH16-HY) |
| Antenna Mast         | ChainTek        | MBS-520-1                     | N/A            | 1m~4m                         | N/A              | Apr. 11, 2023~<br>May 05, 2023 | N/A           | Radiation<br>(03CH16-HY) |
| Turn Table           | ChainTek        | T-200-S-1                     | N/A            | 0~360 Degree                  | N/A              | Apr. 11, 2023~<br>May 05, 2023 | N/A           | Radiation<br>(03CH16-HY) |
| AC Power Source      | ChainTek        | APC-1000W                     | N/A            | N/A                           | N/A              | Apr. 19, 2023                  | N/A           | Conduction<br>(CO05-HY)  |
| EMI Test Receiver    | Rohde & Schwarz | ESR3                          | 102388         | 9kHz~3.6GHz                   | Dec. 01, 2022    | Apr. 19, 2023                  | Nov. 30, 2023 | Conduction<br>(CO05-HY)  |
| Hygrometer           | Testo           | 608-H1                        | 34913912       | N/A                           | Nov. 17, 2022    | Apr. 19, 2023                  | Nov. 16, 2023 | Conduction<br>(CO05-HY)  |
| LISN                 | Rohde & Schwarz | ENV216                        | 100081         | 9kHz~30MHz                    | Nov. 17, 2022    | Apr. 19, 2023                  | Nov. 16, 2023 | Conduction<br>(CO05-HY)  |
| Software             | Rohde & Schwarz | EMC32                         | N/A            | N/A                           | N/A              | Apr. 19, 2023                  | N/A           | Conduction<br>(CO05-HY)  |
| Pulse Limiter        | SCHWARZBECK     | VTSD 9561-F N                 | 00691          | N/A                           | Aug. 01, 2022    | Apr. 19, 2023                  | Jul. 31, 2023 | Conduction<br>(CO05-HY)  |
| LISN Cable           | MVE             | RG-400                        | 260260         | N/A                           | Dec. 29, 2022    | Apr. 19, 2023                  | Dec. 28, 2023 | Conduction<br>(CO05-HY)  |
| Hygrometer           | TECPEL          | DTM-303A                      | TP201996       | N/A                           | Nov. 17, 2022    | Feb. 20, 202~<br>May 16, 2023  | Nov. 16, 2023 | Conducted<br>(TH05-HY)   |
| Power Meter          | Anritsu         | ML2495A                       | 1036004        | N/A                           | Aug. 08, 2022    | Feb. 20, 2023~<br>May 16, 2023 | Aug. 07, 2023 | Conducted<br>(TH05-HY)   |
| Power Sensor         | Anritsu         | MA2411B                       | 1027253        | 300MHz~40GHz                  | Aug. 08, 2022    | Feb. 20, 2023~<br>May 16, 2023 | Aug. 07, 2023 | Conducted<br>(TH05-HY)   |
| Signal Analyzer      | Rohde & Schwarz | FSV40                         | 101905         | 10Hz - 40GHz(amp)             | Aug. 03, 2022    | Feb. 20, 2023~<br>May 16, 2023 | Aug. 02, 2023 | Conducted<br>(TH05-HY)   |



## 5 Measurement Uncertainty

### Uncertainty of Conducted Emission Measurement (150 kHz ~ 30 MHz)

|   |         |
|---|---------|
| Measuring Uncertainty for a Level of Confidence of 95% ( $U = 2Uc(y)$ ) | 3.50 dB |
|---|---------|

### Uncertainty of Radiated Emission Measurement (30 MHz ~ 1000 MHz)

|   |         |
|---|---------|
| Measuring Uncertainty for a Level of Confidence of 95% ( $U = 2Uc(y)$ ) | 6.50 dB |
|---|---------|

### Uncertainty of Radiated Emission Measurement (1000 MHz ~ 6000 MHz)

|   |         |
|---|---------|
| Measuring Uncertainty for a Level of Confidence of 95% ( $U = 2Uc(y)$ ) | 4.60 dB |
|---|---------|

### Uncertainty of Radiated Emission Measurement (6000 MHz ~ 18000 MHz)

|   |         |
|---|---------|
| Measuring Uncertainty for a Level of Confidence of 95% ( $U = 2Uc(y)$ ) | 4.50 dB |
|---|---------|

### Uncertainty of Radiated Emission Measurement (18000 MHz ~ 40000 MHz)

|   |         |
|---|---------|
| Measuring Uncertainty for a Level of Confidence of 95% ( $U = 2Uc(y)$ ) | 5.60 dB |
|---|---------|

## Appendix A. Test Result of Conducted Test Items

|                |                           |                    |       |    |
|----------------|---------------------------|--------------------|-------|----|
| Test Engineer: | Ching Chen and Junyu Jhou | Temperature:       | 21~25 | °C |
| Test Date:     | 2023/2/20-2023/5/16       | Relative Humidity: | 51~54 | %  |

&lt;BR+EDR Ant. 3&gt;

**TEST RESULTS DATA****20dB and 99% Occupied Bandwidth and Hopping Channel Separation**

| Mod. | Data Rate | NTX | CH. | Freq. (MHz) | 20db BW (MHz) | 99% Bandwidth (MHz) | Hopping Channel Separation Measurement (MHz) | Hopping Channel Separation Measurement Limit (MHz) | Pass/Fail |
|------|-----------|-----|-----|-------------|---------------|---------------------|--|--|-----------|
| DH   | 1Mbps     | 1   | 0   | 2402        | 1.043         | 0.949               | 1.016  | 0.6957   | Pass      |
| DH   | 1Mbps     | 1   | 39  | 2441        | 1.043         | 0.947               | 1.007  | 0.6957   | Pass      |
| DH   | 1Mbps     | 1   | 78  | 2480        | 1.043         | 0.949               | 0.994  | 0.6957   | Pass      |
| 2DH  | 2Mbps     | 1   | 0   | 2402        | 1.309         | 1.191               | 0.986  | 0.8725   | Pass      |
| 2DH  | 2Mbps     | 1   | 39  | 2441        | 1.304         | 1.191               | 1.007  | 0.8696   | Pass      |
| 2DH  | 2Mbps     | 1   | 78  | 2480        | 1.313         | 1.189               | 1.007  | 0.8754   | Pass      |
| 3DH  | 3Mbps     | 1   | 0   | 2402        | 1.265         | 1.167               | 1.059  | 0.8435   | Pass      |
| 3DH  | 3Mbps     | 1   | 39  | 2441        | 1.265         | 1.167               | 1.003  | 0.8435   | Pass      |
| 3DH  | 3Mbps     | 1   | 78  | 2480        | 1.265         | 1.167               | 0.999  | 0.8435   | Pass      |

**TEST RESULTS DATA****Dwell Time**

| Mod.       | Hopping Channel Number Rate | Hops Over Occupancy Time (hops) | Package Transfer Time (msec) | Dwell Time (sec) | Limits (sec) | Pass/Fail |
|------------|-----------------------------|---------------------------------|------------------------------|------------------|--------------|-----------|
| 3DH5       | 79                          | 106.670                         | 2.90                         | 0.31             | 0.4          | Pass      |
| 3DH5 (AFH) | 20                          | 53.330                          | 2.90                         | 0.15             | 0.4          | Pass      |

**TEST RESULTS DATA****Peak Power Table**

| DH   | CH. | NTX | Peak Power (dBm) | Power Limit (dBm) | Test Result |
|------|-----|-----|------------------|-------------------|-------------|
| DH1  | 0   | 1   | <b>20.26</b>     | 20.97             | Pass        |
|      | 39  | 1   | 19.93            | 20.97             | Pass        |
|      | 78  | 1   | 19.57            | 20.97             | Pass        |
| 2DH1 | 0   | 1   | <b>20.88</b>     | 20.97             | Pass        |
|      | 39  | 1   | 20.53            | 20.97             | Pass        |
|      | 78  | 1   | 20.40            | 20.97             | Pass        |
| 3DH1 | 0   | 1   | <b>20.89</b>     | 20.97             | Pass        |
|      | 39  | 1   | 20.54            | 20.97             | Pass        |
|      | 78  | 1   | 20.42            | 20.97             | Pass        |

**TEST RESULTS DATA****Average Power Table  
(Reporting Only)**

| DH   | CH. | NTX | Average Power (dBm) | Duty Factor (dB) |
|------|-----|-----|---------------------|------------------|
| DH1  | 0   | 1   | <b>19.68</b>        | 5.15             |
|      | 39  | 1   | 19.32               | 5.15             |
|      | 78  | 1   | 19.22               | 5.15             |
| 2DH1 | 0   | 1   | <b>18.52</b>        | 5.08             |
|      | 39  | 1   | 17.98               | 5.08             |
|      | 78  | 1   | 17.93               | 5.08             |
| 3DH1 | 0   | 1   | <b>17.71</b>        | 5.07             |
|      | 39  | 1   | 17.43               | 5.07             |
|      | 78  | 1   | 17.26               | 5.07             |

**TEST RESULTS DATA****Number of Hopping Frequency**

| Number of Hopping (Channel) | Adaptive Frequency Hopping (Channel) | Limits (Channel) | Pass/Fail |
|-----------------------------|--------------------------------------|------------------|-----------|
| 79                          | 20                                   | > 15             | Pass      |

<BR+EDR Ant. 4>

| <b>TEST RESULTS DATA</b>  |           |     |     |             |               |                     |  |  |           |
|---|-----------|-----|-----|-------------|---------------|---------------------|--|--|-----------|
| <b>20dB and 99% Occupied Bandwidth and Hopping Channel Separation</b> |           |     |     |             |               |                     |  |  |           |
| Mod.  | Data Rate | NTX | CH. | Freq. (MHz) | 20db BW (MHz) | 99% Bandwidth (MHz) | Hopping Channel Separation Measurement (MHz) | Hopping Channel Separation Measurement Limit (MHz) | Pass/Fail |
| DH  | 1Mbps     | 1   | 0   | 2402        | 1.043         | 0.953               | 1.012  | 0.6957   | Pass      |
| DH  | 1Mbps     | 1   | 39  | 2441        | 1.043         | 0.951               | 0.999  | 0.6957   | Pass      |
| DH  | 1Mbps     | 1   | 78  | 2480        | 1.048         | 0.949               | 1.012  | 0.6986   | Pass      |
| 2DH   | 2Mbps     | 1   | 0   | 2402        | 1.313         | 1.189               | 0.981  | 0.8754   | Pass      |
| 2DH   | 2Mbps     | 1   | 39  | 2441        | 1.222         | 1.191               | 0.994  | 0.8145   | Pass      |
| 2DH   | 2Mbps     | 1   | 78  | 2480        | 1.313         | 1.189               | 0.999  | 0.8754   | Pass      |
| 3DH   | 3Mbps     | 1   | 0   | 2402        | 1.265         | 1.165               | 1.077  | 0.8435   | Pass      |
| 3DH   | 3Mbps     | 1   | 39  | 2441        | 1.265         | 1.167               | 0.994  | 0.8435   | Pass      |
| 3DH   | 3Mbps     | 1   | 78  | 2480        | 1.265         | 1.165               | 1.016  | 0.8435   | Pass      |

| <b>TEST RESULTS DATA</b> |                             |                                 |                              |                  |              |           |
|--------------------------|-----------------------------|---------------------------------|------------------------------|------------------|--------------|-----------|
| <b>Dwell Time</b>        |                             |                                 |                              |                  |              |           |
| Mod.                     | Hopping Channel Number Rate | Hops Over Occupancy Time (hops) | Package Transfer Time (msec) | Dwell Time (sec) | Limits (sec) | Pass/Fail |
| DH5                      | 79                          | 106.670                         | 2.89                         | 0.31             | 0.4          | Pass      |
| DH5 (AFH)                | 20                          | 53.330                          | 2.89                         | 0.15             | 0.4          | Pass      |

| <b>TEST RESULTS DATA</b> |     |     |                  |                   |             |
|--------------------------|-----|-----|------------------|-------------------|-------------|
| <b>Peak Power Table</b>  |     |     |                  |                   |             |
| DH                       | CH. | NTX | Peak Power (dBm) | Power Limit (dBm) | Test Result |
| DH1                      | 0   | 1   | <b>20.37</b>     | 20.97             | Pass        |
|                          | 39  | 1   | 19.90            | 20.97             | Pass        |
|                          | 78  | 1   | 19.55            | 20.97             | Pass        |
| 2DH1                     | 0   | 1   | <b>20.69</b>     | 20.97             | Pass        |
|                          | 39  | 1   | 19.95            | 20.97             | Pass        |
|                          | 78  | 1   | 19.91            | 20.97             | Pass        |
| 3DH1                     | 0   | 1   | <b>20.85</b>     | 20.97             | Pass        |
|                          | 39  | 1   | 20.07            | 20.97             | Pass        |
|                          | 78  | 1   | 19.97            | 20.97             | Pass        |

| <b>TEST RESULTS DATA</b>   |     |     |                     |                  |
|----------------------------|-----|-----|---------------------|------------------|
| <b>Average Power Table</b> |     |     |                     |                  |
| <b>(Reporting Only)</b>    |     |     |                     |                  |
| DH                         | CH. | NTX | Average Power (dBm) | Duty Factor (dB) |
| DH1                        | 0   | 1   | <b>19.63</b>        | 5.13             |
|                            | 39  | 1   | 19.61               | 5.13             |
|                            | 78  | 1   | 19.01               | 5.13             |
| 2DH1                       | 0   | 1   | <b>18.14</b>        | 5.07             |
|                            | 39  | 1   | 17.41               | 5.07             |
|                            | 78  | 1   | 17.38               | 5.07             |
| 3DH1                       | 0   | 1   | <b>17.69</b>        | 5.09             |
|                            | 39  | 1   | 16.99               | 5.09             |
|                            | 78  | 1   | 16.95               | 5.09             |

| <b>TEST RESULTS DATA</b>           |                                      |                  |           |
|------------------------------------|--------------------------------------|------------------|-----------|
| <b>Number of Hopping Frequency</b> |                                      |                  |           |
| Number of Hopping (Channel)        | Adaptive Frequency Hopping (Channel) | Limits (Channel) | Pass/Fail |
| 79                                 | 20                                   | > 15             | Pass      |

<HR 2Mbps Ant3>

| <b>TEST RESULTS DATA</b>  |           |     |     |             |               |                     |  |  |           |
|---|-----------|-----|-----|-------------|---------------|---------------------|--|--|-----------|
| <b>20dB and 99% Occupied Bandwidth and Hopping Channel Separation</b> |           |     |     |             |               |                     |  |  |           |
| Mod.  | Data Rate | NTX | CH. | Freq. (MHz) | 20db BW (MHz) | 99% Bandwidth (MHz) | Hopping Channel Separation Measurement (MHz) | Hopping Channel Separation Measurement Limit (MHz) | Pass/Fail |
| 2DH   | 1Mbps     | 1   | 0   | 2402        | 1.317         | 1.197               | 1.090  | 0.8783   | Pass      |
| 2DH   | 1Mbps     | 1   | 39  | 2441        | 1.317         | 1.199               | 0.999  | 0.8783   | Pass      |
| 2DH   | 1Mbps     | 1   | 78  | 2480        | 1.313         | 1.199               | 1.016  | 0.8754   | Pass      |

| <b>TEST RESULTS DATA</b> |                             |                                 |                              |                  |              |           |
|--------------------------|-----------------------------|---------------------------------|------------------------------|------------------|--------------|-----------|
| <b>Dwell Time</b>        |                             |                                 |                              |                  |              |           |
| Mod.                     | Hopping Channel Number Rate | Hops Over Occupancy Time (hops) | Package Transfer Time (msec) | Dwell Time (sec) | Limits (sec) | Pass/Fail |
| DH5                      | 79                          | 106.670                         | 2.90                         | 0.31             | 0.4          | Pass      |
| DH5 (AFH)                | 20                          | 53.330                          | 2.90                         | 0.15             | 0.4          | Pass      |

| <b>TEST RESULTS DATA</b> |     |     |                  |                   |             |
|--------------------------|-----|-----|------------------|-------------------|-------------|
| <b>Peak Power Table</b>  |     |     |                  |                   |             |
| DH                       | CH. | NTX | Peak Power (dBm) | Power Limit (dBm) | Test Result |
| 2DH1                     | 0   | 1   | <b>20.60</b>     | 20.97             | Pass        |
|                          | 39  | 1   | 20.39            | 20.97             | Pass        |
|                          | 78  | 1   | 20.21            | 20.97             | Pass        |

| <b>TEST RESULTS DATA</b>   |     |     |                     |                  |
|----------------------------|-----|-----|---------------------|------------------|
| <b>Average Power Table</b> |     |     |                     |                  |
| <b>(Reporting Only)</b>    |     |     |                     |                  |
| DH                         | CH. | NTX | Average Power (dBm) | Duty Factor (dB) |
| 2DH1                       | 0   | 1   | <b>17.95</b>        | 4.74             |
|                            | 39  | 1   | 17.46               | 4.74             |
|                            | 78  | 1   | 17.32               | 4.74             |

| <b>TEST RESULTS DATA</b>           |                                      |                  |           |
|------------------------------------|--------------------------------------|------------------|-----------|
| <b>Number of Hopping Frequency</b> |                                      |                  |           |
| Number of Hopping (Channel)        | Adaptive Frequency Hopping (Channel) | Limits (Channel) | Pass/Fail |
| 79                                 | 20                                   | > 15             | Pass      |



&lt;HR 2Mbps Ant. 4&gt;

**TEST RESULTS DATA****20dB and 99% Occupied Bandwidth and Hopping Channel Separation**

| Mod. | Data Rate | NTX | CH. | Freq. (MHz) | 20db BW (MHz) | 99% Bandwidth (MHz) | Hopping Channel Separation Measurement (MHz) | Hopping Channel Separation Measurement Limit (MHz) | Pass/Fail |
|------|-----------|-----|-----|-------------|---------------|---------------------|--|--|-----------|
| 2DH  | 1Mbps     | 1   | 0   | 2402        | 1.313         | 1.197               | 1.033  | 0.8754   | Pass      |
| 2DH  | 1Mbps     | 1   | 39  | 2441        | 1.313         | 1.197               | 0.986  | 0.8754   | Pass      |
| 2DH  | 1Mbps     | 1   | 78  | 2480        | 1.313         | 1.197               | 1.003  | 0.8754   | Pass      |

**TEST RESULTS DATA****Dwell Time**

| Mod.      | Hopping Channel Number Rate | Hops Over Occupancy Time (hops) | Package Transfer Time (msec) | Dwell Time (sec) | Limits (sec) | Pass/Fail |
|-----------|-----------------------------|---------------------------------|------------------------------|------------------|--------------|-----------|
| DH5       | 79                          | 106.670                         | 2.93                         | 0.31             | 0.4          | Pass      |
| DH5 (AFH) | 20                          | 53.330                          | 2.93                         | 0.16             | 0.4          | Pass      |

**TEST RESULTS DATA****Peak Power Table**

| DH   | CH. | NTX | Peak Power (dBm) | Power Limit (dBm) | Test Result |
|------|-----|-----|------------------|-------------------|-------------|
| 2DH1 | 0   | 1   | <b>20.85</b>     | 20.97             | Pass        |
|      | 39  | 1   | 20.25            | 20.97             | Pass        |
|      | 78  | 1   | 20.23            | 20.97             | Pass        |

**TEST RESULTS DATA****Average Power Table  
(Reporting Only)**

| DH   | CH. | NTX | Average Power (dBm) | Duty Factor (dB) |
|------|-----|-----|---------------------|------------------|
| 2DH1 | 0   | 1   | <b>18.35</b>        | 4.74             |
|      | 39  | 1   | 17.40               | 4.74             |
|      | 78  | 1   | 17.39               | 4.74             |

**TEST RESULTS DATA****Number of Hopping Frequency**

| Number of Hopping (Channel) | Adaptive Frequency Hopping (Channel) | Limits (Channel) | Pass/Fail |
|-----------------------------|--------------------------------------|------------------|-----------|
| 79                          | 20                                   | > 15             | Pass      |

<TXBF BR+EDR Ant. 3+4>

| <b>TEST RESULTS DATA</b>  |           |     |     |             |               |       |                     |       |  |       |  |        |           |
|---|-----------|-----|-----|-------------|---------------|-------|---------------------|-------|--|-------|--|--------|-----------|
| <b>20dB and 99% Occupied Bandwidth and Hopping Channel Separation</b> |           |     |     |             |               |       |                     |       |  |       |  |        |           |
| Mod.  | Data Rate | NTX | CH. | Freq. (MHz) | 20db BW (MHz) |       | 99% Bandwidth (MHz) |       | Hopping Channel Separation Measurement (MHz) |       | Hopping Channel Separation Measurement Limit (MHz) |        | Pass/Fail |
|   |           |     |     |             | Ant 4         | Ant 3 | Ant 4               | Ant 3 | Ant 4  | Ant 3 | Ant 4  | Ant 3  |           |
| DH  | 1Mbps     | 2   | 0   | 2402        | 1.048         | 1.043 | 0.949               | 0.951 | 1.003  | 0.990 | 0.6986   | 0.6957 | Pass      |
| DH  | 1Mbps     | 2   | 39  | 2441        | 1.022         | 1.044 | 0.909               | 0.949 | 0.990  | 0.990 | 0.6811   | 0.6957 | Pass      |
| DH  | 1Mbps     | 2   | 78  | 2480        | 1.044         | 1.044 | 0.947               | 0.949 | 1.003  | 1.003 | 0.6957   | 0.6957 | Pass      |
| 2DH   | 2Mbps     | 2   | 0   | 2402        | 1.313         | 1.313 | 1.191               | 1.189 | 1.007  | 1.003 | 0.8753   | 0.8753 | Pass      |
| 2DH   | 2Mbps     | 2   | 39  | 2441        | 1.274         | 1.313 | 1.189               | 1.189 | 1.003  | 0.990 | 0.8493   | 0.8753 | Pass      |
| 2DH   | 2Mbps     | 2   | 78  | 2480        | 1.309         | 1.313 | 1.189               | 1.191 | 0.994  | 0.994 | 0.8725   | 0.8753 | Pass      |
| 3DH   | 3Mbps     | 2   | 0   | 2402        | 1.265         | 1.265 | 1.167               | 1.167 | 1.003  | 1.055 | 0.8435   | 0.8435 | Pass      |
| 3DH   | 3Mbps     | 2   | 39  | 2441        | 1.265         | 1.265 | 1.167               | 1.165 | 1.016  | 1.003 | 0.8435   | 0.8435 | Pass      |
| 3DH   | 3Mbps     | 2   | 78  | 2480        | 1.265         | 1.265 | 1.167               | 1.167 | 1.025  | 0.981 | 0.8435   | 0.8435 | Pass      |

| <b>TEST RESULTS DATA</b> |                             |                                |                              |                  |              |           |
|--------------------------|-----------------------------|--------------------------------|------------------------------|------------------|--------------|-----------|
| <b>Dwell Time</b>        |                             |                                |                              |                  |              |           |
| Mod.                     | Hopping Channel Number Rate | Hops Over Occupancy Time(hops) | Package Transfer Time (msec) | Dwell Time (sec) | Limits (sec) | Pass/Fail |
| Normal                   | 79                          | 106.67                         | 2.89                         | 0.31             | 0.4          | Pass      |
| AFH                      | 20                          | 53.33                          | 2.89                         | 0.15             | 0.4          | Pass      |

| <b>TEST RESULTS DATA</b> |     |     |                        |                        |                        |                   |             |
|--------------------------|-----|-----|------------------------|------------------------|------------------------|-------------------|-------------|
| <b>Peak Power Table</b>  |     |     |                        |                        |                        |                   |             |
| DH                       | CH. | NTX | Peak Power Ant 4 (dBm) | Peak Power Ant 3 (dBm) | Peak Power Total (dBm) | Power Limit (dBm) | Test Result |
| DH1                      | 0   | 2   | 17.15                  | 17.05                  | <b>20.11</b>           | 20.97             | Pass        |
|                          | 39  | 2   | 17.12                  | 16.94                  | 20.04                  | 20.97             | Pass        |
|                          | 78  | 2   | 16.41                  | 16.83                  | 19.64                  | 20.97             | Pass        |
| 2DH1                     | 0   | 2   | 16.85                  | 17.19                  | <b>20.03</b>           | 20.97             | Pass        |
|                          | 39  | 2   | 15.80                  | 16.90                  | 19.40                  | 20.97             | Pass        |
|                          | 78  | 2   | 15.60                  | 16.58                  | 19.13                  | 20.97             | Pass        |
| 3DH1                     | 0   | 2   | 17.21                  | 17.93                  | <b>20.60</b>           | 20.97             | Pass        |
|                          | 39  | 2   | 16.35                  | 17.57                  | 20.01                  | 20.97             | Pass        |
|                          | 78  | 2   | 16.10                  | 17.26                  | 19.73                  | 20.97             | Pass        |

| <b>TEST RESULTS DATA</b>                    |     |     |                           |                           |                           |                  |
|---|-----|-----|---------------------------|---------------------------|---------------------------|------------------|
| <b>Average Power Table (Reporting Only)</b> |     |     |                           |                           |                           |                  |
| DH  | CH. | NTX | Average Power Ant 4 (dBm) | Average Power Ant 3 (dBm) | Average Power Total (dBm) | Duty Factor (dB) |
| DH1   | 0   | 2   | 16.64                     | 16.50                     | <b>19.58</b>              | 5.15             |
|   | 39  | 2   | 16.70                     | 16.36                     | 19.54                     | 5.15             |
|   | 78  | 2   | 16.00                     | 16.39                     | 19.21                     | 5.15             |
| 2DH1  | 0   | 2   | 13.92                     | 14.34                     | <b>17.14</b>              | 5.05             |
|   | 39  | 2   | 13.27                     | 14.29                     | 16.82                     | 5.05             |
|   | 78  | 2   | 12.99                     | 13.91                     | 16.48                     | 5.05             |
| 3DH1  | 0   | 2   | 13.97                     | 14.56                     | <b>17.28</b>              | 5.05             |
|   | 39  | 2   | 13.34                     | 14.19                     | 16.79                     | 5.05             |
|   | 78  | 2   | 13.11                     | 14.15                     | 16.67                     | 5.05             |

| <b>TEST RESULTS DATA</b>           |                                      |                  |           |
|------------------------------------|--------------------------------------|------------------|-----------|
| <b>Number of Hopping Frequency</b> |                                      |                  |           |
| Number of Hopping (Channel)        | Adaptive Frequency Hopping (Channel) | Limits (Channel) | Pass/Fail |
| 79                                 | 20                                   | > 15             | Pass      |

<TXBF HR 2Mbps Ant. 3+4>

| <b>TEST RESULTS DATA</b>  |           |     |     |             |               |       |                     |       |  |       |  |        |           |
|---|-----------|-----|-----|-------------|---------------|-------|---------------------|-------|--|-------|--|--------|-----------|
| <b>20dB and 99% Occupied Bandwidth and Hopping Channel Separation</b> |           |     |     |             |               |       |                     |       |  |       |  |        |           |
| Mod.  | Data Rate | NTX | CH. | Freq. (MHz) | 20db BW (MHz) |       | 99% Bandwidth (MHz) |       | Hopping Channel Separation Measurement (MHz) |       | Hopping Channel Separation Measurement Limit (MHz) |        | Pass/Fail |
|   |           |     |     |             | Ant 4         | Ant 3 | Ant 4               | Ant 3 | Ant 4  | Ant 3 | Ant 4  | Ant 3  |           |
| 2DH   | 1Mbps     | 2   | 0   | 2402        | 1.317         | 1.313 | 1.199               | 1.199 | 1.012  | 1.033 | 0.8783   | 0.8753 | Pass      |
| 2DH   | 1Mbps     | 2   | 39  | 2441        | 1.361         | 1.317 | 1.197               | 1.197 | 0.994  | 1.016 | 0.9073   | 0.8783 | Pass      |
| 2DH   | 1Mbps     | 2   | 78  | 2480        | 1.317         | 1.317 | 1.197               | 1.197 | 0.977  | 1.016 | 0.8783   | 0.8783 | Pass      |

| <b>TEST RESULTS DATA</b> |                             |                                |                              |                  |              |           |
|--------------------------|-----------------------------|--------------------------------|------------------------------|------------------|--------------|-----------|
| <b>Dwell Time</b>        |                             |                                |                              |                  |              |           |
| Mod.                     | Hopping Channel Number Rate | Hops Over Occupancy Time(hops) | Package Transfer Time (msec) | Dwell Time (sec) | Limits (sec) | Pass/Fail |
| Normal                   | 79                          | 106.67                         | 2.93                         | 0.31             | 0.4          | Pass      |
| AFH                      | 20                          | 53.33                          | 2.93                         | 0.16             | 0.4          | Pass      |

| <b>TEST RESULTS DATA</b> |     |     |                        |                        |                        |                   |             |
|--------------------------|-----|-----|------------------------|------------------------|------------------------|-------------------|-------------|
| <b>Peak Power Table</b>  |     |     |                        |                        |                        |                   |             |
| DH                       | CH. | NTX | Peak Power Ant 4 (dBm) | Peak Power Ant 3 (dBm) | Peak Power Total (dBm) | Power Limit (dBm) | Test Result |
| 2DH1                     | 0   | 2   | 16.87                  | 17.60                  | <b>20.26</b>           | 20.97             | Pass        |
|                          | 39  | 2   | 16.29                  | 17.15                  | 19.75                  | 20.97             | Pass        |
|                          | 78  | 2   | 15.95                  | 16.95                  | 19.49                  | 20.97             | Pass        |

| <b>TEST RESULTS DATA</b>   |     |     |                           |                           |                           |                  |
|----------------------------|-----|-----|---------------------------|---------------------------|---------------------------|------------------|
| <b>Average Power Table</b> |     |     |                           |                           |                           |                  |
| <b>(Reporting Only)</b>    |     |     |                           |                           |                           |                  |
| DH                         | CH. | NTX | Average Power Ant 4 (dBm) | Average Power Ant 3 (dBm) | Average Power Total (dBm) | Duty Factor (dB) |
| 2DH1                       | 0   | 2   | 14.07                     | 14.67                     | <b>17.39</b>              | 5.15             |
|                            | 39  | 2   | 13.21                     | 14.29                     | 16.79                     | 5.15             |
|                            | 78  | 2   | 13.15                     | 14.11                     | 16.67                     | 5.15             |

| <b>TEST RESULTS DATA</b>           |                                      |                  |           |
|------------------------------------|--------------------------------------|------------------|-----------|
| <b>Number of Hopping Frequency</b> |                                      |                  |           |
| Number of Hopping (Channel)        | Adaptive Frequency Hopping (Channel) | Limits (Channel) | Pass/Fail |
| 79                                 | 20                                   | > 15             | Pass      |



<BR+EDR Ant. 3>

# Number of Hopping Frequency

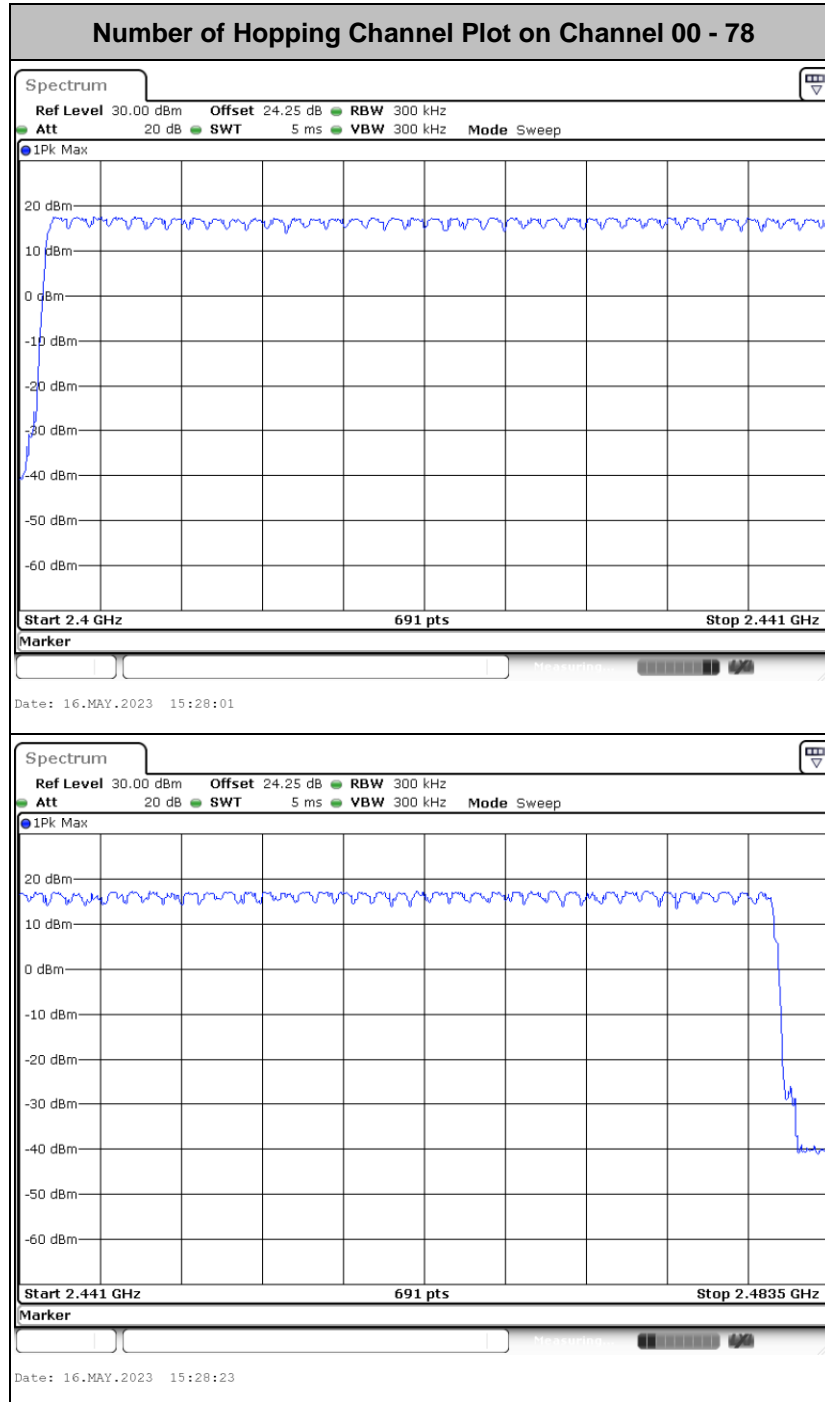



# Hopping Channel Separation

<1Mbps>

Channel Separation Plot on Channel 00 - 01

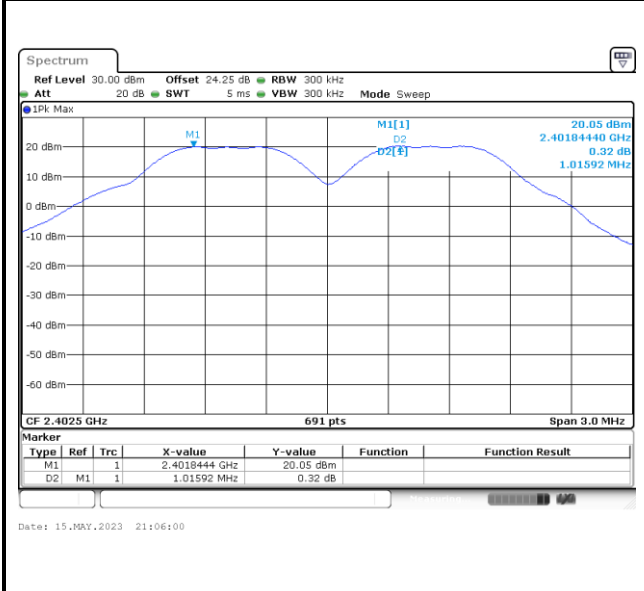

Channel Separation Plot on Channel 39 - 40

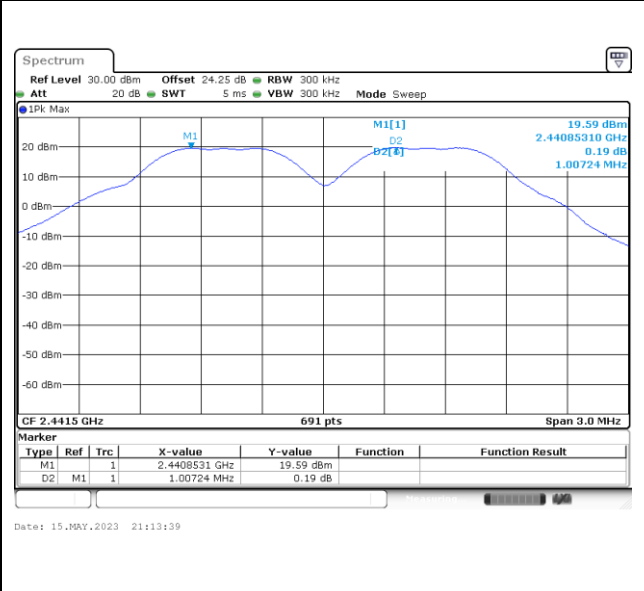

Channel Separation Plot on Channel 77 - 78

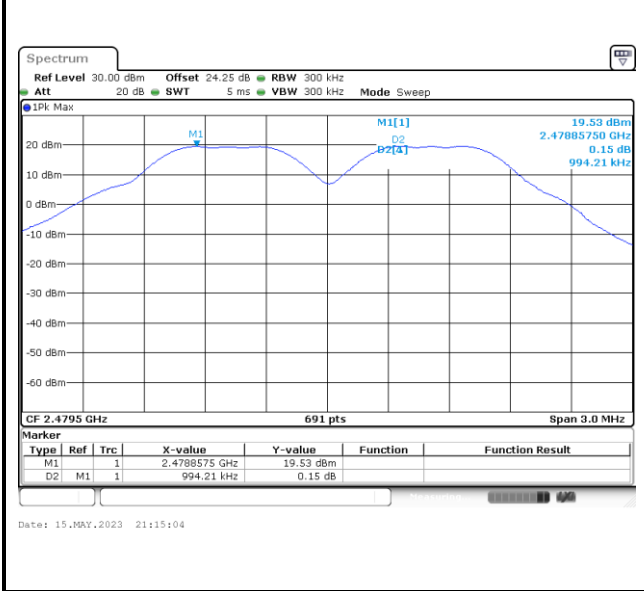



<2Mbps>

Channel Separation Plot on Channel 00 - 01

Channel Separation Plot on Channel 39 - 40

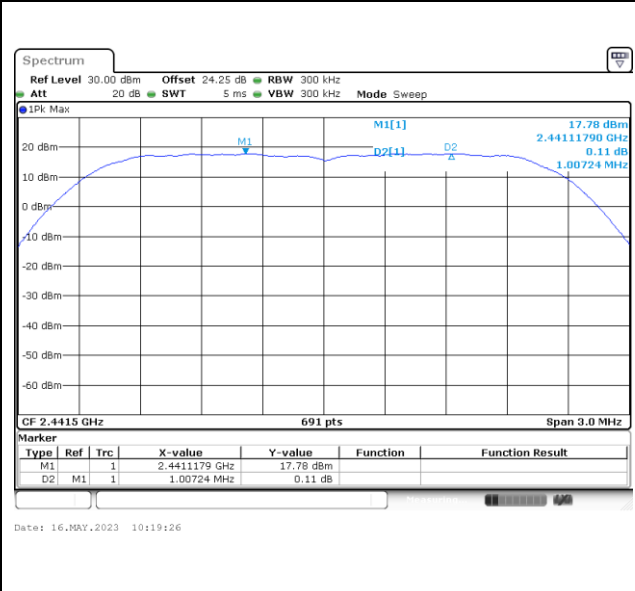
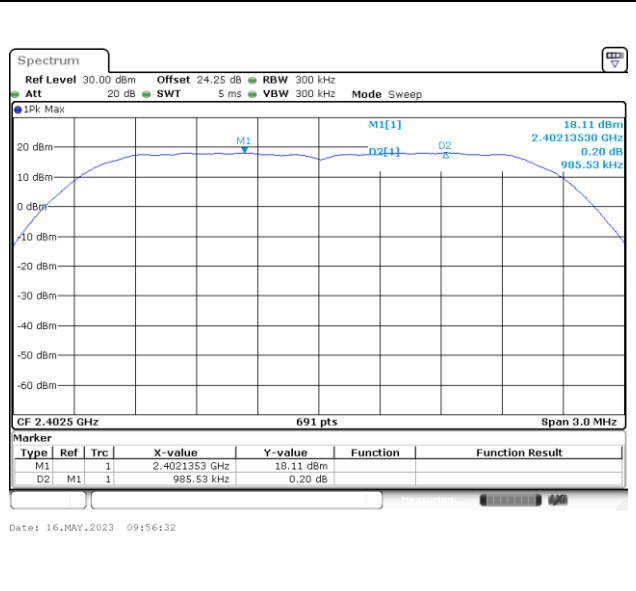

Channel Separation Plot on Channel 77 - 78

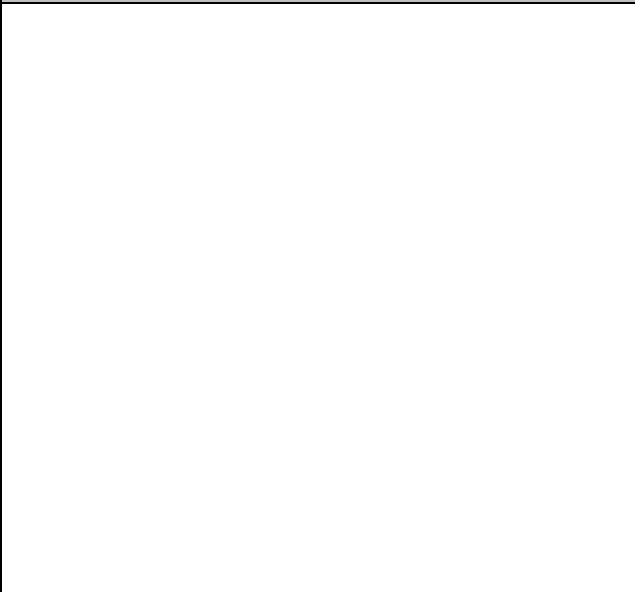
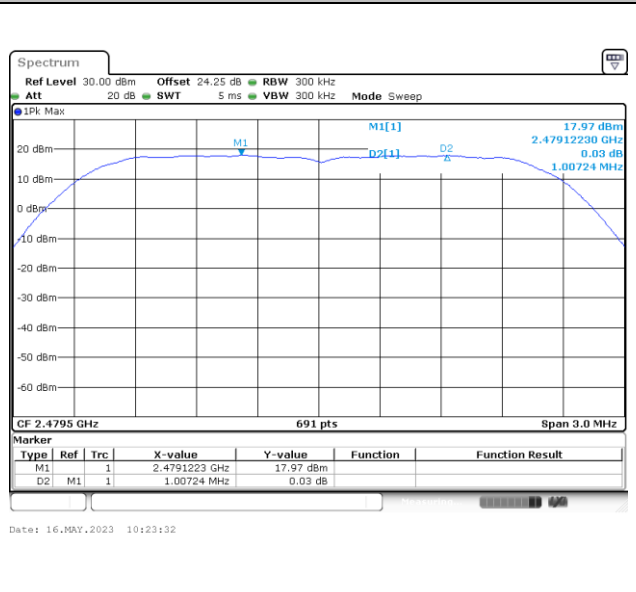



<3Mbps>

Channel Separation Plot on Channel 00 - 01

Channel Separation Plot on Channel 39 - 40

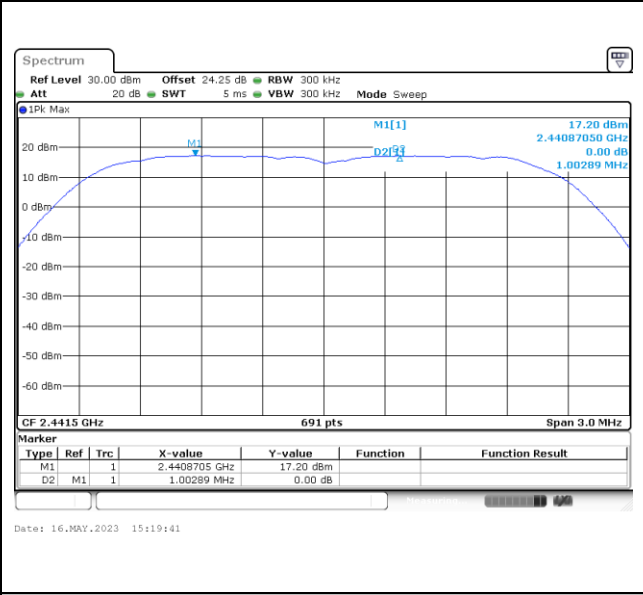
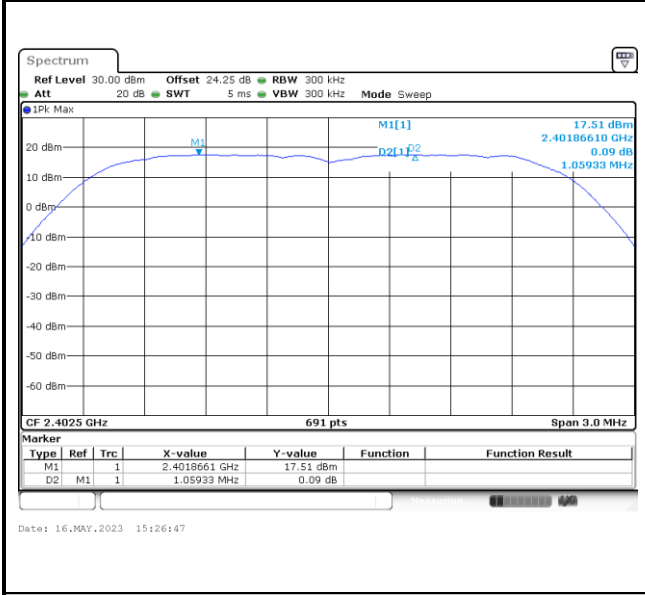

Channel Separation Plot on Channel 77 - 78

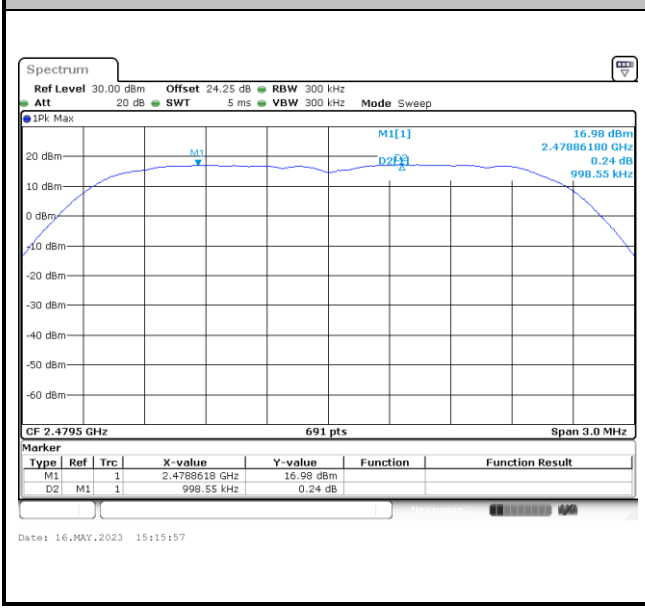



# Dwell Time

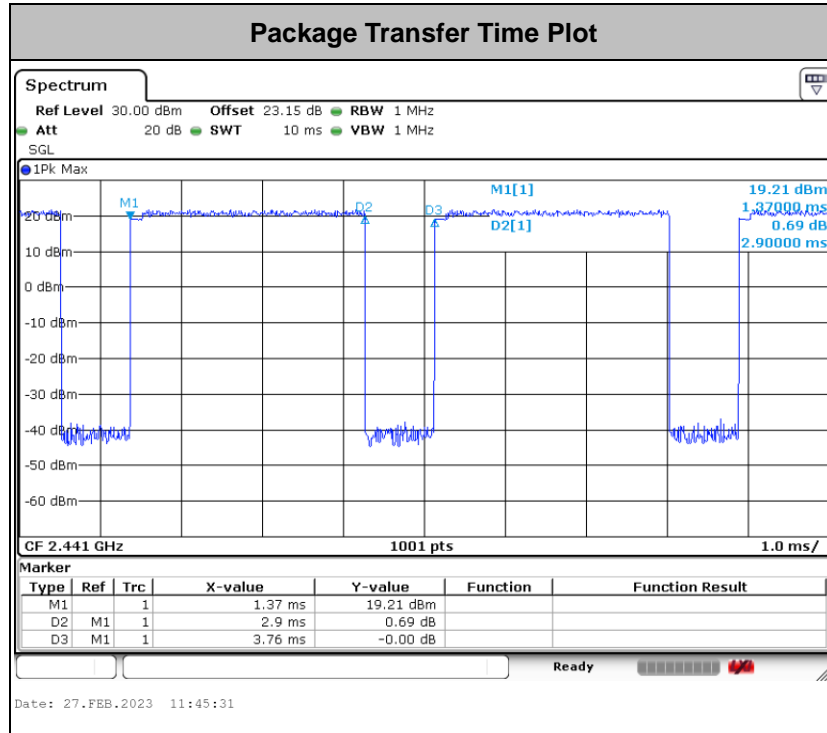

### Remark:

1. In normal mode, hopping rate is 1600 hops/s with 6 slots in 79 hopping channels. With channel hopping rate (1600 / 6 / 79) in Occupancy Time Limit (0.4 x 79) (s), Hops Over Occupancy Time comes to (1600 / 6 / 79) x (0.4 x 79) = 106.67 hops.
2. In AFH mode, hopping rate is 800 hops/s with 6 slots in 20 hopping channels. With channel hopping rate (800 / 6 / 20) in Occupancy Time Limit (0.4 x 20) (s), Hops Over Occupancy Time comes to (800 / 6 / 20) x (0.4 x 20) = 53.33 hops.
3. Dwell Time(s) = Hops Over Occupancy Time (hops) x Package Transfer Time





**20dB Bandwidth**

<1Mbps>

20 dB Bandwidth Plot on Channel 00

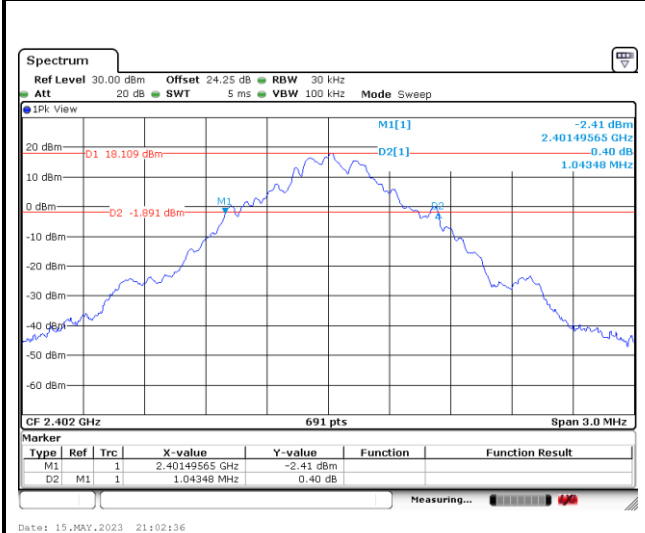

20 dB Bandwidth Plot on Channel 39

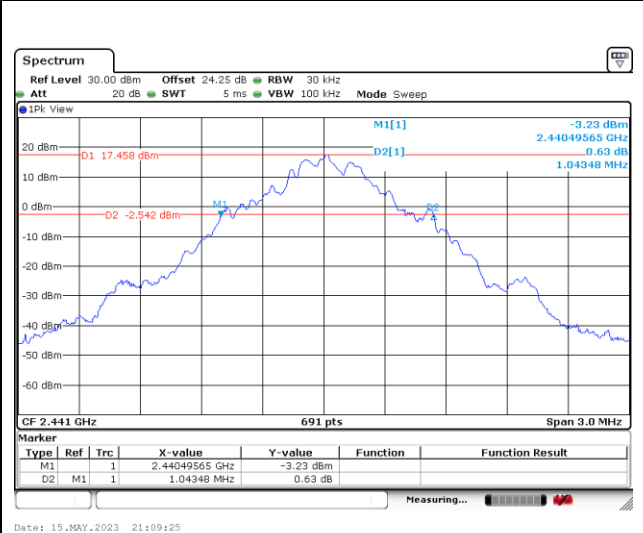

20 dB Bandwidth Plot on Channel 78

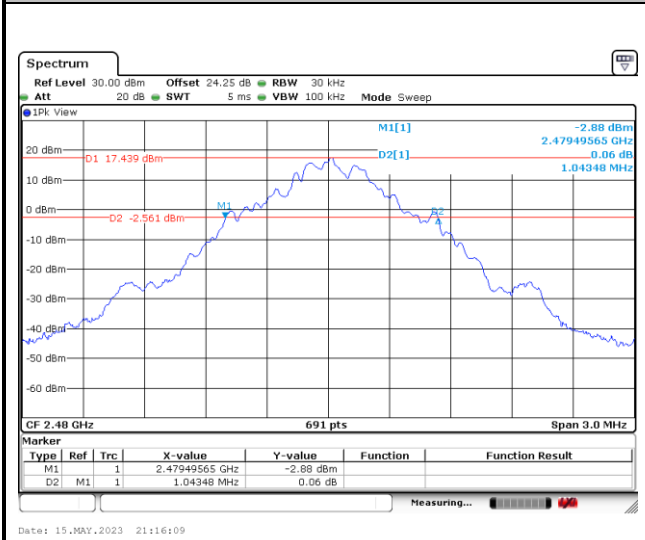



<2Mbps>

20 dB Bandwidth Plot on Channel 00

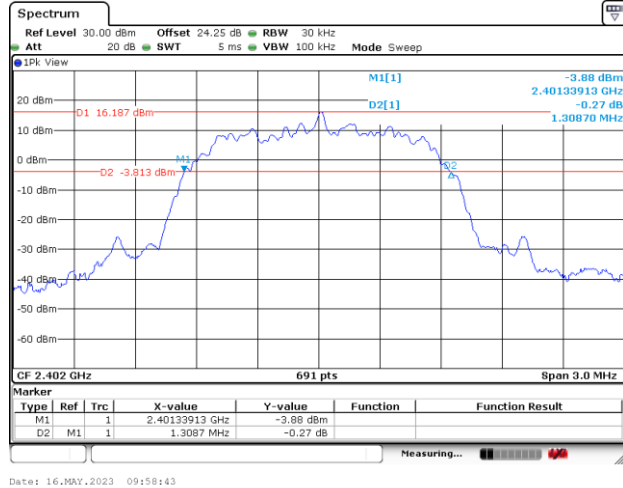

20 dB Bandwidth Plot on Channel 39

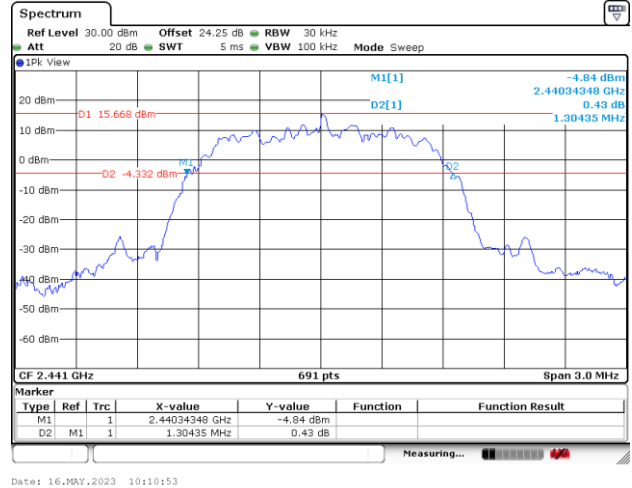

20 dB Bandwidth Plot on Channel 78

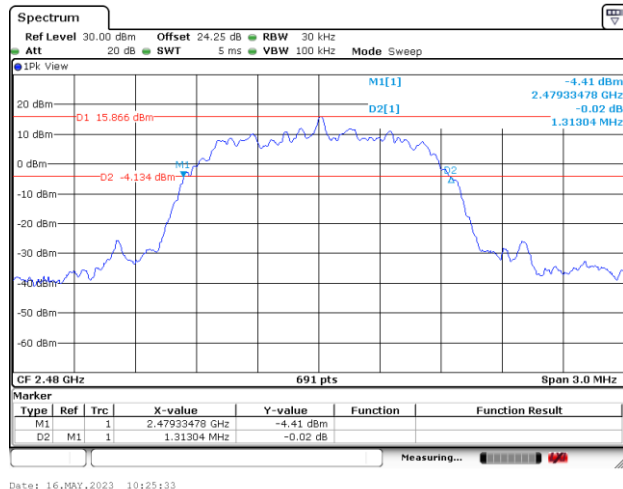



<3Mbps>

20 dB Bandwidth Plot on Channel 00

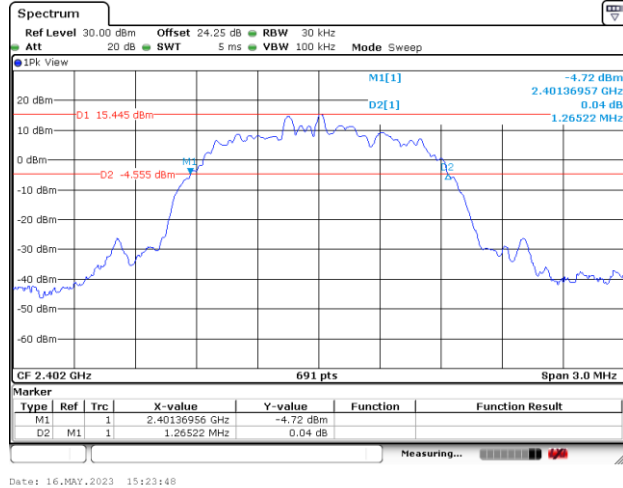

20 dB Bandwidth Plot on Channel 39

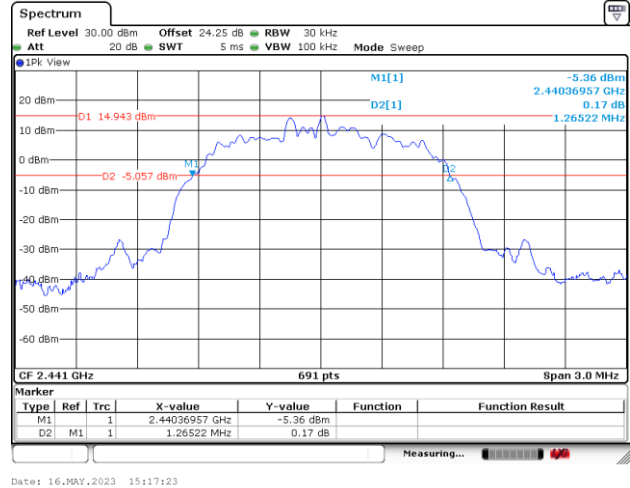

20 dB Bandwidth Plot on Channel 78

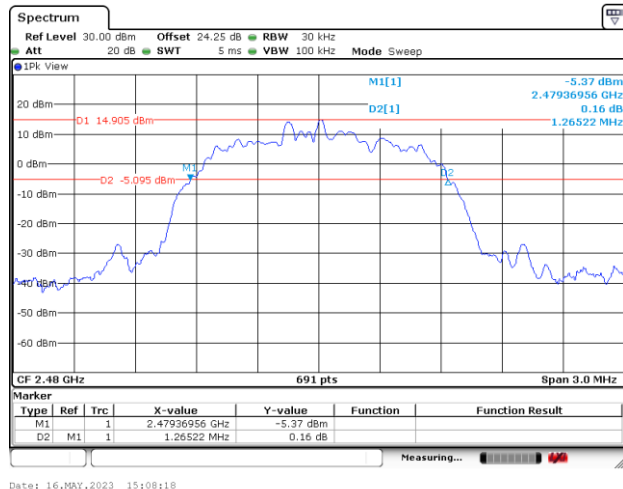



# 99% Occupied Bandwidth

<1Mbps>

## 99% Occupied Bandwidth on Channel 00

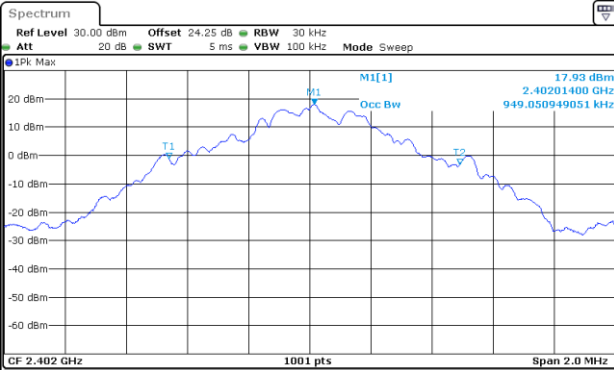

| Type | Ref | Trc | X-value        | Y-value   | Function | Function Result   |
|------|-----|-----|----------------|-----------|----------|-------------------|
| M1   | 1   |     | 2.402014 GHz   | 17.93 dBm |          |                   |
| T1   | 1   |     | 2.40154046 GHz | -1.16 dBm | Occ Bw   | 949.050949051 kHz |
| T2   | 1   |     | 2.40248951 GHz | -3.27 dBm |          |                   |

Date: 15.MAY.2023 21:01:47

## 99% Occupied Bandwidth on Channel 39

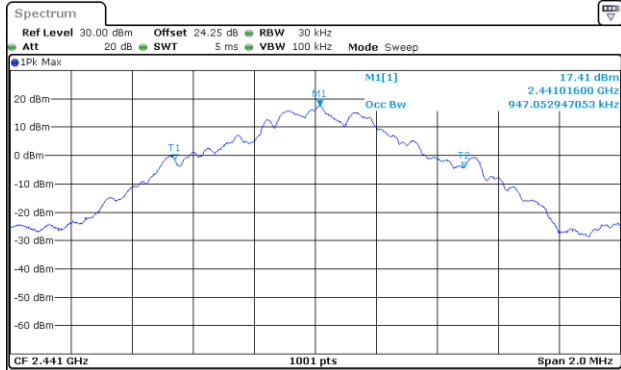

| Type | Ref | Trc | X-value        | Y-value   | Function | Function Result   |
|------|-----|-----|----------------|-----------|----------|-------------------|
| M1   | 1   |     | 2.441016 GHz   | 17.41 dBm |          |                   |
| T1   | 1   |     | 2.44054046 GHz | -1.67 dBm | Occ Bw   | 947.052947053 kHz |
| T2   | 1   |     | 2.44148751 GHz | -4.24 dBm |          |                   |

Date: 15.MAY.2023 21:09:14

## 99% Occupied Bandwidth on Channel 78

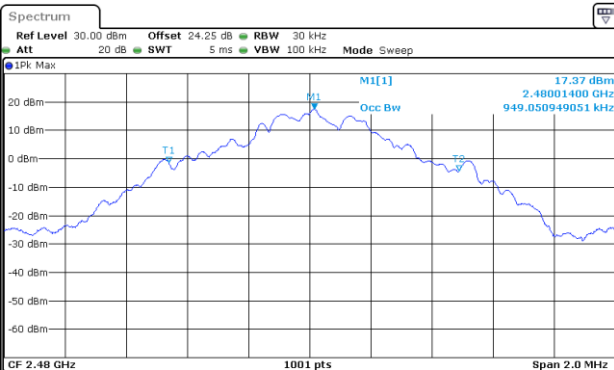

| Type | Ref | Trc | X-value        | Y-value   | Function | Function Result   |
|------|-----|-----|----------------|-----------|----------|-------------------|
| M1   | 1   |     | 2.480014 GHz   | 17.37 dBm |          |                   |
| T1   | 1   |     | 2.47953846 GHz | -1.35 dBm | Occ Bw   | 949.050949051 kHz |
| T2   | 1   |     | 2.48048751 GHz | -4.31 dBm |          |                   |

Date: 15.MAY.2023 21:15:34



<2Mbps>

99% Occupied Bandwidth on Channel 00

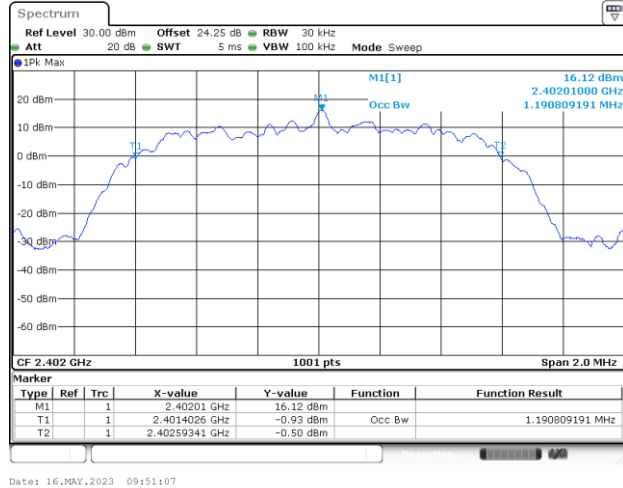

Date: 16.MAY.2023 09:51:07

99% Occupied Bandwidth on Channel 39

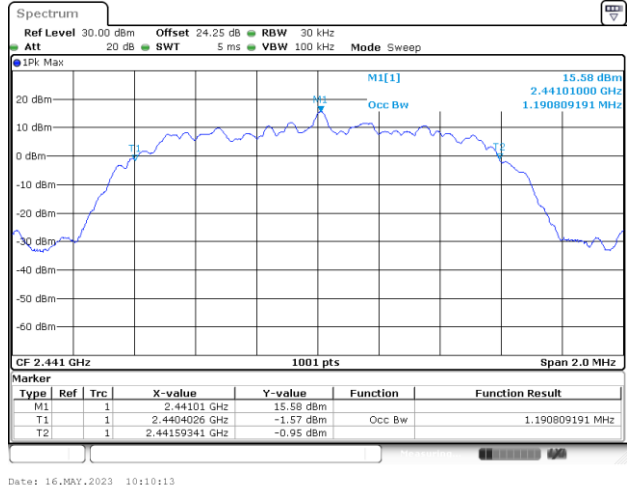

Date: 16.MAY.2023 10:10:13

99% Occupied Bandwidth on Channel 78

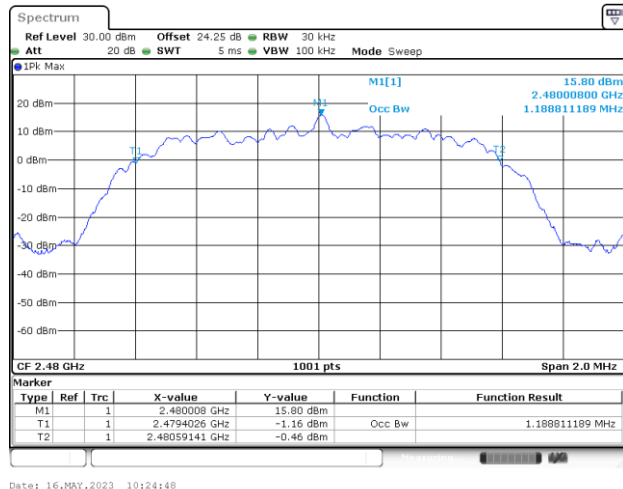

Date: 16.MAY.2023 10:24:48



<3Mbps>

99% Occupied Bandwidth on Channel 00

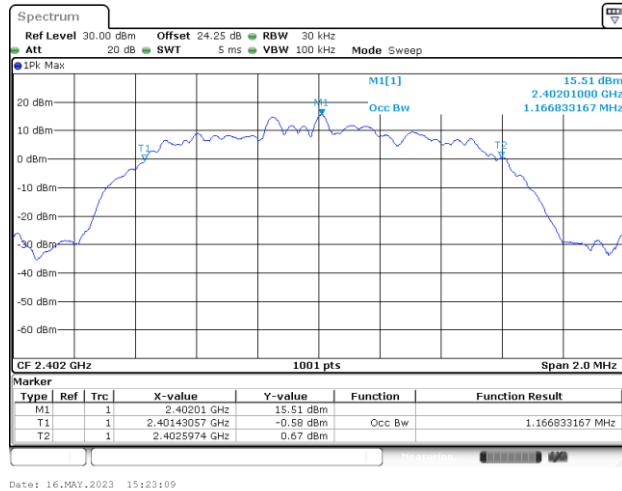

99% Occupied Bandwidth on Channel 39

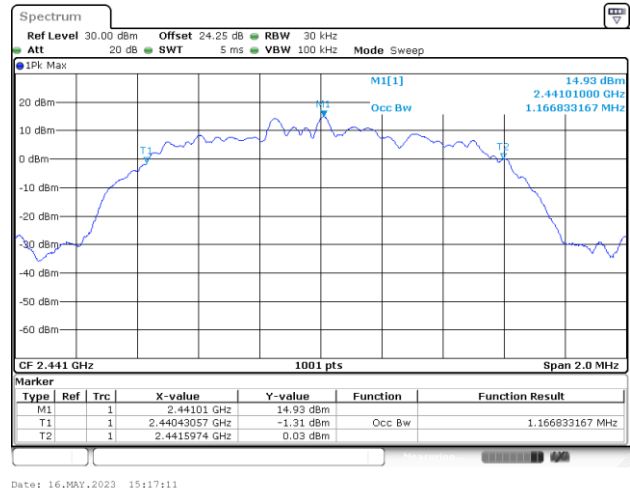

99% Occupied Bandwidth on Channel 78

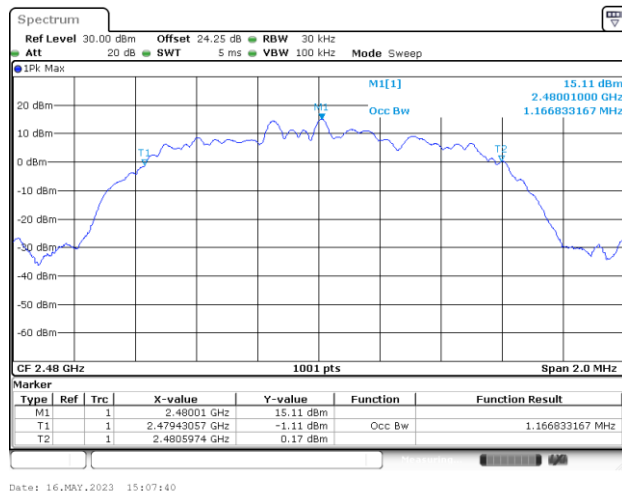

**Note:** The occupied channel bandwidth is maintained within the band of operation for all of the modulations.



# Band Edges

<1Mbps>

### Low Band Edge Plot on Channel 00

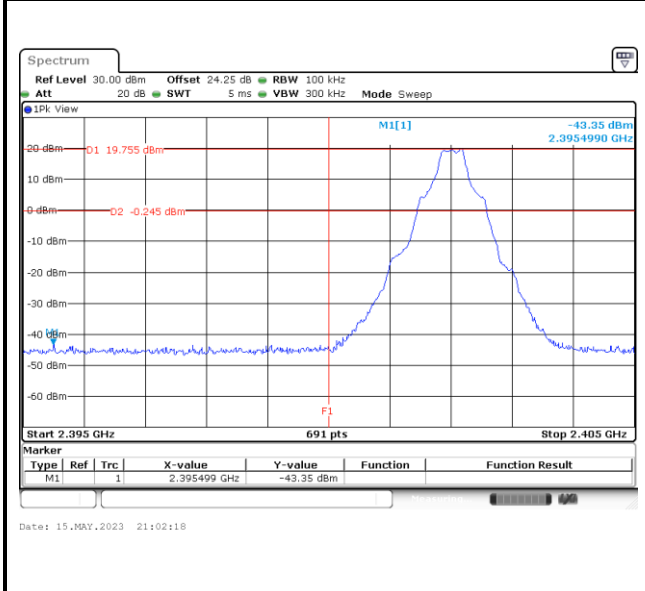

### High Band Edge Plot on Channel 78

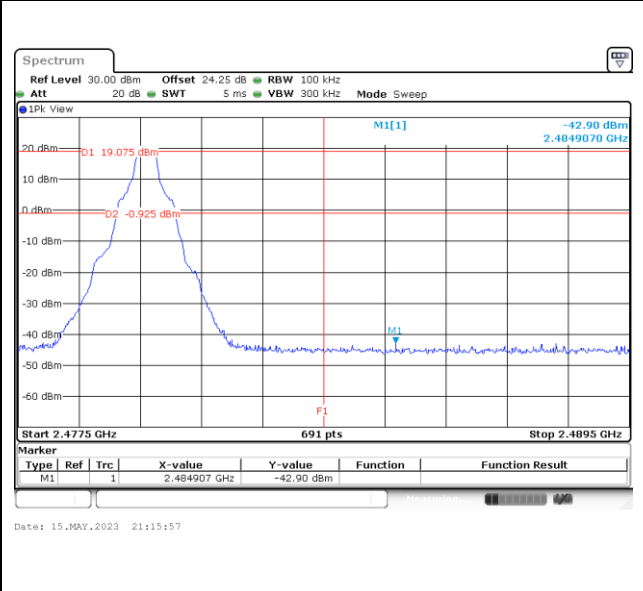

<2Mbps>

### Low Band Edge Plot on Channel 00

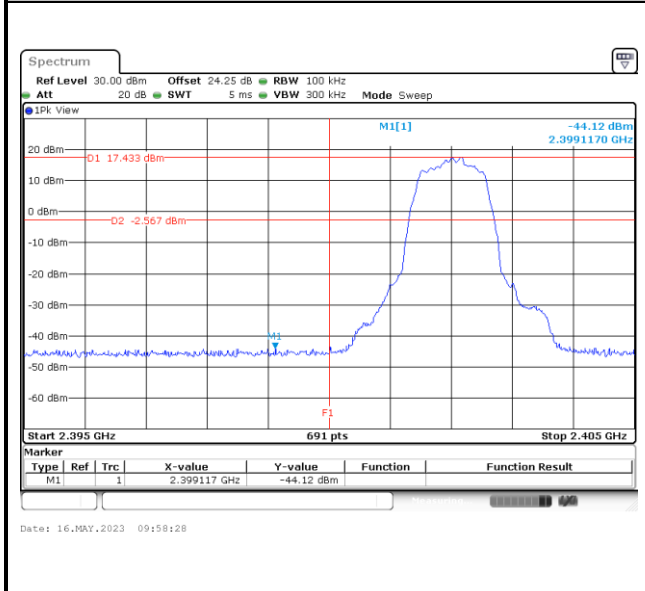

### High Band Edge Plot on Channel 78

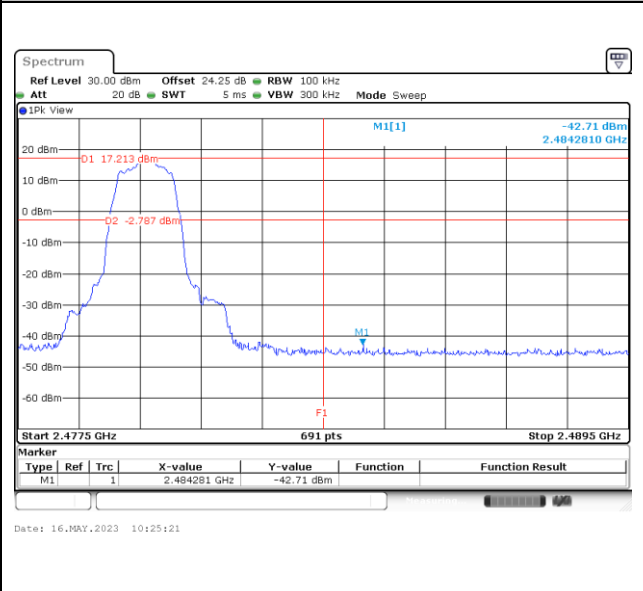



<3Mbps>

Low Band Edge Plot on Channel 00

High Band Edge Plot on Channel 78

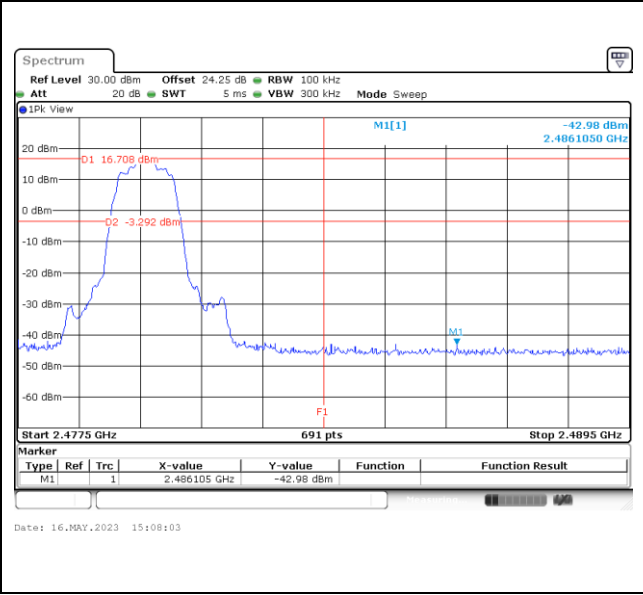
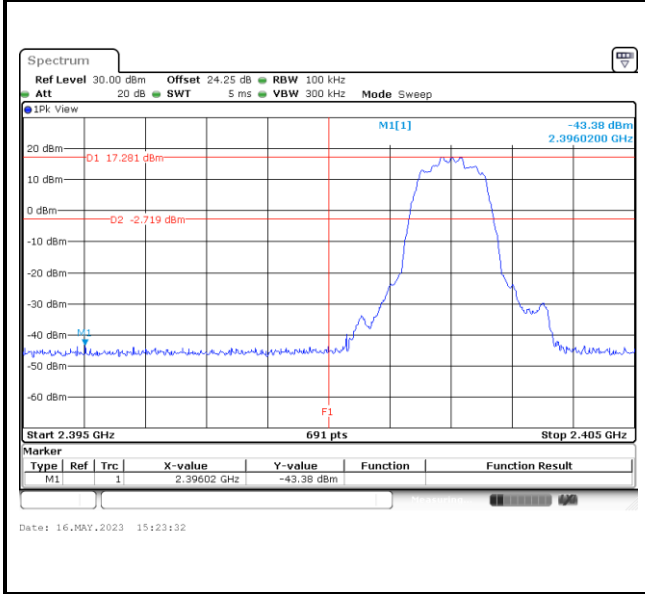





# Hopping Mode Band Edges

<1Mbps>

### Hopping Mode Low Band Edge Plot

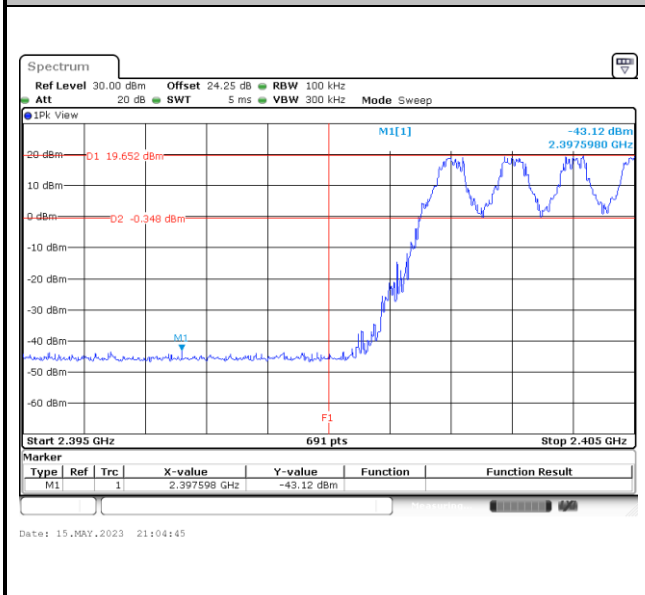

### Hopping Mode High Band Edge Plot

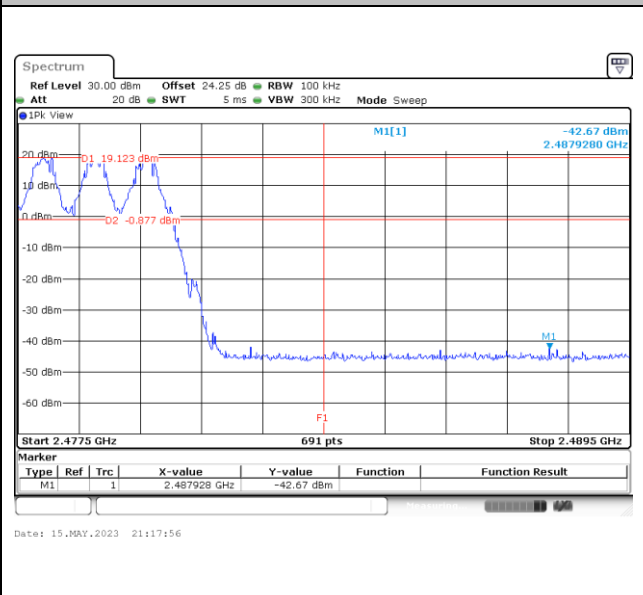

<2Mbps>

### Hopping Mode Low Band Edge Plot

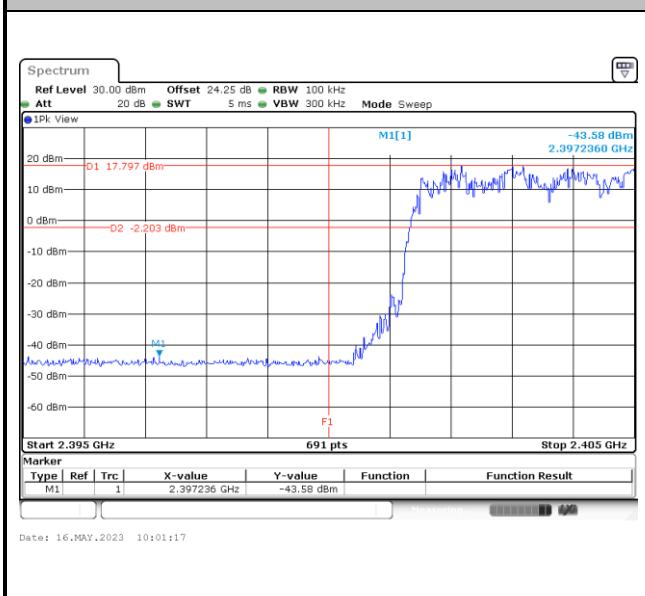

### Hopping Mode High Band Edge Plot

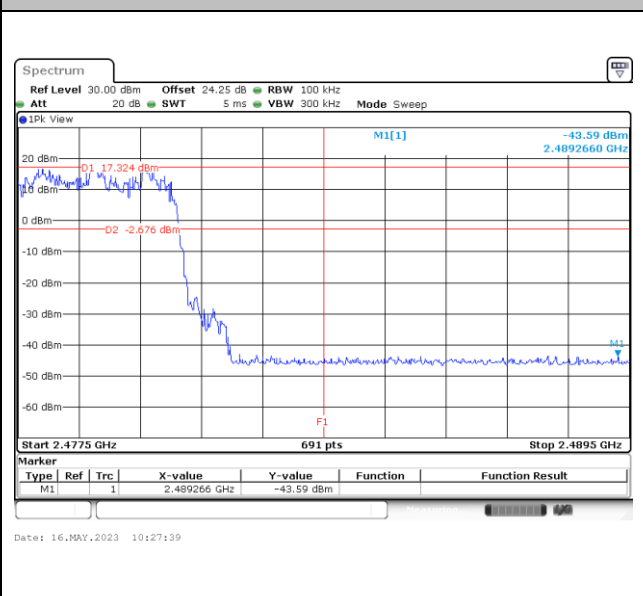



<3Mbps>

Hopping Mode Low Band Edge Plot

Hopping Mode High Band Edge Plot

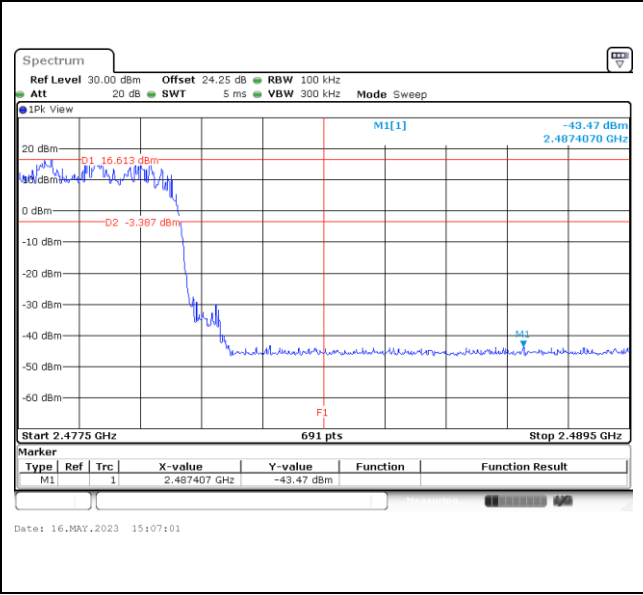
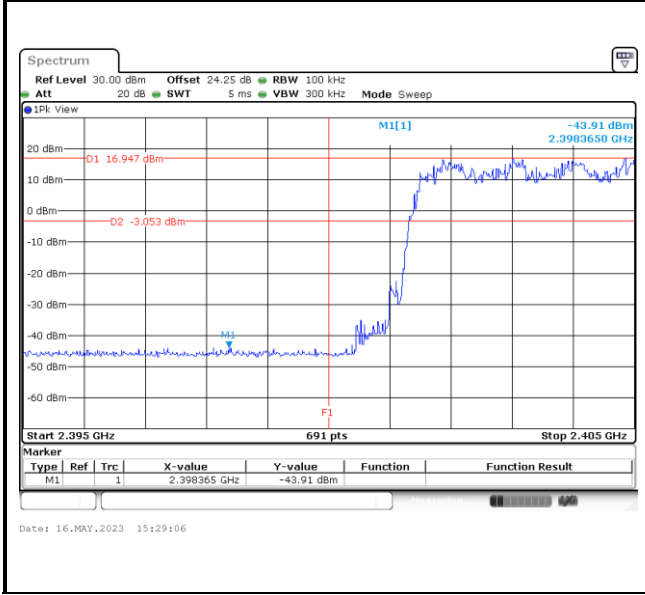



# Spurious Emission

<1Mbps>

### CSE Plot on Ch 00 between 30MHz ~ 1 GHz

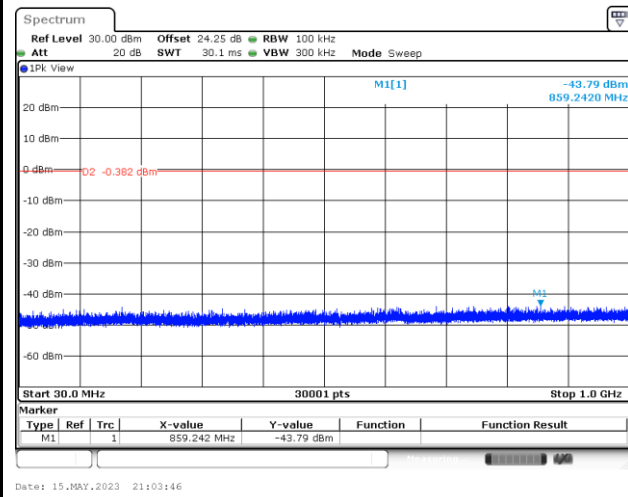

### CSE Plot on Ch 00 between 1 GHz ~ 26.5 GHz

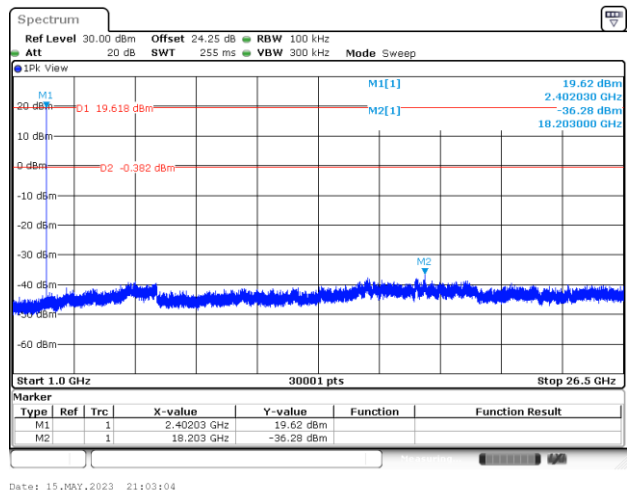

### CSE Plot on Ch 39 between 30MHz ~ 1 GHz

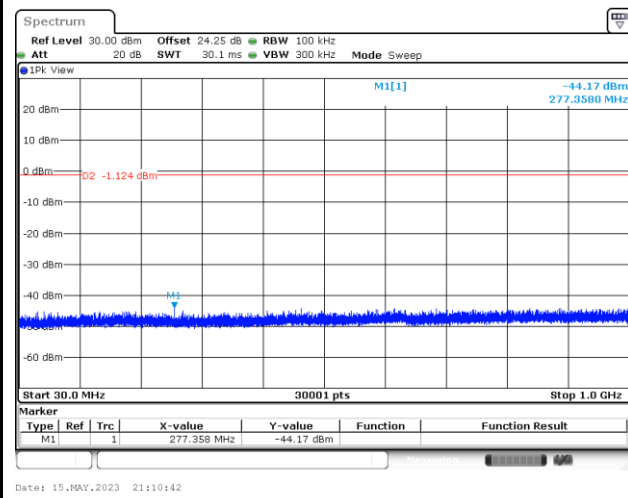

### CSE Plot on Ch 39 between 1 GHz ~ 26.5 GHz

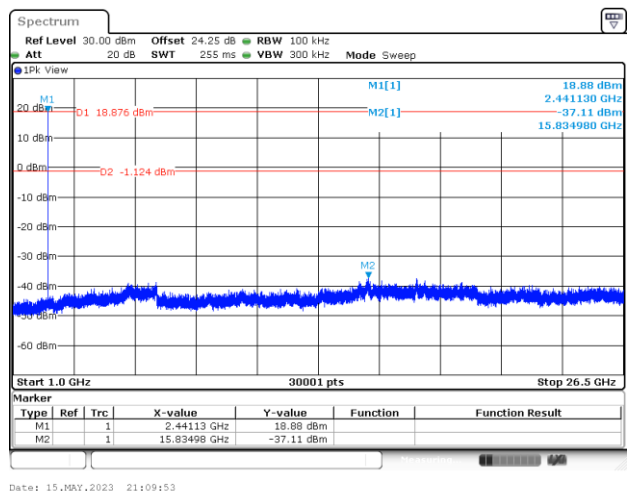



CSE Plot on Ch 78 between 30MHz ~ 1 GHz

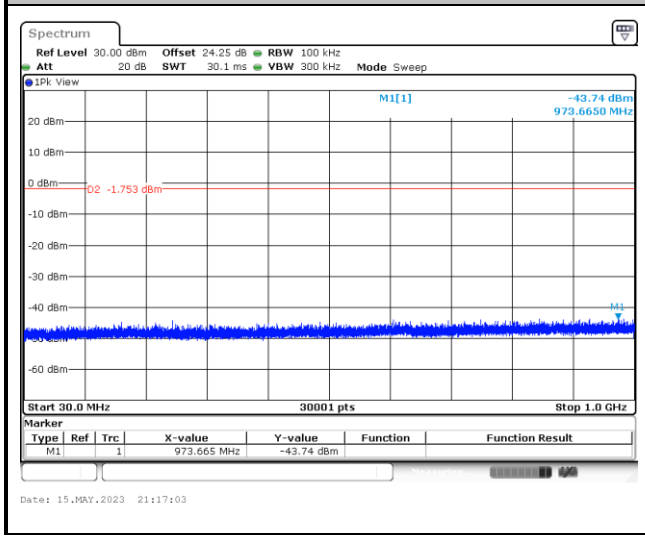

CSE Plot on Ch 78 between 1 GHz ~ 26.5 GHz

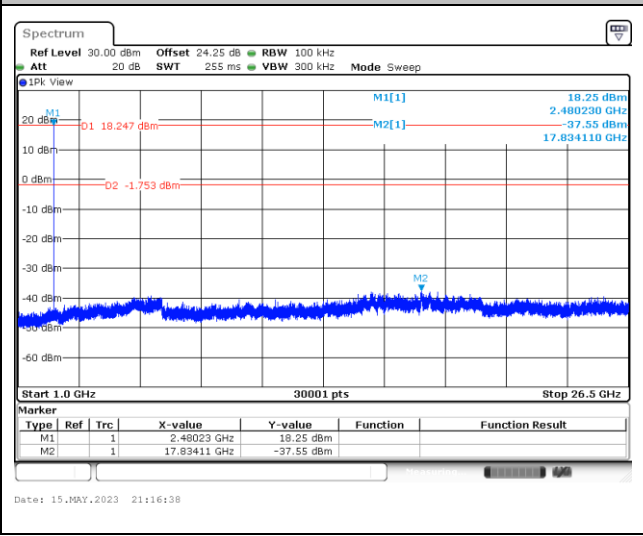



<2Mbps>

CSE Plot on Ch 00 between 30MHz ~ 1 GHz

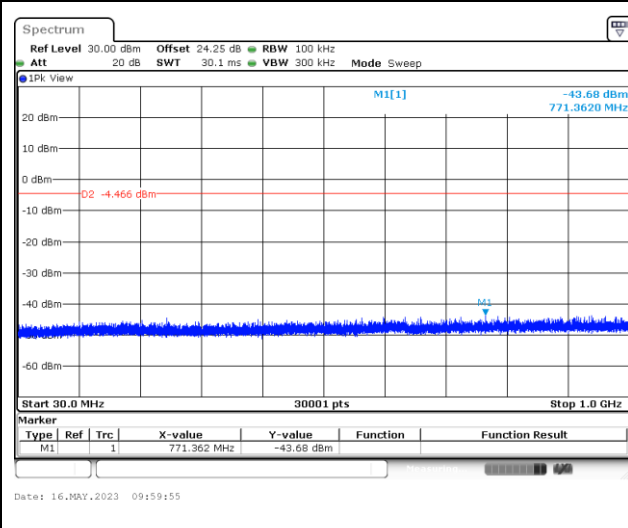

CSE Plot on Ch 00 between 1 GHz ~ 26.5 GHz

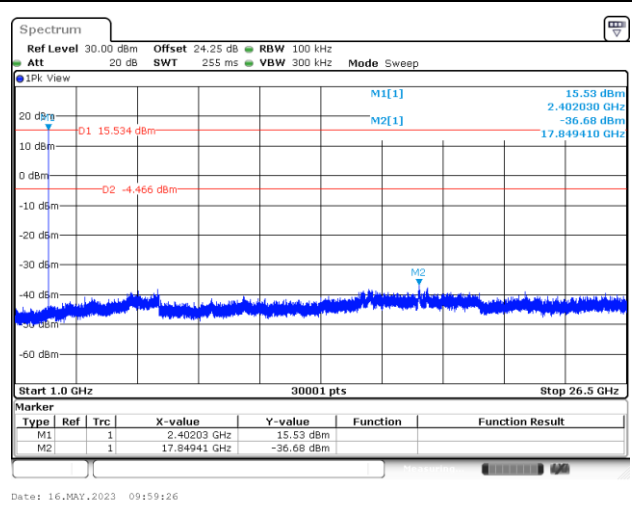

CSE Plot on Ch 39 between 30MHz ~ 1 GHz

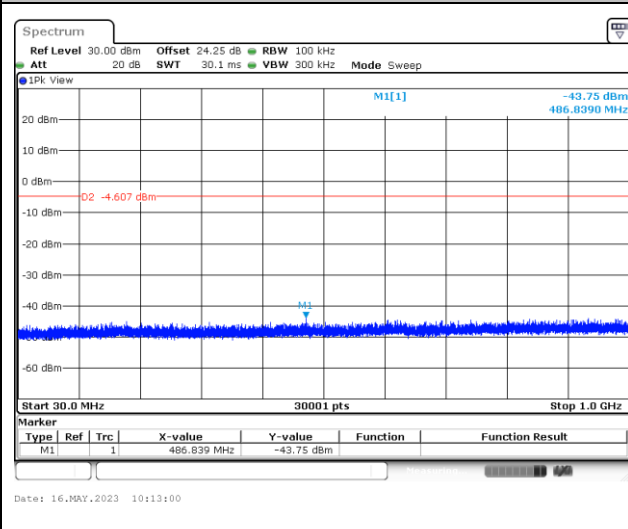

CSE Plot on Ch 39 between 1 GHz ~ 26.5 GHz

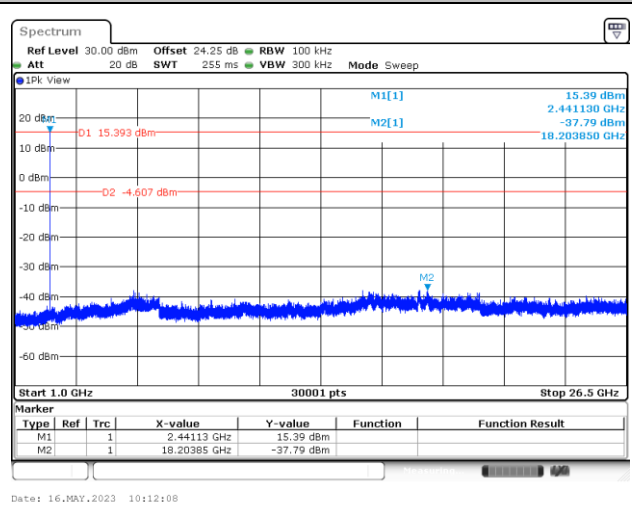



CSE Plot on Ch 78 between 30MHz ~ 1 GHz

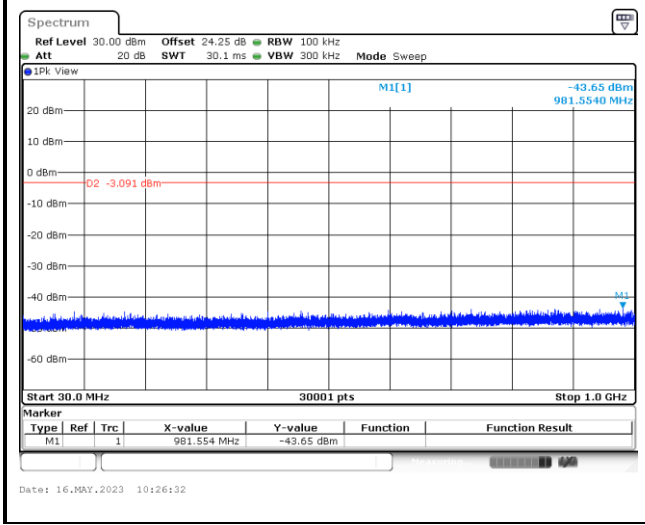

CSE Plot on Ch 78 between 1 GHz ~ 26.5 GHz

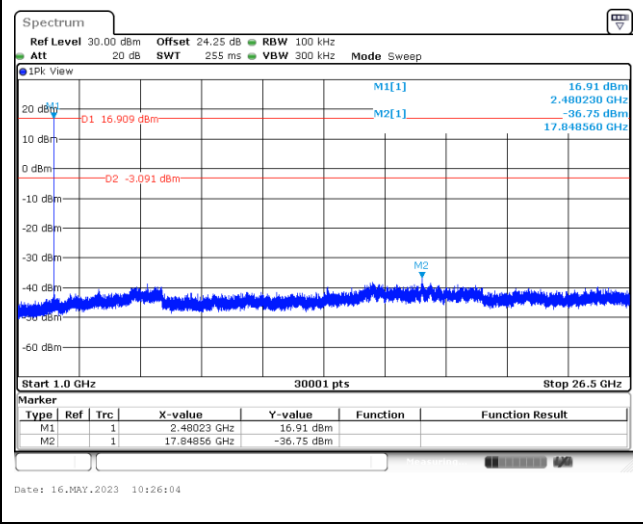



<3Mbps>

CSE Plot on Ch 00 between 30MHz ~ 1 GHz

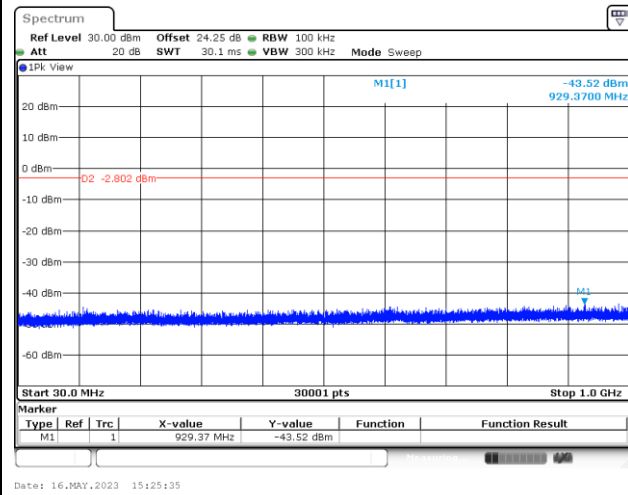

CSE Plot on Ch 00 between 1 GHz ~ 26.5 GHz

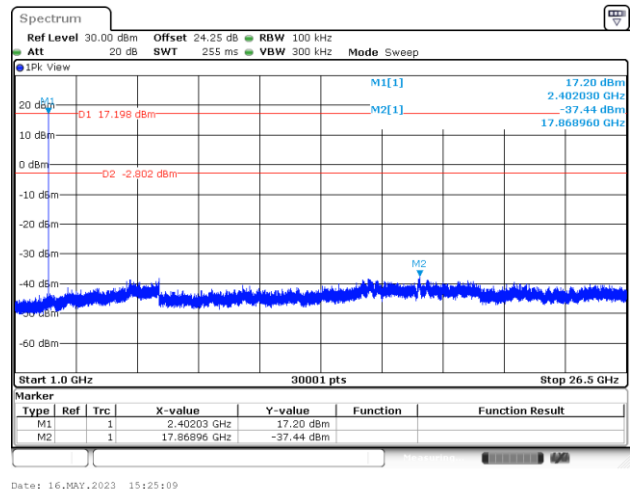

CSE Plot on Ch 39 between 30MHz ~ 1 GHz

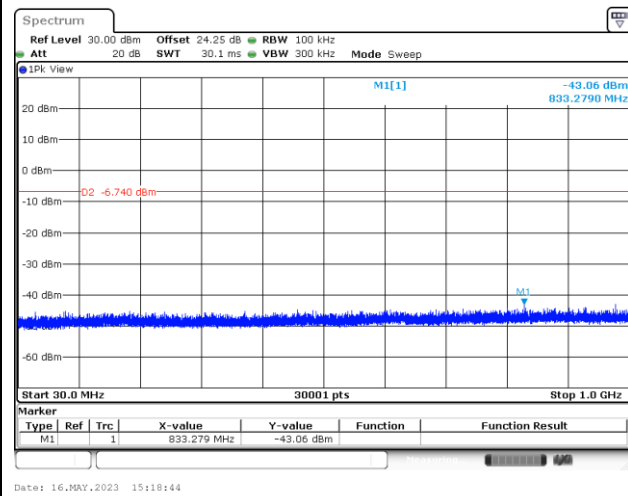

CSE Plot on Ch 39 between 1 GHz ~ 26.5 GHz

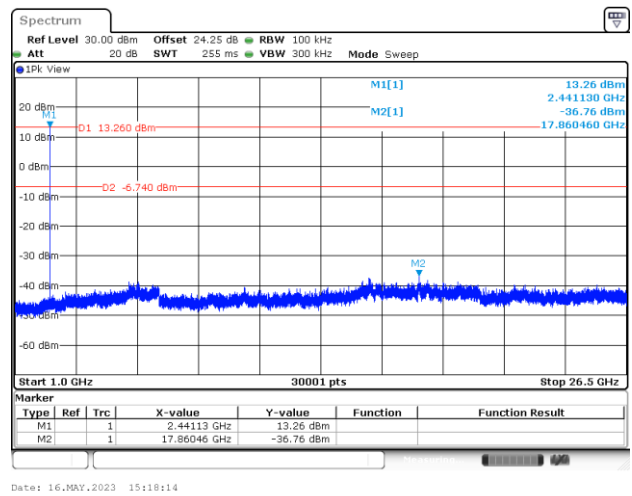



CSE Plot on Ch 78 between 30MHz ~ 1 GHz

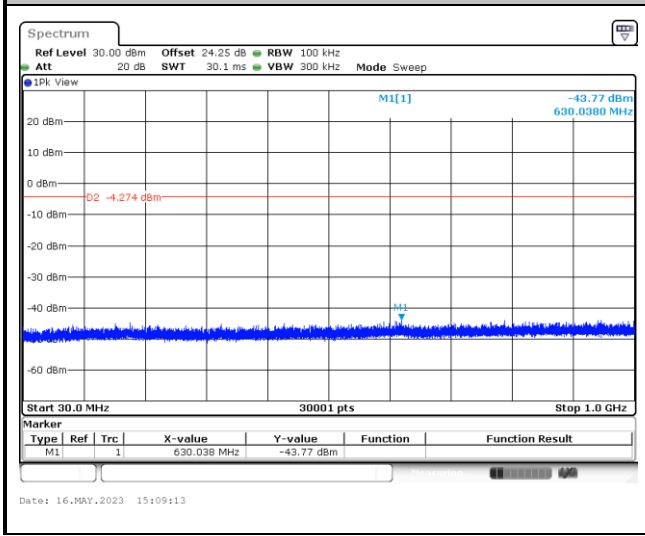

CSE Plot on Ch 78 between 1 GHz ~ 26.5 GHz

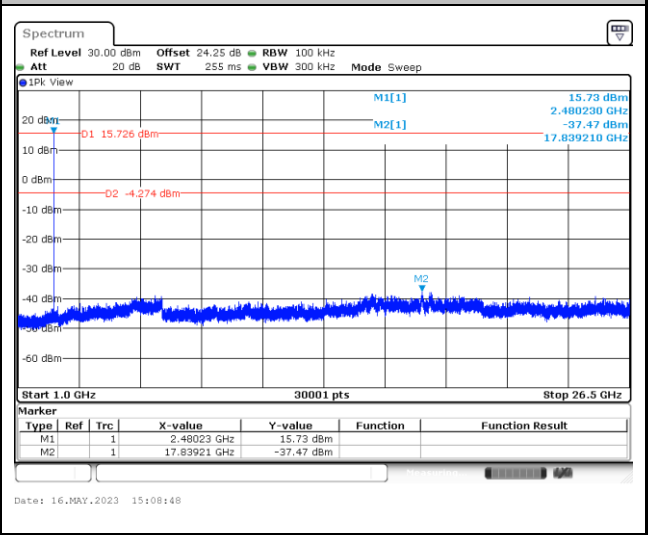





<BR+EDR Ant.4>

# Number of Hopping Frequency

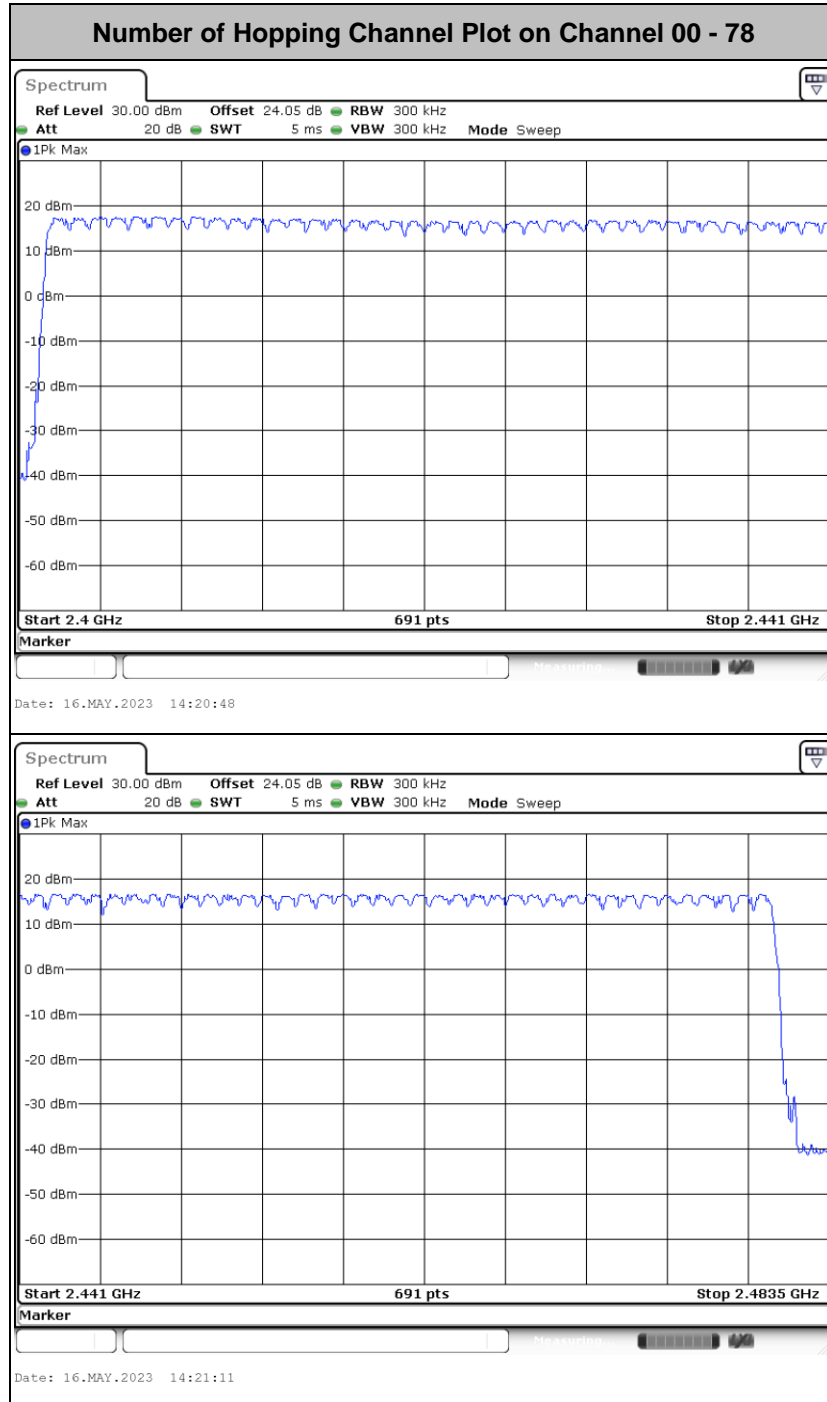



# Hopping Channel Separation

<1Mbps>

### Channel Separation Plot on Channel 00 - 01

### Channel Separation Plot on Channel 39 - 40

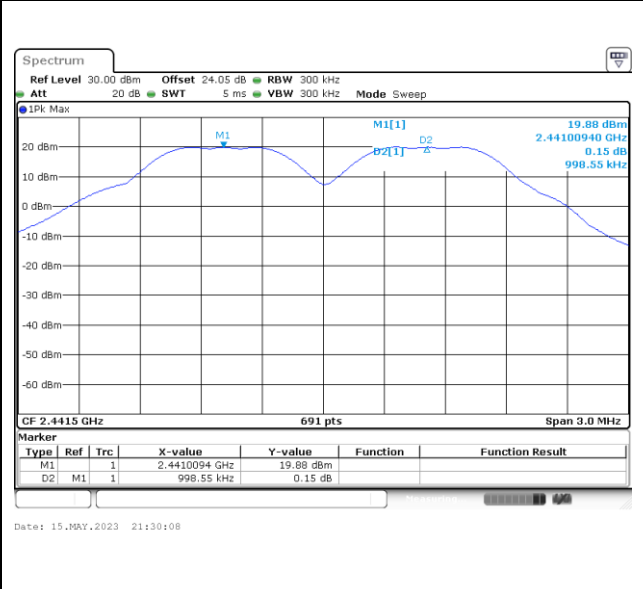
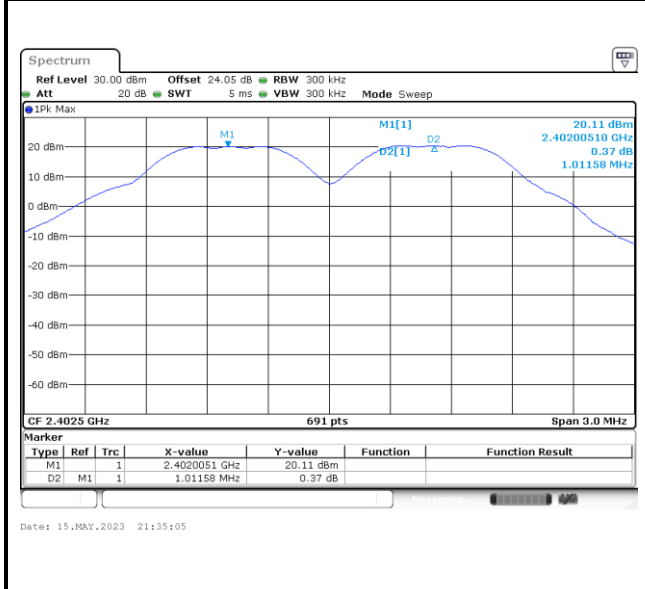

### Channel Separation Plot on Channel 77 - 78

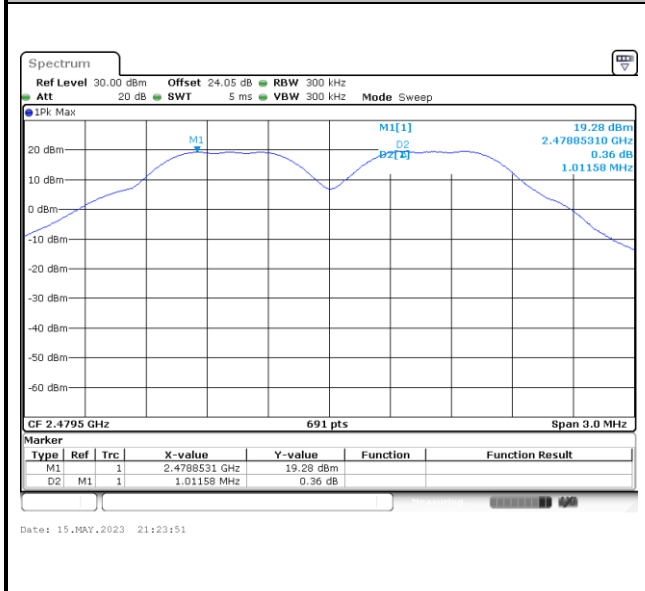



<2Mbps>

Channel Separation Plot on Channel 00 - 01

Channel Separation Plot on Channel 39 - 40

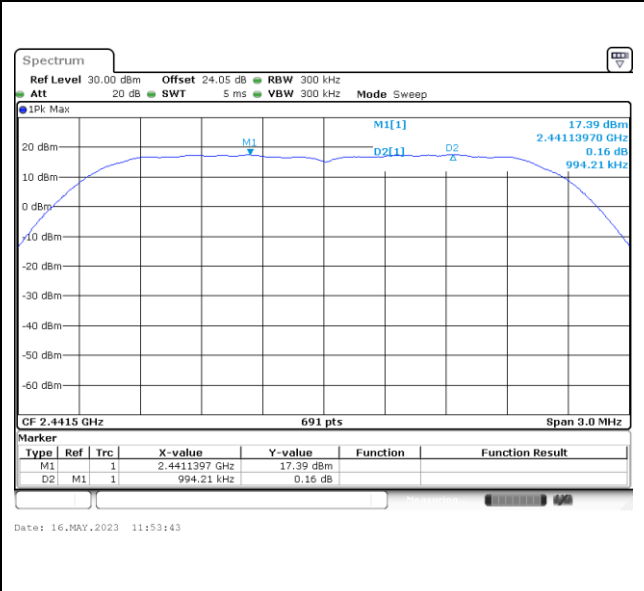
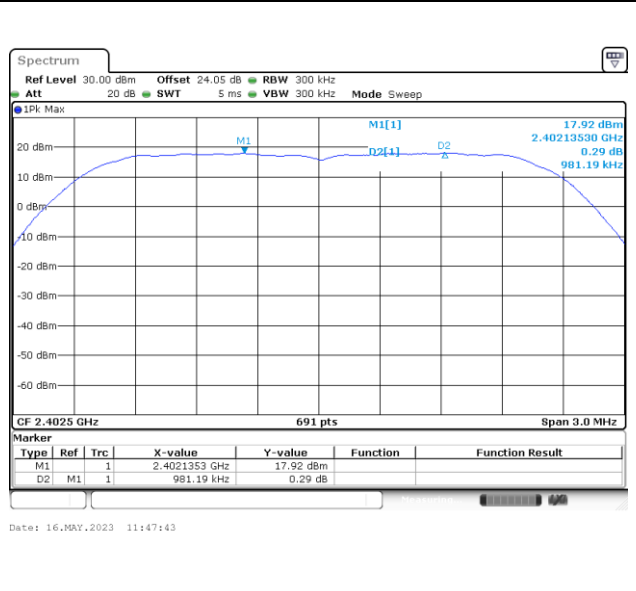

Channel Separation Plot on Channel 77 - 78

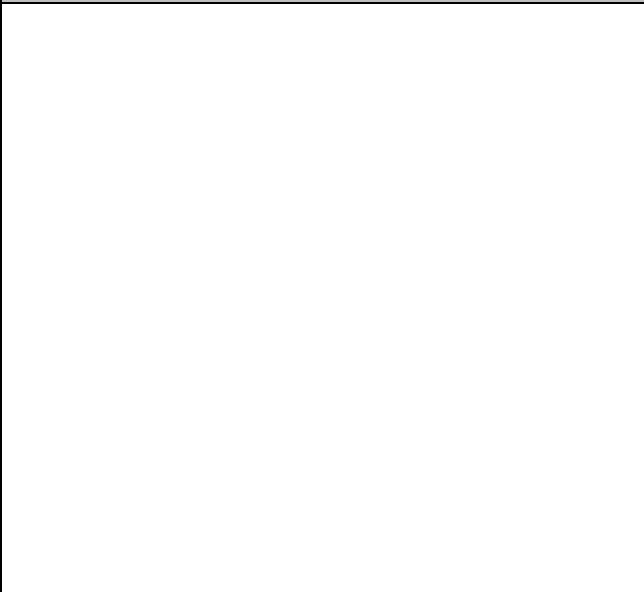
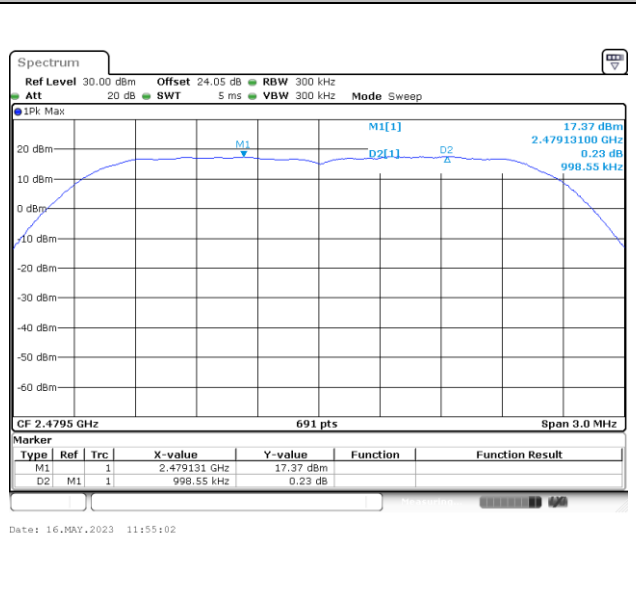



<3Mbps>

Channel Separation Plot on Channel 00 - 01

Channel Separation Plot on Channel 39 - 40

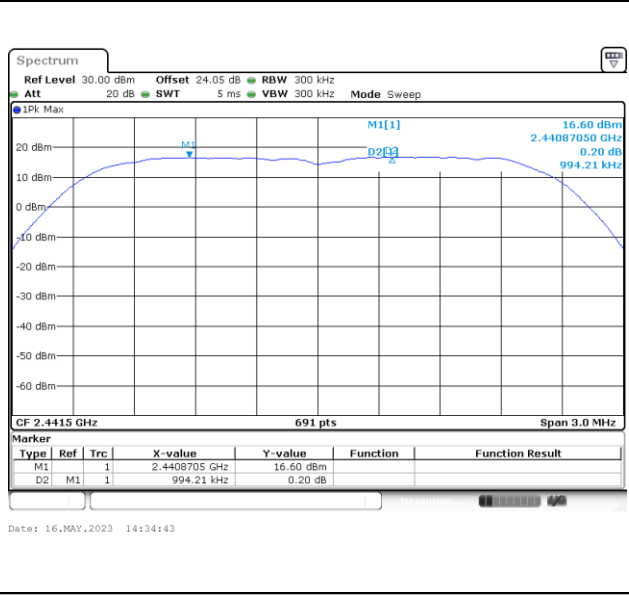
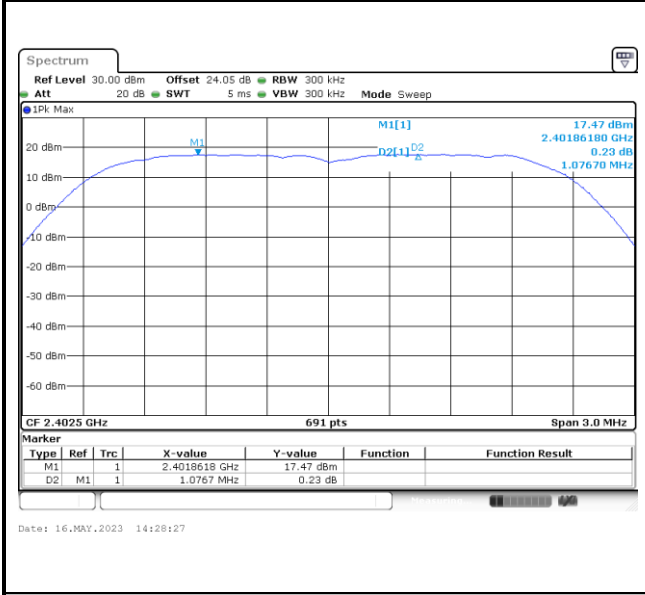

Channel Separation Plot on Channel 77 - 78

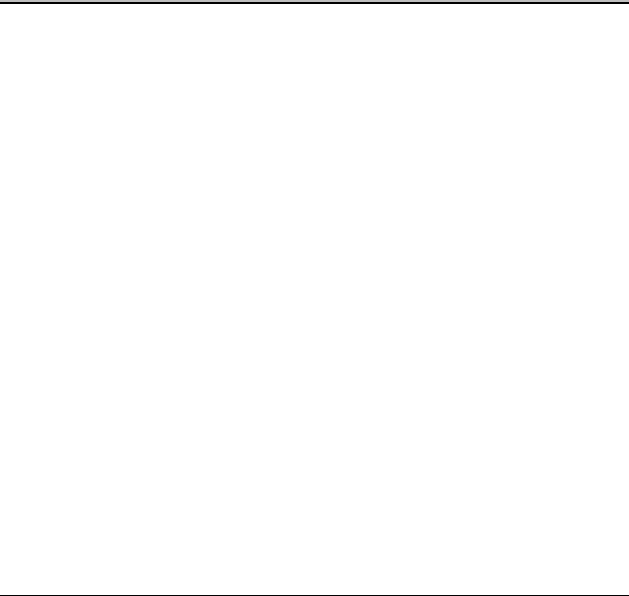
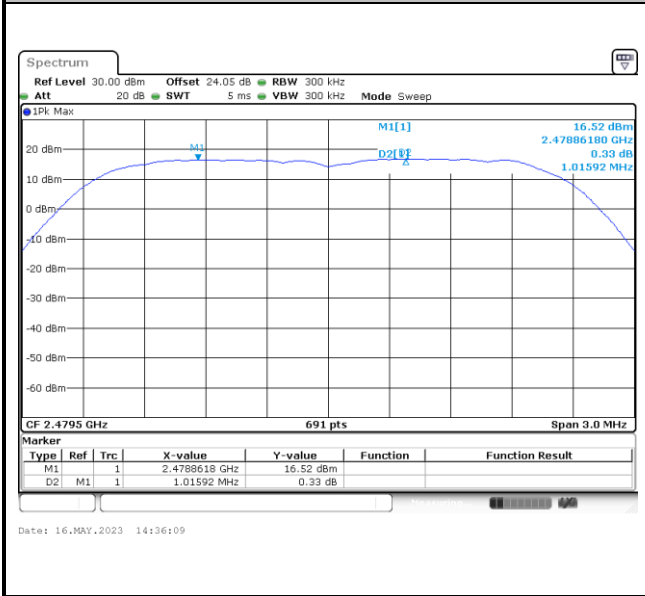



# Dwell Time

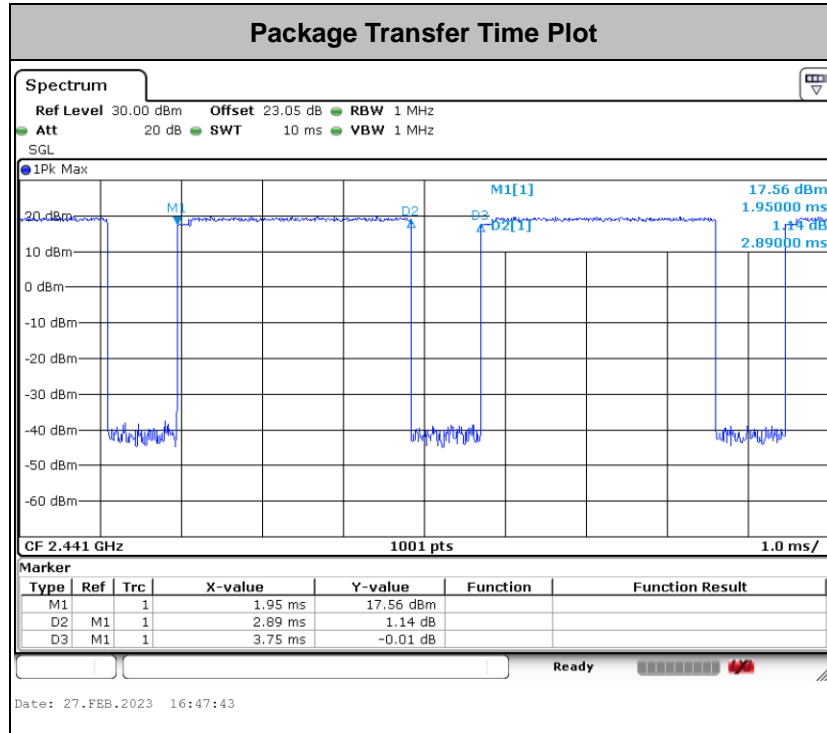

**Remark:**

1. In normal mode, hopping rate is 1600 hops/s with 6 slots in 79 hopping channels. With channel hopping rate (1600 / 6 / 79) in Occupancy Time Limit (0.4 x 79) (s), Hops Over Occupancy Time comes to (1600 / 6 / 79) x (0.4 x 79) = 106.67 hops.
2. In AFH mode, hopping rate is 800 hops/s with 6 slots in 20 hopping channels. With channel hopping rate (800 / 6 / 20) in Occupancy Time Limit (0.4 x 20) (s), Hops Over Occupancy Time comes to (800 / 6 / 20) x (0.4 x 20) = 53.33 hops.
3. Dwell Time(s) = Hops Over Occupancy Time (hops) x Package Transfer Time



**20dB Bandwidth**

<1Mbps>

20 dB Bandwidth Plot on Channel 00

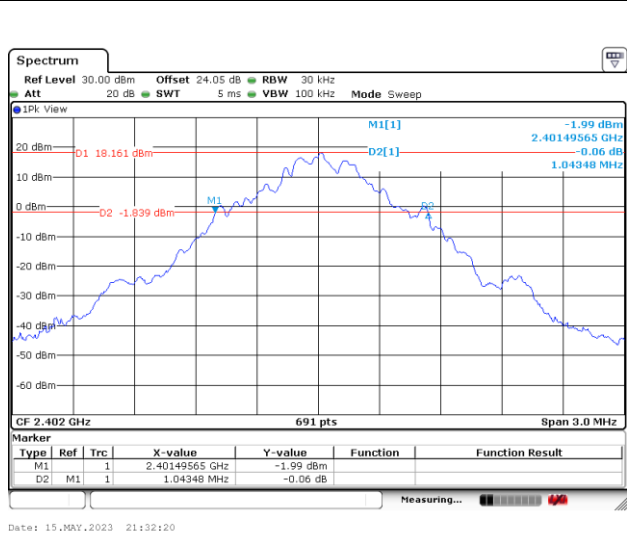

20 dB Bandwidth Plot on Channel 39

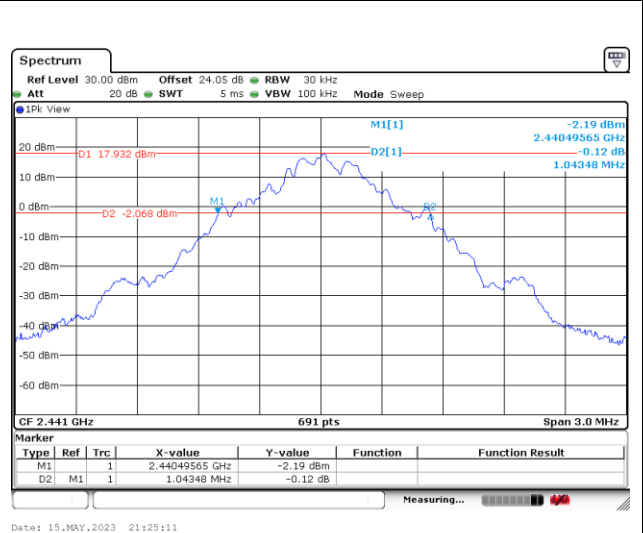

20 dB Bandwidth Plot on Channel 78

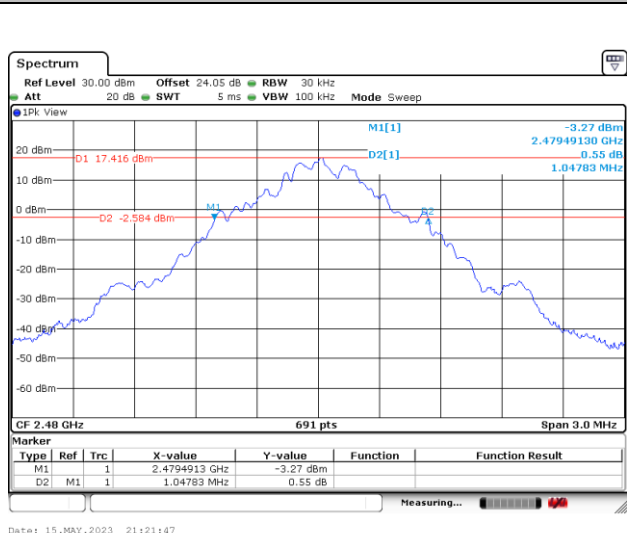



<2Mbps>

20 dB Bandwidth Plot on Channel 00

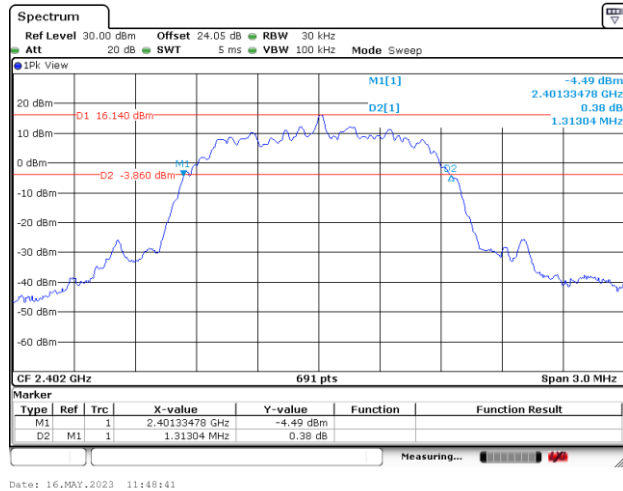

20 dB Bandwidth Plot on Channel 39

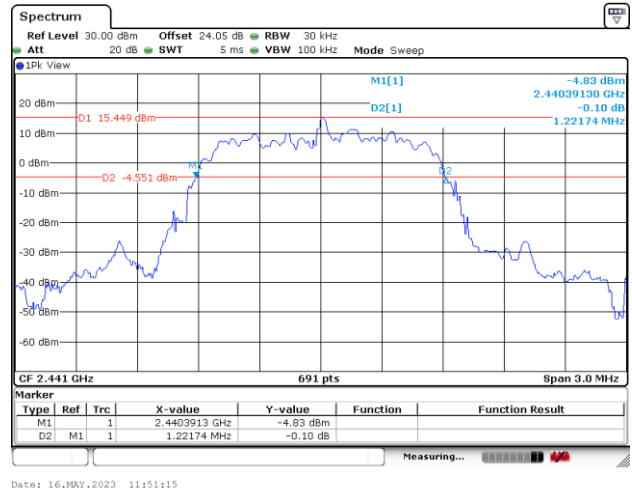

20 dB Bandwidth Plot on Channel 78

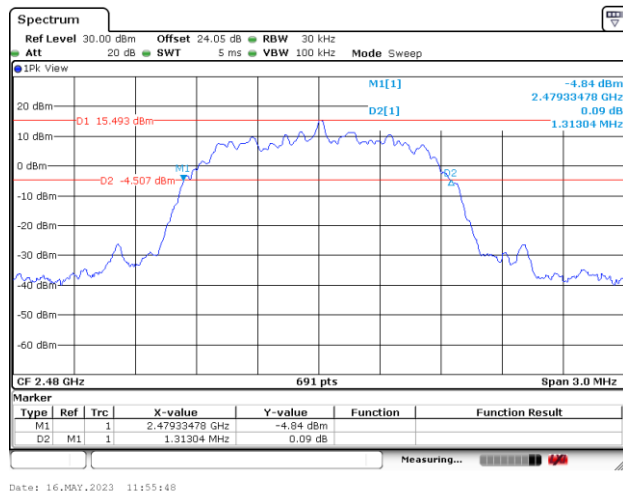



<3Mbps>

20 dB Bandwidth Plot on Channel 00

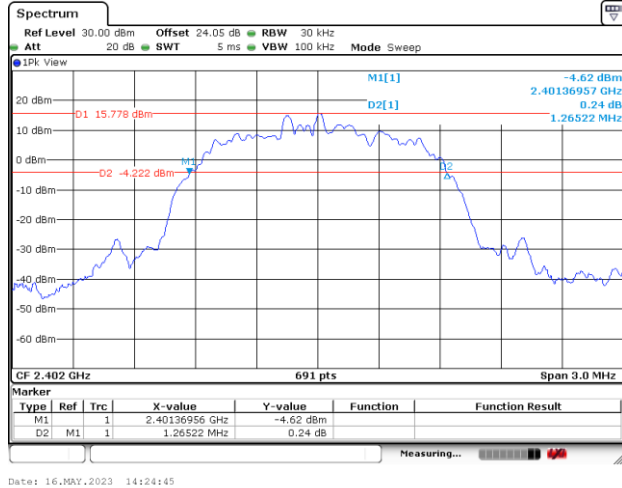

20 dB Bandwidth Plot on Channel 39

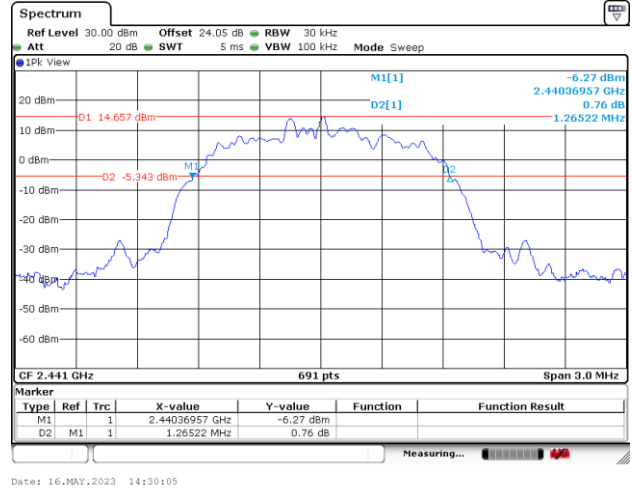

20 dB Bandwidth Plot on Channel 78

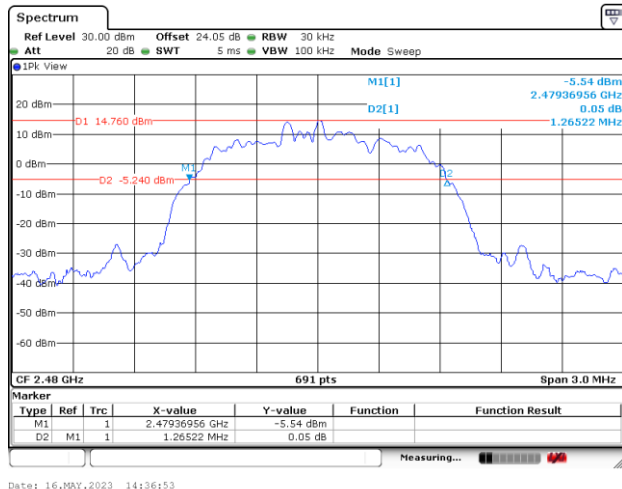





99% Occupied Bandwidth

<1Mbps>

99% Occupied Bandwidth on Channel 00

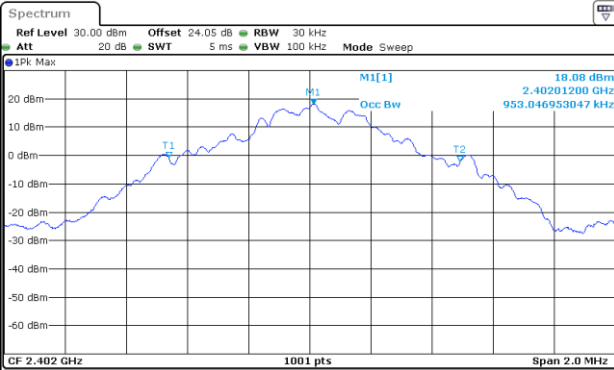

| Marker | Type | Ref | Trc | X-value        | Y-value   | Function | Function Result   |
|--------|------|-----|-----|----------------|-----------|----------|-------------------|
| M1     | 1    |     |     | 2.402012 GHz   | 18.08 dBm |          |                   |
| T1     | 1    |     |     | 2.40153846 GHz | -0.86 dBm | Occ Bw   | 953.046953047 kHz |
| T2     | 1    |     |     | 2.40249151 GHz | -2.26 dBm |          |                   |

Date: 15.MAY.2023 21:32:55

99% Occupied Bandwidth on Channel 39

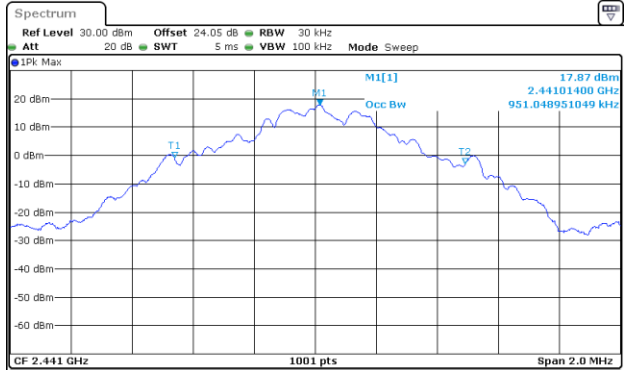

| Marker | Type | Ref | Trc | X-value        | Y-value   | Function | Function Result   |
|--------|------|-----|-----|----------------|-----------|----------|-------------------|
| M1     | 1    |     |     | 2.441014 GHz   | 17.87 dBm |          |                   |
| T1     | 1    |     |     | 2.44053846 GHz | -0.87 dBm | Occ Bw   | 951.048951049 kHz |
| T2     | 1    |     |     | 2.44148951 GHz | -3.06 dBm |          |                   |

Date: 15.MAY.2023 21:24:59

99% Occupied Bandwidth on Channel 78

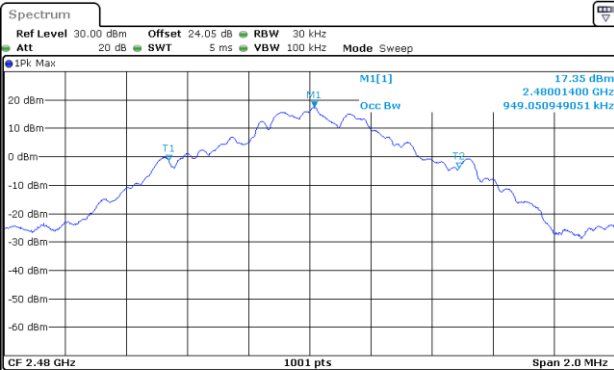

| Marker | Type | Ref | Trc | X-value        | Y-value   | Function | Function Result   |
|--------|------|-----|-----|----------------|-----------|----------|-------------------|
| M1     | 1    |     |     | 2.480014 GHz   | 17.35 dBm |          |                   |
| T1     | 1    |     |     | 2.47953846 GHz | -1.33 dBm | Occ Bw   | 949.050949051 kHz |
| T2     | 1    |     |     | 2.48048751 GHz | -3.99 dBm |          |                   |

Date: 15.MAY.2023 21:22:44



<2Mbps>

99% Occupied Bandwidth on Channel 00

99% Occupied Bandwidth on Channel 39

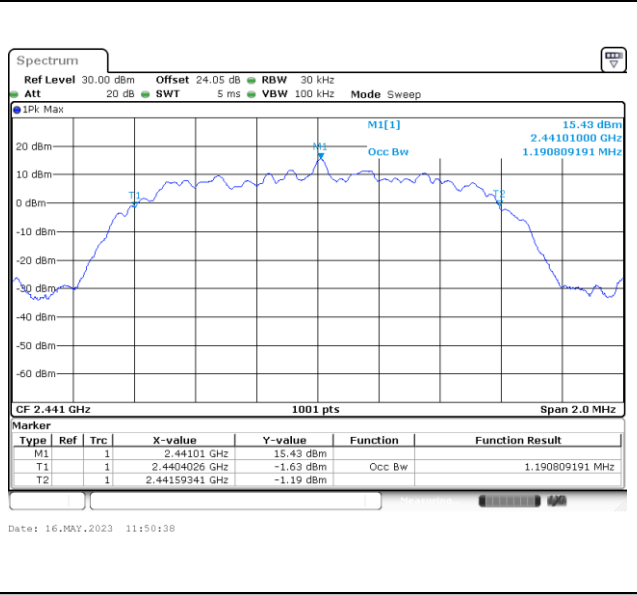
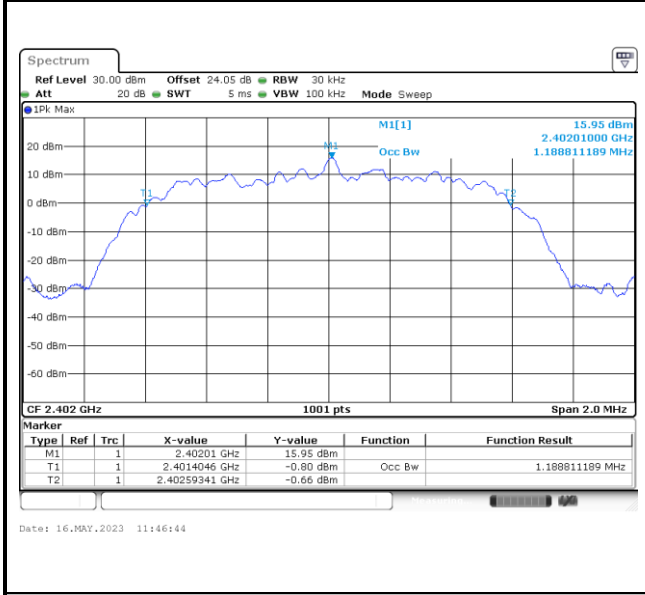

99% Occupied Bandwidth on Channel 78

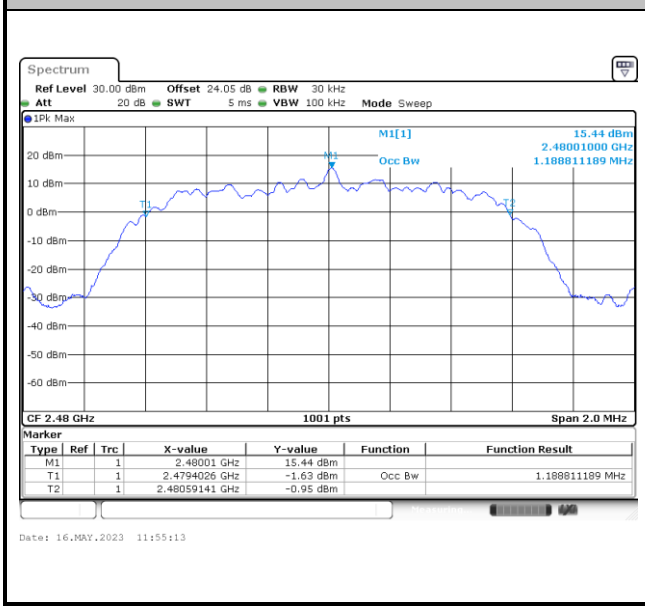



<3Mbps>

99% Occupied Bandwidth on Channel 00

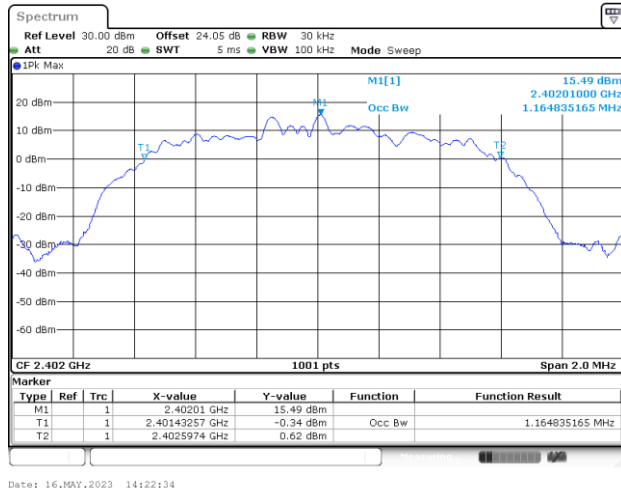

99% Occupied Bandwidth on Channel 39

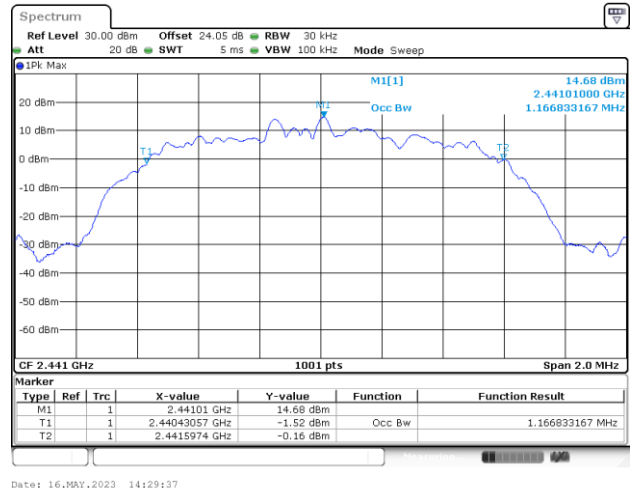

99% Occupied Bandwidth on Channel 78

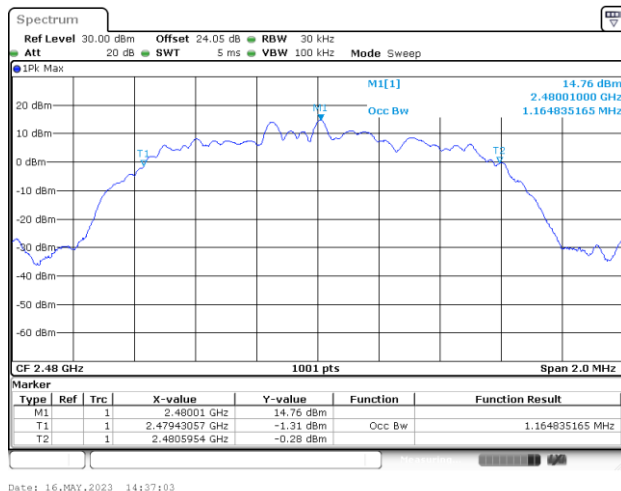

**Note:** The occupied channel bandwidth is maintained within the band of operation for all of the modulations.



# Band Edges

<1Mbps>

### Low Band Edge Plot on Channel 00

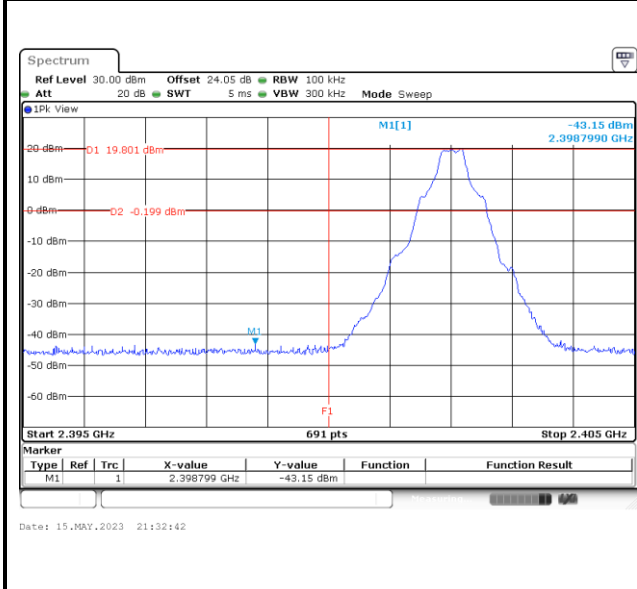

### High Band Edge Plot on Channel 78

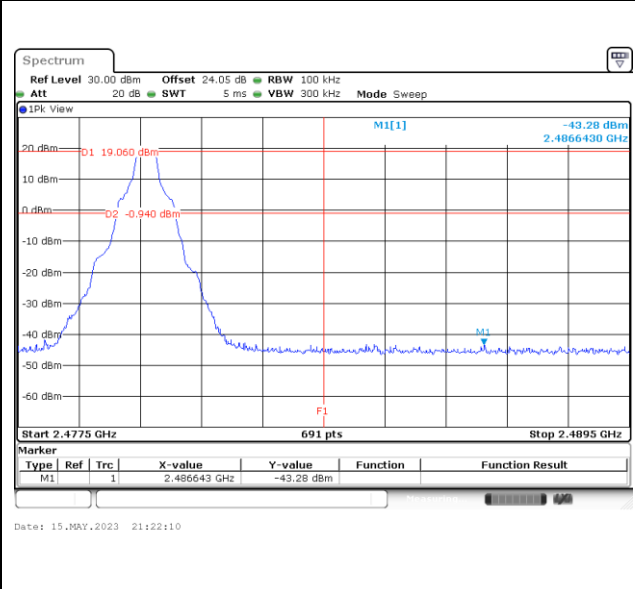

<2Mbps>

### Low Band Edge Plot on Channel 00

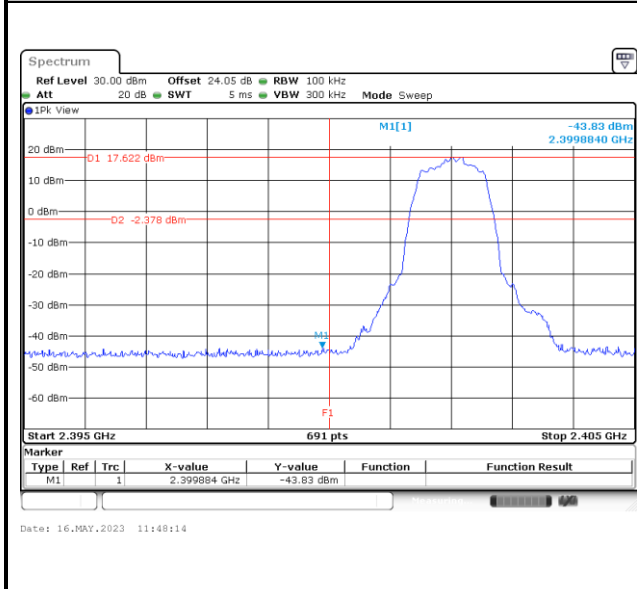

### High Band Edge Plot on Channel 78

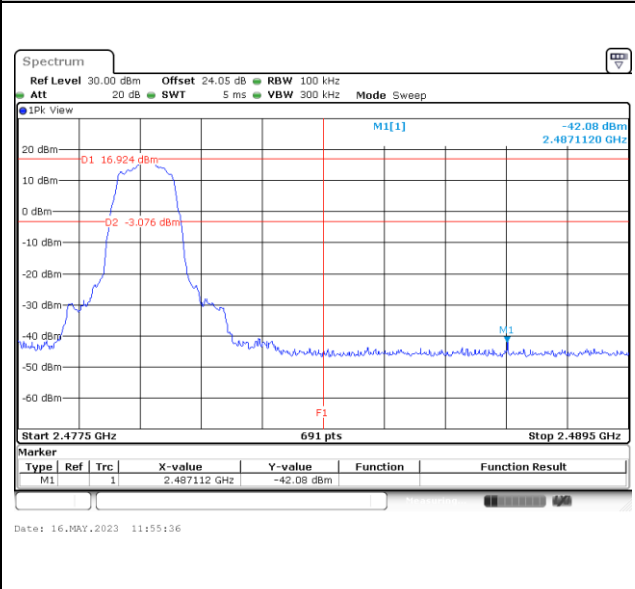



<3Mbps>

Low Band Edge Plot on Channel 00

High Band Edge Plot on Channel 78

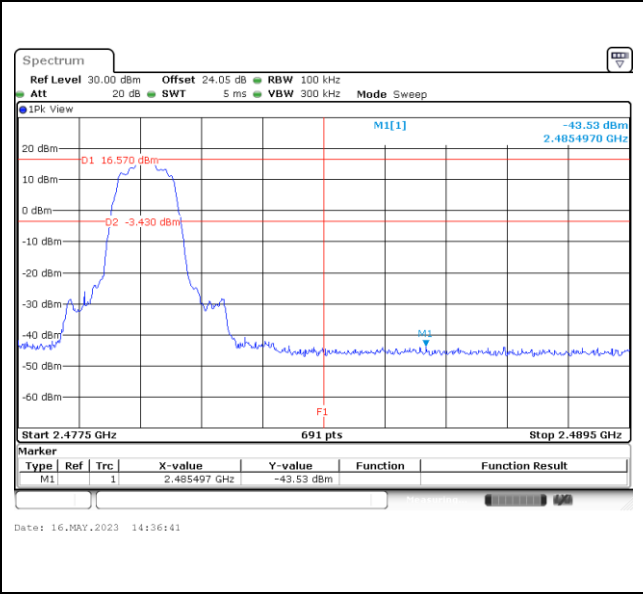
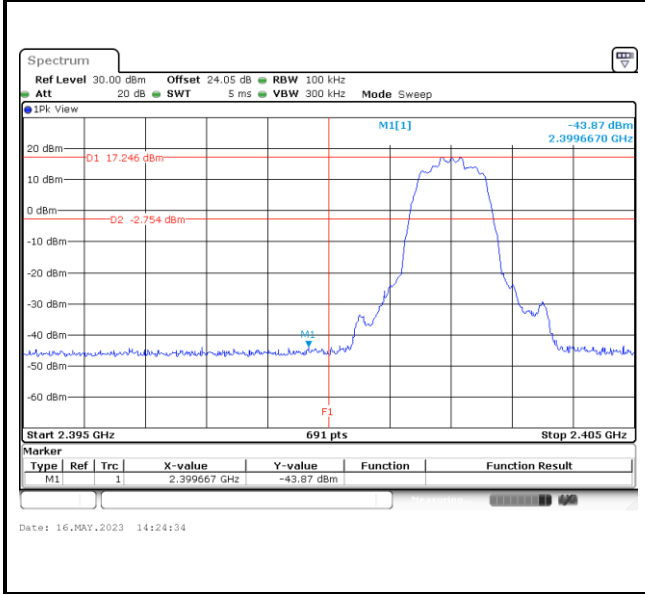



# Hopping Mode Band Edges

<1Mbps>

### Hopping Mode Low Band Edge Plot

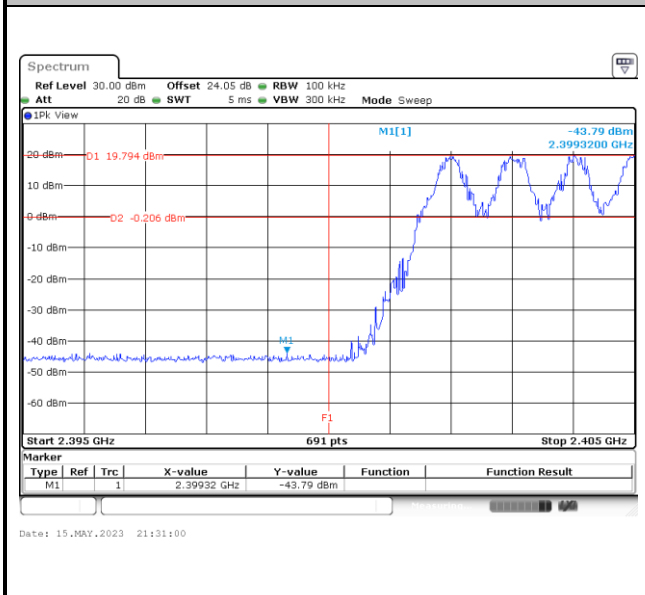

### Hopping Mode High Band Edge Plot

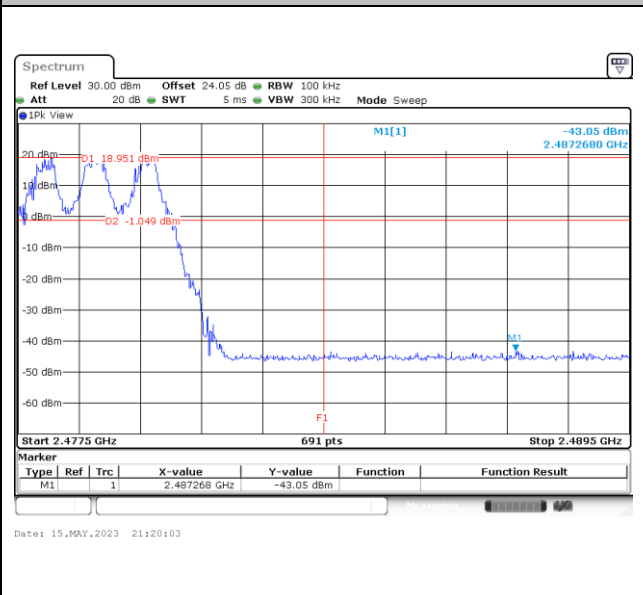

<2Mbps>

### Hopping Mode Low Band Edge Plot

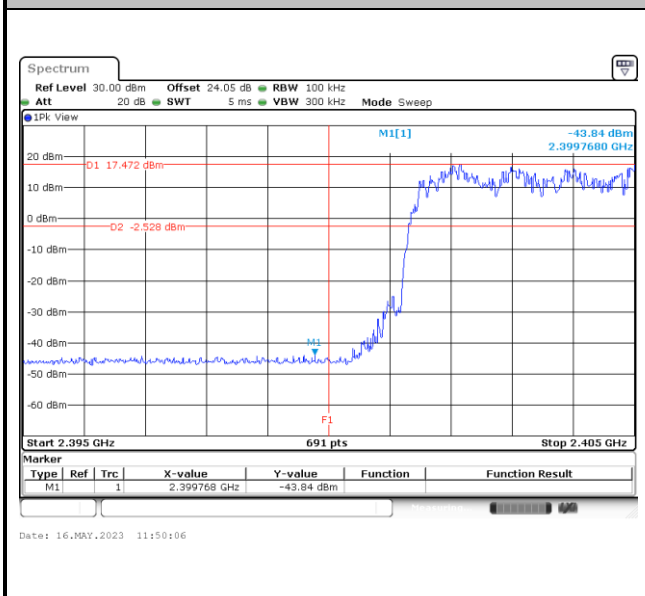

### Hopping Mode High Band Edge Plot

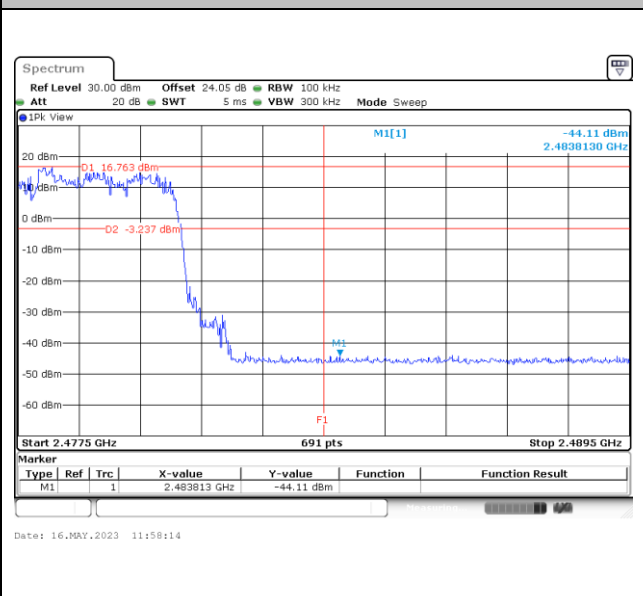



<3Mbps>

Hopping Mode Low Band Edge Plot

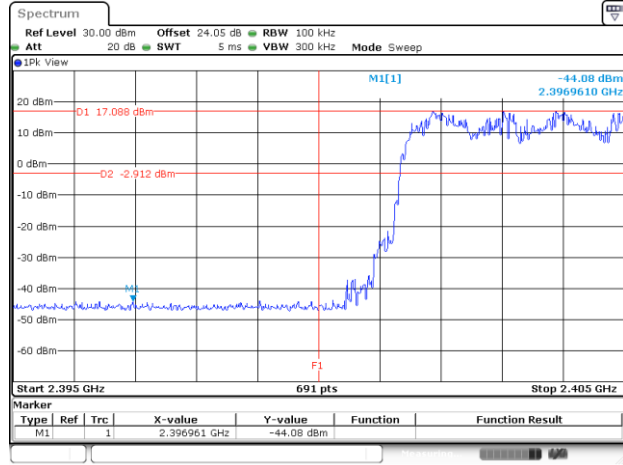

Hopping Mode High Band Edge Plot

