

5G NR n71 ADJACENT CHANNEL POWER

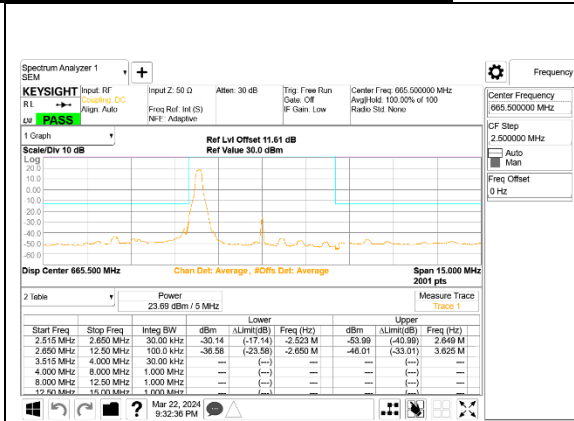

5G NR n71 5MHz BPSK Low Channel RB1-0, ID:19210

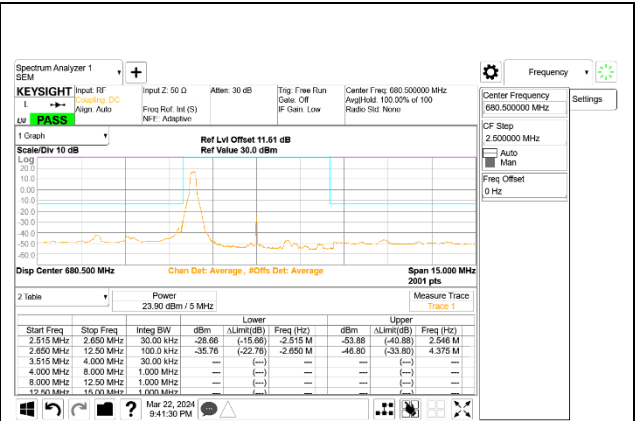

5G NR n71 5MHz BPSK Middle Channel RB1-0, ID:19210

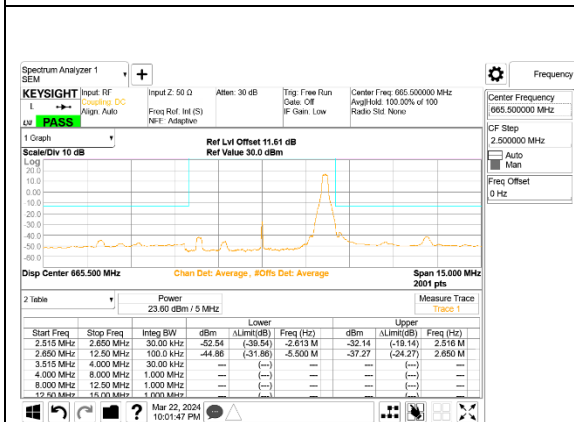

5G NR n71 5MHz BPSK Low Channel RB1-24, ID:19210

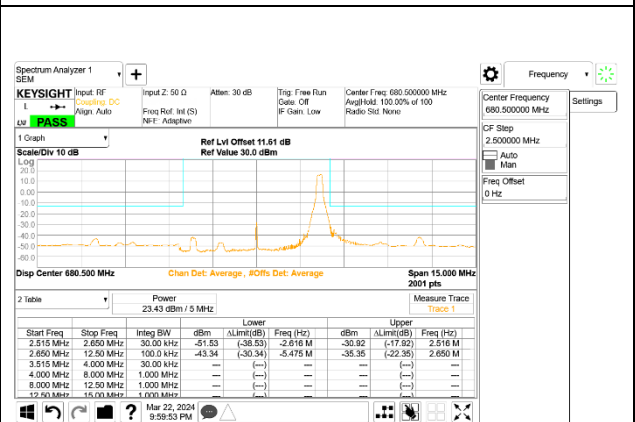

5G NR n71 5MHz BPSK Middle Channel RB1-24, ID:19210

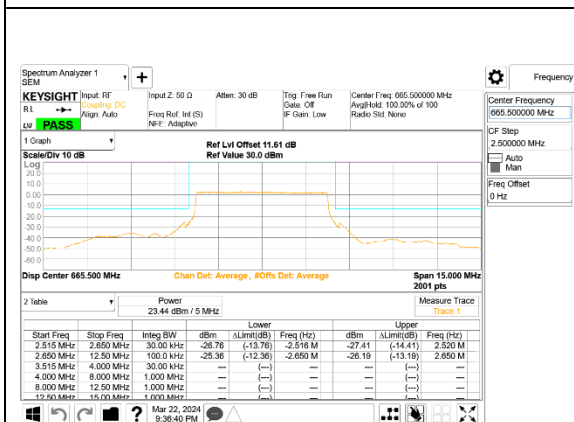

5G NR n71 5MHz BPSK Low Channel RB25-0, ID:19210

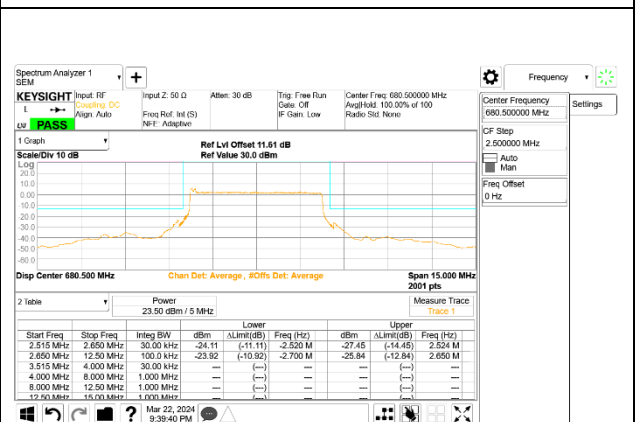

5G NR n71 5MHz BPSK Middle Channel RB25-0, ID:19210

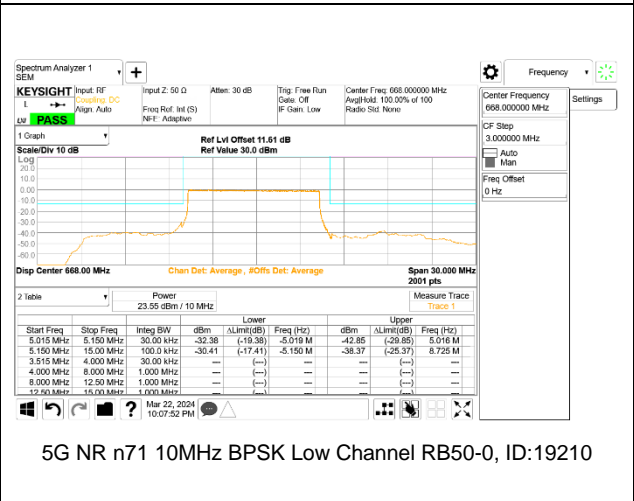
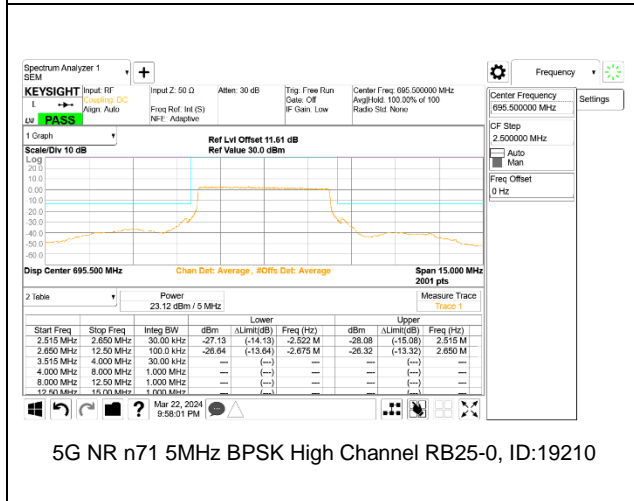
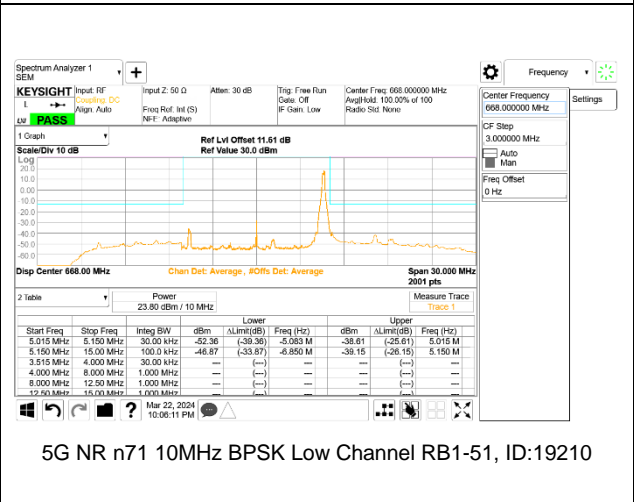
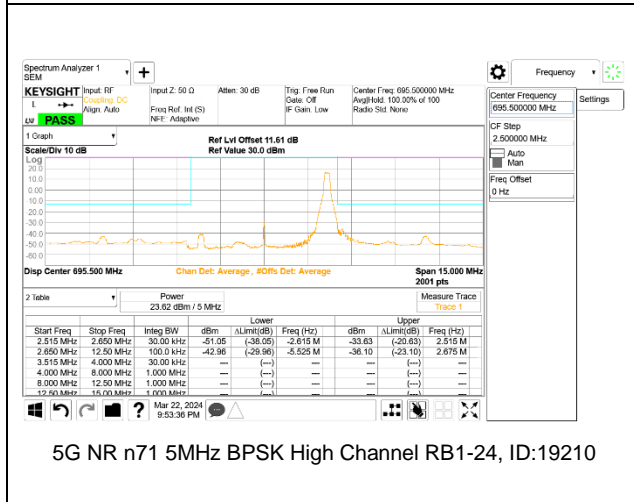
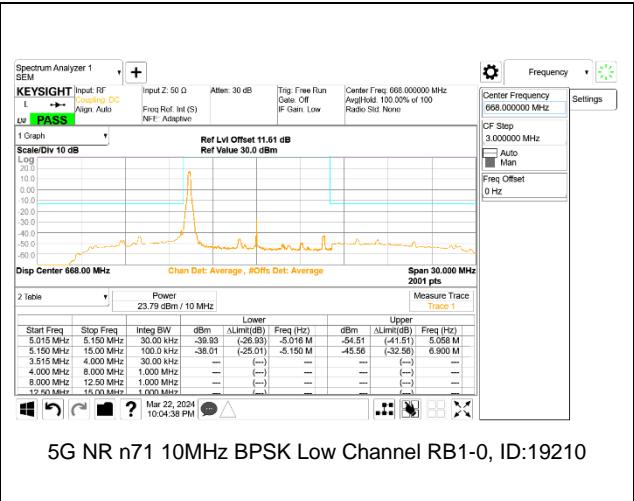
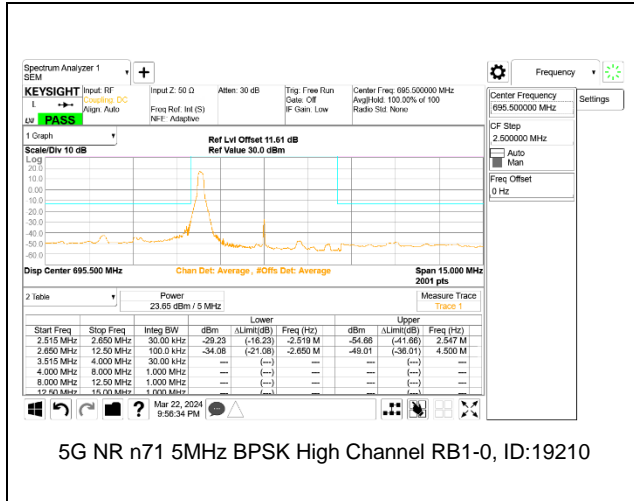

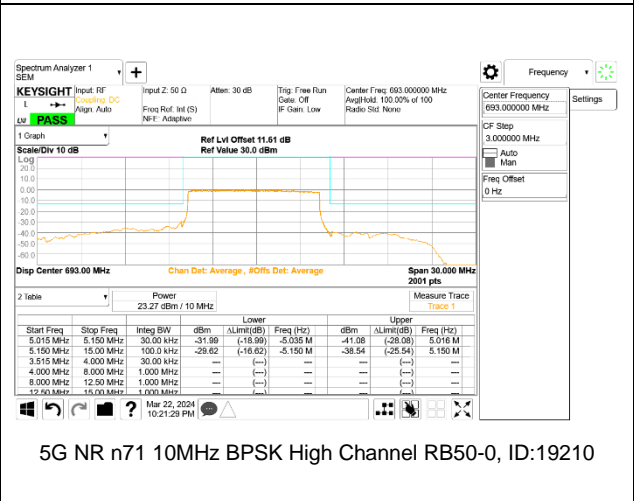
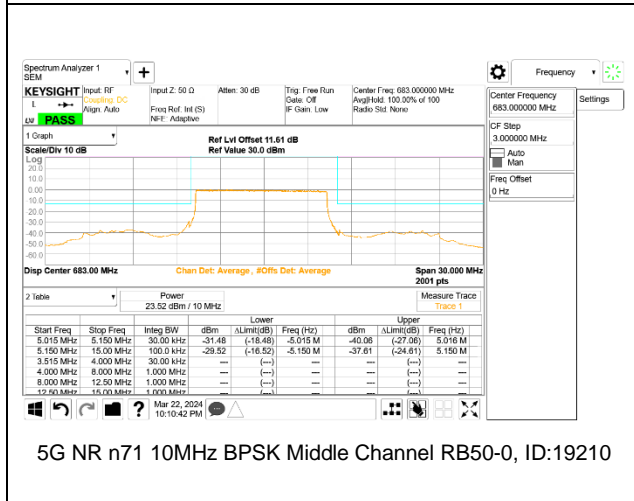
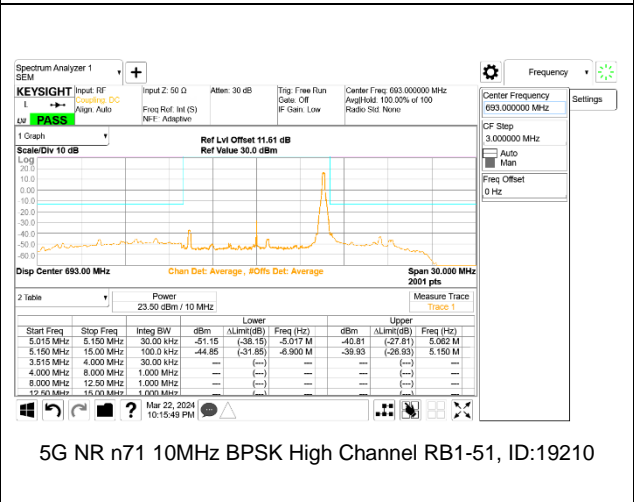
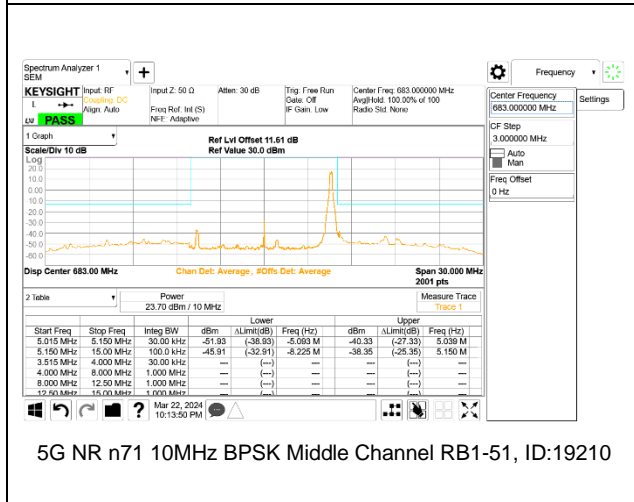
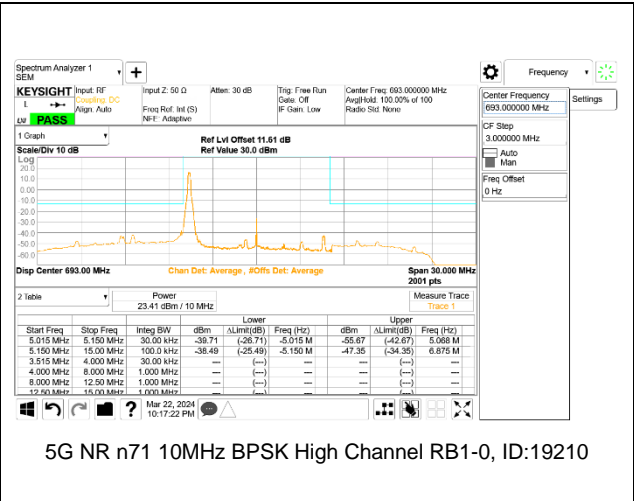
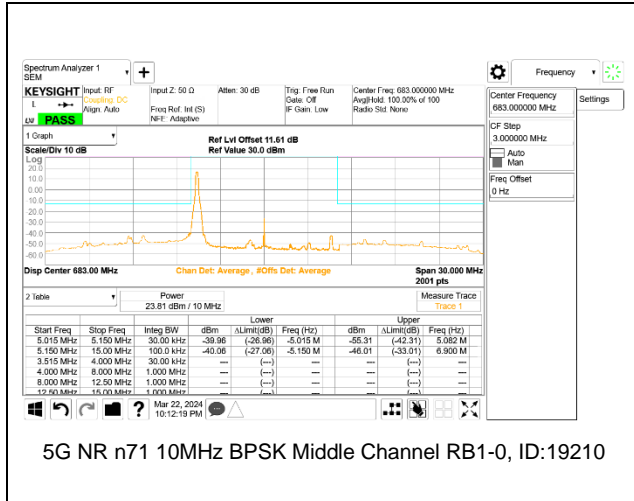

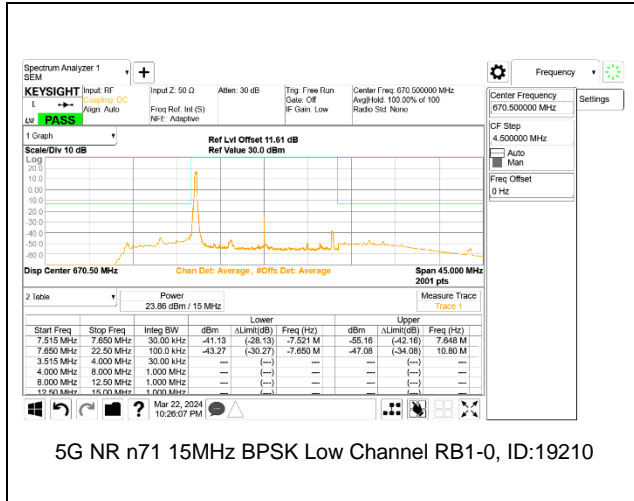

5G NR n71 15MHz BPSK Low Channel RB1-0, ID:19210

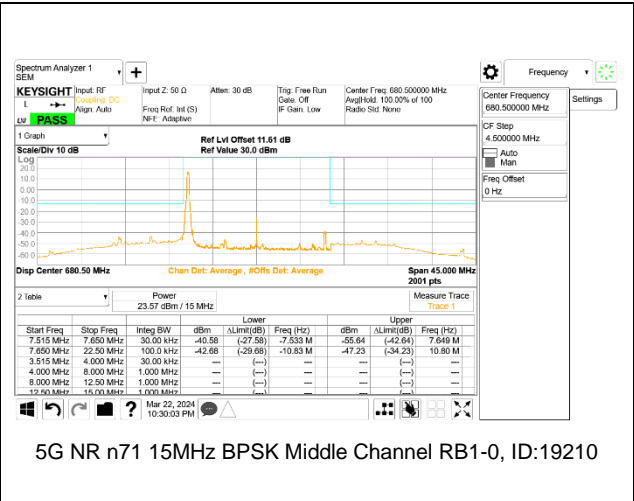

5G NR n71 15MHz BPSK Middle Channel RB1-0, ID:19210

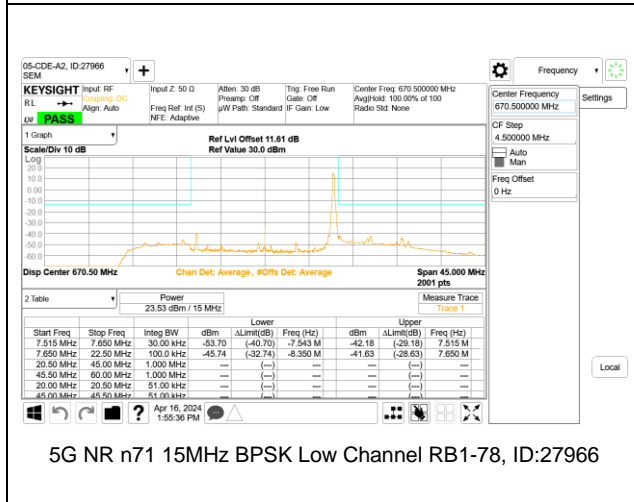

5G NR n71 15MHz BPSK Low Channel RB1-78, ID:27966

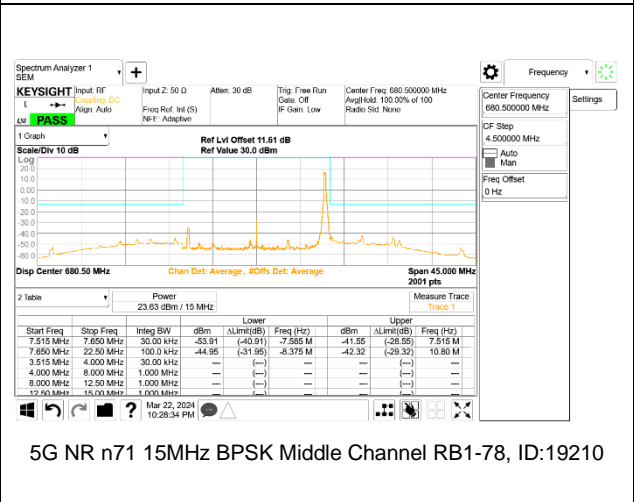

5G NR n71 15MHz BPSK Middle Channel RB1-78, ID:19210

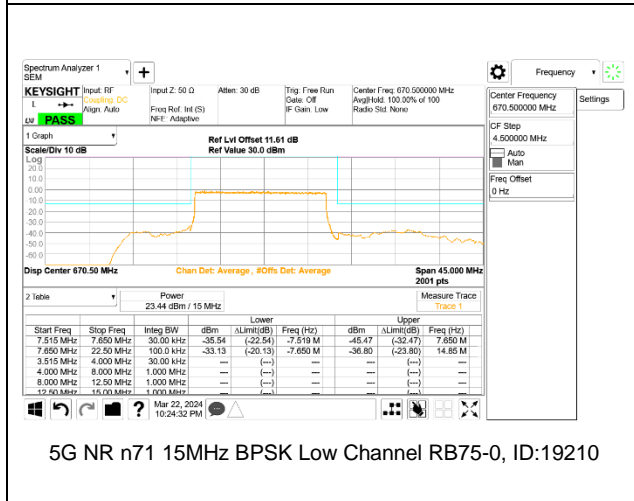

5G NR n71 15MHz BPSK Low Channel RB75-0, ID:19210

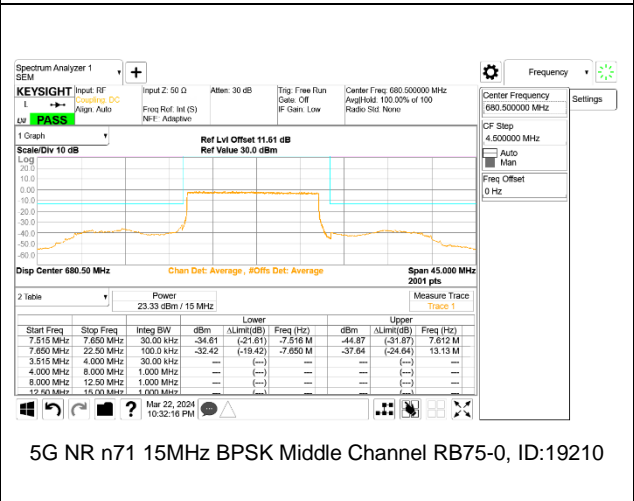

5G NR n71 15MHz BPSK Middle Channel RB75-0, ID:19210

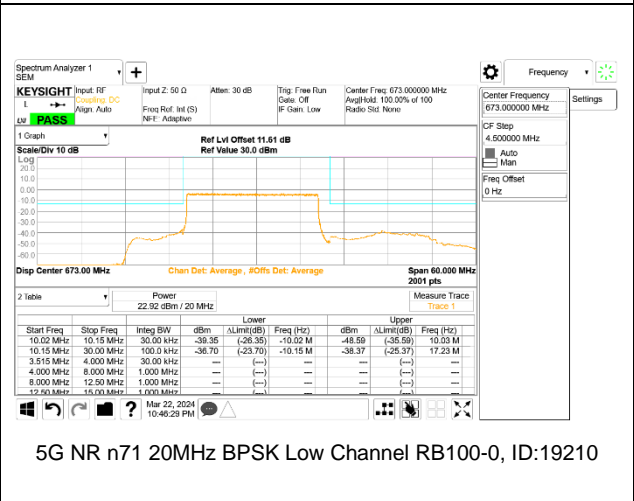
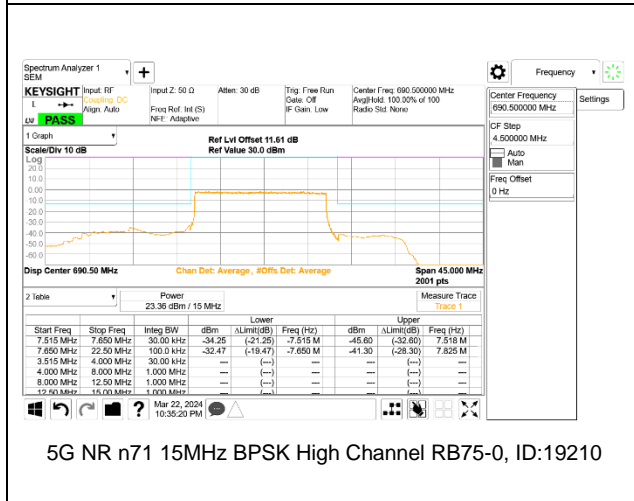
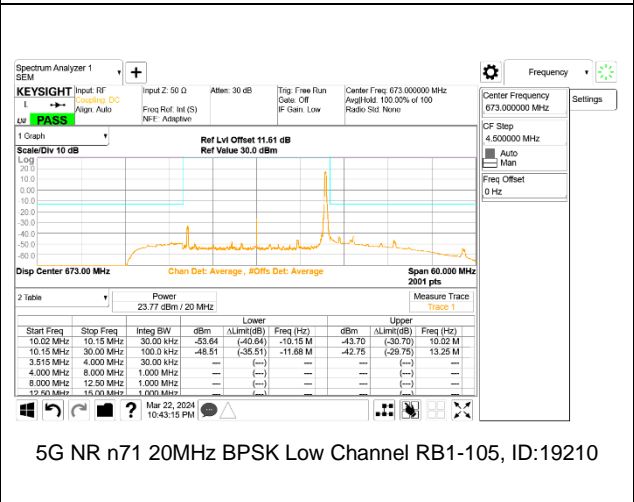
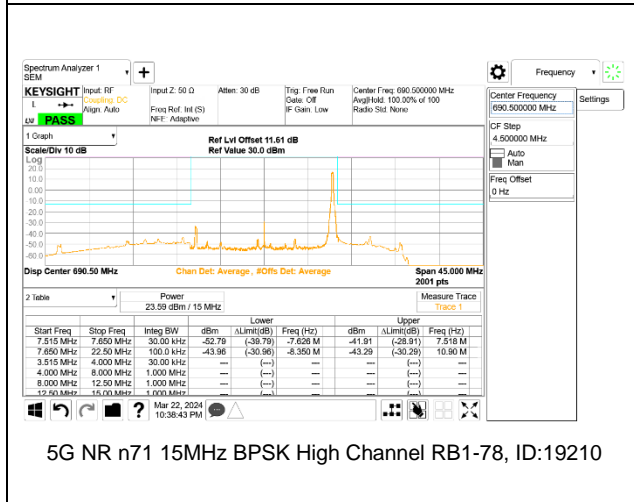
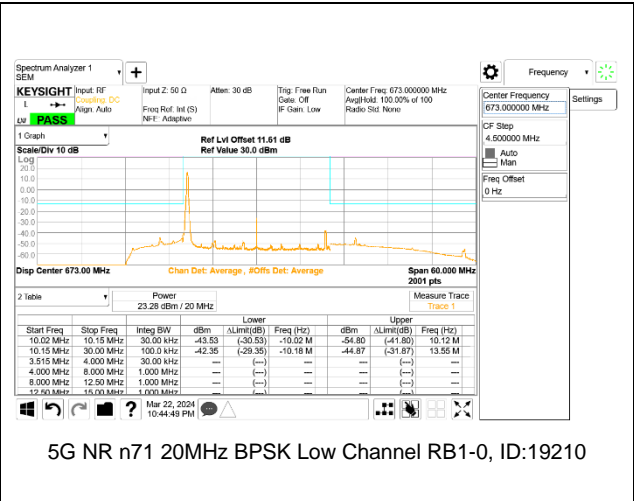
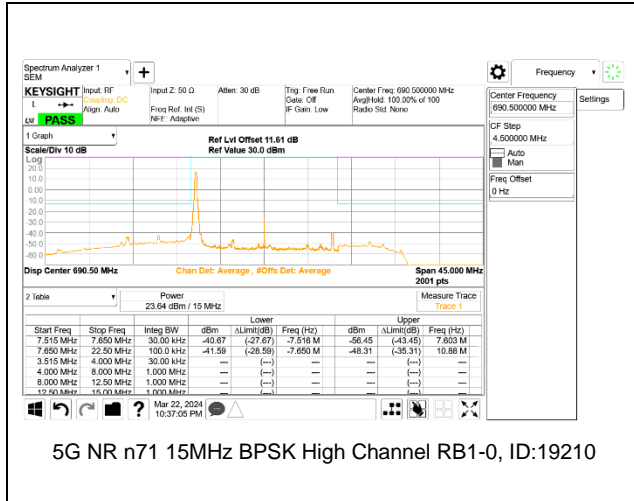

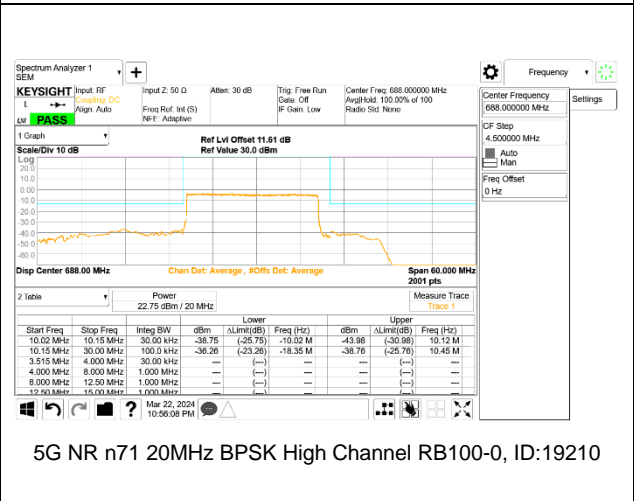
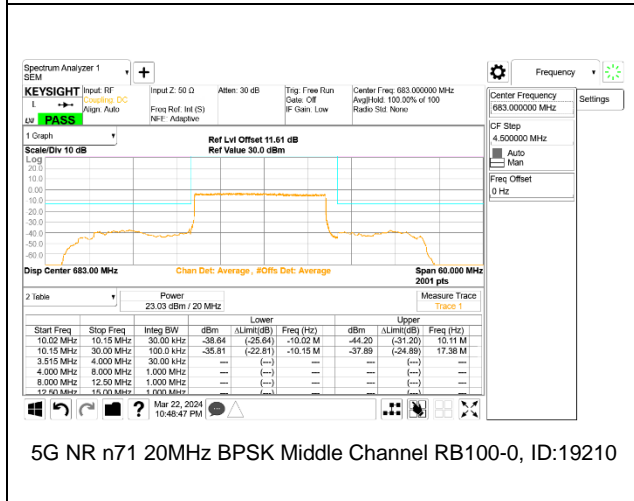
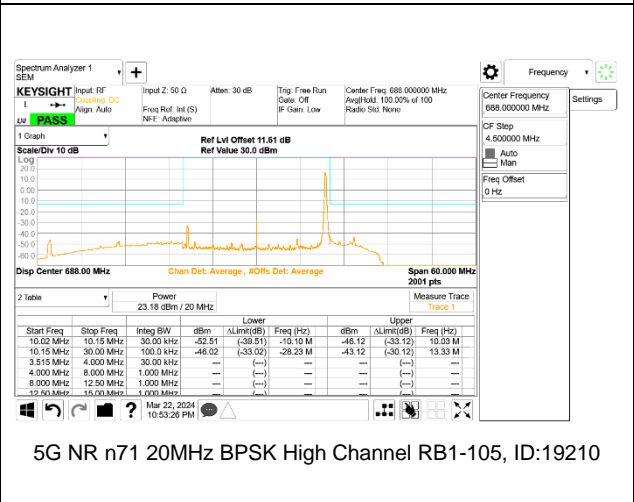
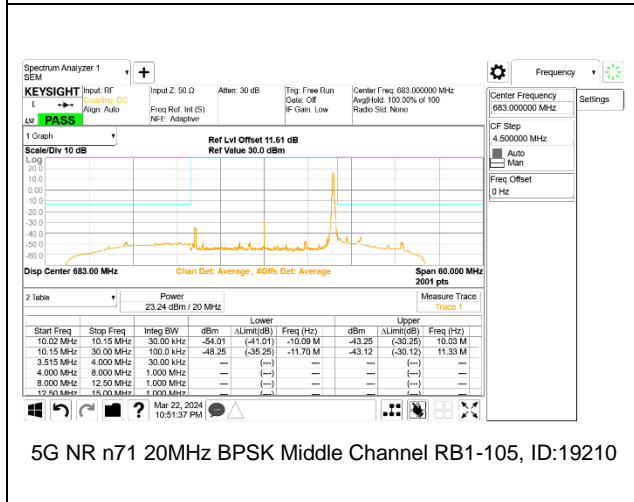
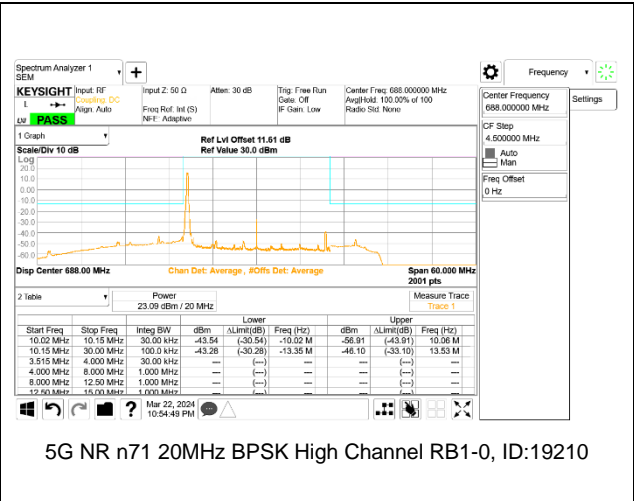
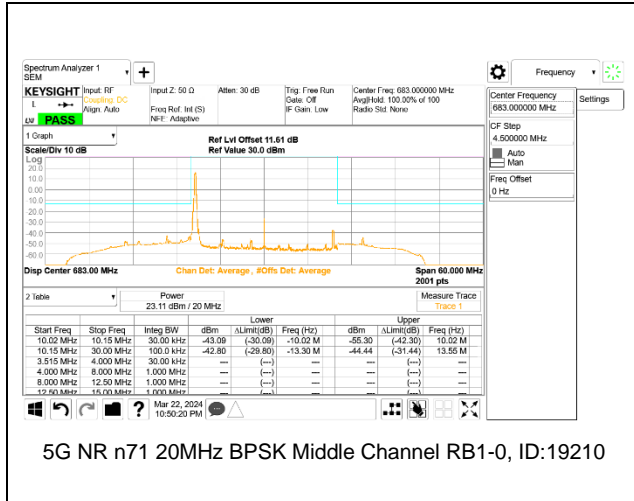



## 9.2.16. 5G NR n77 (FCC Part 27 3450-3550MHz) HPUE

### LIMITS

FCC: §27.53

(n) 3.45 GHz Service. The following emission limits apply to stations transmitting in the 3450-3550 MHz band:

(2) For mobile operations in the 3450-3550 MHz band, the conducted power of any emission outside the licensee's authorized bandwidth shall not exceed -13 dBm/MHz. Compliance with this paragraph (n)(2) is based on the use of measurement instrumentation employing a resolution bandwidth of 1 megahertz or greater. However, in the 1 megahertz bands immediately outside and adjacent to the licensee's frequency block, a resolution bandwidth of at least one percent of the emission bandwidth of the fundamental emission of the transmitter may be employed, but limited to a maximum of 200 kHz. In the bands between 1 and 5 MHz removed from the licensee's frequency block, the minimum resolution bandwidth for the measurement shall be 500 kHz. The emission bandwidth is defined as the width of the signal between two points, one below the carrier center frequency and one above the carrier center frequency, outside of which all emissions are attenuated at least 26 dB below the transmitter power.

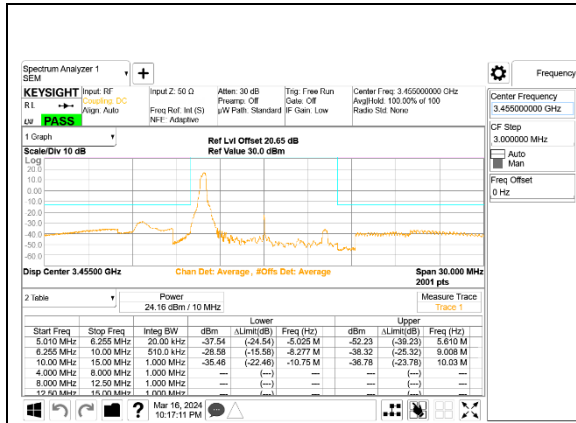

5G NR n77 10MHz BPSK Low Channel RB1-0, ID:28498

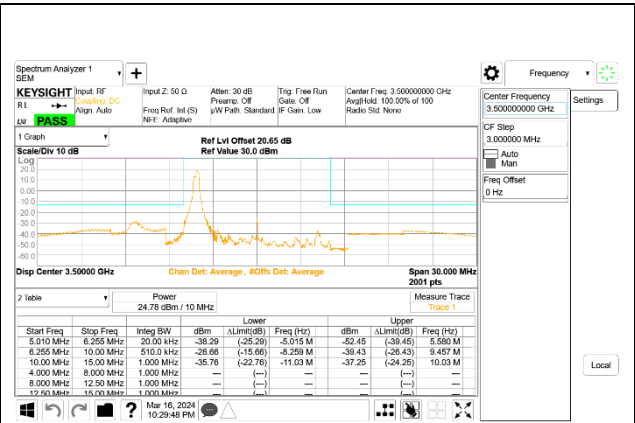

5G NR n77 10MHz BPSK Middle Channel RB1-0, ID:28498

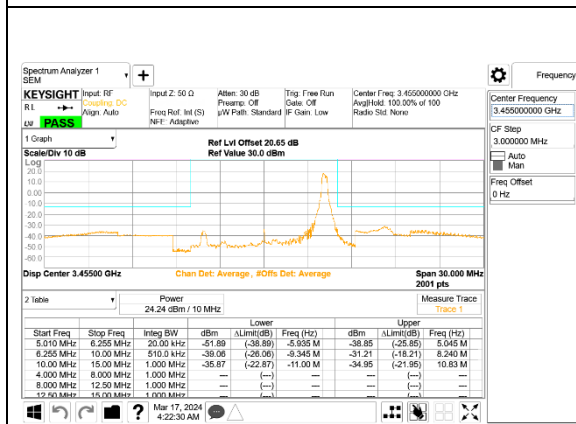

5G NR n77 10MHz BPSK Low Channel RB1-23, ID:28498

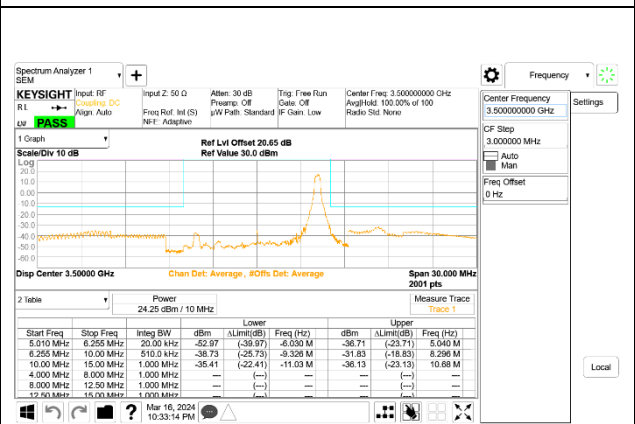

5G NR n77 10MHz BPSK Middle Channel RB1-23, ID:28498

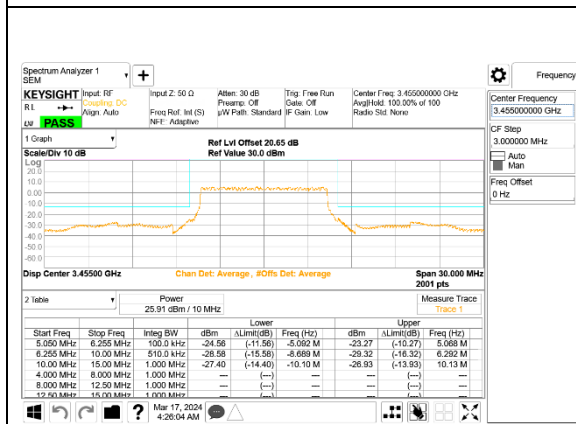

5G NR n77 10MHz BPSK Low Channel RB24-0, ID:28498

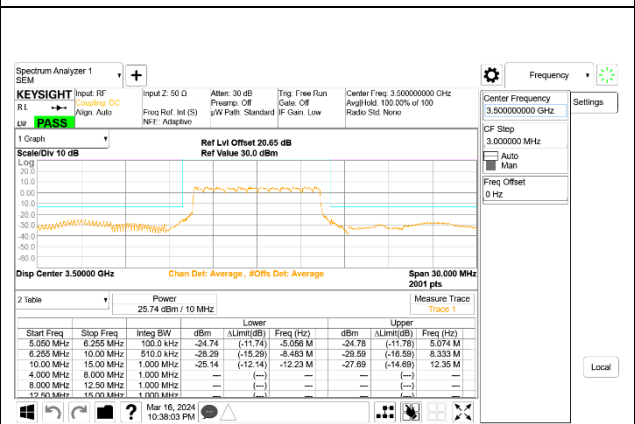

5G NR n77 10MHz BPSK Middle Channel RB24-0, ID:28498

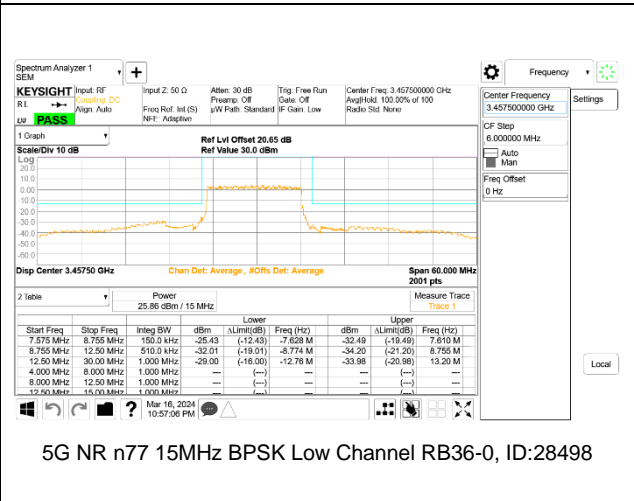
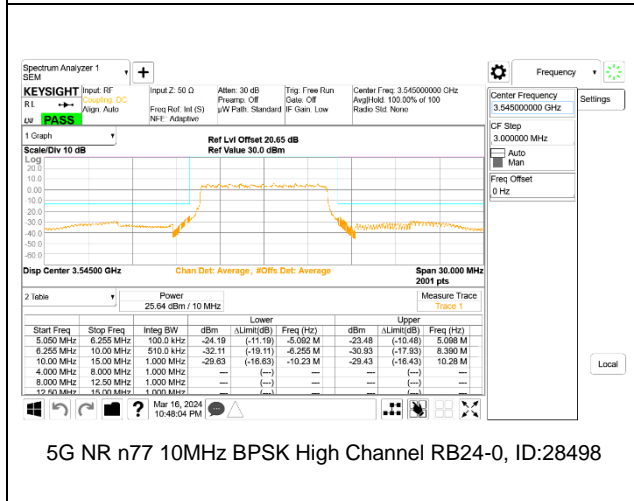
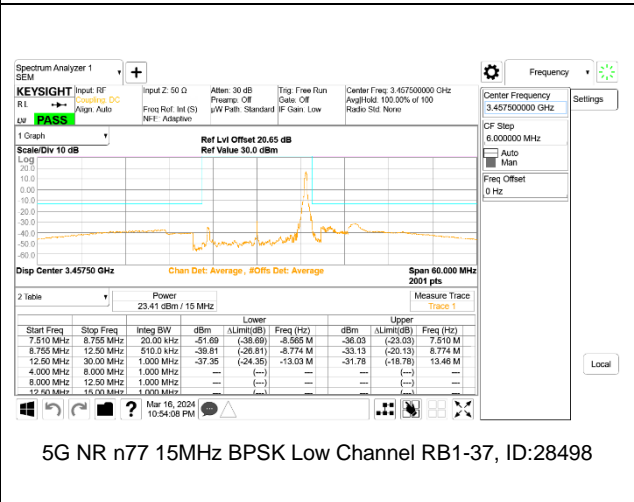
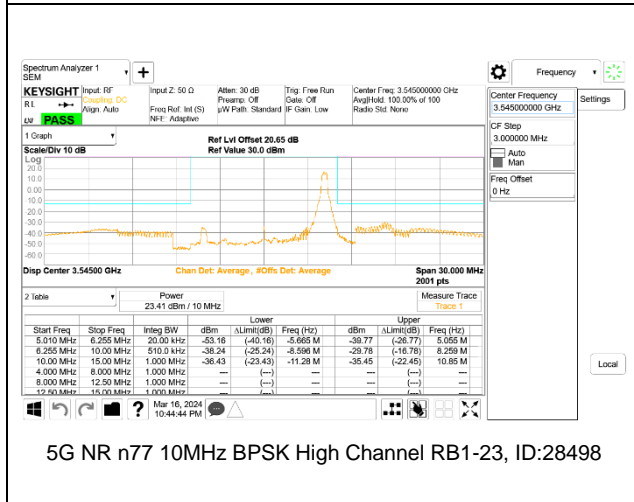
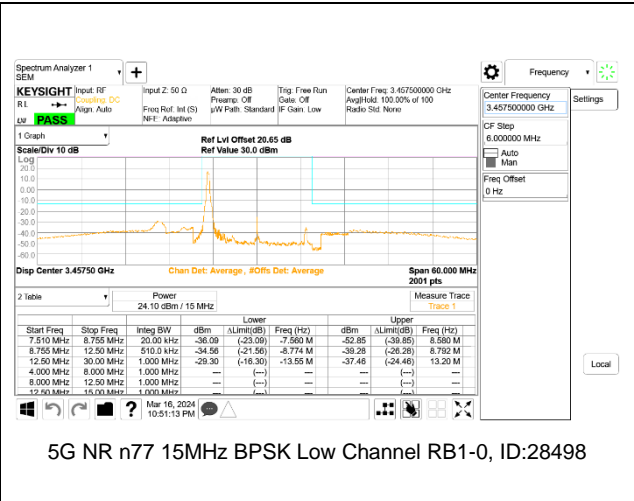
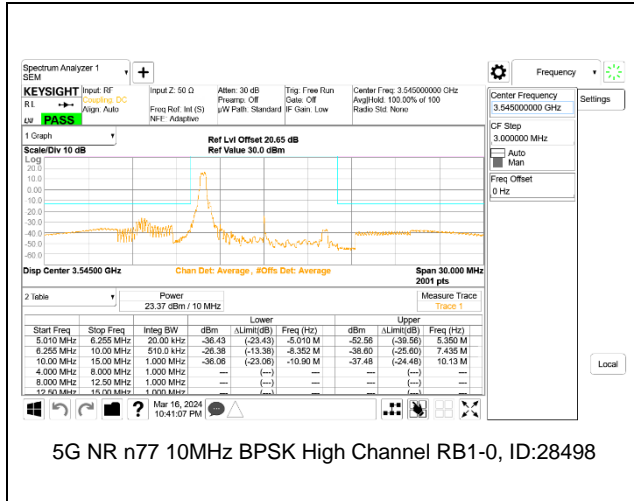

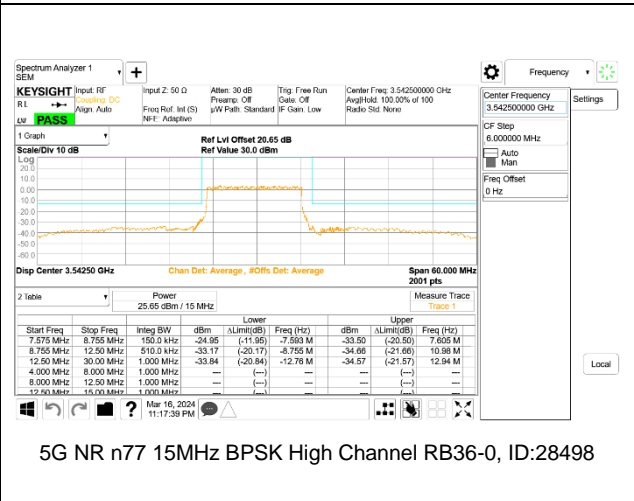
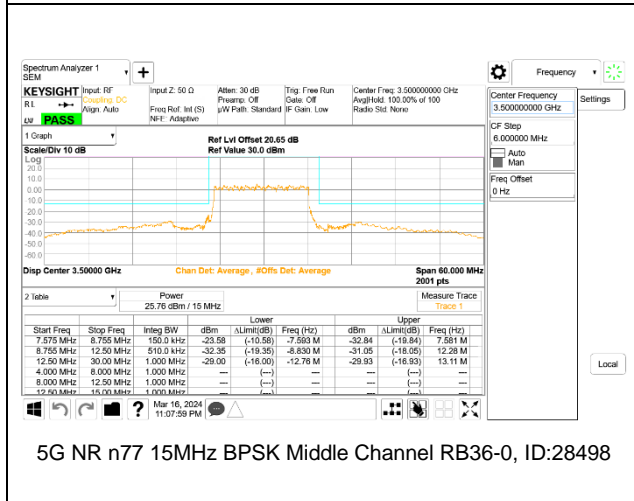
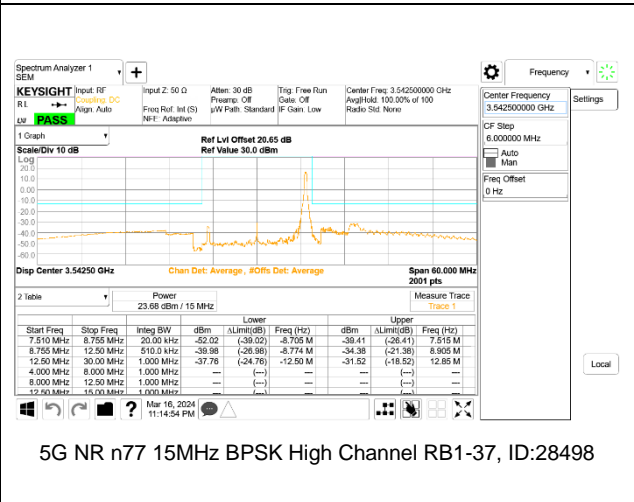
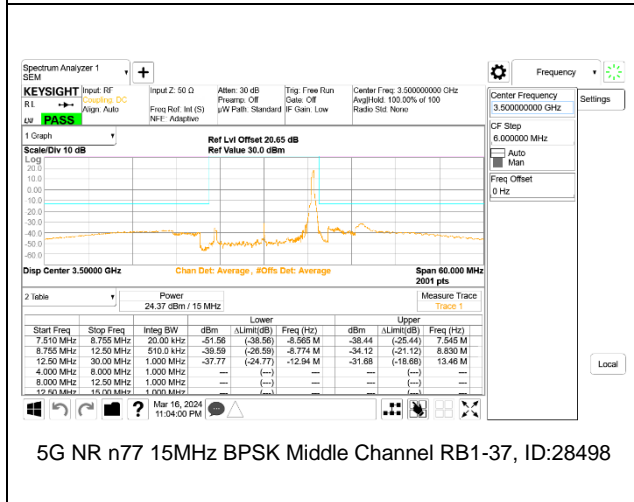
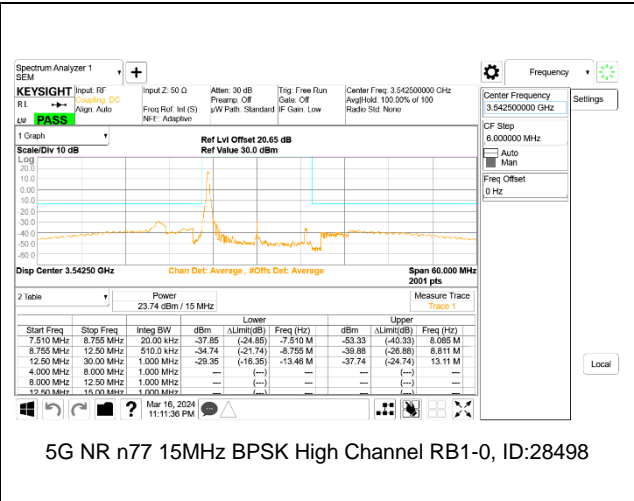
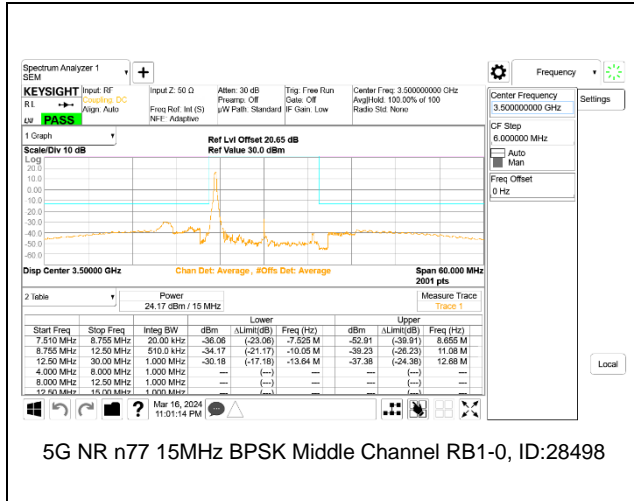

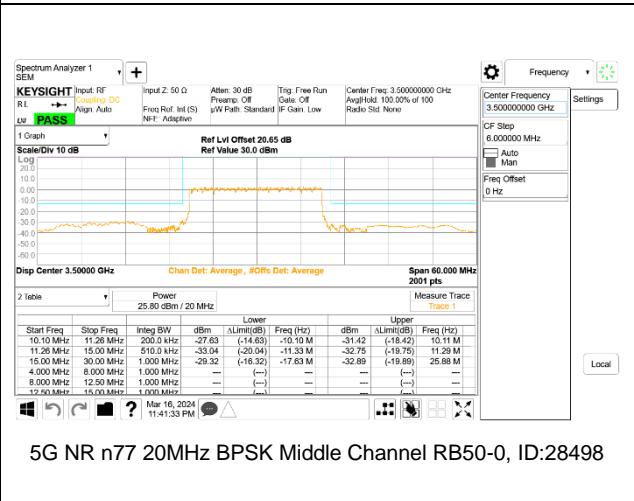
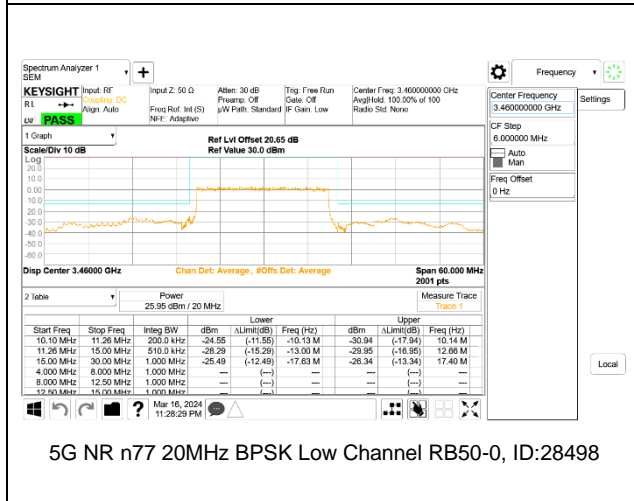
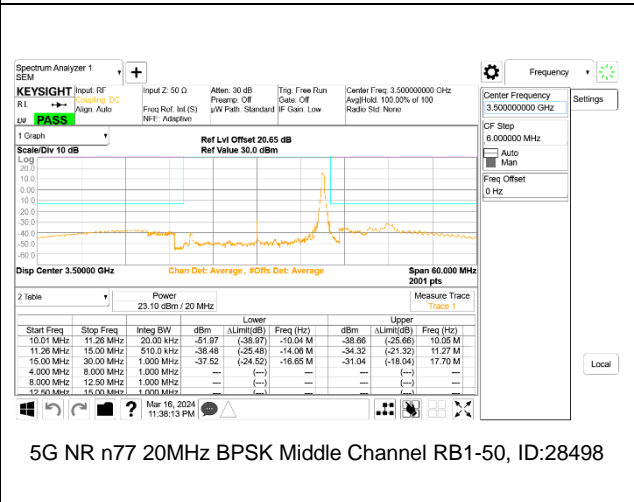
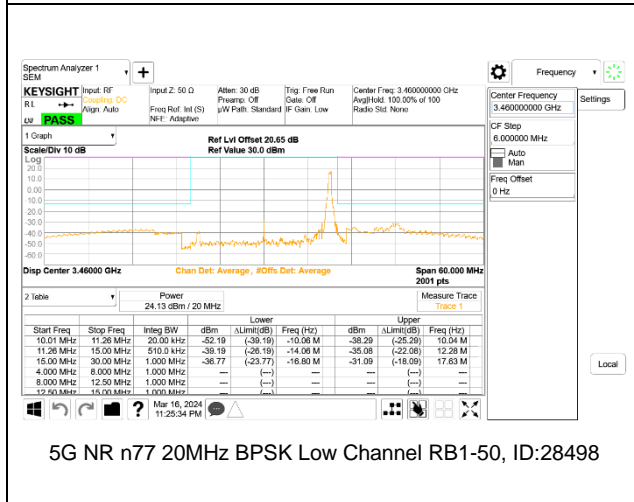
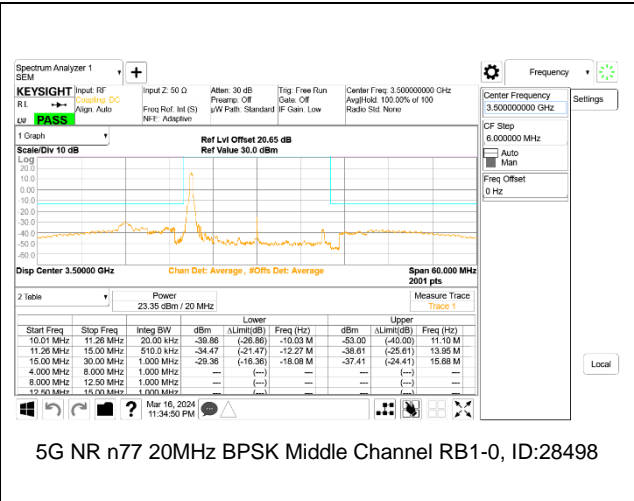
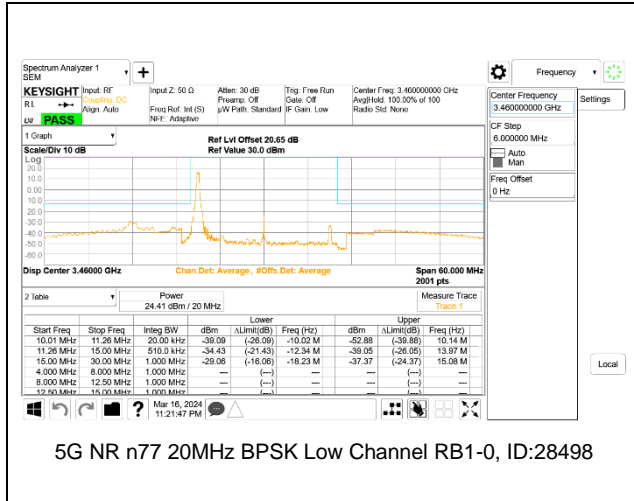

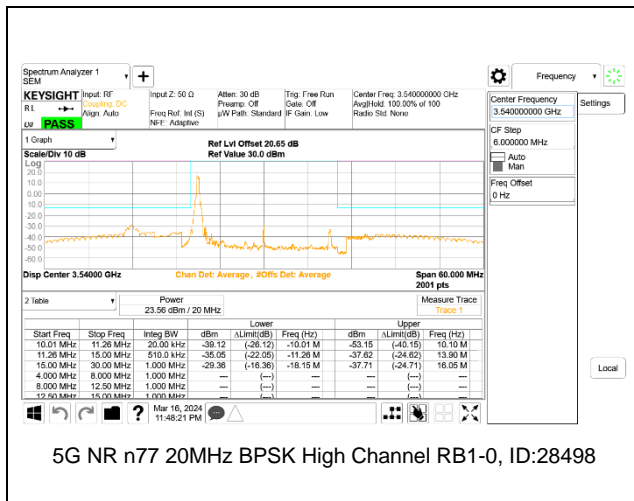

5G NR n77 20MHz BPSK High Channel RB1-0, ID:28498

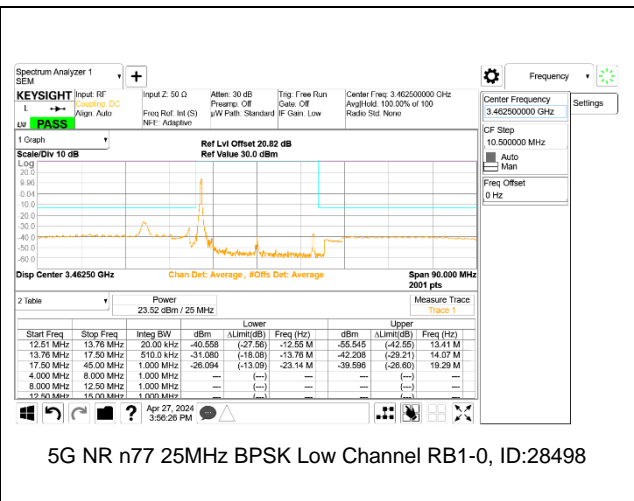

5G NR n77 25MHz BPSK Low Channel RB1-0, ID:28498

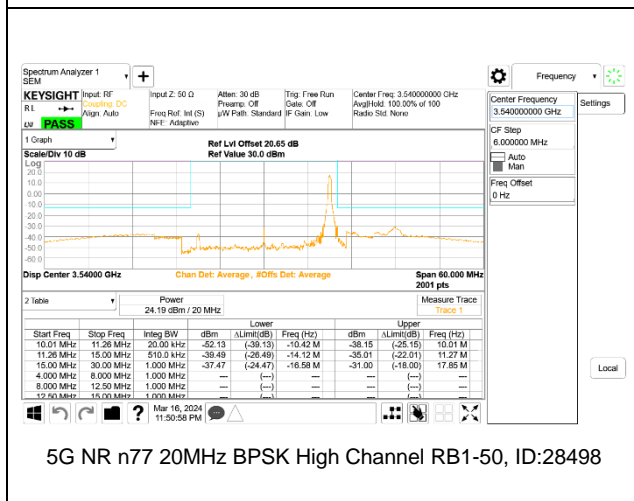

5G NR n77 20MHz BPSK High Channel RB1-50, ID:28498

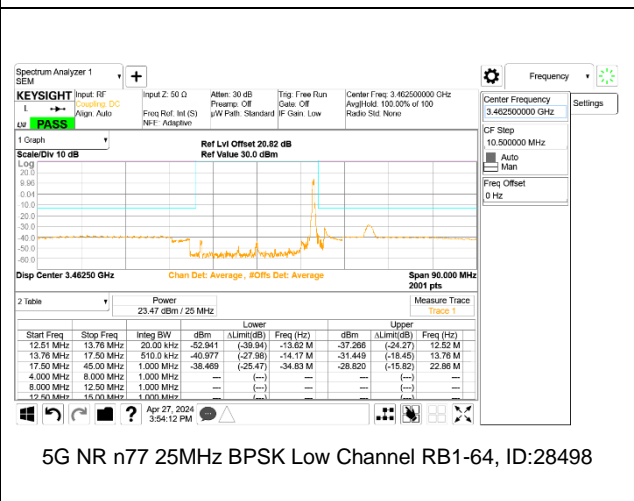

5G NR n77 25MHz BPSK Low Channel RB1-64, ID:28498

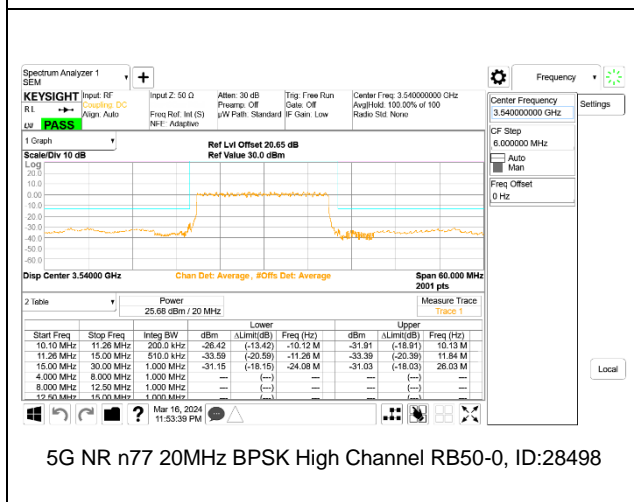

5G NR n77 20MHz BPSK High Channel RB50-0, ID:28498

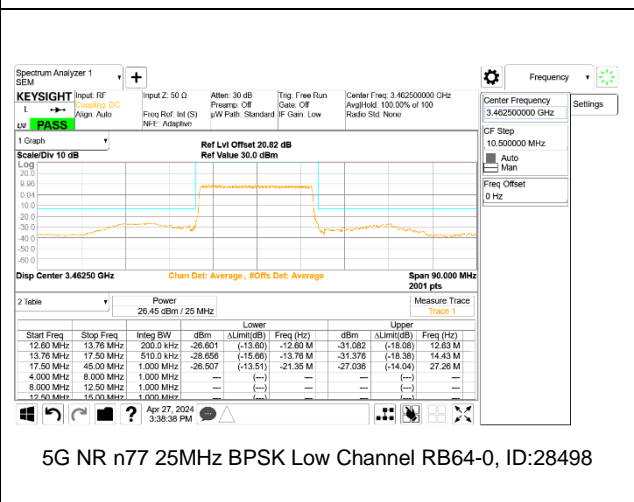

5G NR n77 25MHz BPSK Low Channel RB64-0, ID:28498