



FCC RADIO TEST REPORT

FCC ID : A4RGWKK3
Equipment : Phone
Applicant : Google LLC
1600 Amphitheatre Parkway,
Mountain View, California, 94043 USA
Standard : FCC Part 15 Subpart C §15.247

The product was received on Aug. 05, 2022 and testing was performed from Sep. 15, 2022 to Oct. 05, 2022. We, Sporton International Inc. Wensan Laboratory, would like to declare that the tested sample has been evaluated in accordance with the test procedures and has been in compliance with the applicable technical standards.

The test results in this report apply exclusively to the tested model / sample. Without written approval from Sporton International Inc. Wensan Laboratory, the test report shall not be reproduced except in full.

Approved by: Louis Wu

Sporton International Inc. Wensan Laboratory

No.58, Aly. 75, Ln. 564, Wenhua 3rd, Rd., Guishan Dist., Taoyuan City 333010, Taiwan (R.O.C.)



Table of Contents

History of this test report.....	3
Summary of Test Result.....	4
1 General Description.....	5
1.1 Product Feature of Equipment Under Test.....	5
1.2 Product Specification of Equipment Under Test.....	6
1.3 Modification of EUT	6
1.4 Testing Location	7
1.5 Applicable Standards.....	7
2 Test Configuration of Equipment Under Test.....	8
2.1 Carrier Frequency Channel	8
2.2 Test Mode.....	9
2.3 Connection Diagram of Test System.....	10
2.4 Support Unit used in test configuration and system	12
2.5 EUT Operation Test Setup	12
2.6 Measurement Results Explanation Example.....	12
3 Test Result.....	13
3.1 Number of Channel Measurement	13
3.2 Hopping Channel Separation Measurement	16
3.3 Dwell Time Measurement.....	23
3.4 20dB and 99% Bandwidth Measurement	26
3.5 Output Power Measurement.....	39
3.6 Conducted Band Edges Measurement.....	40
3.7 Conducted Spurious Emission Measurement	49
3.8 Radiated Band Edges and Spurious Emission Measurement	62
3.9 AC Conducted Emission Measurement.....	66
3.10 Antenna Requirements.....	68
4 List of Measuring Equipment	69
5 Uncertainty of Evaluation.....	71
Appendix A. Conducted Test Results	
Appendix B. AC Conducted Emission Test Result	
Appendix C. Radiated Spurious Emission	
Appendix D. Radiated Spurious Emission Plots	
Appendix E. Duty Cycle Plots	
Appendix F. Setup Photographs	



History of this test report

Report No.	Version	Description	Issue Date
FR280208-01A	01	Initial issue of report	Nov. 29, 2022
FR280208-01A	02	Revise description for section 2.2	Dec. 13, 2022



Summary of Test Result

Report Clause	Ref Std. Clause	Test Items	Result (PASS/FAIL)	Remark
3.1	15.247(a)(1)	Number of Channels	Pass	-
3.2	15.247(a)(1)	Hopping Channel Separation	Pass	-
3.3	15.247(a)(1)	Dwell Time of Each Channel	Pass	-
3.4	15.247(a)(1)	20dB Bandwidth	Pass	-
3.4	2.1049	99% Occupied Bandwidth	Reporting only	-
3.5	15.247(b)(1) 15.247(b)(4)	Peak Output Power	Pass	-
3.6	15.247(d)	Conducted Band Edges	Pass	-
3.7	15.247(d)	Conducted Spurious Emission	Pass	-
3.8	15.247(d)	Radiated Band Edges and Radiated Spurious Emission	Pass	6.29 dB under the limit at 2483.520 MHz
3.9	15.207	AC Conducted Emission	Pass	15.38 dB under the limit at 1.411 MHz
3.10	15.203	Antenna Requirement	Pass	-

Declaration of Conformity:

- The test results (PASS/FAIL) with all measurement uncertainty excluded are presented in accordance with the regulation limits or requirements declared by manufacturers.
It's means measurement values may risk exceeding the limit of regulation standards, if measurement uncertainty is include in test results.
- The measurement uncertainty please refer to report "Uncertainty of Evaluation".

Comments and Explanations:

The product specifications of the EUT presented in the report are declared by the manufacturer who shall take full responsibility for the authenticity.

Reviewed by: William Chen
Report Producer: Doris Chen



1 General Description

1.1 Product Feature of Equipment Under Test

Product Feature	
Equipment	Phone
FCC ID	A4RGWKK3
EUT supports Radios application	GSM/EGPRS/WCDMA/HSPA/LTE/5G NR/ NFC/GNSS/ WPT Client WLAN 11b/g/n HT20 WLAN 11a/n HT20/HT40 WLAN 11ac VHT20/VHT40/VHT80 WLAN 11ax HE20/HE40/HE80 Bluetooth BR/EDR/LE

Remark: The above EUT's information was declared by manufacturer.

EUT Information List	
S/N	Performed Test Item
27211FQHN00170	RF Conducted Measurement
28251FQHN00017	Radiated Spurious Emission
28251FQHN00005	Conducted Emission



1.2 Product Specification of Equipment Under Test

Product Specification is subject to this standard	
Tx/Rx Frequency Range	2402 MHz ~ 2480 MHz
Number of Channels	79
Carrier Frequency of Each Channel	2402+n*1 MHz; n=0~78
Maximum Output Power to Antenna	<p><Ant. 4> Bluetooth BR(1Mbps) : 19.18 dBm (0.0828 W) Bluetooth EDR (2Mbps) : 19.49 dBm (0.0889 W) Bluetooth EDR (3Mbps) : 19.90 dBm (0.0977 W)</p> <p><Ant. 3> Bluetooth BR(1Mbps) : 18.69 dBm (0.0740 W) Bluetooth EDR (2Mbps) : 19.18 dBm (0.0828 W) Bluetooth EDR (3Mbps) : 19.60 dBm (0.0912 W)</p>
99% Occupied Bandwidth	<p><Ant. 4> Bluetooth BR(1Mbps) : 0.805 MHz Bluetooth EDR (2Mbps) : 1.166 MHz Bluetooth EDR (3Mbps) : 1.152 MHz</p> <p><Ant. 3> Bluetooth BR(1Mbps) : 0.805 MHz Bluetooth EDR (2Mbps) : 1.166 MHz Bluetooth EDR (3Mbps) : 1.149 MHz</p>
Antenna Type / Gain	<p><Ant. 4> : ILA Antenna with gain -1.30 dBi <Ant. 3> : IFA Antenna with gain 0.80 dBi</p>
Type of Modulation	Bluetooth BR (1Mbps) : GFSK Bluetooth EDR (2Mbps) : $\pi/4$ -DQPSK Bluetooth EDR (3Mbps) : 8-DPSK

Remark: The above EUT's information was declared by manufacturer. Please refer to Comments and Explanations in report summary.

1.3 Modification of EUT

No modifications made to the EUT during the testing.



1.4 Testing Location

Test Site	Sporton International Inc. Wensan Laboratory
Test Site Location	No.58, Aly. 75, Ln. 564, Wenhua 3rd, Rd., Guishan Dist., Taoyuan City 333010, Taiwan (R.O.C.) TEL: +886-3-327-0868 FAX: +886-3-327-0855
Test Site No.	Sporton Site No.
	TH05-HY, CO07-HY, 03CH16-HY

Note: The test site complies with ANSI C63.4 2014 requirement.

FCC designation No.: TW3786

1.5 Applicable Standards

According to the specifications declared by the manufacturer, the EUT must comply with the requirements of the following standards:

- ♦ FCC Part 15 Subpart C §15.247
- ♦ FCC KDB Publication No. 558074 D01 15.247 Meas Guidance v05r02
- ♦ FCC KDB 414788 D01 Radiated Test Site v01r01
- ♦ ANSI C63.10-2013

Remark:

1. All the test items were validated and recorded in accordance with the standards without any modification during the testing.
2. The TAF code is not including all the FCC KDB listed without accreditation.
3. This EUT has also been tested and complied with the requirements of FCC Part 15, Subpart B, recorded in a separate test report.



2 Test Configuration of Equipment Under Test

2.1 Carrier Frequency Channel

Frequency Band	Channel	Freq. (MHz)	Channel	Freq. (MHz)	Channel	Freq. (MHz)
2400-2483.5 MHz	0	2402	27	2429	54	2456
	1	2403	28	2430	55	2457
	2	2404	29	2431	56	2458
	3	2405	30	2432	57	2459
	4	2406	31	2433	58	2460
	5	2407	32	2434	59	2461
	6	2408	33	2435	60	2462
	7	2409	34	2436	61	2463
	8	2410	35	2437	62	2464
	9	2411	36	2438	63	2465
	10	2412	37	2439	64	2466
	11	2413	38	2440	65	2467
	12	2414	39	2441	66	2468
	13	2415	40	2442	67	2469
	14	2416	41	2443	68	2470
	15	2417	42	2444	69	2471
	16	2418	43	2445	70	2472
	17	2419	44	2446	71	2473
	18	2420	45	2447	72	2474
	19	2421	46	2448	73	2475
	20	2422	47	2449	74	2476
	21	2423	48	2450	75	2477
	22	2424	49	2451	76	2478
	23	2425	50	2452	77	2479
	24	2426	51	2453	78	2480
	25	2427	52	2454	-	-
	26	2428	53	2455	-	-



2.2 Test Mode

- a. The EUT has been associated with peripherals and configuration operated in a manner tended to maximize its emission characteristics in a typical application. Frequency range investigated: conduction emission (150 kHz to 30 MHz), radiation emission (9 kHz to the 10th harmonic of the highest fundamental frequency or to 40 GHz, whichever is lower). For radiated measurement, the measured emission level of the EUT was maximized by rotating the EUT on a turntable, adjusting the orientation of the EUT and EUT antenna in three orthogonal axis (X: flat, Y: portrait, Z: landscape), and accessory (Adapter or Earphone) and adjusting the measurement antenna orientation, following C63.10 exploratory test procedures and only the worst plane, and the worst mode of radiated spurious emissions is Bluetooth 3Mbps mode, and recorded in this report.
- b. AC power line Conducted Emission was tested under maximum output power.

The following summary table is showing all test modes to demonstrate in compliance with the standard.

Summary table of Test Cases			
Test Item	Data Rate / Modulation		
Conducted Test Cases	Bluetooth BR 1Mbps GFSK	Bluetooth EDR 2Mbps $\pi/4$-DQPSK	Bluetooth EDR 3Mbps 8-DPSK
	Mode 1: CH00_2402 MHz	Mode 4: CH00_2402 MHz	Mode 7: CH00_2402 MHz
	Mode 2: CH39_2441 MHz	Mode 5: CH39_2441 MHz	Mode 8: CH39_2441 MHz
	Mode 3: CH78_2480 MHz	Mode 6: CH78_2480 MHz	Mode 9: CH78_2480 MHz
Radiated Test Cases	Bluetooth EDR 3Mbps 8-DPSK		
	Mode 1: CH00_2402 MHz Mode 2: CH39_2441 MHz Mode 3: CH78_2480 MHz		
AC Conducted Emission	Mode 1 :GSM850 Idle + WLAN (2.4GHz) link + Bluetooth Link + USB Cable 2 (Charging from AC Adapter 1) Mode 2 WCDMA Band II Idle + WLAN (2.4GHz) Idle + Bluetooth Link + USB Cable 2 (Charging from AC Adapter 1)		
Remark:			
<ol style="list-style-type: none"> 1. For Radiated Test Cases, the worst mode data rate 3Mbps was reported only since the highest RF output power in the preliminary tests. The conducted spurious emissions and conducted band edge measurement for other data rates were not worse than 3Mbps, and no other significantly frequencies found in conducted spurious emission. 2. The worst case of Conducted Emission is mode 2; only the test data of it was reported. 3. For Radiated Test Cases, the tests were performed with Adapter 1 and USB Cable 2. 4. During the preliminary test, both charging modes (Adapter mode and WPT client mode) were verified. It is determined that the adaptor mode is the worst case for official test. 			

2.3 Connection Diagram of Test System

<AC Conducted Emission for WLAN Link Mode>

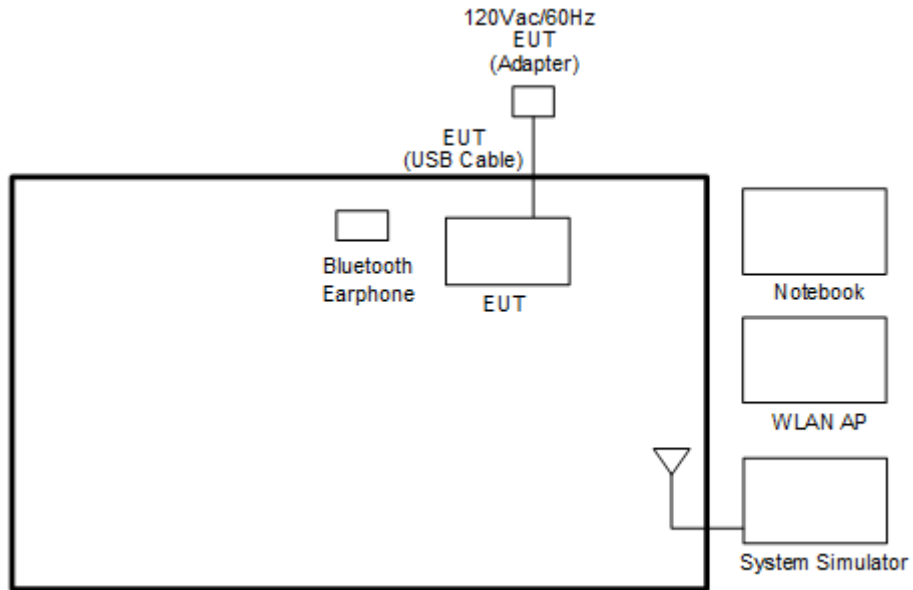

<AC Conducted Emission for WLAN Idle Mode>

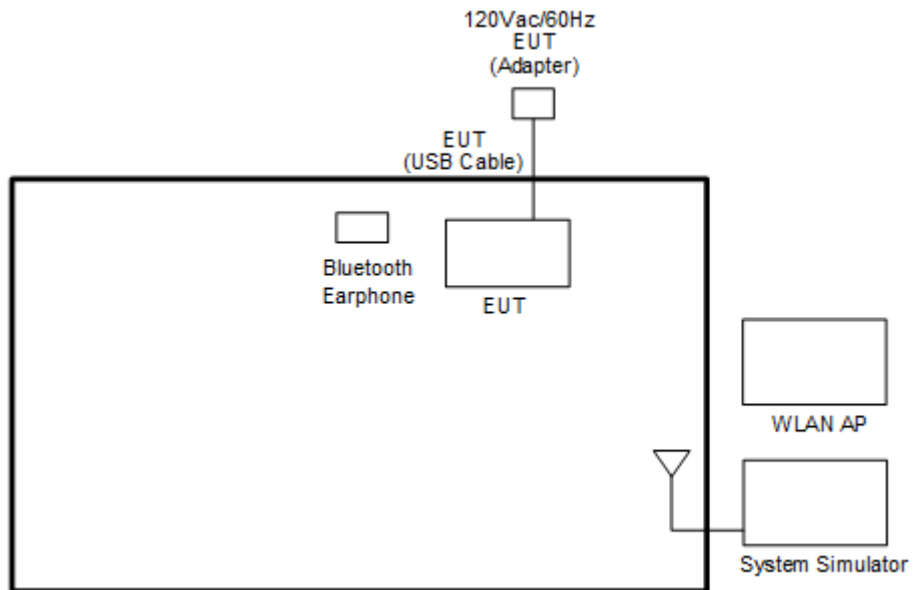

<Bluetooth Tx Mode>

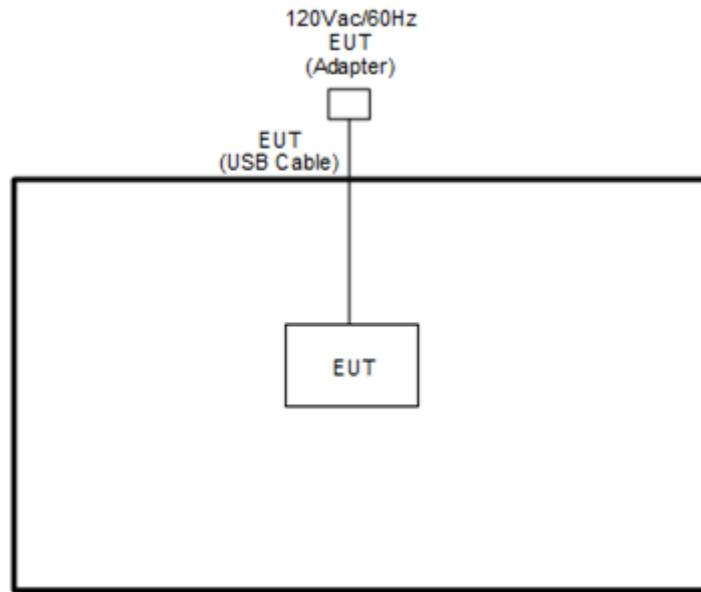

2.4 Support Unit used in test configuration and system

Item	Equipment	Brand Name	Model Name	FCC ID	Data Cable	Power Cord
1.	System Simulator	R&S	CMU 200	N/A	N/A	Unshielded, 1.8 m
2.	Bluetooth Earphone	Kinyo	BTE-3622	N/A	N/A	N/A
3.	WLAN AP	ASUS	RT-AC52	N/A	N/A	Unshielded, 1.8 m
4.	Notebook	Dell	P79G	FCC DoC	N/A	AC I/P: Unshielded, 1.2 m DC O/P: Shielded, 1.8 m

2.5 EUT Operation Test Setup

The RF test items, utility "QRCT 4.0.00195.0" was installed in Notebook which was programmed in order to make the EUT get into the engineering modes to provide channel selection, power level, data rate and the application type and for continuous transmitting signals.

2.6 Measurement Results Explanation Example

For all conducted test items:

The offset level is set in the spectrum analyzer to compensate the RF cable loss and attenuator factor between EUT conducted output port and spectrum analyzer. With the offset compensation, the spectrum analyzer reading level is exactly the EUT RF output level.

Example:

The spectrum analyzer offset is derived from RF cable loss and attenuator factor.

Offset = RF cable loss + attenuator factor.

Following shows an offset computation example with cable loss 4.2 dB and 10 dB attenuator.

$$\begin{aligned}
 \text{Offset(dB)} &= \text{RF cable loss(dB)} + \text{attenuator factor(dB)}. \\
 &= 4.2 + 10 = 14.2 \text{ (dB)}
 \end{aligned}$$

3 Test Result

3.1 Number of Channel Measurement

3.1.1 Limits of Number of Hopping Frequency

Frequency hopping systems in the 2400-2483.5 MHz band shall use at least 15 channels.

3.1.2 Measuring Instruments

Please refer to the measuring equipment list in this test report.

3.1.3 Test Procedure

1. The testing follows ANSI C63.10-2013 clause 7.8.3.
2. The RF output of EUT is connected to the spectrum analyzer by RF cable and attenuator. The path loss is compensated to the results for each measurement.
3. Set the maximum power setting and enable the EUT to transmit continuously.
4. Enable the EUT hopping function.
5. Use the following spectrum analyzer settings: Span = the frequency band of operation; RBW = 300 kHz; VBW \geq RBW; Sweep = auto; Detector function = peak; Trace = max hold.
6. The number of hopping frequency used is defined as the number of total channel.
7. Record the measurement data derived from spectrum analyzer.

3.1.4 Test Setup





3.1.5 Test Result of Number of Hopping Frequency

Please refer to Appendix A.

<Ant. 4>

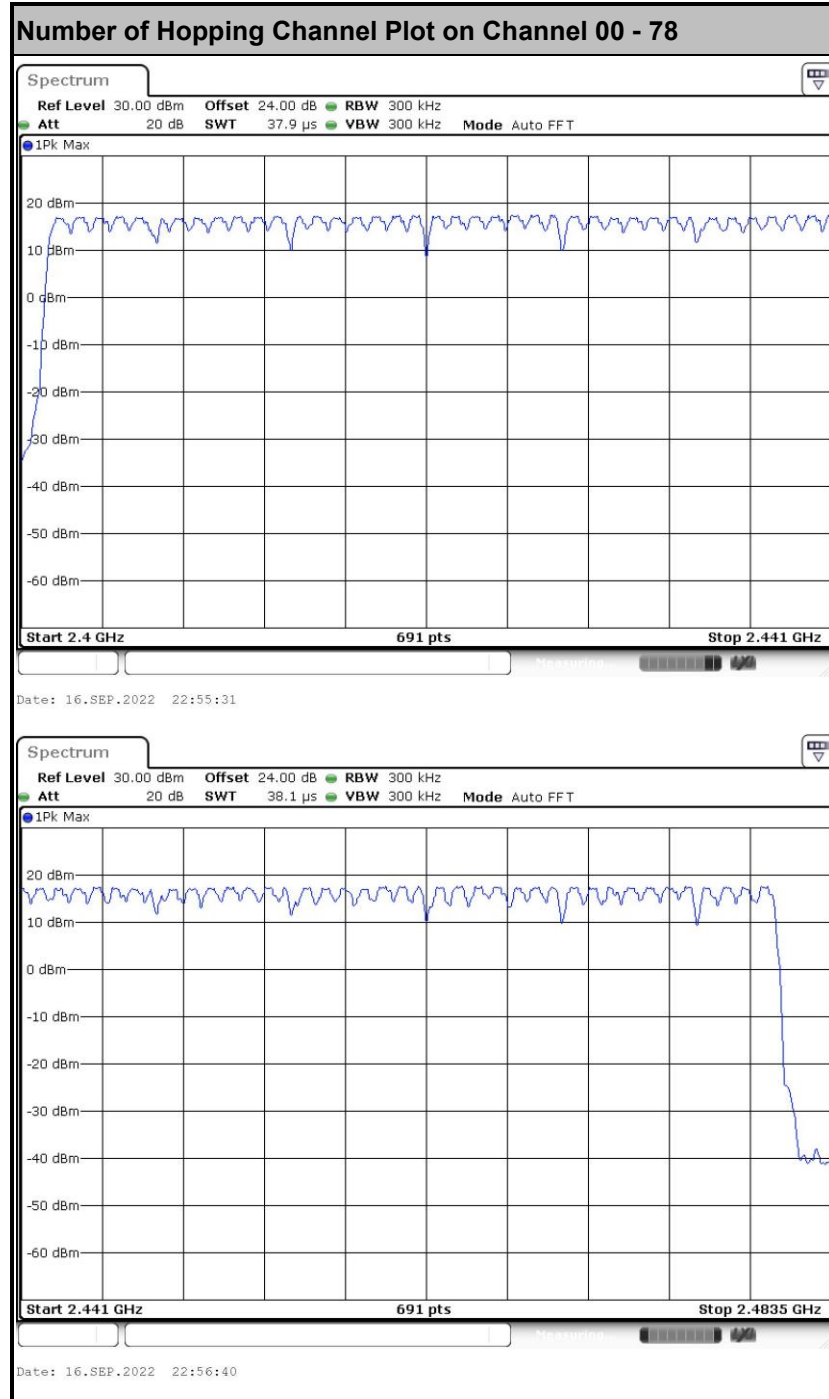



<Ant. 3>

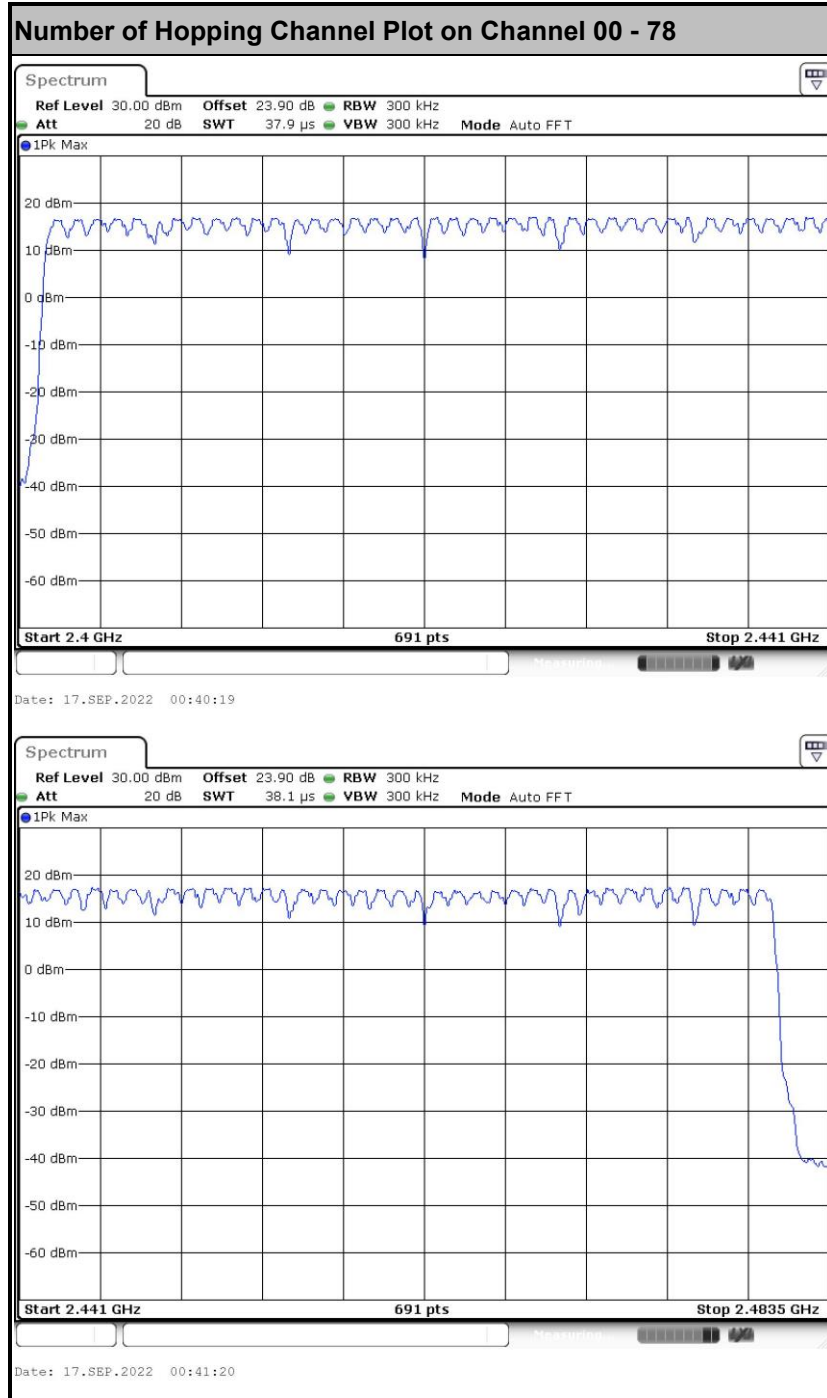

3.2 Hopping Channel Separation Measurement

3.2.1 Limit of Hopping Channel Separation

Frequency hopping systems operating in the 2400-2483.5 MHz band may have hopping channel carrier frequencies that are separated by 25 kHz or two-thirds of the 20 dB bandwidth of the hopping channel, whichever is greater.

3.2.2 Measuring Instruments

Please refer to the measuring equipment list in this test report.

3.2.3 Test Procedures

1. The testing follows ANSI C63.10-2013 clause 7.8.2.
2. The RF output of EUT is connected to the spectrum analyzer by RF cable and attenuator. The path loss is compensated to the results for each measurement.
3. Set the maximum power setting and enable the EUT to transmit continuously.
4. Enable the EUT hopping function.
5. Use the following spectrum analyzer settings:
Span = wide enough to capture the peaks of two adjacent channels;
RBW = 300 kHz; VBW \geq RBW; Sweep = auto; Detector function = peak; Trace = max hold.
6. Measure and record the results in the test report.

3.2.4 Test Setup

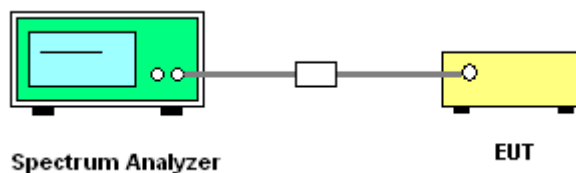

3.2.5 Test Result of Hopping Channel Separation

Please refer to Appendix A.



<Ant. 4>

<1Mbps>

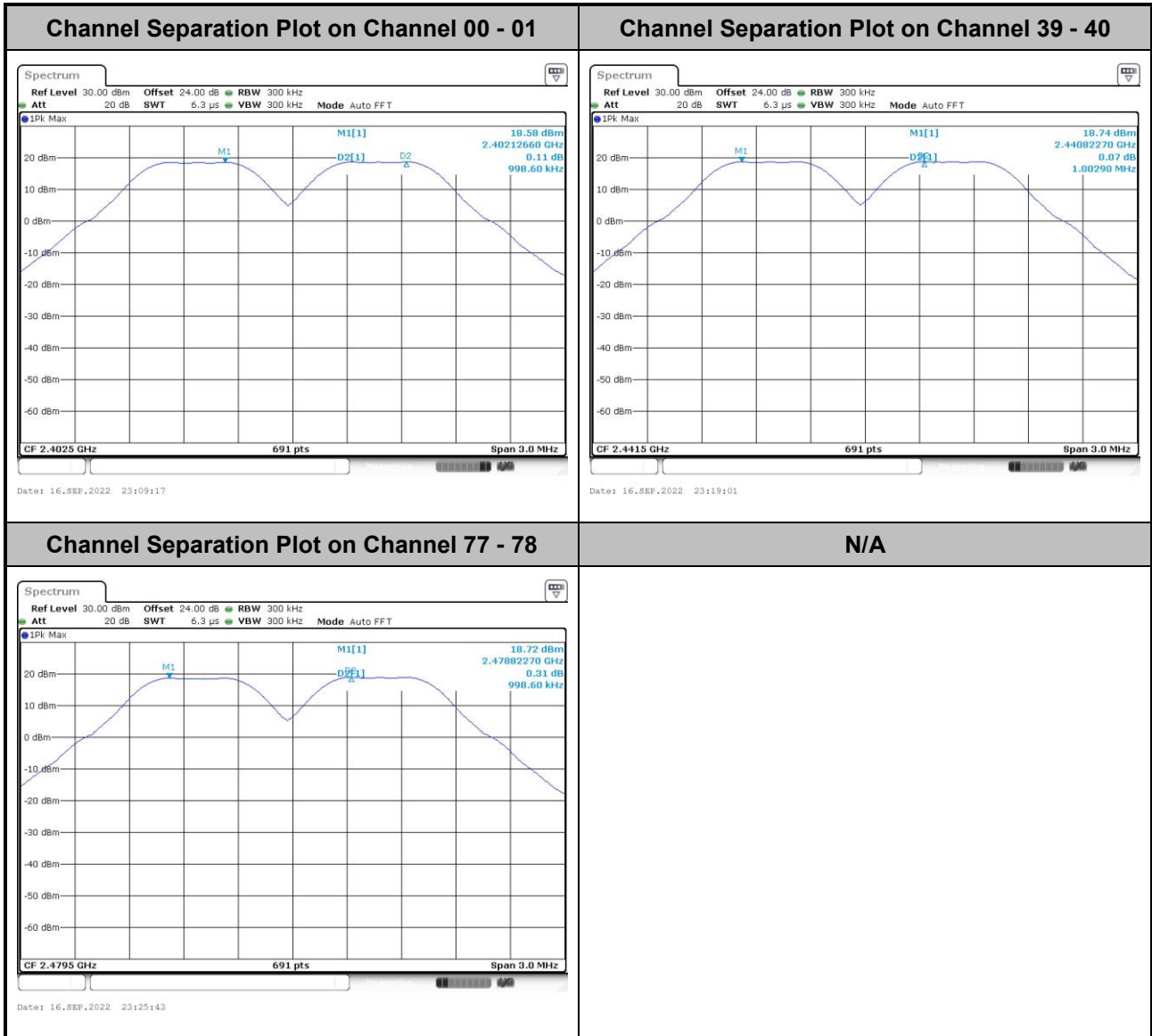



<2Mbps>

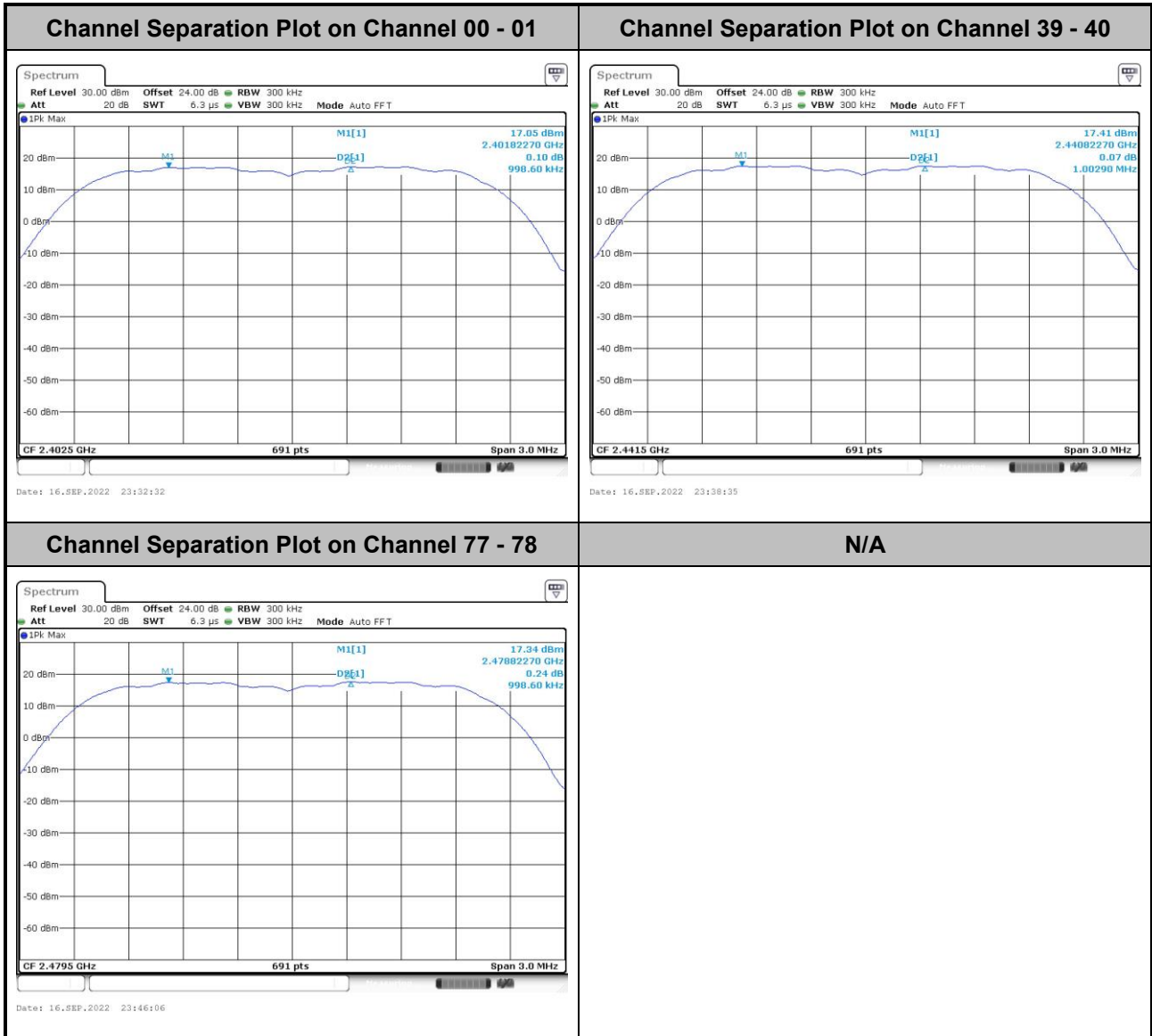



<3Mbps>

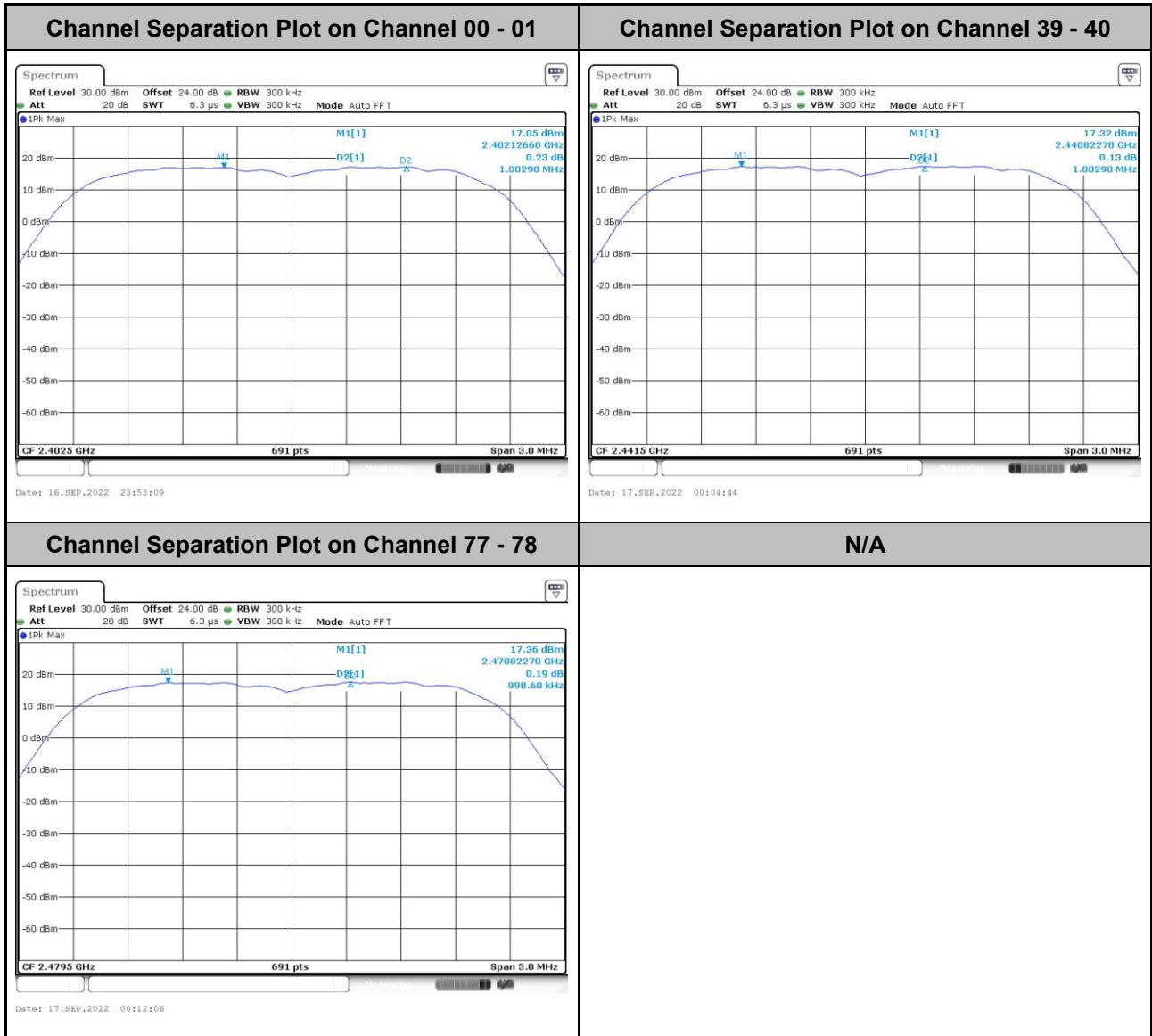



<Ant. 3>

<1Mbps>

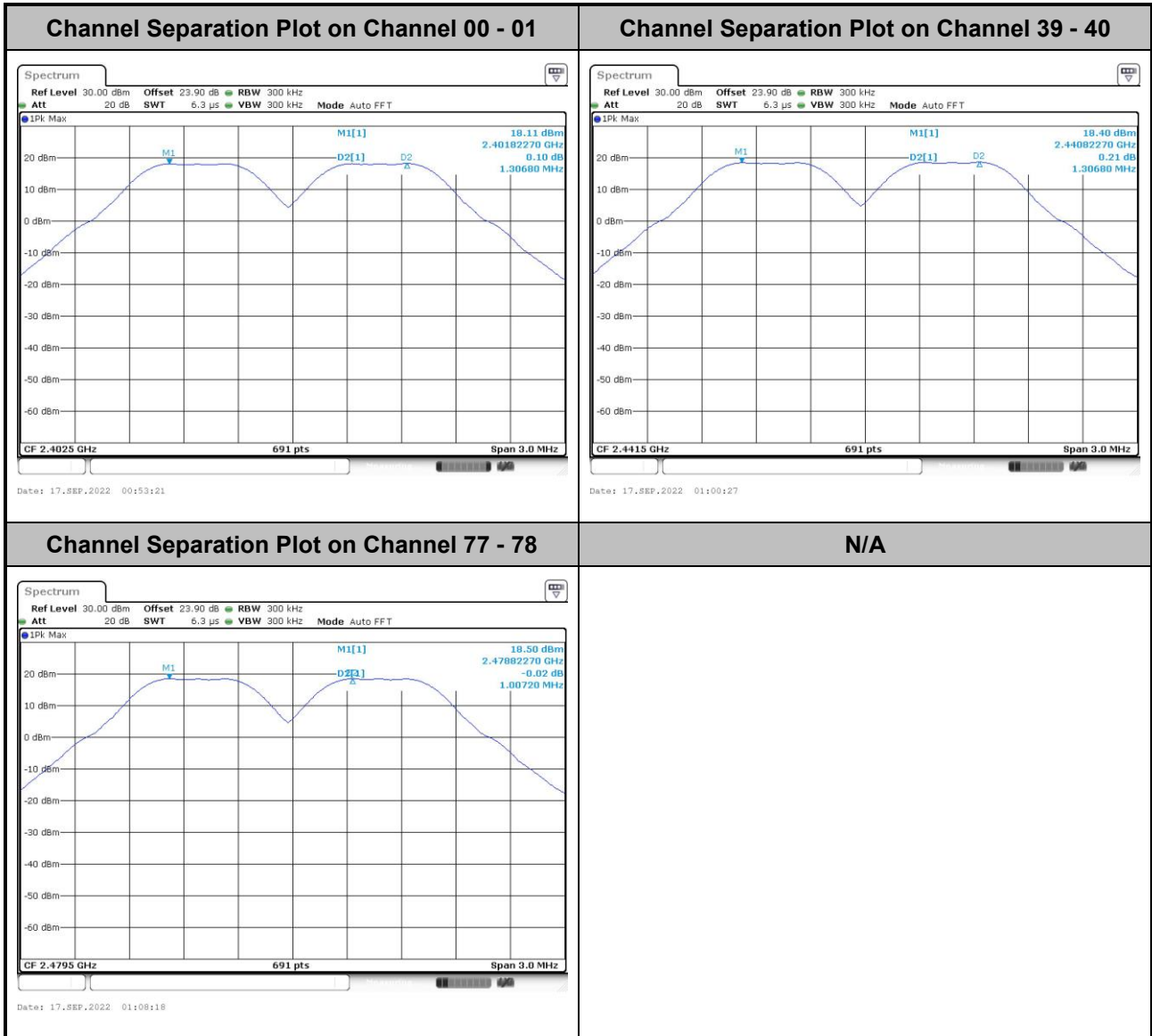



<2Mbps>

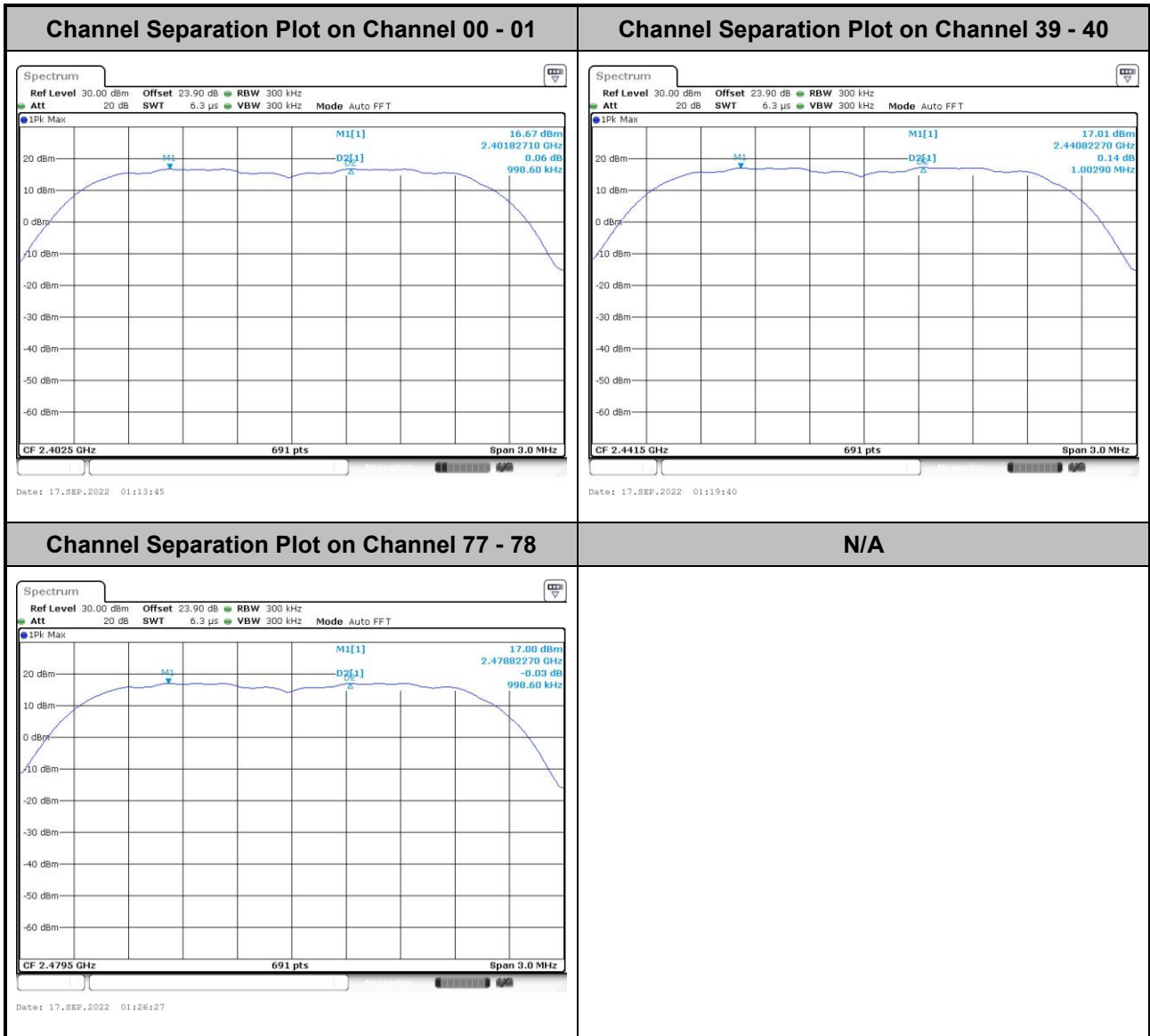



<3Mbps>

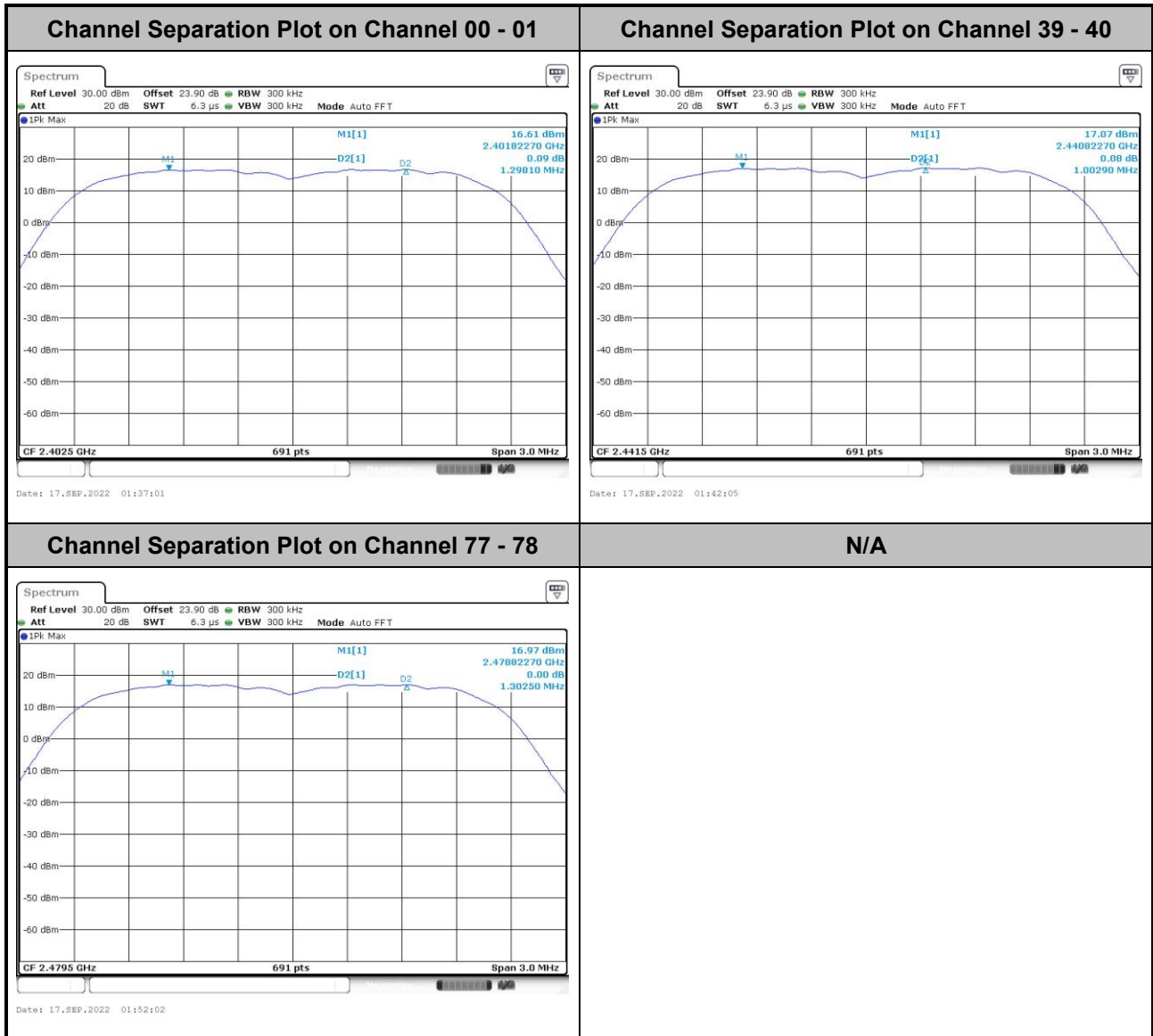

3.3 Dwell Time Measurement

3.3.1 Limit of Dwell Time

The average time of occupancy on any channel shall not be greater than 0.4 seconds within a period of 0.4 seconds multiplied by the number of hopping channels employed.

3.3.2 Measuring Instruments

Please refer to the measuring equipment list in this test report.

3.3.3 Test Procedures

1. The testing follows ANSI C63.10-2013 clause 7.8.4.
2. The RF output of EUT is connected to the spectrum analyzer by RF cable and attenuator. The path loss is compensated to the results for each measurement.
3. Set the maximum power setting and enable the EUT to transmit continuously.
4. Enable the EUT hopping function.
5. Use the following spectrum analyzer settings: Span = zero span, centered on a hopping channel; RBW = 1 MHz; VBW \geq RBW; Sweep = as necessary to capture the entire dwell time per hopping channel; Detector function = peak; Trace = max hold.
6. Measure and record the results in the test report.

3.3.4 Test Setup

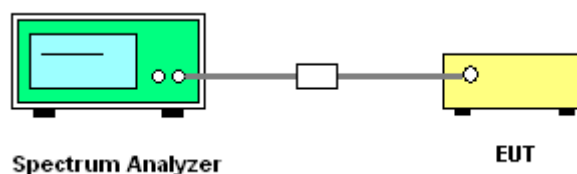

3.3.5 Test Result of Dwell Time

Please refer to Appendix A.

<Ant. 4>

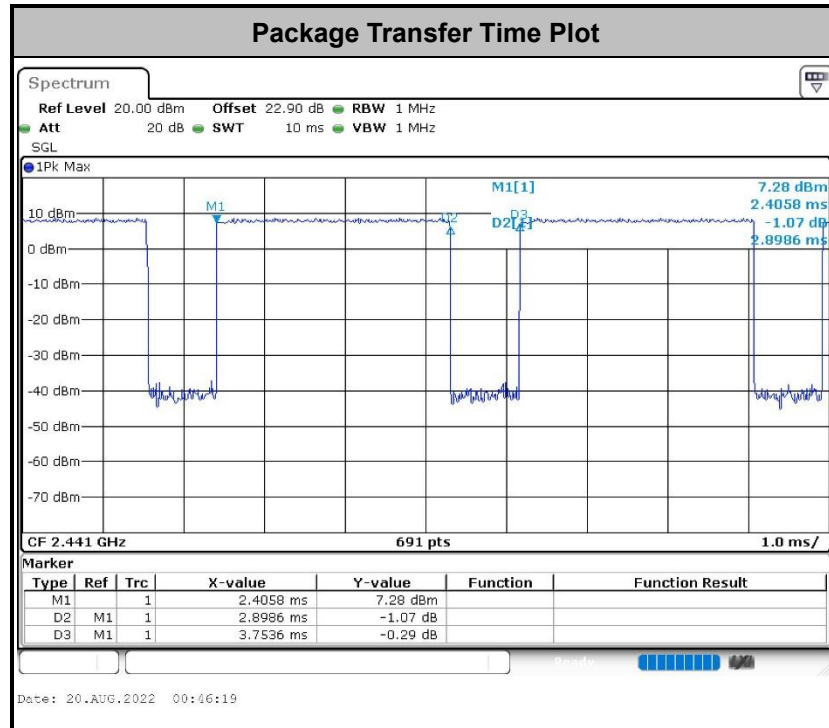

Remark:

1. In normal mode, hopping rate is 1600 hops/s with 6 slots in 79 hopping channels. With channel hopping rate (1600 / 6 / 79) in Occupancy Time Limit (0.4 x 79) (s), Hops Over Occupancy Time comes to (1600 / 6 / 79) x (0.4 x 79) = 106.67 hops.
2. In AFH mode, hopping rate is 800 hops/s with 6 slots in 20 hopping channels. With channel hopping rate (800 / 6 / 20) in Occupancy Time Limit (0.4 x 20) (s), Hops Over Occupancy Time comes to (800 / 6 / 20) x (0.4 x 20) = 53.33 hops.
3. Dwell Time(s) = Hops Over Occupancy Time (hops) x Package Transfer Time

<Ant. 3>

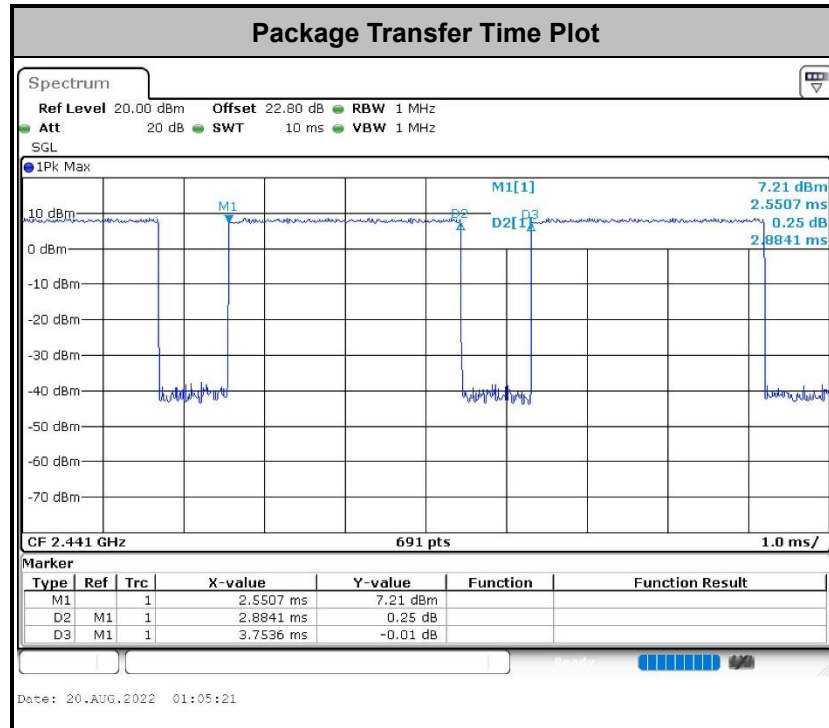

Remark:

4. In normal mode, hopping rate is 1600 hops/s with 6 slots in 79 hopping channels. With channel hopping rate (1600 / 6 / 79) in Occupancy Time Limit (0.4 x 79) (s), Hops Over Occupancy Time comes to (1600 / 6 / 79) x (0.4 x 79) = 106.67 hops.

5. In AFH mode, hopping rate is 800 hops/s with 6 slots in 20 hopping channels. With channel hopping rate (800 / 6 / 20) in Occupancy Time Limit (0.4 x 20) (s), Hops Over Occupancy Time comes to (800 / 6 / 20) x (0.4 x 20) = 53.33 hops.

6. Dwell Time(s) = Hops Over Occupancy Time (hops) x Package Transfer Time

3.4 20dB and 99% Bandwidth Measurement

3.4.1 Limit of 20dB and 99% Bandwidth

Reporting only

3.4.2 Measuring Instruments

Please refer to the measuring equipment list in this test report.

3.4.3 Test Procedures

1. The testing follows ANSI C63.10-2013 clause 6.9.2 and 6.9.3.
2. The RF output of EUT is connected to the spectrum analyzer by RF cable and attenuator. The path loss is compensated to the results for each measurement.
3. Set the maximum power setting and enable the EUT to transmit continuously.
4. Use the following spectrum analyzer settings for 20 dB Bandwidth measurement.
Span = approximately 2 to 5 times the 20 dB bandwidth, centered on a hopping channel;
RBW \geq 1% of the 20 dB bandwidth; VBW \geq RBW; Sweep = auto; Detector function = peak;
Trace = max hold.
5. Use the following spectrum analyzer settings for 99 % Bandwidth measurement.
Span = approximately 1.5 to 5 times the 99% bandwidth, centered on a hopping channel;
RBW \geq 1-5% of the 99% bandwidth; VBW \geq 3 * RBW; Sweep = auto; Detector function = peak;
Trace = max hold.
6. Measure and record the results in the test report.

3.4.4 Test Setup

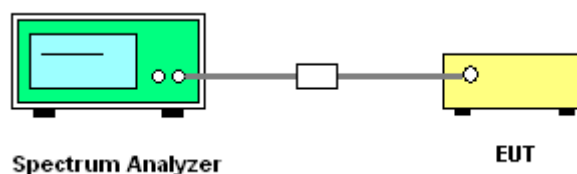

3.4.5 Test Result of 20dB Bandwidth

Please refer to Appendix A.



<Ant. 4>

<1Mbps>

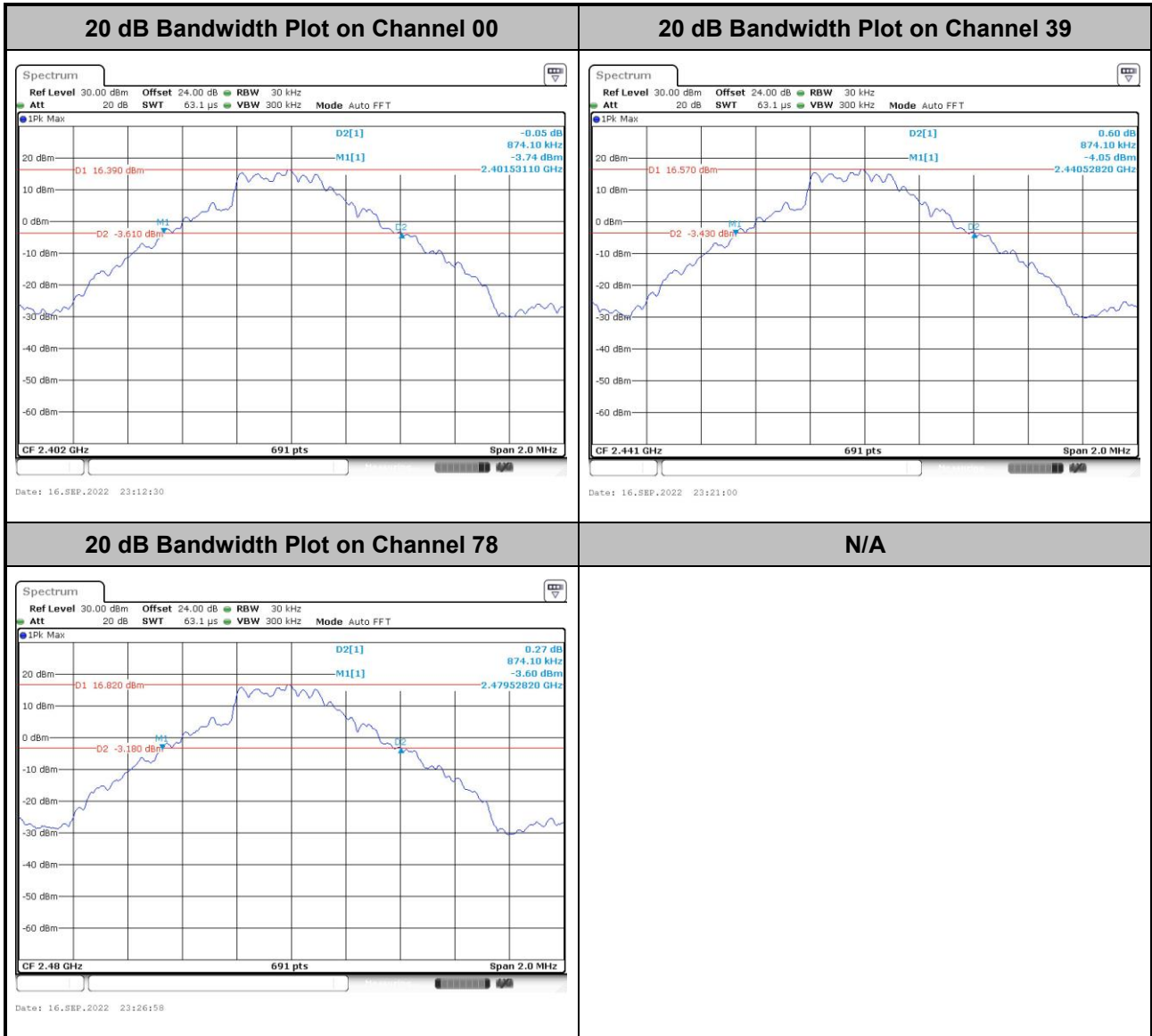



<2Mbps>

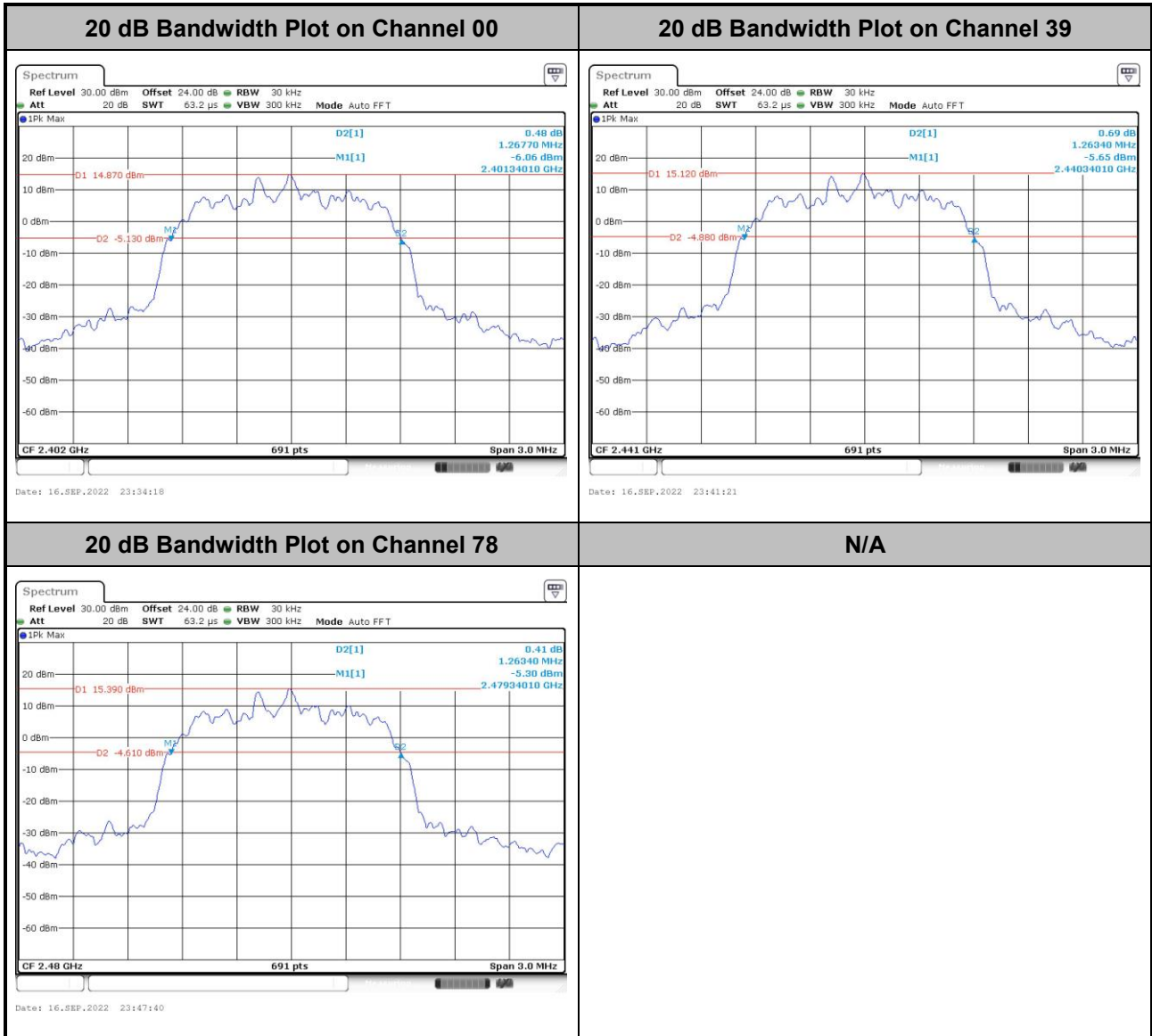



<3Mbps>

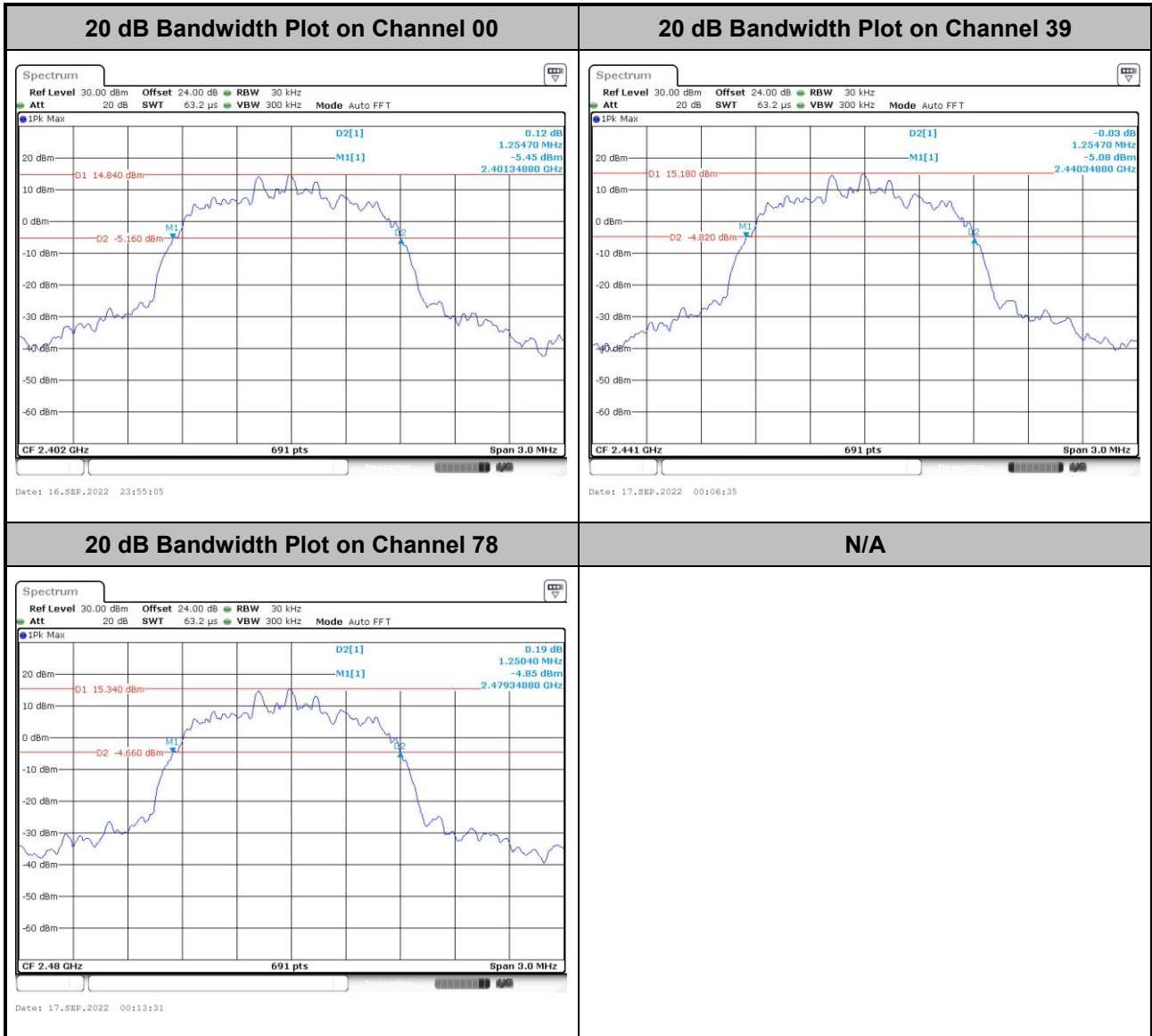



<Ant. 3>

<1Mbps>

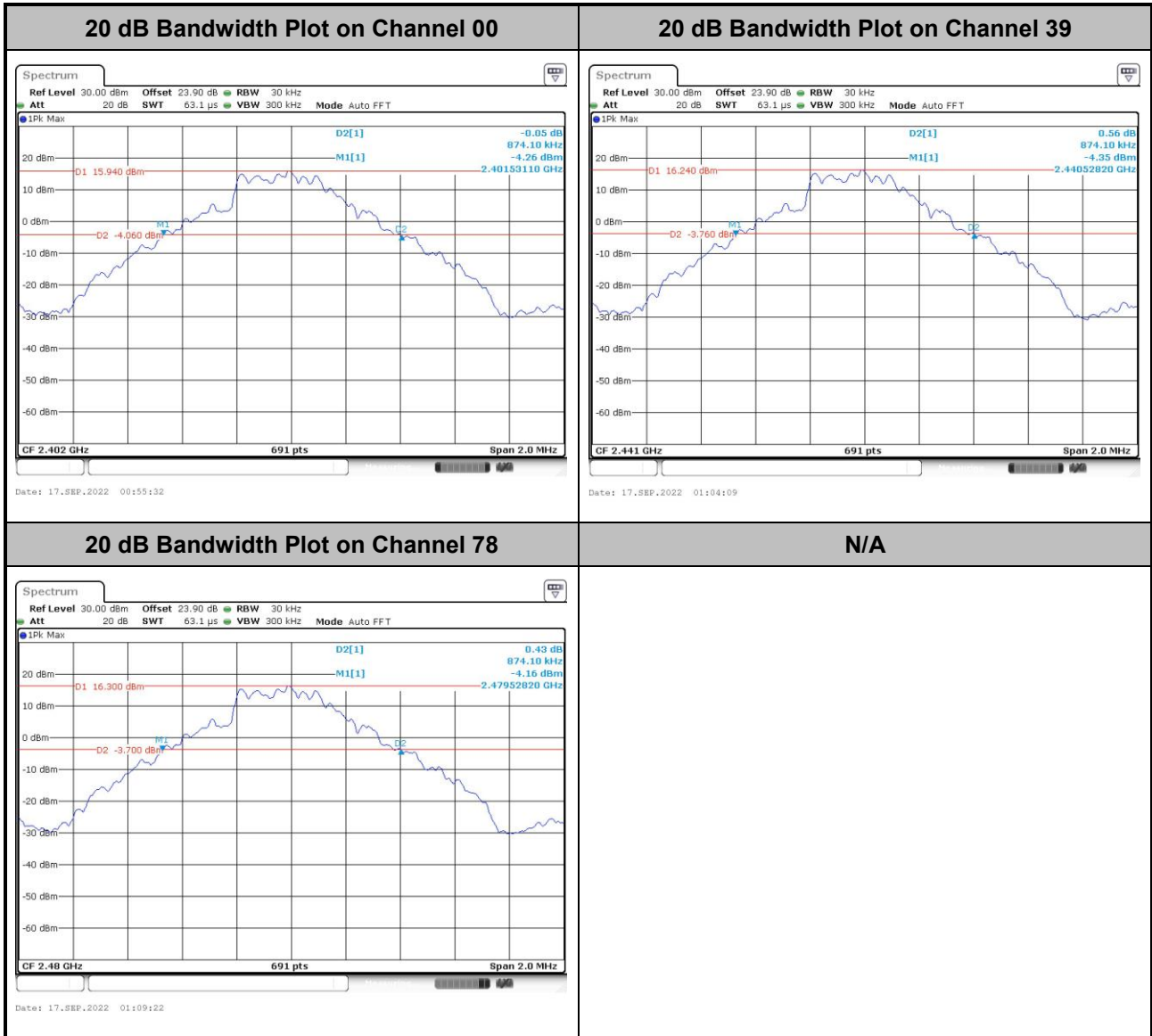



<2Mbps>

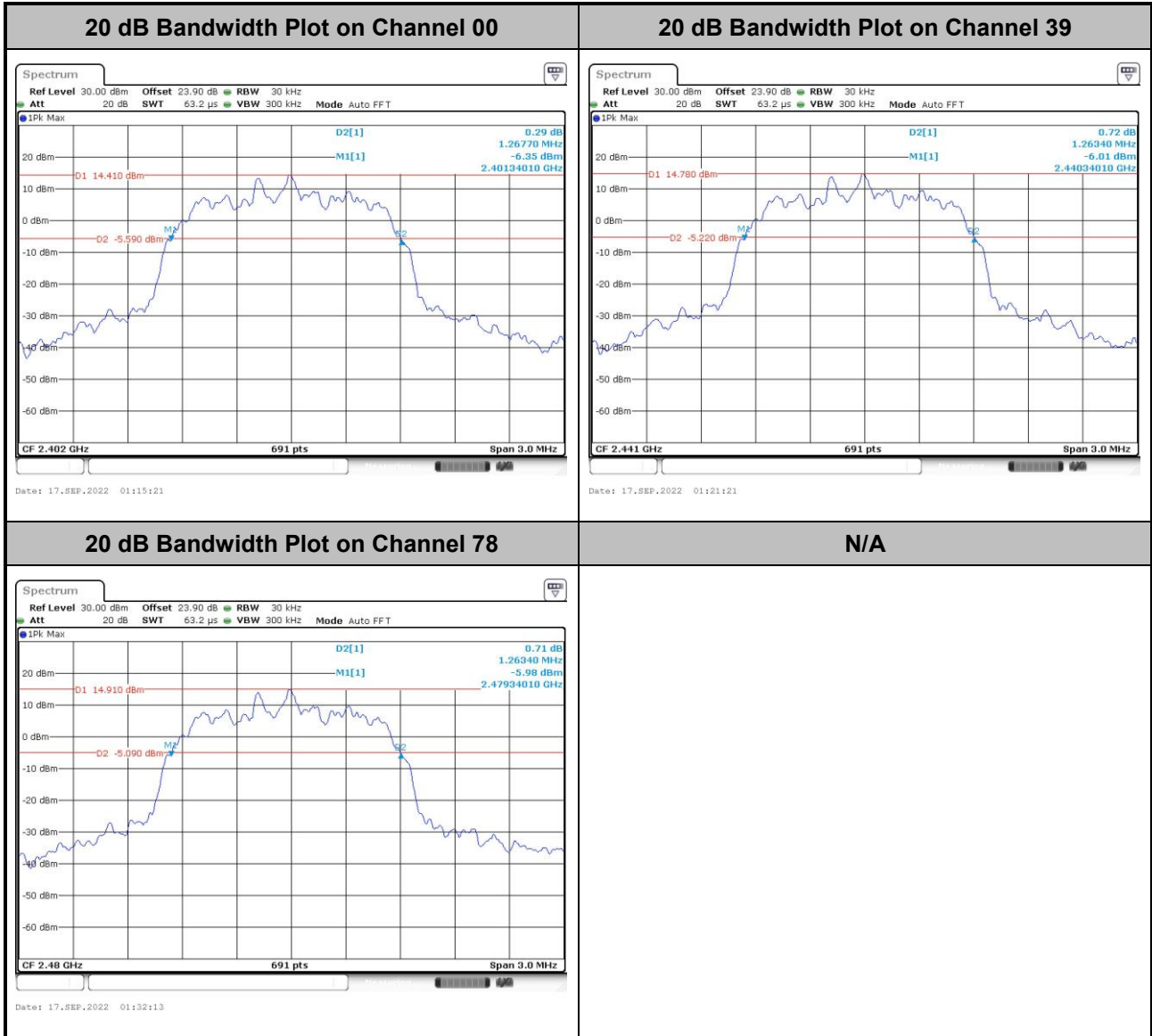



<3Mbps>

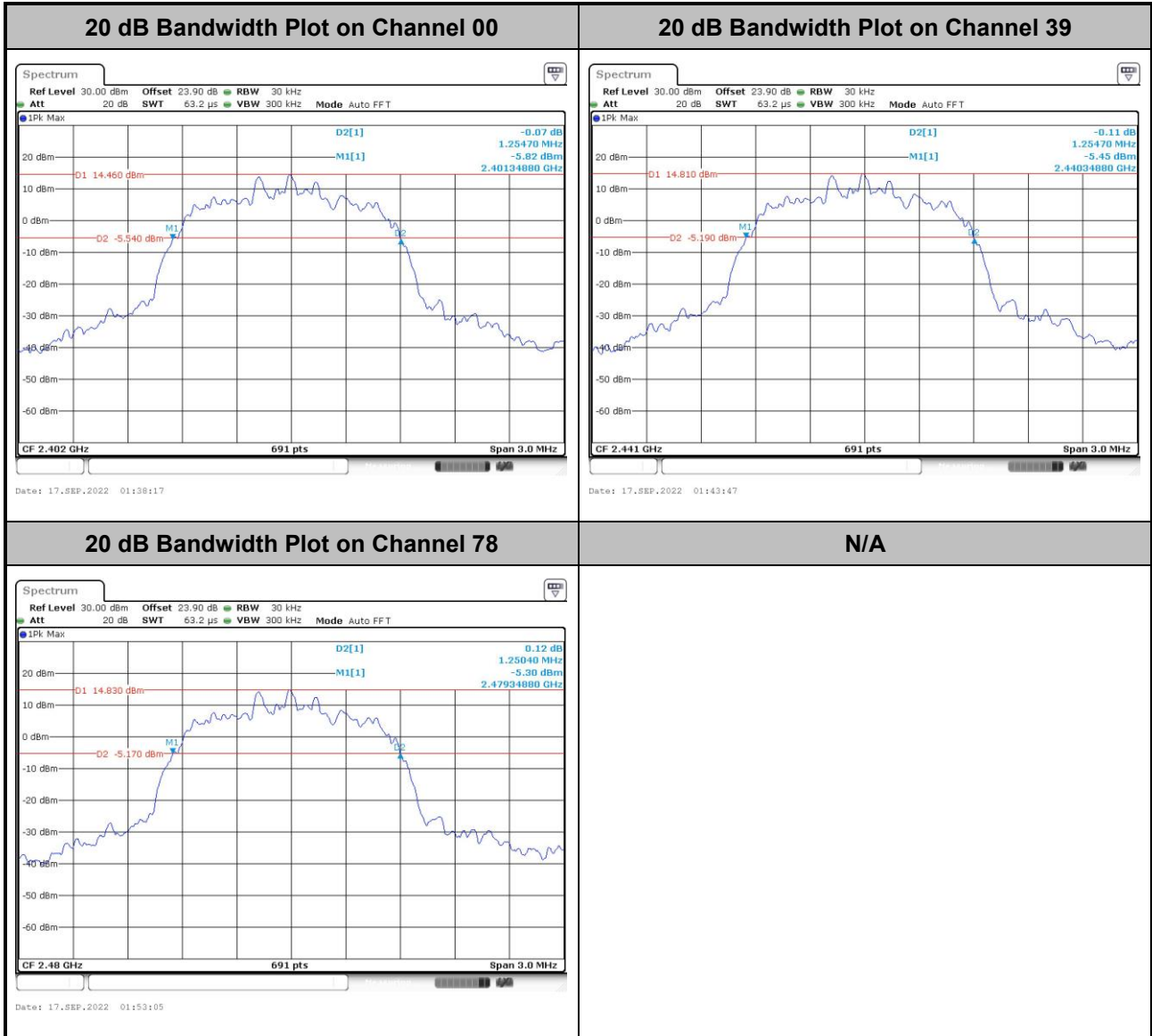



3.4.6 Test Result of 99% Occupied Bandwidth

Please refer to Appendix A.

<Ant. 4>

<1Mbps>

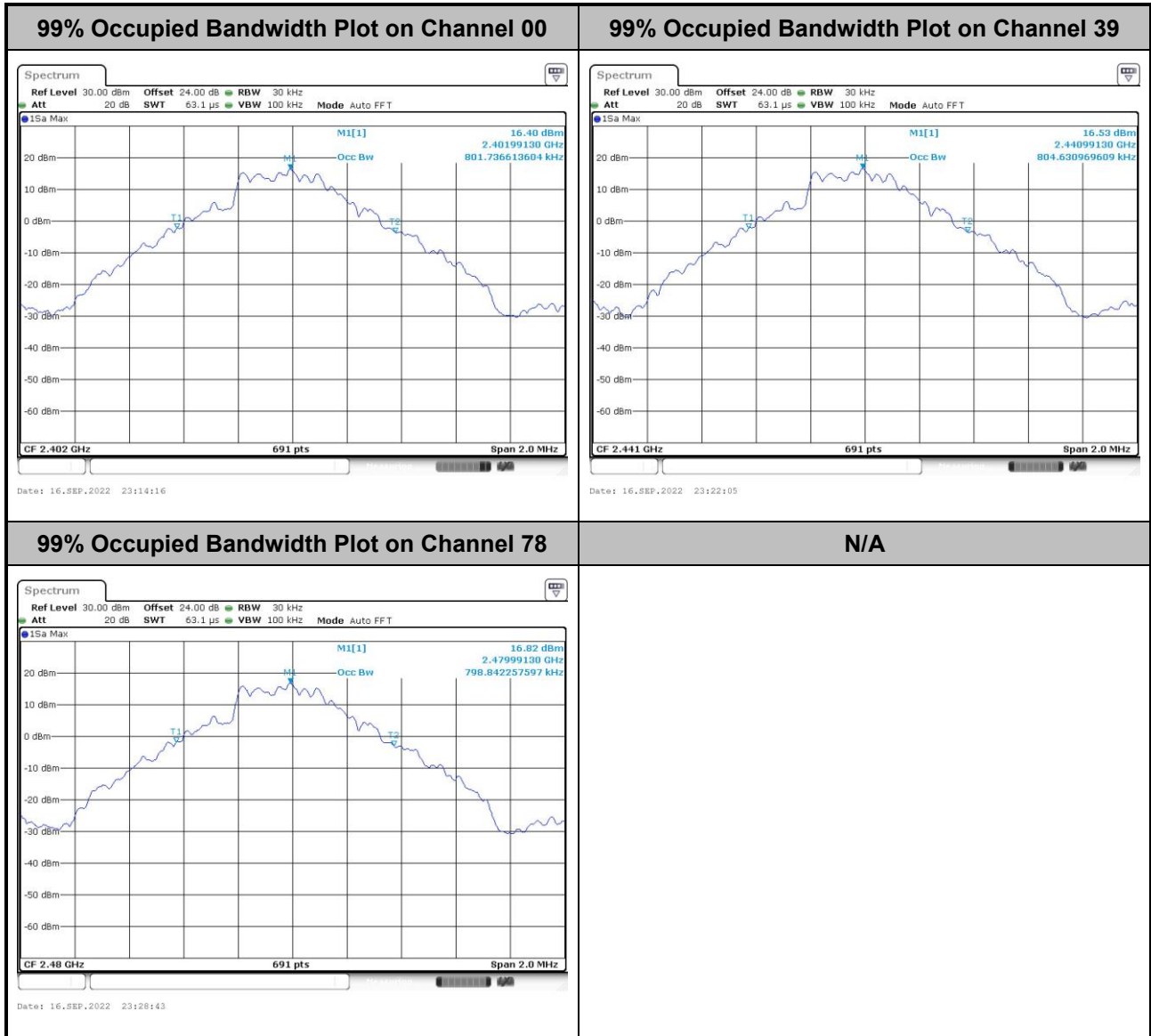

Note: The occupied channel bandwidth is maintained within the band of operation for all of the modulations.



<2Mbps>

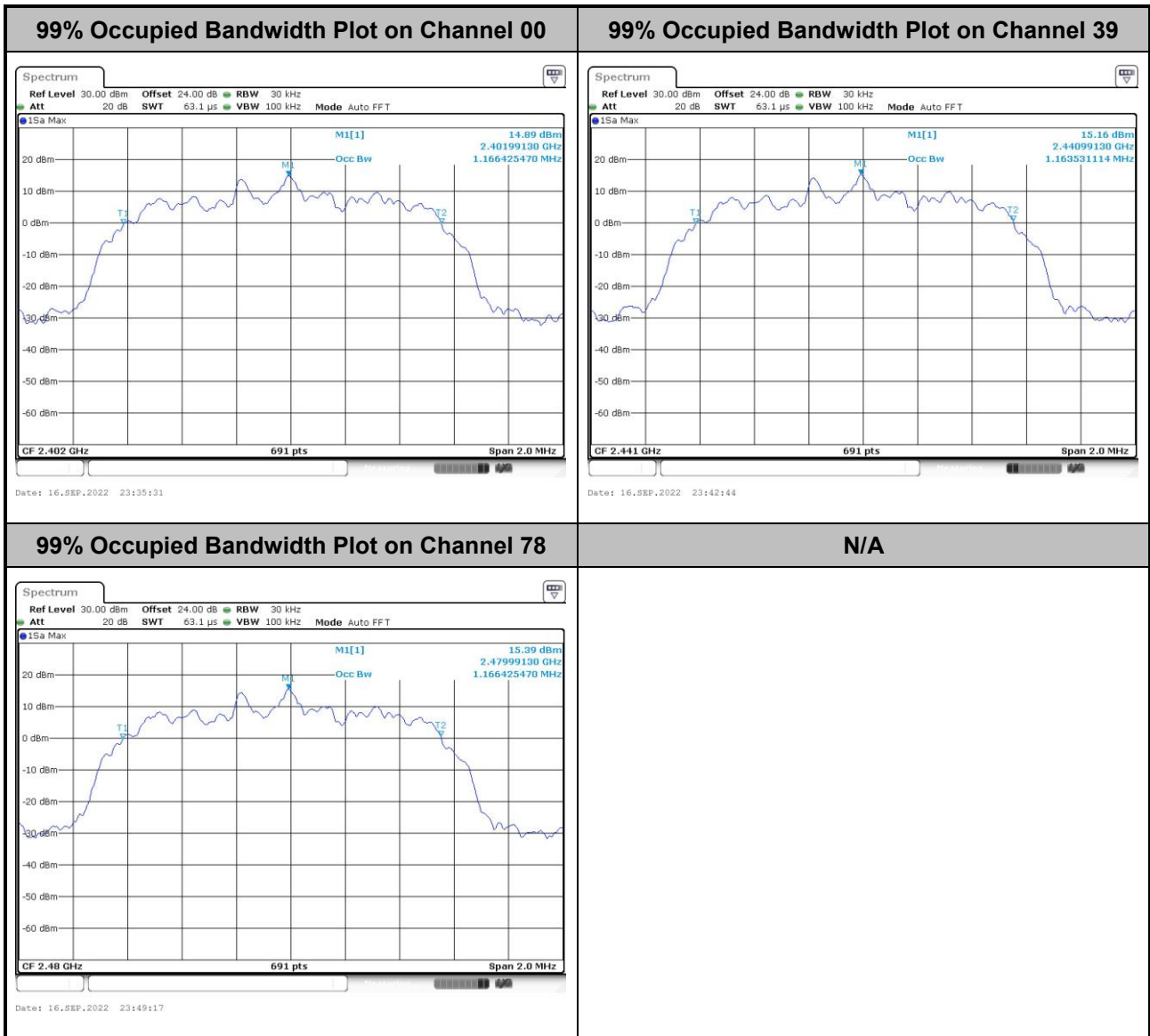

Note: The occupied channel bandwidth is maintained within the band of operation for all of the modulations.



<3Mbps>

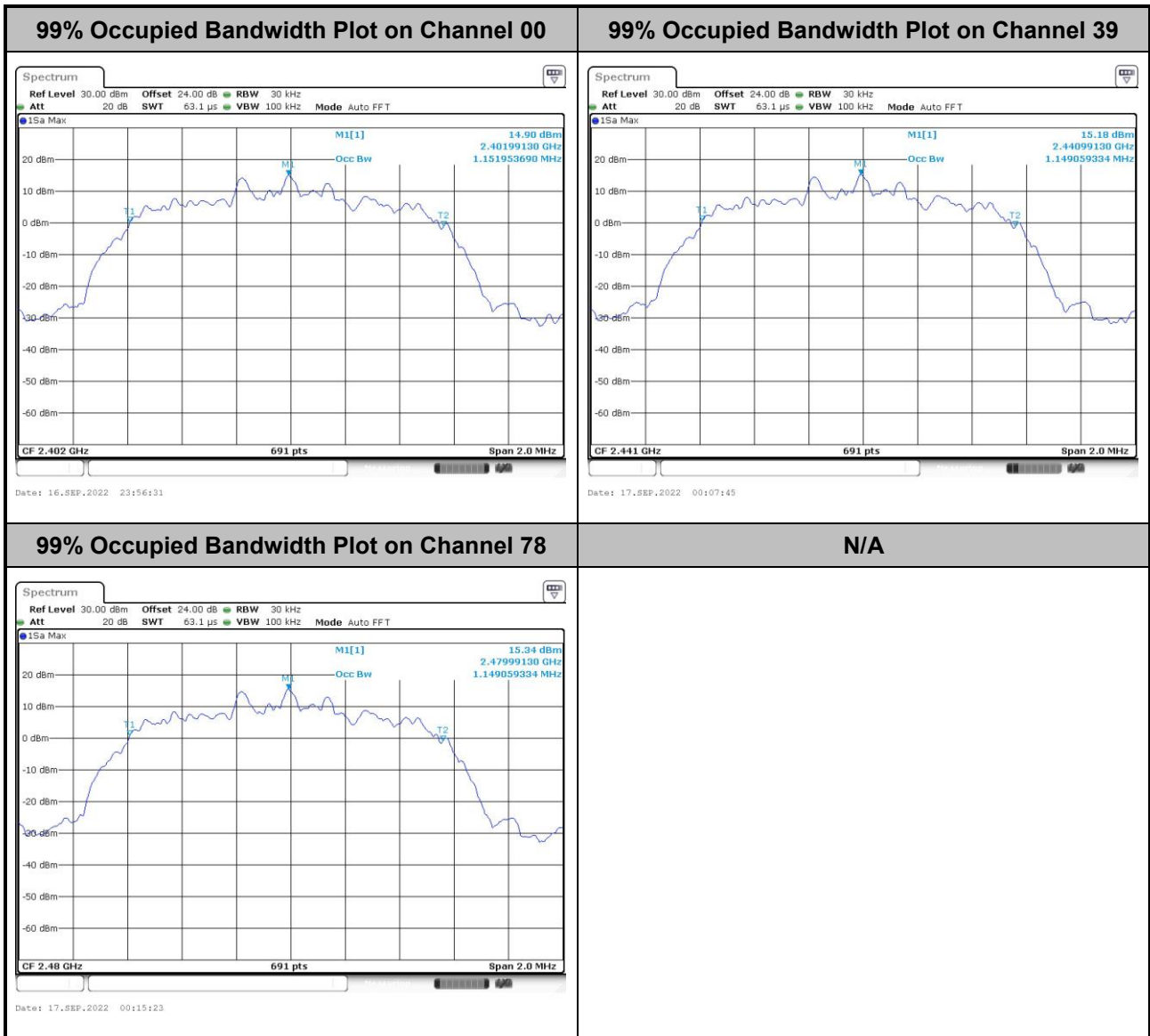

Note: The occupied channel bandwidth is maintained within the band of operation for all of the modulations.



<Ant. 3>

<1Mbps>

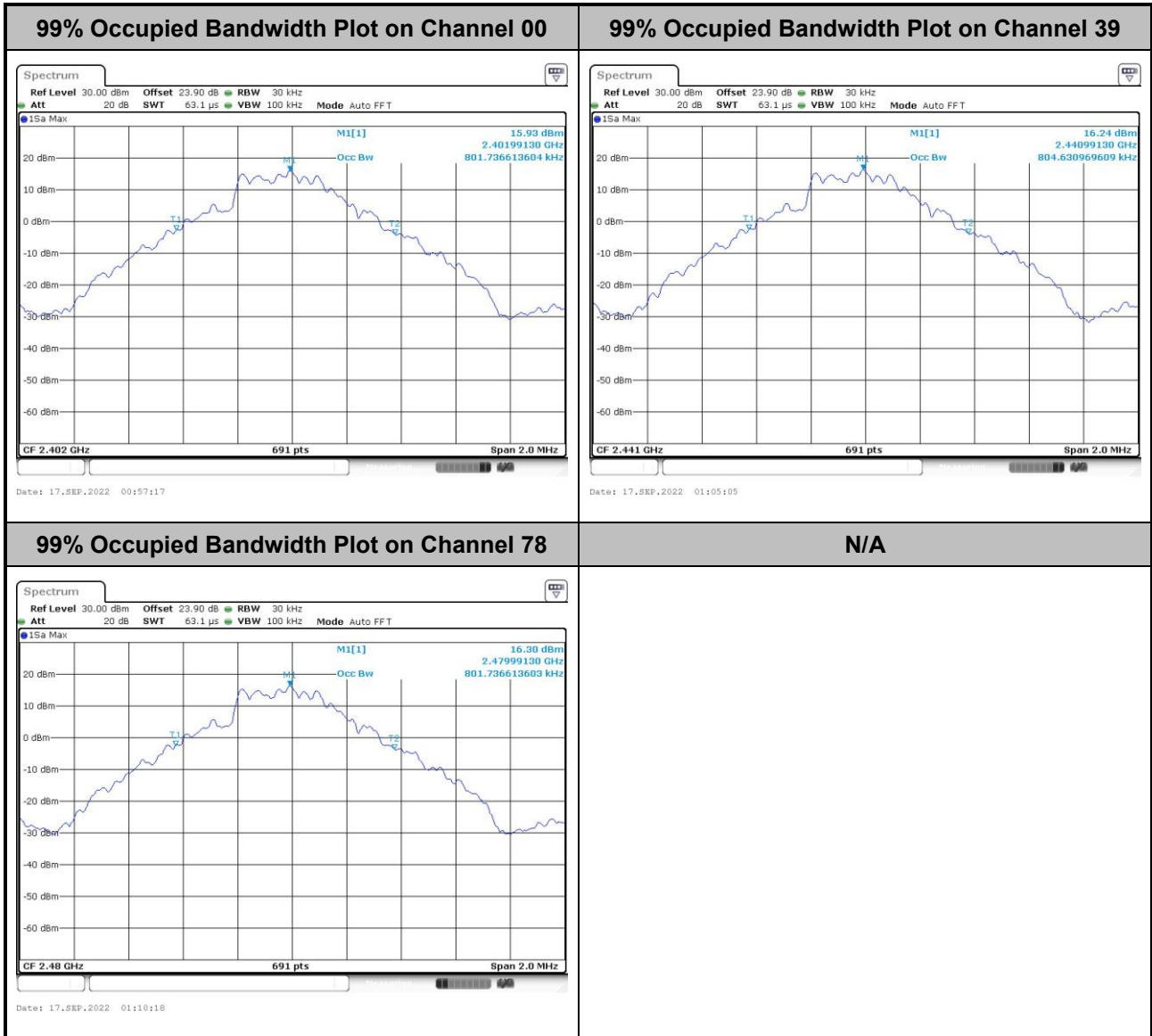

Note: The occupied channel bandwidth is maintained within the band of operation for all of the modulations.



<2Mbps>

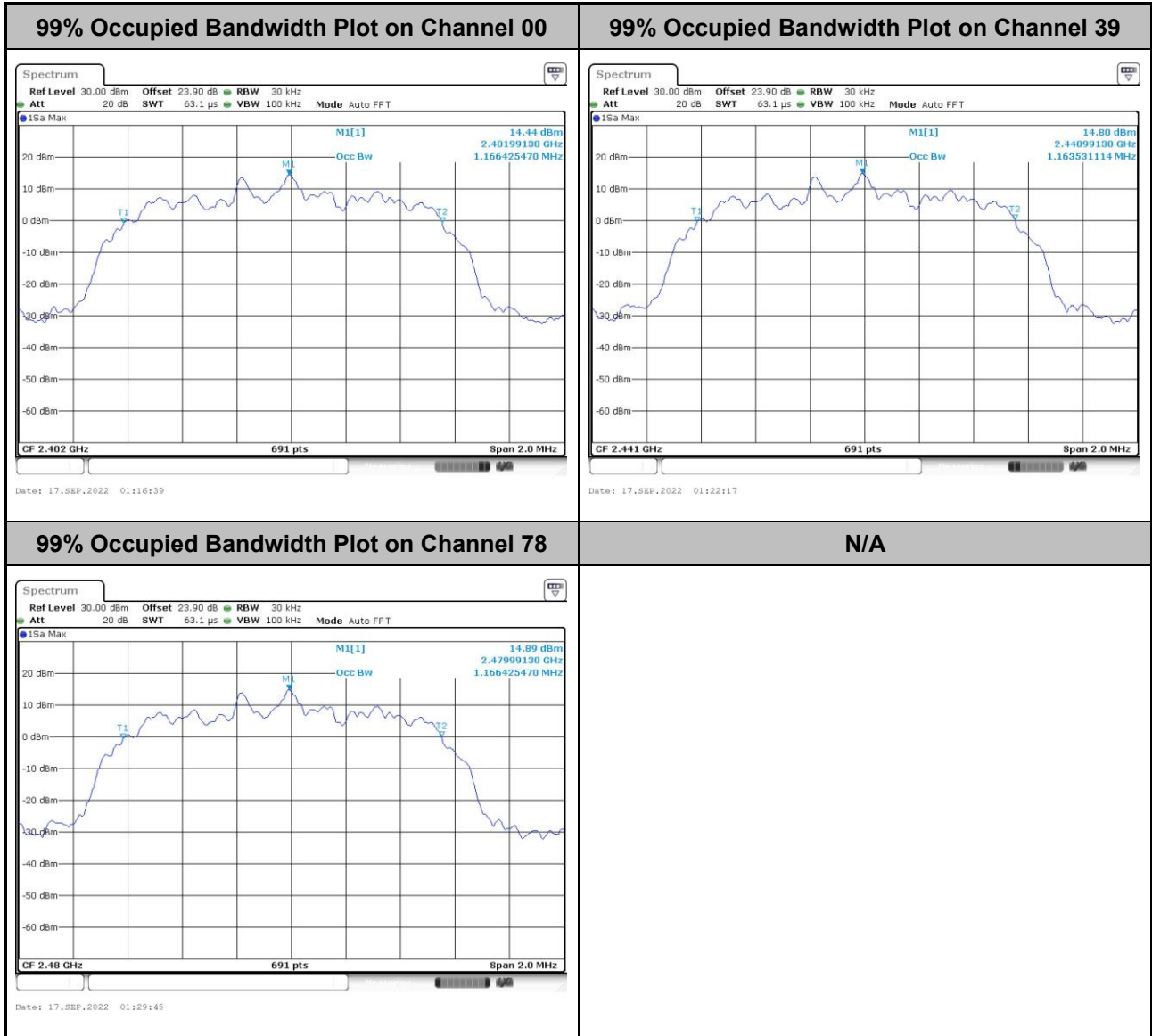

Note: The occupied channel bandwidth is maintained within the band of operation for all of the modulations.



<3Mbps>

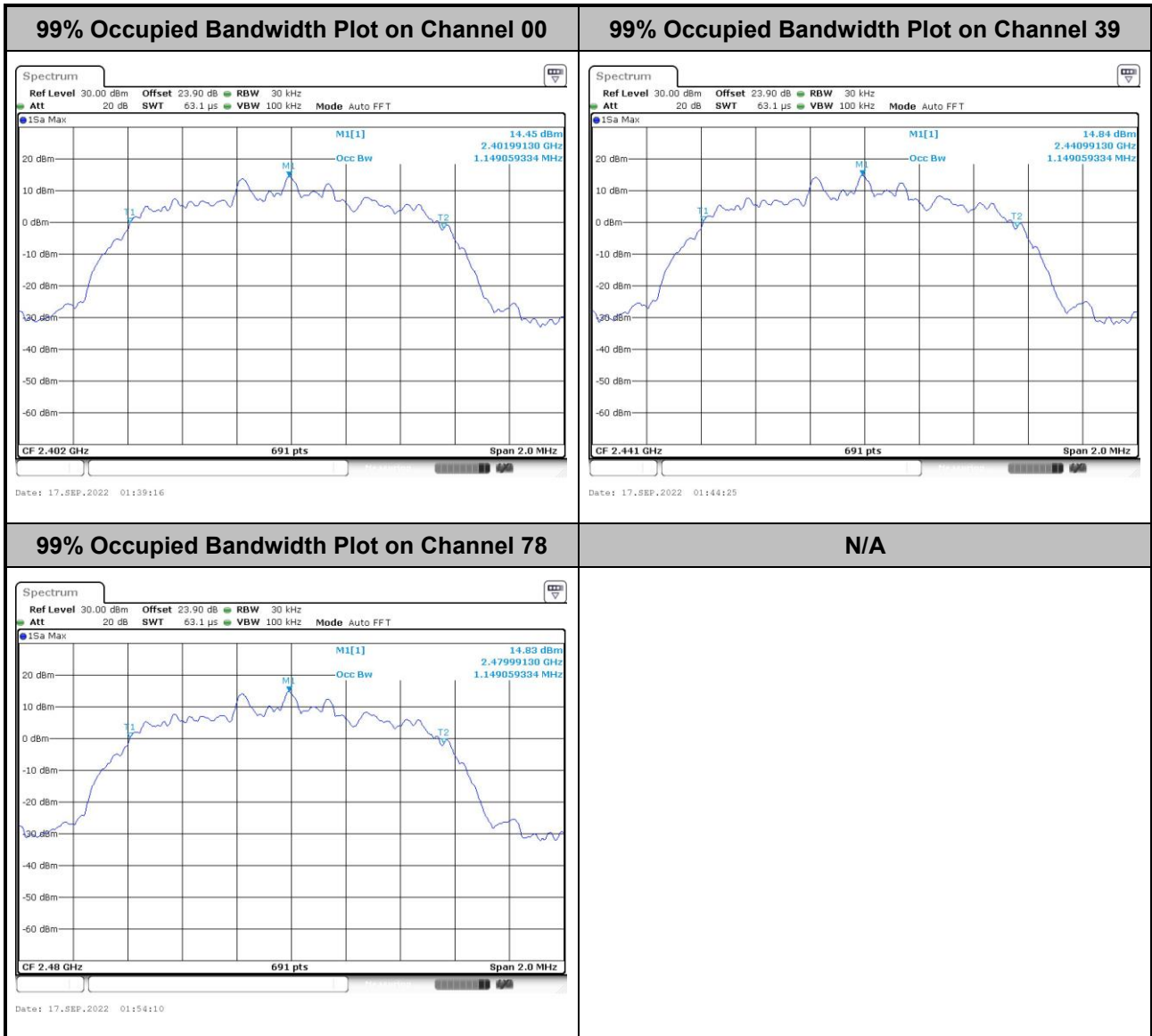

Note: The occupied channel bandwidth is maintained within the band of operation for all of the modulations.

3.5 Output Power Measurement

3.5.1 Limit of Output Power

The maximum peak conducted output power of the intentional radiator shall not exceed the following:
For frequency hopping systems operating in the 2400-2483.5 MHz band employing at least 75 non-overlapping hopping channels, and all frequency hopping systems in the 5725-5850 MHz band: 1 watt. For all other frequency hopping systems in the 2400-2483.5 MHz band 0.125 watts.
If directional gain of transmitting antennas is greater than 6 dBi, the power shall be reduced by the same level in dB comparing to gain minus 6 dBi.

3.5.2 Measuring Instruments

Please refer to the measuring equipment list in this test report.

3.5.3 Test Procedures

1. The testing follows ANSI C63.10-2013 clause 7.8.5.
2. The RF output of EUT is connected to the power meter by RF cable and attenuator. The path loss is compensated to the results for each measurement.
3. Set the maximum power setting and enable the EUT to transmit continuously.
4. Measure the conducted output power with cable loss and record the results in the test report.
5. Measure and record the results in the test report.

3.5.4 Test Setup

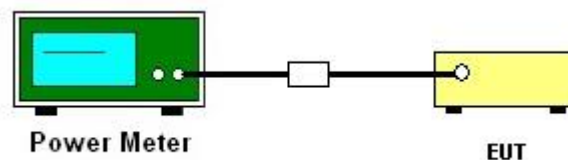

3.5.5 Test Result of Peak Output Power

Please refer to Appendix A.

3.5.6 Test Result of Average Output Power (Reporting Only)

Please refer to Appendix A.

3.6 Conducted Band Edges Measurement

3.6.1 Limit of Band Edges

In any 100 kHz bandwidth outside the intentional radiation frequency band, the radio frequency power shall be at least 20 dB below the highest level of the radiated power. In addition, radiated emissions which fall in the restricted bands must also comply with the radiated emission limits.

3.6.2 Measuring Instruments

Please refer to the measuring equipment list in this test report.

3.6.3 Test Procedures

1. The testing follows ANSI C63.10-2013 clause 7.8.6.
2. Set the maximum power setting and enable the EUT to transmit continuously.
3. Set RBW = 100 kHz, VBW = 300 kHz. Band edge emissions must be at least 20 dB down from the highest emission level within the authorized band as measured with a 100 kHz RBW. The attenuation shall be 30 dB instead of 20 dB when RMS conducted output power procedure is used.
4. Enable hopping function of the EUT and then repeat step 2 and 3.
5. Measure and record the results in the test report.

3.6.4 Test Setup

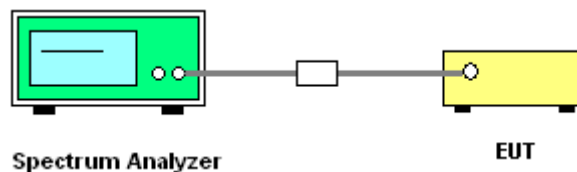



3.6.5 Test Result of Conducted Band Edges

<Ant. 4>

<1Mbps>

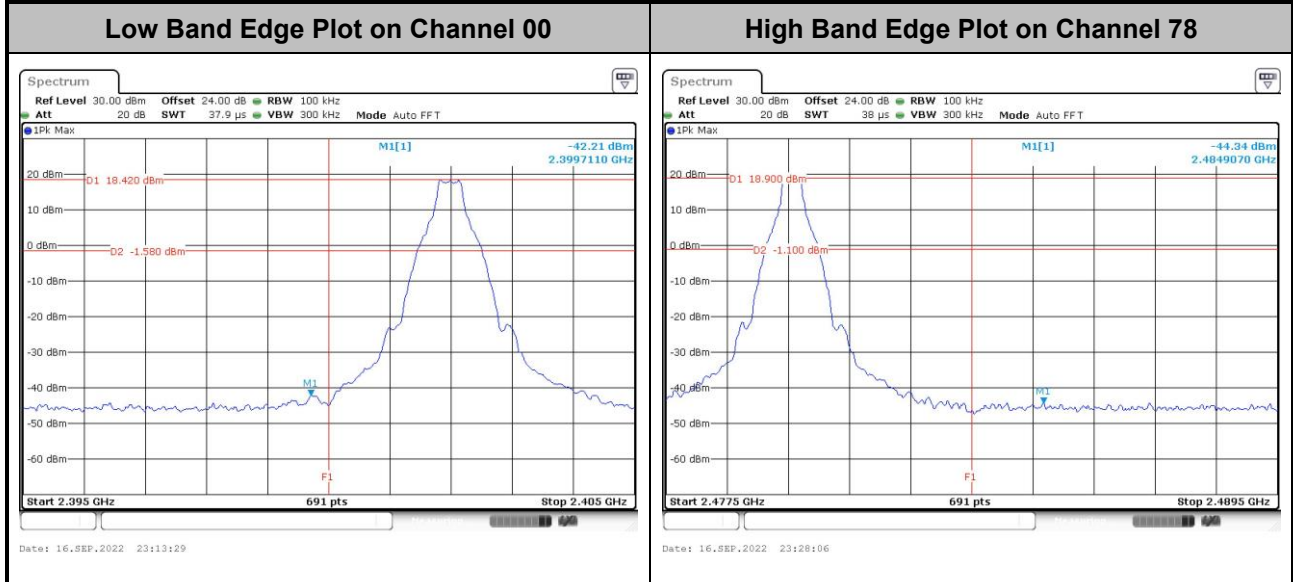

<2Mbps>

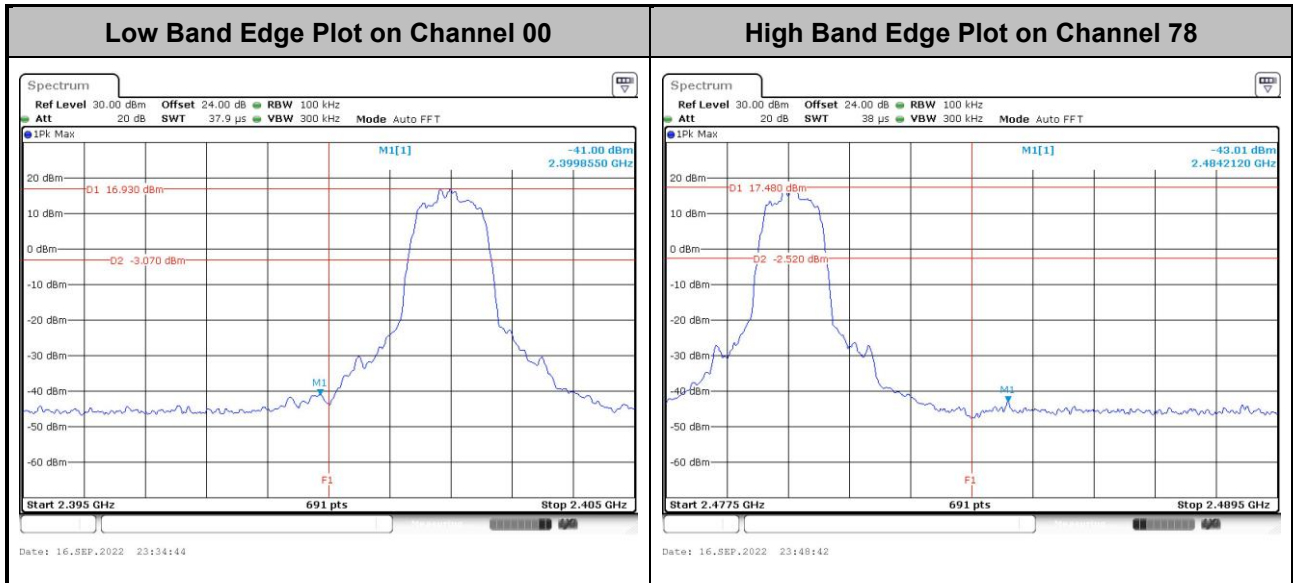



<3Mbps>

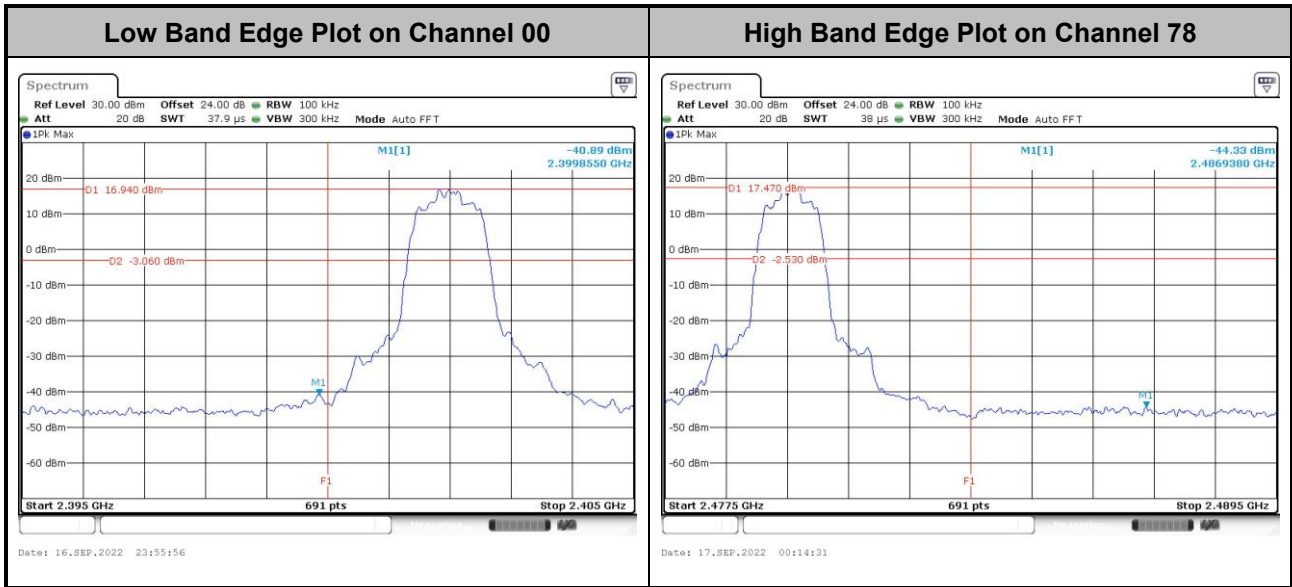



<Ant. 3>

<1Mbps>

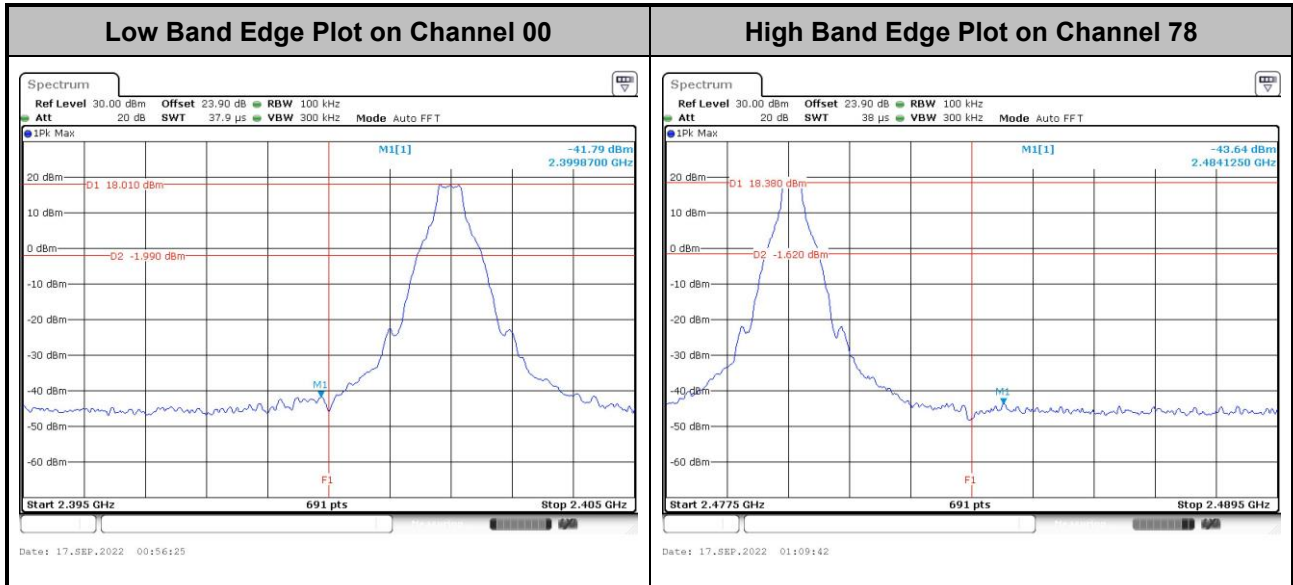

<2Mbps>

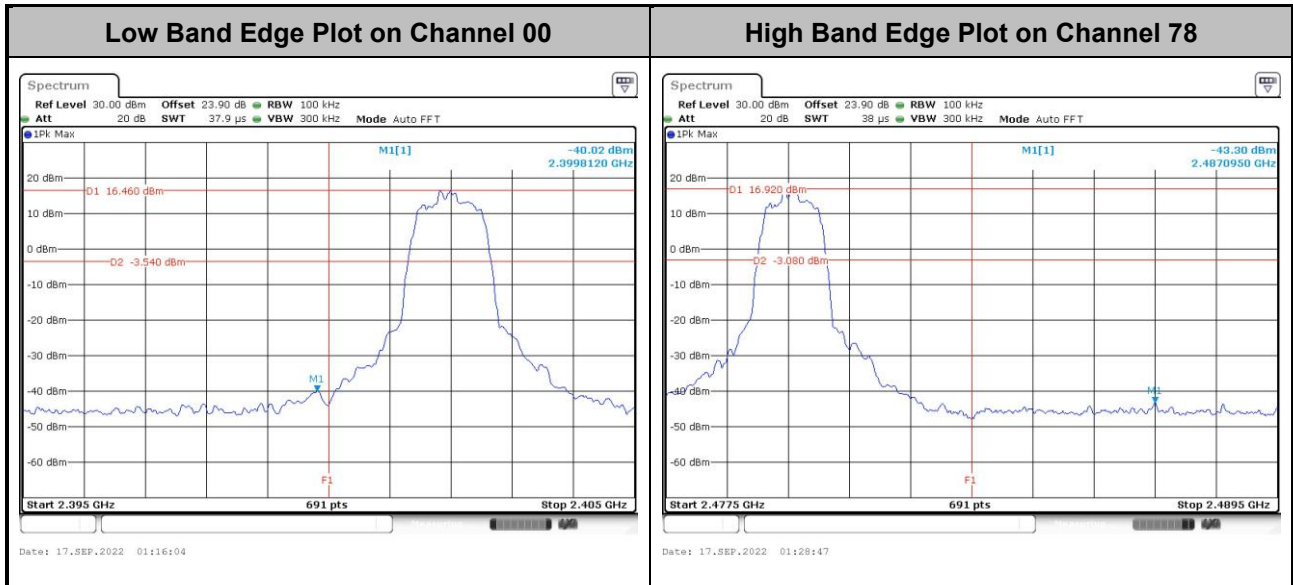



<3Mbps>

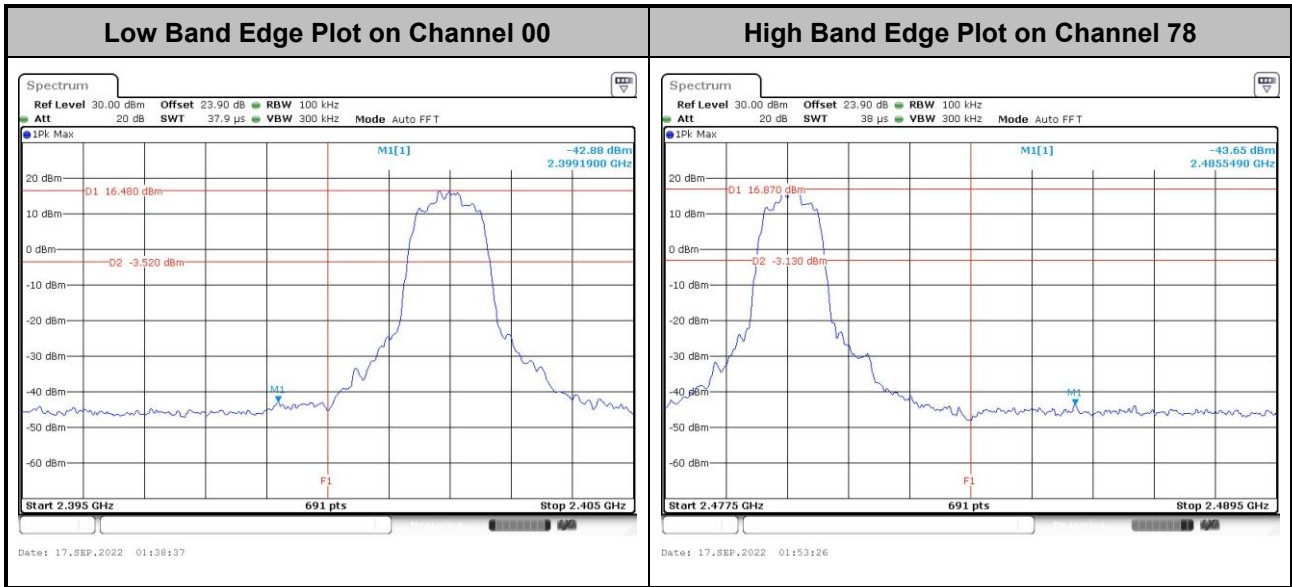



3.6.6 Test Result of Conducted Hopping Mode Band Edges

<Ant. 4>

<1Mbps>

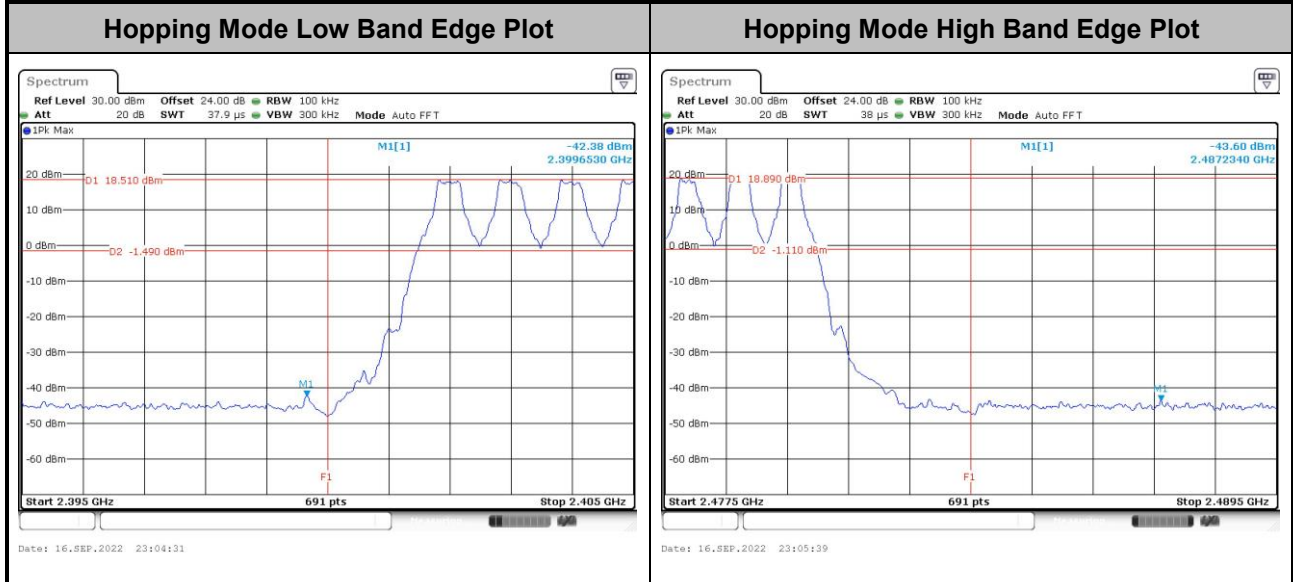

<2Mbps>

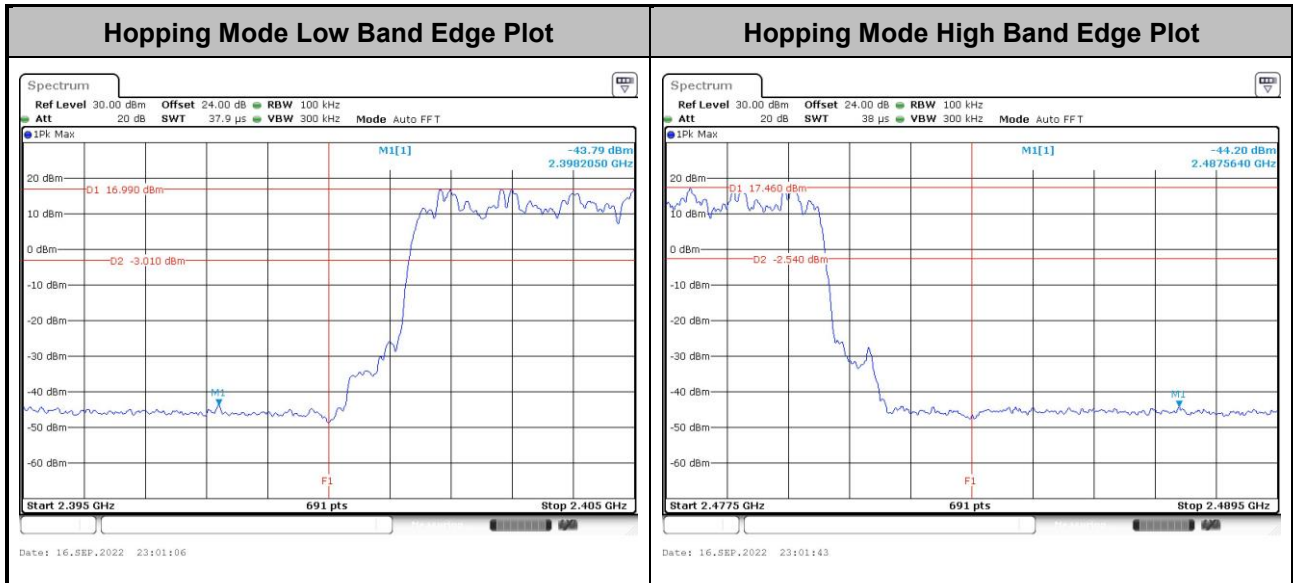



<3Mbps>

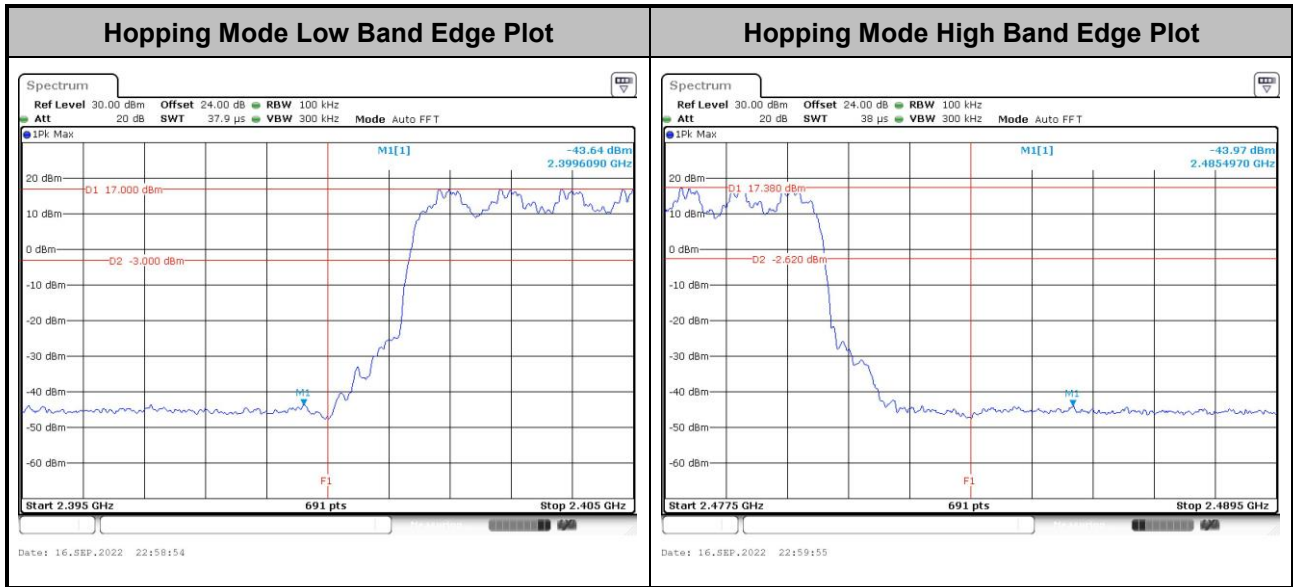



<Ant. 3>

<1Mbps>

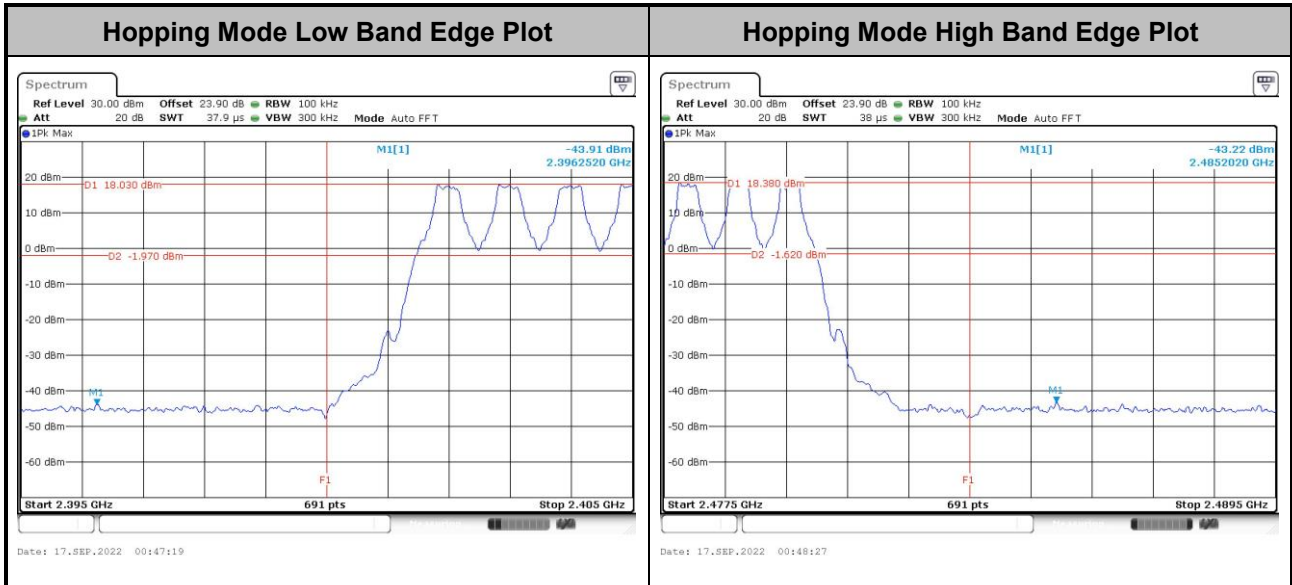

<2Mbps>

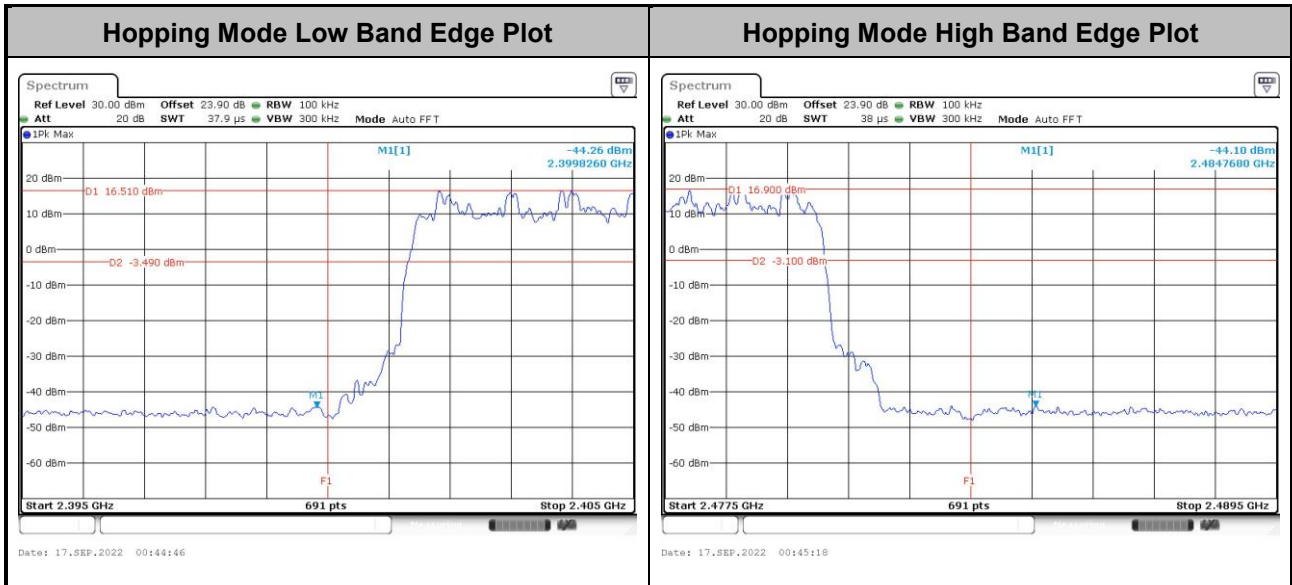



<3Mbps>

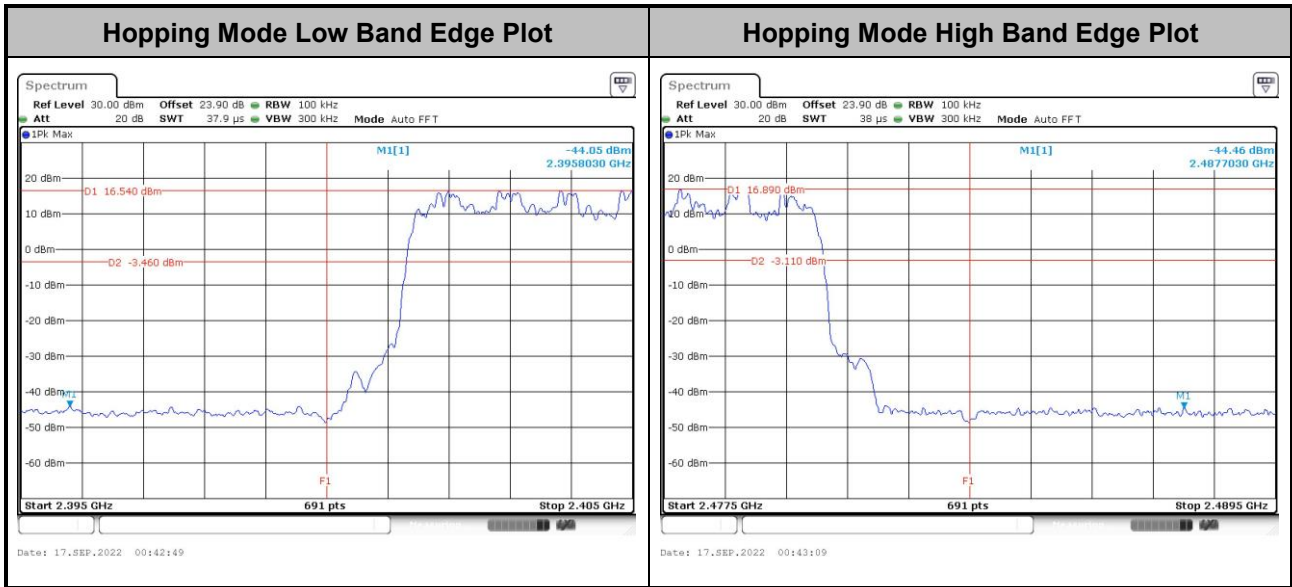

3.7 Conducted Spurious Emission Measurement

3.7.1 Limit of Spurious Emission Measurement

In any 100 kHz bandwidth outside the intentional radiation frequency band, the radio frequency power shall be at least 20 dB below the highest level of the radiated power. In addition, radiated emissions which fall in the restricted bands must also comply with the radiated emission limits.

3.7.2 Measuring Instruments

Please refer to the measuring equipment list in this test report.

3.7.3 Test Procedure

1. The testing follows ANSI C63.10-2013 clause 7.8.8.
2. The RF output of EUT is connected to the spectrum analyzer by RF cable and attenuator. The path loss is compensated to the results for each measurement.
3. Set the maximum power setting and enable the EUT to transmit continuously.
4. Set RBW = 100 kHz, VBW = 300 kHz, scan up through 10th harmonic. All harmonics / spurious must be at least 20 dB down from the highest emission level within the authorized band as measured with a 100 kHz RBW.
5. Measure and record the results in the test report.
6. The RF fundamental frequency should be excluded against the limit line in the operating frequency band.

3.7.4 Test Setup

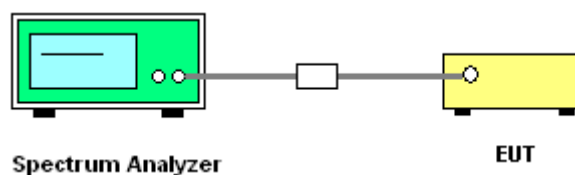



3.7.5 Test Result of Conducted Spurious Emission

<Ant. 4>

<1Mbps>

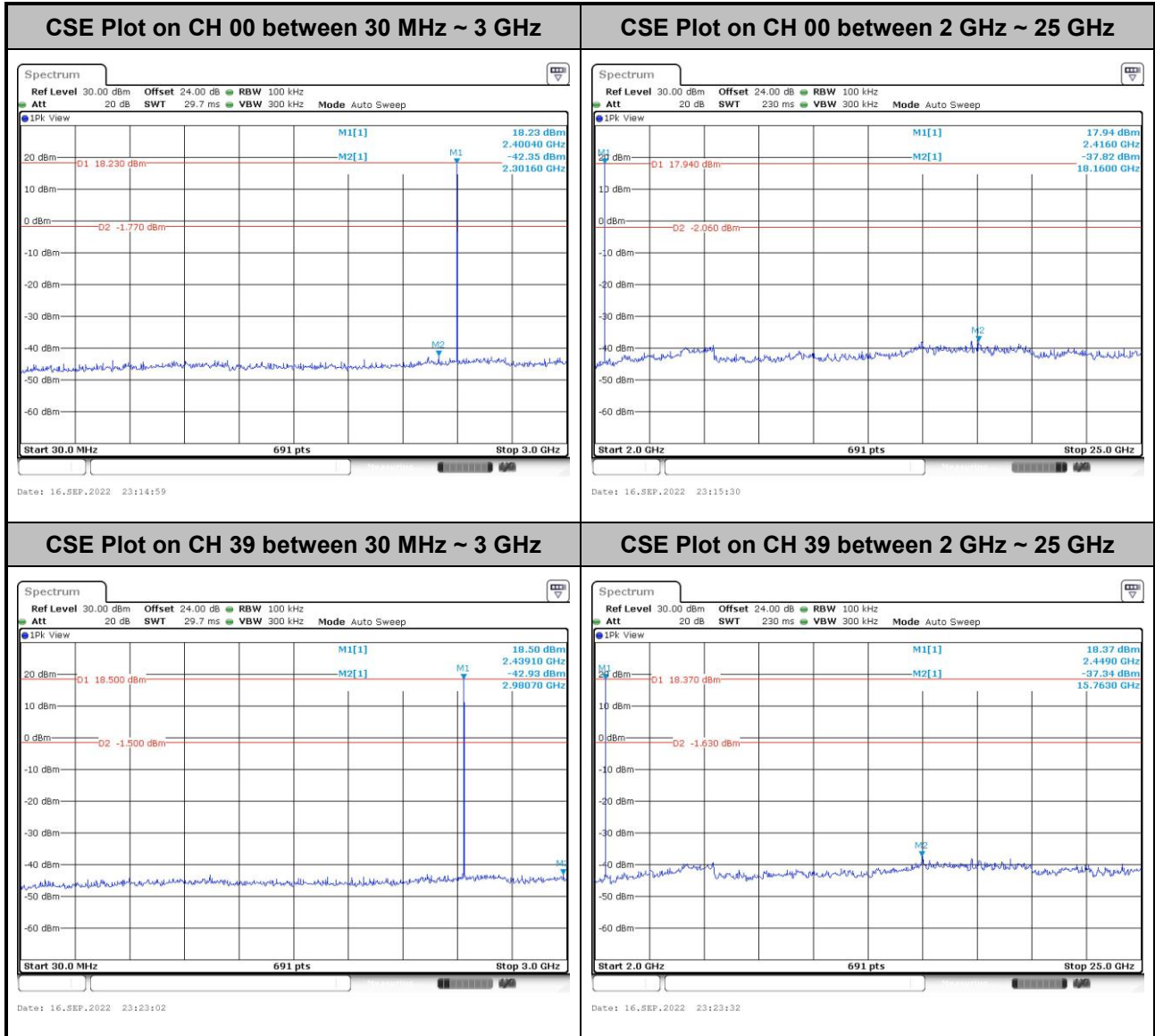

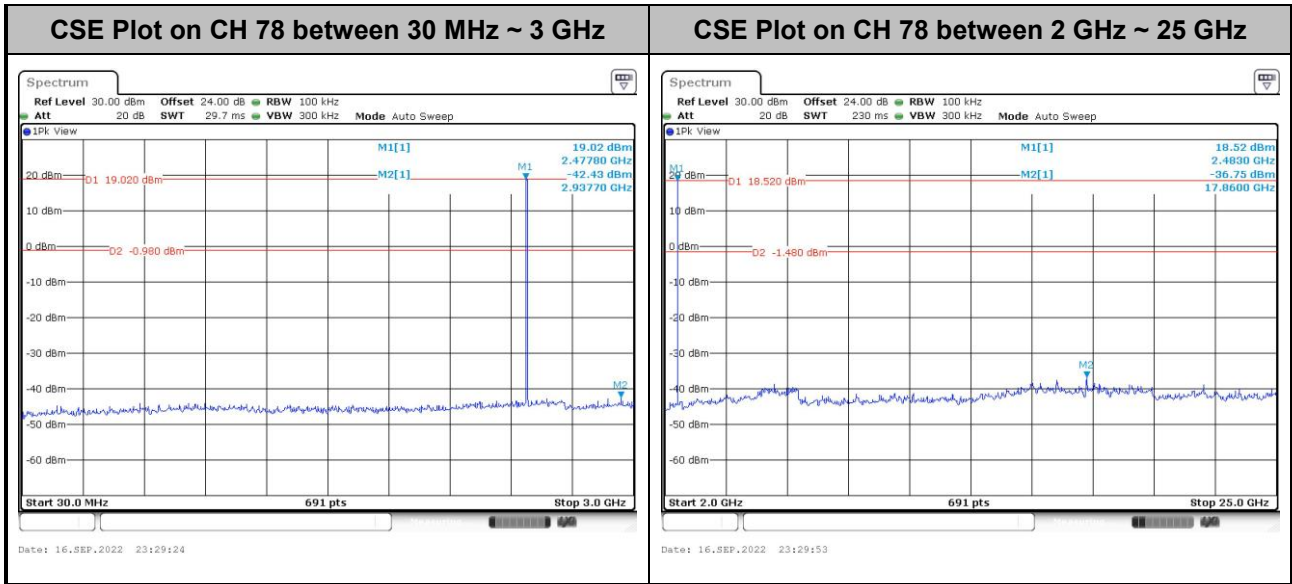



<2Mbps>

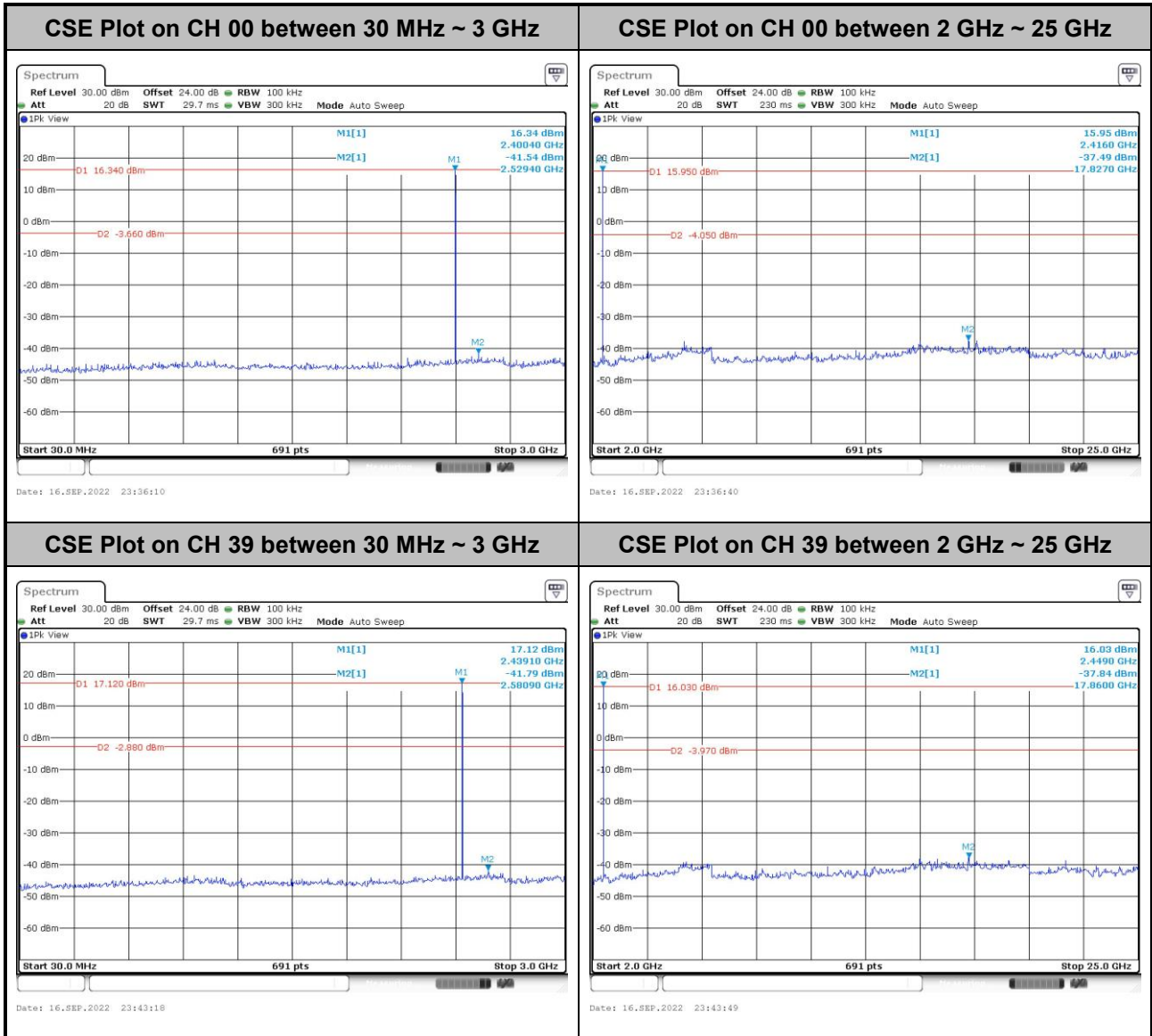

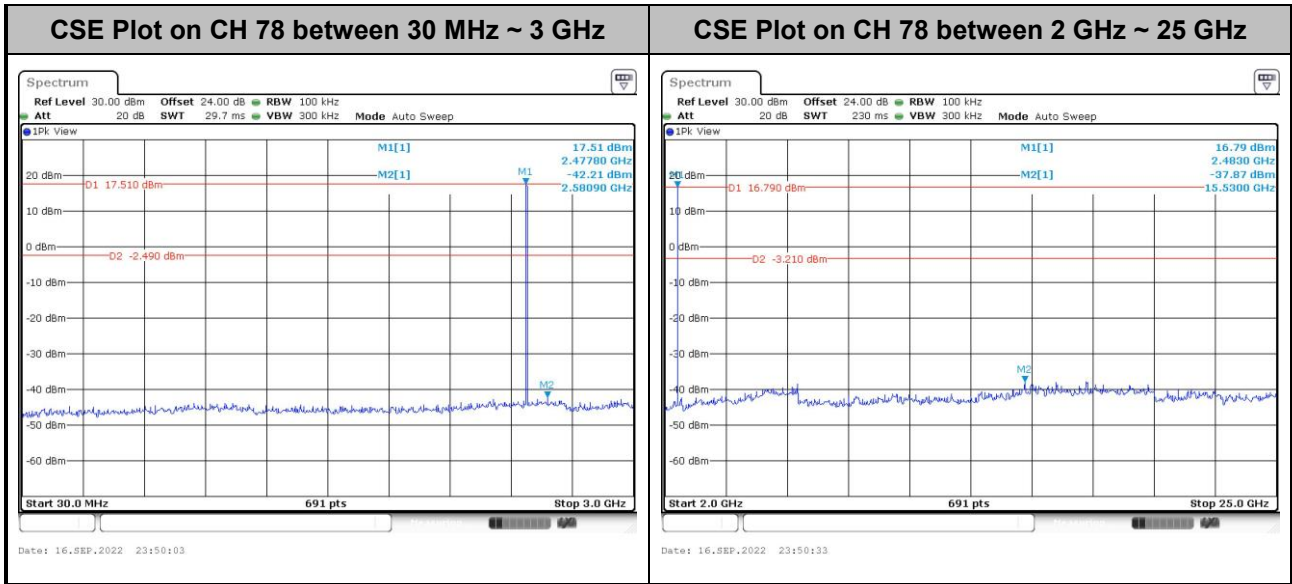



<3Mbps>

