

FCC Test Report

Report No.: RF200427C09-3 R1

FCC ID: A4RGUIK2

Model Name: GUIK2

Received Date: Apr. 27, 2020

Test Date: May 14 ~ Jun. 02, 2020

Issued Date: Jun. 30, 2020

Applicant: Google LLC

Address: 1600 Amphitheatre Parkway, Mountain View, CA 94043, USA

Issued By: Bureau Veritas Consumer Products Services (H.K.) Ltd., Taoyuan Branch
Lin Kou Laboratories

Lab Address: No. 47-2, 14th Ling, Chia Pau Vil., Lin Kou Dist., New Taipei City, Taiwan

Test Location: No.19, Hwa Ya 2nd Rd., Wen Hwa Vil., Kwei Shan Dist., Taoyuan City
33383, Taiwan

**FCC Registration /
Designation Number:** 788550 / TW0003



This report is for your exclusive use. Any copying or replication of this report to or for any other person or entity, or use of our name or trademark, is permitted only with our prior written permission. This report sets forth our findings solely with respect to the test samples identified herein. The results set forth in this report are not indicative or representative of the quality or characteristics of the lot from which a test sample was taken or any similar or identical product unless specifically and expressly noted. Our report includes all of the tests requested by you and the results thereof based upon the information that you provided to us. You have 60 days from date of issuance of this report to notify us of any material error or omission caused by our negligence, provided, however, that such notice shall be in writing and shall specifically address the issue you wish to raise. A failure to raise such issue within the prescribed time shall constitute your unqualified acceptance of the completeness of this report, the tests conducted and the correctness of the report contents. Unless specific mention, the uncertainty of measurement has been explicitly taken into account to declare the compliance or non-compliance to the specification. The report must not be used by the client to claim product certification, approval, or endorsement by TAF or any government agencies.

Table of Contents

Release Control Record	4
1 Certificate of Conformity	5
2 Summary of Test Results	6
2.1 Measurement Uncertainty	6
2.2 Modification Record	6
3 General Information	7
3.1 General Description of EUT	7
3.2 Description of Test Modes	8
3.2.1 Test Mode Applicability and Tested Channel Detail	9
3.3 Duty Cycle of Test Signal	10
3.4 Description of Support Units	11
3.4.1 Configuration of System under Test	11
3.5 General Description of Applied Standards and References	11
4 Test Types and Results	12
4.1 Radiated Emission and Bandedge Measurement	12
4.1.1 Limits of Radiated Emission and Bandedge Measurement	12
4.1.2 Test Instruments	13
4.1.3 Test Procedures	14
4.1.4 Deviation from Test Standard	14
4.1.5 Test Set Up	15
4.1.6 EUT Operating Conditions	16
4.1.7 Test Results	17
4.2 Conducted Emission Measurement	25
4.2.1 Limits of Conducted Emission Measurement	25
4.2.2 Test Instruments	25
4.2.3 Test Procedures	26
4.2.4 Deviation from Test Standard	26
4.2.5 Test Setup	26
4.2.6 EUT Operating Conditions	26
4.2.7 Test Results	27
4.3 6 dB Bandwidth Measurement	29
4.3.1 Limits of 6 dB Bandwidth Measurement	29
4.3.2 Test Setup	29
4.3.3 Test Instruments	29
4.3.4 Test Procedure	29
4.3.5 Deviation from Test Standard	29
4.3.6 EUT Operating Conditions	29
4.3.7 Test Result	30
4.4 Conducted Output Power Measurement	31
4.4.1 Limits of Conducted Output Power Measurement	31
4.4.2 Test Setup	31
4.4.3 Test Instruments	31
4.4.4 Test Procedures	31
4.4.5 Deviation from Test Standard	31
4.4.6 EUT Operating Conditions	31
4.4.7 Test Results	31
4.5 Power Spectral Density Measurement	32
4.5.1 Limits of Power Spectral Density Measurement	32
4.5.2 Test Setup	32
4.5.3 Test Instruments	32
4.5.4 Test Procedure	32
4.5.5 Deviation from Test Standard	32
4.5.6 EUT Operating Condition	32

4.5.7 Test Results	33
4.6 Conducted Out of Band Emission Measurement	34
4.6.1 Limits of Conducted Out of Band Emission Measurement.....	34
4.6.2 Test Setup.....	34
4.6.3 Test Instruments	34
4.6.4 Test Procedure	34
4.6.5 Deviation from Test Standard	34
4.6.6 EUT Operating Condition	34
4.6.7 Test Results	35
5 Pictures of Test Arrangements.....	36
Annex A- Band-edge measurement	37
Appendix – Information of the Testing Laboratories	39

Release Control Record

Issue No.	Description	Date Issued
RF200427C09-3	Original Release	Jun. 12, 2020
RF200427C09-3 R1	Updated power supply rating	Jun. 30, 2020

1 Certificate of Conformity

Product: Interactive Device
Model Name: GUIK2
Sample Status: Engineering Sample
Applicant: Google LLC
Test Date: May 14 ~ Jun. 02, 2020
Standards: 47 CFR FCC Part 15, Subpart C (Section 15.247)
ANSI C63.10:2013

The above equipment has been tested by **Bureau Veritas Consumer Products Services (H.K.) Ltd., Taoyuan Branch**, and found compliance with the requirement of the above standards. The test record, data evaluation & Equipment Under Test (EUT) configurations represented herein are true and accurate accounts of the measurements of the sample's RF characteristics under the conditions specified in this report.

Prepared by : Gina Liu , **Date:** Jun. 30, 2020
Gina Liu / Specialist

Approved by : Dylan Chiou , **Date:** Jun. 30, 2020
Dylan Chiou / Senior Project Engineer

2 Summary of Test Results

47 CFR FCC Part 15, Subpart C (Section 15.247)			
FCC Clause	Test Item	Result	Remarks
15.207	AC Power Conducted Emission	Pass	Meet the requirement of limit. Minimum passing margin is -8.75 dB at 0.61125 MHz.
15.205 / 15.209 / 15.247(d)	Radiated Emissions and Band Edge Measurement	Pass	Meet the requirement of limit. Minimum passing margin is -1.5 dB at 2483.5 MHz.
15.247(d)	Antenna Port Emission	Pass	Meet the requirement of limit.
15.247(a)(2)	6 dB Bandwidth	Pass	Meet the requirement of limit.
15.247(b)	Conducted power	Pass	Meet the requirement of limit.
15.247(e)	Power Spectral Density	Pass	Meet the requirement of limit.
15.203	Antenna Requirement	Pass	Antenna connector is i-pex(MHF) not a standard connector.

Note: Determining compliance based on the results of the compliance measurement, not taking into account measurement instrumentation uncertainty.

2.1 Measurement Uncertainty

Where relevant, the following measurement uncertainty levels have been estimated for tests performed on the EUT as specified in CISPR 16-4-2:

Measurement	Frequency	Expanded Uncertainty (k=2) (±)
Conducted Emissions at mains ports	150 kHz ~ 30 MHz	2.79 dB
Radiated Emissions up to 1 GHz	9 kHz ~ 30 MHz	3.04 dB
	30 MHz ~ 200 MHz	2.93 dB
	200 MHz ~ 1000 MHz	2.95 dB
Radiated Emissions above 1 GHz	1 GHz ~ 18 GHz	2.26 dB
	18 GHz ~ 40 GHz	1.94 dB

2.2 Modification Record

There were no modifications required for compliance.

3 General Information

3.1 General Description of EUT

Product	Interactive Device
Model Name	GUIK2
Status of EUT	Engineering Sample
Power Supply Rating	14.0 Vdc (adapter)
Modulation Type	O-QPSK
Modulation Technology	DSSS
Transfer Rate	250 kbps
Operating Frequency	2405 ~ 2475 MHz
Number of Channel	15
Output Power	104.954 mW
Antenna Type	PIFA antenna with 3.0 dBi gain
Antenna Connector	i-pex(MHF)
SN	1J365004810040204Q00135(MLB SN) SEM000061016 (FATP SN)
Accessory Device	Refer to Note as below
Data Cable Supplied	Refer to Note as below

Note:

1. The EUT's accessories list refers to Ext. Pho.
2. The above Antenna information is declared by manufacturer and for more detailed features description, please refer to the manufacturer's specifications, the laboratory shall not be held responsible.
3. The above EUT information is declared by manufacturer and for more detailed features description, please refers to the manufacturer's specifications or user's manual.

3.2 Description of Test Modes

15 channels are provided to this EUT:

Channel	Frequency (MHz)	Channel	Frequency (MHz)
11	2405	19	2445
12	2410	20	2450
13	2415	21	2455
14	2420	22	2460
15	2425	23	2465
16	2430	24	2470
17	2435	25	2475
18	2440		

3.2.1 Test Mode Applicability and Tested Channel Detail

EUT Configure Mode	Applicable To				Description
	RE \geq 1G	RE<1G	PLC	APCM	
-	√	√	√	√	-

Where **RE \geq 1G**: Radiated Emission above 1 GHz **RE<1G**: Radiated Emission below 1 GHz
PLC: Power Line Conducted Emission **APCM**: Antenna Port Conducted Measurement

NOTE: The EUT had been pre-tested on the positioned of each 3 axis. The worst case was found when positioned on **Z-plane**.
NOTE: “-” means no effect.

Radiated Emission Test (Above 1 GHz):

- Pre-Scan has been conducted to determine the worst-case mode from all possible combinations between available modulations, data rates and antenna ports (if EUT with antenna diversity architecture).
- Following channel(s) was (were) selected for the final test as listed below.

EUT Configure Mode	Available Channel	Tested Channel	Modulation Technology	Modulation Type
-	11 to 25	11, 18, 25	DSSS	O-QPSK

Radiated Emission Test (Below 1 GHz):

- Pre-Scan has been conducted to determine the worst-case mode from all possible combinations between available modulations, data rates and antenna ports (if EUT with antenna diversity architecture).
- Following channel(s) was (were) selected for the final test as listed below.

EUT Configure Mode	Available Channel	Tested Channel	Modulation Technology	Modulation Type
-	11 to 25	25	OFDM	O-QPSK

Power Line Conducted Emission Test:

- Pre-Scan has been conducted to determine the worst-case mode from all possible combinations between available modulations, data rates and antenna ports (if EUT with antenna diversity architecture).
- Following channel(s) was (were) selected for the final test as listed below.

EUT Configure Mode	Available Channel	Tested Channel	Modulation Technology	Modulation Type
-	11 to 25	25	OFDM	O-QPSK

Bandedge Measurement:

- Pre-Scan has been conducted to determine the worst-case mode from all possible combinations between available modulations, data rates and antenna ports (if EUT with antenna diversity architecture).
- Following channel(s) was (were) selected for the final test as listed below.

EUT Configure Mode	Available Channel	Tested Channel	Modulation Technology	Modulation Type
-	11 to 25	11, 25	OFDM	O-QPSK

Antenna Port Conducted Measurement:

- This item includes all test value of each mode, but only includes spectrum plot of worst value of each mode.
- Pre-Scan has been conducted to determine the worst-case mode from all possible combinations between available modulations, data rates and antenna ports (if EUT with antenna diversity architecture).
- Following channel(s) was (were) selected for the final test as listed below.

EUT Configure Mode	Available Channel	Tested Channel	Modulation Technology	Modulation Type
-	11 to 25	11, 18, 25	OFDM	O-QPSK

Test Condition:

Applicable To	Environmental Conditions	Input Power	Tested by
RE≥1G	25 deg. C, 65 % RH	120 Vac, 60 Hz	Getaz Yang
RE<1G	25 deg. C, 65 % RH	120 Vac, 60 Hz	Getaz Yang
PLC	25 deg. C, 65 % RH	120 Vac, 60 Hz	Jisyong Wang
APCM	25 deg. C, 65 % RH	120 Vac, 60 Hz	Gavin Wu

3.3 Duty Cycle of Test Signal

Duty cycle = 2.169/15.962 = 0.136, Duty factor = 10 * log(1/0.136) = 8.67

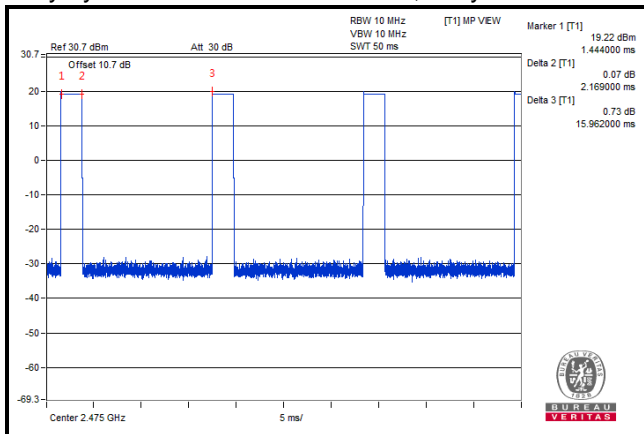

3.4 Description of Support Units

The EUT has been tested as an independent unit together with other necessary accessories or support units.

3.4.1 Configuration of System under Test

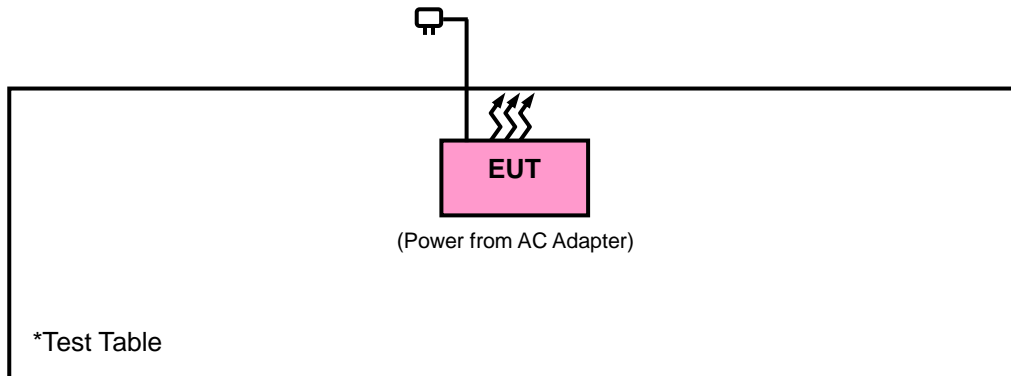

3.5 General Description of Applied Standards and References

The EUT is a RF Product. According to the specifications of the manufacturer, it must comply with the requirements of the following standards and references:

Test Standard:

FCC Part 15, Subpart C (15.247)

ANSI C63.10-2013

All test items have been performed and recorded as per the above standards.

References Test Guidance:

KDB 558074 D01 15.247 Meas Guidance v05r02

KDB 414788 D01 Radiated Test Site v01r01

All test items have been performed as a reference to the above KDB test guidance.

4 Test Types and Results

4.1 Radiated Emission and Bandedge Measurement

4.1.1 Limits of Radiated Emission and Bandedge Measurement

Radiated emissions which fall in the restricted bands must comply with the radiated emission limits specified as below table. Other emissions shall be at least 20 dB below the highest level of the desired power:

Frequencies (MHz)	Field Strength (microvolts/meter)	Measurement Distance (meters)
0.009 ~ 0.490	2400/F (kHz)	300
0.490 ~ 1.705	24000/F (kHz)	30
1.705 ~ 30.0	30	30
30 ~ 88	100	3
88 ~ 216	150	3
216 ~ 960	200	3
Above 960	500	3

NOTE:

1. The lower limit shall apply at the transition frequencies.
2. Emission level (dBuV/m) = 20 log Emission level (uV/m).
3. For frequencies above 1000 MHz, the field strength limits are based on average detector, however, the peak field strength of any emission shall not exceed the maximum permitted average limits, specified above by more than 20 dB under any condition of modulation.

4.1.2 Test Instruments

Description & Manufacturer	Model No.	Serial No.	Date of Calibration	Due Date of Calibration
Test Receiver Agilent	N9038A	MY51210203	Mar. 18, 2020	Mar. 17, 2021
Spectrum Analyzer Agilent	N9010A	MY52220314	Dec. 12, 2019	Dec. 11, 2020
Spectrum Analyzer ROHDE & SCHWARZ	FSU43	101261	Apr. 16, 2020	Apr. 15, 2021
Spectrum Analyzer ROHDE & SCHWARZ	FSW26	102023	Oct. 08, 2019	Oct. 07, 2020
Broadband Horn Antenna SCHWARZBECK	BBHA 9170	148	Nov. 24, 2019	Nov. 23, 2020
HORN Antenna SCHWARZBECK	BBHA 9120D	9120D-969	Nov. 24, 2019	Nov. 23, 2020
BILOG Antenna SCHWARZBECK	VULB 9168	9168-472	Nov. 08, 2019	Nov. 07, 2020
Fixed Attenuator WOKEN	MDCS18N-10	MDCS18N-10-01	Apr. 14, 2020	Apr. 13, 2021
Loop Antenna	HLA 6121	45745	Jul. 01, 2019	Jun. 30, 2020
Preamplifier EMCI	EMC001340	980201	Oct. 14, 2019	Oct. 13, 2020
Preamplifier EMCI	EMC 012645	980115	Oct. 08, 2019	Oct. 07, 2020
Preamplifier EMCI	EMC 184045	980116	Oct. 08, 2019	Oct. 07, 2020
Preamplifier EMCI	EMC 330H	980112	Oct. 08, 2019	Oct. 07, 2020
Power Meter Anritsu	ML2495A	1012010	Sep. 04, 2019	Sep. 03, 2020
Power Sensor Anritsu	MA2411B	1315050	Sep. 04, 2019	Sep. 03, 2020
RF Coaxial Cable HUBER+SUHNNER	EMC104-SM-SM-8 000&3000	140811+170717	Oct. 08, 2019	Oct. 07, 2020
RF Coaxial Cable HUBER+SUHNNER	SUCOFLEX 104	EMC104-SM-SM-1 000(140807)	Oct. 08, 2019	Oct. 07, 2020
RF Coaxial Cable WOKEN	8D-FB	Cable-Ch10-01	Oct. 08, 2019	Oct. 07, 2020
Software BV ADT	E3 6.120103	NA	NA	NA
Antenna Tower MF	MFA-440H	NA	NA	NA
Turn Table MF	MFT-201SS	NA	NA	NA
Antenna Tower & Turn Table Controller MF	MF-7802	NA	NA	NA

Note: 1. The calibration interval of the above test instruments is 12 months and the calibrations are traceable to NML/ROC and NIST/USA.

2. The test was performed in HwaYa Chamber 10.

4.1.3 Test Procedures

For Radiated Emission below 30 MHz

- a. The EUT was placed on the top of a rotating table 0.8 meters above the ground at a 3 meter chamber room. The table was rotated 360 degrees to determine the position of the highest radiation.
- b. The EUT was set 3 meters away from the interference-receiving antenna, which was mounted on the top of a variable-height antenna tower.
- c. Parallel, perpendicular, and ground-parallel orientations of the antenna are set to make the measurement.
- d. For each suspected emission, the EUT was arranged to its worst case and the rotatable table was turned from 0 degrees to 360 degrees to find the maximum reading.
- e. The test-receiver system was set to Quasi-Peak Detect Function and Specified Bandwidth with Maximum Hold Mode.

Note:

1. The resolution bandwidth and video bandwidth of test receiver/spectrum analyzer is 9 kHz at frequency below 30 MHz.

For Radiated Emission above 30 MHz

- a. The EUT was placed on the top of a rotating table 0.8 meters (for 30 MHz ~ 1 GHz) / 1.5 meters (for above 1 GHz) above the ground at 3 meter chamber room for test. The table was rotated 360 degrees to determine the position of the highest radiation.
- b. The EUT was set 3 meters away from the interference-receiving antenna, which was mounted on the top of a variable-height antenna tower.
- c. The height of antenna is varied from one meter to four meters above the ground to determine the maximum value of the field strength. Both horizontal and vertical polarizations of the antenna are set to make the measurement.
- d. For each suspected emission, the EUT was arranged to its worst case and then the antenna was tuned to heights from 1 meter to 4 meters and the rotatable table was turned from 0 degrees to 360 degrees to find the maximum reading.
- e. The test-receiver system was set to quasi-peak detect function and specified bandwidth with maximum hold mode when the test frequency is below 1 GHz.
- f. The test-receiver system was set to peak and average detected function and specified bandwidth with maximum hold mode when the test frequency is above 1 GHz. If the peak reading value also meets average limit, measurement with the average detector is unnecessary.

Note:

1. The resolution bandwidth and video bandwidth of test receiver/spectrum analyzer is 120 kHz for Quasi-peak detection (QP) or Peak detection (PK) at frequency below 1 GHz.
2. The resolution bandwidth of test receiver/spectrum analyzer is 1 MHz and the video bandwidth is 3 MHz for Peak detection (PK) at frequency above 1 GHz.
3. The resolution bandwidth of test receiver/spectrum analyzer is 1 MHz and the video bandwidth is $\geq 1/T$ (Duty cycle < 98 %) or 10 Hz (Duty cycle ≥ 98 %) for Average detection (AV) at frequency above 1 GHz. (RBW = 1 MHz, VBW = 1 kHz)
4. All modes of operation were investigated and the worst-case emissions are reported.

4.1.4 Deviation from Test Standard

No deviation.

4.1.5 Test Set Up

<Radiated Emission below 30 MHz>

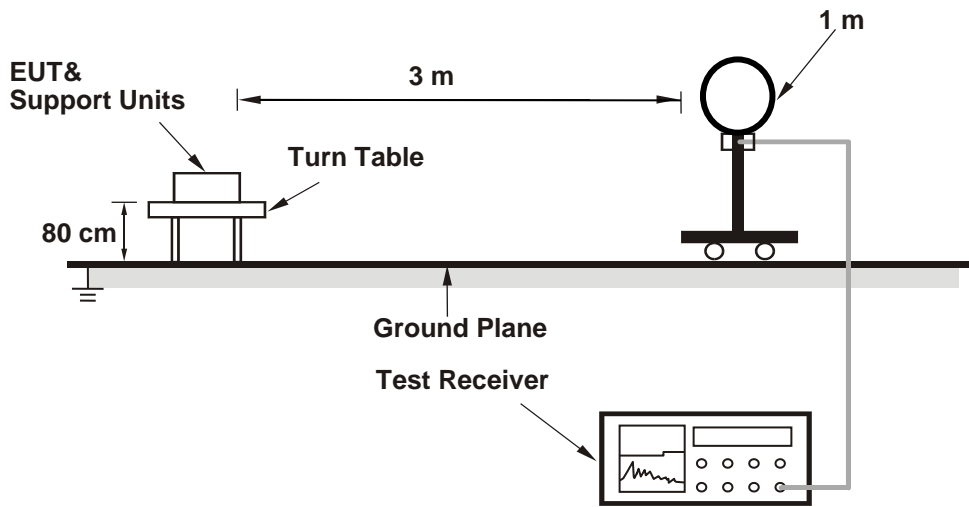

<Radiated Emission 30 MHz to 1 GHz>

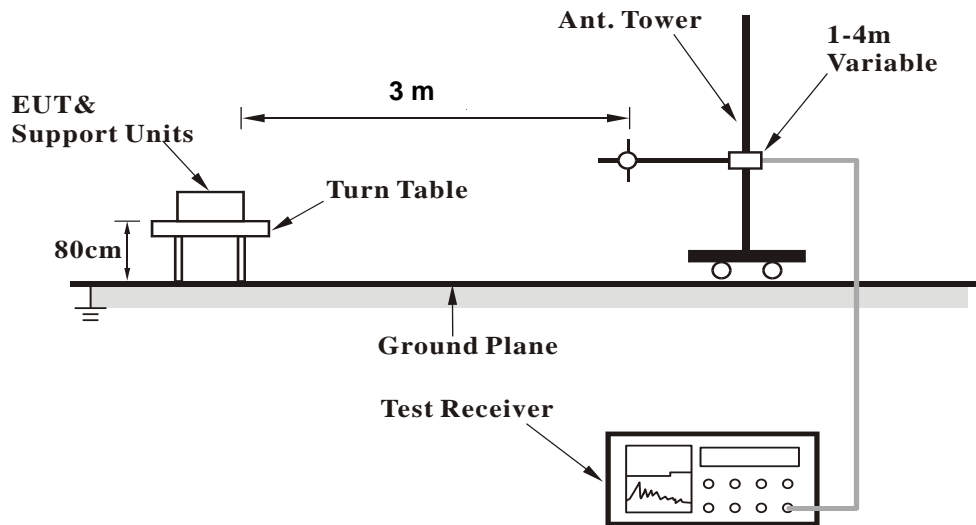

<Radiated Emission above 1 GHz>

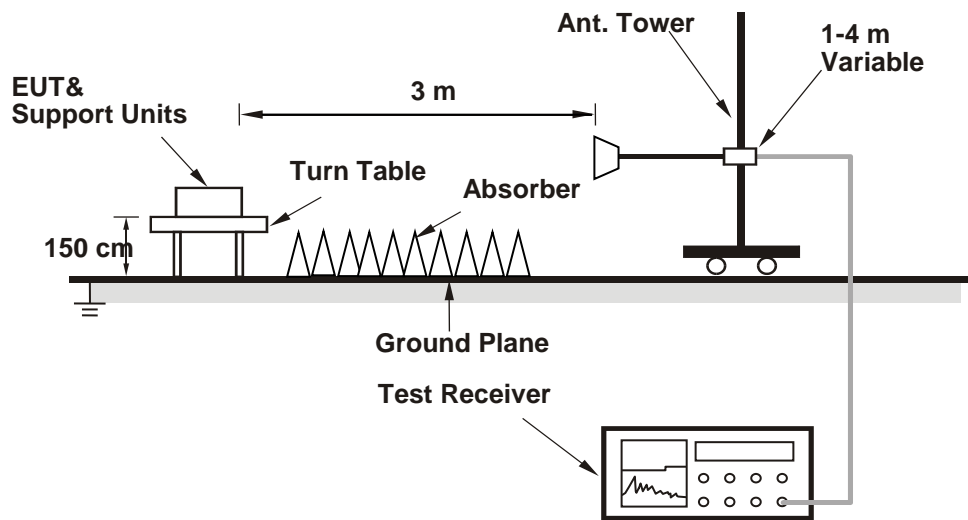

For the actual test configuration, please refer to the attached file (Test Setup Photo).

KDB 414788 OATS and Chamber Correlation Justification

- Based on FCC 15.31 (f) (2): measurements may be performed at a distance closer than that specified in regulations; however, an attempt should be made to avoid making measurements in the near field.
- Open-field site and chamber correlation testing had been performed and chamber measured test result is the worst case test result.

4.1.6 EUT Operating Conditions

- a. Placed the EUT on a testing table.
- b. Use the software to control the EUT under transmission condition continuously at specific channel frequency.

4.1.7 Test Results

Above 1 GHz Data :

EUT Test Condition		Measurement Detail	
Channel	Channel 11	Frequency Range	1 GHz ~ 25 GHz
Input Power	120 Vac, 60 Hz	Detector Function	Peak (PK) Average (AV)
Environmental Conditions	25 deg. C, 65 % RH	Tested By	Getaz Yang

Horizontal

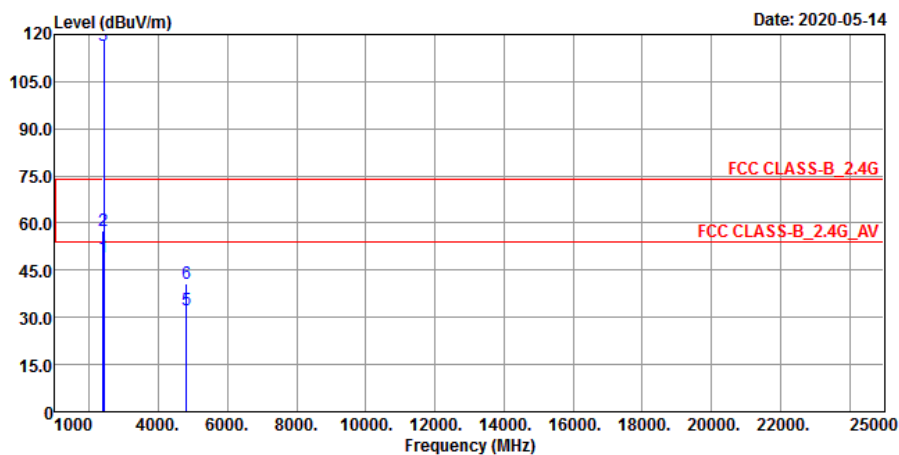

Vertical

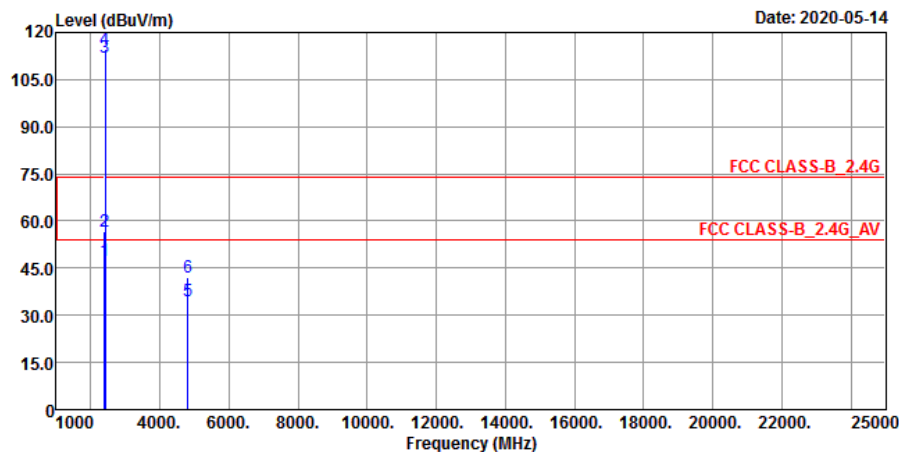

Antenna Polarity & Test Distance: Horizontal at 3 m

Frequency (MHz)	Emission Level (dBuV/m)	Read Level (dBuV)	Factor (dB/m)	Limit (dBuV/m)	Margin (dB)	Antenna Height (cm)	Table Angle (Degree)	Remark
2390	49.08	55	-5.92	54	-4.92	226	335	Average
2390	57.75	63.67	-5.92	74	-16.25	226	335	Peak
2405	116.35	122.29	-5.94	-----	-----	226	335	Average
2405	118.64	124.58	-5.94	-----	-----	226	335	Peak
4810	32.42	48.06	-15.64	54	-21.58	180	16	Average
4810	40.67	56.31	-15.64	74	-33.33	180	16	Peak

Antenna Polarity & Test Distance: Vertical at 3 m

Frequency (MHz)	Emission Level (dBuV/m)	Read Level (dBuV)	Factor (dB/m)	Limit (dBuV/m)	Margin (dB)	Antenna Height (cm)	Table Angle (Degree)	Remark
2390	47.55	53.47	-5.92	54	-6.45	306	4	Average
2390	56.81	62.73	-5.92	74	-17.19	306	4	Peak
2405	112.18	118.12	-5.94	-----	-----	306	4	Average
2405	114.87	120.81	-5.94	-----	-----	306	4	Peak
4810	34.69	50.33	-15.64	54	-19.31	206	303	Average
4810	42.06	57.7	-15.64	74	-31.94	206	303	Peak

Remarks:

- Emission Level = Read Level + Factor
Margin value = Emission level – Limit value
- 2405 MHz: Fundamental frequency.
- The emission levels of other frequencies were very low against the limit.

EUT Test Condition		Measurement Detail	
Channel	Channel 18	Frequency Range	1 GHz ~ 25 GHz
Input Power	120 Vac, 60 Hz	Detector Function	Peak (PK) Average (AV)
Environmental Conditions	25 deg. C, 65 % RH	Tested By	Getaz Yang

Horizontal

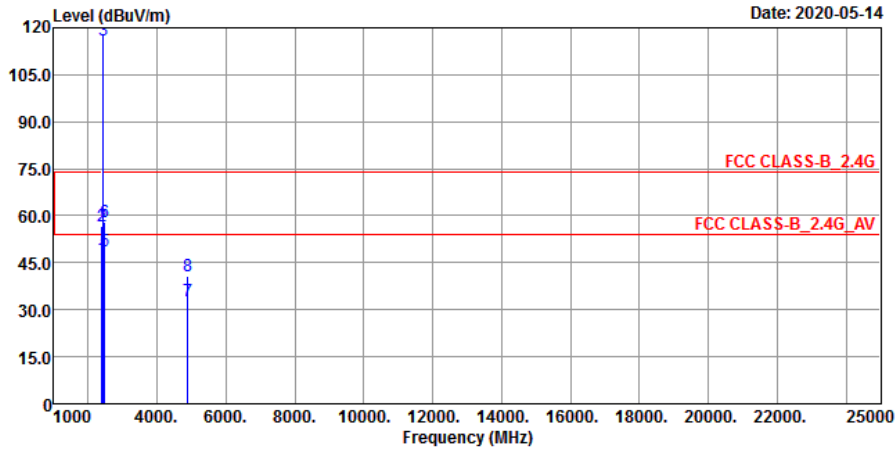

Vertical

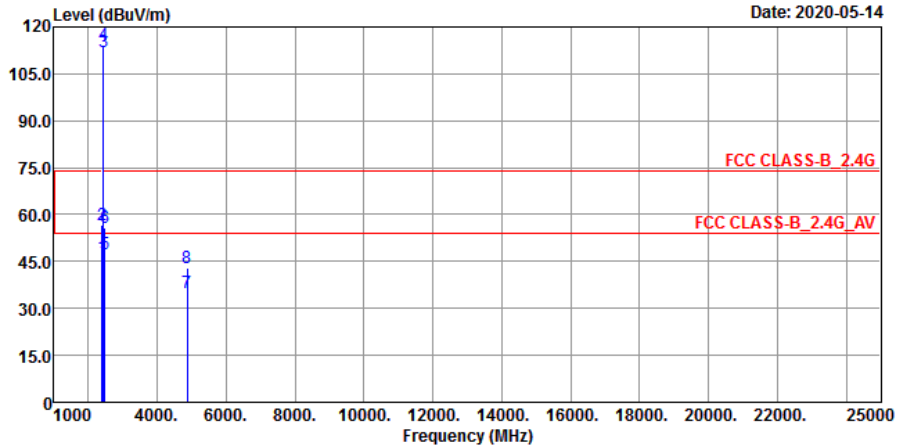

Antenna Polarity & Test Distance: Horizontal at 3 m

Frequency (MHz)	Emission Level (dBuV/m)	Read Level (dBuV)	Factor (dB/m)	Limit (dBuV/m)	Margin (dB)	Antenna Height (cm)	Table Angle (Degree)	Remark
2390	46.49	52.41	-5.92	54	-7.51	224	334	Average
2390	56.53	62.45	-5.92	74	-17.47	224	334	Peak
2440	115.95	121.83	-5.88	-----	-----	224	334	Average
2440	118.3	124.18	-5.88	-----	-----	224	334	Peak
2483.5	48.61	54.31	-5.7	54	-5.39	224	334	Average
2483.5	57.99	63.69	-5.7	74	-16.01	224	334	Peak
4880	32.95	48.51	-15.56	54	-21.05	189	12	Average
4880	40.8	56.36	-15.56	74	-33.2	189	12	Peak

Antenna Polarity & Test Distance: Vertical at 3 m

Frequency (MHz)	Emission Level (dBuV/m)	Read Level (dBuV)	Factor (dB/m)	Limit (dBuV/m)	Margin (dB)	Antenna Height (cm)	Table Angle (Degree)	Remark
2390	46.42	52.34	-5.92	54	-7.58	302	0	Average
2390	56.52	62.44	-5.92	74	-17.48	302	0	Peak
2440	112	117.88	-5.88	-----	-----	302	0	Average
2440	114.37	120.25	-5.88	-----	-----	302	0	Peak
2483.5	47.24	52.94	-5.7	54	-6.76	302	0	Average
2483.5	56	61.7	-5.7	74	-18	302	0	Peak
4875	35.19	50.75	-15.56	54	-18.81	202	301	Average
4875	42.81	58.37	-15.56	74	-31.19	202	301	Peak

Remarks:

- Emission Level = Read Level + Factor
Margin value = Emission level – Limit value
- 2440 MHz: Fundamental frequency.
- The emission levels of other frequencies were very low against the limit.

EUT Test Condition		Measurement Detail	
Channel	Channel 25	Frequency Range	1 GHz ~ 25 GHz
Input Power	120 Vac, 60 Hz	Detector Function	Peak (PK) Average (AV)
Environmental Conditions	25 deg. C, 65 % RH	Tested By	Getaz Yang

Horizontal

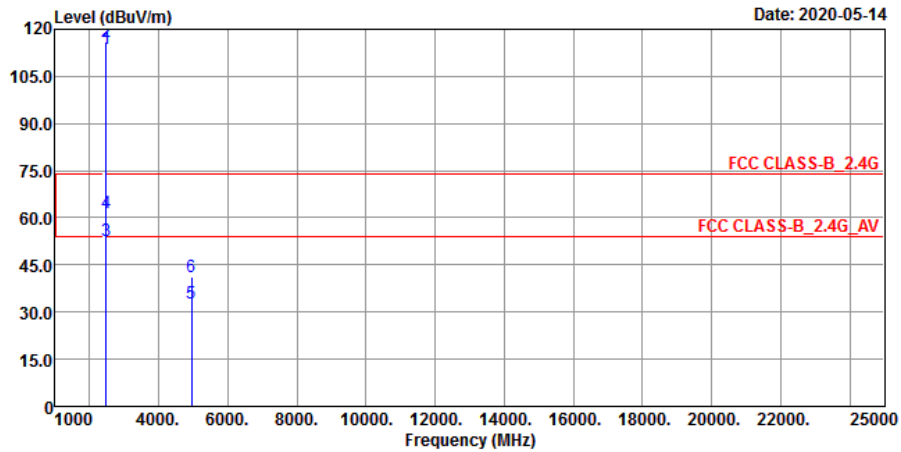

Vertical

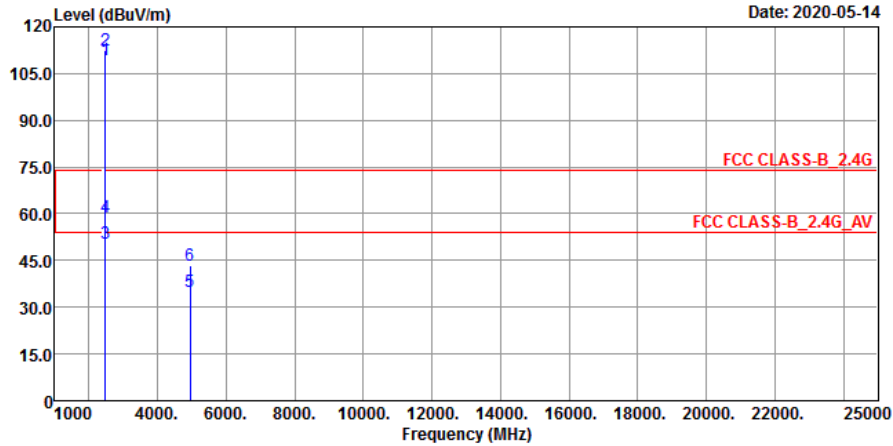

Antenna Polarity & Test Distance: Horizontal at 3 m

Frequency (MHz)	Emission Level (dBuV/m)	Read Level (dBuV)	Factor (dB/m)	Limit (dBuV/m)	Margin (dB)	Antenna Height (cm)	Table Angle (Degree)	Remark
2475	113.75	119.46	-5.71	-----	-----	194	334	Average
2475	116.2	121.91	-5.71	-----	-----	194	334	Peak
2483.5	52.5	58.2	-5.7	54	-1.5	194	334	Average
2483.5	61.47	67.17	-5.7	74	-12.53	194	334	Peak
4950	32.89	48.37	-15.48	54	-21.11	189	24	Average
4950	41.26	56.74	-15.48	74	-32.74	189	24	Peak

Antenna Polarity & Test Distance: Vertical at 3 m

Frequency (MHz)	Emission Level (dBuV/m)	Read Level (dBuV)	Factor (dB/m)	Limit (dBuV/m)	Margin (dB)	Antenna Height (cm)	Table Angle (Degree)	Remark
2475	109.55	115.26	-5.71	-----	-----	319	0	Average
2475	112.26	117.97	-5.71	-----	-----	319	0	Peak
2483.5	50.4	56.1	-5.7	54	-3.6	319	0	Average
2483.5	59.05	64.75	-5.7	74	-14.95	319	0	Peak
4950	34.97	50.45	-15.48	54	-19.03	203	294	Average
4950	43.37	58.85	-15.48	74	-30.63	203	294	Peak

Remarks:

- Emission Level = Read Level + Factor
Margin value = Emission level – Limit value
- 2475 MHz: Fundamental frequency.
- The emission levels of other frequencies were very low against the limit.

Below 1 GHz Worst-Case Data:

EUT Test Condition		Measurement Detail	
Channel	Channel 25	Frequency Range	Below 1000 MHz
Input Power	120 Vac, 60 Hz	Detector Function	Peak (PK) Quasi-peak (QP)
Environmental Conditions	25 deg. C, 65 % RH	Tested By	Getaz Yang

Horizontal

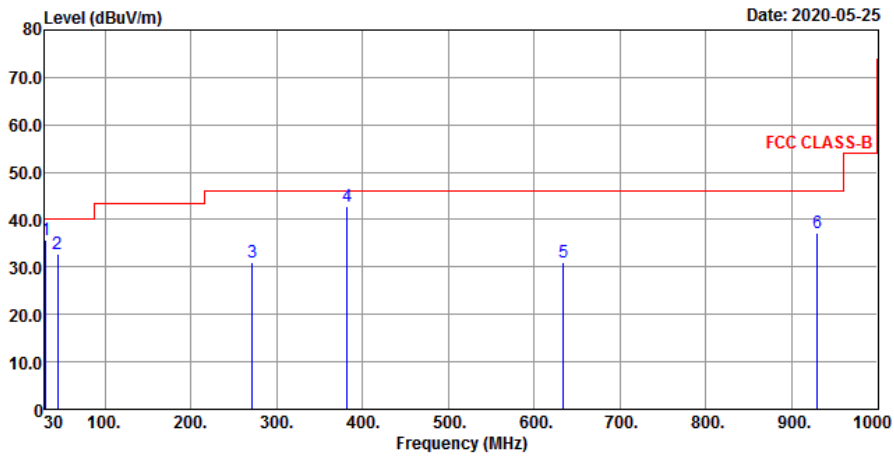

Vertical

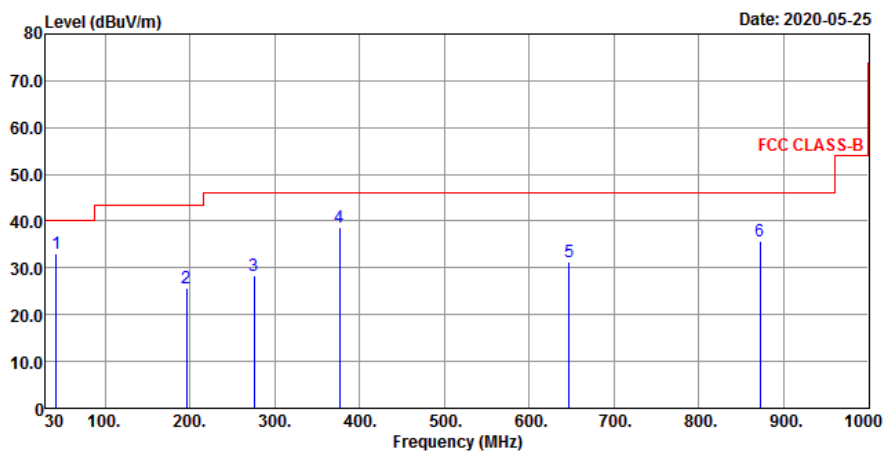

Antenna Polarity & Test Distance: Horizontal at 3 m

Frequency (MHz)	Emission Level (dBuV/m)	Read Level (dBuV)	Factor (dB/m)	Limit (dBuV/m)	Margin (dB)	Antenna Height (cm)	Table Angle (Degree)	Remark
30.97	35.78	49.07	-13.29	40	-4.22	106	274	QP
44.55	32.89	44.76	-11.87	40	-7.11	124	169	QP
271.53	31.14	43.19	-12.05	46	-14.86	136	245	Peak
382.11	42.69	51.39	-8.7	46	-3.31	117	40	Peak
634.31	31.07	32.81	-1.74	46	-14.93	137	140	Peak
930.16	37.16	33.73	3.43	46	-8.84	104	338	Peak

Antenna Polarity & Test Distance: Vertical at 3 m

Frequency (MHz)	Emission Level (dBuV/m)	Read Level (dBuV)	Factor (dB/m)	Limit (dBuV/m)	Margin (dB)	Antenna Height (cm)	Table Angle (Degree)	Remark
42.61	32.95	44.93	-11.98	40	-7.05	109	153	QP
195.87	25.63	40.62	-14.99	43.5	-17.87	116	259	Peak
275.41	28.3	40.2	-11.9	46	-17.7	120	216	Peak
376.29	38.74	47.56	-8.82	46	-7.26	106	168	Peak
646.92	31.35	32.98	-1.63	46	-14.65	110	169	Peak
871.96	35.82	33.12	2.7	46	-10.18	109	297	Peak

Remarks:

- Emission Level = Read Level + Factor
Margin value = Emission level – Limit value
- The emission levels of other frequencies were very low against the limit.

4.2 Conducted Emission Measurement

4.2.1 Limits of Conducted Emission Measurement

Frequency (MHz)	Conducted Limit (dBuV)	
	Quasi-Peak	Average
0.15 - 0.5	66 - 56	56 - 46
0.50 - 5.0	56	46
5.0 - 30.0	60	50

- Note: 1. The lower limit shall apply at the transition frequencies.
 2. The limit decreases in line with the logarithm of the frequency in the range of 0.15 to 0.50 MHz.

4.2.2 Test Instruments

Description & Manufacturer	Model No.	Serial No.	Date of Calibration	Due Date of Calibration
Test Receiver ROHDE & SCHWARZ	ESR3	102412	Feb. 17, 2020	Feb. 16, 2021
RF signal cable (with 10dB PAD) Woken	5D-FB	Cable-cond2-01	Sep. 05, 2019	Sep. 04, 2020
LISN ROHDE & SCHWARZ (EUT)	ESH2-Z5	100100	Jan. 20, 2020	Jan. 19, 2021
LISN ROHDE & SCHWARZ (Peripheral)	ESH3-Z5	100312	Aug. 13, 2019	Aug. 12, 2020
Software ADT	BV ADT_Cond_ V7.3.7.4	NA	NA	NA

- Note: 1. The calibration interval of the above test instruments is 12 months and the calibrations are traceable to NML/ROC and NIST/USA.
 2. The test was performed in HwaYa Shielded Room 2.
 3. The VCCI Site Registration No. is C-12047.

4.2.3 Test Procedures

- a. The EUT was placed 0.4 meters from the conducting wall of the shielded room with EUT being connected to the power mains through a line impedance stabilization network (LISN). Other support units were connected to the power mains through another LISN. The two LISNs provide 50 ohm/50 uH of coupling impedance for the measuring instrument.
- b. Both lines of the power mains connected to the EUT were checked for maximum conducted interference.
- c. The frequency range from 150 kHz to 30 MHz was searched. Emission levels under (Limit – 20 dB) was not recorded.

Note: All modes of operation were investigated and the worst-case emissions are reported.

4.2.4 Deviation from Test Standard

No deviation.

4.2.5 Test Setup

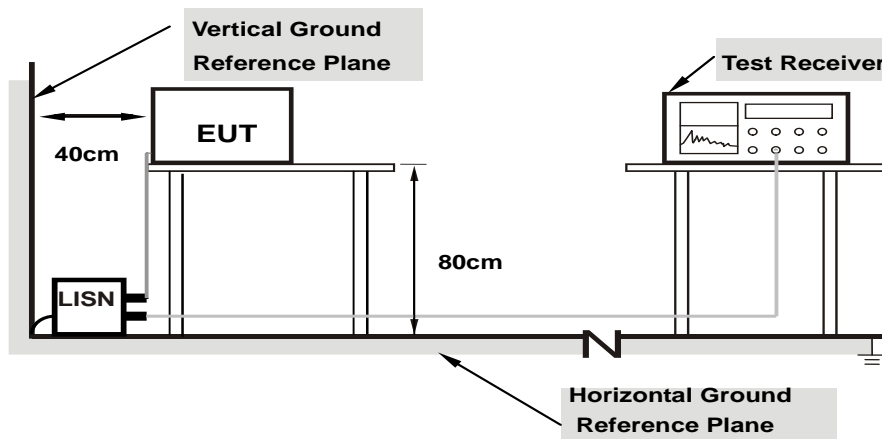

Note: 1. Support units were connected to second LISN.

For the actual test configuration, please refer to the attached file (Test Setup Photo).

4.2.6 EUT Operating Conditions

- a. Placed the EUT on a testing table.
- b. Use the software to control the EUT under transmission condition continuously at specific channel frequency.

4.2.7 Test Results

Frequency Range	150kHz ~ 30MHz	Detector Function & Resolution Bandwidth	Quasi-Peak (QP) / Average (AV), 9kHz
Input Power	120Vac, 60Hz	Environmental Conditions	25°C, 65%RH
Tested by	Jisyong Wang	Test Date	2020/6/2

Phase Of Power : Line (L)										
No	Frequency (MHz)	Correction Factor (dB)	Reading Value (dBuV)		Emission Level (dBuV)		Limit (dBuV)		Margin (dB)	
			Q.P.	AV.	Q.P.	AV.	Q.P.	AV.	Q.P.	AV.
1	0.17698	10.16	36.15	30.38	46.31	40.54	64.63	54.63	-18.32	-14.09
2	0.23662	10.18	31.00	25.06	41.18	35.24	62.21	52.21	-21.03	-16.97
3	0.30075	10.19	26.45	21.82	36.64	32.01	60.22	50.22	-23.58	-18.21
4	0.61215	10.22	33.37	26.61	43.59	36.83	56.00	46.00	-12.41	-9.17
5	1.32225	10.27	15.80	9.19	26.07	19.46	56.00	46.00	-29.93	-26.54
6	2.71725	10.33	10.98	5.84	21.31	16.17	56.00	46.00	-34.69	-29.83

Remarks:

1. Q.P. and AV. are abbreviations of quasi-peak and average individually.
2. The emission levels of other frequencies were very low against the limit.
3. Margin value = Emission level – Limit value
4. Correction factor = Insertion loss + Cable loss
5. Emission Level = Correction Factor + Reading Value

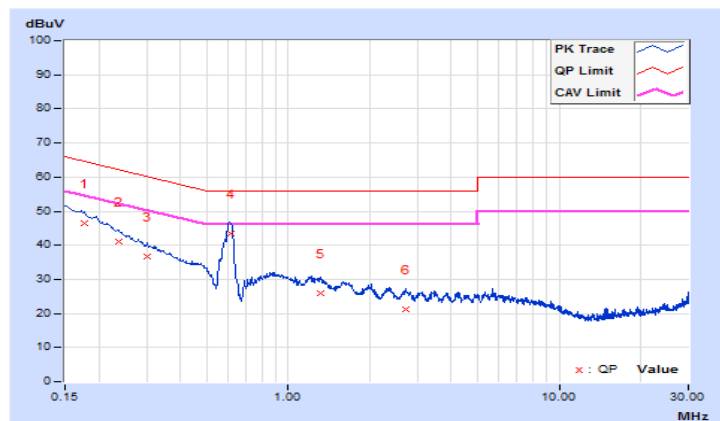

Frequency Range	150kHz ~ 30MHz	Detector Function & Resolution Bandwidth	Quasi-Peak (QP) / Average (AV), 9kHz
Input Power	120Vac, 60Hz	Environmental Conditions	25°C, 65%RH
Tested by	Jisyong Wang	Test Date	2020/6/2

Phase Of Power : Neutral (N)										
No	Frequency (MHz)	Correction Factor (dB)	Reading Value (dBuV)		Emission Level (dBuV)		Limit (dBuV)		Margin (dB)	
			Q.P.	AV.	Q.P.	AV.	Q.P.	AV.	Q.P.	AV.
1	0.20356	10.13	32.23	25.83	42.36	35.96	63.46	53.46	-21.10	-17.50
2	0.24000	10.14	29.44	21.82	39.58	31.96	62.10	52.10	-22.52	-20.14
3	0.34517	10.17	24.42	20.15	34.59	30.32	59.08	49.08	-24.49	-18.76
4	0.61125	10.20	34.65	27.05	44.85	37.25	56.00	46.00	-11.15	-8.75
5	1.32900	10.25	15.88	9.09	26.13	19.34	56.00	46.00	-29.87	-26.66
6	8.35350	10.52	6.24	5.03	16.76	15.55	60.00	50.00	-43.24	-34.45

Remarks:

1. Q.P. and AV. are abbreviations of quasi-peak and average individually.
2. The emission levels of other frequencies were very low against the limit.
3. Margin value = Emission level – Limit value
4. Correction factor = Insertion loss + Cable loss
5. Emission Level = Correction Factor + Reading Value

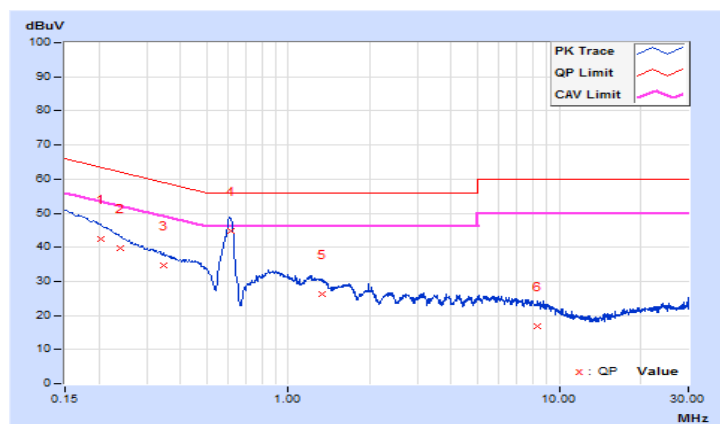

4.3 6 dB Bandwidth Measurement

4.3.1 Limits of 6 dB Bandwidth Measurement

The minimum of 6 dB Bandwidth Measurement is 0.5 MHz.

4.3.2 Test Setup

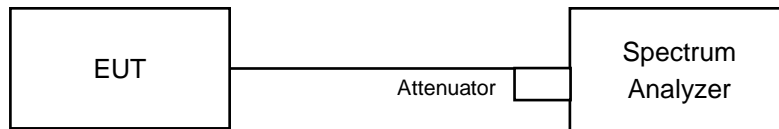

4.3.3 Test Instruments

Refer to section 4.1.2 to get information of above instrument.

4.3.4 Test Procedure

- Set resolution bandwidth (RBW) = 100 kHz
- Set the video bandwidth (VBW) $\geq 3 \times$ RBW, Detector = Peak.
- Trace mode = max hold.
- Sweep = auto couple.
- Measure the maximum width of the emission that is constrained by the frequencies associated with the two amplitude points (upper and lower) that are attenuated by 6 dB relative to the maximum level measured in the fundamental emission

4.3.5 Deviation from Test Standard

No deviation.

4.3.6 EUT Operating Conditions

The software provided by client to enable the EUT under transmission condition continuously at lowest, middle and highest channel frequencies individually.

4.3.7 Test Result

Channel	Frequency (MHz)	6 dB Bandwidth (MHz)	Minimum Limit (MHz)	Pass / Fail
11	2405	1.57	0.5	Pass
18	2440	1.51	0.5	Pass
25	2475	1.59	0.5	Pass

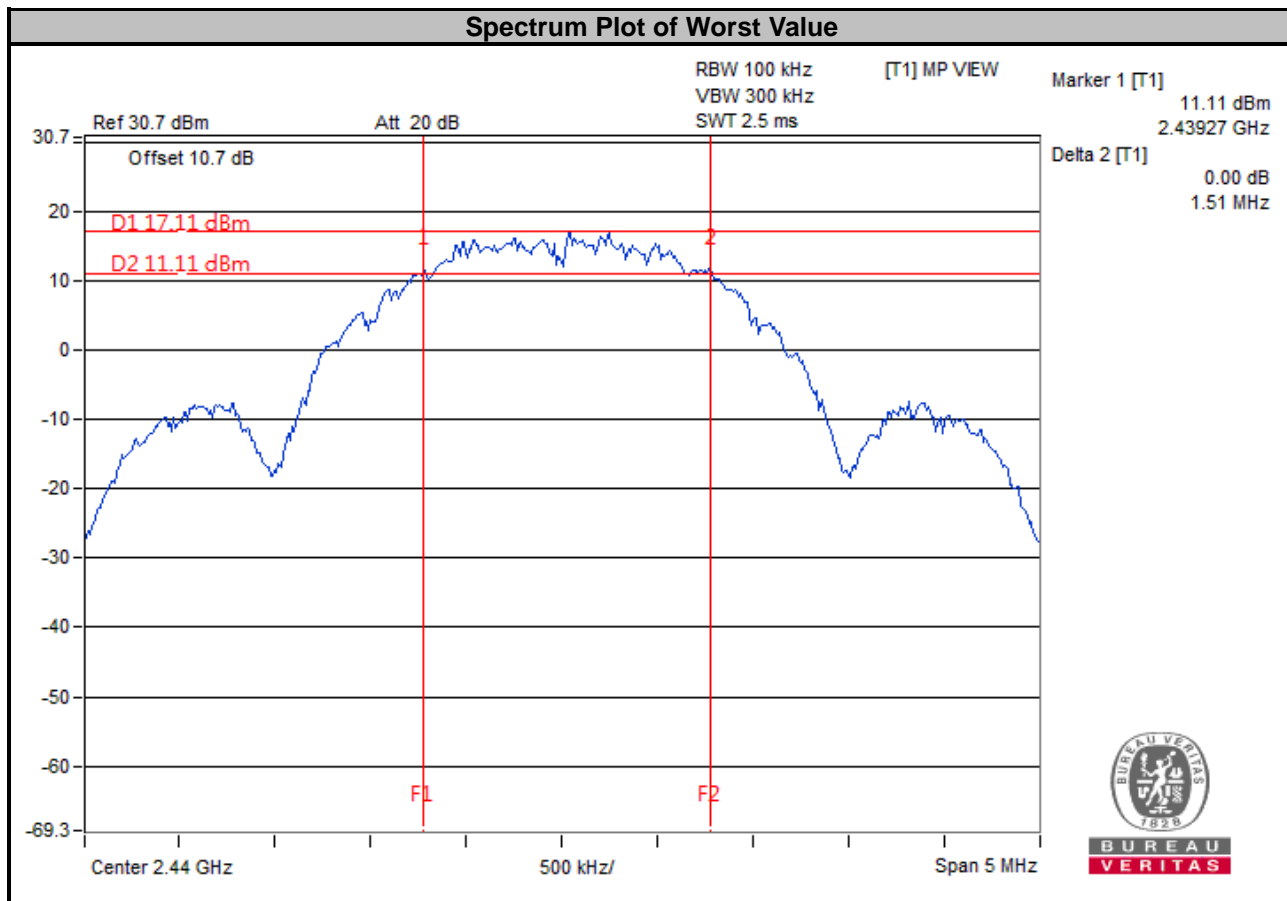

4.4 Conducted Output Power Measurement

4.4.1 Limits of Conducted Output Power Measurement

For systems using digital modulation in the 2400–2483.5 MHz bands: 1 Watt (30 dBm)

4.4.2 Test Setup

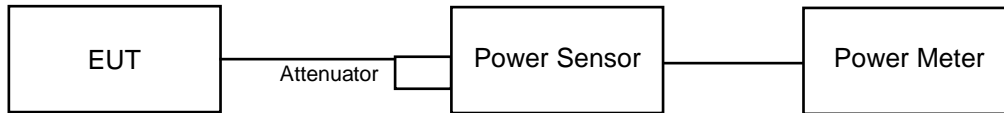

4.4.3 Test Instruments

Refer to section 4.1.2 to get information of above instrument.

4.4.4 Test Procedures

A peak power sensor was used on the output port of the EUT. A power meter was used to read the response of the peak power sensor. Record the power level.

Average power sensor was used to perform output power measurement, trigger and gating function of wide band power meter is enabled to measure max output power of TX on burst. Duty factor is not added to measured value.

4.4.5 Deviation from Test Standard

No deviation.

4.4.6 EUT Operating Conditions

The software provided by client to enable the EUT under transmission condition continuously at lowest, middle and highest channel frequencies individually.

4.4.7 Test Results

Channel	Frequency (MHz)	Peak Power (mW)	Peak Power (dBm)	Limit (dBm)	Pass / Fail
11	2405	104.954	20.21	30	Pass
18	2440	102.565	20.11	30	Pass
25	2475	72.946	18.63	30	Pass

Channel	Frequency (MHz)	Average Power (mW)	Average Power (dBm)	Limit (dBm)	Pass / Fail
11	2405	101.158	20.05	30	Pass
18	2440	99.083	19.96	30	Pass
25	2475	71.285	18.53	30	Pass

4.5 Power Spectral Density Measurement

4.5.1 Limits of Power Spectral Density Measurement

The Maximum of Power Spectral Density Measurement is 8 dBm in any 3 kHz band during any time interval of continuous transmission.

4.5.2 Test Setup

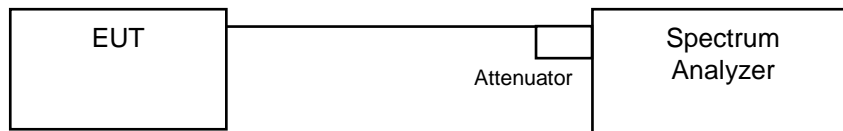

4.5.3 Test Instruments

Refer to section 4.1.2 to get information of above instrument.

4.5.4 Test Procedure

- Set the RBW = 3 kHz, VBW = 10 kHz, Detector = peak.
- Sweep time = auto couple, Trace mode = max hold, allow trace to fully stabilize.
- Use the peak marker function to determine the maximum power level in any 100 kHz band segment within the fundamental EBW.

4.5.5 Deviation from Test Standard

No deviation.

4.5.6 EUT Operating Condition

The software provided by client to enable the EUT under transmission condition continuously at lowest, middle and highest channel frequencies individually.

4.5.7 Test Results

Channel	Frequency (MHz)	PSD (dBm/3 kHz)	Limit (dBm/3 kHz)	Pass / Fail
11	2405	6.82	8	Pass
18	2440	7.91	8	Pass
25	2475	3.39	8	Pass

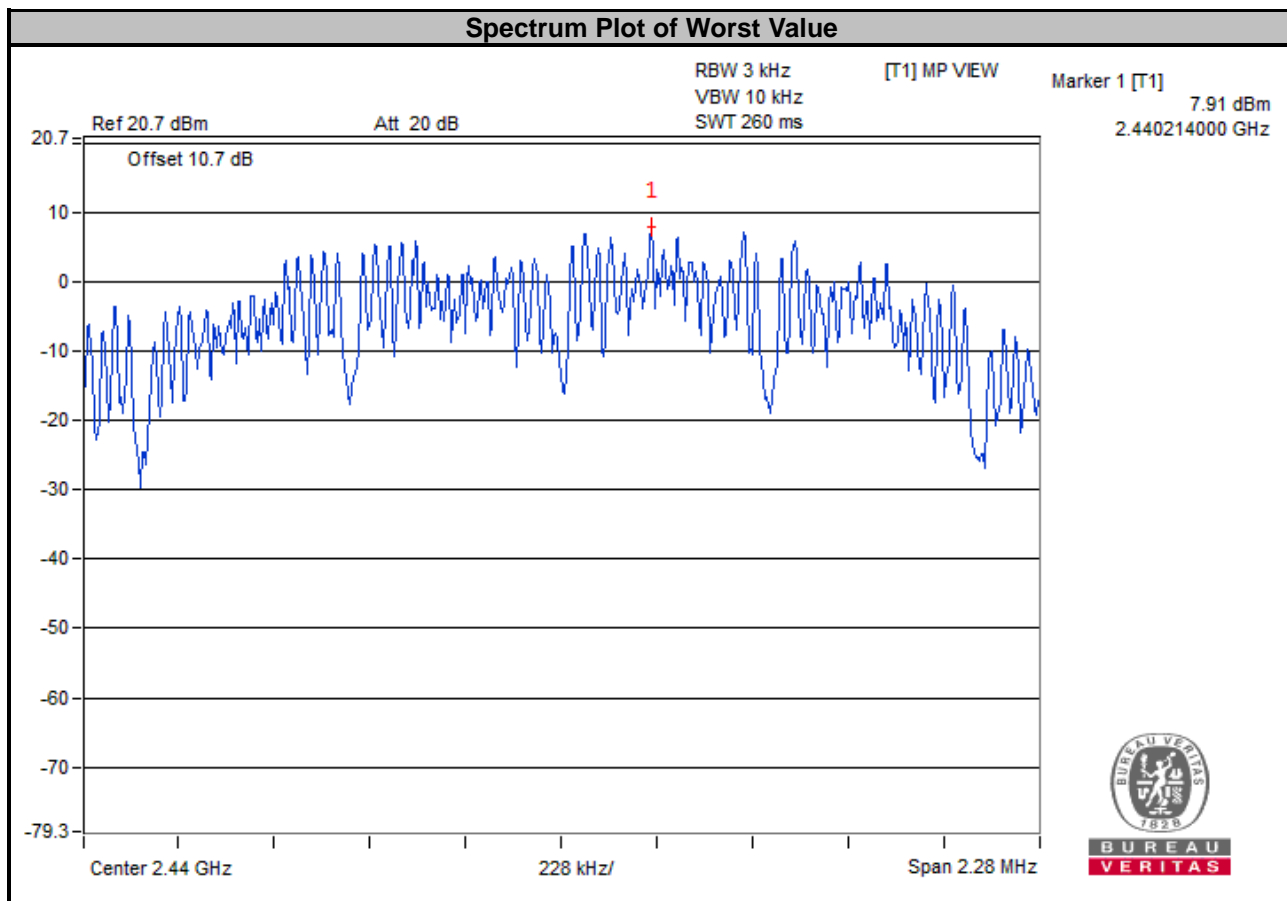

4.6 Conducted Out of Band Emission Measurement

4.6.1 Limits of Conducted Out of Band Emission Measurement

Below -20 dB of the highest emission level of operating band (in 100 kHz Resolution Bandwidth).

4.6.2 Test Setup

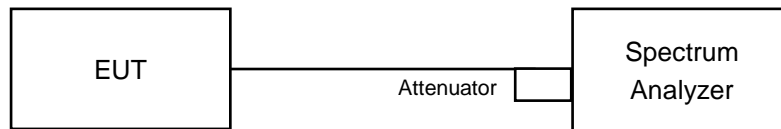

4.6.3 Test Instruments

Refer to section 4.1.2 to get information of above instrument.

4.6.4 Test Procedure

MEASUREMENT PROCEDURE REF

1. Set the RBW = 100 kHz.
2. Set the VBW \geq 300 kHz.
3. Detector = peak.
4. Sweep time = auto couple.
5. Trace mode = max hold.
6. Allow trace to fully stabilize.
7. Use the peak marker function to determine the maximum power level in any 100 kHz band segment within the fundamental EBW.

MEASUREMENT PROCEDURE OOB

1. Set RBW = 100 kHz.
2. Set VBW \geq 300 kHz.
3. Detector = peak.
4. Sweep = auto couple.
5. Trace Mode = max hold.
6. Allow trace to fully stabilize.
7. Use the peak marker function to determine the maximum amplitude level.

4.6.5 Deviation from Test Standard

No deviation.

4.6.6 EUT Operating Condition

The software provided by client to enable the EUT under transmission condition continuously at lowest, middle and highest channel frequencies individually.

4.6.7 Test Results

The spectrum plots are attached on the following images. D1 line indicates the highest level, and D2 line indicates the 20 dB offset below D1. It shows compliance with the requirement.

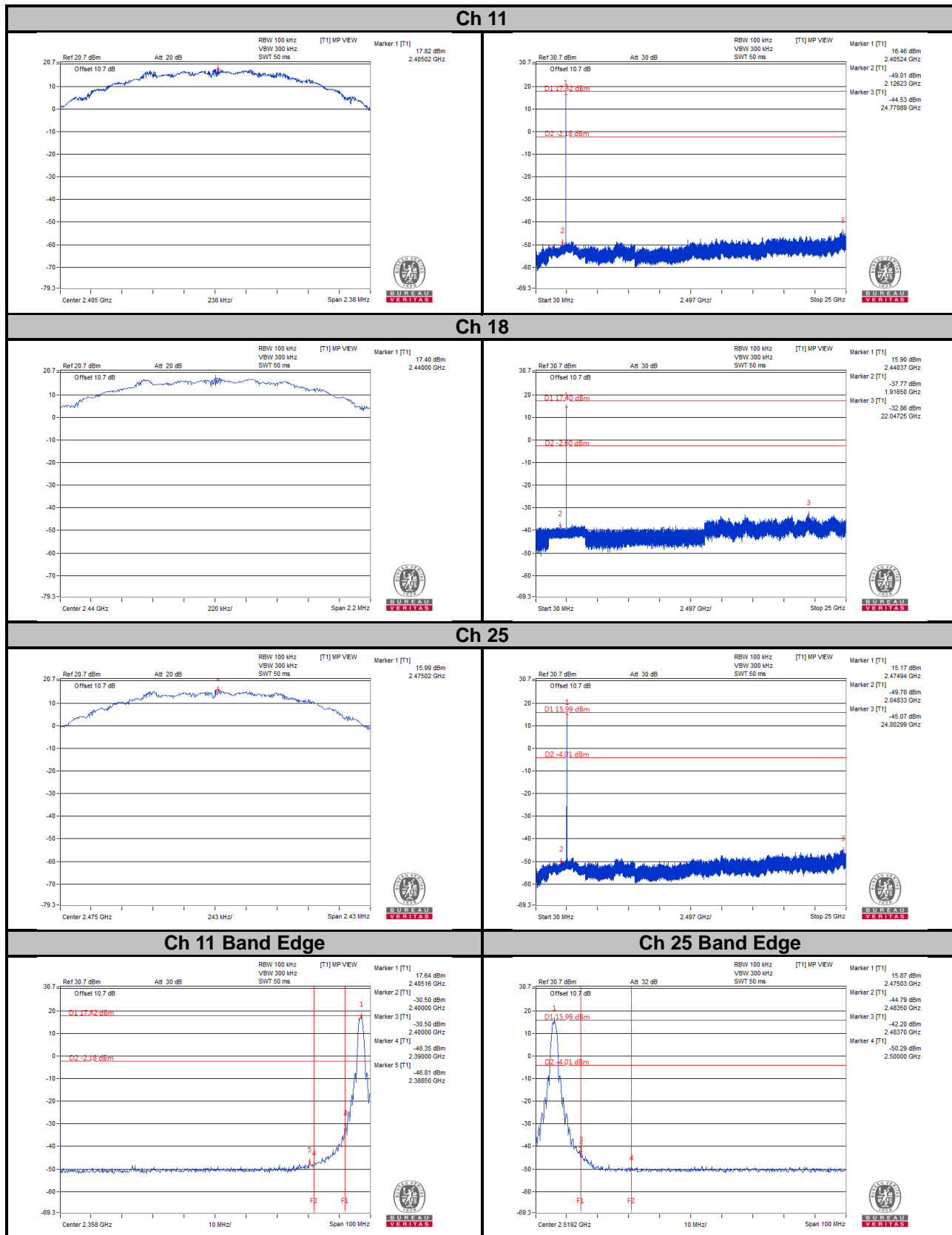

5 Pictures of Test Arrangements

Please refer to the attached file (Test Setup Photo).

Annex A- Band-edge measurement

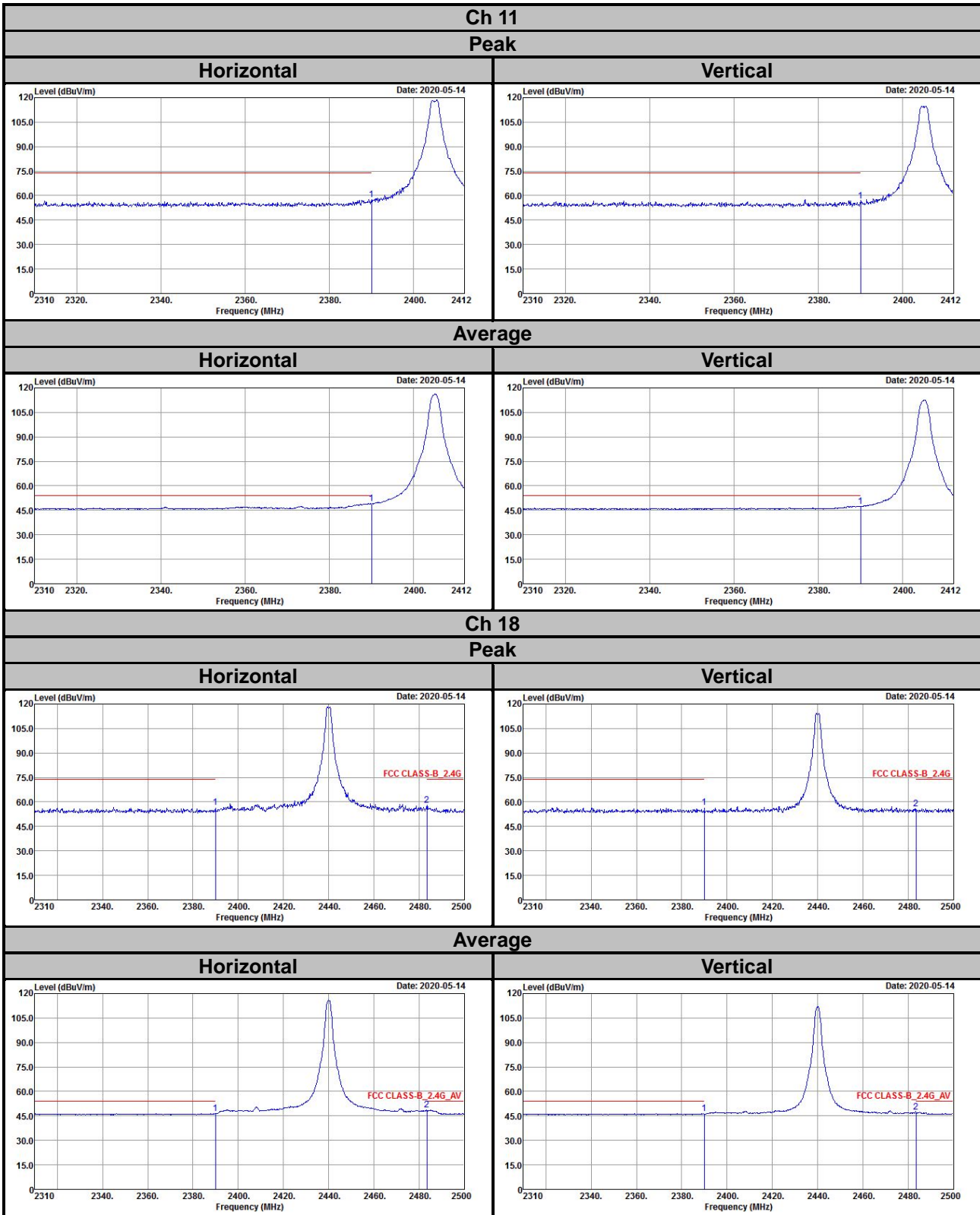

Ch 25

Peak

Horizontal

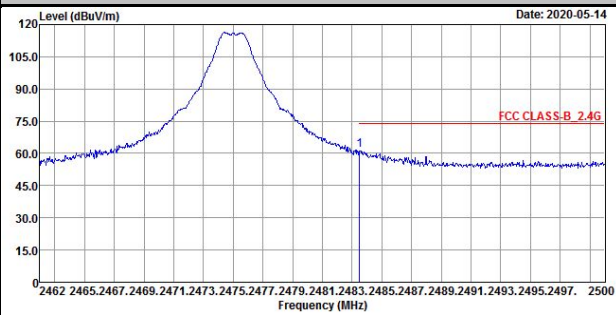

Vertical

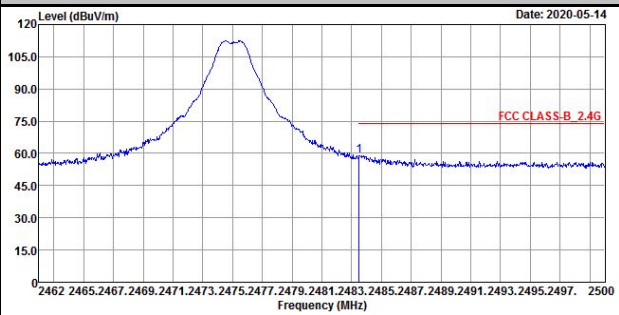

Average

Horizontal

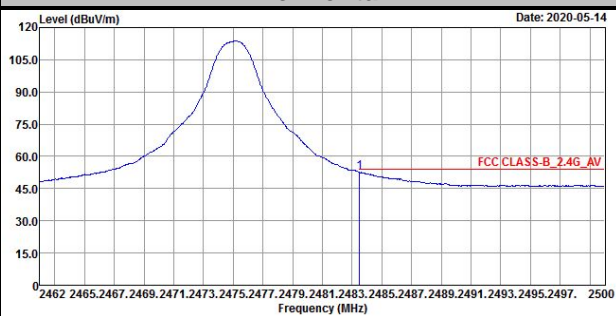

Vertical

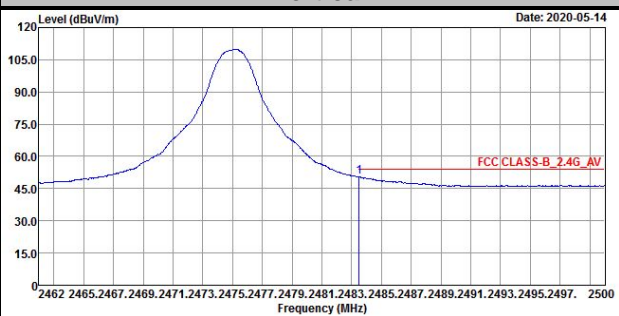

Appendix – Information of the Testing Laboratories

We, Bureau Veritas Consumer Products Services (H.K.) Ltd., Taoyuan Branch, were founded in 1988 to provide our best service in EMC, Radio, Telecom and Safety consultation. Our laboratories are FCC recognized accredited test firms and accredited according to ISO/IEC 17025.

If you have any comments, please feel free to contact us at the following:

Lin Kou EMC/RF Lab

Tel: 886-2-26052180

Fax: 886-2-26051924

Hsin Chu EMC/RF/Telecom Lab

Tel: 886-3-6668565

Fax: 886-3-6668323

Hwa Ya EMC/RF/Safety Lab

Tel: 886-3-3183232

Fax: 886-3-3270892

Email: service.adt@tw.bureauveritas.com

Web Site: www.bureauveritas-adt.com

The address and road map of all our labs can be found in our web site also.

--- END ---