



# FCC RADIO TEST REPORT

FCC ID : A4RGD1YQ  
Equipment : Phone  
Model Name : GD1YQ  
Applicant : Google LLC  
1600 Amphitheatre Parkway,  
Mountain View, California, 94043 USA  
Standard : FCC 47 CFR Part 2, and 90(S)

The product was received on Apr. 23, 2020 and testing was started from Apr. 29, 2020 and completed on Jun. 20, 2020. We, SPORTON INTERNATIONAL INC. EMC & Wireless Communications Laboratory, would like to declare that the tested sample has been evaluated in accordance with the test procedures given in ANSI / TIA-603-E and has been in compliance with the applicable technical standards.

The test results in this report apply exclusively to the tested model / sample. Without written approval of SPORTON INTERNATIONAL INC. EMC & Wireless Communications Laboratory, the test report shall not be reproduced except in full.

*Louis Wu*

Approved by: Louis Wu

**SPORTON INTERNATIONAL INC. EMC & Wireless Communications Laboratory**  
No. 52, Huaya 1st Rd., Guishan Dist., Taoyuan City, Taiwan (R.O.C.)



## Table of Contents

History of this test report.....	3
Summary of Test Result.....	4
<b>1 General Description .....</b>	<b>5</b>
1.1 Feature of Equipment Under Test.....	5
1.2 Product Specification of Equipment Under Test .....	5
1.3 Modification of EUT .....	6
1.4 Testing Site.....	6
1.5 Applied Standards .....	7
<b>2 Test Configuration of Equipment Under Test .....</b>	<b>8</b>
2.1 Test Mode.....	8
2.2 Connection Diagram of Test System .....	8
2.3 Support Unit used in test configuration and system.....	9
2.4 Measurement Results Explanation Example .....	9
2.5 Frequency List of Low/Middle/High Channels.....	9
<b>3 Conducted Test Items.....</b>	<b>10</b>
3.1 Measuring Instruments.....	10
3.2 Conducted Output Power Measurement.....	11
3.3 Peak-to-Average Ratio .....	12
3.4 Bandwidth Limitations Measurement .....	13
3.5 Emissions Mask Measurement .....	14
3.6 Emissions Mask – Out Of Band Emissions Measurement.....	15
3.7 Frequency Stability Measurement.....	16
<b>4 Radiated Test Items .....</b>	<b>17</b>
4.1 Measuring Instruments.....	17
4.2 Field Strength of Spurious Radiation Measurement .....	19
<b>5 List of Measuring Equipment.....</b>	<b>20</b>
<b>6 Uncertainty of Evaluation.....</b>	<b>21</b>
<b>Appendix A. Test Results of Conducted Test</b>	
<b>Appendix B. Test Results of Radiated Test</b>	



### History of this test report

Report No.	Version	Description	Issued Date
FG011718-01G	01	Initial issue of report	Jul. 14, 2020



### Summary of Test Result

Report Clause	Ref Std. Clause	Test Items	Result (PASS/FAIL)	Remark
3.2	§2.1046 §90.635	Conducted Output Power	Pass	-
3.3	-	Peak-to-Average Ratio	Reporting only	-
3.4	§2.1049 §90.209	Bandwidth Limitations	Reporting only	-
3.5	§2.1051 §90.691	Emission masks – In-band emissions	Pass	-
3.6	§2.1051 §90.691	Emission masks – Out of band emissions	Pass	-
3.7	§2.1055 §90.213	Frequency Stability for Temperature & Voltage	Pass	-
4.2	§2.1053 §90.691	Field Strength of Spurious Radiation	Pass	Under limit 37.31 dB at 2469.000 MHz for Primary Antenna Under limit 30.79 dB at 2462.000 MHz for ASDIV Antenna

<b>Declaration of Conformity:</b>
The test results with all measurement uncertainty excluded are presented in accordance with the regulation limits or requirements declared by manufacturers.
<b>Comments and Explanations:</b>
The declared of product specification for EUT presented in the report are provided by the manufacturer, and the manufacturer takes all the responsibilities for the accuracy of product specification.

Reviewed by: Wii Chang

Report Producer: Vivian Hsu



# 1 General Description

## 1.1 Feature of Equipment Under Test

Product Feature	
Equipment	Phone
Model Name	GD1YQ
FCC ID	A4RGD1YQ
EUT supports Radios application	CDMA/EV-DO/GSM/EGPRS/WCDMA/HSPA/LTE/5G NR/ NFC/GNSS/WPC/WPT WLAN 11b/g/n HT20 WLAN 11a/n HT20/HT40 WLAN 11ac VHT20/VHT40/VHT80 Bluetooth BR/EDR/LE

Remark: The above EUT's information was declared by manufacturer.

EUT Information List	
S/N	Performed Test Item
04031FDD4000ER	Conducted Measurement
04071FDD40000A	Radiated Spurious Emission

## 1.2 Product Specification of Equipment Under Test

Product Specification subjective to this standard	
Tx Frequency	817.9 MHz ~ 823.1 MHz
Rx Frequency	862.9 MHz ~ 868.1 MHz
Maximum Output Power to Antenna	<Primary Antenna>: 24.75 dBm <ASDIV Antenna>: 24.74 dBm
Antenna Type / Gain	<Primary Antenna>: Monopole Antenna type <ASDIV Antenna>: Monopole Antenna type
Type of Modulation	CDMA2000 1xRTT: QPSK CDMA2000 1xEV-DO: QPSK/8PSK

### <Primary Antenna>

Radio Tech	Band Number	Antenna name	Gain
CDMA	BC10	Ant 0	-3.5

### <ASDIV Antenna>

Radio Tech	Band Number	Antenna name	Gain
CDMA	BC10	Ant 1	-8.0



### 1.3 Modification of EUT

No modifications are made to the EUT during all test items.

### 1.4 Testing Site

<b>Test Site</b>	SPORTON INTERNATIONAL INC. EMC & Wireless Communications Laboratory
<b>Test Site Location</b>	No.52, Huaya 1st Rd., Guishan Dist., Taoyuan City, Taiwan (R.O.C.) TEL: +886-3-327-3456 FAX: +886-3-328-4978
<b>Test Site No.</b>	<b>Sporton Site No.</b> TH03-HY
<b>Test Engineer</b>	Louis Chung
<b>Temperature</b>	21~24°C
<b>Relative Humidity</b>	51~55%

**Note:** The test site complies with ANSI C63.4 2014 requirement.

<b>Test Site</b>	SPORTON INTERNATIONAL INC. EMC & Wireless Communications Laboratory
<b>Test Site Location</b>	No.58, Aly. 75, Ln. 564, Wenhua 3rd, Rd., Guishan Dist., Taoyuan City, Taiwan (R.O.C.) TEL: +886-3-327-0868 FAX: +886-3-327-0855
<b>Test Site No.</b>	<b>Sporton Site No.</b> 03CH12-HY
<b>Test Engineer</b>	Jack Cheng, Lance Chiang and Chuan Chu
<b>Temperature</b>	24.3~26.4°C
<b>Relative Humidity</b>	56.1~68.1%

**Note:** The test site complies with ANSI C63.4 2014 requirement.

FCC Designation No.: TW1190 and TW0007



## **1.5 Applied Standards**

According to the specifications of the manufacturer, the EUT must comply with the requirements of the following standards:

- ♦ FCC 47 CFR Part 2, 90
- ♦ ANSI / TIA-603-E
- ♦ ANSI C63.26-2015
- ♦ FCC KDB 971168 D01 Power Meas. License Digital Systems v03r01
- ♦ FCC KDB 414788 D01 Radiated Test Site v01r01

### **Remark:**

1. All test items were verified and recorded according to the standards and without any deviation during the test.
2. The TAF code is not including all the FCC KDB listed without accreditation.

## 2 Test Configuration of Equipment Under Test

### 2.1 Test Mode

Antenna port conducted and radiated test items listed below are performed according to KDB 971168 D01 Power Meas. License Digital Systems v03r01 with maximum output power.

For radiated measurement, pre-scanned in three orthogonal panels, X, Y, Z and Accessory (Adapter or Earphone). The worst cases (Primary Antenna: Y plane with Adapter; ASDIV Antenna: Z plane with Adapter) were recorded in this report.

Radiated emissions were investigated as following frequency range:

- 30 MHz to 9000 MHz for CDMA BC10.

Test Modes		
Band	Radiated TCs	Conducted TCs
CDMA2000 BC10	<ul style="list-style-type: none"> <li>■ 1xRTT Link</li> <li>■ 1xEV-DO Link</li> </ul>	<ul style="list-style-type: none"> <li>■ 1xRTT Link</li> <li>■ 1xEV-DO Link</li> </ul>

**Remark:** All the radiated test cases were performed with Adapter 2.

### 2.2 Connection Diagram of Test System

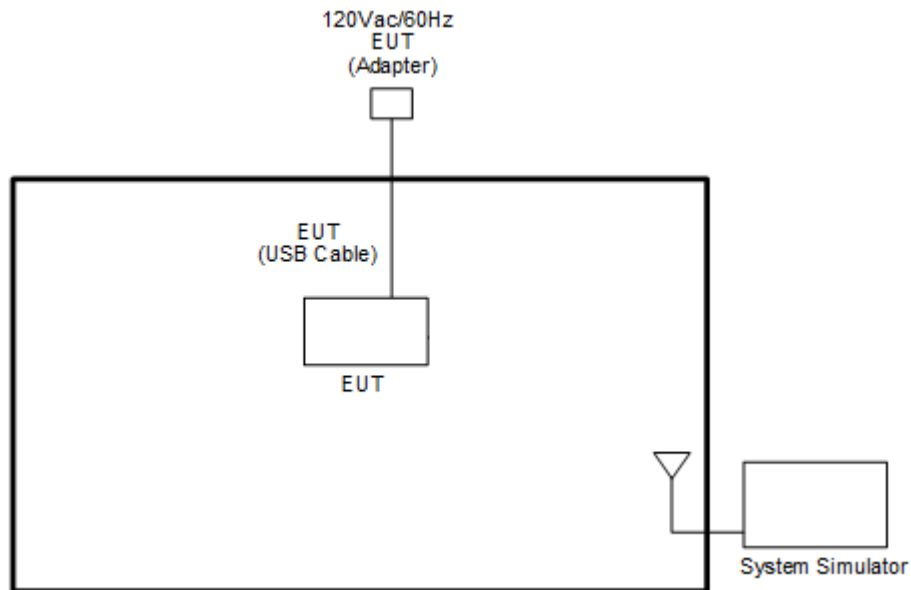





### 2.3 Support Unit used in test configuration and system

Item	Equipment	Trade Name	Model No.	FCC ID	Data Cable	Power Cord
1.	System Simulator	R&S	CMU 200	N/A	N/A	Unshielded, 1.8 m

### 2.4 Measurement Results Explanation Example

For all conducted test items:

The offset level is set in the spectrum analyzer to compensate the RF cable loss and attenuator factor between RF conducted output port and spectrum analyzer. With the offset compensation, the spectrum analyzer reading level will be exactly the RF output level.

The spectrum analyzer offset is derived from RF cable loss and attenuator factor.

$$\text{Offset} = \text{RF cable loss} + \text{attenuator factor}.$$

The following shows an offset computation example with RF cable loss 4.2 dB and a 10dB attenuator.

Example :

$$\begin{aligned} \text{Offset(dB)} &= \text{RF cable loss(dB)} + \text{attenuator factor(dB)}. \\ &= 4.2 + 10 = 14.2 \text{ (dB)} \end{aligned}$$

### 2.5 Frequency List of Low/Middle/High Channels

Frequency List				
Band	Channel/Frequency(MHz)	Lowest	Middle	Highest
CDMA2000 BC10	Channel	476	580	684
	Frequency	817.9	820.5	823.1

### 3 Conducted Test Items

#### 3.1 Measuring Instruments

See list of measuring instruments of this test report.

##### 3.1.1 Test Setup

##### 3.1.2 Conducted Output Power

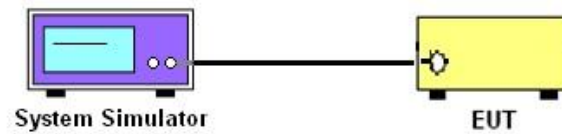

##### 3.1.3 Peak-to-Average Ratio, Occupied Bandwidth, Conducted Band-Edge, and Conducted Spurious Emission

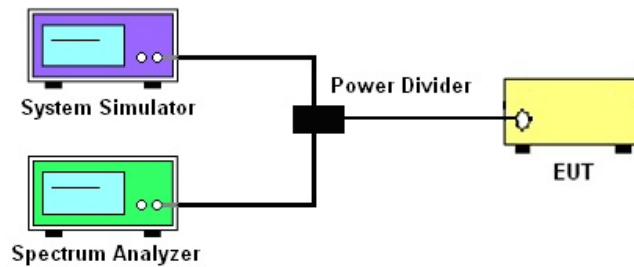

##### 3.1.4 Frequency Stability

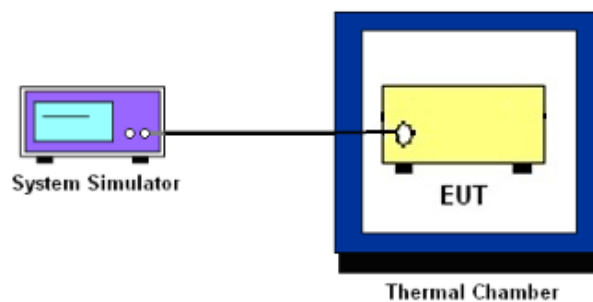

##### 3.1.5 Test Result of Conducted Test

Please refer to Appendix A.



## **3.2 Conducted Output Power Measurement**

### **3.2.1 Description of the Conducted Output Power Measurement**

A system simulator was used to establish communication with the EUT. Its parameters were set to enforce EUT transmitting at the maximum power. The measured power in the radio frequency on the transmitter output terminals shall be reported.

### **3.2.2 Test Procedures**

1. The transmitter output port was connected to the system simulator.
2. Set EUT at maximum power through system simulator.
3. Select lowest, middle, and highest channels for each band and different modulation.
4. Measure and record the power level from the system simulator.



### **3.3 Peak-to-Average Ratio**

#### **3.3.1 Description of the PAR Measurement**

Reporting only

#### **3.3.2 Test Procedures**

1. The EUT was connected to spectrum and system simulator via a power divider.
2. Set the CCDF (Complementary Cumulative Distribution Function) option in spectrum analyzer.
3. The highest RF powers were measured and recorded the maximum PAPR level associated with a probability of 0.1 %.
4. Record the deviation as Peak to Average Ratio.



## **3.4 Bandwidth Limitations Measurement**

### **3.4.1 Description of (Occupied) Bandwidth Limitations Measurement**

The 99% occupied bandwidth is the width of a frequency band such that, below the lower and above the upper frequency limits, the mean powers emitted are each equal to a specified percentage 0.5% of the total mean transmitted power.

The emission bandwidth is defined as the width of the signal between two points, located at the 2 sides of the carrier frequency, outside of which all emissions are attenuated at least 26 dB below the transmitter power.

### **3.4.2 Test Procedures**

1. The EUT was connected to the spectrum analyzer and system simulator via a power divider.
2. The RF output of the EUT was connected to the spectrum analyzer by RF cable and attenuator. The path loss was compensated to the results for each measurement.
3. The 99% occupied bandwidth were measured, set RBW= 1% of span, VBW $\geq$  3\*RBW, sample detector, trace maximum hold.
4. The 26dB bandwidth were measured, set RBW= 1% of EBW, VBW $\geq$  3\*RBW, peak detector, trace maximum hold.



## 3.5 Emissions Mask Measurement

### 3.5.1 Description of Emissions Mask Measurement

Equipment used in this licensed to EA or non-EA systems shall comply with the emission mask provisions of FCC Part 90.691.(a)(1)

- (a). Out-of-band emission requirement shall apply only to the “outer” channels included in an EA license and to spectrum adjacent to interior channels used by incumbent licensees. The emission limits are as follows:
  - (1) For any frequency removed from the EA licensee's frequency block by up to and including 37.5 kHz, the power of any emission shall be attenuated below the transmitter power (P) in watts by at least  $116 \text{ Log}_{10}(f/6.1)$  decibels or  $50 + 10 \text{ Log}_{10}(P)$  decibels or 80 decibels, whichever is the lesser attenuation, where f is the frequency removed from the center of the outer channel in the block in kilohertz and where f is greater than 12.5 kHz.

### 3.5.2 Test Procedures

1. The EUT was connected to spectrum analyzer and system simulator via power divider.
2. The emissions mask of low and high channels for the highest RF powers were measured.
3. The measured RBW and the VBW set 3 times of RBW are then set in spectrum analyzer, and the RBW correction factor  $10 \log (1\% \text{ of OBW}/\text{measured RBW})$ (dB) was compensated, if required.
4. The test results were shown below plots with a correction offset factor including cable loss, insertion loss of power divider.



### 3.6 Emissions Mask – Out Of Band Emissions Measurement

#### 3.6.1 Description of Conducted Spurious Emissions Out of band emissions measurement

The power of any emission FCC Part 90.691 (a)(2) on any frequency removed from the assigned frequency by more than 250 percent of the authorized bandwidth at least  $43 + 10 \log (P)$  dB.

It is measured by means of a calibrated spectrum analyzer and scanned from 30 MHz up to a frequency including its 10th harmonic.

#### 3.6.2 Test Procedures

1. The EUT was connected to the spectrum analyzer and system simulator via a power divider.
2. The RF output of EUT was connected to the spectrum analyzer by an RF cable and attenuator. The path loss was compensated to the results for each measurement.
3. The middle channel for the highest RF power within the transmitting frequency was measured.
4. The conducted spurious emission for the whole frequency range was taken.
5. The RF fundamental frequency should be excluded against the limit line in the operating frequency band.
6. The limit line is derived from  $43 + 10\log(P)$  dB below the transmitter power P(Watts)



## **3.7 Frequency Stability Measurement**

### **3.7.1 Description of Frequency Stability Measurement**

The frequency stability shall be sufficient to ensure that the fundamental emission stays within the authorized frequency block.

### **3.7.2 Test Procedures for Temperature Variation**

1. The EUT was set up in the thermal chamber and connected with the base station.
2. With power OFF, the temperature was decreased to  $-30^{\circ}\text{C}$  and the EUT was stabilized for three hours. Power was applied and the maximum change in frequency was recorded within one minute.
3. With power OFF, the temperature was raised in  $10^{\circ}\text{C}$  step up to  $50^{\circ}\text{C}$ . The EUT was stabilized at each step for at least half an hour. Power was applied and the maximum frequency change was recorded within one minute.

### **3.7.3 Test Procedures for Voltage Variation**

1. The EUT was placed in a temperature chamber at  $20\pm 5^{\circ}\text{C}$  and connected with the base station.
2. The power supply voltage to the EUT was varied from BEP to 115% of the nominal value measured at the input to the EUT.
3. The variation in frequency was measured for the worst case.



## 4 Radiated Test Items

### 4.1 Measuring Instruments

See list of measuring instruments of this test report.

#### 4.1.1 Test Setup

For radiated emissions below 30MHz

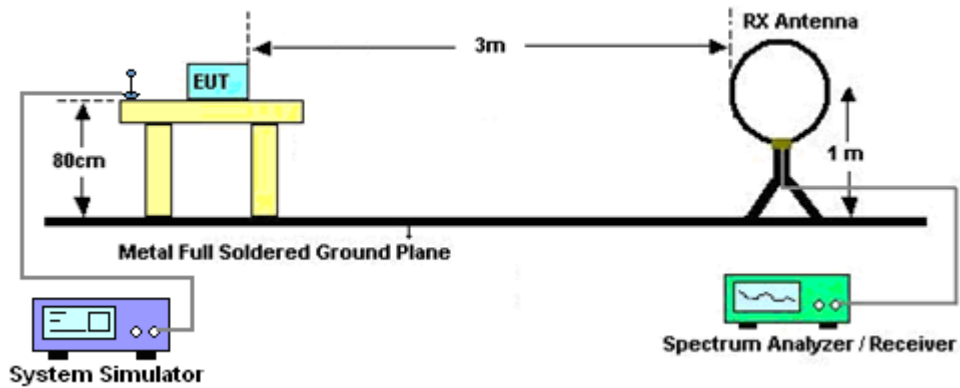

For radiated test from 30MHz to 1GHz

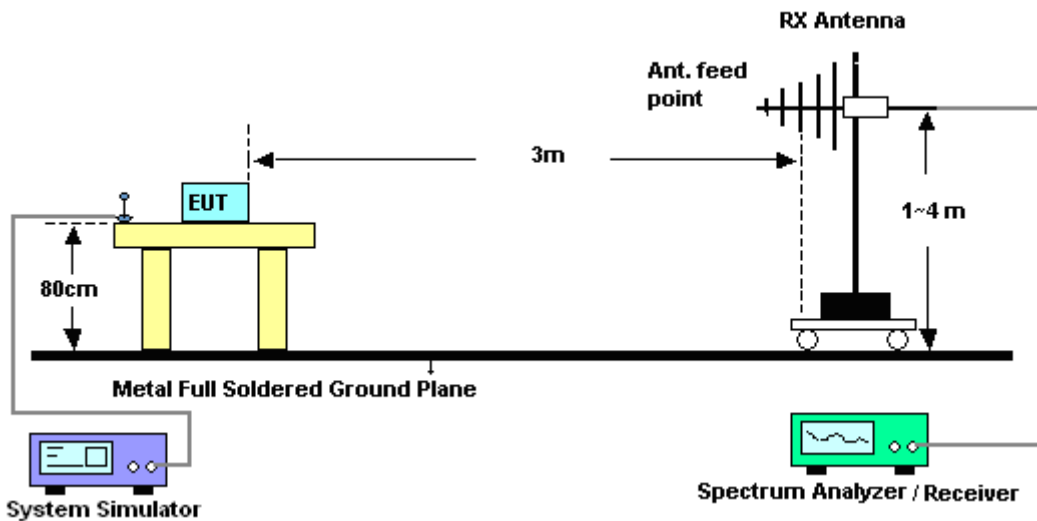

For radiated test above 1GHz

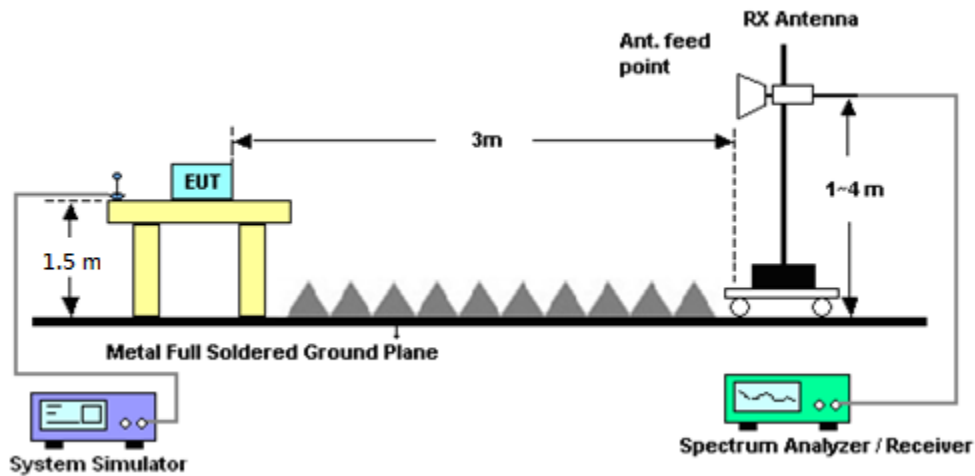

#### 4.1.2 Test Result of Radiated Test

Please refer to Appendix B.

**Note:**

The low frequency, which started from 9 kHz to 30MHz, was pre-scanned and the result which was 20dB lower than the limit line was not reported.

There is a comparison data of both open-field test site and alternative test site - semi-Anechoic chamber according to 414788 D01 Radiated Test Site v01r01, and the result came out very similar.



## 4.2 Field Strength of Spurious Radiation Measurement

### 4.2.1 Description of Field Strength of Spurious Radiated Measurement

The radiated spurious emission was measured by substitution method according to ANSI / TIA-603-E. The power of any emission FCC Part 90.691 on any frequency removed from the assigned frequency by more than 250 percent of the authorized bandwidth at least  $43 + 10 \log (P)$  dB. The spectrum is scanned from 30 MHz up to a frequency including its 10th harmonic.

The power of any emission outside of the authorized operating frequency ranges must be attenuated below the transmitter power (P) by a factor of at least  $43+10\log_{10}(P[\text{Watts}])$  dB. The spectrum is scanned from 30 MHz up to a frequency including its 10th harmonic.

### 4.2.2 Test Procedures

1. The EUT was placed on a rotatable wooden table 0.8 meters for frequency below 1GHz and 1.5 meter for frequency above 1GHz above the ground.
2. The EUT was set 3 meters from the receiving antenna, which was mounted on the antenna tower.
3. The table was rotated 360 degrees to determine the position of the highest spurious emission.
4. The height of the receiving antenna is varied between one meter and four meters to search for the maximum spurious emission for both horizontal and vertical polarizations.
5. Make the measurement with the spectrum analyzer's RBW = 1MHz, VBW = 3MHz, taking record of maximum spurious emission.
6. A horn antenna was substituted in place of the EUT and was driven by a signal generator.
7. Tune the output power of signal generator to the same emission level with EUT maximum spurious emission.
8. Taking the record of output power at antenna port.
9. Repeat step 7 to step 8 for another polarization.
10.  $\text{EIRP (dBm)} = \text{S.G. Power} - \text{Tx Cable Loss} + \text{Tx Antenna Gain}$
11.  $\text{ERP (dBm)} = \text{EIRP} - 2.15$
12. The RF fundamental frequency should be excluded against the limit line in the operating frequency band.
13. The limit line is derived from  $43 + 10\log(P)$  dB below the transmitter power P(Watts)



## 5 List of Measuring Equipment

Instrument	Manufacturer	Model No.	Serial No.	Characteristics	Calibration Date	Test Date	Due Date	Remark
Hygrometer	Testo	608-H1	34893241	N/A	Mar. 26, 2020	May 08, 2020~ May 11, 2020	Mar. 25, 2021	Conducted (TH03-HY)
Spectrum Analyzer	Rohde & Schwarz	FSP30	101329	9kHz~30GHz	Sep. 04, 2019	May 08, 2020~ May 11, 2020	Sep. 03, 2020	Conducted (TH03-HY)
Temperature Chamber	ESPEC	SU-641	92013721	-30°C ~70°C	Nov. 26, 2019	May 08, 2020~ May 11, 2020	Nov. 25, 2020	Conducted (TH03-HY)
Programmable Power Supply	GW Instek	PSS-2005	EL890001	1V~20V 0.5A~4A	Oct. 09, 2019	May 08, 2020~ May 11, 2020	Oct. 08, 2020	Conducted (TH03-HY)
Base Station(Measure)	Rohde & Schwarz	CMU200	117995	GSM / GPRS / WCDMA / CDMA	Aug. 23, 2019	May 08, 2020~ May 11, 2020	Aug. 22, 2020	Conducted (TH03-HY)
Power Divider	Warison	WCOU-0.4-26 .5S-20	#A	N/A	Nov. 06, 2019	May 08, 2020~ May 11, 2020	Nov. 05, 2020	Conducted (TH03-HY)
Loop Antenna	Rohde & Schwarz	HFH2-Z2	100315	9 kHz~30 MHz	Dec. 26, 2019	Apr. 29, 2020~ Jun. 20, 2020	Dec. 25, 2020	Radiation (03CH12-HY)
Bilog Antenna	TESEQ	CBL 6111D & 00800N1D01 N-06	37059 & 01	30MHz~1GHz	Oct. 12, 2019	Apr. 29, 2020~ Jun. 20, 2020	Oct 11, 2020	Radiation (03CH12-HY)
Horn Antenna	SCHWARZBE CK	BBHA 9120D	9120D-132 8	1GHz ~ 18GHz	Nov. 14, 2019	Apr. 29, 2020~ Jun. 20, 2020	Nov. 13, 2020	Radiation (03CH12-HY)
Horn Antenna	SCHWARZBE CK	BBHA 9120D	9120D-152 2	1GHz ~ 18GHz	Sep. 19, 2019	Apr. 29, 2020~ Jun. 20, 2020	Sep. 18, 2020	Radiation (03CH12-HY)
Preamplifier	COM-POWER	PA-103	161075	10MHz~1GHz	Mar. 25, 2020	Apr. 29, 2020~ Jun. 20, 2020	Mar. 24, 2021	Radiation (03CH12-HY)
Preamplifier	Jet-Power	JPA00101800 -30-10P	160118000 2	1GHz~18GHz	Feb. 07, 2020	Apr. 29, 2020~ Jun. 20, 2020	Feb. 06, 2021	Radiation (03CH12-HY)
Preamplifier	Keysight	83017A	MY532701 48	1GHz~26.5GHz	Dec. 20, 2019	Apr. 29, 2020~ Jun. 20, 2020	Dec. 19, 2020	Radiation (03CH12-HY)
Signal Analyzer	Agilent	N9010A	MY534701 18	10Hz~44GHz	Mar. 12, 2020	Apr. 29, 2020~ Jun. 20, 2020	Mar. 11, 2021	Radiation (03CH12-HY)
Signal Generator	Rohde & Schwarz	SMB100A	101107	100kHz~40GHz	Aug. 27, 2019	Apr. 29, 2020~ Jun. 20, 2020	Aug. 26, 2020	Radiation (03CH12-HY)
Hygrometer	TECPEL	DTM-303B	TP161243	N/A	Oct. 25, 2019	Apr. 29, 2020~ Jun. 20, 2020	Oct. 24, 2020	Radiation (03CH12-HY)
RF Cable	HUBER + SUHNER	SUCOFLEX 126E	0058/126E	30M-18G	Dec. 12, 2019	Apr. 29, 2020~ Jun. 20, 2020	Dec. 11, 2020	Radiation (03CH12-HY)
Controller	EMEC	EM1000	N/A	Control Turn table & Ant Mast	N/A	Apr. 29, 2020~ Jun. 20, 2020	N/A	Radiation (03CH12-HY)
Antenna Mast	EMEC	AM-BS-4500- B	N/A	1m~4m	N/A	Apr. 29, 2020~ Jun. 20, 2020	N/A	Radiation (03CH12-HY)
Turn Table	EMEC	TT2000	N/A	0~360 Degree	N/A	Apr. 29, 2020~ Jun. 20, 2020	N/A	Radiation (03CH12-HY)
Software	Audix	E3 6.2009-8-24	RK-00098 9	N/A	N/A	Apr. 29, 2020~ Jun. 20, 2020	N/A	Radiation (03CH12-HY)



## 6 Uncertainty of Evaluation

### Uncertainty of Radiated Emission Measurement (30 MHz ~ 1000 MHz)

Measuring Uncertainty for a Level of Confidence of 95% ( $U = 2Uc(y)$ )	3.24
---	------

### Uncertainty of Radiated Emission Measurement (1 GHz ~ 18 GHz)

Measuring Uncertainty for a Level of Confidence of 95% ( $U = 2Uc(y)$ )	3.62
---	------



### Appendix A. Test Results of Conducted Test

#### Conducted Output Power(Average power)

<Primary Antenna>

Conducted Power (*Unit: dBm)			
Band	CDMA 2000 BC10		
Channel	476	580	684
Frequency	817.9	820.5	823.1
1xRTT RC1 SO55	24.63	24.61	24.68
1xRTT RC3 SO55	24.66	24.64	24.67
1xRTT RC3 SO32 (+ F-SCH)	24.69	24.73	24.70
1xRTT RC3 SO32 (+SCH)	24.64	24.64	24.60
1xEVDO RTAP 153.6Kbps	24.70	24.75	24.71
1xEVDO RETAP 4096Bits	24.69	24.73	24.69



<ASDIV Antenna>

Conducted Power (*Unit: dBm)			
Band	CDMA 2000 BC10		
Channel	476	580	684
Frequency	817.9	820.5	823.1
1xRTT RC1 SO55	24.70	24.41	24.53
1xRTT RC3 SO55	24.74	24.48	24.51
1xRTT RC3 SO32 (+ F-SCH)	24.69	24.45	24.46
1xRTT RC3 SO32 (+SCH)	24.68	24.46	24.51
1xEVDO RTAP 153.6Kbps	24.58	24.42	24.43
1xEVDO RETAP 4096Bits	24.72	24.47	24.47



## A2. CDMA

### Peak-to-Average Ratio

Mode	CDMA BC10	Limit: 13dB
Mod.	1xRTT	Result
Lowest CH	3.88	PASS
Middle CH	3.88	
Highest CH	3.84	





CDMA BC10 (1xRTT)

Lowest Channel

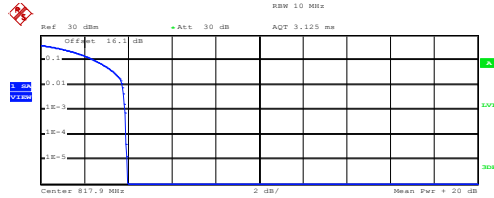

Complementary Cumulative Distribution Function (100000 samples)

Trace 1  
 Mean 24.51 dBm  
 Peak 28.48 dBm  
 Crest 3.97 dB

10 %	2.52 dB
1 %	3.76 dB
.1 %	3.88 dB
.01 %	3.92 dB

Date: 8.MAY.2020 18:50:11

Middle Channel

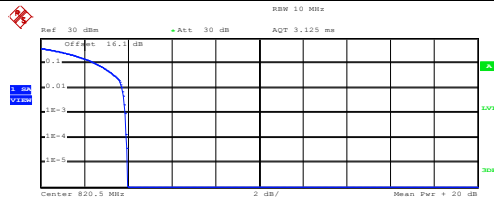

Complementary Cumulative Distribution Function (100000 samples)

Trace 1  
 Mean 24.59 dBm  
 Peak 28.56 dBm  
 Crest 3.97 dB

10 %	2.56 dB
1 %	3.72 dB
.1 %	3.88 dB
.01 %	3.92 dB

Date: 8.MAY.2020 18:50:53

Highest Channel

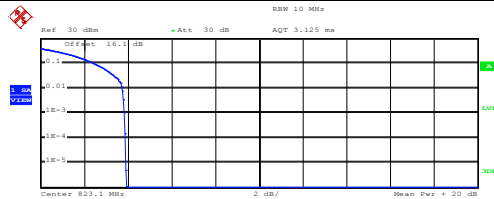

Complementary Cumulative Distribution Function (100000 samples)

Trace 1  
 Mean 24.54 dBm  
 Peak 28.48 dBm  
 Crest 3.95 dB

10 %	2.52 dB
1 %	3.76 dB
.1 %	3.84 dB
.01 %	3.88 dB

Date: 8.MAY.2020 18:51:17



**26dB Bandwidth**

Mode	CDMA BC10: 26dB BW(MHz)
Mod.	1xRTT
Lowest CH	1.43
Middle CH	1.43
Highest CH	1.42

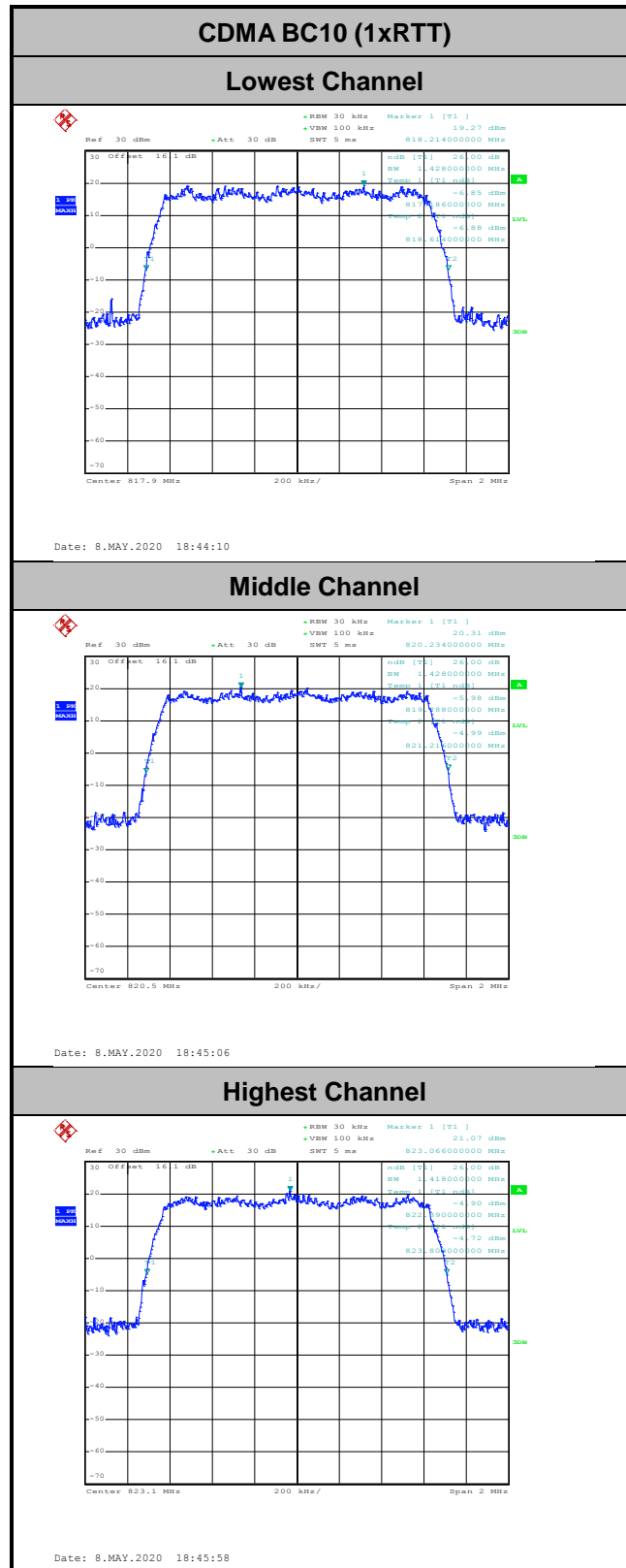



**Occupied Bandwidth**

Mode	CDMA BC10: 99% OBW (MHz)
Mod.	1xRTT
Lowest CH	1.27
Middle CH	1.28
Highest CH	1.28

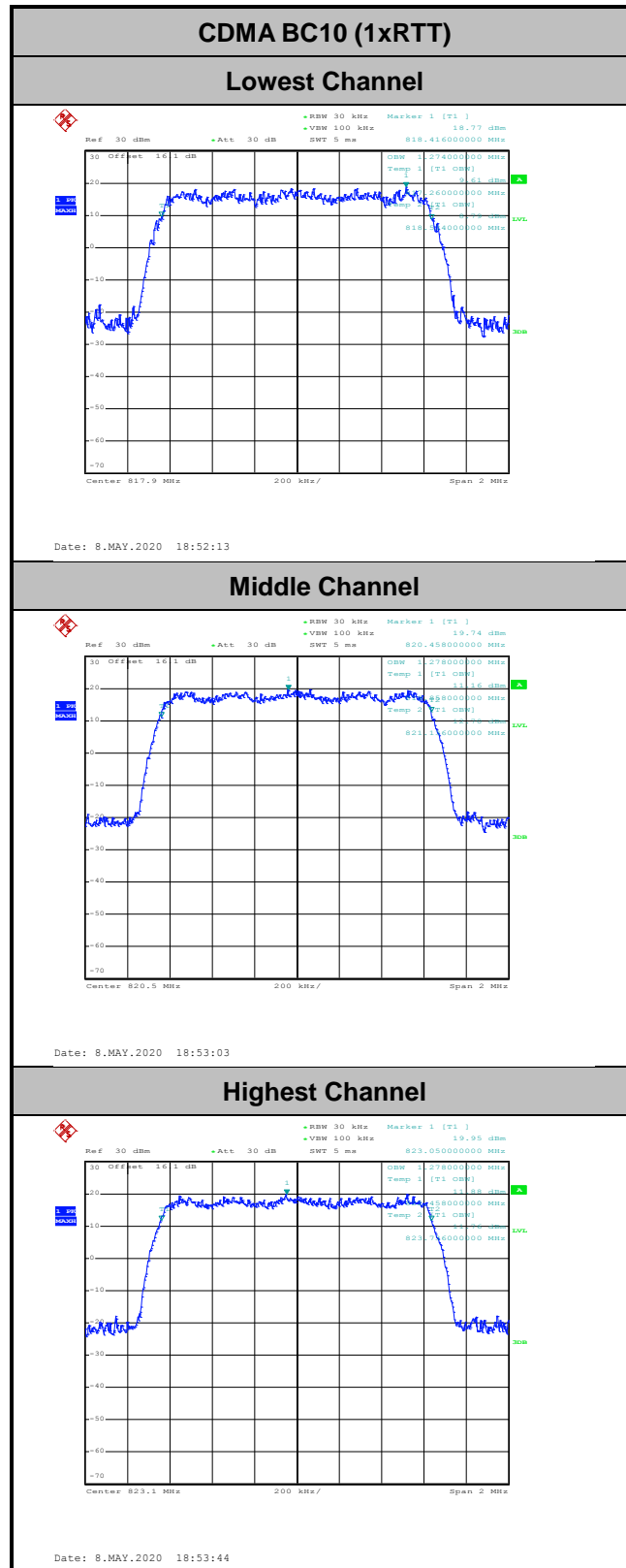



Conducted Band Edge

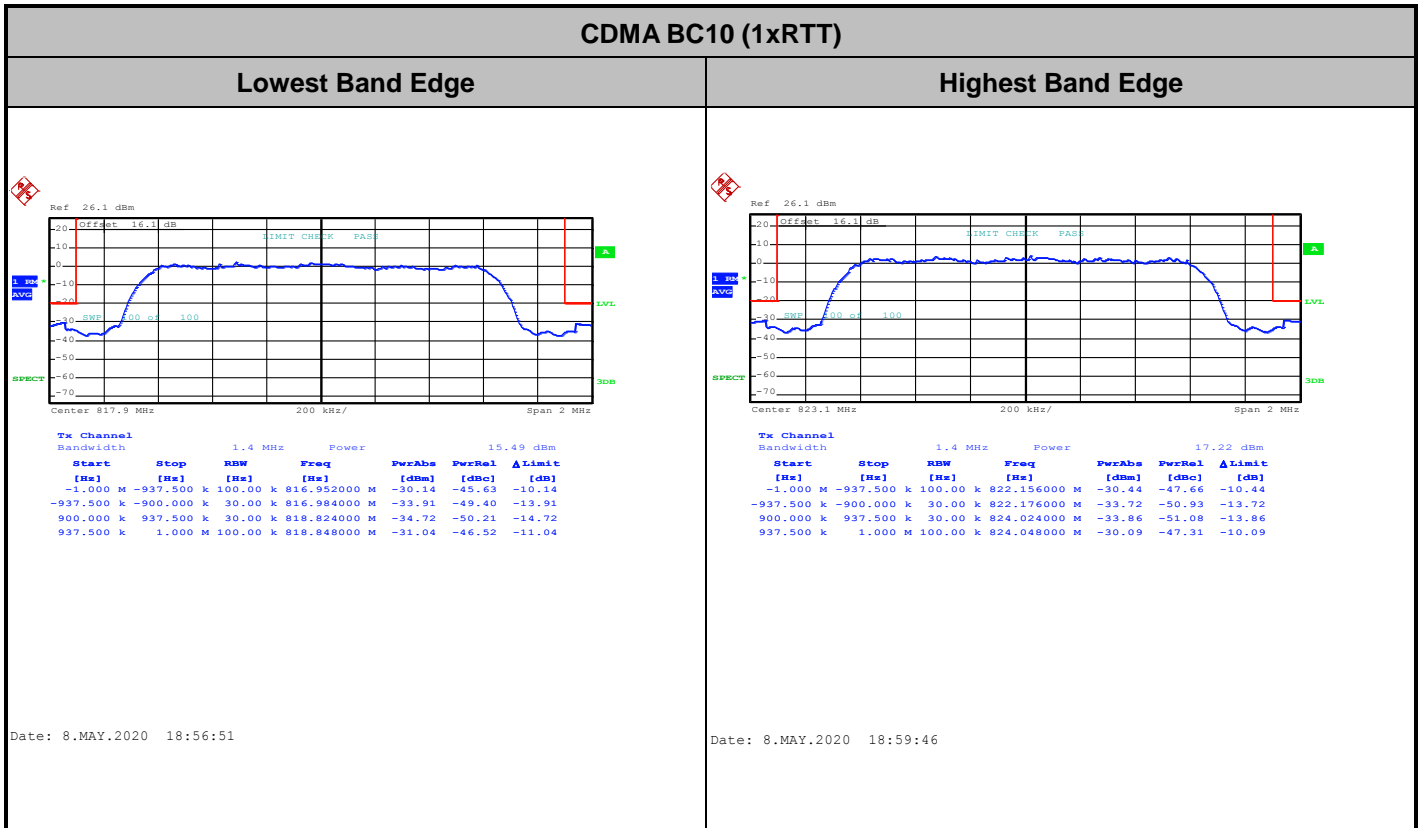



# Conducted Spurious Emission

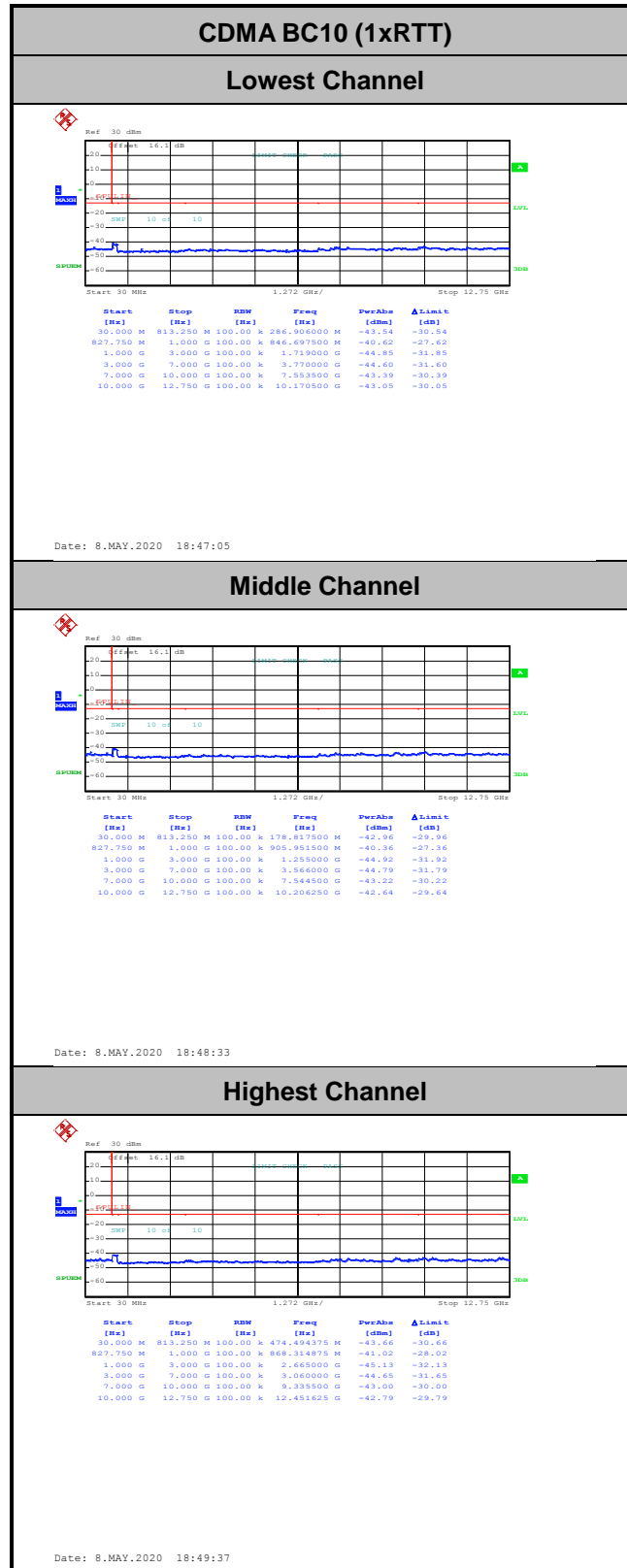



**Frequency Stability**

Test Conditions	Middle Channel	CDMA BC10 (1xRTT)	Limit Note 2.
Temperature (°C)	Voltage (Volt)	Deviation (ppm)	Result
50	Normal Voltage	0.0037	PASS
40	Normal Voltage	0.0061	
30	Normal Voltage	0.0024	
20(Ref.)	Normal Voltage	0.0000	
10	Normal Voltage	0.0037	
0	Normal Voltage	0.0061	
-10	Normal Voltage	0.0012	
-20	Normal Voltage	0.0061	
-30	Normal Voltage	0.0037	
20	Maximum Voltage	0.0037	
20	Normal Voltage	0.0000	
20	Battery End Point	0.0012	

**Note:**

- 1. Normal Voltage = 3.87 V. ; Battery End Point (BEP) = 3.49 V. ; Maximum Voltage =4.45 V
- 2. The frequency fundamental emissions stay within the authorized frequency block.





**Radiated Spurious Emission**

<Primary Antenna>

<Ant. 0>

**CDMA2000 BC10**

CDMA2000 BC10									
Channel	Frequency ( MHz )	ERP ( dBm )	Limit ( dBm )	Over Limit ( dB )	SPA Reading (dBm)	S.G. Power ( dBm )	TX Cable loss ( dB )	TX Antenna Gain (dBi)	Polarization (H/V)
Lowest	1636	-61.52	-13	-48.52	-71.16	-67.07	0.92	8.62	H
	2454	-53.13	-13	-40.13	-66.98	-60.48	1.14	10.64	H
	3272	-55.94	-13	-42.94	-71.42	-64.42	1.32	11.95	H
									H
									H
									H
	1636	-61.97	-13	-48.97	-71.13	-67.52	0.92	8.62	V
	2454	-53.39	-13	-40.39	-67.34	-60.74	1.14	10.64	V
	3272	-55.51	-13	-42.51	-71.47	-63.99	1.32	11.95	V
									V
									V
									V
Middle	1641	-61.40	-13	-48.40	-71.05	-66.97	0.92	8.64	H
	2462	-50.40	-13	-37.40	-64.26	-57.76	1.14	10.65	H
	3282	-55.74	-13	-42.74	-71.2	-64.25	1.32	11.98	H
									H
									H
									H
	1641	-61.79	-13	-48.79	-70.93	-67.36	0.92	8.64	V
	2462	-51.15	-13	-38.15	-65.13	-58.51	1.14	10.65	V
	3282	-55.03	-13	-42.03	-70.97	-63.54	1.32	11.98	V
									V
									V
									V



Highest	1646	-61.15	-13	-48.15	-70.81	-66.74	0.92	8.65	H
	2469	-50.31	-13	-37.31	-64.17	-57.67	1.14	10.66	H
	3292	-55.39	-13	-42.39	-70.83	-63.92	1.32	12.00	H
									H
									H
									H
	1646	-62.03	-13	-49.03	-71.17	-67.62	0.92	8.65	V
	2469	-50.85	-13	-37.85	-64.85	-58.21	1.14	10.66	V
	3292	-55.40	-13	-42.40	-71.31	-63.93	1.32	12.00	V
									V
									V
									V

Remark: Spurious emissions within 30-1000MHz were found more than 20dB below limit line.



<ASDIV Antenna>  
<Ant. 1>

**CDMA2000 BC10**

CDMA2000 BC10									
Channel	Frequency ( MHz )	ERP ( dBm )	Limit ( dBm )	Over Limit ( dB )	SPA Reading (dBm)	S.G. Power ( dBm )	TX Cable loss ( dB )	TX Antenna Gain (dBi)	Polarization (H/V)
Lowest	1636	-61.32	-13	-48.32	-70.97	-66.87	0.92	8.62	H
	2454	-47.08	-13	-34.08	-60.94	-54.43	1.14	10.64	H
	3272	-55.90	-13	-42.90	-71.38	-64.38	1.32	11.95	H
									H
									H
									H
	1636	-62.18	-13	-49.18	-71.32	-67.73	0.92	8.62	V
	2454	-49.13	-13	-36.13	-63.09	-56.48	1.14	10.64	V
	3272	-55.16	-13	-42.16	-71.12	-63.64	1.32	11.95	V
									V
									V
									V
Middle	1641	-61.48	-13	-48.48	-71.13	-67.05	0.92	8.64	H
	2462	-43.79	-13	-30.79	-57.65	-51.15	1.14	10.65	H
	3282	-55.85	-13	-42.85	-71.31	-64.36	1.32	11.98	H
									H
									H
									H
	1641	-61.27	-13	-48.27	-70.41	-66.84	0.92	8.64	V
	2462	-45.17	-13	-32.17	-59.15	-52.53	1.14	10.65	V
	3282	-55.23	-13	-42.23	-71.17	-63.74	1.32	11.98	V
									V
									V
									V



Highest	1646	-61.32	-13	-48.32	-70.98	-66.91	0.92	8.65	H
	2469	-48.11	-13	-35.11	-61.97	-55.47	1.14	10.66	H
	3292	-55.63	-13	-42.63	-71.07	-64.16	1.32	12.00	H
									H
									H
									H
	1646	-61.95	-13	-48.95	-71.09	-67.54	0.92	8.65	V
	2469	-50.23	-13	-37.23	-64.23	-57.59	1.14	10.66	V
	3292	-55.33	-13	-42.33	-71.24	-63.86	1.32	12.00	V
									V
									V
									V

Remark: Spurious emissions within 30-1000MHz were found more than 20dB below limit line.

————THE END————