



FCC RADIO TEST REPORT

FCC ID : A4RGRY0E
Equipment : Wireless Device
Model Name : GRY0E
Applicant : Google LLC
1600 Amphitheatre Parkway,
Mountain View, California, 94043 USA
Standard : FCC 47 CFR Part 2, 22(H), 24(E), 27(L)

The product was received on Nov. 27, 2023 and testing was performed from Nov. 27, 2023 to Mar. 15, 2024. We, Sporton International Inc. EMC & Wireless Communications Laboratory, would like to declare that the tested sample has been evaluated in accordance with the test procedures given in ANSI / TIA-603-E and has been in compliance with the applicable technical standards.

The test results in this report apply exclusively to the tested model / sample. Without written approval from Sporton International Inc. EMC & Wireless Communications Laboratory, the test report shall not be reproduced except in full.

Louis Wu

Approved by: Louis Wu

Sporton International Inc. EMC & Wireless Communications Laboratory

No. 52, Huaya 1st Rd., Guishan Dist., Taoyuan City 333, Taiwan (R.O.C.)



Table of Contents

History of this test report.....3

Summary of Test Result.....4

1 General Description5

 1.1 Product Feature of Equipment Under Test5

 1.2 Modification of EUT5

 1.3 Testing Location6

 1.4 Applicable Standards6

2 Test Configuration of Equipment Under Test7

 2.1 Test Mode.....7

 2.2 Connection Diagram of Test System8

 2.3 Support Unit used in test configuration8

 2.4 Measurement Results Explanation Example8

 2.5 Frequency List of Low/Middle/High Channels.....9

3 Conducted Test Result10

 3.1 Measuring Instruments.....10

 3.2 Conducted Output Power and ERP/EIRP11

 3.3 Peak-to-Average Ratio12

 3.4 99% Occupied Bandwidth and 26dB Bandwidth Measurement.....13

 3.5 Conducted Band Edge14

 3.6 Conducted Spurious Emission15

 3.7 Frequency Stability.....16

4 Radiated Test Items17

 4.1 Measuring Instruments.....17

 4.2 Test Setup17

 4.3 Test Result of Radiated Test.....18

 4.4 Field Strength of Spurious Radiation Measurement19

5 List of Measuring Equipment.....20

6 Measurement Uncertainty21

Appendix A. Test Results of Conducted Test

Appendix B. Test Results of Radiated Test

Appendix C. Test Setup Photographs



Summary of Test Result

Report Clause	Ref Std. Clause	Test Items	Result (PASS/FAIL)	Remark
3.2	§2.1046	Conducted Output Power	Pass	-
	§22.913 (a)(5)	Effective Radiated Power (WCDMA Band V)		
	§24.232 (c)	Equivalent Isotropic Radiated Power (WCDMA Band II)		
	§27.50 (d)(4)	Equivalent Isotropic Radiated Power (WCDMA Band IV)		
3.3	§24.232 (d)	Peak-to-Average Ratio	Pass	-
3.4	§2.1049 §22.917 (b) §24.238 (b) §27.53 (g)	Occupied Bandwidth (WCDMA Band V) (WCDMA Band II) (WCDMA Band IV)	Pass	-
3.5	§2.1051 §22.917 (a) §24.238 (a) §27.53 (g)	Band Edge Measurement (WCDMA Band V) (WCDMA Band II) (WCDMA Band IV)	Pass	-
3.6	§2.1051 §22.917 (a) §24.238 (a) §27.53 (g)	Conducted Emission (WCDMA Band V) (WCDMA Band II) (WCDMA Band IV)	Pass	-
3.7	§2.1055 §22.355 §24.235 §27.54	Frequency Stability Temperature & Voltage	Pass	-
4.4	§2.1053 §22.917 (a) §24.238 (a) §27.53 (h)	Field Strength of Spurious Radiation (WCDMA Band V) (WCDMA Band II) (WCDMA Band IV)	Pass	37.00 dB under the limit at 2512.00 MHz

Conformity Assessment Condition:

- The test results (PASS/FAIL) with all measurement uncertainty excluded are presented against the regulation limits or in accordance with the requirements stipulated by the applicant/manufacturer who shall bear all the risks of non-compliance that may potentially occur if measurement uncertainty is taken into account.
- The measurement uncertainty please refer to each test result in the section "Measurement Uncertainty".

Disclaimer:

The product specifications of the EUT presented in the test report that may affect the test assessments are declared by the manufacturer who shall take full responsibility for the authenticity.

Reviewed by: Yun Huang

Report Producer: Michelle Chen



1 General Description

1.1 Product Feature of Equipment Under Test

Product Feature
<p>General Specs WCDMA/LTE, Bluetooth, BLE, BLE (CH2-76), Wi-Fi 2.4GHz 802.11b/g/n/ax, Wi-Fi 5GHz 802.11a/n/ac/ax, NFC, UWB and GPS.</p> <p>Antenna Type WWAN: <Ant. 1>: PIFA Antenna <Ant. 2>: PIFA Antenna</p>

Remark: The above EUT's information was declared by manufacturer. Please refer to Disclaimer in report summary.

Antenna information		
Band	Ant1	Ant2
WCDMA B5		-10.9
WCDMA B2	-8.1	
WCDMA B4	-6.7	

EUT Information List	
S/N	Performed Test Item
1JE6501133103033A300F0F	Conducted Measurement ERP/EIRP
41311JEAYL00CV	Radiated Spurious Emission

1.2 Modification of EUT

No modifications made to the EUT during the testing.



1.3 Testing Location

Test Site	Sporton International Inc. EMC & Wireless Communications Laboratory	
Test Site Location	No.52, Huaya 1st Rd., Guishan Dist., Taoyuan City 333, Taiwan (R.O.C.) TEL: +886-3-327-3456 FAX: +886-3-328-4978	
Test Site No.	Sporton Site No.	
	TH03-HY	03CH07-HY
Test Engineer	Eric Wu	Jesse Wang, Stan Hsieh and Ken Wu
Temperature (°C)	20.8~22.8	17.2~25.2
Relative Humidity (%)	42.5~44.5	47.0~68.3

Note: The test site complies with ANSI C63.4 2014 requirement.

FCC Designation No.: TW1190

1.4 Applicable Standards

According to the specifications declared by the manufacturer, the EUT must comply with the requirements of the following standards:

- ♦ ANSI C63.26-2015
- ♦ ANSI / TIA-603-E
- ♦ FCC 47 CFR Part 2, 22(H), 24(E), 27(L)
- ♦ FCC KDB 971168 D01 Power Meas. License Digital Systems v03r01
- ♦ FCC KDB 412172 D01 Determining ERP and EIRP v01r01
- ♦ FCC KDB 414788 D01 Radiated Test Site v01r01

Remark:

1. All the test items were validated and recorded in accordance with the standards without any modification during the testing.
2. The TAF code is not including all the FCC KDB listed without accreditation.



2 Test Configuration of Equipment Under Test

2.1 Test Mode

Antenna port conducted and radiated test items were performed according to KDB 971168 D01 Power Meas. License Digital Systems v03r01 with maximum output power.

For radiated measurement, the measured emission level of the EUT was maximized by rotating the EUT on a turntable, adjusting the orientation of the EUT and EUT antenna in three orthogonal axis (X: flat, Y: portrait, Z: landscape), and adjusting the measurement antenna orientation, following C63.26 exploratory test procedures and find X plane with Adapter for WCDMA Band V and II, Y plane with Adapter for WCDMA Band IV as worst plane.

Radiated emissions were investigated as following frequency range:

1. 30 MHz to 9000 MHz for WCDMA Band V
2. 30 MHz to 18000 MHz for WCDMA Band IV
3. 30 MHz to 19100 MHz for WCDMA Band II

All modes, data rates and positions were investigated.

Test modes are chosen to be reported as the worst case configuration below:

Test Modes		
Band	Radiated TCs	Conducted TCs
WCDMA Band V	■ RMC 12.2Kbps Link	■ RMC 12.2Kbps Link
WCDMA Band II	■ RMC 12.2Kbps Link	■ RMC 12.2Kbps Link
WCDMA Band IV	■ RMC 12.2Kbps Link	■ RMC 12.2Kbps Link

Remark: Simultaneous transmission between WWAN and WIFI, Bluetooth or UWB have been investigated and no significant emission was observed.

2.2 Connection Diagram of Test System

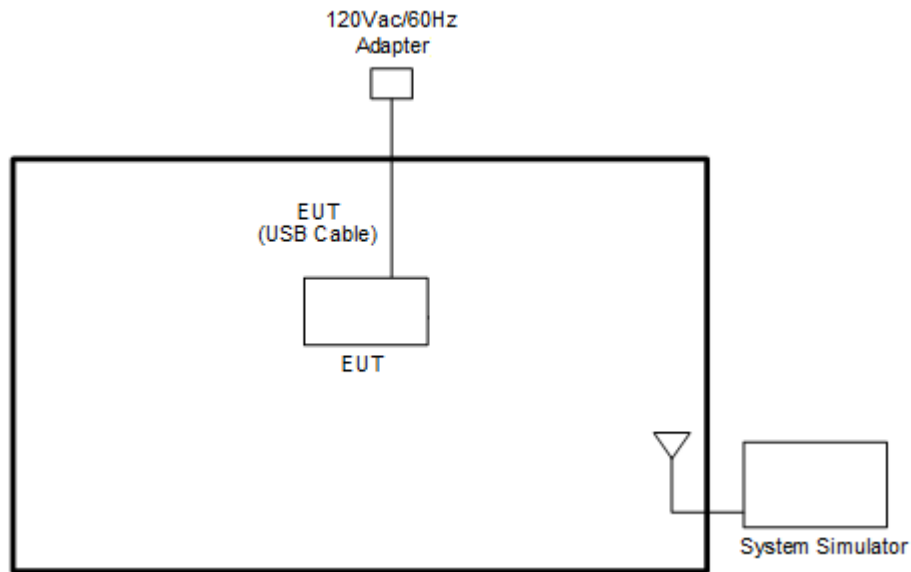

2.3 Support Unit used in test configuration

Item	Equipment	Brand Name	Model No.	FCC ID	Data Cable	Power Cord
1.	System Simulator	Anritsu	MT8821C	N/A	N/A	Unshielded, 1.8 m

2.4 Measurement Results Explanation Example

For all conducted test items:

The offset level is set in the spectrum analyzer to compensate the RF cable loss and attenuator factor between RF conducted output port and spectrum analyzer. With the offset compensation, the spectrum analyzer reading level will be exactly the RF output level.

The spectrum analyzer offset is derived from RF cable loss and attenuator factor.

Offset = RF cable loss + attenuator factor.

The following shows an offset computation example with RF cable loss 4.2 dB and a 10 dB attenuator.

Example:

$$\begin{aligned} \text{Offset(dB)} &= \text{RF cable loss(dB)} + \text{attenuator factor(dB)}. \\ &= 4.2 + 10 = 14.2 \text{ (dB)} \end{aligned}$$



2.5 Frequency List of Low/Middle/High Channels

Frequency List				
Band	Channel/Frequency(MHz)	Lowest	Middle	Highest
WCDMA Band V	Channel	4132	4182	4233
	Frequency	826.4	836.4	846.6
WCDMA Band II	Channel	9262	9400	9538
	Frequency	1852.4	1880.0	1907.6
WCDMA Band IV	Channel	1312	1413	1513
	Frequency	1712.4	1732.6	1752.6

3 Conducted Test Result

3.1 Measuring Instruments

Please refer to the measuring equipment list in this test report.

3.1.1 Test Setup

3.1.2 Conducted Output Power



3.1.3 Peak-to-Average Ratio, Occupied Bandwidth, Conducted Band-Edge and Conducted Spurious Emission

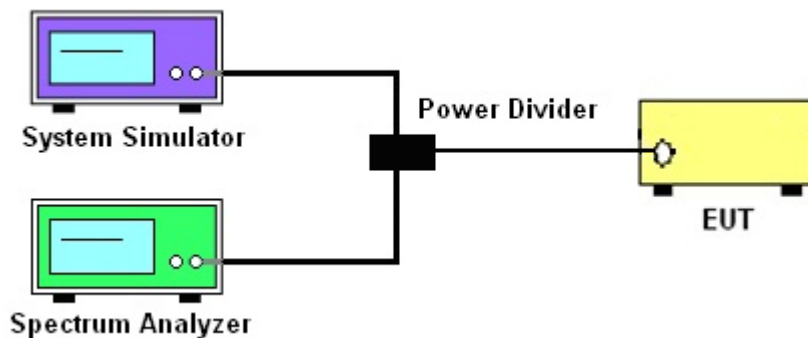

3.1.4 Frequency Stability

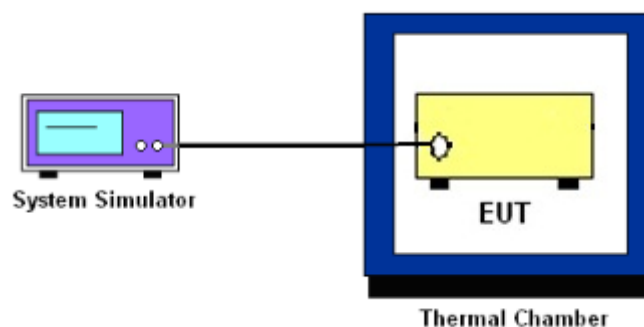

3.1.5 Test Result of Conducted Test

Please refer to Appendix A.



3.2 Conducted Output Power and ERP/EIRP

3.2.1 Description of the Conducted Output Power and ERP/EIRP

A system simulator was used to establish communication with the EUT. Its parameters were set to enforce EUT transmitting at the maximum power. The measured power in the radio frequency on the transmitter output terminals shall be reported.

The ERP of mobile transmitters must not exceed 7 Watts for WCDMA Band V

The EIRP of mobile transmitters must not exceed 2 Watts for WCDMA Band II

The EIRP of mobile transmitters must not exceed 1 Watts for WCDMA Band IV

According to KDB 412172 D01 Power Approach,

$EIRP = P_T + G_T - L_C$, $ERP = EIRP - 2.15$, where

P_T = transmitter output power in dBm

G_T = gain of the transmitting antenna in dBi

L_C = signal attenuation in the connecting cable between the transmitter and antenna in dB

3.2.2 Test Procedures

1. The transmitter output port is connected to the system simulator.
2. Set EUT at maximum power through system simulator.
3. Select the lowest, middle, and the highest channels for each band and different modulation.
4. Measure the maximum burst average power for GSM and maximum average power for other modulation signal.



3.3 Peak-to-Average Ratio

3.3.1 Description of the PAR Measurement

The peak-to-average ratio (PAR) of the transmission may not exceed 13 dB.

3.3.2 Test Procedures

The testing follows ANSI C63.26-2015 Section 5.2.6

1. The EUT is connected to spectrum analyzer and system simulator via a power divider.
2. Set EUT to transmit at maximum output power.
3. When the duty cycle is less than 98%, then signal gating will be implemented on the spectrum analyzer by triggering from the system simulator.
4. Set the CCDF (Complementary Cumulative Distribution Function) option of the spectrum analyzer.
5. Record the maximum PAPR level associated with a probability of 0.1%.



3.4 99% Occupied Bandwidth and 26dB Bandwidth Measurement

3.4.1 Description of 99% Occupied Bandwidth and 26dB Bandwidth Measurement

The occupied bandwidth is the width of a frequency band such that, below the lower and above the upper frequency limits, the mean powers emitted are each equal to a specified percentage 0.5% of the total mean transmitted power.

The 26 dB emission bandwidth is defined as the frequency range between two points, one above and one below the carrier frequency, at which the spectral density of the emission is attenuated 26 dB below the maximum in-band spectral density of the modulated signal. Spectral density (power per unit bandwidth) is to be measured with a detector of resolution bandwidth equal to approximately 1.0% of the emission bandwidth.

3.4.2 Test Procedures

The testing follows ANSI C63.26-2015 Section 5.4.3 (26dB) and Section 5.4.4 (99OB)

1. The EUT is connected to spectrum analyzer and system simulator via a power divider.
2. The spectrum analyzer center frequency is set to the nominal EUT channel center frequency. The span range for the spectrum analyzer shall be between two and five times the anticipated OBW.
3. The nominal resolution bandwidth (RBW) shall be in the range of 1 to 5 % of the anticipated OBW, and the VBW shall be at least 3 times the RBW.
4. Set the detection mode to peak, and the trace mode to max hold.
5. Determine the reference value: Set the EUT to transmit a modulated signal. Allow the trace to stabilize. Set the spectrum analyzer marker to the highest level of the displayed trace.
(This is the reference value)
6. Determine the “-26 dB down amplitude” as equal to (Reference Value – X).
7. Place two markers, one at the lowest and the other at the highest frequency of the envelope of the spectral display such that each marker is at or slightly below the “-X dB down amplitude” determined in step 6. If a marker is below this “-X dB down amplitude” value it shall be placed as close as possible to this value. The OBW is the positive frequency difference between the two markers.
8. Use the 99 % power bandwidth function of the spectrum analyzer and report the measured bandwidth.



3.5 Conducted Band Edge

3.5.1 Description of Conducted Band Edge Measurement

The power of any emission outside of the authorized operating frequency ranges must be lower than the transmitter power (P) by a factor of at least $43 + 10 \log (P)$ dB.

3.5.2 Test Procedures

The testing follows FCC KDB 971168 D01 v03r01 Section 6.1.

1. The EUT is connected to the spectrum analyzer and system simulator via a power divider.
2. The RF output of EUT is connected to the spectrum analyzer by an RF cable and attenuator. The path loss is compensated to the results for each measurement.
3. The band edges of low and high channels for the highest RF powers are measured.
4. The RF fundamental frequency shall be excluded against the limit line in the operating frequency band.
5. The limit line is derived from $43 + 10\log(P)$ dB below the transmitter power P(Watts)



3.6 Conducted Spurious Emission

3.6.1 Description of Conducted Spurious Emission Measurement

The power of any emission outside of the authorized operating frequency ranges must be lower than the transmitter power (P) by a factor of at least $43 + 10 \log (P)$ dB.

It is measured by means of a calibrated spectrum analyzer and scanned from 30 MHz up to a frequency including its 10th harmonic.

3.6.2 Test Procedures

The testing follows FCC KDB 971168 D01 v03r01 Section 6.1.

1. The EUT is connected to the spectrum analyzer and system simulator via a power divider.
2. The RF output of EUT is connected to the spectrum analyzer by an RF cable and attenuator. The path loss is compensated to the results for each measurement.
3. The middle channel for the highest RF power within the transmitting frequency is measured.
4. The conducted spurious emission for the whole frequency range is taken.
5. The RF fundamental frequency shall be excluded against the limit line in the operating frequency band.
6. The limit line is derived from $43 + 10\log(P)$ dB below the transmitter power P(Watts)



3.7 Frequency Stability

3.7.1 Description of Frequency Stability Measurement

22.355

The frequency stability shall be measured by variation of ambient temperature and variation of primary supply voltage to ensure that the fundamental emission stays within the authorized frequency block. The frequency stability of the transmitter shall be maintained within $\pm 0.00025\%$ ($\pm 2.5\text{ppm}$) of the center frequency.

24.235 & 27.54

The frequency stability shall be sufficient to ensure that the fundamental emission stays within the authorized frequency block.

3.7.2 Test Procedures for Temperature Variation

The testing follows FCC KDB 971168 D01 v03r01 Section 9.0.

1. The EUT is set up in the thermal chamber and connected with the system simulator.
2. With power OFF, the temperature is decreased to -30°C and the EUT is stabilized before testing. Power is applied and the maximum change in frequency is recorded within one minute.
3. With power OFF, the temperature is raised in 10°C steps up to 50°C . The EUT is stabilized at each step for at least half an hour. Power is applied and the maximum frequency change is recorded within one minute.

3.7.3 Test Procedures for Voltage Variation

The testing follows FCC KDB 971168 D01 v03r01 Section 9.0.

1. The EUT is placed in a temperature chamber at $20\pm 5^{\circ}\text{C}$ and connected with the system simulator.
2. The power supply voltage to the EUT is varied from 85% to 115% of the nominal value measured at the input to the EUT.
3. The variation in frequency is measured for the worst case.

4 Radiated Test Items

4.1 Measuring Instruments

Please refer to the measuring equipment list in this test report.

4.2 Test Setup

For radiated test below 30MHz



For radiated test from 30MHz to 1GHz



For radiated test from 1GHz to 18GHz

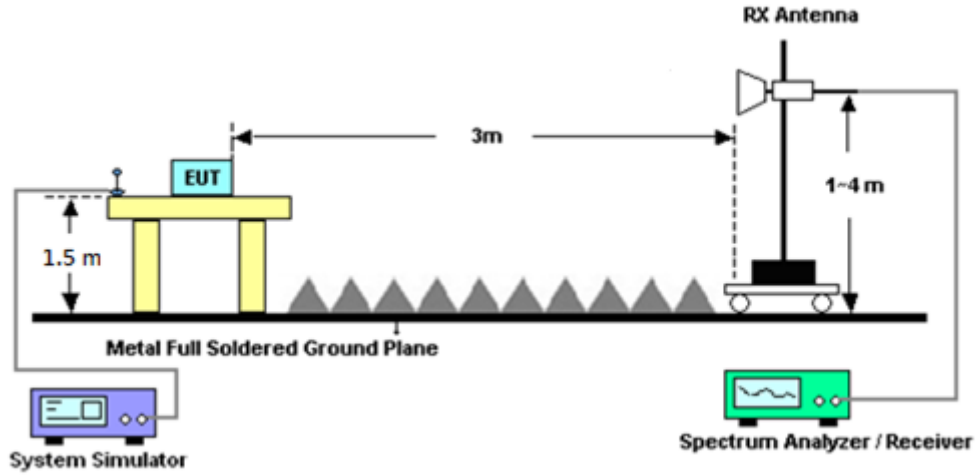

For radiated test above 18GHz

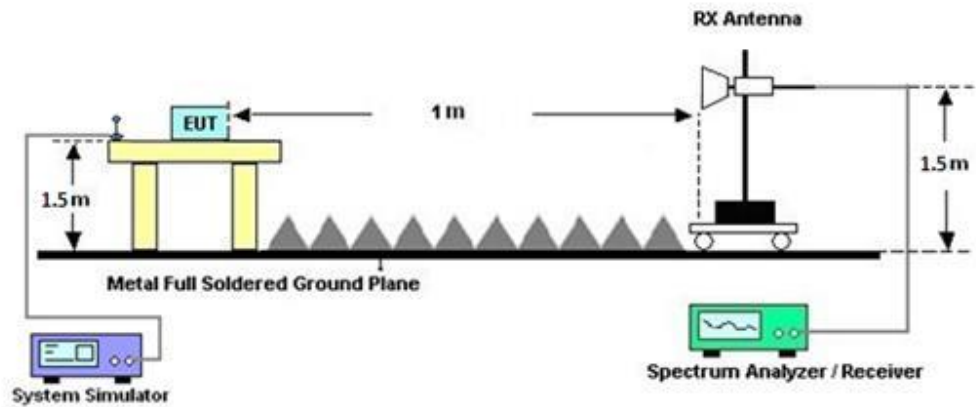

4.3 Test Result of Radiated Test

Please refer to Appendix B.

Note:

The low frequency, which starts from 9 kHz to 30 MHz, is pre-scanned and the result which is 20 dB lower than the limit line is not reported.

There is adequate comparison measurement of both open-field test site and alternative test site - semi-Anechoic chamber according to 414788 D01 Radiated Test Site v01r01, and the result came out very similar.



4.4 Field Strength of Spurious Radiation Measurement

4.4.1 Description of Field Strength of Spurious Radiated Measurement

The power of any emission outside of the authorized operating frequency ranges must be attenuated below the transmitter power (P) by a factor of at least $43 + 10 \log(P)$ dB. The spectrum is scanned from 30 MHz up to a frequency including its 10th harmonic.

4.4.2 Test Procedures

The testing follows FCC KDB 971168 D01 v03r01 Section 7 and ANSI C63.26-2015 section 5.5.4 Radiated measurement using the field strength method.

1. The EUT is placed on a rotatable wooden table 0.8 meters for frequency below 1 GHz and 1.5 meter for frequency above 1 GHz above the ground.
2. The EUT is set 3 meters away from the receiving antenna, which is mounted on the antenna tower.
3. The table is rotated 360 degrees to determine the position of the highest spurious emission.
4. The height of the receiving antenna is varied between one meter and four meters to search for the maximum spurious emission for both horizontal and vertical polarizations.
5. Make the measurement with the spectrum analyzer's RBW = 1 MHz, VBW = 3 MHz, taking record of maximum spurious emission.
6. To convert spectrum reading E(dBuV/m) to EIRP(dBm)
 $EIRP(dBm) = Level (dBuV/m) + 20\log(d) - 104.77$, where d is the distance at which field strength limit is specified in the rules
7. Field Strength Level (dBm) = Spectrum Reading (dBm) + Antenna Factor + Cable Loss + Read Level - Preamp Factor.
8. ERP (dBm) = EIRP (dBm) - 2.15
9. The RF fundamental frequency shall be excluded against the limit line in the operating frequency band.
10. The limit line is derived from $43 + 10\log(P)$ dB below the transmitter power P(Watts)



5 List of Measuring Equipment

Instrument	Brand Name	Model No.	Serial No.	Characteristics	Calibration Date	Test Date	Due Date	Remark
Bilog Antenna	TESEQ	CBL 6111D & 00800N1D01N-06	35419 & 03	30MHz~1GHz	Apr. 23, 2023	Feb. 29, 2024~Mar. 07, 2024	Apr. 22, 2024	Radiation (03CH07-HY)
Double Ridge Horn Antenna	ESCO	3117	00075962	1GHz ~ 18GHz	Nov. 27, 2023	Feb. 29, 2024~Mar. 07, 2024	Nov. 26, 2024	Radiation (03CH07-HY)
Preamplifier	COM-POWER	PA-103A	161241	10MHz~1GHz	Oct. 02, 2023	Feb. 29, 2024~Mar. 07, 2024	Oct. 01, 2024	Radiation (03CH07-HY)
Preamplifier	Agilent	8449B	3008A02362	1GHz~26.5GHz	Mar. 24, 2023	Feb. 29, 2024~Mar. 07, 2024	Mar. 23, 2024	Radiation (03CH07-HY)
Preamplifier	EMEC	EM18G40G	0600789	18-40GHz	Jul. 25, 2023	Feb. 29, 2024~Mar. 07, 2024	Jul. 24, 2024	Radiation (03CH07-HY)
RF Cable	HUBER + SUHNER	SUCOFLEX 104	MY28655/4 MY24971/4 MY15682/4	30MHz to 18GHz	Feb. 21, 2024	Feb. 29, 2024~Mar. 07, 2024	Feb. 20, 2025	Radiation (03CH07-HY)
RF Cable	HUBER + SUHNER	SUCOFLEX 102	MY2858/2	18GHz~40GHz	Feb. 21, 2024	Feb. 29, 2024~Mar. 07, 2024	Feb. 20, 2025	Radiation (03CH07-HY)
Spectrum Analyzer	Agilent	N9030A	MY52350276	3Hz~44GHz	Mar. 28, 2023	Feb. 29, 2024~Mar. 07, 2024	Mar. 27, 2024	Radiation (03CH07-HY)
Controller	EMEC	EM1000	N/A	Control Ant Mast	N/A	Feb. 29, 2024~Mar. 07, 2024	N/A	Radiation (03CH07-HY)
Controller	MF	MF-7802	N/A	Control Turn table	N/A	Feb. 29, 2024~Mar. 07, 2024	N/A	Radiation (03CH07-HY)
Antenna Mast	EMEC	AM-BS-4500E	N/A	Boresight mast 1M~4M	N/A	Feb. 29, 2024~Mar. 07, 2024	N/A	Radiation (03CH07-HY)
Turn Table	ChainTek	Chaintek 3000	N/A	0~360 Degree	N/A	Feb. 29, 2024~Mar. 07, 2024	N/A	Radiation (03CH07-HY)
Software	Audix	E3	N/A	N/A	N/A	Feb. 29, 2024~Mar. 07, 2024	N/A	Radiation (03CH07-HY)
USB Data Logger	TECPEL	TR-32	HE17XB2495	N/A	Mar. 14, 2023	Feb. 29, 2024~Mar. 07, 2024	Mar. 13, 2024	Radiation (03CH07-HY)
SHF-EHF Horn Antenna	SCHWARZBECK	BBHA 9170	BBHA9170251	18GHz~40GHz	Nov. 24, 2023	Feb. 29, 2024~Mar. 07, 2024	Nov. 23, 2024	Radiation (03CH07-HY)
Spectrum Analyzer	Rohde & Schwarz	FSP30	101329	9kHz~30GHz	Sep. 20, 2023	Nov. 27, 2023~Mar. 15, 2024	Sep. 19, 2024	Conducted (TH03-HY)
Base Station (Measure)	Rohde & Schwarz	CMU200	117995	GSM / GPRS / WCDMA / CDMA	Aug. 06, 2023	Nov. 27, 2023~Mar. 15, 2024	Aug. 05, 2024	Conducted (TH03-HY)
Thermal Chamber	ESPEC	SU-241	92003713	-30℃ ~95℃	May 17, 2023	Nov. 27, 2023~Mar. 15, 2024	May 16, 2024	Conducted (TH03-HY)
Hygrometer	TECPEL	DTM-303A	TP201996	N/A	Nov. 07, 2023	Nov. 27, 2023~Mar. 15, 2024	Nov. 06, 2024	Conducted (TH03-HY)
Programmable Power Supply	GW Instek	PSS-2005	EL890001	1V~20V 0.5A~4A	Sep. 12, 2023	Nov. 27, 2023~Mar. 15, 2024	Sep. 11, 2024	Conducted (TH03-HY)



6 Measurement Uncertainty

Uncertainty of Radiated Emission Measurement (30 MHz ~ 1000 MHz)

Measuring Uncertainty for a Level of Confidence of 95% ($U = 2Uc(y)$)	3.46 dB
---	---------

Uncertainty of Radiated Emission Measurement (1 GHz ~ 18 GHz)

Measuring Uncertainty for a Level of Confidence of 95% ($U = 2Uc(y)$)	3.33 dB
---	---------

Uncertainty of Radiated Emission Measurement (18 GHz ~ 40 GHz)

Measuring Uncertainty for a Level of Confidence of 95% ($U = 2Uc(y)$)	3.91 dB
---	---------



Appendix A. Test Results of Conducted Test

Conducted Output Power(Average power) & ERP / EIRP

WCDMA Band V Maximum Average Power [dBm] (GT - LC = -10.9 dB)							
Channel	4132	4182	4233	ERP (dBm)	ERP (W)		
Frequency	826.4	836.4	846.6				
RMC 12.2K	22.93	23.06	22.79	10.01	0.0100		
HSDPA Subtest-1	22.75	23.00	22.76				
HSDPA Subtest-2	22.89	22.79	22.77				
HSDPA Subtest-3	22.41	22.47	22.30				
HSDPA Subtest-4	22.38	22.42	22.24				
HSUPA Subtest-1	22.05	22.02	22.01				
HSUPA Subtest-2	20.96	20.93	20.94				
HSUPA Subtest-3	21.95	21.89	21.89				
HSUPA Subtest-4	20.96	20.88	20.88				
HSUPA Subtest-5	22.82	22.74	22.77				
Limit	ERP < 7W					Result	Pass

WCDMA Band II Maximum Average Power [dBm] (GT - LC = -8.1 dB)							
Channel	9262	9400	9538	EIRP (dBm)	EIRP (W)		
Frequency	1852.4	1880	1907.6				
RMC 12.2K	22.71	22.73	22.94	14.84	0.0305		
HSDPA Subtest-1	22.62	22.53	22.51				
HSDPA Subtest-2	22.53	22.54	22.50				
HSDPA Subtest-3	22.00	21.98	22.01				
HSDPA Subtest-4	22.02	22.03	22.02				
HSUPA Subtest-1	22.15	22.30	22.18				
HSUPA Subtest-2	20.76	20.81	20.96				
HSUPA Subtest-3	21.78	21.78	21.91				
HSUPA Subtest-4	20.75	20.77	20.98				
HSUPA Subtest-5	22.74	22.61	22.80				
Limit	EIRP < 2W					Result	Pass

WCDMA Band IV Maximum Average Power [dBm] (GT - LC = -6.7 dB)							
Channel	1312	1413	1513	EIRP (dBm)	EIRP (W)		
Frequency	1712.4	1732.6	1752.6				
RMC 12.2K	23.03	22.86	22.82	16.33	0.0430		
HSDPA Subtest-1	22.53	22.51	22.49				
HSDPA Subtest-2	22.48	22.54	22.51				
HSDPA Subtest-3	22.00	22.04	22.01				
HSDPA Subtest-4	21.99	22.00	21.99				
HSUPA Subtest-1	22.61	22.52	22.45				
HSUPA Subtest-2	21.13	21.14	21.20				
HSUPA Subtest-3	22.10	22.03	22.08				
HSUPA Subtest-4	21.06	21.04	21.05				
HSUPA Subtest-5	22.93	22.84	22.90				
Limit	EIRP < 1W					Result	Pass



A2. WCDMA

Peak-to-Average Ratio

Mode	WCDMA Band V	WCDMA Band II	WCDMA Band IV	Limit: 13dB
Mod.	RMC 12.2Kbps	RMC 12.2Kbps	RMC 12.2Kbps	Result
Lowest CH	2.92	3.24	3.00	PASS
Middle CH	2.72	3.28	3.16	
Highest CH	3.00	3.20	3.28	

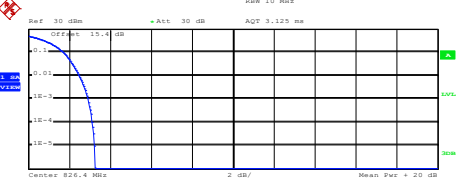
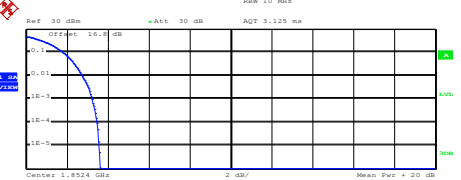
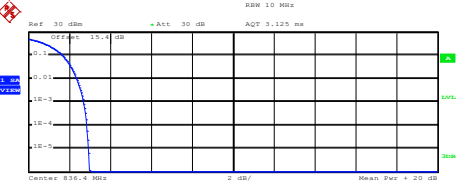
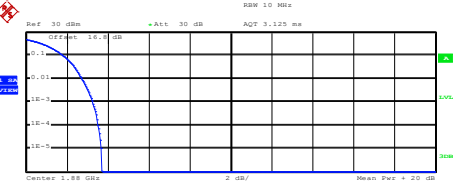
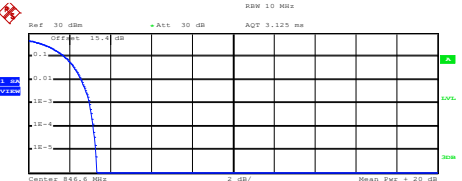
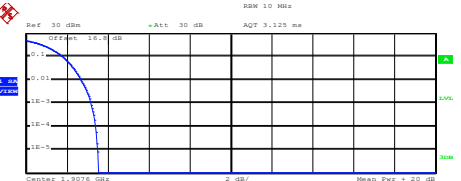

WCDMA Band V (RMC 12.2Kbps)	WCDMA Band II (RMC 12.2Kbps)																												
<p align="center">Lowest Channel</p>  <p>Center 826.4 MHz 2 dB/ Mean Pwr + 20 dB</p> <p>Complementary Cumulative Distribution Function (100000 samples)</p> <p>Trace 1</p> <table border="0"> <tr><td>Mean</td><td>22.11 dBm</td></tr> <tr><td>Peak</td><td>25.36 dBm</td></tr> <tr><td>Crest</td><td>3.25 dB</td></tr> </table> <table border="0"> <tr><td>10 %</td><td>1.72 dB</td></tr> <tr><td>1 %</td><td>2.48 dB</td></tr> <tr><td>.1 %</td><td>2.92 dB</td></tr> <tr><td>.01 %</td><td>3.12 dB</td></tr> </table> <p>Date: 27.NOV.2023 16:15:12</p>	Mean	22.11 dBm	Peak	25.36 dBm	Crest	3.25 dB	10 %	1.72 dB	1 %	2.48 dB	.1 %	2.92 dB	.01 %	3.12 dB	<p align="center">Lowest Channel</p>  <p>Center 1.8524 GHz 2 dB/ Mean Pwr + 20 dB</p> <p>Complementary Cumulative Distribution Function (100000 samples)</p> <p>Trace 1</p> <table border="0"> <tr><td>Mean</td><td>21.87 dBm</td></tr> <tr><td>Peak</td><td>25.50 dBm</td></tr> <tr><td>Crest</td><td>3.63 dB</td></tr> </table> <table border="0"> <tr><td>10 %</td><td>1.80 dB</td></tr> <tr><td>1 %</td><td>2.76 dB</td></tr> <tr><td>.1 %</td><td>3.24 dB</td></tr> <tr><td>.01 %</td><td>3.48 dB</td></tr> </table> <p>Date: 27.NOV.2023 14:52:30</p>	Mean	21.87 dBm	Peak	25.50 dBm	Crest	3.63 dB	10 %	1.80 dB	1 %	2.76 dB	.1 %	3.24 dB	.01 %	3.48 dB
Mean	22.11 dBm																												
Peak	25.36 dBm																												
Crest	3.25 dB																												
10 %	1.72 dB																												
1 %	2.48 dB																												
.1 %	2.92 dB																												
.01 %	3.12 dB																												
Mean	21.87 dBm																												
Peak	25.50 dBm																												
Crest	3.63 dB																												
10 %	1.80 dB																												
1 %	2.76 dB																												
.1 %	3.24 dB																												
.01 %	3.48 dB																												
<p align="center">Middle Channel</p>  <p>Center 826.4 MHz 2 dB/ Mean Pwr + 20 dB</p> <p>Complementary Cumulative Distribution Function (100000 samples)</p> <p>Trace 1</p> <table border="0"> <tr><td>Mean</td><td>22.21 dBm</td></tr> <tr><td>Peak</td><td>25.22 dBm</td></tr> <tr><td>Crest</td><td>3.00 dB</td></tr> </table> <table border="0"> <tr><td>10 %</td><td>1.68 dB</td></tr> <tr><td>1 %</td><td>2.36 dB</td></tr> <tr><td>.1 %</td><td>2.72 dB</td></tr> <tr><td>.01 %</td><td>2.88 dB</td></tr> </table> <p>Date: 27.NOV.2023 16:15:34</p>	Mean	22.21 dBm	Peak	25.22 dBm	Crest	3.00 dB	10 %	1.68 dB	1 %	2.36 dB	.1 %	2.72 dB	.01 %	2.88 dB	<p align="center">Middle Channel</p>  <p>Center 1.85 GHz 2 dB/ Mean Pwr + 20 dB</p> <p>Complementary Cumulative Distribution Function (100000 samples)</p> <p>Trace 1</p> <table border="0"> <tr><td>Mean</td><td>21.79 dBm</td></tr> <tr><td>Peak</td><td>25.50 dBm</td></tr> <tr><td>Crest</td><td>3.71 dB</td></tr> </table> <table border="0"> <tr><td>10 %</td><td>1.84 dB</td></tr> <tr><td>1 %</td><td>2.72 dB</td></tr> <tr><td>.1 %</td><td>3.28 dB</td></tr> <tr><td>.01 %</td><td>3.52 dB</td></tr> </table> <p>Date: 27.NOV.2023 14:52:53</p>	Mean	21.79 dBm	Peak	25.50 dBm	Crest	3.71 dB	10 %	1.84 dB	1 %	2.72 dB	.1 %	3.28 dB	.01 %	3.52 dB
Mean	22.21 dBm																												
Peak	25.22 dBm																												
Crest	3.00 dB																												
10 %	1.68 dB																												
1 %	2.36 dB																												
.1 %	2.72 dB																												
.01 %	2.88 dB																												
Mean	21.79 dBm																												
Peak	25.50 dBm																												
Crest	3.71 dB																												
10 %	1.84 dB																												
1 %	2.72 dB																												
.1 %	3.28 dB																												
.01 %	3.52 dB																												
<p align="center">Highest Channel</p>  <p>Center 846.6 MHz 2 dB/ Mean Pwr + 20 dB</p> <p>Complementary Cumulative Distribution Function (100000 samples)</p> <p>Trace 1</p> <table border="0"> <tr><td>Mean</td><td>22.03 dBm</td></tr> <tr><td>Peak</td><td>25.36 dBm</td></tr> <tr><td>Crest</td><td>3.33 dB</td></tr> </table> <table border="0"> <tr><td>10 %</td><td>1.76 dB</td></tr> <tr><td>1 %</td><td>2.60 dB</td></tr> <tr><td>.1 %</td><td>3.00 dB</td></tr> <tr><td>.01 %</td><td>3.16 dB</td></tr> </table> <p>Date: 27.NOV.2023 16:15:55</p>	Mean	22.03 dBm	Peak	25.36 dBm	Crest	3.33 dB	10 %	1.76 dB	1 %	2.60 dB	.1 %	3.00 dB	.01 %	3.16 dB	<p align="center">Highest Channel</p>  <p>Center 1.9076 GHz 2 dB/ Mean Pwr + 20 dB</p> <p>Complementary Cumulative Distribution Function (100000 samples)</p> <p>Trace 1</p> <table border="0"> <tr><td>Mean</td><td>21.89 dBm</td></tr> <tr><td>Peak</td><td>25.43 dBm</td></tr> <tr><td>Crest</td><td>3.54 dB</td></tr> </table> <table border="0"> <tr><td>10 %</td><td>1.80 dB</td></tr> <tr><td>1 %</td><td>2.68 dB</td></tr> <tr><td>.1 %</td><td>3.20 dB</td></tr> <tr><td>.01 %</td><td>3.40 dB</td></tr> </table> <p>Date: 27.NOV.2023 14:53:16</p>	Mean	21.89 dBm	Peak	25.43 dBm	Crest	3.54 dB	10 %	1.80 dB	1 %	2.68 dB	.1 %	3.20 dB	.01 %	3.40 dB
Mean	22.03 dBm																												
Peak	25.36 dBm																												
Crest	3.33 dB																												
10 %	1.76 dB																												
1 %	2.60 dB																												
.1 %	3.00 dB																												
.01 %	3.16 dB																												
Mean	21.89 dBm																												
Peak	25.43 dBm																												
Crest	3.54 dB																												
10 %	1.80 dB																												
1 %	2.68 dB																												
.1 %	3.20 dB																												
.01 %	3.40 dB																												



WCDMA Band IV (RMC 12.2Kbps)

Lowest Channel

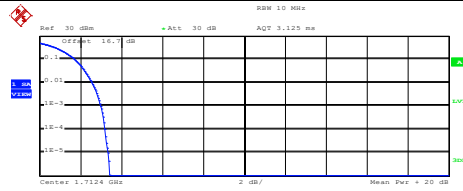

Complementary Cumulative Distribution Function (100000 samples)

Trace 1
 Mean 22.50 dBm
 Peak 25.92 dBm
 Crest 3.43 dB

10 % 1.72 dB
 1 % 2.56 dB
 .1 % 3.00 dB
 .01 % 3.20 dB

Date: 27.NOV.2023 15:50:09

Middle Channel

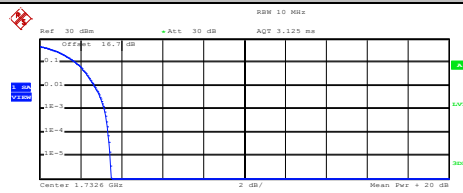

Complementary Cumulative Distribution Function (100000 samples)

Trace 1
 Mean 22.01 dBm
 Peak 25.50 dBm
 Crest 3.49 dB

10 % 1.76 dB
 1 % 2.68 dB
 .1 % 3.16 dB
 .01 % 3.36 dB

Date: 27.NOV.2023 15:50:29

Highest Channel

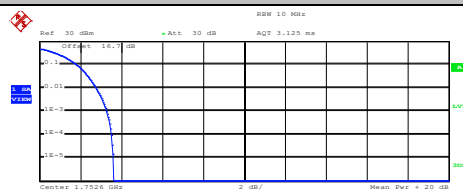

Complementary Cumulative Distribution Function (100000 samples)

Trace 1
 Mean 22.15 dBm
 Peak 25.78 dBm
 Crest 3.63 dB

10 % 1.80 dB
 1 % 2.76 dB
 .1 % 3.28 dB
 .01 % 3.52 dB

Date: 27.NOV.2023 15:50:52



26dB Bandwidth

Mode	WCDMA Band V 26dB BW(MHz)	WCDMA Band II 26dB BW(MHz)	WCDMA Band IV 26dB BW(MHz)
Mod.	RMC 12.2Kbps	RMC 12.2Kbps	RMC 12.2Kbps
Lowest CH	4.73	4.73	4.73
Middle CH	4.73	4.72	4.75
Highest CH	4.74	4.74	4.73

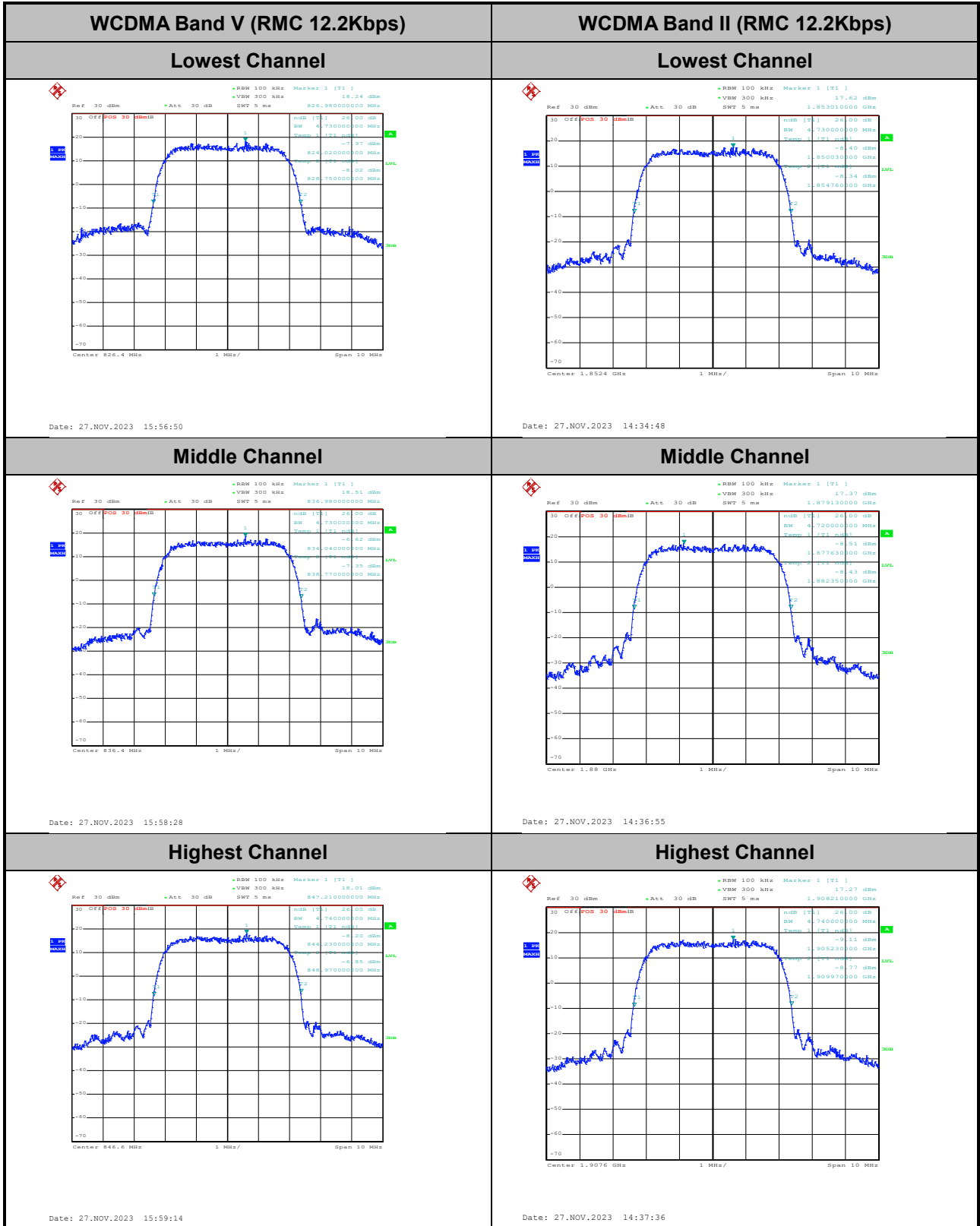



WCDMA Band IV (RMC 12.2Kbps)

Lowest Channel

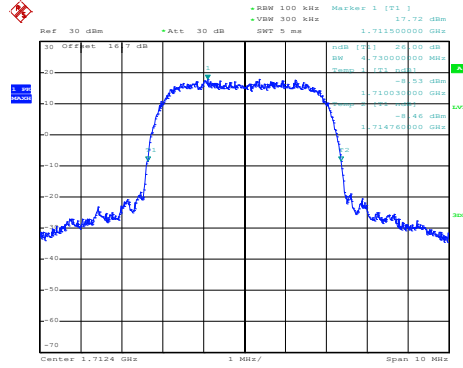

Date: 27.NOV.2023 15:29:24

Middle Channel

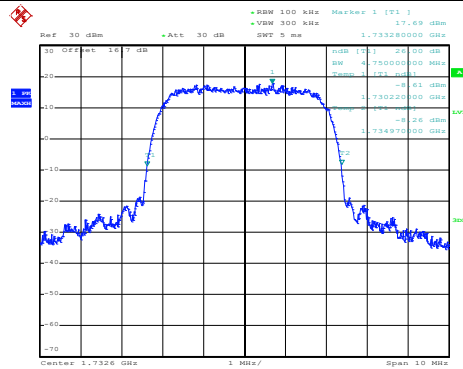

Date: 27.NOV.2023 15:30:56

Highest Channel

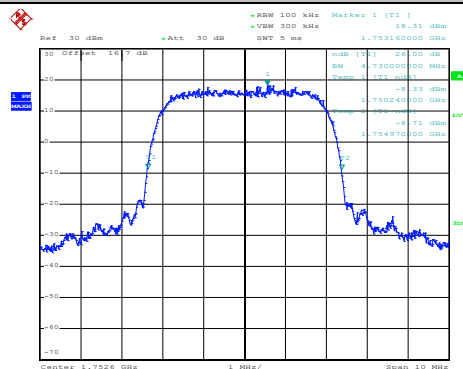

Date: 27.NOV.2023 15:31:50



Occupied Bandwidth

Mode	WCDMA Band V 99%OBW(MHz)	WCDMA Band II 99%OBW(MHz)	WCDMA Band IV 99%OBW(MHz)
Mod.	RMC 12.2Kbps	RMC 12.2Kbps	RMC 12.2Kbps
Lowest CH	4.15	4.15	4.13
Middle CH	4.15	4.15	4.13
Highest CH	4.14	4.15	4.13

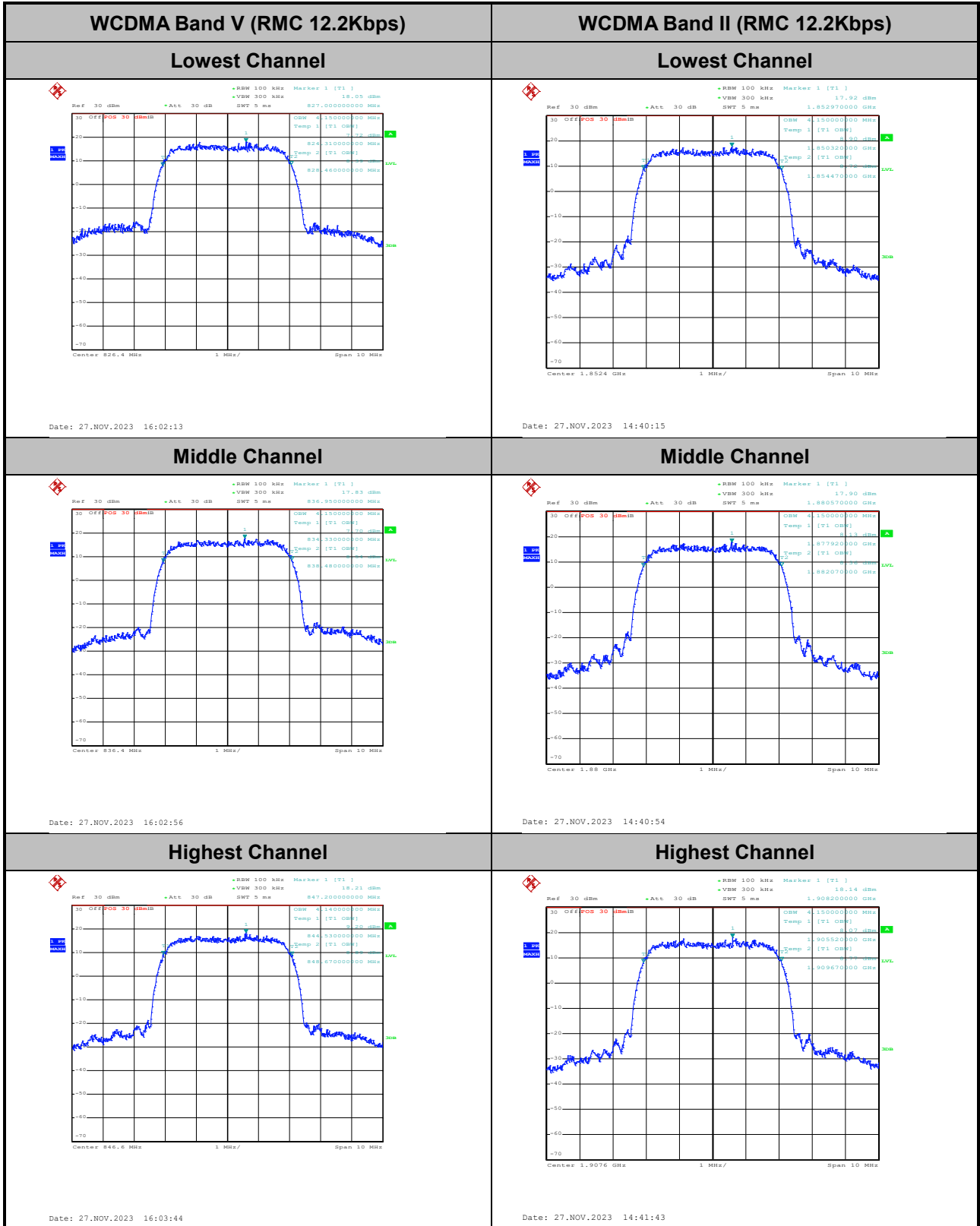

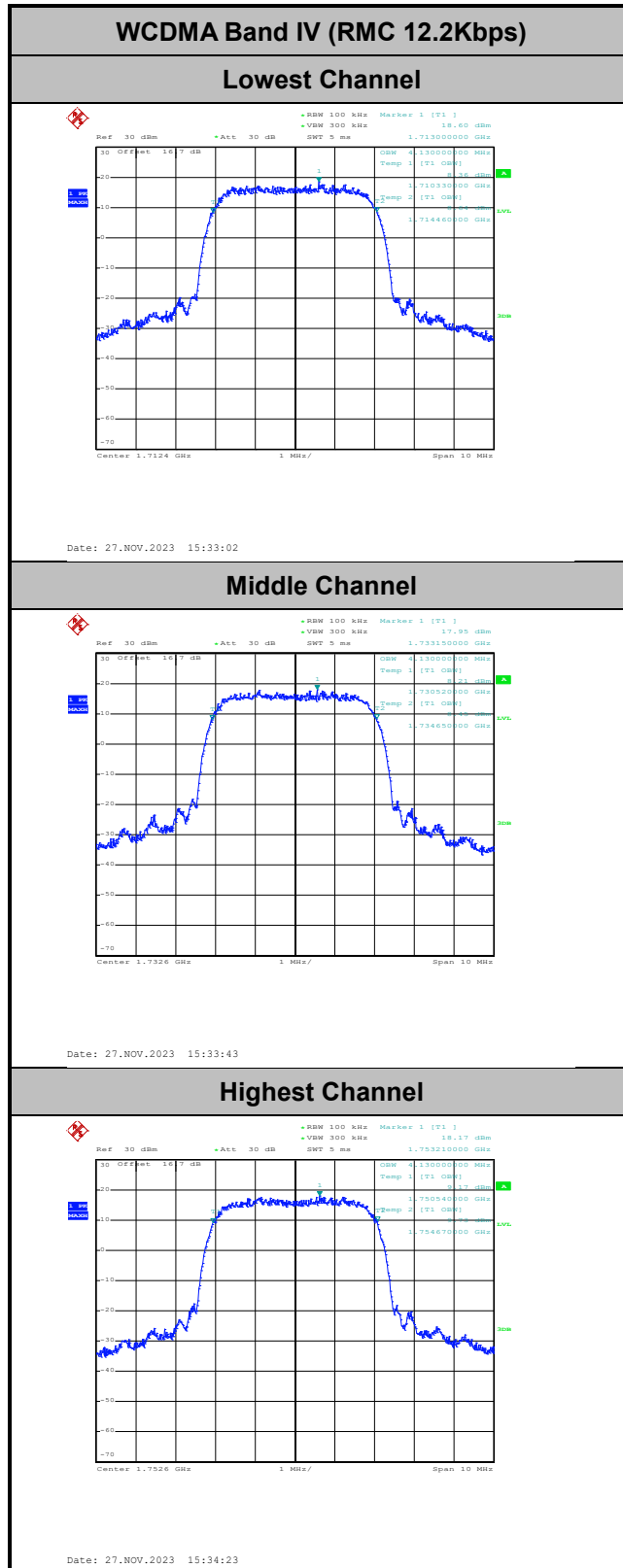



Conducted Band Edge

WCDMA Band V (RMC 12.2Kbps)

Lowest Band Edge

Highest Band Edge

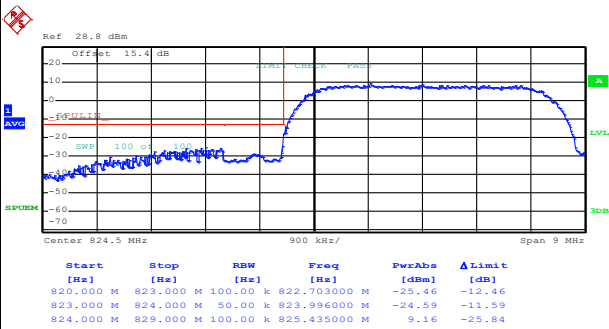

Date: 27.NOV.2023 16:07:08

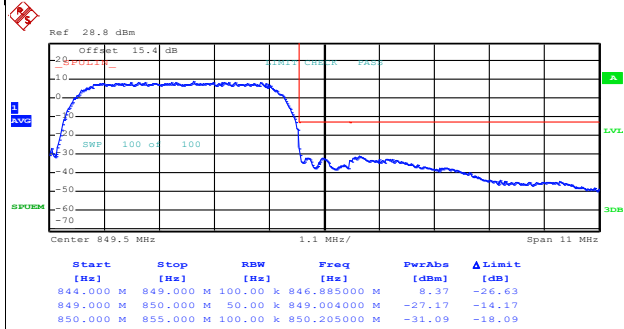

Date: 27.NOV.2023 16:10:15



WCDMA Band II (RMC 12.2Kbps)

Lowest Band Edge

Highest Band Edge

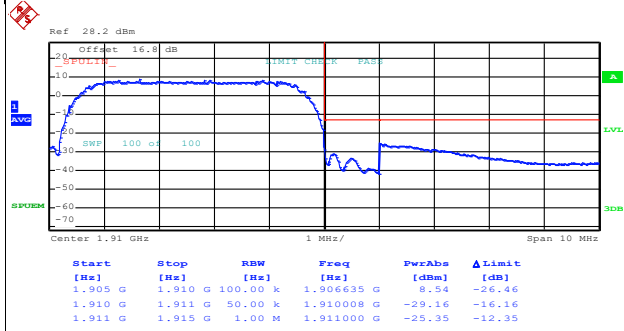
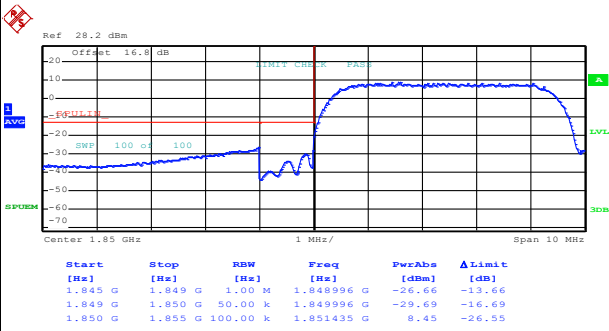

Date: 27.NOV.2023 14:45:21

Date: 27.NOV.2023 14:48:16



WCDMA Band IV (RMC 12.2Kbps)

Lowest Band Edge

Highest Band Edge

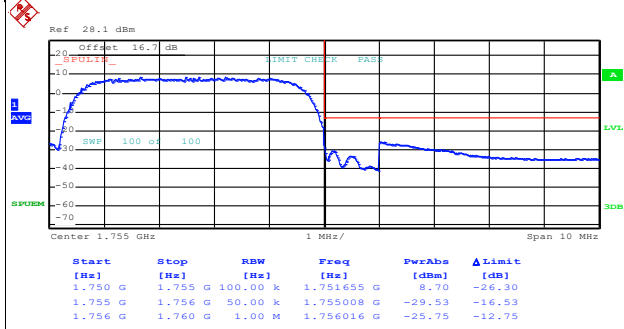
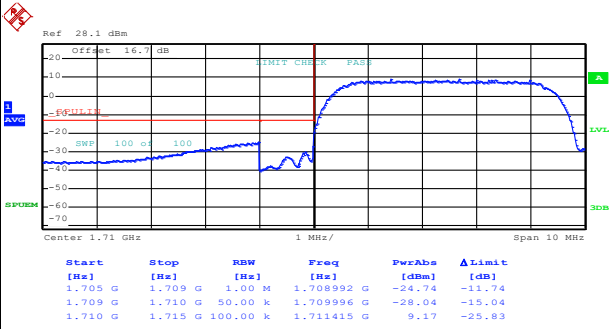

Date: 27.NOV.2023 15:38:02

Date: 27.NOV.2023 15:41:05



Conducted Spurious Emission

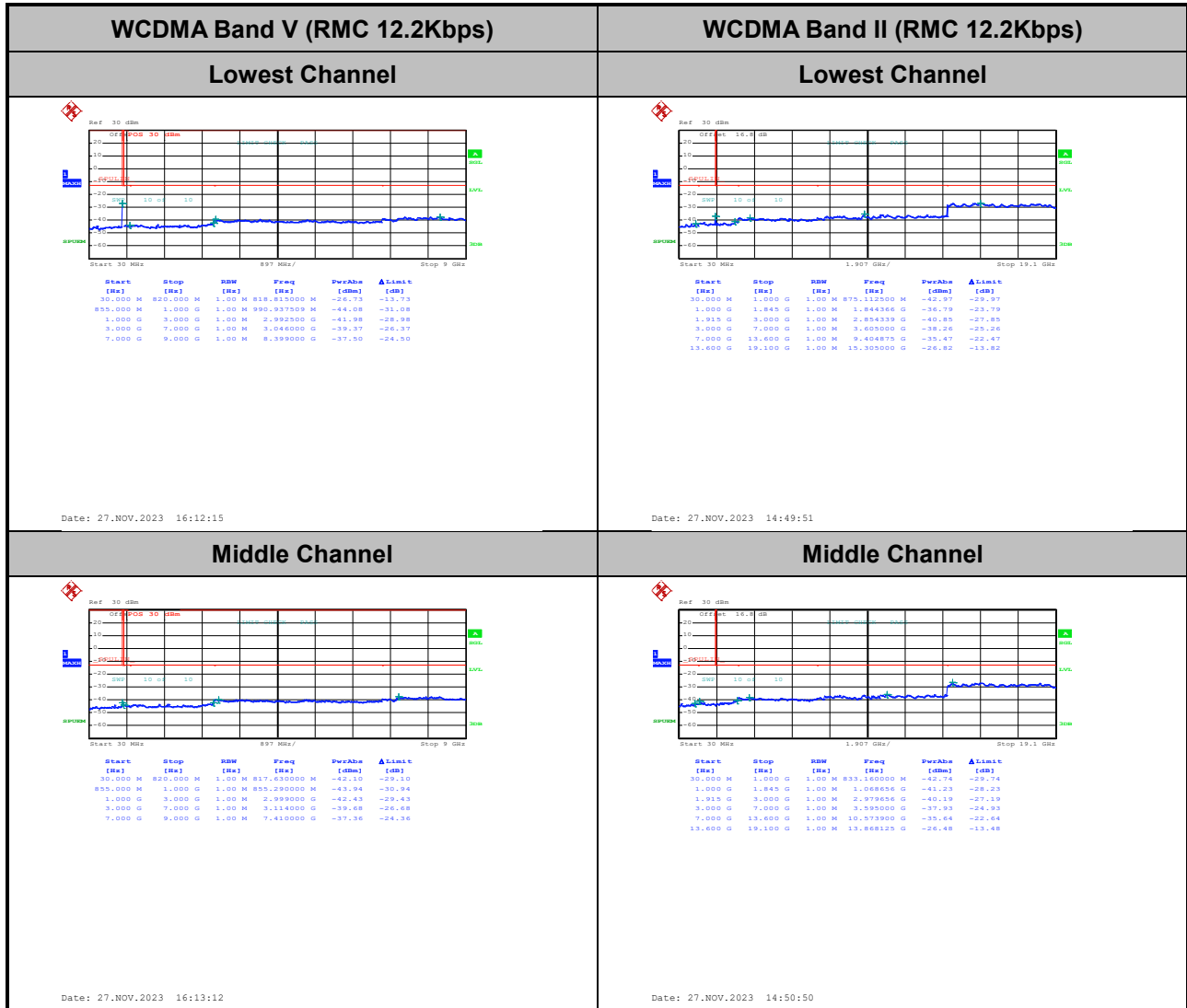

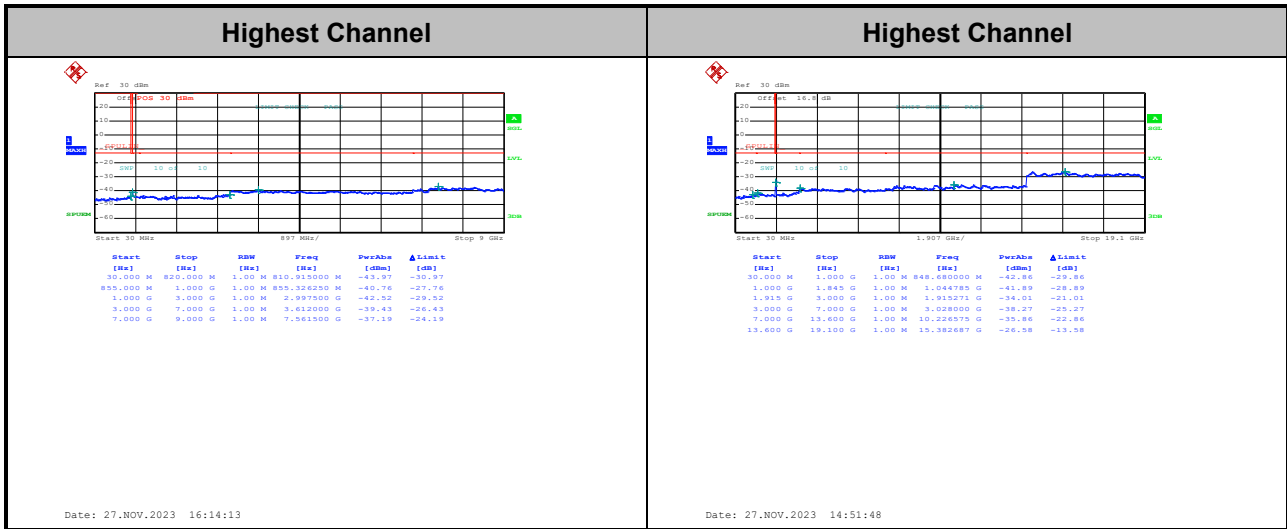



WCDMA Band IV (RMC 12.2Kbps)

Lowest Channel

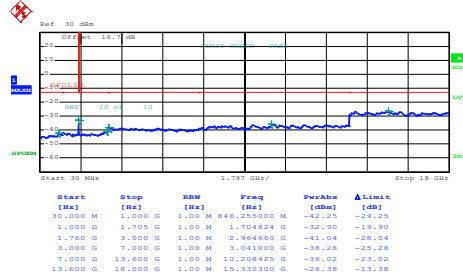

Date: 27.NOV.2023 15:42:37

Middle Channel

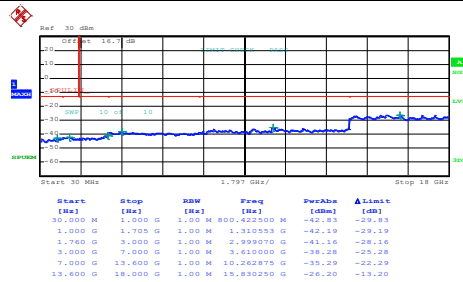

Date: 27.NOV.2023 15:43:36

Highest Channel

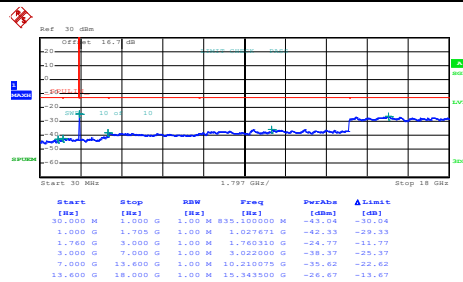

Date: 27.NOV.2023 15:44:34



Frequency Stability

Test Conditions	Middle Channel	WCDMA Band V (RMC 12.2Kbps)	Limit
			2.5ppm
Temperature (°C)	Voltage (Volt)	Deviation (ppm)	Result
35	Normal Voltage	0.0012	PASS
30	Normal Voltage	0.0024	
20(Ref.)	Normal Voltage	0.0000	
10	Normal Voltage	0.0096	
0	Normal Voltage	0.0155	
20	Maximum Voltage	0.0048	
20	Normal Voltage	0.0012	
20	Battery End Point	0.0036	

Test Conditions	Middle Channel	WCDMA Band II (RMC 12.2Kbps)	Limit
			Note 2.
Temperature (°C)	Voltage (Volt)	Deviation (ppm)	Result
35	Normal Voltage	0.0064	PASS
30	Normal Voltage	0.0048	
20(Ref.)	Normal Voltage	0.0000	
10	Normal Voltage	0.0021	
0	Normal Voltage	0.0027	
20	Maximum Voltage	0.0069	
20	Normal Voltage	0.0011	
20	Battery End Point	0.0005	

Note:

1. Normal Voltage = 3.88V. ; Battery End Point (BEP) = 3.60 V. ; Maximum Voltage =4.40 V
2. The frequency fundamental emissions stay within the authorized frequency block.



Test Conditions	Middle Channel	WCDMA Band IV (RMC 12.2Kbps)	Limit
		Deviation (ppm)	Note 2.
Temperature (°C)	Voltage (Volt)		Result
35	Normal Voltage	0.0069	PASS
30	Normal Voltage	0.0046	
20(Ref.)	Normal Voltage	0.0000	
10	Normal Voltage	0.0012	
0	Normal Voltage	0.0029	
20	Maximum Voltage	0.0023	
20	Normal Voltage	0.0017	
20	Battery End Point	0.0040	

Note:

- 1. Normal Voltage = 3.88V. ; Battery End Point (BEP) = 3.60 V. ; Maximum Voltage =4.40 V
- 2. The frequency fundamental emissions stay within the authorized frequency block.



Appendix B. Test Results of Radiated Test

B1. Summary of each worse mode

Mode	Part	Band	Ch	Freq (MHz)	Level (dBm)	Det	Ant Factor (dB)	Amp\Cbl (dB)	Filter (dB)	EIRPCF (dB)	Reading (dBuV)	Limit (dBm)	Margin (dB)	Pol	Ant
1	Part 22H	WCDMA B5	M	2512	-50.00	RMS	32.42	-25.56	0.24	-95.23	38.13	-13.00	-37.00	H	ANT2
1	Part 24E	WCDMA B2	H	7630	-53.11	RMS	35.90	-19.28	0.35	-95.23	25.15	-13.00	-40.11	V	ANT1
1	Part 27L	WCDMA B4	L	5145	-52.03	RMS	34.27	-21.56	0.43	-95.23	30.06	-13.00	-39.03	V	ANT1



ANT2

Part 22H Mode 1

WCDMA B5 Ch4132

L

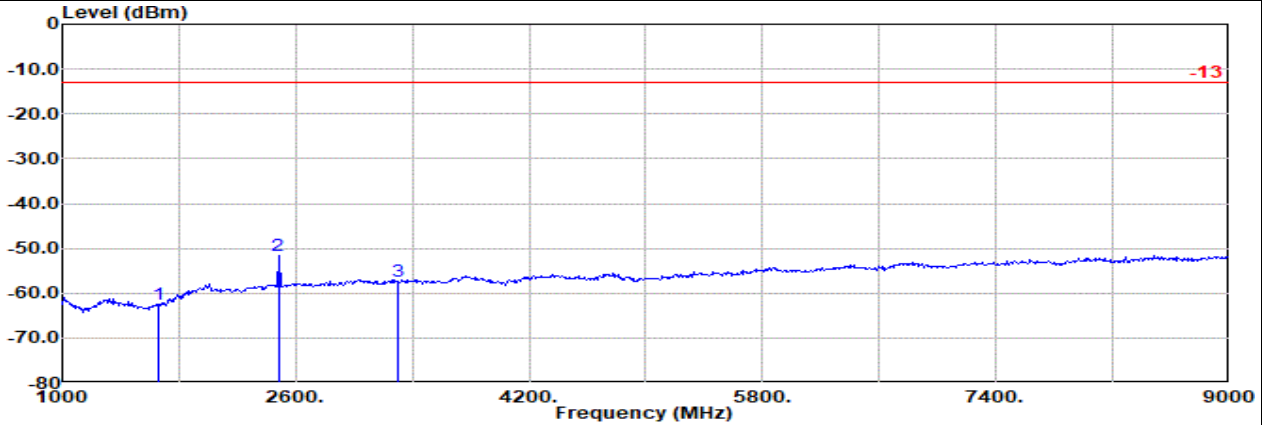

Site : 03CH07-HY
 Condition: -13 3m HF_ANT_00075962 Horizontal
 Mode : WCDMA 850 Ch4132

1	MHz	Level dBm	Detector	Ant Amp\Cb Filter		EIRPCF	Readin g	Limit dBm	Margin Pol		
				Factor	1				dB	dB	dB
	1656.00	-62.41	RMS	28.70	-27.18	0.31	-95.23	0.00	-13.00	-49.41	Horizontal
2	2480.00	-51.56	RMS	32.10	-25.61	0.29	-95.23	36.89	-13.00	-38.56	Horizontal
3	3304.00	-57.40	RMS	32.81	-24.19	0.14	-95.23	29.07	-13.00	-44.40	Horizontal

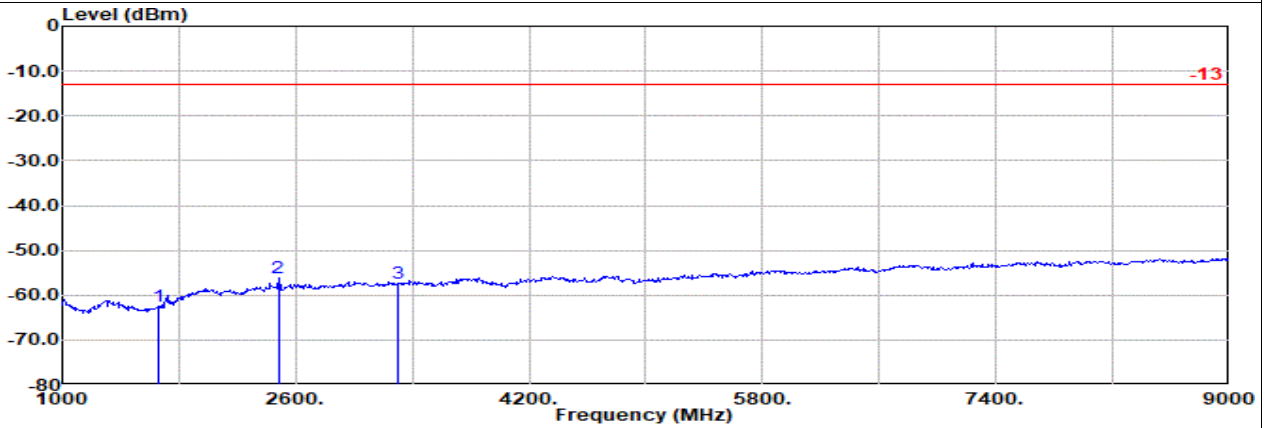

Site : 03CH07-HY
 Condition: -13 3m HF_ANT_00075962 Vertical
 Mode : WCDMA 850 Ch4132

1	MHz	Level dBm	Detector	Ant Amp\Cb Filter		EIRPCF	Readin g	Limit dBm	Margin Pol		
				Factor	1				dB	dB	dB
	1656.00	-62.39	RMS	28.70	-27.18	0.31	-95.23	31.01	-13.00	-49.39	Vertical
2	2480.00	-56.00	RMS	32.10	-25.61	0.29	-95.23	32.45	-13.00	-43.00	Vertical
3	3304.00	-57.35	RMS	32.81	-24.19	0.14	-95.23	29.12	-13.00	-44.35	Vertical



ANT2

Part 22H Mode 1
WCDMA B5 Ch4182
M

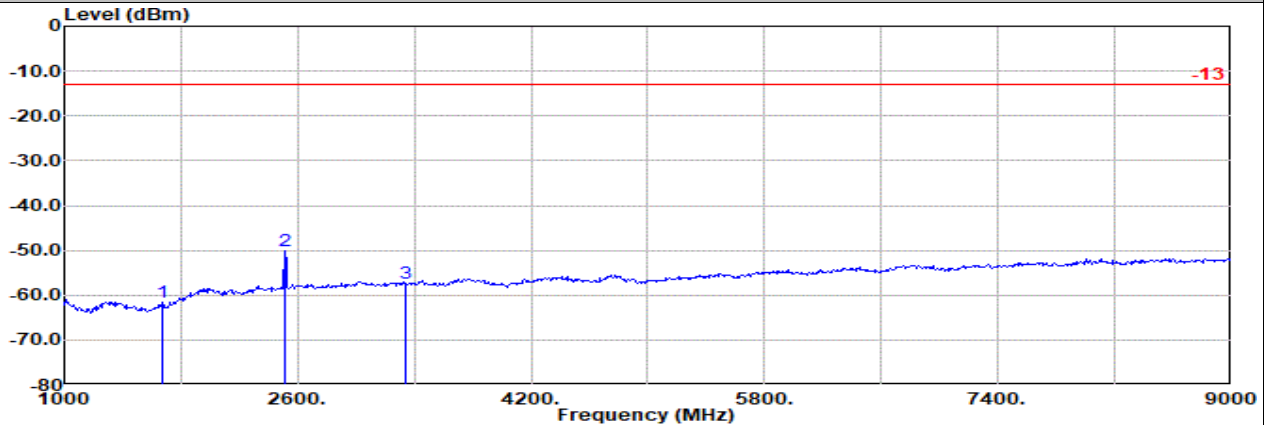

Site : 03CH07-HY
Condition: -13 3m HF_ANT_00075962 Horizontal
Mode : WCDMA 850 Ch4182

1	2	3	MHz	Level dBm	Detector	Ant Amp\Cb Filter		EIRPCF	Readin g	Limit	Margin	Pol	
						Factor	1						dB
			1672.00	-61.69	RMS	28.70	-27.14	0.31	-95.23	31.67	-13.00	-48.69	Horizontal
			2512.00	-50.00	RMS	32.42	-25.56	0.24	-95.23	38.13	-13.00	-37.00	Horizontal
			3344.00	-57.50	RMS	32.89	-24.10	0.14	-95.23	28.80	-13.00	-44.50	Horizontal

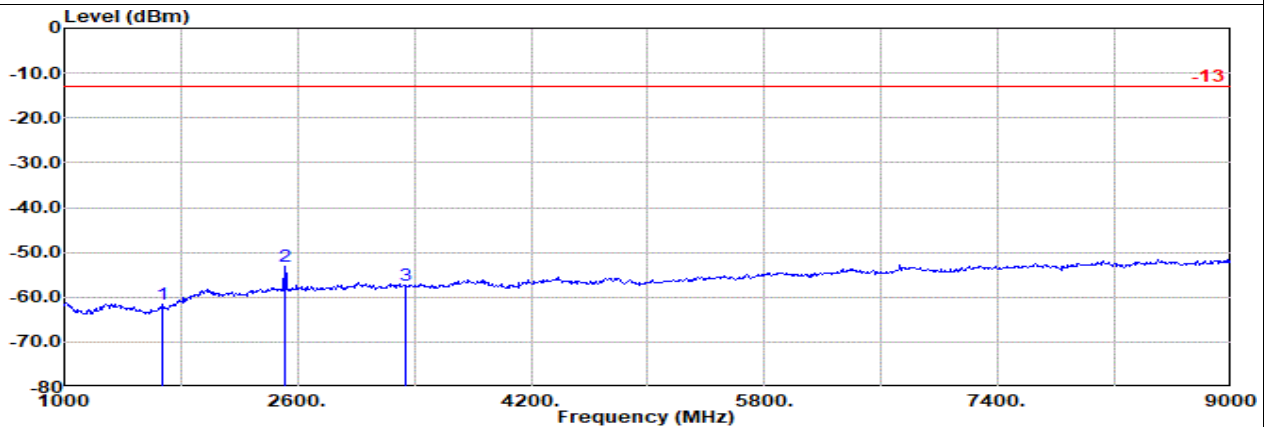

Site : 03CH07-HY
Condition: -13 3m HF_ANT_00075962 Vertical
Mode : WCDMA 850 Ch4182

1	2	3	MHz	Level dBm	Detector	Ant Amp\Cb Filter		EIRPCF	Readin g	Limit	Margin	Pol	
						Factor	1						dB
			1672.00	-61.65	RMS	28.70	-27.14	0.31	-95.23	31.71	-13.00	-48.65	Vertical
			2512.00	-53.17	RMS	32.42	-25.56	0.24	-95.23	34.96	-13.00	-40.17	Vertical
			3344.00	-57.38	RMS	32.89	-24.10	0.14	-95.23	28.92	-13.00	-44.38	Vertical



ANT2

Part 22H Mode 1
WCDMA B5 Ch4233
H

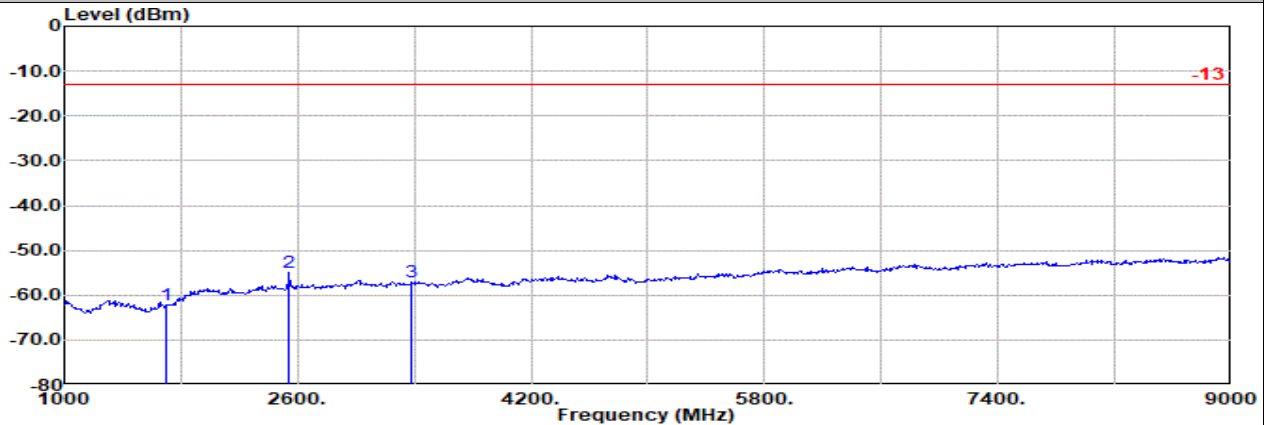

Site : 03CH07-HY
Condition: -13 3m HF_ANT_00075962 Horizontal
Mode : WCDMA 850 Ch4233

1	2	3	MHz	Level dBm	Detector	Ant Amp\Cb Filter		EIRPCF	Readin g	Limit dBm	Margin dB	Pol	
						Factor	1						dB
			1696.00	-62.14	RMS	28.76	-27.08	0.31	-95.23	31.10	-13.00	-49.14	Horizontal
			2544.00	-54.80	RMS	32.54	-25.51	0.20	-95.23	33.20	-13.00	-41.80	Horizontal
			3384.00	-57.04	RMS	33.04	-24.01	0.15	-95.23	29.01	-13.00	-44.04	Horizontal

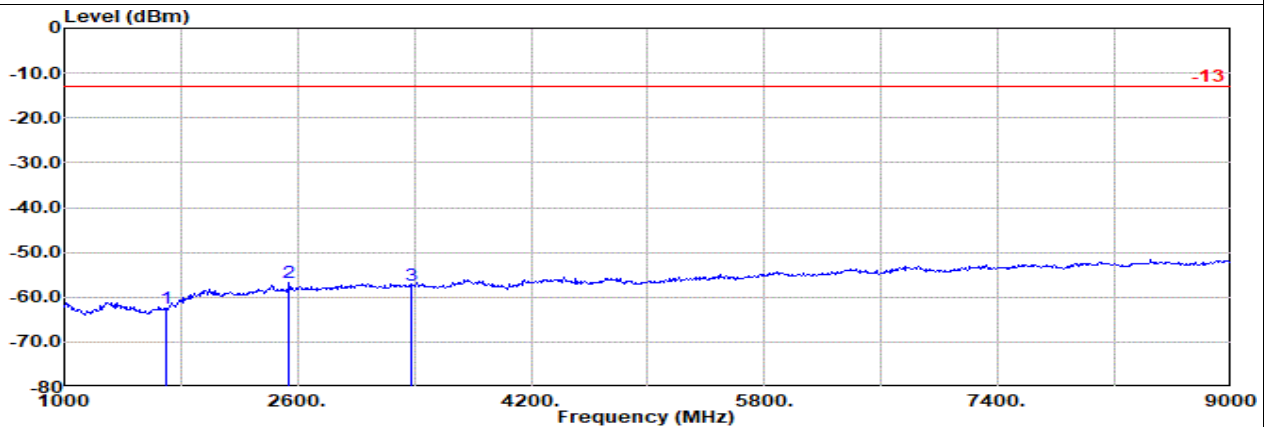

Site : 03CH07-HY
Condition: -13 3m HF_ANT_00075962 Vertical
Mode : WCDMA 850 Ch4233

1	2	3	MHz	Level dBm	Detector	Ant Amp\Cb Filter		EIRPCF	Readin g	Limit dBm	Margin dB	Pol	
						Factor	1						dB
			1696.00	-62.38	RMS	28.76	-27.08	0.31	-95.23	30.86	-13.00	-49.38	Vertical
			2544.00	-56.86	RMS	32.54	-25.51	0.20	-95.23	31.14	-13.00	-43.86	Vertical
			3384.00	-57.32	RMS	33.04	-24.01	0.15	-95.23	28.73	-13.00	-44.32	Vertical



ANT1

Part 24E Mode 1

WCDMA B2 Ch9262

L

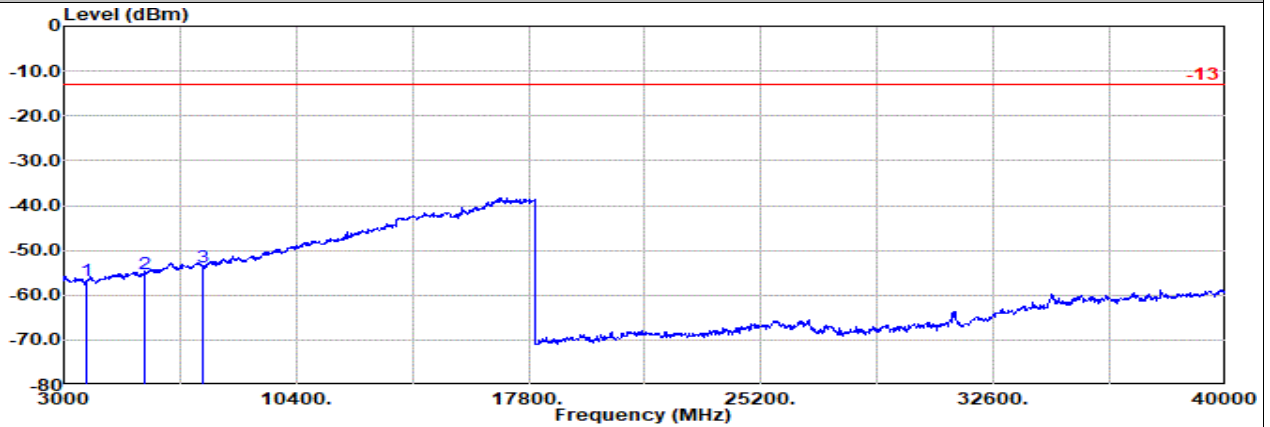

Site : 03CH07-HY
 Condition: -13 3m HF_ANT_00075962 Horizontal
 Mode : WCDMA 1900 CH9262

1	2	3	Freq Level		Detector	Ant Amp\Cb Filter		Factor	Filter		EIRPCF	Readin g	Limit		Margin	Pol
			MHz	dBm		dB/m	dB		dB	dB			dBuV	dBm		
1	3705.00	-56.71	RMS	33.11	-23.53	0.67	-95.23	28.27	-13.00	-43.71	Horizontal					
2	5550.00	-55.33	RMS	34.70	-21.16	0.51	-95.23	25.85	-13.00	-42.33	Horizontal					
3	7410.00	-53.76	RMS	35.68	-19.38	0.31	-95.23	24.86	-13.00	-40.76	Horizontal					

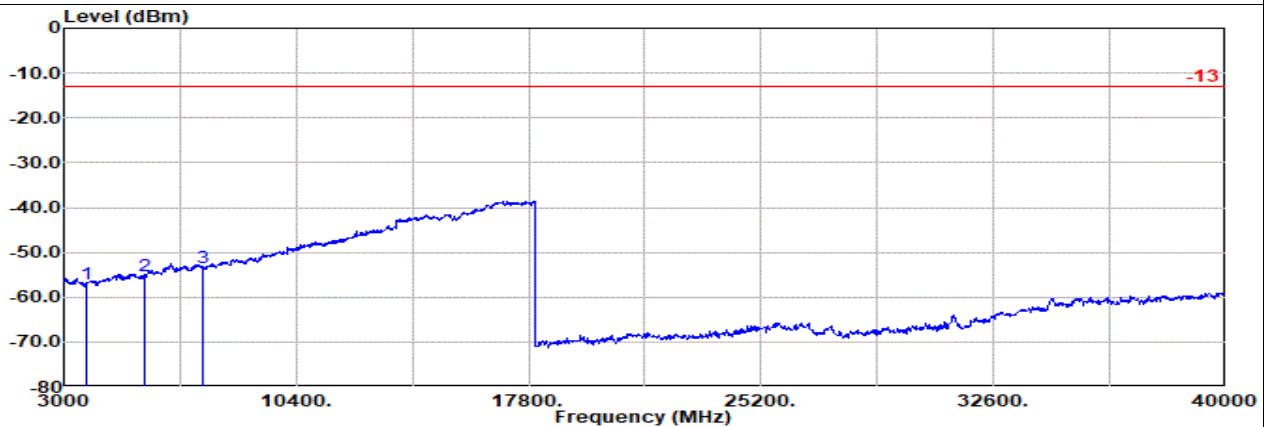

Site : 03CH07-HY
 Condition: -13 3m HF_ANT_00075962 Vertical
 Mode : WCDMA 1900 CH9262

1	2	3	Freq Level		Detector	Ant Amp\Cb Filter		Factor	Filter		EIRPCF	Readin g	Limit		Margin	Pol
			MHz	dBm		dB/m	dB		dB	dB			dBuV	dBm		
1	3705.00	-57.04	RMS	33.11	-23.53	0.67	-95.23	27.94	-13.00	-44.04	Vertical					
2	5550.00	-55.23	RMS	34.70	-21.16	0.51	-95.23	25.95	-13.00	-42.23	Vertical					
3	7410.00	-53.51	RMS	35.68	-19.38	0.31	-95.23	25.11	-13.00	-40.51	Vertical					



ANT1

Part 24E Mode 1
WCDMA B2 Ch9400
M

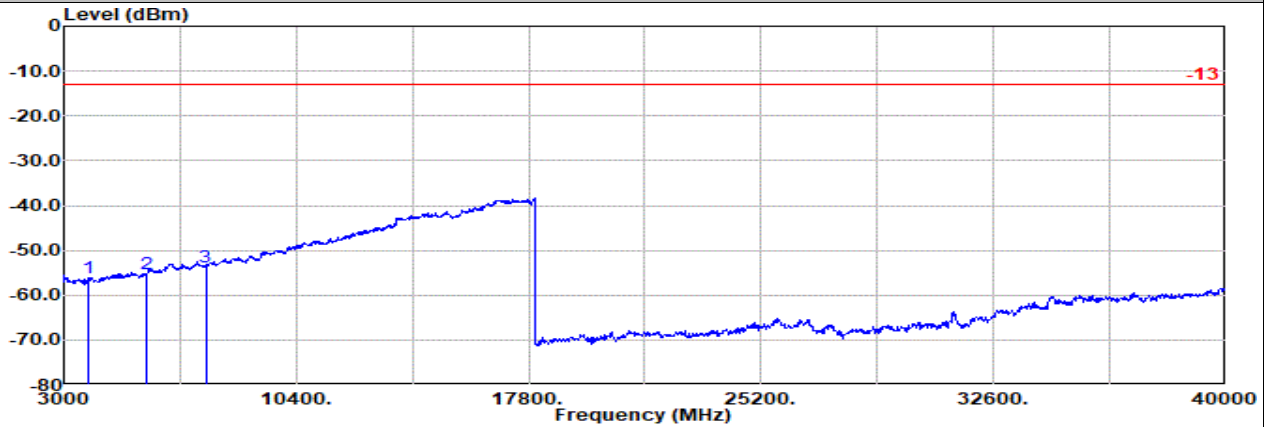

Site : 03CH07-HY
Condition: -13 3m HF_ANT_00075962 Horizontal
Mode : WCDMA 1900 CH9400

1	2	3	Freq Level		Detector	Ant Amp\Cb Filter		Factor	Filter		EIRPCF	Readin g	Limit		Margin	Pol
			MHz	dBm		dB/m	dB		dB	dB			dBuV	dBm		
1	3765.00	-56.08	RMS	33.26	-23.43	0.67	-95.23	28.65	-13.00	-43.08	Horizontal					
2	5640.00	-55.11	RMS	34.94	-21.07	0.47	-95.23	25.78	-13.00	-42.11	Horizontal					
3	7515.00	-53.70	RMS	35.56	-19.34	0.33	-95.23	24.98	-13.00	-40.70	Horizontal					

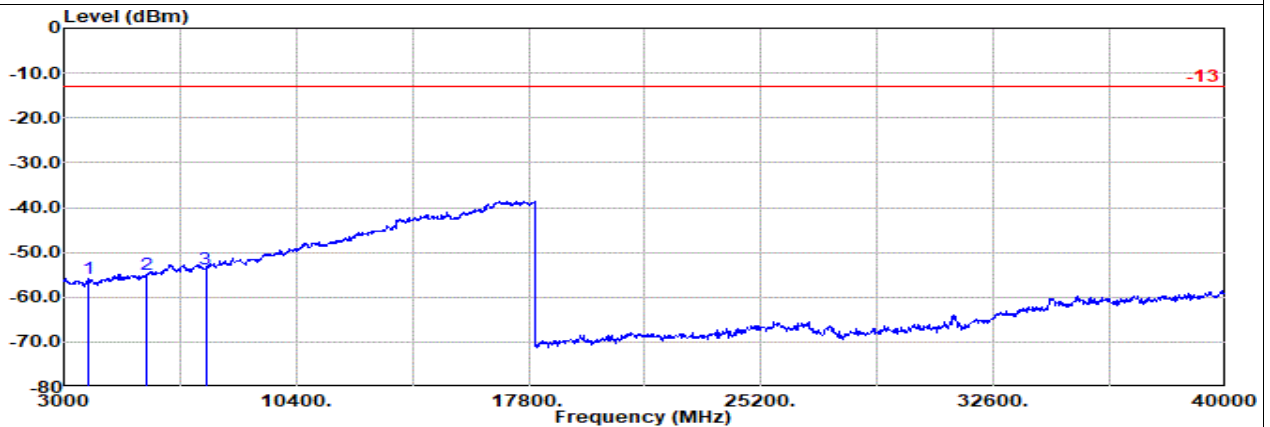

Site : 03CH07-HY
Condition: -13 3m HF_ANT_00075962 Vertical
Mode : WCDMA 1900 CH9400

1	2	3	Freq Level		Detector	Ant Amp\Cb Filter		Factor	Filter		EIRPCF	Readin g	Limit		Margin	Pol
			MHz	dBm		dB/m	dB		dB	dB			dBuV	dBm		
1	3765.00	-55.79	RMS	33.26	-23.43	0.67	-95.23	28.94	-13.00	-42.79	Vertical					
2	5640.00	-54.91	RMS	34.94	-21.07	0.47	-95.23	25.98	-13.00	-41.91	Vertical					
3	7515.00	-53.60	RMS	35.56	-19.34	0.33	-95.23	25.08	-13.00	-40.60	Vertical					



ANT1

Part 24E Mode 1
WCDMA B2 Ch9538
H

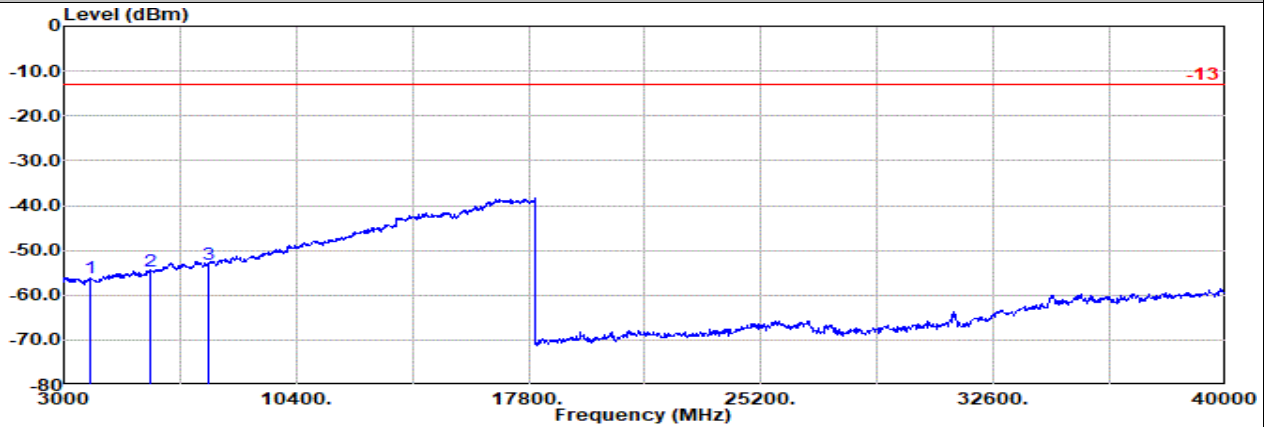

Site : 03CH07-HY
Condition: -13 3m HF_ANT_00075962 Horizontal
Mode : WCDMA 1900 CH9538

	Freq	Level	Detector	Ant Amp\Cb Filter		EIRPCF	Readin	Limit		Margin	Pol
				Factor	1			g			
	MHz	dBm		dB/m	dB	dB	dBuV	dBm	dB		
1	3815.00	-56.21	RMS	33.43	-23.34	0.67	-95.23	28.26	-13.00	-43.21	Horizontal
2	5723.00	-54.61	RMS	35.20	-20.97	0.36	-95.23	26.03	-13.00	-41.61	Horizontal
3	7630.00	-53.14	RMS	35.90	-19.28	0.35	-95.23	25.12	-13.00	-40.14	Horizontal

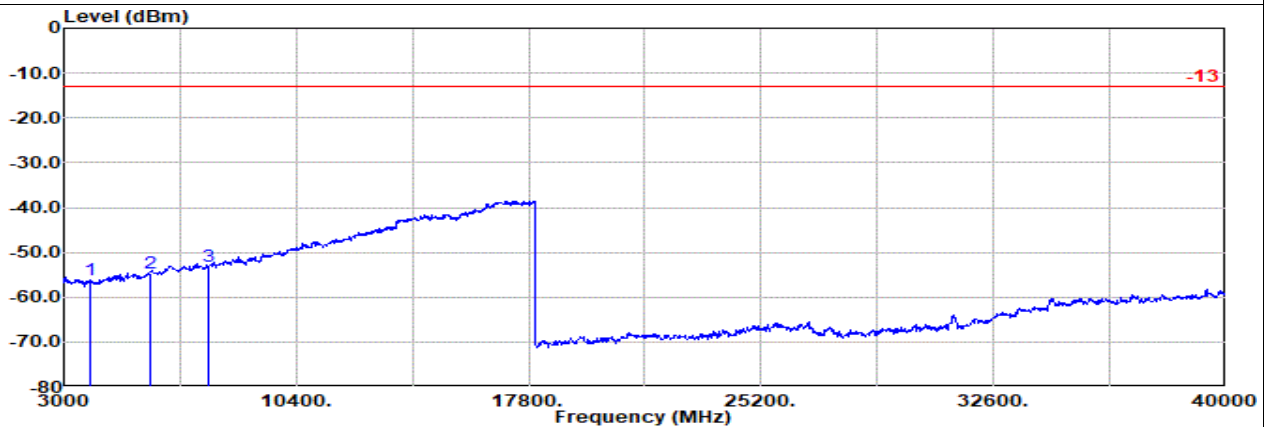

Site : 03CH07-HY
Condition: -13 3m HF_ANT_00075962 Vertical
Mode : WCDMA 1900 CH9538

	Freq	Level	Detector	Ant Amp\Cb Filter		EIRPCF	Readin	Limit		Margin	Pol
				Factor	1			g			
	MHz	dBm		dB/m	dB	dB	dBuV	dBm	dB		
1	3815.00	-56.15	RMS	33.43	-23.34	0.67	-95.23	28.32	-13.00	-43.15	Vertical
2	5723.00	-54.56	RMS	35.20	-20.97	0.36	-95.23	26.08	-13.00	-41.56	Vertical
3	7630.00	-53.11	RMS	35.90	-19.28	0.35	-95.23	25.15	-13.00	-40.11	Vertical



ANT1

Part 27L Mode 1
WCDMA B4 Ch1312
L

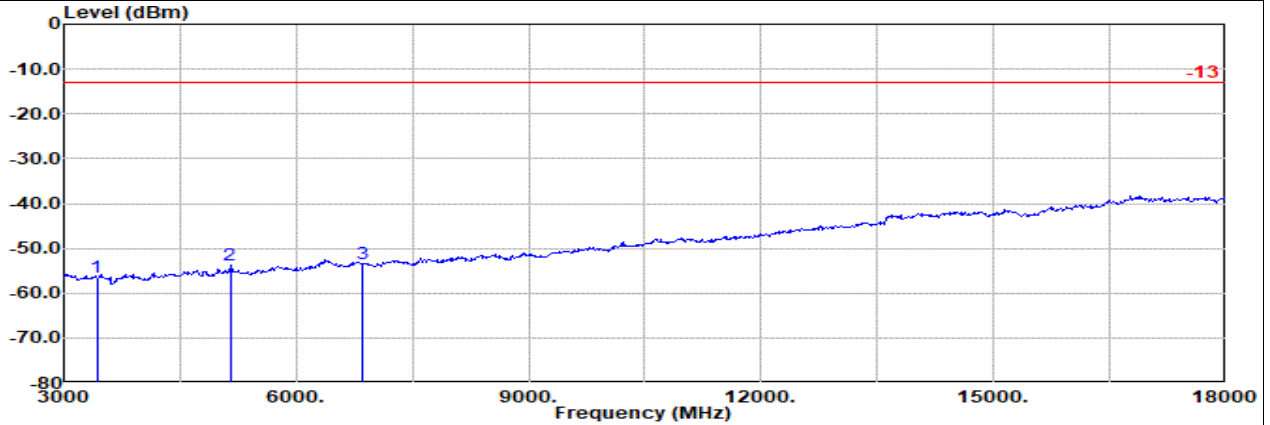

Site : 03CH07-HY
Condition: -13 3m HF_ANT_00075962 Horizontal
Mode : WCDMA 1700 CH1312

1	MHz	Level dBm	Detector	Ant Amp\Cb Filter		EIRPCF	Readin g	Limit dBm	Margin dB	Pol	
				Factor	1						dB
1	3425.00	-56.31	RMS	33.10	-23.94	0.80	-95.23	28.96	-13.00	-43.31	Horizontal
2	5145.00	-53.80	RMS	34.27	-21.56	0.43	-95.23	28.29	-13.00	-40.80	Horizontal
3	6850.00	-53.42	RMS	35.70	-19.95	0.62	-95.23	25.44	-13.00	-40.42	Horizontal

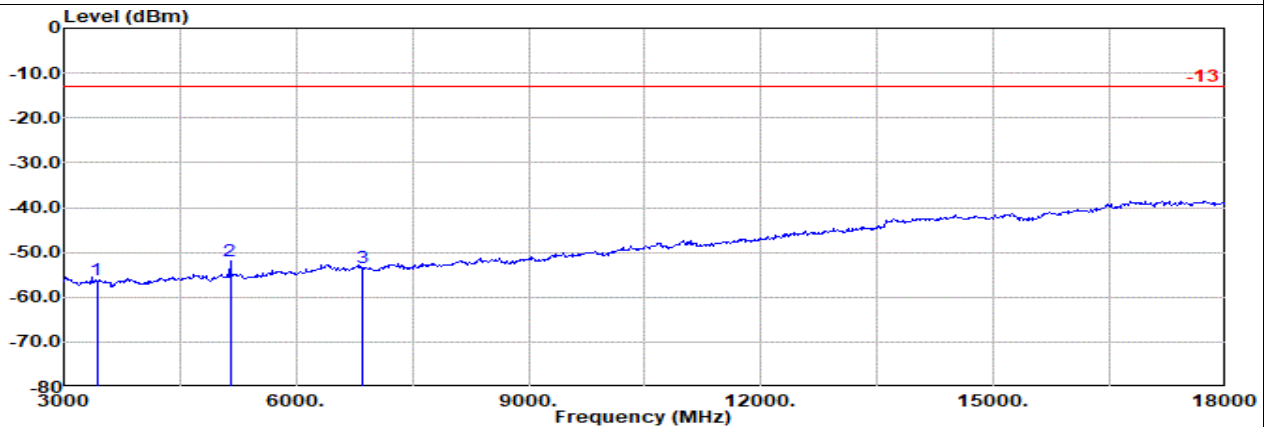

Site : 03CH07-HY
Condition: -13 3m HF_ANT_00075962 Vertical
Mode : WCDMA 1700 CH1312

1	MHz	Level dBm	Detector	Ant Amp\Cb Filter		EIRPCF	Readin g	Limit dBm	Margin dB	Pol	
				Factor	1						dB
1	3425.00	-56.14	RMS	33.10	-23.94	0.80	-95.23	29.13	-13.00	-43.14	Vertical
2	5145.00	-52.03	RMS	34.27	-21.56	0.43	-95.23	30.06	-13.00	-39.03	Vertical
3	6850.00	-53.33	RMS	35.70	-19.95	0.62	-95.23	25.53	-13.00	-40.33	Vertical



ANT1

Part 27L Mode 1
WCDMA B4 Ch1413
M

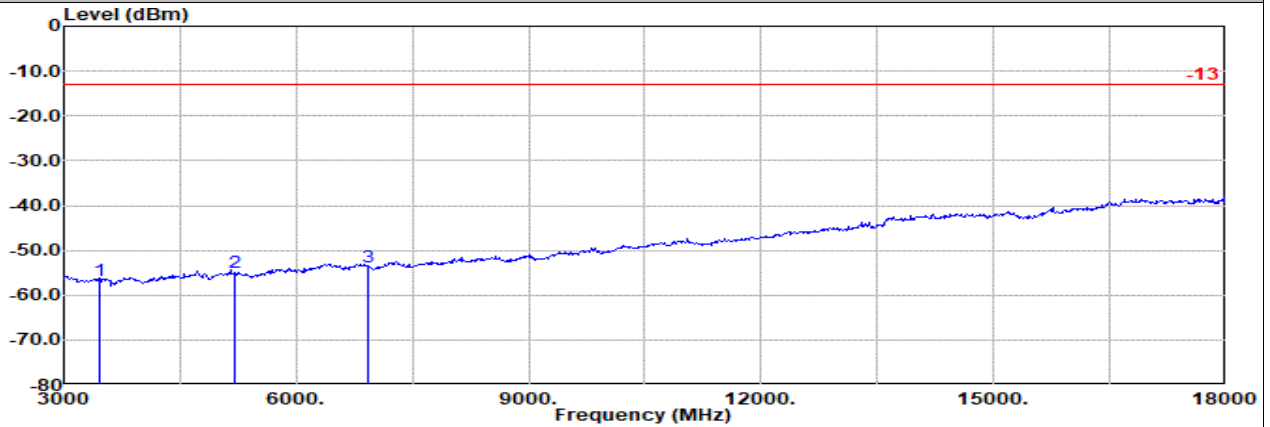

Site : 03CH07-HY
Condition: -13 3m HF_ANT_00075962 Horizontal
Mode : WCDMA 1700 CH1413

	Freq	Level	Detector	Ant Amp\Cb Filter		EIRPCF	Reading	Limit		Margin	Pol
				Factor	1			dBm	dB		
	MHz	dBm		dB/m	dB	dB	dBuV	dBm	dB		
1	3465.00	-56.62	RMS	33.01	-23.89	0.76	-95.23	28.73	-13.00	-43.62	Horizontal
2	5205.00	-55.02	RMS	34.52	-21.46	0.31	-95.23	26.84	-13.00	-42.02	Horizontal
3	6930.00	-53.72	RMS	35.76	-19.89	0.36	-95.23	25.28	-13.00	-40.72	Horizontal

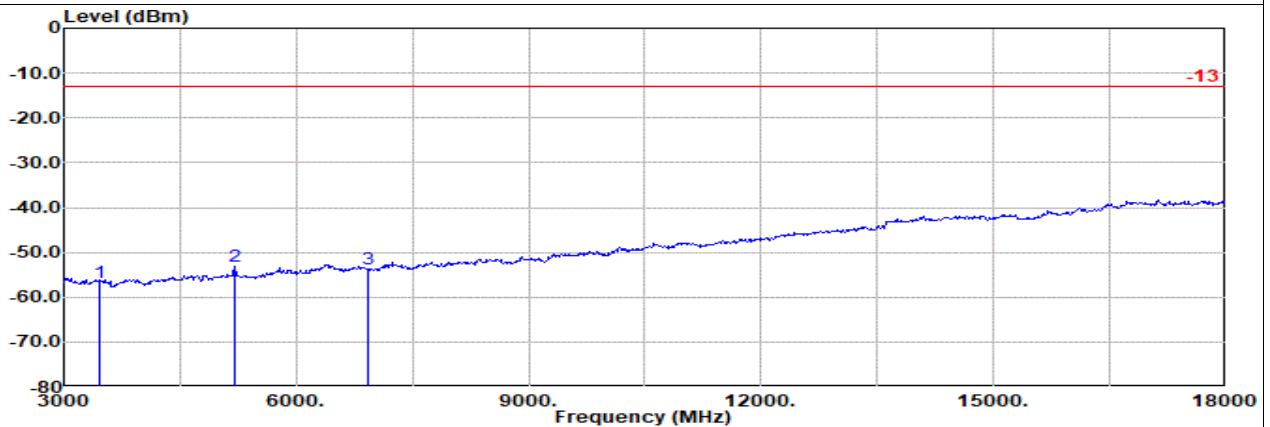

Site : 03CH07-HY
Condition: -13 3m HF_ANT_00075962 Vertical
Mode : WCDMA 1700 CH1413

	Freq	Level	Detector	Ant Amp\Cb Filter		EIRPCF	Reading	Limit		Margin	Pol
				Factor	1			dBm	dB		
	MHz	dBm		dB/m	dB	dB	dBuV	dBm	dB		
1	3465.00	-56.63	RMS	33.01	-23.89	0.76	-95.23	28.72	-13.00	-43.63	Vertical
2	5205.00	-53.19	RMS	34.52	-21.46	0.31	-95.23	28.67	-13.00	-40.19	Vertical
3	6930.00	-53.73	RMS	35.76	-19.89	0.36	-95.23	25.27	-13.00	-40.73	Vertical



ANT1

Part 27L Mode 1
WCDMA B4 Ch1513
H

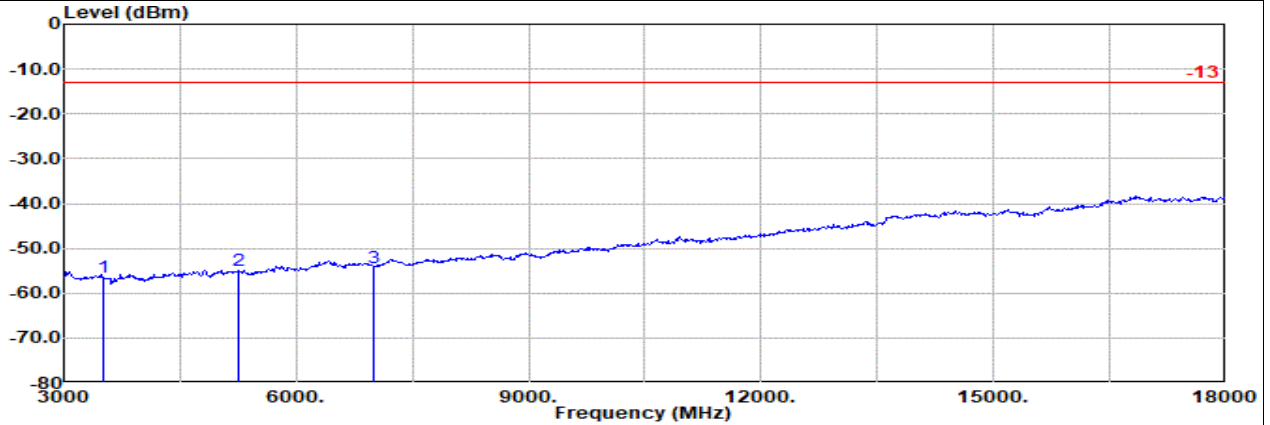

Site : 03CH07-HY
Condition: -13 3m HF_ANT_00075962 Horizontal
Mode : WCDMA 1700 CH1513

1	2	3	Freq Level		Detector	Ant Amp\Cb Filter		EIRPCF	Readin g	Limit	Margin Pol	
			MHz	dBm		Factor	1				dB	dB
1	3505.00	-56.55	RMS	32.78	-23.84	0.73	-95.23	29.01	-13.00	-43.55	Horizontal	
2	5258.00	-54.98	RMS	34.68	-21.42	0.35	-95.23	26.64	-13.00	-41.98	Horizontal	
3	7010.00	-54.28	RMS	35.68	-19.83	0.16	-95.23	24.94	-13.00	-41.28	Horizontal	

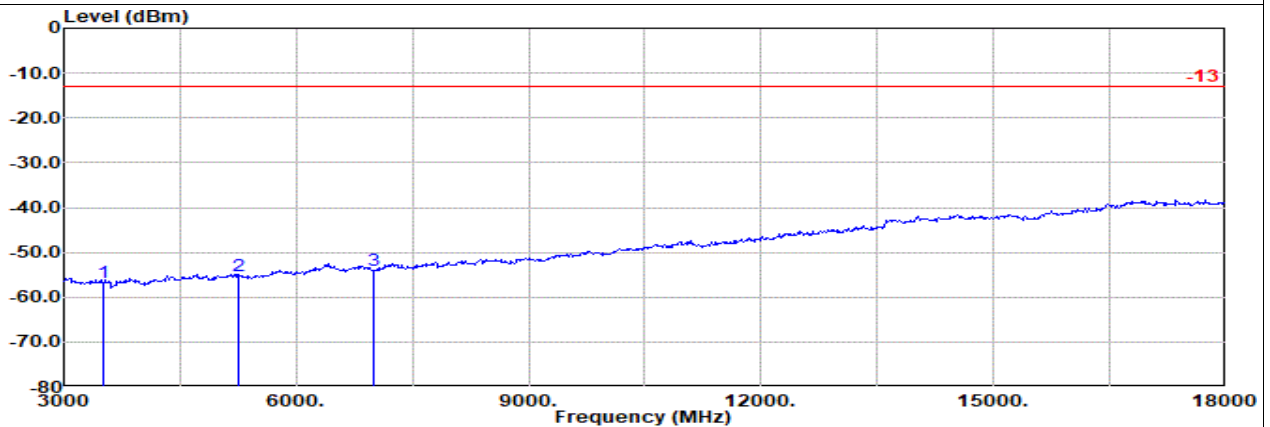

Site : 03CH07-HY
Condition: -13 3m HF_ANT_00075962 Vertical
Mode : WCDMA 1700 CH1513

1	2	3	Freq Level		Detector	Ant Amp\Cb Filter		EIRPCF	Readin g	Limit	Margin Pol	
			MHz	dBm		Factor	1				dB	dB
1	3505.00	-56.65	RMS	32.78	-23.84	0.73	-95.23	28.91	-13.00	-43.65	Vertical	
2	5258.00	-55.19	RMS	34.68	-21.42	0.35	-95.23	26.43	-13.00	-42.19	Vertical	
3	7010.00	-54.15	RMS	35.68	-19.83	0.16	-95.23	25.07	-13.00	-41.15	Vertical	



ANT2

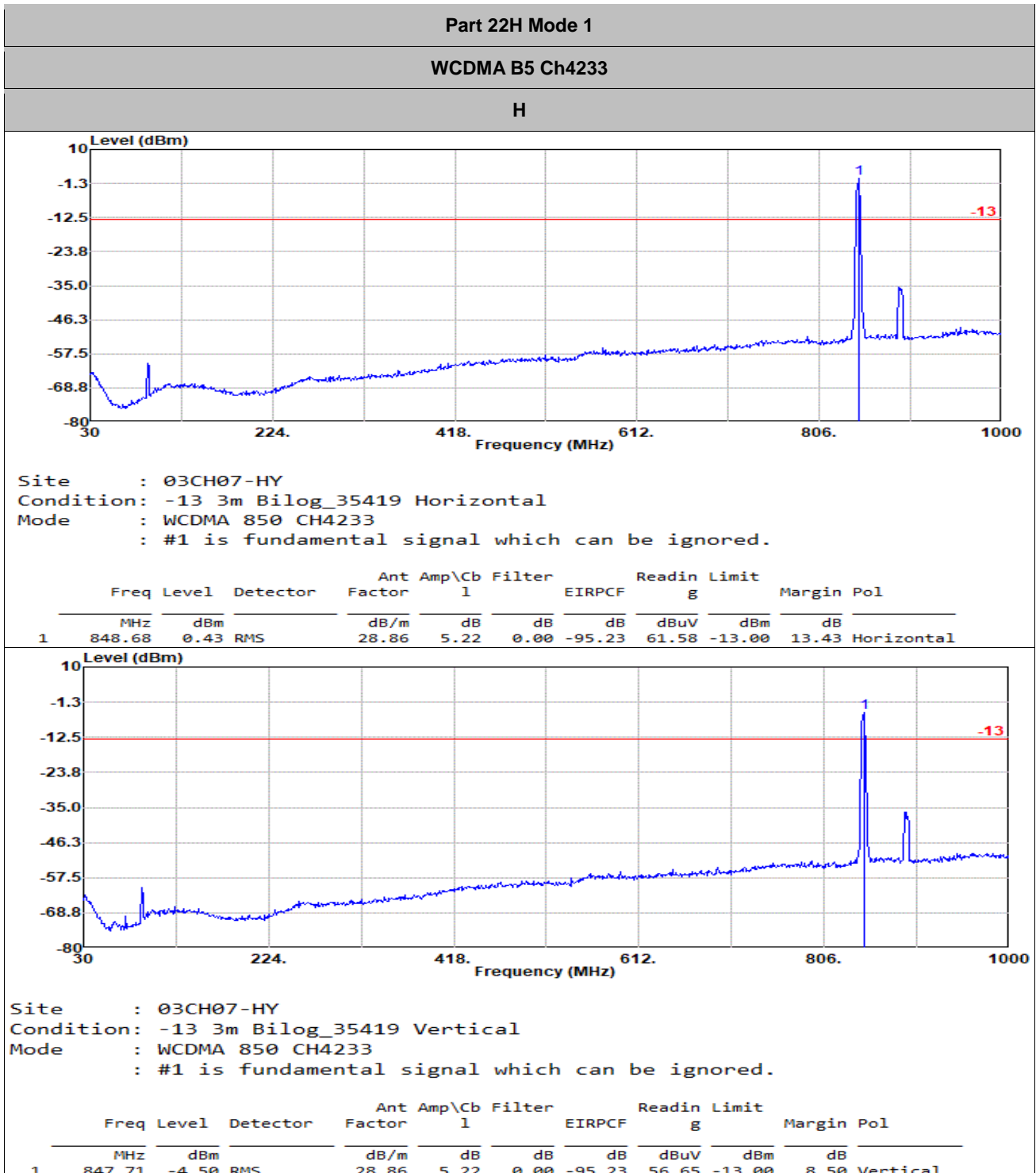

Remark: The over limit signal before #1 is fundamental signal which can be ignored.

————THE END————