



FCC RADIO TEST REPORT

FCC ID : A4RGR83Y
Equipment : Phone
Model Name : GR83Y
Applicant : Google LLC
1600 Amphitheatre Parkway,
Mountain View, California, 94043 USA
Standard : 47 CFR FCC Part 15.519

The product was received on Dec. 20, 2023, and testing was performed from Dec. 28, 2023 to Apr. 08, 2024. We, Sporton International Inc. Wensan Laboratory, would like to declare that the tested sample has been evaluated in accordance with the test procedures and has been in compliance with the applicable technical standards.

The test results in this report apply exclusively to the tested model / sample. Without written approval of Sporton International Inc. Wensan Laboratory, the test report shall not be reproduced except in full.

Approved by: Louis Wu

Sporton International Inc. Wensan Laboratory

No.58, Aly. 75, Ln. 564, Wenhua 3rd, Rd., Guishan Dist., Taoyuan City 333010, Taiwan (R.O.C.)



Table of Contents

History of this test report.....3

Summary of Test Result.....5

1 General Description6

1.1 Product Feature of Equipment Under Test6

1.2 Modification of EUT6

1.3 Type of EUT7

1.4 Testing Applied Standards7

1.5 Testing Location Information8

1.6 Measurement Uncertainty8

2 Test Configuration of EUT9

2.1 Test Mode.....9

2.2 The Worst Case Measurement Configuration10

2.3 Test Setup Diagram11

2.4 Support Unit used in test configuration and system11

3 Transmitter Test Result12

3.1 AC Power-line Conducted Emissions12

3.2 UWB bandwidth.....13

3.3 Technical requirements for hand held UWB systems25

3.4 Peak Power Measurement28

3.5 Radiated Emissions.....37

4 Test Equipment and Calibration Data90

Appendix A. Conducted Emissions Test Results

Appendix B. Setup Photographs



History of this test report

Report No.	Version	Description	Issue Date
FR3N2325Q	01	Initial issue of report	Apr. 23, 2024
FR3N2325Q	02	Revise Section 1.1, Section 1.4, Section 3.2 and Section 3.5 This report is an updated version, replacing the report issued on Apr. 23, 2024.	May 08, 2024
FR3N2325Q	03	Revise Section 3.5.7, Section 3.5.8 and Section 3.5.11 This report is an updated version, replacing the report issued on May 08, 2024.	May 10, 2024
FR3N2325Q	04	Revise Section 3.5.7, Section 3.5.8 and Section 3.5.11 This report is an updated version, replacing the report issued on May 10, 2024.	May 11, 2024
FR3N2325Q	05	Revise Section 3.5.9 ~ 3.5.10 This report is an updated version, replacing the report issued on May 11, 2024.	May 13, 2024
FR3N2325Q	06	Revise Report No. This report is an updated version, replacing the report issued on May 13, 2024.	Jul. 11, 2024



--	--	--	--



Summary of Test Result

Report Clause	Ref Std. Clause	Test Items	Result (PASS/FAIL)	Remark
1.2	15.203	Antenna Requirement	PASS	15.203
3.1	15.207	AC Power-line Conducted Emissions	PASS	15.207
3.2	15.503	UWB Bandwidth	PASS	≥ 500MHz
3.3	15.519(a)(1)	Technical requirements for Hand Held UWB systems	PASS	15.519(a)(1)
3.4	15.519(e)	Peak Power Measurement	PASS	≤ 0 dBm/50MHz
3.5	15.519(c) /15.519(d)	Radiated Emissions	PASS	UWB Emissions: 15.519(c) GPS Emissions: 15.519(d) Digital Emissions: 15.209

Conformity Assessment Condition:

1. The test results (PASS/FAIL) with all measurement uncertainty excluded are presented against the regulation limits or in accordance with the requirements stipulated by the applicant/manufacturer who shall bear all the risks of non-compliance that may potentially occur if measurement uncertainty is taken into account.
2. The measurement uncertainty please refer to each test result in the section "Measurement Uncertainty".

Disclaimer:

The product specifications of the EUT presented in the test report that may affect the test assessments are declared by the manufacturer who shall take full responsibility for the authenticity.

Reviewed by: William Chen
Report Producer: Michelle Chen



1 General Description

1.1 Product Feature of Equipment Under Test

Product Feature	
General Specs GSM/WCDMA/LTE/5G NR, Bluetooth, BLE, BLE channel sounding, Thread, Wi-Fi 802.11be, UWB, NFC, WPT, NTN and GNSS	
Antenna Type UWB: <Ranging Antenna>: IFA Antenna <Common AoA Antenna>: Patch Antenna	

Antenna information		
6489.6 MHz	Peak Gain (dBi)	<Ranging Antenna>: -4.8 <Common AoA Antenna>: 1.2
7987.2 MHz	Peak Gain (dBi)	<Ranging Antenna>: -2.6 <Common AoA Antenna>: 2.2

Remark:

1. The above EUT's information was declared by manufacturer. Please refer to Disclaimer in report summary.
2. The antenna gain is not used for all the test.
3. Mode 1 (CH5), mode 15 (CH5), mode 12 (CH9) and mode 14 (CH9) are selected as the worst mode to be reported for radiated spurious emission test.

EUT Information List	
S/N	Performed Test Item
3B131FDAP00078	Equivalent Isotropic Radiated Power
	Radiated Spurious Emission
3B131FDAP0007M	Conducted Emission

1.2 Modification of EUT

No modifications are made to the EUT during all test items.



1.3 Type of EUT

Operational Condition	
EUT Power Type	AC mains: AC voltage 120 V
Type of EUT	
<input checked="" type="checkbox"/>	Stand-alone
<input type="checkbox"/>	Combined (EUT where the radio part is fully integrated within another device) Combined Equipment - Brand Name / Model No.: ...
<input type="checkbox"/>	Plug-in radio (EUT intended for a variety of host systems) Host System - Brand Name / Model No.: ...
<input type="checkbox"/>	Other:

1.4 Testing Applied Standards

According to the specifications of the manufacturer, the EUT must comply with the requirements of the following standards:

- ◆ 47 CFR FCC Part 15
- ◆ ANSI C63.10-2013
- ◆ FCC KDB 414788 D01 Radiated Test Site v01r01
- ◆ FCC KDB 393764 D01 UWB FAQ v02r01.

Remark: The TAF code is not including all the FCC KDB listed without accreditation.

1.5 Testing Location Information

Test Site	Sporton International Inc. Wensan Laboratory		
Test Site Location	No.58, Aly. 75, Ln. 564, Wenhua 3rd, Rd., Guishan Dist., Taoyuan City 333010, Taiwan (R.O.C.) TEL: +886-3-327-0868 FAX: +886-3-327-0855		
Test Site No.	Sporton Site No.		
	03CH22-HY, CO07-HY		

Note: The test site complies with ANSI C63.4 2014 requirement.
FCC designation No.: TW3786

Test Condition	Test Site No.	Test Engineer	Test Environment	Test Date
Conduction	CO07-HY	Louis Chung	22.7 ~ 24.6 °C 54.2~ 59.7 %	Mar. 25, 2024
Radiated	03CH22-HY	Bank Lin, Lu Wen-Kai and Karl Hou	22.5~23.5 °C 61.7~65.3 %	Dec. 28, 2023~ Apr. 08, 2024

1.6 Measurement Uncertainty

ISO/IEC 17025 requires that an estimate of the measurement uncertainties associated with the emissions test results be included in the report. The measurement uncertainties given below are based on a 95% confidence level (based on a coverage factor (k=2))

Test Items	Uncertainty	Remark
AC Conduction (150kHz ~ 30MHz)	3.44 dB	Confidence levels of 95%
Radiated Emission (30MHz ~ 1000MHz)	6.5 dB	Confidence levels of 95%
Radiated Emission (1GHz ~ 6GHz)	4.5 dB	Confidence levels of 95%
Radiated Emission (6GHz ~ 18GHz)	4.5 dB	Confidence levels of 95%
Radiated Emission (18GHz ~ 40GHz)	5.4 dB	Confidence levels of 95%





2 Test Configuration of EUT

2.1 Test Mode

Test Configuration					
Mode	Antenna	Channel	Modulation	Config ID	Payload Length (bytes)
1	Ranging Antenna	5	BPRF	0	125
2	Ranging Antenna	9	BPRF	0	125
3	Common AoA	5	BPRF	0	125
4	Common AoA	9	BPRF	0	125
5	Ranging Antenna	5	BPRF	1	125
6	Ranging Antenna	9	BPRF	1	125
7	Common AoA	5	BPRF	1	125
8	Common AoA	9	BPRF	1	125
9	Ranging Antenna	5	BPRF	2	NA
10	Ranging Antenna	9	BPRF	2	NA
11	Common AoA	5	BPRF	2	NA
12	Common AoA	9	BPRF	2	NA
13	Ranging Antenna	5	HPRF	3	150
14	Ranging Antenna	9	HPRF	3	150
15	Common AoA	5	HPRF	3	150
16	Common AoA	9	HPRF	3	150
17	Ranging Antenna	5	HPRF	4	150
18	Ranging Antenna	9	HPRF	4	150
19	Common AoA	5	HPRF	4	150
20	Common AoA	9	HPRF	4	150
21	Ranging Antenna	5	HPRF	5	N/A
22	Ranging Antenna	9	HPRF	5	N/A
23	Common AoA	5	HPRF	5	N/A
24	Common AoA	9	HPRF	5	N/A
25	Ranging Antenna	5	HPRF	6	N/A
26	Ranging Antenna	9	HPRF	6	N/A
27	Common AoA	5	HPRF	6	N/A
28	Common AoA	9	HPRF	6	N/A

2.2 The Worst Case Measurement Configuration

The Worst Case Mode for Following Conformance Tests	
Tests Item	AC power-line conducted emissions
Condition	AC power-line conducted measurement for line and neutral Test Voltage: 120Vac / 60Hz
Operating Mode	CTX
1	Adapter Mode
Remark: 1. Please refer to 15.207 which states, "Measurements to demonstrate compliance with the conducted limits are not required for devices employ Battery for operation and which do not operate from the AC power lines or contain provisions for operation while connected to the AC power lines". 2. For Conducted Emission Test Cases, the tests were performed with Adapter 1 and USB Cable 2.	

The Worst Case Mode for Following Conformance Tests			
Tests Item	UWB Bandwidth, Peak Power Measurement, Radiated Emissions		
Test Condition	Radiated measurement		
Operating Mode	CTX		
1	Adapter Mode		
Mode 1 configuration was tested and found to be the worst case and measured during the test.			
Operating Mode > 1GHz	CTX		
Orthogonal Planes of EUT	X Plane	Y Plane	Z Plane
			
All Ranging Antenna CH05 Test Mode	V		
All Ranging Antenna CH09 Test Mode			V
All Common AoA CH05 Test Mode		V	
All Common AoA CH09 Test Mode			V
Remark: 1. The measured emission level of the EUT was maximized by rotating the EUT on a turntable, adjusting the orientation of the EUT and EUT antenna in three orthogonal axis (X: flat, Y: portrait, Z: landscape) and accessory (Adapter or Earphone), and adjusting the measurement antenna orientation, following C63.10 exploratory test procedures and find as worst plane, and recorded in this report. 2. For Radiated Test Cases, the tests were performed with AC Adapter 1 and USB Cable 2.			

2.3 Test Setup Diagram

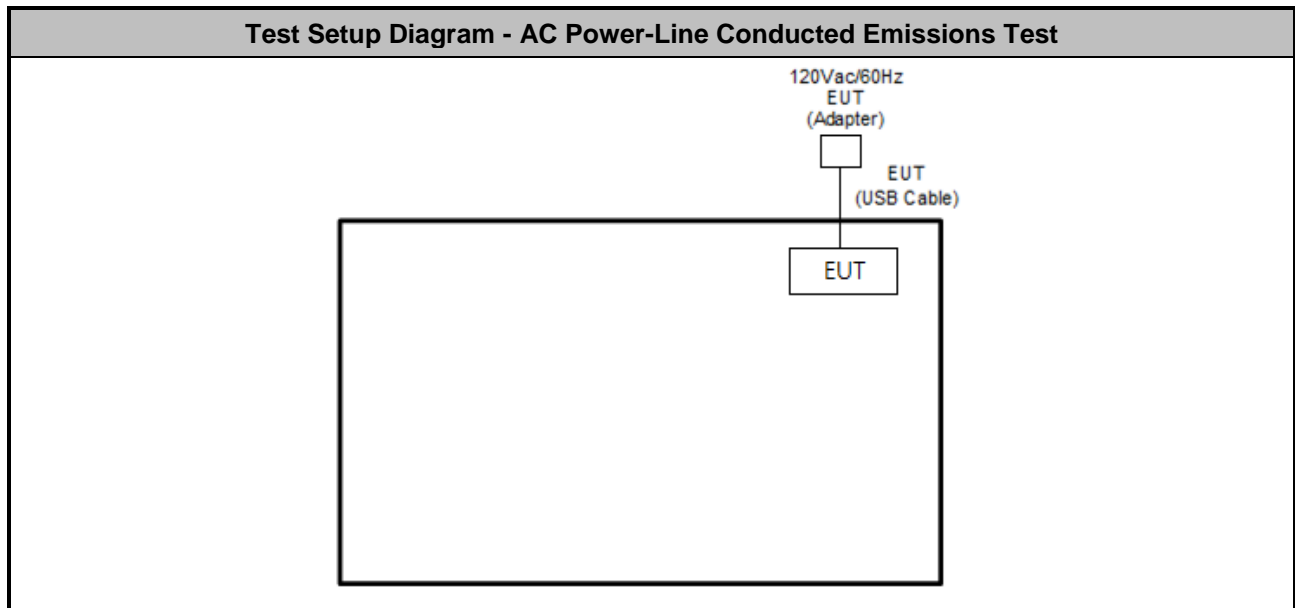
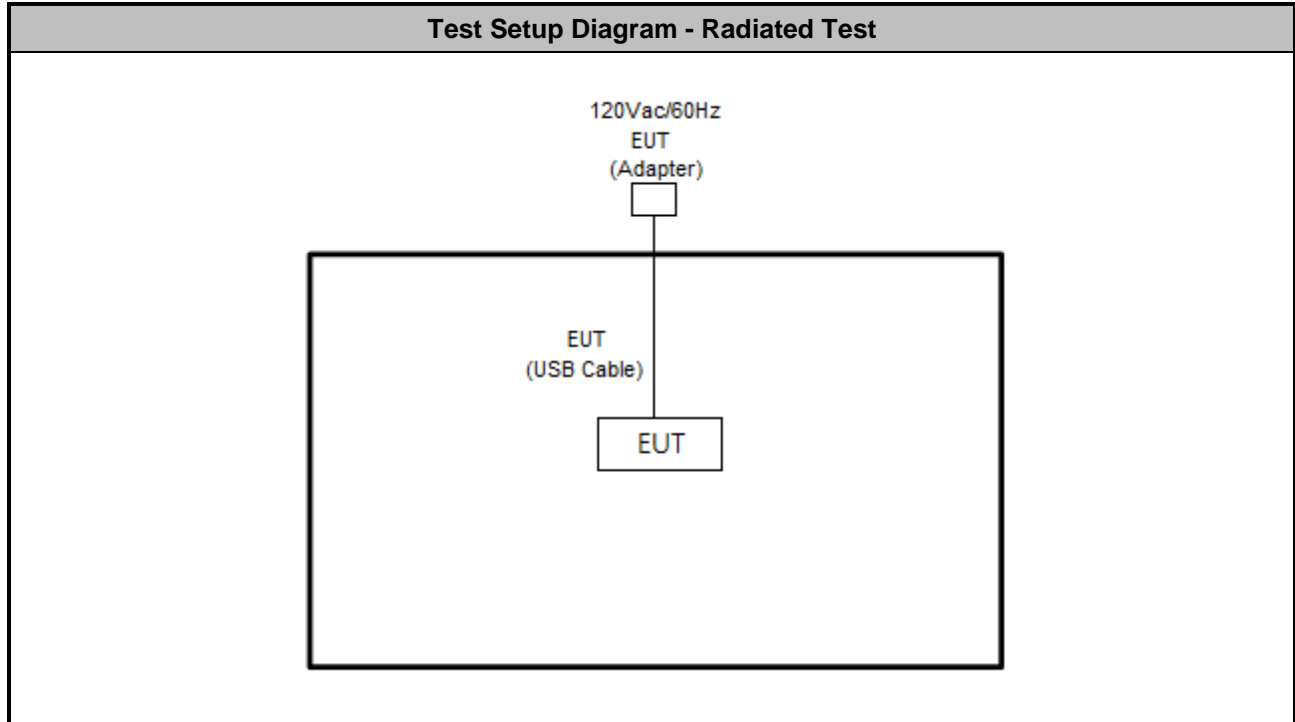

2.4 Support Unit used in test configuration and system

Item	Equipment	Brand Name	Model Name	FCC ID	Data Cable	Power Cord
1.	Notebook	Lenovo	SL11B03776	FCC DoC	N/A	AC I/P: Unshielded, 1.2 m DC O/P: Shielded, 1.8 m
2.	Spectrum Analyzer	FSW43	101456	N/A	N/A	N/A

3 Transmitter Test Result

3.1 AC Power-line Conducted Emissions

3.1.1 AC Power-line Conducted Emissions Limit

AC Power-line Conducted Emissions Limit		
Frequency Emission (MHz)	Quasi-Peak	Average
0.15-0.5	66 - 56 *	56 - 46 *
0.5-5	56	46
5-30	60	50

Note 1: * Decreases with the logarithm of the frequency.

3.1.2 Measuring Instruments

Refer a test equipment and calibration data table in this test report.

3.1.3 Test Procedures

Test Method
■ Refer as ANSI C63.10-2013, clause 6.2 for AC power-line conducted emissions.

3.1.4 Test Setup

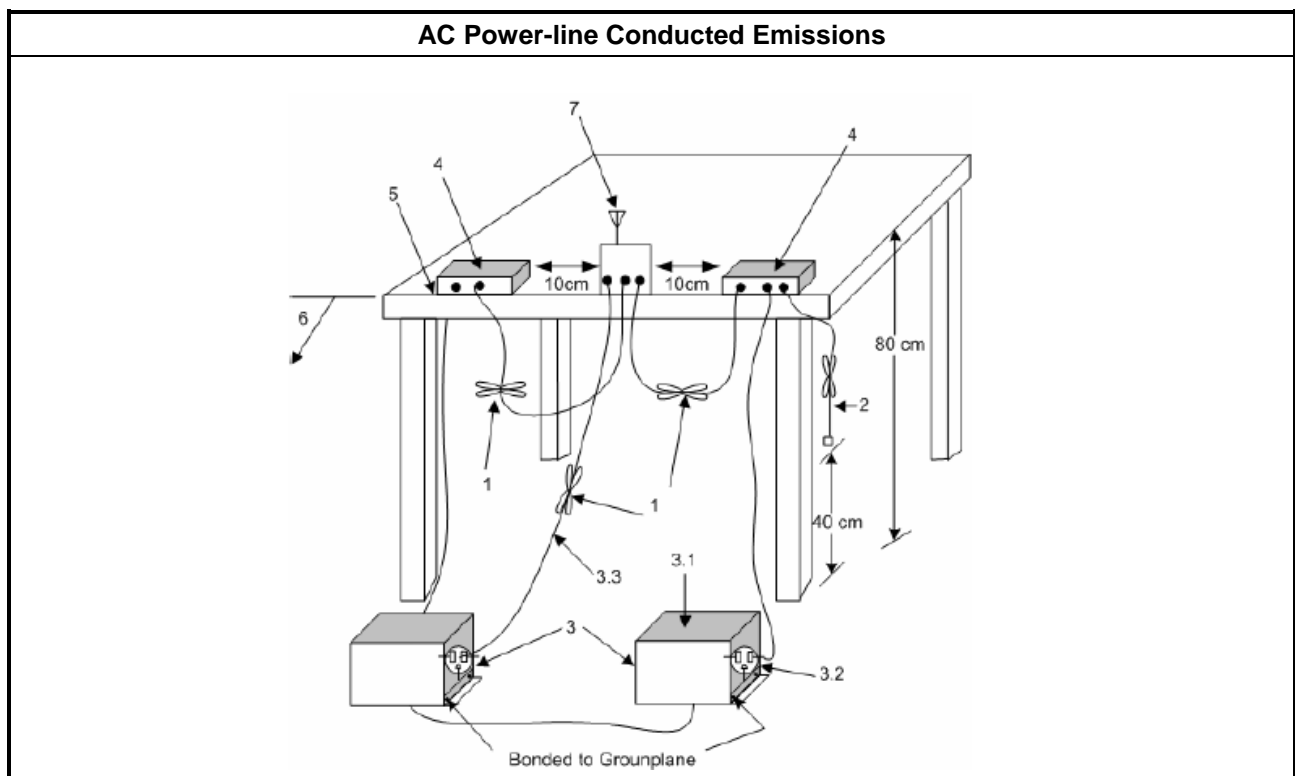

3.1.5 Test Result

Please refer to Appendix A.

3.2 UWB bandwidth

3.2.1 UWB bandwidth Limit

UWB bandwidth Limit
UWB bandwidth \geq 500 MHz or Fractional bandwidth \geq 0.2; Fractional bandwidth = $2(f_H - f_L) / (f_H + f_L)$

3.2.2 Measuring Instruments

Refer a test equipment and calibration data table in this test report.

3.2.3 Test Procedures

Test Method
<ul style="list-style-type: none"> ■ For the UWB bandwidth shall be measured using one of the options below:
<ul style="list-style-type: none"> ■ Refer as ANSI C63.10, clause 6.9.2 and clause 10.1 for UWB bandwidth testing.

3.2.4 Test Setup

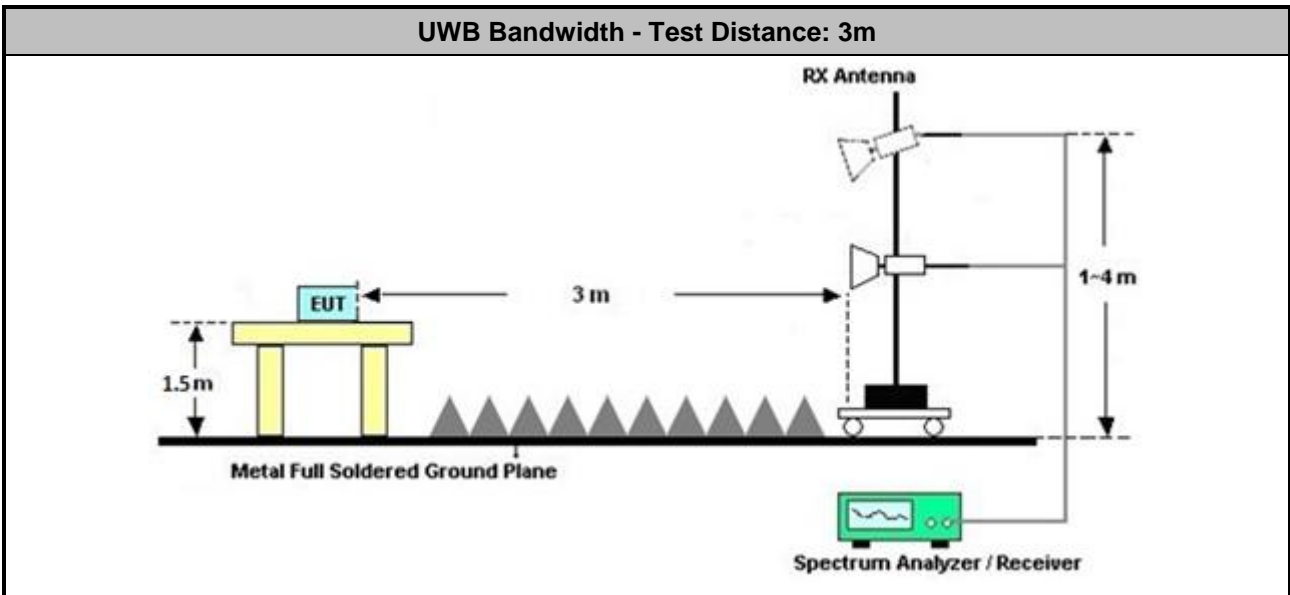

3.2.5 Test Result of UWB Bandwidth

Test mode	F _L (MHz)	F _H (MHz)	UWB Bandwidth (MHz)	Bandwidth limit (MHz)	Result	PoI [H/V]
1	6222	6760	538	≥ 500	Pass	H
2	7714	8259	545	≥ 500	Pass	H
3	6221	6760	539	≥ 500	Pass	V
4	7717	8258	559	≥ 500	Pass	V
5	6223	6762	539	≥ 500	Pass	H
6	7728	8238	510	≥ 500	Pass	V
7	6222	6759	537	≥ 500	Pass	V
8	7717	8257	540	≥ 500	Pass	V
9	6222	6760	538	≥ 500	Pass	H
10	7713	8256	543	≥ 500	Pass	V
11	6223	6759	536	≥ 500	Pass	V
12	7717	8224	507	≥ 500	Pass	V
13	6250	6760	510	≥ 500	Pass	H
14	7716	8254	538	≥ 500	Pass	V
15	6221	6760	539	≥ 500	Pass	V
16	7717	8257	540	≥ 500	Pass	V
17	6254	6757	503	≥ 500	Pass	H
18	7702	8206	504	≥ 500	Pass	H
19	6221	6761	540	≥ 500	Pass	V
20	7719	8255	536	≥ 500	Pass	V
21	6220	6758	538	≥ 500	Pass	H
22	7717	8256	539	≥ 500	Pass	H
23	6221	6759	538	≥ 500	Pass	V
24	7717	8257	540	≥ 500	Pass	V
25	6223	6758	535	≥ 500	Pass	H
26	7712	8224	512	≥ 500	Pass	H
27	6221	6763	542	≥ 500	Pass	V
28	7715	8255	540	≥ 500	Pass	V



UWB Bandwidth																																																																																																					
Mode 1	Mode 2																																																																																																				
<p>Date: 2024-02-22</p> <p>Site Condition : 03CH22-HY : 3m LEZC04A1BEN_230712 HORIZONTAL : RBW:1000.000KHz VBW:3000.000KHz SWT:3.000sec</p> <p>Detector : Peak Project : 3N2325 Channel : CH5 Modulation : BPRF UWB Frame : 0 HPRF Set # : NA Payload Length : 125 Power Offset Length : 43 Post Power Offset : 50 Sweep point (pts) : 1001 UWB Bandwidth (MHz) : 538</p> <table border="1"> <thead> <tr> <th>Freq</th> <th>Level</th> <th>Over</th> <th>Limit</th> <th>ReadAntenna</th> <th>Cable</th> <th>Preamp</th> <th>A/Pos</th> <th>T/Pos</th> <th>Remark</th> </tr> <tr> <th>MHz</th> <th>dBuV/m</th> <th>dB</th> <th>dBuV/m</th> <th>Level</th> <th>Loss</th> <th>Factor</th> <th>dB</th> <th>cm</th> <th>deg</th> </tr> </thead> <tbody> <tr> <td>1</td> <td>6222.00</td> <td>61.40</td> <td>-----</td> <td>46.88</td> <td>35.22</td> <td>14.12</td> <td>34.82</td> <td>---</td> <td>Peak</td> </tr> <tr> <td>2</td> <td>6725.00</td> <td>70.21</td> <td>-----</td> <td>56.26</td> <td>36.65</td> <td>14.72</td> <td>35.32</td> <td>---</td> <td>Peak</td> </tr> <tr> <td>3</td> <td>6768.00</td> <td>68.43</td> <td>-----</td> <td>44.34</td> <td>36.78</td> <td>14.75</td> <td>35.36</td> <td>---</td> <td>Peak</td> </tr> </tbody> </table>	Freq	Level	Over	Limit	ReadAntenna	Cable	Preamp	A/Pos	T/Pos	Remark	MHz	dBuV/m	dB	dBuV/m	Level	Loss	Factor	dB	cm	deg	1	6222.00	61.40	-----	46.88	35.22	14.12	34.82	---	Peak	2	6725.00	70.21	-----	56.26	36.65	14.72	35.32	---	Peak	3	6768.00	68.43	-----	44.34	36.78	14.75	35.36	---	Peak	<p>Date: 2023-12-30</p> <p>Site Condition : 03CH22-HY : 3m LEZC04A1BEN_230712 HORIZONTAL : RBW:1000.000KHz VBW:3000.000KHz SWT:3.000sec</p> <p>Detector : Peak Project : 3N2325 Channel : CH5 Modulation : BPRF UWB Frame : 0 HPRF Set # : NA Payload Length : 125 Power Offset Length : 38 Post Power Offset : 50 Sweep point (pts) : 1001 UWB Bandwidth (MHz) : 545</p> <table border="1"> <thead> <tr> <th>Freq</th> <th>Level</th> <th>Over</th> <th>Limit</th> <th>ReadAntenna</th> <th>Cable</th> <th>Preamp</th> <th>A/Pos</th> <th>T/Pos</th> <th>Remark</th> </tr> <tr> <th>MHz</th> <th>dBuV/m</th> <th>dB</th> <th>dBuV/m</th> <th>Level</th> <th>Loss</th> <th>Factor</th> <th>dB</th> <th>cm</th> <th>deg</th> </tr> </thead> <tbody> <tr> <td>1</td> <td>7714.00</td> <td>59.79</td> <td>-----</td> <td>43.16</td> <td>37.00</td> <td>15.87</td> <td>36.24</td> <td>---</td> <td>Peak</td> </tr> <tr> <td>2</td> <td>7832.00</td> <td>69.62</td> <td>-----</td> <td>52.89</td> <td>37.18</td> <td>16.81</td> <td>36.38</td> <td>---</td> <td>Peak</td> </tr> <tr> <td>3</td> <td>8259.00</td> <td>59.83</td> <td>-----</td> <td>43.16</td> <td>37.28</td> <td>16.33</td> <td>36.86</td> <td>---</td> <td>Peak</td> </tr> </tbody> </table>	Freq	Level	Over	Limit	ReadAntenna	Cable	Preamp	A/Pos	T/Pos	Remark	MHz	dBuV/m	dB	dBuV/m	Level	Loss	Factor	dB	cm	deg	1	7714.00	59.79	-----	43.16	37.00	15.87	36.24	---	Peak	2	7832.00	69.62	-----	52.89	37.18	16.81	36.38	---	Peak	3	8259.00	59.83	-----	43.16	37.28	16.33	36.86	---	Peak
Freq	Level	Over	Limit	ReadAntenna	Cable	Preamp	A/Pos	T/Pos	Remark																																																																																												
MHz	dBuV/m	dB	dBuV/m	Level	Loss	Factor	dB	cm	deg																																																																																												
1	6222.00	61.40	-----	46.88	35.22	14.12	34.82	---	Peak																																																																																												
2	6725.00	70.21	-----	56.26	36.65	14.72	35.32	---	Peak																																																																																												
3	6768.00	68.43	-----	44.34	36.78	14.75	35.36	---	Peak																																																																																												
Freq	Level	Over	Limit	ReadAntenna	Cable	Preamp	A/Pos	T/Pos	Remark																																																																																												
MHz	dBuV/m	dB	dBuV/m	Level	Loss	Factor	dB	cm	deg																																																																																												
1	7714.00	59.79	-----	43.16	37.00	15.87	36.24	---	Peak																																																																																												
2	7832.00	69.62	-----	52.89	37.18	16.81	36.38	---	Peak																																																																																												
3	8259.00	59.83	-----	43.16	37.28	16.33	36.86	---	Peak																																																																																												
<p>Date: 2024-01-03</p> <p>Site Condition : 03CH22-HY : 3m LEZC04A1BEN_230712 HORIZONTAL : RBW:1000.000KHz VBW:3000.000KHz SWT:3.000sec</p> <p>Detector : Peak Project : 3N2325 Channel : CH5 Modulation : BPRF UWB Frame : 0 HPRF Set # : NA Payload Length : 125 Power Offset Length : 60 Post Power Offset : 51 Sweep point (pts) : 1001 UWB Bandwidth (MHz) : 539</p> <table border="1"> <thead> <tr> <th>Freq</th> <th>Level</th> <th>Over</th> <th>Limit</th> <th>ReadAntenna</th> <th>Cable</th> <th>Preamp</th> <th>A/Pos</th> <th>T/Pos</th> <th>Remark</th> </tr> <tr> <th>MHz</th> <th>dBuV/m</th> <th>dB</th> <th>dBuV/m</th> <th>Level</th> <th>Loss</th> <th>Factor</th> <th>dB</th> <th>cm</th> <th>deg</th> </tr> </thead> <tbody> <tr> <td>1</td> <td>6221.00</td> <td>67.85</td> <td>-----</td> <td>52.54</td> <td>35.21</td> <td>14.12</td> <td>34.82</td> <td>100</td> <td>360 Peak</td> </tr> <tr> <td>2</td> <td>6725.00</td> <td>76.95</td> <td>-----</td> <td>60.90</td> <td>36.65</td> <td>14.72</td> <td>35.32</td> <td>100</td> <td>360 Peak</td> </tr> <tr> <td>3</td> <td>6768.00</td> <td>67.38</td> <td>-----</td> <td>51.21</td> <td>36.78</td> <td>14.75</td> <td>35.36</td> <td>100</td> <td>360 Peak</td> </tr> </tbody> </table>	Freq	Level	Over	Limit	ReadAntenna	Cable	Preamp	A/Pos	T/Pos	Remark	MHz	dBuV/m	dB	dBuV/m	Level	Loss	Factor	dB	cm	deg	1	6221.00	67.85	-----	52.54	35.21	14.12	34.82	100	360 Peak	2	6725.00	76.95	-----	60.90	36.65	14.72	35.32	100	360 Peak	3	6768.00	67.38	-----	51.21	36.78	14.75	35.36	100	360 Peak																																																			
Freq	Level	Over	Limit	ReadAntenna	Cable	Preamp	A/Pos	T/Pos	Remark																																																																																												
MHz	dBuV/m	dB	dBuV/m	Level	Loss	Factor	dB	cm	deg																																																																																												
1	6221.00	67.85	-----	52.54	35.21	14.12	34.82	100	360 Peak																																																																																												
2	6725.00	76.95	-----	60.90	36.65	14.72	35.32	100	360 Peak																																																																																												
3	6768.00	67.38	-----	51.21	36.78	14.75	35.36	100	360 Peak																																																																																												

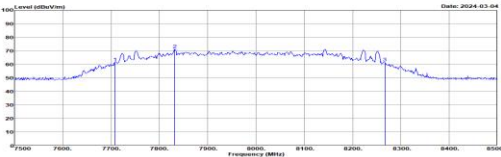
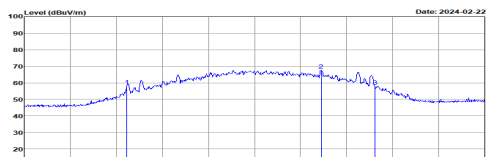
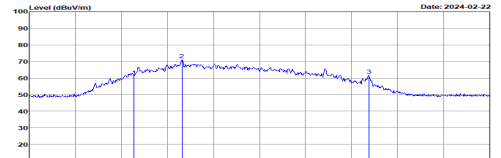

UWB Bandwidth																																																																																																											
Mode 4	Mode 5																																																																																																										
 <p>Date: 2024-03-04</p> <p>Site Condition : 03CH22-HY 3m LE2C04A18EN_230712 VERTICAL RBW:1000.000kHz VBW:3000.000kHz SWT:3.000sec</p> <p>Detector : Peak Project : 3N2325 Channel : CH9 Modulation : BPRF UWB Frame : 1 HIPRF Set # : NA Payload Length : 125 Power Offset : 43 Post Power Offset : 50 Sweep point (pts) : 1001 UWB Bandwidth (MHz) : 599</p> <table border="1"> <thead> <tr> <th>Freq</th> <th>Level</th> <th>Over</th> <th>Limit</th> <th>ReadAntenna</th> <th>Cable</th> <th>Preamp</th> <th>A/Pos</th> <th>T/Pos</th> <th>Remark</th> </tr> <tr> <th>MHz</th> <th>dBuV/m</th> <th>dB</th> <th>dBuV/m</th> <th>dBuV</th> <th>dB/m</th> <th>dB</th> <th>dB</th> <th>cm</th> <th>deg</th> </tr> </thead> <tbody> <tr> <td>1 7788.00</td> <td>61.34</td> <td>-----</td> <td>-----</td> <td>44.71</td> <td>37.00</td> <td>15.86</td> <td>36.23</td> <td>---</td> <td>---</td> <td>Peak</td> </tr> <tr> <td>2 7832.00</td> <td>71.33</td> <td>-----</td> <td>-----</td> <td>54.48</td> <td>37.10</td> <td>16.01</td> <td>36.38</td> <td>---</td> <td>---</td> <td>Peak</td> </tr> <tr> <td>3 8267.00</td> <td>61.22</td> <td>-----</td> <td>-----</td> <td>44.55</td> <td>37.00</td> <td>16.38</td> <td>36.87</td> <td>---</td> <td>---</td> <td>Peak</td> </tr> </tbody> </table>	Freq	Level	Over	Limit	ReadAntenna	Cable	Preamp	A/Pos	T/Pos	Remark	MHz	dBuV/m	dB	dBuV/m	dBuV	dB/m	dB	dB	cm	deg	1 7788.00	61.34	-----	-----	44.71	37.00	15.86	36.23	---	---	Peak	2 7832.00	71.33	-----	-----	54.48	37.10	16.01	36.38	---	---	Peak	3 8267.00	61.22	-----	-----	44.55	37.00	16.38	36.87	---	---	Peak	 <p>Date: 2024-02-22</p> <p>Site Condition : 03CH22-HY 3m LE2C04A18EN_230712 HORIZONTAL RBW:1000.000kHz VBW:3000.000kHz SWT:3.000sec</p> <p>Detector : Peak Project : 3N2325 Channel : CH5 Modulation : BPRF UWB Frame : 1 HIPRF Set # : NA Payload Length : 125 Power Offset : 40 Post Power Offset : 50 Sweep point (pts) : 1001 UWB Bandwidth (MHz) : 539</p> <table border="1"> <thead> <tr> <th>Freq</th> <th>Level</th> <th>Over</th> <th>Limit</th> <th>ReadAntenna</th> <th>Cable</th> <th>Preamp</th> <th>A/Pos</th> <th>T/Pos</th> <th>Remark</th> </tr> <tr> <th>MHz</th> <th>dBuV/m</th> <th>dB</th> <th>dBuV/m</th> <th>dBuV</th> <th>dB/m</th> <th>dB</th> <th>dB</th> <th>cm</th> <th>deg</th> </tr> </thead> <tbody> <tr> <td>1 6223.00</td> <td>58.21</td> <td>-----</td> <td>-----</td> <td>43.68</td> <td>35.23</td> <td>14.12</td> <td>34.82</td> <td>---</td> <td>---</td> <td>Peak</td> </tr> <tr> <td>2 6645.00</td> <td>67.81</td> <td>-----</td> <td>-----</td> <td>51.89</td> <td>36.50</td> <td>14.65</td> <td>35.23</td> <td>---</td> <td>---</td> <td>Peak</td> </tr> <tr> <td>3 6762.00</td> <td>58.01</td> <td>-----</td> <td>-----</td> <td>41.91</td> <td>36.70</td> <td>14.76</td> <td>35.36</td> <td>---</td> <td>---</td> <td>Peak</td> </tr> </tbody> </table>	Freq	Level	Over	Limit	ReadAntenna	Cable	Preamp	A/Pos	T/Pos	Remark	MHz	dBuV/m	dB	dBuV/m	dBuV	dB/m	dB	dB	cm	deg	1 6223.00	58.21	-----	-----	43.68	35.23	14.12	34.82	---	---	Peak	2 6645.00	67.81	-----	-----	51.89	36.50	14.65	35.23	---	---	Peak	3 6762.00	58.01	-----	-----	41.91	36.70	14.76	35.36	---	---	Peak
Freq	Level	Over	Limit	ReadAntenna	Cable	Preamp	A/Pos	T/Pos	Remark																																																																																																		
MHz	dBuV/m	dB	dBuV/m	dBuV	dB/m	dB	dB	cm	deg																																																																																																		
1 7788.00	61.34	-----	-----	44.71	37.00	15.86	36.23	---	---	Peak																																																																																																	
2 7832.00	71.33	-----	-----	54.48	37.10	16.01	36.38	---	---	Peak																																																																																																	
3 8267.00	61.22	-----	-----	44.55	37.00	16.38	36.87	---	---	Peak																																																																																																	
Freq	Level	Over	Limit	ReadAntenna	Cable	Preamp	A/Pos	T/Pos	Remark																																																																																																		
MHz	dBuV/m	dB	dBuV/m	dBuV	dB/m	dB	dB	cm	deg																																																																																																		
1 6223.00	58.21	-----	-----	43.68	35.23	14.12	34.82	---	---	Peak																																																																																																	
2 6645.00	67.81	-----	-----	51.89	36.50	14.65	35.23	---	---	Peak																																																																																																	
3 6762.00	58.01	-----	-----	41.91	36.70	14.76	35.36	---	---	Peak																																																																																																	
 <p>Date: 2024-02-22</p> <p>Site Condition : 03CH22-HY 3m LE2C04A18EN_230712 VERTICAL RBW:1000.000kHz VBW:3000.000kHz SWT:3.000sec</p> <p>Detector : Peak Project : 3N2325 Channel : CH9 Modulation : BPRF UWB Frame : 1 HIPRF Set # : NA Payload Length : 125 Power Offset : 43 Post Power Offset : 50 Sweep point (pts) : 1001 UWB Bandwidth (MHz) : 510</p> <table border="1"> <thead> <tr> <th>Freq</th> <th>Level</th> <th>Over</th> <th>Limit</th> <th>ReadAntenna</th> <th>Cable</th> <th>Preamp</th> <th>A/Pos</th> <th>T/Pos</th> <th>Remark</th> </tr> <tr> <th>MHz</th> <th>dBuV/m</th> <th>dB</th> <th>dBuV/m</th> <th>dBuV</th> <th>dB/m</th> <th>dB</th> <th>dB</th> <th>cm</th> <th>deg</th> </tr> </thead> <tbody> <tr> <td>1 7728.00</td> <td>61.10</td> <td>-----</td> <td>-----</td> <td>44.46</td> <td>37.00</td> <td>15.89</td> <td>36.25</td> <td>---</td> <td>---</td> <td>Peak</td> </tr> <tr> <td>2 7832.00</td> <td>71.05</td> <td>-----</td> <td>-----</td> <td>54.32</td> <td>37.10</td> <td>16.01</td> <td>36.38</td> <td>---</td> <td>---</td> <td>Peak</td> </tr> <tr> <td>3 8238.00</td> <td>61.45</td> <td>-----</td> <td>-----</td> <td>44.81</td> <td>37.18</td> <td>16.30</td> <td>36.84</td> <td>---</td> <td>---</td> <td>Peak</td> </tr> </tbody> </table>	Freq	Level	Over	Limit	ReadAntenna	Cable	Preamp	A/Pos	T/Pos	Remark	MHz	dBuV/m	dB	dBuV/m	dBuV	dB/m	dB	dB	cm	deg	1 7728.00	61.10	-----	-----	44.46	37.00	15.89	36.25	---	---	Peak	2 7832.00	71.05	-----	-----	54.32	37.10	16.01	36.38	---	---	Peak	3 8238.00	61.45	-----	-----	44.81	37.18	16.30	36.84	---	---	Peak																																																						
Freq	Level	Over	Limit	ReadAntenna	Cable	Preamp	A/Pos	T/Pos	Remark																																																																																																		
MHz	dBuV/m	dB	dBuV/m	dBuV	dB/m	dB	dB	cm	deg																																																																																																		
1 7728.00	61.10	-----	-----	44.46	37.00	15.89	36.25	---	---	Peak																																																																																																	
2 7832.00	71.05	-----	-----	54.32	37.10	16.01	36.38	---	---	Peak																																																																																																	
3 8238.00	61.45	-----	-----	44.81	37.18	16.30	36.84	---	---	Peak																																																																																																	

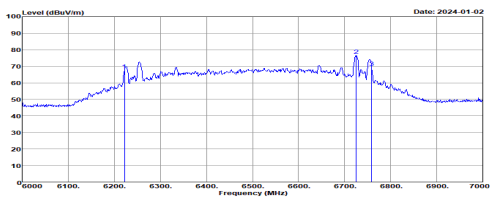
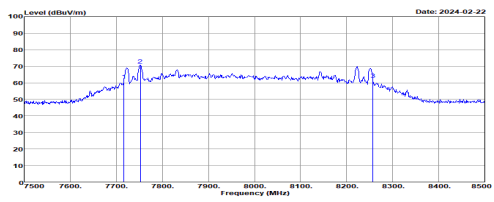
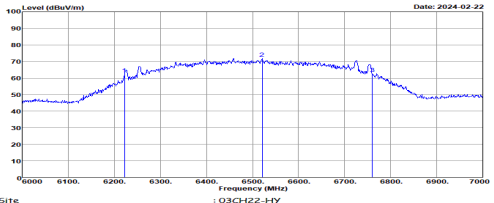

UWB Bandwidth																																																																																																															
Mode 7	Mode 8																																																																																																														
 <p>Date: 2024-01-02</p> <p>Site Condition: :03CH22-HY :3mLEZC04A1BEN_230712 VERTICAL :RBW:1000.000KHz VBW:3000.000KHz SWT:3.000sec</p> <p>Detector: :Peak Project: :3N2325 Channel: :CH9 Modulation: :BPRF UWB Frame: :1 HPRF Set #: :NA Payload Length: :125 Power Offset: :60 Post Power Offset: :50 Sweep point (pts): :1001 UWB Bandwidth (MHz): :537</p> <table border="1"> <thead> <tr> <th>Line</th> <th>Freq</th> <th>Level</th> <th>Over</th> <th>Limit</th> <th>ReadAntenna</th> <th>Cable</th> <th>Preamp</th> <th>A/Pos</th> <th>T/Pos</th> <th>Remark</th> </tr> <tr> <th></th> <th>MHz</th> <th>dBuV/m</th> <th>dB</th> <th>dBuV/m</th> <th>Level</th> <th>Factor</th> <th>Loss</th> <th>Factor</th> <th>cm</th> <th>deg</th> </tr> </thead> <tbody> <tr> <td>1</td> <td>6222.00</td> <td>67.63</td> <td>-----</td> <td>-----</td> <td>53.11</td> <td>35.22</td> <td>14.12</td> <td>34.82</td> <td>---</td> <td>Peak</td> </tr> <tr> <td>2</td> <td>6725.00</td> <td>76.38</td> <td>-----</td> <td>-----</td> <td>60.53</td> <td>36.65</td> <td>14.72</td> <td>35.32</td> <td>---</td> <td>Peak</td> </tr> <tr> <td>3</td> <td>6759.00</td> <td>69.39</td> <td>-----</td> <td>-----</td> <td>53.30</td> <td>36.70</td> <td>14.75</td> <td>35.36</td> <td>---</td> <td>Peak</td> </tr> </tbody> </table>	Line	Freq	Level	Over	Limit	ReadAntenna	Cable	Preamp	A/Pos	T/Pos	Remark		MHz	dBuV/m	dB	dBuV/m	Level	Factor	Loss	Factor	cm	deg	1	6222.00	67.63	-----	-----	53.11	35.22	14.12	34.82	---	Peak	2	6725.00	76.38	-----	-----	60.53	36.65	14.72	35.32	---	Peak	3	6759.00	69.39	-----	-----	53.30	36.70	14.75	35.36	---	Peak	 <p>Date: 2024-02-22</p> <p>Site Condition: :03CH22-HY :3mLEZC04A1BEN_230712 VERTICAL :RBW:1000.000KHz VBW:3000.000KHz SWT:3.000sec</p> <p>Detector: :Peak Project: :3N2325 Channel: :CH9 Modulation: :BPRF UWB Frame: :1 HPRF Set #: :NA Payload Length: :125 Power Offset: :63 Post Power Offset: :50 Sweep point (pts): :1001 UWB Bandwidth (MHz): :540</p> <table border="1"> <thead> <tr> <th>Line</th> <th>Freq</th> <th>Level</th> <th>Over</th> <th>Limit</th> <th>ReadAntenna</th> <th>Cable</th> <th>Preamp</th> <th>A/Pos</th> <th>T/Pos</th> <th>Remark</th> </tr> <tr> <th></th> <th>MHz</th> <th>dBuV/m</th> <th>dB</th> <th>dBuV/m</th> <th>Level</th> <th>Factor</th> <th>Loss</th> <th>Factor</th> <th>cm</th> <th>deg</th> </tr> </thead> <tbody> <tr> <td>1</td> <td>7717.00</td> <td>61.63</td> <td>-----</td> <td>-----</td> <td>44.99</td> <td>37.00</td> <td>15.88</td> <td>36.24</td> <td>---</td> <td>Peak</td> </tr> <tr> <td>2</td> <td>7752.00</td> <td>70.64</td> <td>-----</td> <td>-----</td> <td>54.20</td> <td>37.00</td> <td>15.92</td> <td>36.28</td> <td>---</td> <td>Peak</td> </tr> <tr> <td>3</td> <td>8257.00</td> <td>62.19</td> <td>-----</td> <td>-----</td> <td>45.52</td> <td>37.20</td> <td>16.33</td> <td>36.86</td> <td>---</td> <td>Peak</td> </tr> </tbody> </table>	Line	Freq	Level	Over	Limit	ReadAntenna	Cable	Preamp	A/Pos	T/Pos	Remark		MHz	dBuV/m	dB	dBuV/m	Level	Factor	Loss	Factor	cm	deg	1	7717.00	61.63	-----	-----	44.99	37.00	15.88	36.24	---	Peak	2	7752.00	70.64	-----	-----	54.20	37.00	15.92	36.28	---	Peak	3	8257.00	62.19	-----	-----	45.52	37.20	16.33	36.86	---	Peak
Line	Freq	Level	Over	Limit	ReadAntenna	Cable	Preamp	A/Pos	T/Pos	Remark																																																																																																					
	MHz	dBuV/m	dB	dBuV/m	Level	Factor	Loss	Factor	cm	deg																																																																																																					
1	6222.00	67.63	-----	-----	53.11	35.22	14.12	34.82	---	Peak																																																																																																					
2	6725.00	76.38	-----	-----	60.53	36.65	14.72	35.32	---	Peak																																																																																																					
3	6759.00	69.39	-----	-----	53.30	36.70	14.75	35.36	---	Peak																																																																																																					
Line	Freq	Level	Over	Limit	ReadAntenna	Cable	Preamp	A/Pos	T/Pos	Remark																																																																																																					
	MHz	dBuV/m	dB	dBuV/m	Level	Factor	Loss	Factor	cm	deg																																																																																																					
1	7717.00	61.63	-----	-----	44.99	37.00	15.88	36.24	---	Peak																																																																																																					
2	7752.00	70.64	-----	-----	54.20	37.00	15.92	36.28	---	Peak																																																																																																					
3	8257.00	62.19	-----	-----	45.52	37.20	16.33	36.86	---	Peak																																																																																																					
 <p>Date: 2024-02-22</p> <p>Site Condition: :03CH22-HY :3mLEZC04A1BEN_230712 HORIZONTAL :RBW:1000.000KHz VBW:3000.000KHz SWT:3.000sec</p> <p>Detector: :Peak Project: :3N2325 Channel: :CH9 Modulation: :BPRF UWB Frame: :3 HPRF Set #: :NA Payload Length: :31 Power Offset: :50 Post Power Offset: :1001 UWB Bandwidth (MHz): :538</p> <table border="1"> <thead> <tr> <th>Line</th> <th>Freq</th> <th>Level</th> <th>Over</th> <th>Limit</th> <th>ReadAntenna</th> <th>Cable</th> <th>Preamp</th> <th>A/Pos</th> <th>T/Pos</th> <th>Remark</th> </tr> <tr> <th></th> <th>MHz</th> <th>dBuV/m</th> <th>dB</th> <th>dBuV/m</th> <th>Level</th> <th>Factor</th> <th>Loss</th> <th>Factor</th> <th>cm</th> <th>deg</th> </tr> </thead> <tbody> <tr> <td>1</td> <td>6222.00</td> <td>62.37</td> <td>-----</td> <td>-----</td> <td>47.85</td> <td>35.22</td> <td>14.12</td> <td>34.82</td> <td>---</td> <td>Peak</td> </tr> <tr> <td>2</td> <td>6521.00</td> <td>71.93</td> <td>-----</td> <td>-----</td> <td>56.08</td> <td>36.44</td> <td>14.50</td> <td>35.09</td> <td>---</td> <td>Peak</td> </tr> <tr> <td>3</td> <td>6760.00</td> <td>62.76</td> <td>-----</td> <td>-----</td> <td>46.67</td> <td>36.70</td> <td>14.75</td> <td>35.36</td> <td>---</td> <td>Peak</td> </tr> </tbody> </table>	Line	Freq	Level	Over	Limit	ReadAntenna	Cable	Preamp	A/Pos	T/Pos	Remark		MHz	dBuV/m	dB	dBuV/m	Level	Factor	Loss	Factor	cm	deg	1	6222.00	62.37	-----	-----	47.85	35.22	14.12	34.82	---	Peak	2	6521.00	71.93	-----	-----	56.08	36.44	14.50	35.09	---	Peak	3	6760.00	62.76	-----	-----	46.67	36.70	14.75	35.36	---	Peak																																																								
Line	Freq	Level	Over	Limit	ReadAntenna	Cable	Preamp	A/Pos	T/Pos	Remark																																																																																																					
	MHz	dBuV/m	dB	dBuV/m	Level	Factor	Loss	Factor	cm	deg																																																																																																					
1	6222.00	62.37	-----	-----	47.85	35.22	14.12	34.82	---	Peak																																																																																																					
2	6521.00	71.93	-----	-----	56.08	36.44	14.50	35.09	---	Peak																																																																																																					
3	6760.00	62.76	-----	-----	46.67	36.70	14.75	35.36	---	Peak																																																																																																					



UWB Bandwidth																																																																																																					
Mode 10	Mode 11																																																																																																				
<p>Date: 2024-02-22</p> <p>Site Condition: :03CH22-HY :3mLEZC04A1BEN_230712 VERTICAL :RBW:1000.000KHz VBW:3000.000KHz SWT:3.000sec</p> <p>Detector: :Peak Project: :3N2325 Channel: :CH5 Modulation: :BPRF UWB Frame: :3 HPRF Set #: :NA Payload Length: :NA Power Offset: :31 Post Power Offset: :50 Sweep point (pts): :1001 UWB Bandwidth (MHz): :543</p> <table border="1"> <thead> <tr> <th>Freq</th> <th>Level</th> <th>Over</th> <th>Limit</th> <th>ReadAntenna</th> <th>Cable</th> <th>Preamp</th> <th>A/Pos</th> <th>T/Pos</th> <th>Remark</th> </tr> <tr> <th>MHz</th> <th>dBuV/m</th> <th>dB</th> <th>dBuV/m</th> <th>dBuV</th> <th>dB/m</th> <th>dB</th> <th>dB</th> <th>cm</th> <th>deg</th> </tr> </thead> <tbody> <tr> <td>1</td> <td>7713.00</td> <td>63.54</td> <td>-----</td> <td>46.90</td> <td>37.00</td> <td>15.87</td> <td>36.23</td> <td>---</td> <td>Peak</td> </tr> <tr> <td>2</td> <td>7752.00</td> <td>72.67</td> <td>-----</td> <td>46.03</td> <td>37.00</td> <td>15.92</td> <td>36.28</td> <td>---</td> <td>Peak</td> </tr> <tr> <td>3</td> <td>8256.00</td> <td>63.19</td> <td>-----</td> <td>46.53</td> <td>37.28</td> <td>16.32</td> <td>36.86</td> <td>---</td> <td>Peak</td> </tr> </tbody> </table>	Freq	Level	Over	Limit	ReadAntenna	Cable	Preamp	A/Pos	T/Pos	Remark	MHz	dBuV/m	dB	dBuV/m	dBuV	dB/m	dB	dB	cm	deg	1	7713.00	63.54	-----	46.90	37.00	15.87	36.23	---	Peak	2	7752.00	72.67	-----	46.03	37.00	15.92	36.28	---	Peak	3	8256.00	63.19	-----	46.53	37.28	16.32	36.86	---	Peak	<p>Date: 2024-02-22</p> <p>Site Condition: :03CH22-HY :3mLEZC04A1BEN_230712 VERTICAL :RBW:1000.000KHz VBW:3000.000KHz SWT:3.000sec</p> <p>Detector: :Peak Project: :3N2325 Channel: :CH5 Modulation: :BPRF UWB Frame: :3 HPRF Set #: :NA Payload Length: :NA Power Offset: :50 Post Power Offset: :50 Sweep point (pts): :1001 UWB Bandwidth (MHz): :536</p> <table border="1"> <thead> <tr> <th>Freq</th> <th>Level</th> <th>Over</th> <th>Limit</th> <th>ReadAntenna</th> <th>Cable</th> <th>Preamp</th> <th>A/Pos</th> <th>T/Pos</th> <th>Remark</th> </tr> <tr> <th>MHz</th> <th>dBuV/m</th> <th>dB</th> <th>dBuV/m</th> <th>dBuV</th> <th>dB/m</th> <th>dB</th> <th>dB</th> <th>cm</th> <th>deg</th> </tr> </thead> <tbody> <tr> <td>1</td> <td>6223.00</td> <td>66.82</td> <td>-----</td> <td>52.29</td> <td>35.23</td> <td>14.12</td> <td>34.82</td> <td>---</td> <td>Peak</td> </tr> <tr> <td>2</td> <td>6725.00</td> <td>75.78</td> <td>-----</td> <td>59.73</td> <td>36.65</td> <td>14.72</td> <td>35.32</td> <td>---</td> <td>Peak</td> </tr> <tr> <td>3</td> <td>6759.00</td> <td>67.59</td> <td>-----</td> <td>51.50</td> <td>36.78</td> <td>14.75</td> <td>35.36</td> <td>---</td> <td>Peak</td> </tr> </tbody> </table>	Freq	Level	Over	Limit	ReadAntenna	Cable	Preamp	A/Pos	T/Pos	Remark	MHz	dBuV/m	dB	dBuV/m	dBuV	dB/m	dB	dB	cm	deg	1	6223.00	66.82	-----	52.29	35.23	14.12	34.82	---	Peak	2	6725.00	75.78	-----	59.73	36.65	14.72	35.32	---	Peak	3	6759.00	67.59	-----	51.50	36.78	14.75	35.36	---	Peak
Freq	Level	Over	Limit	ReadAntenna	Cable	Preamp	A/Pos	T/Pos	Remark																																																																																												
MHz	dBuV/m	dB	dBuV/m	dBuV	dB/m	dB	dB	cm	deg																																																																																												
1	7713.00	63.54	-----	46.90	37.00	15.87	36.23	---	Peak																																																																																												
2	7752.00	72.67	-----	46.03	37.00	15.92	36.28	---	Peak																																																																																												
3	8256.00	63.19	-----	46.53	37.28	16.32	36.86	---	Peak																																																																																												
Freq	Level	Over	Limit	ReadAntenna	Cable	Preamp	A/Pos	T/Pos	Remark																																																																																												
MHz	dBuV/m	dB	dBuV/m	dBuV	dB/m	dB	dB	cm	deg																																																																																												
1	6223.00	66.82	-----	52.29	35.23	14.12	34.82	---	Peak																																																																																												
2	6725.00	75.78	-----	59.73	36.65	14.72	35.32	---	Peak																																																																																												
3	6759.00	67.59	-----	51.50	36.78	14.75	35.36	---	Peak																																																																																												
<p>Date: 2024-02-22</p> <p>Site Condition: :03CH22-HY :3mLEZC04A1BEN_230712 VERTICAL :RBW:1000.000KHz VBW:3000.000KHz SWT:3.000sec</p> <p>Detector: :Peak Project: :3N2325 Channel: :CH5 Modulation: :BPRF UWB Frame: :3 HPRF Set #: :NA Payload Length: :48 Power Offset: :48 Post Power Offset: :50 Sweep point (pts): :1001 UWB Bandwidth (MHz): :507</p> <table border="1"> <thead> <tr> <th>Freq</th> <th>Level</th> <th>Over</th> <th>Limit</th> <th>ReadAntenna</th> <th>Cable</th> <th>Preamp</th> <th>A/Pos</th> <th>T/Pos</th> <th>Remark</th> </tr> <tr> <th>MHz</th> <th>dBuV/m</th> <th>dB</th> <th>dBuV/m</th> <th>dBuV</th> <th>dB/m</th> <th>dB</th> <th>dB</th> <th>cm</th> <th>deg</th> </tr> </thead> <tbody> <tr> <td>1</td> <td>7717.00</td> <td>66.59</td> <td>-----</td> <td>49.95</td> <td>37.00</td> <td>15.88</td> <td>36.24</td> <td>---</td> <td>Peak</td> </tr> <tr> <td>2</td> <td>7752.00</td> <td>76.38</td> <td>-----</td> <td>59.46</td> <td>37.00</td> <td>15.92</td> <td>36.28</td> <td>---</td> <td>Peak</td> </tr> <tr> <td>3</td> <td>8226.00</td> <td>66.38</td> <td>-----</td> <td>49.70</td> <td>37.15</td> <td>16.28</td> <td>36.83</td> <td>---</td> <td>Peak</td> </tr> </tbody> </table>	Freq	Level	Over	Limit	ReadAntenna	Cable	Preamp	A/Pos	T/Pos	Remark	MHz	dBuV/m	dB	dBuV/m	dBuV	dB/m	dB	dB	cm	deg	1	7717.00	66.59	-----	49.95	37.00	15.88	36.24	---	Peak	2	7752.00	76.38	-----	59.46	37.00	15.92	36.28	---	Peak	3	8226.00	66.38	-----	49.70	37.15	16.28	36.83	---	Peak																																																			
Freq	Level	Over	Limit	ReadAntenna	Cable	Preamp	A/Pos	T/Pos	Remark																																																																																												
MHz	dBuV/m	dB	dBuV/m	dBuV	dB/m	dB	dB	cm	deg																																																																																												
1	7717.00	66.59	-----	49.95	37.00	15.88	36.24	---	Peak																																																																																												
2	7752.00	76.38	-----	59.46	37.00	15.92	36.28	---	Peak																																																																																												
3	8226.00	66.38	-----	49.70	37.15	16.28	36.83	---	Peak																																																																																												



Mode 13		Mode 14																																																																																																													
<p>Site Condition : 03CH22-HY : 3m LEZC04A1BEN_230712 HORIZONTAL : RBW:1000.000KHz VBW:3000.000KHz SWT:3.000sec</p> <p>Detector : Peak Project : 3N2325 Channel : CH5 Modulation : HPRF UWB Frame : N/A HPRF Set # : 13 Payload Length : N/A Power Offset Length : 42 Post Power Offset : 50 Sweep point (pts) : 1001 UWB Bandwidth (MHz) : 510</p> <table border="1"> <thead> <tr> <th>Freq</th> <th>Level</th> <th>Over</th> <th>Limit</th> <th>ReadAntenna</th> <th>Cable</th> <th>Preamp</th> <th>A/Pos</th> <th>T/Pos</th> <th>Remark</th> </tr> <tr> <th>MHz</th> <th>dBuV/m</th> <th>dB</th> <th>dBuV/m</th> <th>Level</th> <th>Loss</th> <th>Factor</th> <th>dB</th> <th>dB</th> <th>cm</th> <th>deg</th> </tr> </thead> <tbody> <tr> <td>1</td> <td>6258.00</td> <td>68.85</td> <td>-----</td> <td>46.05</td> <td>35.58</td> <td>14.15</td> <td>34.85</td> <td>---</td> <td>---</td> <td>Peak</td> </tr> <tr> <td>2</td> <td>6725.00</td> <td>70.32</td> <td>-----</td> <td>56.27</td> <td>36.65</td> <td>14.72</td> <td>35.32</td> <td>---</td> <td>---</td> <td>Peak</td> </tr> <tr> <td>3</td> <td>6768.00</td> <td>68.97</td> <td>-----</td> <td>44.88</td> <td>36.78</td> <td>14.75</td> <td>35.36</td> <td>---</td> <td>---</td> <td>Peak</td> </tr> </tbody> </table>		Freq	Level	Over	Limit	ReadAntenna	Cable	Preamp	A/Pos	T/Pos	Remark	MHz	dBuV/m	dB	dBuV/m	Level	Loss	Factor	dB	dB	cm	deg	1	6258.00	68.85	-----	46.05	35.58	14.15	34.85	---	---	Peak	2	6725.00	70.32	-----	56.27	36.65	14.72	35.32	---	---	Peak	3	6768.00	68.97	-----	44.88	36.78	14.75	35.36	---	---	Peak	<p>Site Condition : 03CH22-HY : 3m LEZC04A1BEN_230712 VERTICAL : RBW:1000.000KHz VBW:3000.000KHz SWT:3.000sec</p> <p>Detector : Peak Project : 3N2325 Channel : CH5 Modulation : HPRF UWB Frame : N/A HPRF Set # : 13 Payload Length : N/A Power Offset Length : 60 Post Power Offset : 50 Sweep point (pts) : 1001 UWB Bandwidth (MHz) : 538</p> <table border="1"> <thead> <tr> <th>Freq</th> <th>Level</th> <th>Over</th> <th>Limit</th> <th>ReadAntenna</th> <th>Cable</th> <th>Preamp</th> <th>A/Pos</th> <th>T/Pos</th> <th>Remark</th> </tr> <tr> <th>MHz</th> <th>dBuV/m</th> <th>dB</th> <th>dBuV/m</th> <th>Level</th> <th>Loss</th> <th>Factor</th> <th>dB</th> <th>dB</th> <th>cm</th> <th>deg</th> </tr> </thead> <tbody> <tr> <td>1</td> <td>7716.00</td> <td>68.90</td> <td>-----</td> <td>44.26</td> <td>37.00</td> <td>15.88</td> <td>36.24</td> <td>---</td> <td>---</td> <td>Peak</td> </tr> <tr> <td>2</td> <td>7752.00</td> <td>70.77</td> <td>-----</td> <td>54.13</td> <td>37.00</td> <td>15.92</td> <td>36.28</td> <td>---</td> <td>---</td> <td>Peak</td> </tr> <tr> <td>3</td> <td>8254.00</td> <td>62.00</td> <td>-----</td> <td>45.34</td> <td>37.28</td> <td>16.32</td> <td>36.86</td> <td>---</td> <td>---</td> <td>Peak</td> </tr> </tbody> </table>		Freq	Level	Over	Limit	ReadAntenna	Cable	Preamp	A/Pos	T/Pos	Remark	MHz	dBuV/m	dB	dBuV/m	Level	Loss	Factor	dB	dB	cm	deg	1	7716.00	68.90	-----	44.26	37.00	15.88	36.24	---	---	Peak	2	7752.00	70.77	-----	54.13	37.00	15.92	36.28	---	---	Peak	3	8254.00	62.00	-----	45.34	37.28	16.32	36.86	---	---	Peak
Freq	Level	Over	Limit	ReadAntenna	Cable	Preamp	A/Pos	T/Pos	Remark																																																																																																						
MHz	dBuV/m	dB	dBuV/m	Level	Loss	Factor	dB	dB	cm	deg																																																																																																					
1	6258.00	68.85	-----	46.05	35.58	14.15	34.85	---	---	Peak																																																																																																					
2	6725.00	70.32	-----	56.27	36.65	14.72	35.32	---	---	Peak																																																																																																					
3	6768.00	68.97	-----	44.88	36.78	14.75	35.36	---	---	Peak																																																																																																					
Freq	Level	Over	Limit	ReadAntenna	Cable	Preamp	A/Pos	T/Pos	Remark																																																																																																						
MHz	dBuV/m	dB	dBuV/m	Level	Loss	Factor	dB	dB	cm	deg																																																																																																					
1	7716.00	68.90	-----	44.26	37.00	15.88	36.24	---	---	Peak																																																																																																					
2	7752.00	70.77	-----	54.13	37.00	15.92	36.28	---	---	Peak																																																																																																					
3	8254.00	62.00	-----	45.34	37.28	16.32	36.86	---	---	Peak																																																																																																					
<p>Mode 15</p>																																																																																																															
<p>Site Condition : 03CH22-HY : 3m LEZC04A1BEN_230712 VERTICAL : RBW:1000.000KHz VBW:3000.000KHz SWT:3.000sec</p> <p>Detector : Peak Project : 3N2325 Channel : CH5 Modulation : HPRF UWB Frame : N/A HPRF Set # : 13 Payload Length : N/A Power Offset Length : 80 Post Power Offset : 50 Sweep point (pts) : 1001 UWB Bandwidth (MHz) : 539</p> <table border="1"> <thead> <tr> <th>Freq</th> <th>Level</th> <th>Over</th> <th>Limit</th> <th>ReadAntenna</th> <th>Cable</th> <th>Preamp</th> <th>A/Pos</th> <th>T/Pos</th> <th>Remark</th> </tr> <tr> <th>MHz</th> <th>dBuV/m</th> <th>dB</th> <th>dBuV/m</th> <th>Level</th> <th>Loss</th> <th>Factor</th> <th>dB</th> <th>dB</th> <th>cm</th> <th>deg</th> </tr> </thead> <tbody> <tr> <td>1</td> <td>6221.00</td> <td>67.69</td> <td>-----</td> <td>53.18</td> <td>35.21</td> <td>14.12</td> <td>34.82</td> <td>---</td> <td>---</td> <td>Peak</td> </tr> <tr> <td>2</td> <td>6725.00</td> <td>76.78</td> <td>-----</td> <td>66.73</td> <td>36.65</td> <td>14.72</td> <td>35.32</td> <td>---</td> <td>---</td> <td>Peak</td> </tr> <tr> <td>3</td> <td>6768.00</td> <td>67.84</td> <td>-----</td> <td>56.95</td> <td>36.78</td> <td>14.75</td> <td>35.36</td> <td>---</td> <td>---</td> <td>Peak</td> </tr> </tbody> </table>		Freq	Level	Over	Limit	ReadAntenna	Cable	Preamp	A/Pos	T/Pos	Remark	MHz	dBuV/m	dB	dBuV/m	Level	Loss	Factor	dB	dB	cm	deg	1	6221.00	67.69	-----	53.18	35.21	14.12	34.82	---	---	Peak	2	6725.00	76.78	-----	66.73	36.65	14.72	35.32	---	---	Peak	3	6768.00	67.84	-----	56.95	36.78	14.75	35.36	---	---	Peak																																																								
Freq	Level	Over	Limit	ReadAntenna	Cable	Preamp	A/Pos	T/Pos	Remark																																																																																																						
MHz	dBuV/m	dB	dBuV/m	Level	Loss	Factor	dB	dB	cm	deg																																																																																																					
1	6221.00	67.69	-----	53.18	35.21	14.12	34.82	---	---	Peak																																																																																																					
2	6725.00	76.78	-----	66.73	36.65	14.72	35.32	---	---	Peak																																																																																																					
3	6768.00	67.84	-----	56.95	36.78	14.75	35.36	---	---	Peak																																																																																																					



UWB Bandwidth																																																																																																													
Mode 16	Mode 17																																																																																																												
<p>Date: 2024-03-04</p> <p>Site Condition : 03CH22-HY : 3m LE2C04A1BEN_230712 VERTICAL : RBW:1000.000kHz VBW:3000.000kHz SWT:3.000sec</p> <p>Detector : Peak Project : 3N2325 Channel : CH9 Modulation : HPRF UWB Frame : N/A HPRF Set # : 13 Payload Length : 150 Power Offsetlength : 09 Post Power Offset : 60 Sweep point (pts) : 1001 UWB Bandwidth (MHz) : 540</p> <table border="1"> <thead> <tr> <th>Freq</th> <th>Level</th> <th>Over</th> <th>Limit</th> <th>ReadAntenna</th> <th>Cable</th> <th>Preamp</th> <th>A/Pos</th> <th>T/Pos</th> <th>Remark</th> </tr> <tr> <th>MHz</th> <th>dBuV/m</th> <th>dB</th> <th>dBuV/m</th> <th>Level</th> <th>Loss</th> <th>Factor</th> <th>dB</th> <th>dB</th> <th>cm</th> <th>deg</th> </tr> </thead> <tbody> <tr> <td>1</td> <td>7717.00</td> <td>62.43</td> <td>-----</td> <td>45.79</td> <td>37.00</td> <td>15.88</td> <td>36.24</td> <td>---</td> <td>---</td> <td>Peak</td> </tr> <tr> <td>2</td> <td>7752.00</td> <td>72.39</td> <td>-----</td> <td>55.75</td> <td>37.00</td> <td>15.92</td> <td>36.28</td> <td>---</td> <td>---</td> <td>Peak</td> </tr> <tr> <td>3</td> <td>8257.00</td> <td>62.89</td> <td>-----</td> <td>46.22</td> <td>37.28</td> <td>16.33</td> <td>36.86</td> <td>---</td> <td>---</td> <td>Peak</td> </tr> </tbody> </table>	Freq	Level	Over	Limit	ReadAntenna	Cable	Preamp	A/Pos	T/Pos	Remark	MHz	dBuV/m	dB	dBuV/m	Level	Loss	Factor	dB	dB	cm	deg	1	7717.00	62.43	-----	45.79	37.00	15.88	36.24	---	---	Peak	2	7752.00	72.39	-----	55.75	37.00	15.92	36.28	---	---	Peak	3	8257.00	62.89	-----	46.22	37.28	16.33	36.86	---	---	Peak	<p>Date: 2024-02-22</p> <p>Site Condition : 03CH22-HY : 3m LE2C04A1BEN_230712 HORIZONTAL : RBW:1000.000kHz VBW:3000.000kHz SWT:3.000sec</p> <p>Detector : Peak Project : 3N2325 Channel : CH5 Modulation : HPRF UWB Frame : N/A HPRF Set # : 15 Payload Length : N/A Power Offsetlength : 48 Post Power Offset : 50 Sweep point (pts) : 1001 UWB Bandwidth (MHz) : 503</p> <table border="1"> <thead> <tr> <th>Freq</th> <th>Level</th> <th>Over</th> <th>Limit</th> <th>ReadAntenna</th> <th>Cable</th> <th>Preamp</th> <th>A/Pos</th> <th>T/Pos</th> <th>Remark</th> </tr> <tr> <th>MHz</th> <th>dBuV/m</th> <th>dB</th> <th>dBuV/m</th> <th>Level</th> <th>Loss</th> <th>Factor</th> <th>dB</th> <th>dB</th> <th>cm</th> <th>deg</th> </tr> </thead> <tbody> <tr> <td>1</td> <td>6254.00</td> <td>66.51</td> <td>-----</td> <td>51.69</td> <td>35.52</td> <td>14.15</td> <td>34.85</td> <td>---</td> <td>---</td> <td>Peak</td> </tr> <tr> <td>2</td> <td>6590.00</td> <td>76.28</td> <td>-----</td> <td>60.52</td> <td>36.36</td> <td>14.46</td> <td>35.00</td> <td>---</td> <td>---</td> <td>Peak</td> </tr> <tr> <td>3</td> <td>6757.00</td> <td>66.56</td> <td>-----</td> <td>50.47</td> <td>36.78</td> <td>14.75</td> <td>35.36</td> <td>---</td> <td>---</td> <td>Peak</td> </tr> </tbody> </table>	Freq	Level	Over	Limit	ReadAntenna	Cable	Preamp	A/Pos	T/Pos	Remark	MHz	dBuV/m	dB	dBuV/m	Level	Loss	Factor	dB	dB	cm	deg	1	6254.00	66.51	-----	51.69	35.52	14.15	34.85	---	---	Peak	2	6590.00	76.28	-----	60.52	36.36	14.46	35.00	---	---	Peak	3	6757.00	66.56	-----	50.47	36.78	14.75	35.36	---	---	Peak
Freq	Level	Over	Limit	ReadAntenna	Cable	Preamp	A/Pos	T/Pos	Remark																																																																																																				
MHz	dBuV/m	dB	dBuV/m	Level	Loss	Factor	dB	dB	cm	deg																																																																																																			
1	7717.00	62.43	-----	45.79	37.00	15.88	36.24	---	---	Peak																																																																																																			
2	7752.00	72.39	-----	55.75	37.00	15.92	36.28	---	---	Peak																																																																																																			
3	8257.00	62.89	-----	46.22	37.28	16.33	36.86	---	---	Peak																																																																																																			
Freq	Level	Over	Limit	ReadAntenna	Cable	Preamp	A/Pos	T/Pos	Remark																																																																																																				
MHz	dBuV/m	dB	dBuV/m	Level	Loss	Factor	dB	dB	cm	deg																																																																																																			
1	6254.00	66.51	-----	51.69	35.52	14.15	34.85	---	---	Peak																																																																																																			
2	6590.00	76.28	-----	60.52	36.36	14.46	35.00	---	---	Peak																																																																																																			
3	6757.00	66.56	-----	50.47	36.78	14.75	35.36	---	---	Peak																																																																																																			
<p>Date: 2024-02-22</p> <p>Site Condition : 03CH22-HY : 3m LE2C04A1BEN_230712 HORIZONTAL : RBW:1000.000kHz VBW:3000.000kHz SWT:3.000sec</p> <p>Detector : Peak Project : 3N2325 Channel : CH9 Modulation : HPRF UWB Frame : N/A HPRF Set # : 15 Payload Length : N/A Power Offsetlength : 60 Post Power Offset : 50 Sweep point (pts) : 1001 UWB Bandwidth (MHz) : 504</p> <table border="1"> <thead> <tr> <th>Freq</th> <th>Level</th> <th>Over</th> <th>Limit</th> <th>ReadAntenna</th> <th>Cable</th> <th>Preamp</th> <th>A/Pos</th> <th>T/Pos</th> <th>Remark</th> </tr> <tr> <th>MHz</th> <th>dBuV/m</th> <th>dB</th> <th>dBuV/m</th> <th>Level</th> <th>Loss</th> <th>Factor</th> <th>dB</th> <th>dB</th> <th>cm</th> <th>deg</th> </tr> </thead> <tbody> <tr> <td>1</td> <td>7702.00</td> <td>63.47</td> <td>-----</td> <td>46.83</td> <td>37.00</td> <td>15.86</td> <td>36.22</td> <td>---</td> <td>---</td> <td>Peak</td> </tr> <tr> <td>2</td> <td>7987.00</td> <td>73.44</td> <td>-----</td> <td>56.61</td> <td>37.27</td> <td>16.13</td> <td>36.57</td> <td>---</td> <td>---</td> <td>Peak</td> </tr> <tr> <td>3</td> <td>8206.00</td> <td>64.76</td> <td>-----</td> <td>48.21</td> <td>37.11</td> <td>16.25</td> <td>36.83</td> <td>---</td> <td>---</td> <td>Peak</td> </tr> </tbody> </table>	Freq	Level	Over	Limit	ReadAntenna	Cable	Preamp	A/Pos	T/Pos	Remark	MHz	dBuV/m	dB	dBuV/m	Level	Loss	Factor	dB	dB	cm	deg	1	7702.00	63.47	-----	46.83	37.00	15.86	36.22	---	---	Peak	2	7987.00	73.44	-----	56.61	37.27	16.13	36.57	---	---	Peak	3	8206.00	64.76	-----	48.21	37.11	16.25	36.83	---	---	Peak																																																							
Freq	Level	Over	Limit	ReadAntenna	Cable	Preamp	A/Pos	T/Pos	Remark																																																																																																				
MHz	dBuV/m	dB	dBuV/m	Level	Loss	Factor	dB	dB	cm	deg																																																																																																			
1	7702.00	63.47	-----	46.83	37.00	15.86	36.22	---	---	Peak																																																																																																			
2	7987.00	73.44	-----	56.61	37.27	16.13	36.57	---	---	Peak																																																																																																			
3	8206.00	64.76	-----	48.21	37.11	16.25	36.83	---	---	Peak																																																																																																			



UWB Bandwidth																																																																																																													
Mode 19	Mode 20																																																																																																												
<p>Date: 2024-02-22</p> <p>Site Condition: :03CH22-HY :3mLEZC04A1BEN_230712 VERTICAL :RBW:1000.000KHz VBW:3000.000KHz SWT:3.000sec</p> <p>Detector: :Peak Project: :3N2325 Channel: :CH5 Modulation: :HPRF UWB Frame: :NA HPRF Set #: :15 Payload Length: :150 Power Offset/length: :70 Post Power Offset: :54 Sweep point (pts): :1001 UWB Bandwidth (MHz): :540</p> <table border="1"> <thead> <tr> <th>Freq</th> <th>Level</th> <th>Over</th> <th>Limit</th> <th>ReadAntenna</th> <th>Cable</th> <th>Preamp</th> <th>A/Pos</th> <th>T/Pos</th> <th>Remark</th> </tr> <tr> <th>MHz</th> <th>dBuV/m</th> <th>dB</th> <th>dBuV/m</th> <th>Level</th> <th>Loss</th> <th>Factor</th> <th>dB</th> <th>dB</th> <th>cm</th> <th>deg</th> </tr> </thead> <tbody> <tr> <td>1</td> <td>6221.00</td> <td>66.53</td> <td>-----</td> <td>52.02</td> <td>35.21</td> <td>14.12</td> <td>34.82</td> <td>---</td> <td>---</td> <td>Peak</td> </tr> <tr> <td>2</td> <td>6725.00</td> <td>75.85</td> <td>-----</td> <td>59.80</td> <td>36.65</td> <td>14.72</td> <td>35.32</td> <td>---</td> <td>---</td> <td>Peak</td> </tr> <tr> <td>3</td> <td>6761.00</td> <td>66.48</td> <td>-----</td> <td>50.39</td> <td>36.70</td> <td>14.75</td> <td>35.36</td> <td>---</td> <td>---</td> <td>Peak</td> </tr> </tbody> </table>	Freq	Level	Over	Limit	ReadAntenna	Cable	Preamp	A/Pos	T/Pos	Remark	MHz	dBuV/m	dB	dBuV/m	Level	Loss	Factor	dB	dB	cm	deg	1	6221.00	66.53	-----	52.02	35.21	14.12	34.82	---	---	Peak	2	6725.00	75.85	-----	59.80	36.65	14.72	35.32	---	---	Peak	3	6761.00	66.48	-----	50.39	36.70	14.75	35.36	---	---	Peak	<p>Date: 2023-12-30</p> <p>Site Condition: :03CH22-HY :3mLEZC04A1BEN_230712 VERTICAL :RBW:1000.000KHz VBW:3000.000KHz SWT:3.000sec</p> <p>Detector: :Peak Project: :3N2325 Channel: :CH5 Modulation: :HPRF UWB Frame: :NA HPRF Set #: :15 Payload Length: :150 Power Offset/length: :63 Post Power Offset: :50 Sweep point (pts): :1001 UWB Bandwidth (MHz): :536</p> <table border="1"> <thead> <tr> <th>Freq</th> <th>Level</th> <th>Over</th> <th>Limit</th> <th>ReadAntenna</th> <th>Cable</th> <th>Preamp</th> <th>A/Pos</th> <th>T/Pos</th> <th>Remark</th> </tr> <tr> <th>MHz</th> <th>dBuV/m</th> <th>dB</th> <th>dBuV/m</th> <th>Level</th> <th>Loss</th> <th>Factor</th> <th>dB</th> <th>dB</th> <th>cm</th> <th>deg</th> </tr> </thead> <tbody> <tr> <td>1</td> <td>7719.00</td> <td>69.69</td> <td>-----</td> <td>53.05</td> <td>37.00</td> <td>15.88</td> <td>36.24</td> <td>111</td> <td>9</td> <td>Peak</td> </tr> <tr> <td>2</td> <td>7987.00</td> <td>79.54</td> <td>-----</td> <td>62.71</td> <td>37.27</td> <td>16.13</td> <td>36.57</td> <td>111</td> <td>9</td> <td>Peak</td> </tr> <tr> <td>3</td> <td>8255.00</td> <td>70.65</td> <td>-----</td> <td>53.99</td> <td>37.20</td> <td>16.32</td> <td>36.86</td> <td>111</td> <td>9</td> <td>Peak</td> </tr> </tbody> </table>	Freq	Level	Over	Limit	ReadAntenna	Cable	Preamp	A/Pos	T/Pos	Remark	MHz	dBuV/m	dB	dBuV/m	Level	Loss	Factor	dB	dB	cm	deg	1	7719.00	69.69	-----	53.05	37.00	15.88	36.24	111	9	Peak	2	7987.00	79.54	-----	62.71	37.27	16.13	36.57	111	9	Peak	3	8255.00	70.65	-----	53.99	37.20	16.32	36.86	111	9	Peak
Freq	Level	Over	Limit	ReadAntenna	Cable	Preamp	A/Pos	T/Pos	Remark																																																																																																				
MHz	dBuV/m	dB	dBuV/m	Level	Loss	Factor	dB	dB	cm	deg																																																																																																			
1	6221.00	66.53	-----	52.02	35.21	14.12	34.82	---	---	Peak																																																																																																			
2	6725.00	75.85	-----	59.80	36.65	14.72	35.32	---	---	Peak																																																																																																			
3	6761.00	66.48	-----	50.39	36.70	14.75	35.36	---	---	Peak																																																																																																			
Freq	Level	Over	Limit	ReadAntenna	Cable	Preamp	A/Pos	T/Pos	Remark																																																																																																				
MHz	dBuV/m	dB	dBuV/m	Level	Loss	Factor	dB	dB	cm	deg																																																																																																			
1	7719.00	69.69	-----	53.05	37.00	15.88	36.24	111	9	Peak																																																																																																			
2	7987.00	79.54	-----	62.71	37.27	16.13	36.57	111	9	Peak																																																																																																			
3	8255.00	70.65	-----	53.99	37.20	16.32	36.86	111	9	Peak																																																																																																			
<p>Date: 2024-03-05</p> <p>Site Condition: :03CH22-HY :3mLEZC04A1BEN_230712 HORIZONTAL :RBW:1000.000KHz VBW:3000.000KHz SWT:3.000sec</p> <p>Detector: :Peak Project: :3N2325 Channel: :CH5 Modulation: :HPRF UWB Frame: :NA HPRF Set #: :21 Payload Length: :162 Power Offset/length: :50 Post Power Offset: :1001 Sweep point (pts): :538 UWB Bandwidth (MHz): :538</p> <table border="1"> <thead> <tr> <th>Freq</th> <th>Level</th> <th>Over</th> <th>Limit</th> <th>ReadAntenna</th> <th>Cable</th> <th>Preamp</th> <th>A/Pos</th> <th>T/Pos</th> <th>Remark</th> </tr> <tr> <th>MHz</th> <th>dBuV/m</th> <th>dB</th> <th>dBuV/m</th> <th>Level</th> <th>Loss</th> <th>Factor</th> <th>dB</th> <th>dB</th> <th>cm</th> <th>deg</th> </tr> </thead> <tbody> <tr> <td>1</td> <td>6220.00</td> <td>66.33</td> <td>-----</td> <td>51.84</td> <td>35.20</td> <td>14.11</td> <td>34.82</td> <td>---</td> <td>---</td> <td>Peak</td> </tr> <tr> <td>2</td> <td>6254.00</td> <td>74.55</td> <td>-----</td> <td>59.73</td> <td>35.52</td> <td>14.15</td> <td>34.85</td> <td>---</td> <td>---</td> <td>Peak</td> </tr> <tr> <td>3</td> <td>6758.00</td> <td>65.44</td> <td>-----</td> <td>49.35</td> <td>36.70</td> <td>14.75</td> <td>35.36</td> <td>---</td> <td>---</td> <td>Peak</td> </tr> </tbody> </table>	Freq	Level	Over	Limit	ReadAntenna	Cable	Preamp	A/Pos	T/Pos	Remark	MHz	dBuV/m	dB	dBuV/m	Level	Loss	Factor	dB	dB	cm	deg	1	6220.00	66.33	-----	51.84	35.20	14.11	34.82	---	---	Peak	2	6254.00	74.55	-----	59.73	35.52	14.15	34.85	---	---	Peak	3	6758.00	65.44	-----	49.35	36.70	14.75	35.36	---	---	Peak																																																							
Freq	Level	Over	Limit	ReadAntenna	Cable	Preamp	A/Pos	T/Pos	Remark																																																																																																				
MHz	dBuV/m	dB	dBuV/m	Level	Loss	Factor	dB	dB	cm	deg																																																																																																			
1	6220.00	66.33	-----	51.84	35.20	14.11	34.82	---	---	Peak																																																																																																			
2	6254.00	74.55	-----	59.73	35.52	14.15	34.85	---	---	Peak																																																																																																			
3	6758.00	65.44	-----	49.35	36.70	14.75	35.36	---	---	Peak																																																																																																			



UWB Bandwidth																																																																																																																							
Mode 22	Mode 23																																																																																																																						
<p>Date: 2024-02-22</p> <p>Site Condition: 03CH22-HV, 3m LEZ0041BEN_230712 HORIZONTAL, RBW:1000.000KHz VBW:3000.000KHz SWT:3.000sec</p> <p>Detector: Peak Project: 3N2325 Channel: CH9 Modulation: HPRF UWB Frame: NA HPRF Set #: 21 Payload Length: NA Power Offset/length: 00 Post Power Offset: 50 Sweep point (pts): 1001 UWB Bandwidth (MHz): 539</p> <table border="1"> <thead> <tr> <th>Peak</th> <th>Freq</th> <th>Level</th> <th>Over</th> <th>Limit</th> <th>ReadAntenna</th> <th>Cable</th> <th>Preamp</th> <th>A/Pos</th> <th>T/Pos</th> <th>Remark</th> </tr> <tr> <th></th> <th>MHz</th> <th>dBuV/m</th> <th>dB</th> <th>dBuV/m</th> <th>Level</th> <th>Loss</th> <th>Factor</th> <th>dB</th> <th>dB</th> <th>cm</th> <th>deg</th> </tr> </thead> <tbody> <tr> <td>1</td> <td>7717.00</td> <td>62.58</td> <td>-----</td> <td>-----</td> <td>45.94</td> <td>37.00</td> <td>15.88</td> <td>36.24</td> <td>---</td> <td>---</td> <td>Peak</td> </tr> <tr> <td>2</td> <td>7752.00</td> <td>72.00</td> <td>-----</td> <td>-----</td> <td>55.44</td> <td>37.00</td> <td>15.92</td> <td>36.28</td> <td>---</td> <td>---</td> <td>Peak</td> </tr> <tr> <td>3</td> <td>8256.00</td> <td>62.95</td> <td>-----</td> <td>-----</td> <td>46.29</td> <td>37.20</td> <td>16.32</td> <td>36.86</td> <td>---</td> <td>---</td> <td>Peak</td> </tr> </tbody> </table>	Peak	Freq	Level	Over	Limit	ReadAntenna	Cable	Preamp	A/Pos	T/Pos	Remark		MHz	dBuV/m	dB	dBuV/m	Level	Loss	Factor	dB	dB	cm	deg	1	7717.00	62.58	-----	-----	45.94	37.00	15.88	36.24	---	---	Peak	2	7752.00	72.00	-----	-----	55.44	37.00	15.92	36.28	---	---	Peak	3	8256.00	62.95	-----	-----	46.29	37.20	16.32	36.86	---	---	Peak	<p>Date: 2024-02-22</p> <p>Site Condition: 03CH22-HV, 3m LEZ0041BEN_230712 VERTICAL, RBW:1000.000KHz VBW:3000.000KHz SWT:3.000sec</p> <p>Detector: Peak Project: 3N2325 Channel: CH5 Modulation: HPRF UWB Frame: NA HPRF Set #: 21 Payload Length: NA Power Offset/length: 71 Post Power Offset: 50 Sweep point (pts): 1001 UWB Bandwidth (MHz): 538</p> <table border="1"> <thead> <tr> <th>Peak</th> <th>Freq</th> <th>Level</th> <th>Over</th> <th>Limit</th> <th>ReadAntenna</th> <th>Cable</th> <th>Preamp</th> <th>A/Pos</th> <th>T/Pos</th> <th>Remark</th> </tr> <tr> <th></th> <th>MHz</th> <th>dBuV/m</th> <th>dB</th> <th>dBuV/m</th> <th>Level</th> <th>Loss</th> <th>Factor</th> <th>dB</th> <th>dB</th> <th>cm</th> <th>deg</th> </tr> </thead> <tbody> <tr> <td>1</td> <td>6221.00</td> <td>66.58</td> <td>-----</td> <td>-----</td> <td>52.07</td> <td>35.21</td> <td>14.12</td> <td>34.82</td> <td>---</td> <td>---</td> <td>Peak</td> </tr> <tr> <td>2</td> <td>6725.00</td> <td>75.95</td> <td>-----</td> <td>-----</td> <td>59.00</td> <td>36.65</td> <td>14.72</td> <td>35.32</td> <td>---</td> <td>---</td> <td>Peak</td> </tr> <tr> <td>3</td> <td>6759.00</td> <td>68.33</td> <td>-----</td> <td>-----</td> <td>52.24</td> <td>36.70</td> <td>14.75</td> <td>35.36</td> <td>---</td> <td>---</td> <td>Peak</td> </tr> </tbody> </table>	Peak	Freq	Level	Over	Limit	ReadAntenna	Cable	Preamp	A/Pos	T/Pos	Remark		MHz	dBuV/m	dB	dBuV/m	Level	Loss	Factor	dB	dB	cm	deg	1	6221.00	66.58	-----	-----	52.07	35.21	14.12	34.82	---	---	Peak	2	6725.00	75.95	-----	-----	59.00	36.65	14.72	35.32	---	---	Peak	3	6759.00	68.33	-----	-----	52.24	36.70	14.75	35.36	---	---	Peak
Peak	Freq	Level	Over	Limit	ReadAntenna	Cable	Preamp	A/Pos	T/Pos	Remark																																																																																																													
	MHz	dBuV/m	dB	dBuV/m	Level	Loss	Factor	dB	dB	cm	deg																																																																																																												
1	7717.00	62.58	-----	-----	45.94	37.00	15.88	36.24	---	---	Peak																																																																																																												
2	7752.00	72.00	-----	-----	55.44	37.00	15.92	36.28	---	---	Peak																																																																																																												
3	8256.00	62.95	-----	-----	46.29	37.20	16.32	36.86	---	---	Peak																																																																																																												
Peak	Freq	Level	Over	Limit	ReadAntenna	Cable	Preamp	A/Pos	T/Pos	Remark																																																																																																													
	MHz	dBuV/m	dB	dBuV/m	Level	Loss	Factor	dB	dB	cm	deg																																																																																																												
1	6221.00	66.58	-----	-----	52.07	35.21	14.12	34.82	---	---	Peak																																																																																																												
2	6725.00	75.95	-----	-----	59.00	36.65	14.72	35.32	---	---	Peak																																																																																																												
3	6759.00	68.33	-----	-----	52.24	36.70	14.75	35.36	---	---	Peak																																																																																																												
<p>Date: 2024-01-03</p> <p>Site Condition: 03CH22-HV, 3m LEZ0041BEN_230712 HORIZONTAL, RBW:1000.000KHz VBW:3000.000KHz SWT:3.000sec</p> <p>Detector: Peak Project: 3N2325 Channel: CH9 Modulation: HPRF UWB Frame: NA HPRF Set #: 21 Payload Length: NA Power Offset/length: 03 Post Power Offset: 51 Sweep point (pts): 1001 UWB Bandwidth (MHz): 540</p> <table border="1"> <thead> <tr> <th>Peak</th> <th>Freq</th> <th>Level</th> <th>Over</th> <th>Limit</th> <th>ReadAntenna</th> <th>Cable</th> <th>Preamp</th> <th>A/Pos</th> <th>T/Pos</th> <th>Remark</th> </tr> <tr> <th></th> <th>MHz</th> <th>dBuV/m</th> <th>dB</th> <th>dBuV/m</th> <th>Level</th> <th>Loss</th> <th>Factor</th> <th>dB</th> <th>dB</th> <th>cm</th> <th>deg</th> </tr> </thead> <tbody> <tr> <td>1</td> <td>7717.00</td> <td>67.04</td> <td>-----</td> <td>-----</td> <td>50.40</td> <td>37.00</td> <td>15.88</td> <td>36.24</td> <td>233</td> <td>4</td> <td>Peak</td> </tr> <tr> <td>2</td> <td>7752.00</td> <td>76.39</td> <td>-----</td> <td>-----</td> <td>59.75</td> <td>37.00</td> <td>15.92</td> <td>36.28</td> <td>233</td> <td>4</td> <td>Peak</td> </tr> <tr> <td>3</td> <td>8257.00</td> <td>67.64</td> <td>-----</td> <td>-----</td> <td>50.97</td> <td>37.20</td> <td>16.33</td> <td>36.86</td> <td>233</td> <td>4</td> <td>Peak</td> </tr> </tbody> </table>	Peak	Freq	Level	Over	Limit	ReadAntenna	Cable	Preamp	A/Pos	T/Pos	Remark		MHz	dBuV/m	dB	dBuV/m	Level	Loss	Factor	dB	dB	cm	deg	1	7717.00	67.04	-----	-----	50.40	37.00	15.88	36.24	233	4	Peak	2	7752.00	76.39	-----	-----	59.75	37.00	15.92	36.28	233	4	Peak	3	8257.00	67.64	-----	-----	50.97	37.20	16.33	36.86	233	4	Peak																																																												
Peak	Freq	Level	Over	Limit	ReadAntenna	Cable	Preamp	A/Pos	T/Pos	Remark																																																																																																													
	MHz	dBuV/m	dB	dBuV/m	Level	Loss	Factor	dB	dB	cm	deg																																																																																																												
1	7717.00	67.04	-----	-----	50.40	37.00	15.88	36.24	233	4	Peak																																																																																																												
2	7752.00	76.39	-----	-----	59.75	37.00	15.92	36.28	233	4	Peak																																																																																																												
3	8257.00	67.64	-----	-----	50.97	37.20	16.33	36.86	233	4	Peak																																																																																																												



UWB Bandwidth																																																																																																															
Mode 25	Mode 26																																																																																																														
<p>Date: 2024-02-22</p> <p>Site Condition : 03CH22-HY : 3m LEZC04A1BEN_230712 HORIZONTAL : RBW:1000.000kHz VBW:3000.000kHz SWT:3.000sec</p> <p>Detector : Peak Project : 3N2325 Channel : CH5 Modulation : HPRF UWB Frame : NA HPRF Set # : 31 Payload Length : NA Power Offsetlength : 30 Post Power Offset : 50 Sweep point (pts) : 1001 UWB Bandwidth (MHz) : 535</p> <table border="1"> <thead> <tr> <th>Peak</th> <th>Freq</th> <th>Level</th> <th>Over</th> <th>Limit</th> <th>ReadAntenna</th> <th>Cable</th> <th>Preamp</th> <th>A/Pos</th> <th>T/Pos</th> <th>Remark</th> </tr> <tr> <th></th> <th>MHz</th> <th>dBuV/m</th> <th>dB</th> <th>dBuV/m</th> <th>dBuV</th> <th>dB/m</th> <th>dB</th> <th>dB</th> <th>cm</th> <th>deg</th> </tr> </thead> <tbody> <tr> <td>1</td> <td>6223.00</td> <td>64.51</td> <td>-----</td> <td>-----</td> <td>49.98</td> <td>35.23</td> <td>14.12</td> <td>34.82</td> <td>---</td> <td>Peak</td> </tr> <tr> <td>2</td> <td>6758.00</td> <td>74.43</td> <td>-----</td> <td>-----</td> <td>58.62</td> <td>36.41</td> <td>14.48</td> <td>35.08</td> <td>---</td> <td>Peak</td> </tr> <tr> <td>3</td> <td>6758.00</td> <td>64.98</td> <td>-----</td> <td>-----</td> <td>48.89</td> <td>36.70</td> <td>14.75</td> <td>35.36</td> <td>---</td> <td>Peak</td> </tr> </tbody> </table>	Peak	Freq	Level	Over	Limit	ReadAntenna	Cable	Preamp	A/Pos	T/Pos	Remark		MHz	dBuV/m	dB	dBuV/m	dBuV	dB/m	dB	dB	cm	deg	1	6223.00	64.51	-----	-----	49.98	35.23	14.12	34.82	---	Peak	2	6758.00	74.43	-----	-----	58.62	36.41	14.48	35.08	---	Peak	3	6758.00	64.98	-----	-----	48.89	36.70	14.75	35.36	---	Peak	<p>Date: 2024-02-22</p> <p>Site Condition : 03CH22-HY : 3m LEZC04A1BEN_230712 HORIZONTAL : RBW:1000.000kHz VBW:3000.000kHz SWT:3.000sec</p> <p>Detector : Peak Project : 3N2325 Channel : CH5 Modulation : HPRF UWB Frame : NA HPRF Set # : 31 Payload Length : NA Power Offsetlength : 30 Post Power Offset : 50 Sweep point (pts) : 1001 UWB Bandwidth (MHz) : 512</p> <table border="1"> <thead> <tr> <th>Peak</th> <th>Freq</th> <th>Level</th> <th>Over</th> <th>Limit</th> <th>ReadAntenna</th> <th>Cable</th> <th>Preamp</th> <th>A/Pos</th> <th>T/Pos</th> <th>Remark</th> </tr> <tr> <th></th> <th>MHz</th> <th>dBuV/m</th> <th>dB</th> <th>dBuV/m</th> <th>dBuV</th> <th>dB/m</th> <th>dB</th> <th>dB</th> <th>cm</th> <th>deg</th> </tr> </thead> <tbody> <tr> <td>1</td> <td>7712.00</td> <td>64.97</td> <td>-----</td> <td>-----</td> <td>48.33</td> <td>37.00</td> <td>15.87</td> <td>36.23</td> <td>---</td> <td>Peak</td> </tr> <tr> <td>2</td> <td>7848.00</td> <td>74.87</td> <td>-----</td> <td>-----</td> <td>58.15</td> <td>37.10</td> <td>16.02</td> <td>36.40</td> <td>---</td> <td>Peak</td> </tr> <tr> <td>3</td> <td>8224.00</td> <td>65.27</td> <td>-----</td> <td>-----</td> <td>48.67</td> <td>37.15</td> <td>16.28</td> <td>36.83</td> <td>---</td> <td>Peak</td> </tr> </tbody> </table>	Peak	Freq	Level	Over	Limit	ReadAntenna	Cable	Preamp	A/Pos	T/Pos	Remark		MHz	dBuV/m	dB	dBuV/m	dBuV	dB/m	dB	dB	cm	deg	1	7712.00	64.97	-----	-----	48.33	37.00	15.87	36.23	---	Peak	2	7848.00	74.87	-----	-----	58.15	37.10	16.02	36.40	---	Peak	3	8224.00	65.27	-----	-----	48.67	37.15	16.28	36.83	---	Peak
Peak	Freq	Level	Over	Limit	ReadAntenna	Cable	Preamp	A/Pos	T/Pos	Remark																																																																																																					
	MHz	dBuV/m	dB	dBuV/m	dBuV	dB/m	dB	dB	cm	deg																																																																																																					
1	6223.00	64.51	-----	-----	49.98	35.23	14.12	34.82	---	Peak																																																																																																					
2	6758.00	74.43	-----	-----	58.62	36.41	14.48	35.08	---	Peak																																																																																																					
3	6758.00	64.98	-----	-----	48.89	36.70	14.75	35.36	---	Peak																																																																																																					
Peak	Freq	Level	Over	Limit	ReadAntenna	Cable	Preamp	A/Pos	T/Pos	Remark																																																																																																					
	MHz	dBuV/m	dB	dBuV/m	dBuV	dB/m	dB	dB	cm	deg																																																																																																					
1	7712.00	64.97	-----	-----	48.33	37.00	15.87	36.23	---	Peak																																																																																																					
2	7848.00	74.87	-----	-----	58.15	37.10	16.02	36.40	---	Peak																																																																																																					
3	8224.00	65.27	-----	-----	48.67	37.15	16.28	36.83	---	Peak																																																																																																					
<p>Date: 2024-02-22</p> <p>Site Condition : 03CH22-HY : 3m LEZC04A1BEN_230712 VERTICAL : RBW:1000.000kHz VBW:3000.000kHz SWT:3.000sec</p> <p>Detector : Peak Project : 3N2325 Channel : CH5 Modulation : HPRF UWB Frame : NA HPRF Set # : 31 Payload Length : NA Power Offsetlength : 54 Post Power Offset : 57 Sweep point (pts) : 1001 UWB Bandwidth (MHz) : 542</p> <table border="1"> <thead> <tr> <th>Peak</th> <th>Freq</th> <th>Level</th> <th>Over</th> <th>Limit</th> <th>ReadAntenna</th> <th>Cable</th> <th>Preamp</th> <th>A/Pos</th> <th>T/Pos</th> <th>Remark</th> </tr> <tr> <th></th> <th>MHz</th> <th>dBuV/m</th> <th>dB</th> <th>dBuV/m</th> <th>dBuV</th> <th>dB/m</th> <th>dB</th> <th>dB</th> <th>cm</th> <th>deg</th> </tr> </thead> <tbody> <tr> <td>1</td> <td>6221.00</td> <td>63.02</td> <td>-----</td> <td>-----</td> <td>48.51</td> <td>35.21</td> <td>14.12</td> <td>34.82</td> <td>---</td> <td>Peak</td> </tr> <tr> <td>2</td> <td>6725.00</td> <td>72.55</td> <td>-----</td> <td>-----</td> <td>56.50</td> <td>36.65</td> <td>14.72</td> <td>35.32</td> <td>---</td> <td>Peak</td> </tr> <tr> <td>3</td> <td>6763.00</td> <td>62.76</td> <td>-----</td> <td>-----</td> <td>46.60</td> <td>36.70</td> <td>14.76</td> <td>35.36</td> <td>---</td> <td>Peak</td> </tr> </tbody> </table>	Peak	Freq	Level	Over	Limit	ReadAntenna	Cable	Preamp	A/Pos	T/Pos	Remark		MHz	dBuV/m	dB	dBuV/m	dBuV	dB/m	dB	dB	cm	deg	1	6221.00	63.02	-----	-----	48.51	35.21	14.12	34.82	---	Peak	2	6725.00	72.55	-----	-----	56.50	36.65	14.72	35.32	---	Peak	3	6763.00	62.76	-----	-----	46.60	36.70	14.76	35.36	---	Peak																																																								
Peak	Freq	Level	Over	Limit	ReadAntenna	Cable	Preamp	A/Pos	T/Pos	Remark																																																																																																					
	MHz	dBuV/m	dB	dBuV/m	dBuV	dB/m	dB	dB	cm	deg																																																																																																					
1	6221.00	63.02	-----	-----	48.51	35.21	14.12	34.82	---	Peak																																																																																																					
2	6725.00	72.55	-----	-----	56.50	36.65	14.72	35.32	---	Peak																																																																																																					
3	6763.00	62.76	-----	-----	46.60	36.70	14.76	35.36	---	Peak																																																																																																					

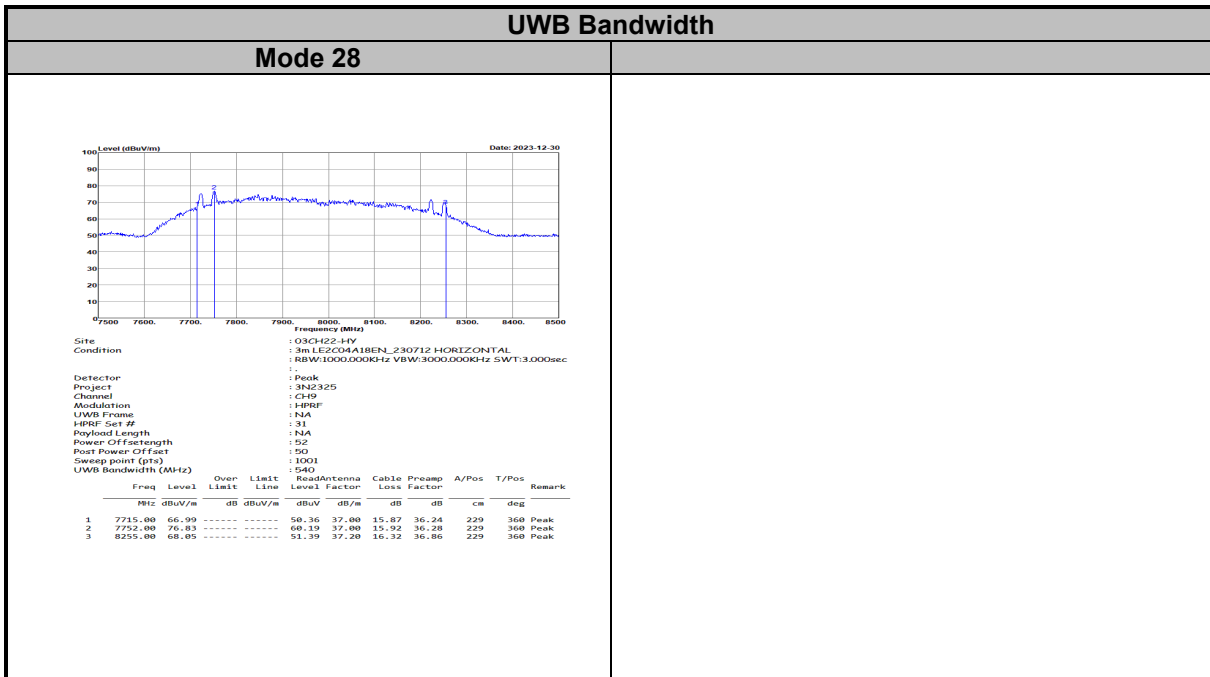

3.3 Technical requirements for hand held UWB systems

3.3.1 Technical Requirements for transmission Limit

FCC 15.519(a) (1) A UWB device operating under the provisions of this section shall transmit only when it is sending information to an associated receiver. The UWB intentional radiator shall cease transmission within 10 seconds unless it receives an acknowledgement from the associated receiver that its transmission is being received. An acknowledgment of reception must continue to be received by the UWB intentional radiator at least every 10 seconds or the UWB device must cease transmitting.

3.3.2 Measuring Instruments

Refer a test equipment and calibration data table in this test report.

3.3.3 Test Procedure

Follow the test step as below:

1. Turn on both EUT and companion receiver.
2. Set the EUT to TX mode, and EUT starts polling.
3. Set the companion receiver to associate EUT and EUT starts to transmit.
4. Disable the RX function of the companion receiver to disassociate the EUT.
5. Check if EUT stop transmitting once step 4 is made.

3.3.4 Test Setup

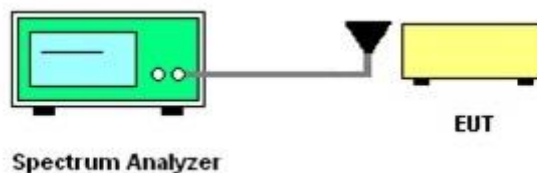



3.3.5 Test Result

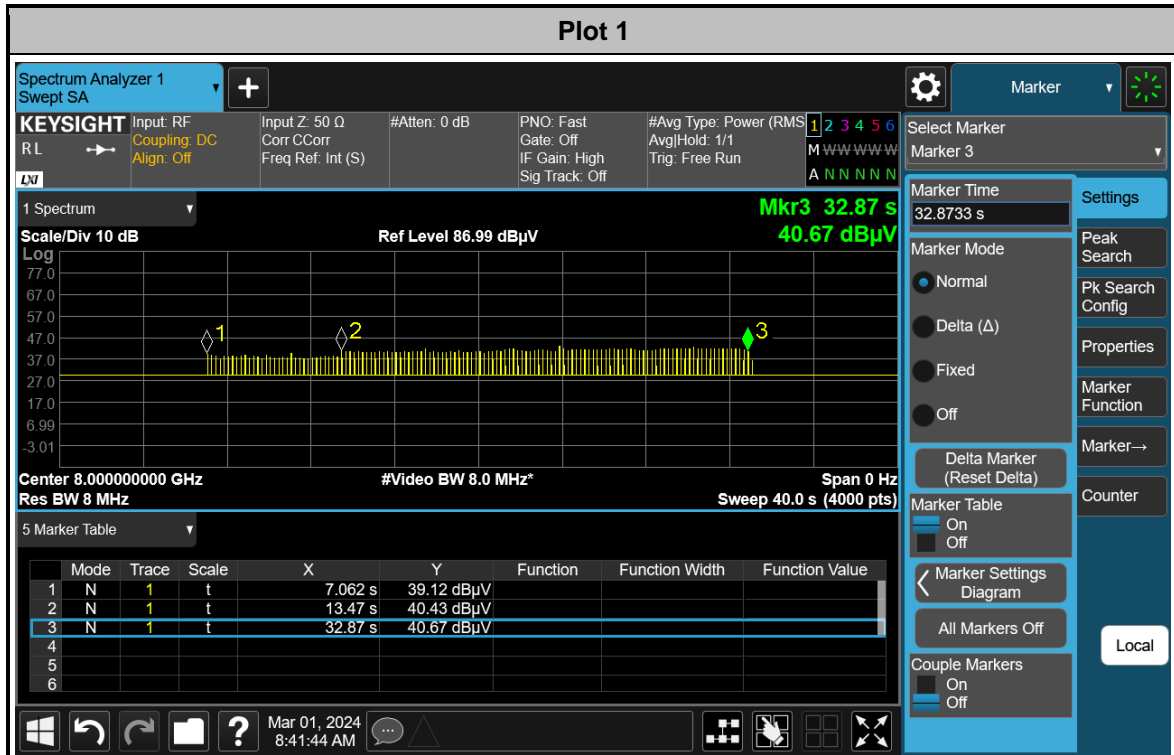

M1 to M2: Set the EUT to TX mode, and EUT starts polling.

M2 to M3: Set the companion receiver to associate EUT and EUT starts to transmit.

M3: Disable the TX function of EUT. EUT stops transmitting and polling.

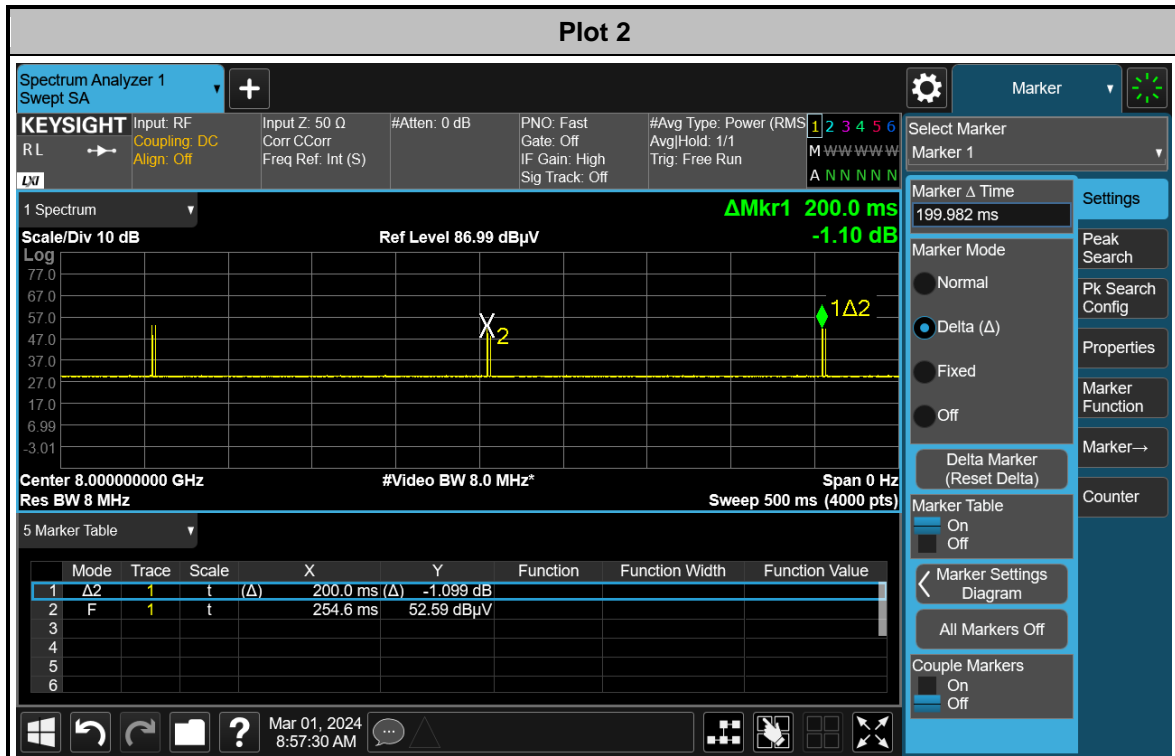

M1 to M2: Set the EUT to TX mode, and EUT starts polling.
 M2 to M3: Set the companion receiver to associate EUT and EUT starts to transmit.
 M3: RX function of the companion receiver is disabled. EUT disassociates the companion receiver and stops transmitting, but continues polling.



Plot 3 is zoom in plot of M2 to M3 (transmission)
 Plot 4 is zoom in plot after M3 (polling only)

3.4 Peak Power Measurement

3.4.1 Peak Power Measurement Limit

Peak Power Measurement Limit
$P_{eirp} = 0 \text{ dBm}/50\text{MHz}$

3.4.2 Measuring Instruments

Refer a test equipment and calibration data table in this test report.

3.4.3 Test Procedures

Test Method
<ul style="list-style-type: none"> ■ Peak Power Measurement
<ul style="list-style-type: none"> ■ Refer as ANSI C63.10, clause 10.3.1 for radiated measurement procedure testing. ■ Refer as ANSI C63.10, clause 10.3.2 for measurement distance is 3m. ■ Refer as ANSI C63.10, clause 10.3.5 for peak detector procedure testing. ■ Refer as ANSI C63.10, clause 10.3.6 for bandwidth conversion of peak power.
<ul style="list-style-type: none"> ■ Frequency of max peak power is pre-located: The span bandwidth is continuously reduced to find the worst frequency. Once the worst frequency is found, the setting of spectrum analyzer is set as below: <ul style="list-style-type: none"> • Central frequency: Worst frequency point • Span: Zero span • RBW: 50MHz • VBW: 80MHz • Detector: Peak detector • Trace: Max hold

3.4.4 Test Setup

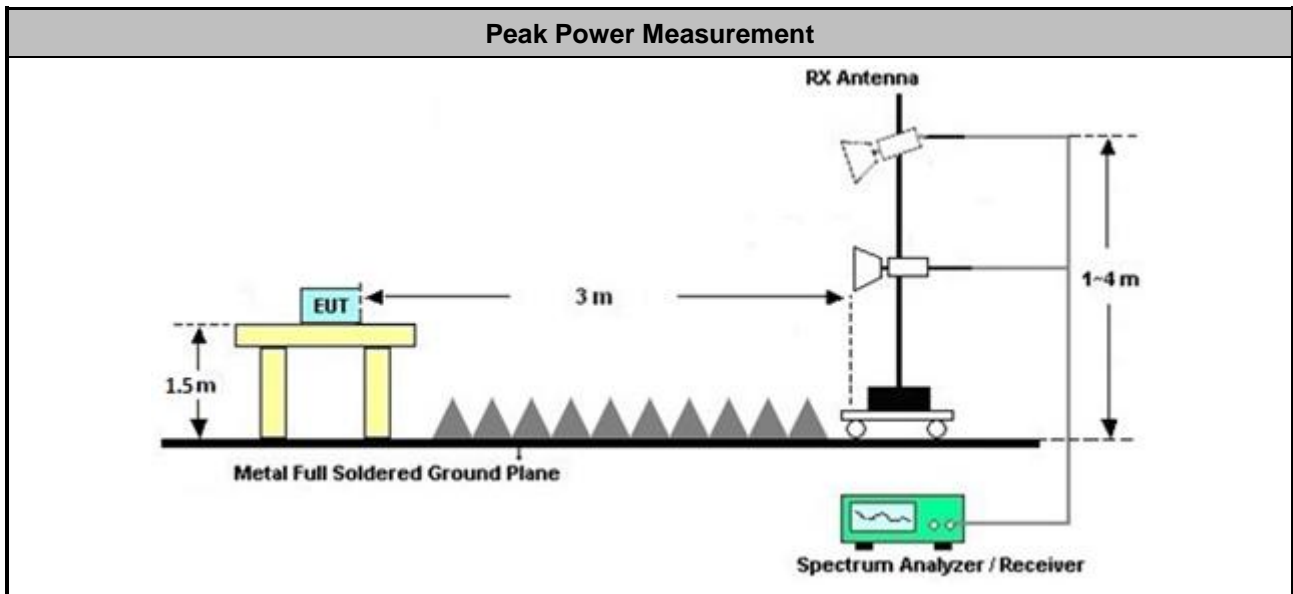



3.4.5 Test Result of Peak Power Measurement

Peak Measurement Result							
Test Mode	Freq. (MHz)	E-Field (dBuV/m)	ERIP _{50MHz} (dBm)	ERIP _{50MHz} Limit (dBm)	Margin (dB)	Result	Pol [H/V]
1	6491	93.78	-1.45	0	-1.45	Pass	H
2	7990	92.11	-3.12	0	-3.12	Pass	H
3	6737	93.82	-1.41	0	-1.41	Pass	V
4	7983	93.51	-1.72	0	-1.72	Pass	V
5	6487	92.78	-2.45	0	-2.45	Pass	H
6	7976	92.36	-2.87	0	-2.87	Pass	H
7	6740	94.94	-0.29	0	-0.29	Pass	V
8	7982	90.38	-4.85	0	-4.85	Pass	V
9	6738	88.30	-6.93	0	-6.93	Pass	H
10	7737	91.76	-3.47	0	-3.47	Pass	H
11	6739	94.36	-0.87	0	-0.87	Pass	V
12	7738	94.43	-0.80	0	-0.80	Pass	V
13	6490	88.22	-7.01	0	-7.01	Pass	H
14	7737	91.30	-3.93	0	-3.93	Pass	H
15	6744	94.71	-0.52	0	-0.52	Pass	V
16	7739	92.77	-2.46	0	-2.46	Pass	V
17	6486	86.87	-8.36	0	-8.36	Pass	H
18	7738	90.57	-4.66	0	-4.66	Pass	V
19	6738	94.85	-0.38	0	-0.38	Pass	V
20	8236	94.53	-0.70	0	-0.70	Pass	V
21	6740	89.29	-5.94	0	-5.94	Pass	H
22	7738	89.60	-5.63	0	-5.63	Pass	V
23	6742	94.41	-0.82	0	-0.82	Pass	V
24	7736	95.12	-0.11	0	-0.11	Pass	V
25	6491	85.95	-9.28	0	-9.28	Pass	H
26	7737	89.25	-5.98	0	-5.98	Pass	V
27	6741	92.18	-3.05	0	-3.05	Pass	V
28	7739	94.94	-0.29	0	-0.29	Pass	V

Note 1: EIRP [dBm] = E-Field [dBuV/m] - 95.23;
Note 2: Measurement worst emissions of receive antenna polarization.

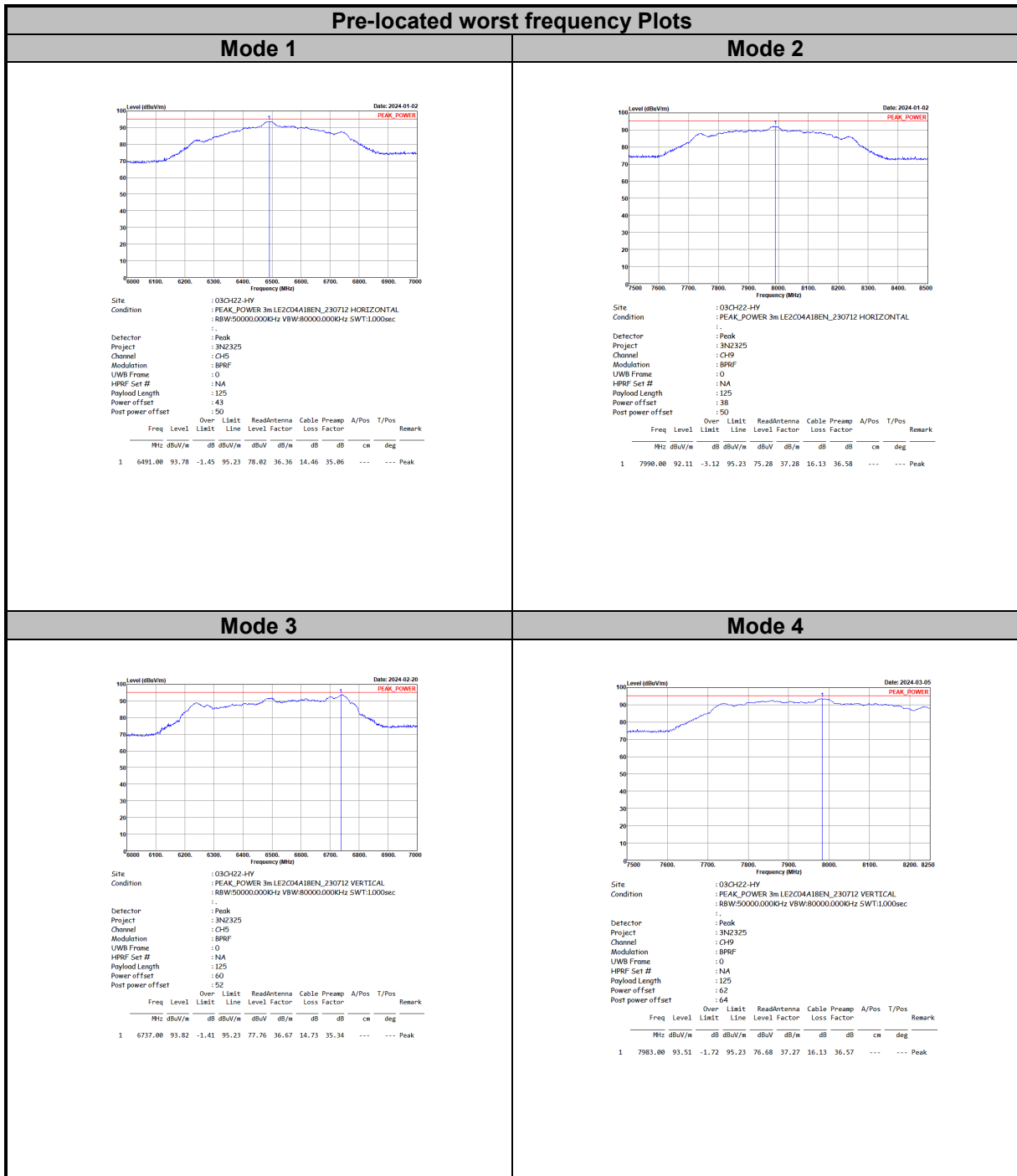



Pre-located worst frequency Plots																																																																	
Mode 5	Mode 6																																																																
<p>Date: 2024-01-02 PEAK_POWER</p> <p>Site Condition : :03CH22-HY :PEAK_POWER 3m LEZC04A18EN_230712 HORIZONTAL :RBW:50000.000kHz VBW:80000.000kHz SWT:1.000sec :</p> <p>Detector : :Peak Project : :3N2325 Channel : :CH9 Modulation : :BPRF UWB Frame : :1 HPRF Set # : :NA Payload Length : :125 Power offset : :40 Post power offset : :50</p> <table border="1"> <thead> <tr> <th>Over</th> <th>Limit</th> <th>ReadAntenna</th> <th>Cable</th> <th>Preamp</th> <th>A/Pos</th> <th>T/Pos</th> <th>Remark</th> </tr> <tr> <th>Freq</th> <th>Level</th> <th>Limit</th> <th>Line</th> <th>Level Factor</th> <th>Loss Factor</th> <th></th> <th></th> </tr> <tr> <th>MHz</th> <th>dBW/m</th> <th>dB</th> <th>dBW/m</th> <th>dBW</th> <th>dB/m</th> <th>dB</th> <th>cm deg</th> </tr> </thead> <tbody> <tr> <td>1</td> <td>6487.00</td> <td>92.78</td> <td>-2.45</td> <td>95.23</td> <td>77.04</td> <td>36.35</td> <td>14.45 35.06 --- --- Peak</td> </tr> </tbody> </table>	Over	Limit	ReadAntenna	Cable	Preamp	A/Pos	T/Pos	Remark	Freq	Level	Limit	Line	Level Factor	Loss Factor			MHz	dBW/m	dB	dBW/m	dBW	dB/m	dB	cm deg	1	6487.00	92.78	-2.45	95.23	77.04	36.35	14.45 35.06 --- --- Peak	<p>Date: 2024-01-02 PEAK_POWER</p> <p>Site Condition : :03CH22-HY :PEAK_POWER 3m LEZC04A18EN_230712 HORIZONTAL :RBW:50000.000kHz VBW:80000.000kHz SWT:1.000sec :</p> <p>Detector : :Peak Project : :3N2325 Channel : :CH9 Modulation : :BPRF UWB Frame : :1 HPRF Set # : :NA Payload Length : :125 Power offset : :43 Post power offset : :50</p> <table border="1"> <thead> <tr> <th>Over</th> <th>Limit</th> <th>ReadAntenna</th> <th>Cable</th> <th>Preamp</th> <th>A/Pos</th> <th>T/Pos</th> <th>Remark</th> </tr> <tr> <th>Freq</th> <th>Level</th> <th>Limit</th> <th>Line</th> <th>Level Factor</th> <th>Loss Factor</th> <th></th> <th></th> </tr> <tr> <th>MHz</th> <th>dBW/m</th> <th>dB</th> <th>dBW/m</th> <th>dBW</th> <th>dB/m</th> <th>dB</th> <th>cm deg</th> </tr> </thead> <tbody> <tr> <td>1</td> <td>7976.00</td> <td>92.36</td> <td>-2.87</td> <td>95.23</td> <td>75.55</td> <td>37.25</td> <td>16.12 36.56 --- --- Peak</td> </tr> </tbody> </table>	Over	Limit	ReadAntenna	Cable	Preamp	A/Pos	T/Pos	Remark	Freq	Level	Limit	Line	Level Factor	Loss Factor			MHz	dBW/m	dB	dBW/m	dBW	dB/m	dB	cm deg	1	7976.00	92.36	-2.87	95.23	75.55	37.25	16.12 36.56 --- --- Peak
Over	Limit	ReadAntenna	Cable	Preamp	A/Pos	T/Pos	Remark																																																										
Freq	Level	Limit	Line	Level Factor	Loss Factor																																																												
MHz	dBW/m	dB	dBW/m	dBW	dB/m	dB	cm deg																																																										
1	6487.00	92.78	-2.45	95.23	77.04	36.35	14.45 35.06 --- --- Peak																																																										
Over	Limit	ReadAntenna	Cable	Preamp	A/Pos	T/Pos	Remark																																																										
Freq	Level	Limit	Line	Level Factor	Loss Factor																																																												
MHz	dBW/m	dB	dBW/m	dBW	dB/m	dB	cm deg																																																										
1	7976.00	92.36	-2.87	95.23	75.55	37.25	16.12 36.56 --- --- Peak																																																										
Mode 7	Mode 8																																																																
<p>Date: 2024-01-02 PEAK_POWER</p> <p>Site Condition : :03CH22-HY :PEAK_POWER 3m LEZC04A18EN_230712 VERTICAL :</p> <p>Detector : :Peak Project : :3N2325 Channel : :CH9 Modulation : :BPRF UWB Frame : :1 HPRF Set # : :NA Payload Length : :125 Power offset : :60 Post power offset : :50</p> <table border="1"> <thead> <tr> <th>Over</th> <th>Limit</th> <th>ReadAntenna</th> <th>Cable</th> <th>Preamp</th> <th>A/Pos</th> <th>T/Pos</th> <th>Remark</th> </tr> <tr> <th>Freq</th> <th>Level</th> <th>Limit</th> <th>Line</th> <th>Level Factor</th> <th>Loss Factor</th> <th></th> <th></th> </tr> <tr> <th>MHz</th> <th>dBW/m</th> <th>dB</th> <th>dBW/m</th> <th>dBW</th> <th>dB/m</th> <th>dB</th> <th>cm deg</th> </tr> </thead> <tbody> <tr> <td>1</td> <td>6748.00</td> <td>94.94</td> <td>-0.29</td> <td>95.23</td> <td>78.86</td> <td>36.68</td> <td>14.74 35.34 --- --- Peak</td> </tr> </tbody> </table>	Over	Limit	ReadAntenna	Cable	Preamp	A/Pos	T/Pos	Remark	Freq	Level	Limit	Line	Level Factor	Loss Factor			MHz	dBW/m	dB	dBW/m	dBW	dB/m	dB	cm deg	1	6748.00	94.94	-0.29	95.23	78.86	36.68	14.74 35.34 --- --- Peak	<p>Date: 2024-02-20 PEAK_POWER</p> <p>Site Condition : :03CH22-HY :PEAK_POWER 3m LEZC04A18EN_230712 VERTICAL :RBW:50000.000kHz VBW:80000.000kHz SWT:1.000sec :</p> <p>Detector : :Peak Project : :3N2325 Channel : :CH9 Modulation : :BPRF UWB Frame : :1 HPRF Set # : :NA Payload Length : :125 Power offset : :63 Post power offset : :63</p> <table border="1"> <thead> <tr> <th>Over</th> <th>Limit</th> <th>ReadAntenna</th> <th>Cable</th> <th>Preamp</th> <th>A/Pos</th> <th>T/Pos</th> <th>Remark</th> </tr> <tr> <th>Freq</th> <th>Level</th> <th>Limit</th> <th>Line</th> <th>Level Factor</th> <th>Loss Factor</th> <th></th> <th></th> </tr> <tr> <th>MHz</th> <th>dBW/m</th> <th>dB</th> <th>dBW/m</th> <th>dBW</th> <th>dB/m</th> <th>dB</th> <th>cm deg</th> </tr> </thead> <tbody> <tr> <td>1</td> <td>7982.00</td> <td>90.38</td> <td>-4.85</td> <td>95.23</td> <td>73.56</td> <td>37.26</td> <td>16.13 36.57 --- --- Peak</td> </tr> </tbody> </table>	Over	Limit	ReadAntenna	Cable	Preamp	A/Pos	T/Pos	Remark	Freq	Level	Limit	Line	Level Factor	Loss Factor			MHz	dBW/m	dB	dBW/m	dBW	dB/m	dB	cm deg	1	7982.00	90.38	-4.85	95.23	73.56	37.26	16.13 36.57 --- --- Peak
Over	Limit	ReadAntenna	Cable	Preamp	A/Pos	T/Pos	Remark																																																										
Freq	Level	Limit	Line	Level Factor	Loss Factor																																																												
MHz	dBW/m	dB	dBW/m	dBW	dB/m	dB	cm deg																																																										
1	6748.00	94.94	-0.29	95.23	78.86	36.68	14.74 35.34 --- --- Peak																																																										
Over	Limit	ReadAntenna	Cable	Preamp	A/Pos	T/Pos	Remark																																																										
Freq	Level	Limit	Line	Level Factor	Loss Factor																																																												
MHz	dBW/m	dB	dBW/m	dBW	dB/m	dB	cm deg																																																										
1	7982.00	90.38	-4.85	95.23	73.56	37.26	16.13 36.57 --- --- Peak																																																										



Pre-located worst frequency Plots																																																																							
Mode 9	Mode 10																																																																						
<p>Date: 2024-01-02</p> <p>Site : 03CH22-HY Condition : PEAK_POWER 3m LE2C04A18EN_230712 HORIZONTAL</p> <p>Detector : Peak Project : 3N2325 Channel : CH9 Modulation : BPRF UWB Frame : 3 HRPF Set # : NA Payload Length : NA Power offset : 31 Post power offset : 50</p> <table border="1"> <thead> <tr> <th>Over</th> <th>Limit</th> <th>ReadAntenna</th> <th>Cable Preamp</th> <th>A/Pos</th> <th>T/Pos</th> <th>Remark</th> </tr> <tr> <th>Freq</th> <th>Level</th> <th>Line</th> <th>Level Factor</th> <th>Loss Factor</th> <th></th> <th></th> </tr> <tr> <th>MHz</th> <th>dBuV/m</th> <th>dB</th> <th>dBuV/m</th> <th>dBuV/m</th> <th>dB</th> <th>dB</th> <th>cm</th> <th>deg</th> </tr> </thead> <tbody> <tr> <td>1</td> <td>6738.00</td> <td>88.30</td> <td>-6.93</td> <td>95.23</td> <td>72.23</td> <td>36.68</td> <td>14.73</td> <td>35.34</td> <td>---</td> <td>---</td> <td>Peak</td> </tr> </tbody> </table>	Over	Limit	ReadAntenna	Cable Preamp	A/Pos	T/Pos	Remark	Freq	Level	Line	Level Factor	Loss Factor			MHz	dBuV/m	dB	dBuV/m	dBuV/m	dB	dB	cm	deg	1	6738.00	88.30	-6.93	95.23	72.23	36.68	14.73	35.34	---	---	Peak	<p>Date: 2024-01-02</p> <p>Site : 03CH22-HY Condition : PEAK_POWER 3m LE2C04A18EN_230712 HORIZONTAL</p> <p>Detector : Peak Project : 3N2325 Channel : CH9 Modulation : BPRF UWB Frame : 3 HRPF Set # : NA Payload Length : NA Power offset : 31 Post power offset : 50</p> <table border="1"> <thead> <tr> <th>Over</th> <th>Limit</th> <th>ReadAntenna</th> <th>Cable Preamp</th> <th>A/Pos</th> <th>T/Pos</th> <th>Remark</th> </tr> <tr> <th>Freq</th> <th>Level</th> <th>Line</th> <th>Level Factor</th> <th>Loss Factor</th> <th></th> <th></th> </tr> <tr> <th>MHz</th> <th>dBuV/m</th> <th>dB</th> <th>dBuV/m</th> <th>dBuV/m</th> <th>dB</th> <th>dB</th> <th>cm</th> <th>deg</th> </tr> </thead> <tbody> <tr> <td>1</td> <td>7737.00</td> <td>91.76</td> <td>-3.47</td> <td>95.23</td> <td>75.12</td> <td>37.00</td> <td>15.90</td> <td>36.26</td> <td>---</td> <td>---</td> <td>Peak</td> </tr> </tbody> </table>	Over	Limit	ReadAntenna	Cable Preamp	A/Pos	T/Pos	Remark	Freq	Level	Line	Level Factor	Loss Factor			MHz	dBuV/m	dB	dBuV/m	dBuV/m	dB	dB	cm	deg	1	7737.00	91.76	-3.47	95.23	75.12	37.00	15.90	36.26	---	---	Peak
Over	Limit	ReadAntenna	Cable Preamp	A/Pos	T/Pos	Remark																																																																	
Freq	Level	Line	Level Factor	Loss Factor																																																																			
MHz	dBuV/m	dB	dBuV/m	dBuV/m	dB	dB	cm	deg																																																															
1	6738.00	88.30	-6.93	95.23	72.23	36.68	14.73	35.34	---	---	Peak																																																												
Over	Limit	ReadAntenna	Cable Preamp	A/Pos	T/Pos	Remark																																																																	
Freq	Level	Line	Level Factor	Loss Factor																																																																			
MHz	dBuV/m	dB	dBuV/m	dBuV/m	dB	dB	cm	deg																																																															
1	7737.00	91.76	-3.47	95.23	75.12	37.00	15.90	36.26	---	---	Peak																																																												
<p>Date: 2024-01-02</p> <p>Site : 03CH22-HY Condition : PEAK_POWER 3m LE2C04A18EN_230712 VERTICAL</p> <p>Detector : Peak Project : 3N2325 Channel : CH9 Modulation : BPRF UWB Frame : 3 HRPF Set # : NA Payload Length : NA Power offset : 48 Post power offset : 50</p> <table border="1"> <thead> <tr> <th>Over</th> <th>Limit</th> <th>ReadAntenna</th> <th>Cable Preamp</th> <th>A/Pos</th> <th>T/Pos</th> <th>Remark</th> </tr> <tr> <th>Freq</th> <th>Level</th> <th>Line</th> <th>Level Factor</th> <th>Loss Factor</th> <th></th> <th></th> </tr> <tr> <th>MHz</th> <th>dBuV/m</th> <th>dB</th> <th>dBuV/m</th> <th>dBuV/m</th> <th>dB</th> <th>dB</th> <th>cm</th> <th>deg</th> </tr> </thead> <tbody> <tr> <td>1</td> <td>6739.00</td> <td>94.36</td> <td>-0.87</td> <td>95.23</td> <td>78.28</td> <td>36.68</td> <td>14.74</td> <td>35.34</td> <td>---</td> <td>---</td> <td>Peak</td> </tr> </tbody> </table>	Over	Limit	ReadAntenna	Cable Preamp	A/Pos	T/Pos	Remark	Freq	Level	Line	Level Factor	Loss Factor			MHz	dBuV/m	dB	dBuV/m	dBuV/m	dB	dB	cm	deg	1	6739.00	94.36	-0.87	95.23	78.28	36.68	14.74	35.34	---	---	Peak	<p>Date: 2024-01-02</p> <p>Site : 03CH22-HY Condition : PEAK_POWER 3m LE2C04A18EN_230712 VERTICAL</p> <p>Detector : Peak Project : 3N2325 Channel : CH9 Modulation : BPRF UWB Frame : 3 HRPF Set # : NA Payload Length : NA Power offset : 48 Post power offset : 50</p> <table border="1"> <thead> <tr> <th>Over</th> <th>Limit</th> <th>ReadAntenna</th> <th>Cable Preamp</th> <th>A/Pos</th> <th>T/Pos</th> <th>Remark</th> </tr> <tr> <th>Freq</th> <th>Level</th> <th>Line</th> <th>Level Factor</th> <th>Loss Factor</th> <th></th> <th></th> </tr> <tr> <th>MHz</th> <th>dBuV/m</th> <th>dB</th> <th>dBuV/m</th> <th>dBuV/m</th> <th>dB</th> <th>dB</th> <th>cm</th> <th>deg</th> </tr> </thead> <tbody> <tr> <td>1</td> <td>7738.00</td> <td>94.43</td> <td>-0.80</td> <td>95.23</td> <td>77.80</td> <td>37.00</td> <td>15.90</td> <td>36.27</td> <td>---</td> <td>---</td> <td>Peak</td> </tr> </tbody> </table>	Over	Limit	ReadAntenna	Cable Preamp	A/Pos	T/Pos	Remark	Freq	Level	Line	Level Factor	Loss Factor			MHz	dBuV/m	dB	dBuV/m	dBuV/m	dB	dB	cm	deg	1	7738.00	94.43	-0.80	95.23	77.80	37.00	15.90	36.27	---	---	Peak
Over	Limit	ReadAntenna	Cable Preamp	A/Pos	T/Pos	Remark																																																																	
Freq	Level	Line	Level Factor	Loss Factor																																																																			
MHz	dBuV/m	dB	dBuV/m	dBuV/m	dB	dB	cm	deg																																																															
1	6739.00	94.36	-0.87	95.23	78.28	36.68	14.74	35.34	---	---	Peak																																																												
Over	Limit	ReadAntenna	Cable Preamp	A/Pos	T/Pos	Remark																																																																	
Freq	Level	Line	Level Factor	Loss Factor																																																																			
MHz	dBuV/m	dB	dBuV/m	dBuV/m	dB	dB	cm	deg																																																															
1	7738.00	94.43	-0.80	95.23	77.80	37.00	15.90	36.27	---	---	Peak																																																												

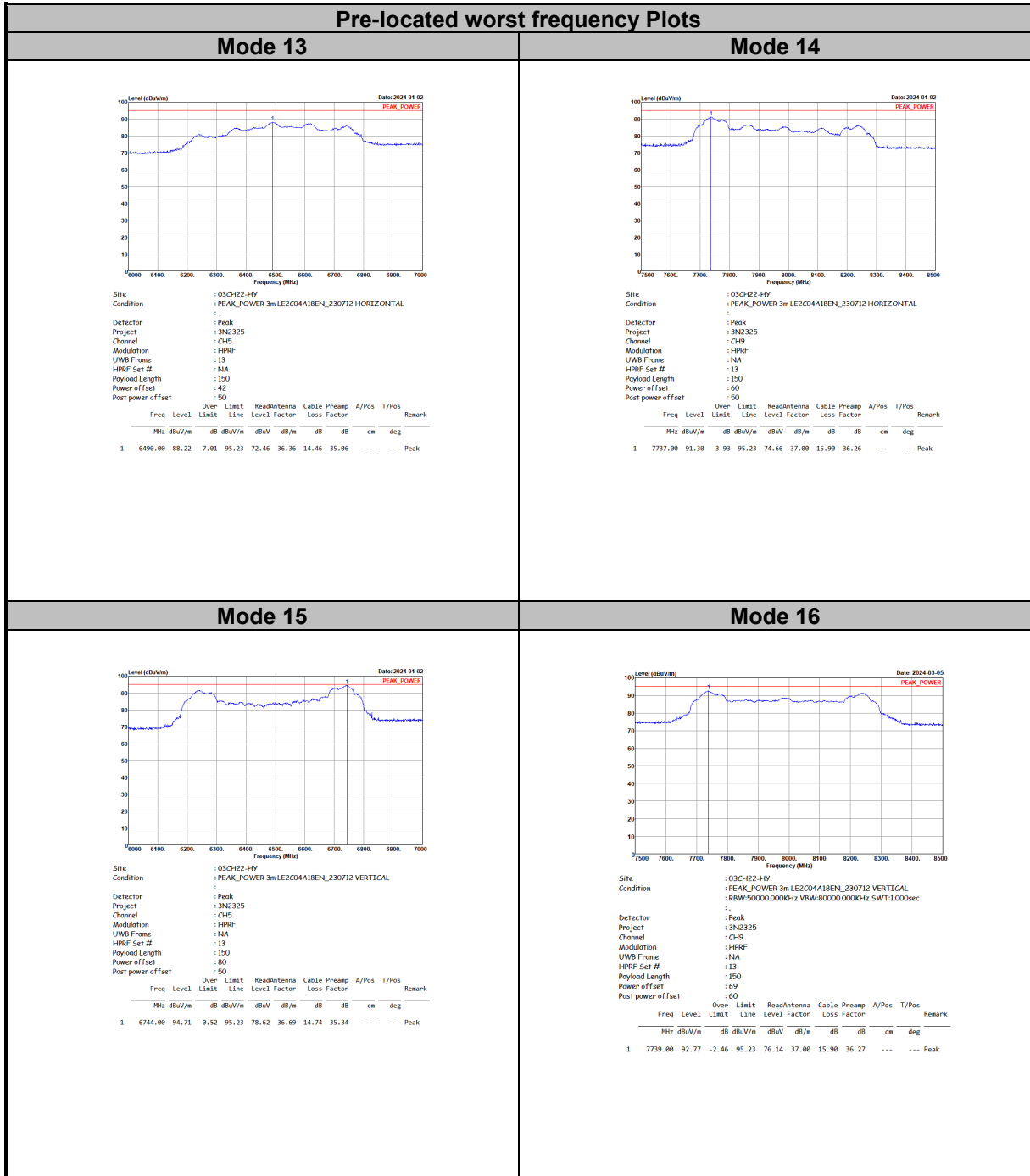



Pre-located worst frequency Plots																																																																			
<p style="text-align: center;">Mode 17</p> <p>Date: 2024-02-22</p> <p>Site : 03CH22-HY Condition : PEAK_POWER 3m LEZC0418EN_230712 HORIZONTAL : RBW:50000.000KHz VBW:80000.000KHz SWT:1.000sec</p> <p>Detector : Peak Project : 3N2325 Channel : CH5 Modulation : HPRF UWB Frame : NA HPRF Set # : 15 Payload Length : 150 Power offset : -48 Post power offset : -50</p> <table border="1"> <thead> <tr> <th>Over</th> <th>Limit</th> <th>ReadAntenna</th> <th>Cable</th> <th>Preamp</th> <th>A/Pos</th> <th>T/Pos</th> <th>Remark</th> </tr> <tr> <th>Freq</th> <th>Level</th> <th>Limit</th> <th>Line</th> <th>Level Factor</th> <th>Loss Factor</th> <th></th> <th></th> </tr> <tr> <th>MHz</th> <th>dBV/m</th> <th>dB</th> <th>dBV/m</th> <th>dBV/m</th> <th>dB</th> <th>dB</th> <th>cm deg</th> </tr> </thead> <tbody> <tr> <td>1</td> <td>6486.00</td> <td>86.87</td> <td>-8.36</td> <td>95.23</td> <td>71.14</td> <td>36.34</td> <td>14.45 35.86</td> <td>--- --- Peak</td> </tr> </tbody> </table>	Over	Limit	ReadAntenna	Cable	Preamp	A/Pos	T/Pos	Remark	Freq	Level	Limit	Line	Level Factor	Loss Factor			MHz	dBV/m	dB	dBV/m	dBV/m	dB	dB	cm deg	1	6486.00	86.87	-8.36	95.23	71.14	36.34	14.45 35.86	--- --- Peak	<p style="text-align: center;">Mode 18</p> <p>Date: 2024-02-22</p> <p>Site : 03CH22-HY Condition : PEAK_POWER 3m LEZC0418EN_230712 VERTICAL : RBW:50000.000KHz VBW:80000.000KHz SWT:1.000sec</p> <p>Detector : Peak Project : 3N2325 Channel : CH9 Modulation : HPRF UWB Frame : NA HPRF Set # : 15 Payload Length : 150 Power offset : -60 Post power offset : -50</p> <table border="1"> <thead> <tr> <th>Over</th> <th>Limit</th> <th>ReadAntenna</th> <th>Cable</th> <th>Preamp</th> <th>A/Pos</th> <th>T/Pos</th> <th>Remark</th> </tr> <tr> <th>Freq</th> <th>Level</th> <th>Limit</th> <th>Line</th> <th>Level Factor</th> <th>Loss Factor</th> <th></th> <th></th> </tr> <tr> <th>MHz</th> <th>dBV/m</th> <th>dB</th> <th>dBV/m</th> <th>dBV/m</th> <th>dB</th> <th>dB</th> <th>cm deg</th> </tr> </thead> <tbody> <tr> <td>1</td> <td>7738.00</td> <td>90.57</td> <td>-4.66</td> <td>95.23</td> <td>73.94</td> <td>37.00</td> <td>15.90 36.27</td> <td>--- --- Peak</td> </tr> </tbody> </table>	Over	Limit	ReadAntenna	Cable	Preamp	A/Pos	T/Pos	Remark	Freq	Level	Limit	Line	Level Factor	Loss Factor			MHz	dBV/m	dB	dBV/m	dBV/m	dB	dB	cm deg	1	7738.00	90.57	-4.66	95.23	73.94	37.00	15.90 36.27	--- --- Peak
Over	Limit	ReadAntenna	Cable	Preamp	A/Pos	T/Pos	Remark																																																												
Freq	Level	Limit	Line	Level Factor	Loss Factor																																																														
MHz	dBV/m	dB	dBV/m	dBV/m	dB	dB	cm deg																																																												
1	6486.00	86.87	-8.36	95.23	71.14	36.34	14.45 35.86	--- --- Peak																																																											
Over	Limit	ReadAntenna	Cable	Preamp	A/Pos	T/Pos	Remark																																																												
Freq	Level	Limit	Line	Level Factor	Loss Factor																																																														
MHz	dBV/m	dB	dBV/m	dBV/m	dB	dB	cm deg																																																												
1	7738.00	90.57	-4.66	95.23	73.94	37.00	15.90 36.27	--- --- Peak																																																											
<p style="text-align: center;">Mode 19</p> <p>Date: 2024-02-22</p> <p>Site : 03CH22-HY Condition : PEAK_POWER 3m LEZC0418EN_230712 VERTICAL : RBW:50000.000KHz VBW:80000.000KHz SWT:1.000sec</p> <p>Detector : Peak Project : 3N2325 Channel : CH5 Modulation : HPRF UWB Frame : NA HPRF Set # : 15 Payload Length : 150 Power offset : -70 Post power offset : -54</p> <table border="1"> <thead> <tr> <th>Over</th> <th>Limit</th> <th>ReadAntenna</th> <th>Cable</th> <th>Preamp</th> <th>A/Pos</th> <th>T/Pos</th> <th>Remark</th> </tr> <tr> <th>Freq</th> <th>Level</th> <th>Limit</th> <th>Line</th> <th>Level Factor</th> <th>Loss Factor</th> <th></th> <th></th> </tr> <tr> <th>MHz</th> <th>dBV/m</th> <th>dB</th> <th>dBV/m</th> <th>dBV/m</th> <th>dB</th> <th>dB</th> <th>cm deg</th> </tr> </thead> <tbody> <tr> <td>1</td> <td>6738.00</td> <td>94.85</td> <td>-0.38</td> <td>95.23</td> <td>78.78</td> <td>36.68</td> <td>14.73 35.34</td> <td>--- --- Peak</td> </tr> </tbody> </table>	Over	Limit	ReadAntenna	Cable	Preamp	A/Pos	T/Pos	Remark	Freq	Level	Limit	Line	Level Factor	Loss Factor			MHz	dBV/m	dB	dBV/m	dBV/m	dB	dB	cm deg	1	6738.00	94.85	-0.38	95.23	78.78	36.68	14.73 35.34	--- --- Peak	<p style="text-align: center;">Mode 20</p> <p>Date: 2024-01-02</p> <p>Site : 03CH22-HY Condition : PEAK_POWER 3m LEZC0418EN_230712 VERTICAL : RBW:50000.000KHz VBW:80000.000KHz SWT:1.000sec</p> <p>Detector : Peak Project : 3N2325 Channel : CH9 Modulation : HPRF UWB Frame : NA HPRF Set # : 15 Payload Length : 150 Power offset : -63 Post power offset : -50</p> <table border="1"> <thead> <tr> <th>Over</th> <th>Limit</th> <th>ReadAntenna</th> <th>Cable</th> <th>Preamp</th> <th>A/Pos</th> <th>T/Pos</th> <th>Remark</th> </tr> <tr> <th>Freq</th> <th>Level</th> <th>Limit</th> <th>Line</th> <th>Level Factor</th> <th>Loss Factor</th> <th></th> <th></th> </tr> <tr> <th>MHz</th> <th>dBV/m</th> <th>dB</th> <th>dBV/m</th> <th>dBV/m</th> <th>dB</th> <th>dB</th> <th>cm deg</th> </tr> </thead> <tbody> <tr> <td>1</td> <td>8236.00</td> <td>94.53</td> <td>-0.70</td> <td>95.23</td> <td>77.91</td> <td>37.17</td> <td>16.29 36.84</td> <td>100 13 Peak</td> </tr> </tbody> </table>	Over	Limit	ReadAntenna	Cable	Preamp	A/Pos	T/Pos	Remark	Freq	Level	Limit	Line	Level Factor	Loss Factor			MHz	dBV/m	dB	dBV/m	dBV/m	dB	dB	cm deg	1	8236.00	94.53	-0.70	95.23	77.91	37.17	16.29 36.84	100 13 Peak
Over	Limit	ReadAntenna	Cable	Preamp	A/Pos	T/Pos	Remark																																																												
Freq	Level	Limit	Line	Level Factor	Loss Factor																																																														
MHz	dBV/m	dB	dBV/m	dBV/m	dB	dB	cm deg																																																												
1	6738.00	94.85	-0.38	95.23	78.78	36.68	14.73 35.34	--- --- Peak																																																											
Over	Limit	ReadAntenna	Cable	Preamp	A/Pos	T/Pos	Remark																																																												
Freq	Level	Limit	Line	Level Factor	Loss Factor																																																														
MHz	dBV/m	dB	dBV/m	dBV/m	dB	dB	cm deg																																																												
1	8236.00	94.53	-0.70	95.23	77.91	37.17	16.29 36.84	100 13 Peak																																																											



Pre-located worst frequency Plots

Mode 21

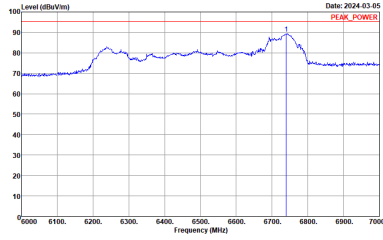

Site : 03CH22-HY
Condition : PEAK_POWER 3m LEZ00418EN_230712 HORIZONTAL
: RBW:50000.000KHz VBW:80000.000KHz SWT:1.000sec

Detector : Peak
Project : 3N2325
Channel : CH5
Modulation : HPRF
UWB Frame : NA
HPRF Set # : 21
Payload Length : NA
Power offset : 62
Post power offset : 50

Over	Limit	ReadAntenna	Cable	Preamp	A/Pos	T/Pos	Remark				
Freq	Level	Limit	Line	Level	Factor	Loss	Factor				
MHz	dBuV/m	dB	dBuV/m	dBuV	dB/m	dB	dB	cm	deg		
1	6740.00	89.29	-5.94	95.23	73.21	36.68	14.74	35.34	110	116	Peak

Mode 22

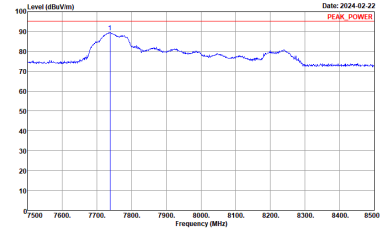

Site : 03CH22-HY
Condition : PEAK_POWER 3m LEZ00418EN_230712 VERTICAL
: RBW:50000.000KHz VBW:80000.000KHz SWT:1.000sec

Detector : Peak
Project : 3N2325
Channel : CH9
Modulation : HPRF
UWB Frame : NA
HPRF Set # : 21
Payload Length : NA
Power offset : 60
Post power offset : 50

Over	Limit	ReadAntenna	Cable	Preamp	A/Pos	T/Pos	Remark				
Freq	Level	Limit	Line	Level	Factor	Loss	Factor				
MHz	dBuV/m	dB	dBuV/m	dBuV	dB/m	dB	dB	cm	deg		
1	7738.00	89.68	-5.63	95.23	72.97	37.00	15.90	36.27	---	---	Peak

Mode 23

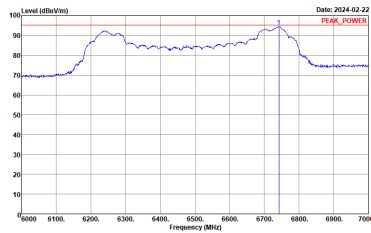

Site : 03CH22-HY
Condition : PEAK_POWER 3m LEZ00418EN_230712 VERTICAL
: RBW:50000.000KHz VBW:80000.000KHz SWT:1.000sec

Detector : Peak
Project : 3N2325
Channel : CH5
Modulation : HPRF
UWB Frame : NA
HPRF Set # : 21
Payload Length : NA
Power offset : 71
Post power offset : 50

Over	Limit	ReadAntenna	Cable	Preamp	A/Pos	T/Pos	Remark				
Freq	Level	Limit	Line	Level	Factor	Loss	Factor				
MHz	dBuV/m	dB	dBuV/m	dBuV	dB/m	dB	dB	cm	deg		
1	6742.00	94.41	-0.82	95.23	78.33	36.68	14.74	35.34	---	---	Peak

Mode 24

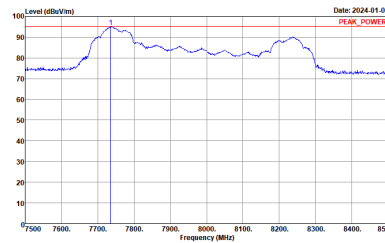

Site : 03CH22-HY
Condition : PEAK_POWER 3m LEZ00418EN_230712 VERTICAL
: RBW:50000.000KHz VBW:80000.000KHz SWT:1.000sec

Detector : Peak
Project : 3N2325
Channel : CH9
Modulation : HPRF
UWB Frame : NA
HPRF Set # : 21
Payload Length : NA
Power offset : 63
Post power offset : 51

Over	Limit	ReadAntenna	Cable	Preamp	A/Pos	T/Pos	Remark				
Freq	Level	Limit	Line	Level	Factor	Loss	Factor				
MHz	dBuV/m	dB	dBuV/m	dBuV	dB/m	dB	dB	cm	deg		
1	7736.00	95.12	-0.11	95.23	78.48	37.00	15.90	36.26	217	5	Peak



Pre-located worst frequency Plots																																																																	
Mode 25	Mode 26																																																																
<p>Date: 2024-02-22</p> <p>Site Condition : 03CH22-HY : PEAK_POWER 3m LEZC04A1BEN_230712 HORIZONTAL : RBW:50000.000KHz VBW:80000.000KHz SWT:1.000sec</p> <p>Detector : Peak Project : 3N2325 Channel : CH5 Modulation : HPRF UWB Frame : NA HPRF Set # : 31 Payload Length : NA Power offset : 31 Post power offset : 50</p> <table border="1"> <thead> <tr> <th>Over</th> <th>Limit</th> <th>ReadAntenna</th> <th>Cable</th> <th>Preamp</th> <th>A/Pos</th> <th>T/Pos</th> <th>Remark</th> </tr> <tr> <th>Freq</th> <th>Level</th> <th>Limit</th> <th>Line</th> <th>Level Factor</th> <th>Loss Factor</th> <th></th> <th></th> </tr> <tr> <th>MHz</th> <th>dBV/m</th> <th>dB</th> <th>dBV/m</th> <th>dBV/m</th> <th>dB</th> <th>dB</th> <th>cm deg</th> </tr> </thead> <tbody> <tr> <td>1</td> <td>6491.00</td> <td>85.95</td> <td>-9.28</td> <td>95.23</td> <td>70.19</td> <td>36.36</td> <td>14.46 35.06 --- --- Peak</td> </tr> </tbody> </table>	Over	Limit	ReadAntenna	Cable	Preamp	A/Pos	T/Pos	Remark	Freq	Level	Limit	Line	Level Factor	Loss Factor			MHz	dBV/m	dB	dBV/m	dBV/m	dB	dB	cm deg	1	6491.00	85.95	-9.28	95.23	70.19	36.36	14.46 35.06 --- --- Peak	<p>Date: 2024-02-22</p> <p>Site Condition : 03CH22-HY : PEAK_POWER 3m LEZC04A1BEN_230712 VERTICAL : RBW:50000.000KHz VBW:80000.000KHz SWT:1.000sec</p> <p>Detector : Peak Project : 3N2325 Channel : CH9 Modulation : HPRF UWB Frame : NA HPRF Set # : 31 Payload Length : NA Power offset : 30 Post power offset : 50</p> <table border="1"> <thead> <tr> <th>Over</th> <th>Limit</th> <th>ReadAntenna</th> <th>Cable</th> <th>Preamp</th> <th>A/Pos</th> <th>T/Pos</th> <th>Remark</th> </tr> <tr> <th>Freq</th> <th>Level</th> <th>Limit</th> <th>Line</th> <th>Level Factor</th> <th>Loss Factor</th> <th></th> <th></th> </tr> <tr> <th>MHz</th> <th>dBV/m</th> <th>dB</th> <th>dBV/m</th> <th>dBV/m</th> <th>dB</th> <th>dB</th> <th>cm deg</th> </tr> </thead> <tbody> <tr> <td>1</td> <td>7737.00</td> <td>89.25</td> <td>-5.98</td> <td>95.23</td> <td>72.61</td> <td>37.00</td> <td>15.90 36.26 --- --- Peak</td> </tr> </tbody> </table>	Over	Limit	ReadAntenna	Cable	Preamp	A/Pos	T/Pos	Remark	Freq	Level	Limit	Line	Level Factor	Loss Factor			MHz	dBV/m	dB	dBV/m	dBV/m	dB	dB	cm deg	1	7737.00	89.25	-5.98	95.23	72.61	37.00	15.90 36.26 --- --- Peak
Over	Limit	ReadAntenna	Cable	Preamp	A/Pos	T/Pos	Remark																																																										
Freq	Level	Limit	Line	Level Factor	Loss Factor																																																												
MHz	dBV/m	dB	dBV/m	dBV/m	dB	dB	cm deg																																																										
1	6491.00	85.95	-9.28	95.23	70.19	36.36	14.46 35.06 --- --- Peak																																																										
Over	Limit	ReadAntenna	Cable	Preamp	A/Pos	T/Pos	Remark																																																										
Freq	Level	Limit	Line	Level Factor	Loss Factor																																																												
MHz	dBV/m	dB	dBV/m	dBV/m	dB	dB	cm deg																																																										
1	7737.00	89.25	-5.98	95.23	72.61	37.00	15.90 36.26 --- --- Peak																																																										
<p>Date: 2024-02-21</p> <p>Site Condition : 03CH22-HY : PEAK_POWER 3m LEZC04A1BEN_230712 VERTICAL : RBW:50000.000KHz VBW:80000.000KHz SWT:1.000sec</p> <p>Detector : Peak Project : 3N2325 Channel : CH5 Modulation : HPRF UWB Frame : NA HPRF Set # : 31 Payload Length : NA Power offset : 54 Post power offset : 57</p> <table border="1"> <thead> <tr> <th>Over</th> <th>Limit</th> <th>ReadAntenna</th> <th>Cable</th> <th>Preamp</th> <th>A/Pos</th> <th>T/Pos</th> <th>Remark</th> </tr> <tr> <th>Freq</th> <th>Level</th> <th>Limit</th> <th>Line</th> <th>Level Factor</th> <th>Loss Factor</th> <th></th> <th></th> </tr> <tr> <th>MHz</th> <th>dBV/m</th> <th>dB</th> <th>dBV/m</th> <th>dBV/m</th> <th>dB</th> <th>dB</th> <th>cm deg</th> </tr> </thead> <tbody> <tr> <td>1</td> <td>6741.00</td> <td>92.18</td> <td>-3.05</td> <td>95.23</td> <td>76.10</td> <td>36.68</td> <td>14.74 35.34 --- --- Peak</td> </tr> </tbody> </table>	Over	Limit	ReadAntenna	Cable	Preamp	A/Pos	T/Pos	Remark	Freq	Level	Limit	Line	Level Factor	Loss Factor			MHz	dBV/m	dB	dBV/m	dBV/m	dB	dB	cm deg	1	6741.00	92.18	-3.05	95.23	76.10	36.68	14.74 35.34 --- --- Peak	<p>Date: 2024-01-02</p> <p>Site Condition : 03CH22-HY : PEAK_POWER 3m LEZC04A1BEN_230712 VERTICAL : RBW:50000.000KHz VBW:80000.000KHz SWT:1.000sec</p> <p>Detector : Peak Project : 3N2325 Channel : CH9 Modulation : HPRF UWB Frame : NA HPRF Set # : 31 Payload Length : NA Power offset : 52 Post power offset : 50</p> <table border="1"> <thead> <tr> <th>Over</th> <th>Limit</th> <th>ReadAntenna</th> <th>Cable</th> <th>Preamp</th> <th>A/Pos</th> <th>T/Pos</th> <th>Remark</th> </tr> <tr> <th>Freq</th> <th>Level</th> <th>Limit</th> <th>Line</th> <th>Level Factor</th> <th>Loss Factor</th> <th></th> <th></th> </tr> <tr> <th>MHz</th> <th>dBV/m</th> <th>dB</th> <th>dBV/m</th> <th>dBV/m</th> <th>dB</th> <th>dB</th> <th>cm deg</th> </tr> </thead> <tbody> <tr> <td>1</td> <td>7739.00</td> <td>94.04</td> <td>-0.29</td> <td>95.23</td> <td>78.31</td> <td>37.00</td> <td>15.90 36.27 236 0 Peak</td> </tr> </tbody> </table>	Over	Limit	ReadAntenna	Cable	Preamp	A/Pos	T/Pos	Remark	Freq	Level	Limit	Line	Level Factor	Loss Factor			MHz	dBV/m	dB	dBV/m	dBV/m	dB	dB	cm deg	1	7739.00	94.04	-0.29	95.23	78.31	37.00	15.90 36.27 236 0 Peak
Over	Limit	ReadAntenna	Cable	Preamp	A/Pos	T/Pos	Remark																																																										
Freq	Level	Limit	Line	Level Factor	Loss Factor																																																												
MHz	dBV/m	dB	dBV/m	dBV/m	dB	dB	cm deg																																																										
1	6741.00	92.18	-3.05	95.23	76.10	36.68	14.74 35.34 --- --- Peak																																																										
Over	Limit	ReadAntenna	Cable	Preamp	A/Pos	T/Pos	Remark																																																										
Freq	Level	Limit	Line	Level Factor	Loss Factor																																																												
MHz	dBV/m	dB	dBV/m	dBV/m	dB	dB	cm deg																																																										
1	7739.00	94.04	-0.29	95.23	78.31	37.00	15.90 36.27 236 0 Peak																																																										



3.5 Radiated Emissions

3.5.1 Radiated Emissions Limit

Radiated Emissions below 960MHz and Emissions from Digital Circuitry Limit			
Frequency Range (MHz)	Field Strength (uV/m)	Field Strength (dBuV/m)	Measure Distance (m)
0.009~0.490	2400/F(kHz)	48.5 - 13.8	300
0.490~1.705	24000/F(kHz)	33.8 - 23	30
1.705~30.0	30	29	30
30~88	100	40	3
88~216	150	43.5	3
216~960	200	46	3
Above 960	500	54	3

Note 1: Test distance for frequencies at or above 30 MHz, measurements may be performed at a distance other than the limit distance provided they are not performed in the near field and the emissions to be measured can be detected by the measurement equipment. When performing measurements at a distance other than that specified, the results shall be extrapolated to the specified distance using an extrapolation factor of 20 dB/decade (inverse of linear distance for field-strength measurements, inverse of linear distance-squared for power-density measurements).

Note 2: Test distance for frequencies at below 30 MHz, measurements may be performed at a distance closer than the EUT limit distance; however, an attempt should be made to avoid making measurements in the near field. When performing measurements below 30 MHz at a closer distance than the limit distance, the results shall be extrapolated to the specified distance by either making measurements at a minimum of two or more distances on at least one radial to determine the proper extrapolation factor or by using the square of an inverse linear distance extrapolation factor (40 dB/decade). The test report shall specify the extrapolation method used to determine compliance of the EUT.

Radiated Emissions above 960MHz Limit	
Frequency Range (MHz)	EIRP (dBm), RBW = 1MHz
960-1610	-75.3
1610-1990	-63.3
1990-3100	-61.3
3100-10600	-41.3
Above 10600	-61.3

Note: Distance extrapolation factor = 20 log (test distance [X m]/specific distance [3 m]) (dB)

Radiated Emissions in GPS Bands Limit	
Frequency Range (MHz)	EIRP (dBm), RBW ≥ 1kHz
1164-1240	-85.3
1559-1610	-85.3

Note E (dBuV/m) = EIRP (dBm) + 95.23, example, E(dBuV/m) = -85.3 + 95.23 = 9.93dBuV/m



3.5.2 Measuring Instruments

Refer a test equipment and calibration data table in this test report.

3.5.3 Test Procedures

Test Method for Radiated Emissions above 960MHz	
<ul style="list-style-type: none"> ■ Radiated Emissions above 960MHz 	
■	Refer as ANSI C63.10, clause 10.3.1 for radiated measurement procedure testing.
■	Refer as ANSI C63.10, clause 10.3.2 for measurement distance is 3m. In some cases, it may be necessary to measure the radiated UWB emissions at a closer distance to obtain enough signal and margin to overcome the measurement system noise floor. Distance extrapolation factor = 20 log (test distance [X m]/specific distance [3 m]) (dB)
■	Refer as ANSI C63.10, clause 10.3.4 for rms detector procedure testing.
■	Refer as ANSI C63.10, clause 10.3.7 for evaluating AVG-PSD (RBW=1MHz).
■	Refer as ANSI C63.10, clause 10.3.10 for evaluating AVG-PSD in GPS Band (RBW≥1kHz).
<ul style="list-style-type: none"> ■ For radiated measurement. 	
■	Refer as ANSI C63.10, clause 10.3.8 following eirp can be used radiated test configuration.
■	Refer as ANSI C63.10, clause 10.3.9 following eirp can be directly determined using the field strength.

Test Method for Radiated Emissions below 960MHz and Emissions from Digital Circuitry	
<ul style="list-style-type: none"> ■ Measurements may be performed at a distance other than the limit distance provided they are not performed in the near field and the emissions to be measured can be detected by the measurement equipment. When performing measurements at a distance other than that specified, the results shall be extrapolated to the specified distance using an extrapolation factor of 20 dB/decade (inverse of linear distance for field-strength measurements, inverse of linear distance-squared for power-density measurements) for above 30MHz-960MHz; 40dB/decade for frequency below 30MHz. 	
<ul style="list-style-type: none"> ■ For the transmitter unwanted emissions shall be measured using following options below: 	
■	Refer as ANSI C63.10, clause 4.1.4 Detector functions and selection of bandwidth
□	Refer as ANSI C63.10, clause 4.1.4.2.4 average value of pulsed emissions. Adjusted by a “duty cycle correction factor”, derived from 20log (dwell time/100 ms). Average emission = peak emission + 20 log (duty cycle).
■	Refer as ANSI C63.10, clause 4.1.4.2.2 measurement procedure peak limit.
<ul style="list-style-type: none"> ■ For radiated measurement. 	
■	Refer as ANSI C63.10, clause 6.4 for radiated emissions below 30 MHz and test distance is 3m.
■	Refer as ANSI C63.10, clause 6.5 for radiated emissions 30 MHz to 1 GHz and test distance is 3m.
■	Refer as ANSI C63.10, clause 6.6 for radiated emissions above 1 GHz and test distance is 3m.
■	If the noise floor can't meet the limit, the test distance will be shorten and described in the report.
<ul style="list-style-type: none"> ■ Any unwanted emissions level shall not exceed the fundamental emission level. 	

3.5.4 Test Setup

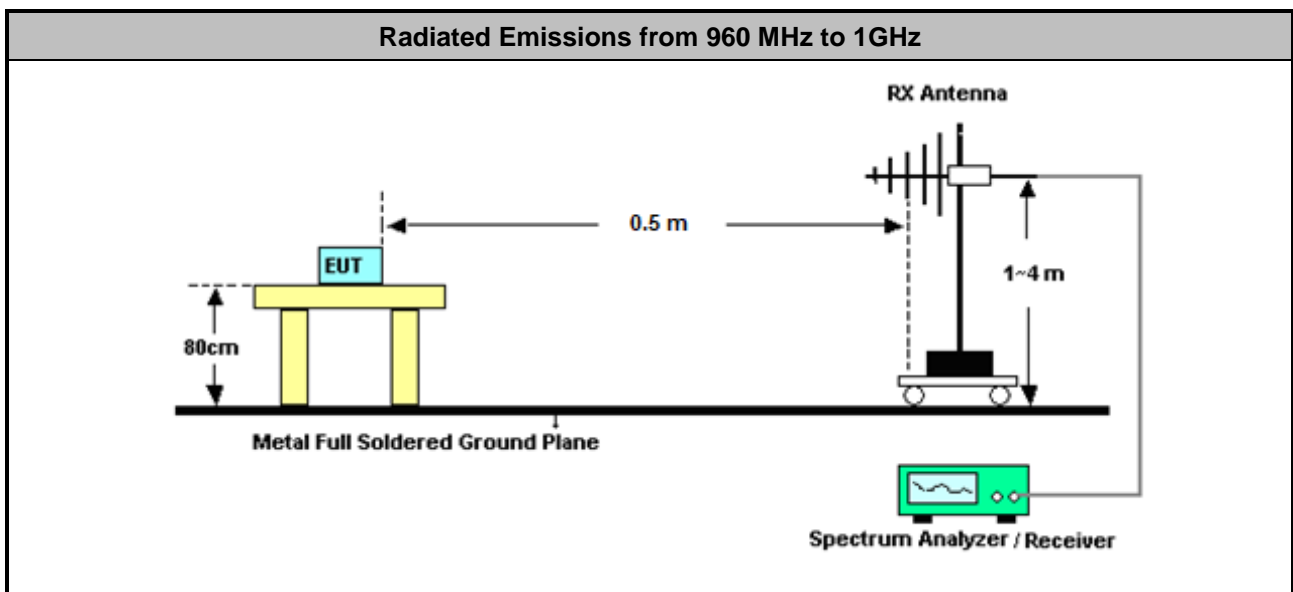
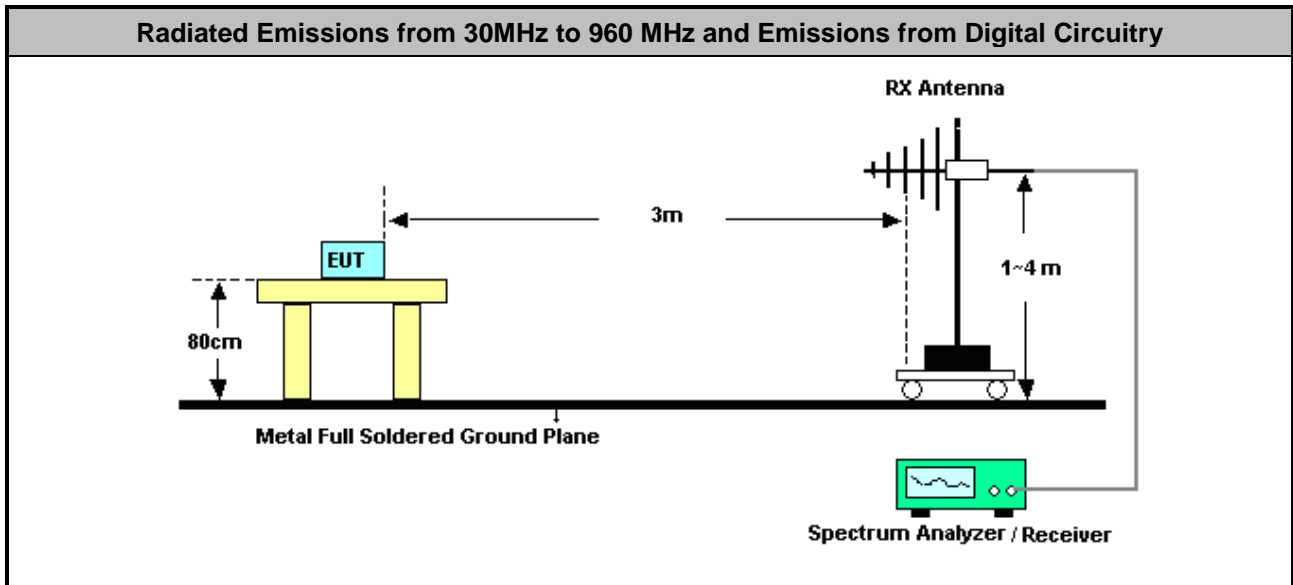
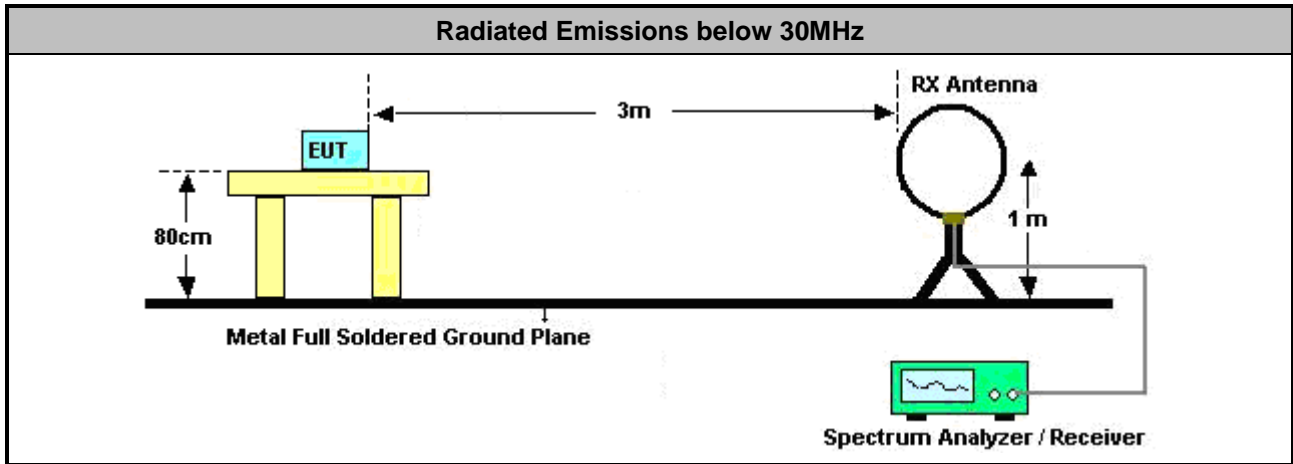

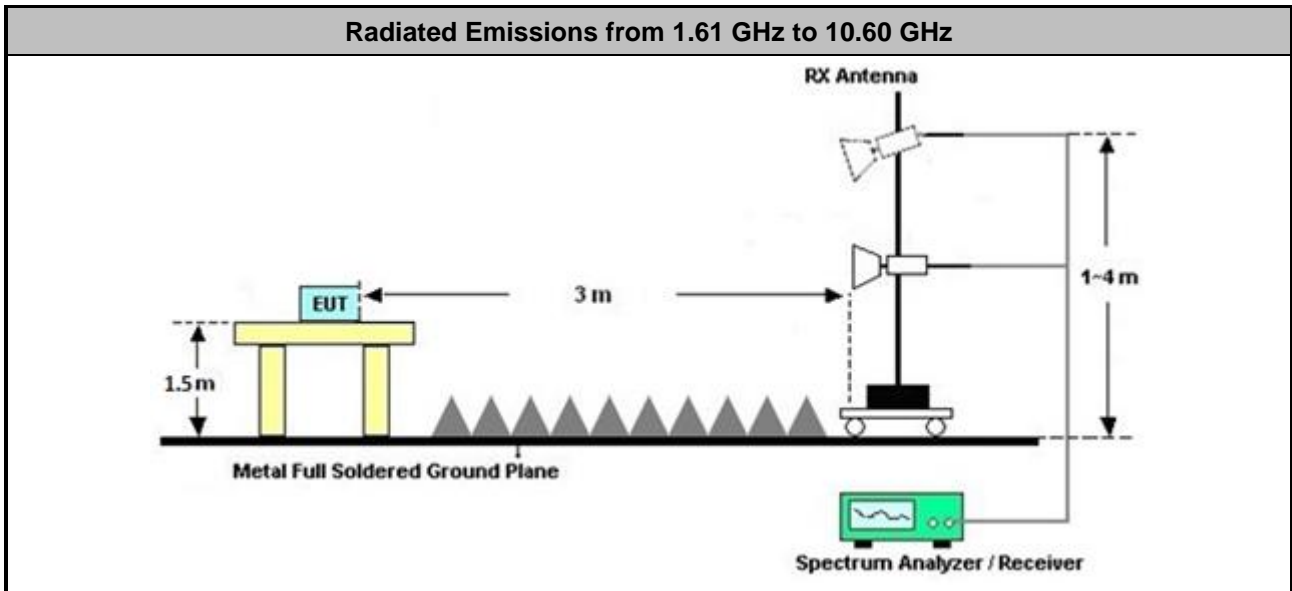
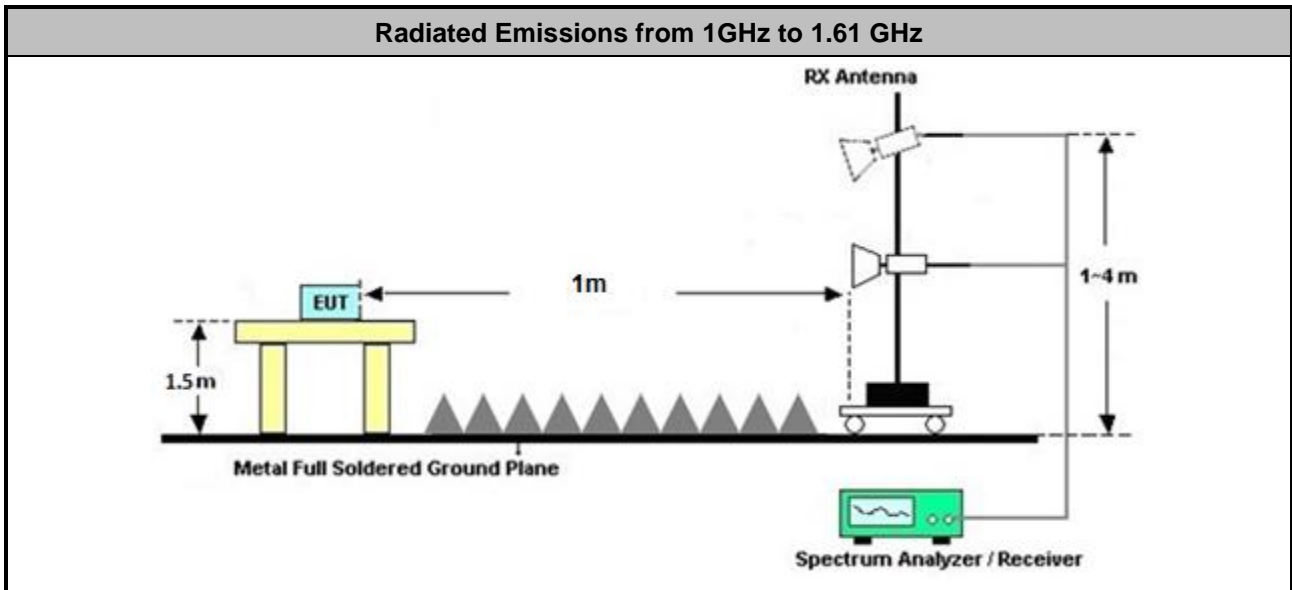

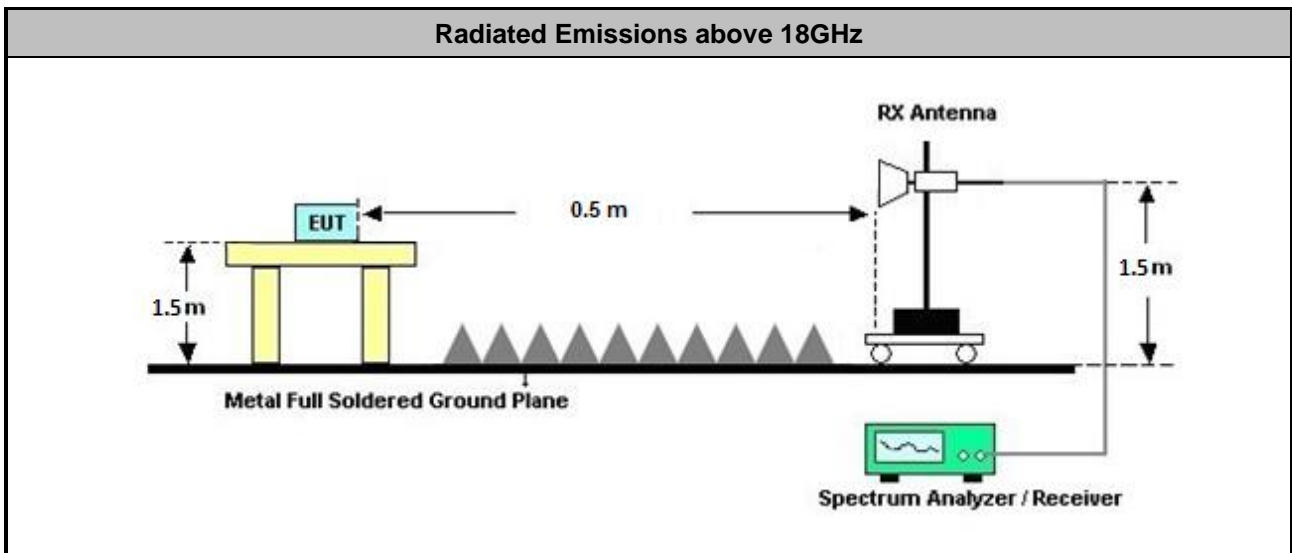
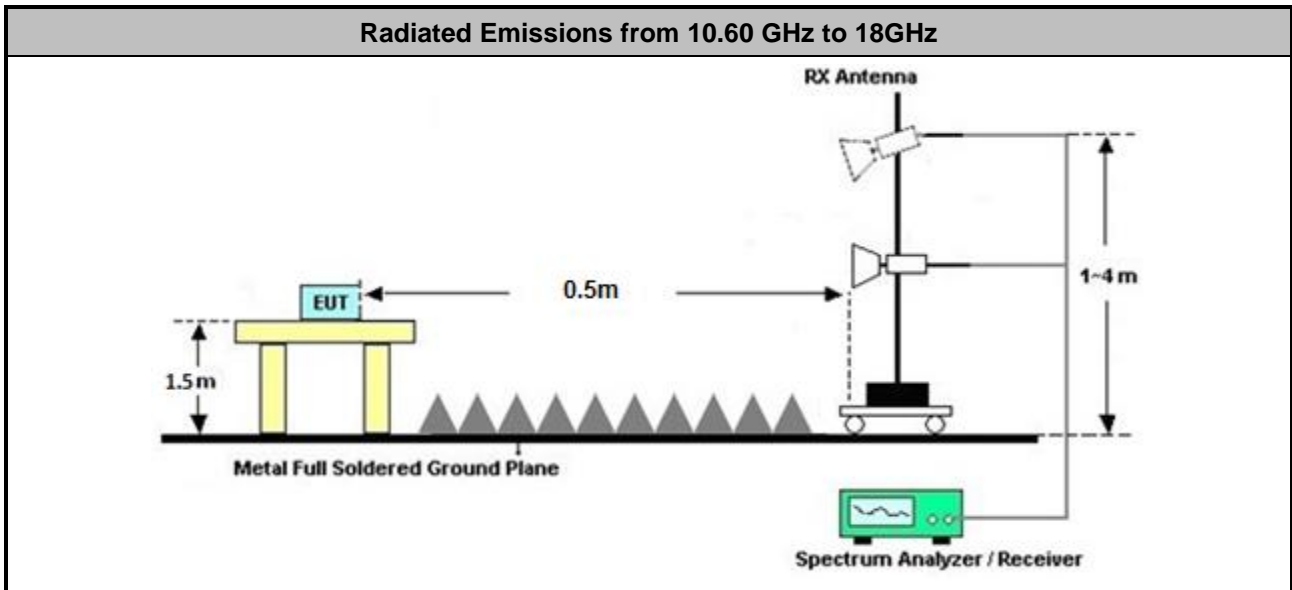

Note 1: Magnetic field tests shall be performed in the frequency range of 9 kHz to 30 MHz using a calibrated loop antenna. Electric field tests shall be performed in the frequency range of 30 MHz to 1000 MHz using a calibrated bi-log antenna and the frequency range of 1 GHz to 40 GHz using a calibrated horn antenna.
 Note 2: If test distance other than 3m is used, the used test distance will be recorded in test result.

3.5.5 Radiated Emissions (Below 30MHz)

All amplitude of spurious emissions that are attenuated by more than 20 dB below the permissible value has no need to be reported.

There is adequate comparison measurement of both open-field test site and alternative test site - semi-Anechoic chamber according to 414788 D01 Radiated Test Site v01r01, and the result came out very similar.

**3.5.6 Average Power Spectral Density**

Test mode	Frequency (MHz)	Emission Level (dBuV/m)	Emission Limit (dBm/MHz)	Emission Limit (dBuV/m)	Margin (dB)	Result	Pol [H/V]
1	6466	53.79	-41.3	53.93	-0.14	Pass	H
2	7956	53.76	-41.3	53.93	-0.17	Pass	H
3	6630	53.69	-41.3	53.93	-0.24	Pass	V
4	7847	53.80	-41.3	53.93	-0.13	Pass	V
5	6451	53.59	-41.3	53.93	-0.34	Pass	H
6	7831	53.70	-41.3	53.93	-0.23	Pass	V
7	6591	53.76	-41.3	53.93	-0.17	Pass	V
8	7847	49.21	-41.3	53.93	-4.72	Pass	V
9	6461	53.80	-41.3	53.93	-0.13	Pass	H
10	7855	53.50	-41.3	53.93	-0.43	Pass	V
11	6618	53.39	-41.3	53.93	-0.54	Pass	V
12	7844	53.72	-41.3	53.93	-0.21	Pass	H
13	6521	53.59	-41.3	53.93	-0.34	Pass	H
14	7847	53.81	-41.3	53.93	-0.12	Pass	V
15	6586	53.82	-41.3	53.93	-0.11	Pass	V
16	7848	52.92	-41.3	53.93	-1.01	Pass	V
17	6531	53.55	-41.3	53.93	-0.38	Pass	H
18	7848	53.34	-41.3	53.93	-0.59	Pass	V
19	6630	53.82	-41.3	53.93	-0.11	Pass	V
20	8049	52.89	-41.3	53.93	-1.04	Pass	V
21	6414	53.58	-41.3	53.93	-0.35	Pass	H
22	7849	53.53	-41.3	53.93	-0.40	Pass	V
23	6628	53.80	-41.3	53.93	-0.13	Pass	V
24	7849	53.77	-41.3	53.93	-0.16	Pass	V
25	6535	53.69	-41.3	53.93	-0.24	Pass	H
26	7847	53.45	-41.3	53.93	-0.48	Pass	V
27	6599	51.43	-41.3	53.93	-2.50	Pass	V
28	7857	53.53	-41.3	53.93	-0.40	Pass	V



Radiated Emissions (Fundamental)																																																															
Operating Function	Adapter Mode	Polarization	H for Mode 1 and Mode 2 V for Mode 3 and Mode 4																																																												
		Test Distance	3m																																																												
Mode 1		Mode 2																																																													
<p>Date: 2024-02-22</p> <p>Site Condition : 03CH22-HY : FCC_UWB_HAND 3m LE2C04A18EN_230712 HORIZONTAL : RBW:1000.000KHz VBW:3000.000KHz SWT:1.000sec</p> <p>Detector : Average Project : 3N2325 Channel : CH5 Modulation : BPRF UWB Frame : 0 HPRF Set # : NA Payload Length : 125 Power Offset : 43 Post Power Offset : 50 Sweep point (pts) : 1001</p> <table border="1"> <thead> <tr> <th>Freq</th> <th>Level</th> <th>Over</th> <th>Limit</th> <th>ReadAntenna</th> <th>Cable</th> <th>Preamp</th> <th>A/Pos</th> <th>T/Pos</th> <th>Remark</th> </tr> <tr> <th>MHz</th> <th>dBuV/m</th> <th>dB</th> <th>dBuV/m</th> <th>dBuV</th> <th>dB/m</th> <th>dB</th> <th>dB</th> <th>cm</th> <th>deg</th> </tr> </thead> <tbody> <tr> <td>1</td> <td>6466.00</td> <td>53.79</td> <td>-0.14</td> <td>53.93</td> <td>38.15</td> <td>36.26</td> <td>14.42</td> <td>35.04</td> <td>--- Average</td> </tr> </tbody> </table>		Freq	Level	Over	Limit	ReadAntenna	Cable	Preamp	A/Pos	T/Pos	Remark	MHz	dBuV/m	dB	dBuV/m	dBuV	dB/m	dB	dB	cm	deg	1	6466.00	53.79	-0.14	53.93	38.15	36.26	14.42	35.04	--- Average	<p>Date: 2024-02-22</p> <p>Site Condition : 03CH22-HY : FCC_UWB_HAND 3m LE2C04A18EN_230712 HORIZONTAL : RBW:1000.000KHz VBW:3000.000KHz SWT:1.000sec</p> <p>Detector : Average Project : 3N2325 Channel : CH9 Modulation : BPRF UWB Frame : 0 HPRF Set # : NA Payload Length : 125 Power Offset : 38 Post Power Offset : 50 Sweep point (pts) : 1001</p> <table border="1"> <thead> <tr> <th>Freq</th> <th>Level</th> <th>Over</th> <th>Limit</th> <th>ReadAntenna</th> <th>Cable</th> <th>Preamp</th> <th>A/Pos</th> <th>T/Pos</th> <th>Remark</th> </tr> <tr> <th>MHz</th> <th>dBuV/m</th> <th>dB</th> <th>dBuV/m</th> <th>dBuV</th> <th>dB/m</th> <th>dB</th> <th>dB</th> <th>cm</th> <th>deg</th> </tr> </thead> <tbody> <tr> <td>1</td> <td>7956.00</td> <td>53.76</td> <td>-0.17</td> <td>53.93</td> <td>36.99</td> <td>37.21</td> <td>16.10</td> <td>36.54</td> <td>--- Average</td> </tr> </tbody> </table>		Freq	Level	Over	Limit	ReadAntenna	Cable	Preamp	A/Pos	T/Pos	Remark	MHz	dBuV/m	dB	dBuV/m	dBuV	dB/m	dB	dB	cm	deg	1	7956.00	53.76	-0.17	53.93	36.99	37.21	16.10	36.54	--- Average
Freq	Level	Over	Limit	ReadAntenna	Cable	Preamp	A/Pos	T/Pos	Remark																																																						
MHz	dBuV/m	dB	dBuV/m	dBuV	dB/m	dB	dB	cm	deg																																																						
1	6466.00	53.79	-0.14	53.93	38.15	36.26	14.42	35.04	--- Average																																																						
Freq	Level	Over	Limit	ReadAntenna	Cable	Preamp	A/Pos	T/Pos	Remark																																																						
MHz	dBuV/m	dB	dBuV/m	dBuV	dB/m	dB	dB	cm	deg																																																						
1	7956.00	53.76	-0.17	53.93	36.99	37.21	16.10	36.54	--- Average																																																						
Mode 3		Mode 4																																																													
<p>Date: 2024-01-03</p> <p>Site Condition : 03CH22-HY : FCC_UWB_HAND 3m LE2C04A18EN_230712 VERTICAL : RBW:1000.000KHz VBW:3000.000KHz SWT:1.000sec</p> <p>Detector : Average Project : 3N2325 Channel : CH5 Modulation : BPRF UWB Frame : 0 HPRF Set # : NA Payload Length : 125 Power Offset : 60 Post Power Offset : 51 Sweep point (pts) : 1001</p> <table border="1"> <thead> <tr> <th>Freq</th> <th>Level</th> <th>Over</th> <th>Limit</th> <th>ReadAntenna</th> <th>Cable</th> <th>Preamp</th> <th>A/Pos</th> <th>T/Pos</th> <th>Remark</th> </tr> <tr> <th>MHz</th> <th>dBuV/m</th> <th>dB</th> <th>dBuV/m</th> <th>dBuV</th> <th>dB/m</th> <th>dB</th> <th>dB</th> <th>cm</th> <th>deg</th> </tr> </thead> <tbody> <tr> <td>1</td> <td>6630.00</td> <td>53.69</td> <td>-0.24</td> <td>53.93</td> <td>37.77</td> <td>36.50</td> <td>14.64</td> <td>35.22</td> <td>100 360 Average</td> </tr> </tbody> </table>		Freq	Level	Over	Limit	ReadAntenna	Cable	Preamp	A/Pos	T/Pos	Remark	MHz	dBuV/m	dB	dBuV/m	dBuV	dB/m	dB	dB	cm	deg	1	6630.00	53.69	-0.24	53.93	37.77	36.50	14.64	35.22	100 360 Average	<p>Date: 2024-03-04</p> <p>Site Condition : 03CH22-HY : FCC_UWB_HAND 3m LE2C04A18EN_230712 VERTICAL : RBW:1000.000KHz VBW:3000.000KHz SWT:1.000sec</p> <p>Detector : Average Project : 3N2325 Channel : CH9 Modulation : BPRF UWB Frame : 0 HPRF Set # : NA Payload Length : 125 Power Offset : 62 Post Power Offset : 64 Sweep point (pts) : 1001</p> <table border="1"> <thead> <tr> <th>Freq</th> <th>Level</th> <th>Over</th> <th>Limit</th> <th>ReadAntenna</th> <th>Cable</th> <th>Preamp</th> <th>A/Pos</th> <th>T/Pos</th> <th>Remark</th> </tr> <tr> <th>MHz</th> <th>dBuV/m</th> <th>dB</th> <th>dBuV/m</th> <th>dBuV</th> <th>dB/m</th> <th>dB</th> <th>dB</th> <th>cm</th> <th>deg</th> </tr> </thead> <tbody> <tr> <td>1</td> <td>7847.00</td> <td>53.80</td> <td>-0.13</td> <td>53.93</td> <td>37.08</td> <td>37.10</td> <td>16.02</td> <td>36.40</td> <td>--- Average</td> </tr> </tbody> </table>		Freq	Level	Over	Limit	ReadAntenna	Cable	Preamp	A/Pos	T/Pos	Remark	MHz	dBuV/m	dB	dBuV/m	dBuV	dB/m	dB	dB	cm	deg	1	7847.00	53.80	-0.13	53.93	37.08	37.10	16.02	36.40	--- Average
Freq	Level	Over	Limit	ReadAntenna	Cable	Preamp	A/Pos	T/Pos	Remark																																																						
MHz	dBuV/m	dB	dBuV/m	dBuV	dB/m	dB	dB	cm	deg																																																						
1	6630.00	53.69	-0.24	53.93	37.77	36.50	14.64	35.22	100 360 Average																																																						
Freq	Level	Over	Limit	ReadAntenna	Cable	Preamp	A/Pos	T/Pos	Remark																																																						
MHz	dBuV/m	dB	dBuV/m	dBuV	dB/m	dB	dB	cm	deg																																																						
1	7847.00	53.80	-0.13	53.93	37.08	37.10	16.02	36.40	--- Average																																																						



Radiated Emissions (Fundamental)

Operating Function	Adapter Mode	Polarization	H for Mode 5 V for Mode 6~8
		Test Distance	3m

Mode 5

Mode 6

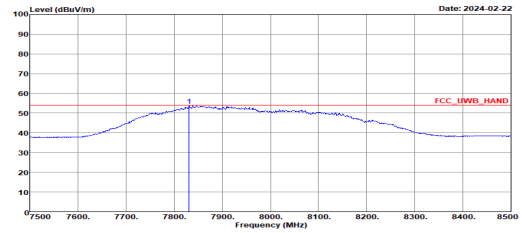
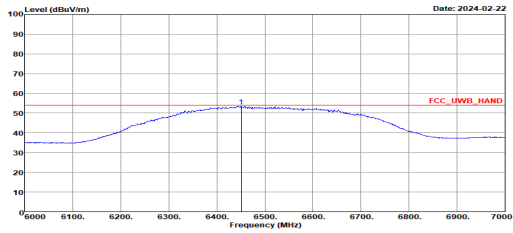

Site : 03CH22-HY
Condition : FCC_UWB_HAND 3m LE2C04A18EN_230712 HORIZONTAL
RBW:1000.000KHz VBW:3000.000KHz SWT:1.000sec

Detector : Average
Project : 3N2325
Channel : CH5
Modulation : BPRF
UWB Frame : 1
HPRF Set # : NA
Payload Length : 125
Power Offset : 40
Post Power Offset : 50
Sweep point (pts) : 1001

Freq	Level	Over	Limit	ReadAntenna	Cable	Preamp	A/Pos	T/Pos	Remark
MHz	dBuV/m	dB	dBuV/m	dBuV	dB/m	dB	dB	cm	deg
1	6451.00	53.59	-0.34	53.93	38.02	36.20	14.40	35.03	---

Site : 03CH22-HY
Condition : FCC_UWB_HAND 3m LE2C04A18EN_230712 VERTICAL
RBW:1000.000KHz VBW:3000.000KHz SWT:1.000sec

Detector : Average
Project : 3N2325
Channel : CH9
Modulation : BPRF
UWB Frame : 1
HPRF Set # : NA
Payload Length : 125
Power Offset : 43
Post Power Offset : 50
Sweep point (pts) : 1001

Freq	Level	Over	Limit	ReadAntenna	Cable	Preamp	A/Pos	T/Pos	Remark
MHz	dBuV/m	dB	dBuV/m	dBuV	dB/m	dB	dB	cm	deg
1	7831.00	53.70	-0.23	53.93	36.98	37.10	16.00	36.38	---

Mode 7

Mode 8

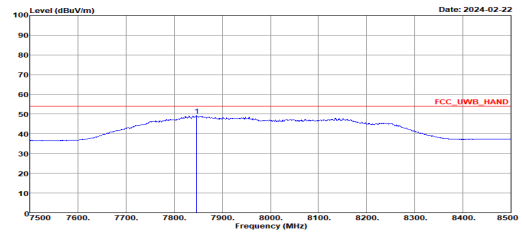
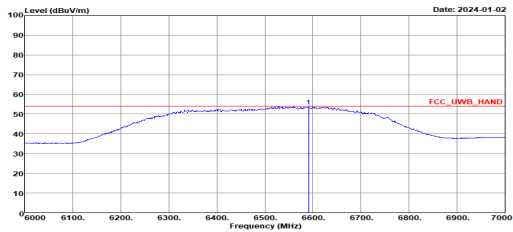

Site : 03CH22-HY
Condition : FCC_UWB_HAND 3m LE2C04A18EN_230712 VERTICAL
RBW:1000.000KHz VBW:3000.000KHz SWT:1.000sec

Detector : Average
Project : 3N2325
Channel : CH5
Modulation : BPRF
UWB Frame : 1
HPRF Set # : NA
Payload Length : 125
Power Offset : 60
Post Power Offset : 50
Sweep point (pts) : 1001

Freq	Level	Over	Limit	ReadAntenna	Cable	Preamp	A/Pos	T/Pos	Remark
MHz	dBuV/m	dB	dBuV/m	dBuV	dB/m	dB	dB	cm	deg
1	6591.00	53.76	-0.17	53.93	37.83	36.50	14.60	35.17	---

Site : 03CH22-HY
Condition : FCC_UWB_HAND 3m LE2C04A18EN_230712 VERTICAL
RBW:1000.000KHz VBW:3000.000KHz SWT:1.000sec

Detector : Average
Project : 3N2325
Channel : CH9
Modulation : BPRF
UWB Frame : 1
HPRF Set # : NA
Payload Length : 125
Power Offset : 63
Post Power Offset : 63
Sweep point (pts) : 1001

Freq	Level	Over	Limit	ReadAntenna	Cable	Preamp	A/Pos	T/Pos	Remark
MHz	dBuV/m	dB	dBuV/m	dBuV	dB/m	dB	dB	cm	deg
1	7847.00	49.21	-4.72	53.93	32.49	37.10	16.02	36.40	---



Radiated Emissions (Fundamental)																																																															
Operating Function	Adapter Mode	Polarization	H for Mode 9 and Mode 12 V for Mode 10 and Mode 11																																																												
		Test Distance	3m																																																												
Mode 9		Mode 10																																																													
<p>Date: 2024-02-22</p>		<p>Date: 2024-02-22</p>																																																													
<p>Site : 03CH22-HY Condition : FCC_UWB_HAND 3m LE2C04A18EN_230712 HORIZONTAL Project : 3N2325 Detector : Average Channel : CH5 Modulation : BPRF UWB Frame : 3 HPRF Set # : NA Payload Length : NA Power Offset : 31 Post Power Offset : 50 Sweep point (pts) : 1001</p> <table border="1"> <thead> <tr> <th>Freq</th> <th>Level</th> <th>Over</th> <th>Limit</th> <th>ReadAntenna</th> <th>Cable</th> <th>Preamp</th> <th>A/Pos</th> <th>T/Pos</th> <th>Remark</th> </tr> <tr> <th>MHz</th> <th>dBuV/m</th> <th>dB</th> <th>dBuV/m</th> <th>dBuV</th> <th>dB/m</th> <th>dB</th> <th>dB</th> <th>cm</th> <th>deg</th> </tr> </thead> <tbody> <tr> <td>1</td> <td>6461.00</td> <td>53.80</td> <td>-0.13</td> <td>53.93</td> <td>38.17</td> <td>36.24</td> <td>14.42</td> <td>35.03</td> <td>---</td> </tr> </tbody> </table>		Freq	Level	Over	Limit	ReadAntenna	Cable	Preamp	A/Pos	T/Pos	Remark	MHz	dBuV/m	dB	dBuV/m	dBuV	dB/m	dB	dB	cm	deg	1	6461.00	53.80	-0.13	53.93	38.17	36.24	14.42	35.03	---	<p>Site : 03CH22-HY Condition : FCC_UWB_HAND 3m LE2C04A18EN_230712 VERTICAL Project : 3N2325 Detector : Average Channel : CH9 Modulation : BPRF UWB Frame : 3 HPRF Set # : NA Payload Length : NA Power Offset : 31 Post Power Offset : 50 Sweep point (pts) : 1001</p> <table border="1"> <thead> <tr> <th>Freq</th> <th>Level</th> <th>Over</th> <th>Limit</th> <th>ReadAntenna</th> <th>Cable</th> <th>Preamp</th> <th>A/Pos</th> <th>T/Pos</th> <th>Remark</th> </tr> <tr> <th>MHz</th> <th>dBuV/m</th> <th>dB</th> <th>dBuV/m</th> <th>dBuV</th> <th>dB/m</th> <th>dB</th> <th>dB</th> <th>cm</th> <th>deg</th> </tr> </thead> <tbody> <tr> <td>1</td> <td>7855.00</td> <td>53.50</td> <td>-0.43</td> <td>53.93</td> <td>36.78</td> <td>37.11</td> <td>16.02</td> <td>36.41</td> <td>---</td> </tr> </tbody> </table>		Freq	Level	Over	Limit	ReadAntenna	Cable	Preamp	A/Pos	T/Pos	Remark	MHz	dBuV/m	dB	dBuV/m	dBuV	dB/m	dB	dB	cm	deg	1	7855.00	53.50	-0.43	53.93	36.78	37.11	16.02	36.41	---
Freq	Level	Over	Limit	ReadAntenna	Cable	Preamp	A/Pos	T/Pos	Remark																																																						
MHz	dBuV/m	dB	dBuV/m	dBuV	dB/m	dB	dB	cm	deg																																																						
1	6461.00	53.80	-0.13	53.93	38.17	36.24	14.42	35.03	---																																																						
Freq	Level	Over	Limit	ReadAntenna	Cable	Preamp	A/Pos	T/Pos	Remark																																																						
MHz	dBuV/m	dB	dBuV/m	dBuV	dB/m	dB	dB	cm	deg																																																						
1	7855.00	53.50	-0.43	53.93	36.78	37.11	16.02	36.41	---																																																						
Mode 11		Mode 12																																																													
<p>Date: 2024-02-22</p>		<p>Date: 2023-12-27</p>																																																													
<p>Site : 03CH22-HY Condition : FCC_UWB_HAND 3m LE2C04A18EN_230712 VERTICAL Project : 3N2325 Detector : Average Channel : CH5 Modulation : BPRF UWB Frame : 3 HPRF Set # : NA Payload Length : NA Power Offset : 50 Post Power Offset : 50 Sweep point (pts) : 1001</p> <table border="1"> <thead> <tr> <th>Freq</th> <th>Level</th> <th>Over</th> <th>Limit</th> <th>ReadAntenna</th> <th>Cable</th> <th>Preamp</th> <th>A/Pos</th> <th>T/Pos</th> <th>Remark</th> </tr> <tr> <th>MHz</th> <th>dBuV/m</th> <th>dB</th> <th>dBuV/m</th> <th>dBuV</th> <th>dB/m</th> <th>dB</th> <th>dB</th> <th>cm</th> <th>deg</th> </tr> </thead> <tbody> <tr> <td>1</td> <td>6618.00</td> <td>53.39</td> <td>-0.54</td> <td>53.93</td> <td>37.46</td> <td>36.50</td> <td>14.63</td> <td>35.20</td> <td>---</td> </tr> </tbody> </table>		Freq	Level	Over	Limit	ReadAntenna	Cable	Preamp	A/Pos	T/Pos	Remark	MHz	dBuV/m	dB	dBuV/m	dBuV	dB/m	dB	dB	cm	deg	1	6618.00	53.39	-0.54	53.93	37.46	36.50	14.63	35.20	---	<p>Site : 03CH22-HY Condition : FCC_UWB_HAND 3m LE2C04A18EN_230712 HORIZONTAL Project : 3N2325 Detector : Average Channel : CH9 Modulation : BPRF UWB Frame : 3 HPRF Set # : NA Payload Length : NA Power Offset : 48 Post Power Offset : 50 Sweep point (pts) : 1001</p> <table border="1"> <thead> <tr> <th>Freq</th> <th>Level</th> <th>Over</th> <th>Limit</th> <th>ReadAntenna</th> <th>Cable</th> <th>Preamp</th> <th>A/Pos</th> <th>T/Pos</th> <th>Remark</th> </tr> <tr> <th>MHz</th> <th>dBuV/m</th> <th>dB</th> <th>dBuV/m</th> <th>dBuV</th> <th>dB/m</th> <th>dB</th> <th>dB</th> <th>cm</th> <th>deg</th> </tr> </thead> <tbody> <tr> <td>1</td> <td>7844.00</td> <td>53.72</td> <td>-0.21</td> <td>53.93</td> <td>37.00</td> <td>37.10</td> <td>16.02</td> <td>36.40</td> <td>100 318 Average</td> </tr> </tbody> </table>		Freq	Level	Over	Limit	ReadAntenna	Cable	Preamp	A/Pos	T/Pos	Remark	MHz	dBuV/m	dB	dBuV/m	dBuV	dB/m	dB	dB	cm	deg	1	7844.00	53.72	-0.21	53.93	37.00	37.10	16.02	36.40	100 318 Average
Freq	Level	Over	Limit	ReadAntenna	Cable	Preamp	A/Pos	T/Pos	Remark																																																						
MHz	dBuV/m	dB	dBuV/m	dBuV	dB/m	dB	dB	cm	deg																																																						
1	6618.00	53.39	-0.54	53.93	37.46	36.50	14.63	35.20	---																																																						
Freq	Level	Over	Limit	ReadAntenna	Cable	Preamp	A/Pos	T/Pos	Remark																																																						
MHz	dBuV/m	dB	dBuV/m	dBuV	dB/m	dB	dB	cm	deg																																																						
1	7844.00	53.72	-0.21	53.93	37.00	37.10	16.02	36.40	100 318 Average																																																						



Radiated Emissions (Fundamental)																																																																					
Operating Function		Adapter Mode		Polarization		H for Mode 13 V for Mode 14~16																																																															
				Test Distance		3m																																																															
Mode 13					Mode 14																																																																
<p>Date: 2024-02-22</p> <p>Site : 03CH22-HY Condition : FCC_UWB_HAND 3m LE2C04A18EN_230712 HORIZONTAL RBW:1000.000KHz VBW:3000.000KHz SWT:1.000sec</p> <p>Detector : Average Project : 3N2325 Channel : CH5 Modulation : HPRF UWB Frame : NA HPRF Set # : 13 Payload Length : NA Power Offset : 42 Post Power Offset : 50 Sweep point (pts) : 1001</p> <table border="1"> <thead> <tr> <th>Freq</th> <th>Level</th> <th>Over</th> <th>Limit</th> <th>ReadAntenna</th> <th>Cable</th> <th>Preamp</th> <th>A/Pos</th> <th>T/Pos</th> <th>Remark</th> </tr> <tr> <th>MHz</th> <th>dBuV/m</th> <th>dB</th> <th>dBuV/m</th> <th>dBuV</th> <th>dB/m</th> <th>dB</th> <th>dB</th> <th>cm</th> <th>deg</th> </tr> </thead> <tbody> <tr> <td>1</td> <td>6521.00</td> <td>53.59</td> <td>-0.34</td> <td>53.93</td> <td>37.74</td> <td>36.44</td> <td>14.50</td> <td>35.09</td> <td>--- Average</td> </tr> </tbody> </table>					Freq	Level	Over	Limit	ReadAntenna	Cable	Preamp	A/Pos	T/Pos	Remark	MHz	dBuV/m	dB	dBuV/m	dBuV	dB/m	dB	dB	cm	deg	1	6521.00	53.59	-0.34	53.93	37.74	36.44	14.50	35.09	--- Average	<p>Date: 2024-02-22</p> <p>Site : 03CH22-HY Condition : FCC_UWB_HAND 3m LE2C04A18EN_230712 VERTICAL RBW:1000.000KHz VBW:3000.000KHz SWT:1.000sec</p> <p>Detector : Average Project : 3N2325 Channel : CH9 Modulation : HPRF UWB Frame : NA HPRF Set # : 13 Payload Length : NA Power Offset : 60 Post Power Offset : 50 Sweep point (pts) : 1001</p> <table border="1"> <thead> <tr> <th>Freq</th> <th>Level</th> <th>Over</th> <th>Limit</th> <th>ReadAntenna</th> <th>Cable</th> <th>Preamp</th> <th>A/Pos</th> <th>T/Pos</th> <th>Remark</th> </tr> <tr> <th>MHz</th> <th>dBuV/m</th> <th>dB</th> <th>dBuV/m</th> <th>dBuV</th> <th>dB/m</th> <th>dB</th> <th>dB</th> <th>cm</th> <th>deg</th> </tr> </thead> <tbody> <tr> <td>1</td> <td>7847.00</td> <td>53.81</td> <td>-0.12</td> <td>53.93</td> <td>37.09</td> <td>37.10</td> <td>16.02</td> <td>36.40</td> <td>--- Average</td> </tr> </tbody> </table>					Freq	Level	Over	Limit	ReadAntenna	Cable	Preamp	A/Pos	T/Pos	Remark	MHz	dBuV/m	dB	dBuV/m	dBuV	dB/m	dB	dB	cm	deg	1	7847.00	53.81	-0.12	53.93	37.09	37.10	16.02	36.40	--- Average
Freq	Level	Over	Limit	ReadAntenna	Cable	Preamp	A/Pos	T/Pos	Remark																																																												
MHz	dBuV/m	dB	dBuV/m	dBuV	dB/m	dB	dB	cm	deg																																																												
1	6521.00	53.59	-0.34	53.93	37.74	36.44	14.50	35.09	--- Average																																																												
Freq	Level	Over	Limit	ReadAntenna	Cable	Preamp	A/Pos	T/Pos	Remark																																																												
MHz	dBuV/m	dB	dBuV/m	dBuV	dB/m	dB	dB	cm	deg																																																												
1	7847.00	53.81	-0.12	53.93	37.09	37.10	16.02	36.40	--- Average																																																												
Mode 15					Mode 16																																																																
<p>Date: 2024-02-22</p> <p>Site : 03CH22-HY Condition : FCC_UWB_HAND 3m LE2C04A18EN_230712 VERTICAL RBW:1000.000KHz VBW:3000.000KHz SWT:1.000sec</p> <p>Detector : Average Project : 3N2325 Channel : CH5 Modulation : HPRF UWB Frame : NA HPRF Set # : 13 Payload Length : NA Power Offset : 80 Post Power Offset : 50 Sweep point (pts) : 1001</p> <table border="1"> <thead> <tr> <th>Freq</th> <th>Level</th> <th>Over</th> <th>Limit</th> <th>ReadAntenna</th> <th>Cable</th> <th>Preamp</th> <th>A/Pos</th> <th>T/Pos</th> <th>Remark</th> </tr> <tr> <th>MHz</th> <th>dBuV/m</th> <th>dB</th> <th>dBuV/m</th> <th>dBuV</th> <th>dB/m</th> <th>dB</th> <th>dB</th> <th>cm</th> <th>deg</th> </tr> </thead> <tbody> <tr> <td>1</td> <td>6586.00</td> <td>53.82</td> <td>-0.11</td> <td>53.93</td> <td>37.90</td> <td>36.50</td> <td>14.59</td> <td>35.17</td> <td>--- Average</td> </tr> </tbody> </table>					Freq	Level	Over	Limit	ReadAntenna	Cable	Preamp	A/Pos	T/Pos	Remark	MHz	dBuV/m	dB	dBuV/m	dBuV	dB/m	dB	dB	cm	deg	1	6586.00	53.82	-0.11	53.93	37.90	36.50	14.59	35.17	--- Average	<p>Date: 2024-03-04</p> <p>Site : 03CH22-HY Condition : FCC_UWB_HAND 3m LE2C04A18EN_230712 VERTICAL RBW:1000.000KHz VBW:3000.000KHz SWT:1.000sec</p> <p>Detector : Average Project : 3N2325 Channel : CH9 Modulation : HPRF UWB Frame : 0 HPRF Set # : 13 Payload Length : NA Power Offset : 69 Post Power Offset : 60 Sweep point (pts) : 1001</p> <table border="1"> <thead> <tr> <th>Freq</th> <th>Level</th> <th>Over</th> <th>Limit</th> <th>ReadAntenna</th> <th>Cable</th> <th>Preamp</th> <th>A/Pos</th> <th>T/Pos</th> <th>Remark</th> </tr> <tr> <th>MHz</th> <th>dBuV/m</th> <th>dB</th> <th>dBuV/m</th> <th>dBuV</th> <th>dB/m</th> <th>dB</th> <th>dB</th> <th>cm</th> <th>deg</th> </tr> </thead> <tbody> <tr> <td>1</td> <td>7848.00</td> <td>52.92</td> <td>-1.01</td> <td>53.93</td> <td>36.20</td> <td>37.10</td> <td>16.02</td> <td>36.40</td> <td>--- Average</td> </tr> </tbody> </table>					Freq	Level	Over	Limit	ReadAntenna	Cable	Preamp	A/Pos	T/Pos	Remark	MHz	dBuV/m	dB	dBuV/m	dBuV	dB/m	dB	dB	cm	deg	1	7848.00	52.92	-1.01	53.93	36.20	37.10	16.02	36.40	--- Average
Freq	Level	Over	Limit	ReadAntenna	Cable	Preamp	A/Pos	T/Pos	Remark																																																												
MHz	dBuV/m	dB	dBuV/m	dBuV	dB/m	dB	dB	cm	deg																																																												
1	6586.00	53.82	-0.11	53.93	37.90	36.50	14.59	35.17	--- Average																																																												
Freq	Level	Over	Limit	ReadAntenna	Cable	Preamp	A/Pos	T/Pos	Remark																																																												
MHz	dBuV/m	dB	dBuV/m	dBuV	dB/m	dB	dB	cm	deg																																																												
1	7848.00	52.92	-1.01	53.93	36.20	37.10	16.02	36.40	--- Average																																																												



Radiated Emissions (Fundamental)																																																																							
Operating Function	Adapter Mode	Polarization		H for Mode 17 V for Mode 18~20																																																																			
		Test Distance		3m																																																																			
Mode 17				Mode 18																																																																			
Site : 03CH22-HY Condition : FCC_UWB_HAND 3m LE2C04A18EN_230712 HORIZONTAL : RBW:1000.000KHz VBW:3000.000KHz SWT:1.000sec : Detector : Average Project : 3N2325 Channel : CH5 Modulation : HPRF UWB Frame : NA HPRF Set # : 15 Payload Length : NA Power Offset : 4B Post Power Offset : 50 Sweep point (pts) : 1001				Site : 03CH22-HY Condition : FCC_UWB_HAND 3m LE2C04A18EN_230712 VERTICAL : RBW:1000.000KHz VBW:3000.000KHz SWT:1.000sec : Detector : Average Project : 3N2325 Channel : CH9 Modulation : HPRF UWB Frame : NA HPRF Set # : 15 Payload Length : NA Power Offset : 60 Post Power Offset : 50 Sweep point (pts) : 1001																																																																			
<table border="1"> <thead> <tr> <th>Freq</th> <th>Level</th> <th>Over</th> <th>Limit</th> <th>ReadAntenna</th> <th>Cable</th> <th>Preamp</th> <th>A/Pos</th> <th>T/Pos</th> <th>Remark</th> </tr> <tr> <th>MHz</th> <th>dBuV/m</th> <th>dB</th> <th>dBuV/m</th> <th>dBuV</th> <th>dB/m</th> <th>dB</th> <th>dB</th> <th>cm</th> <th>deg</th> </tr> </thead> <tbody> <tr> <td>1</td> <td>6531.00</td> <td>53.55</td> <td>-0.38</td> <td>53.93</td> <td>37.68</td> <td>36.46</td> <td>14.51</td> <td>35.10</td> <td>---</td> <td>---</td> <td>Average</td> </tr> </tbody> </table>				Freq	Level	Over	Limit	ReadAntenna	Cable	Preamp	A/Pos	T/Pos	Remark	MHz	dBuV/m	dB	dBuV/m	dBuV	dB/m	dB	dB	cm	deg	1	6531.00	53.55	-0.38	53.93	37.68	36.46	14.51	35.10	---	---	Average	<table border="1"> <thead> <tr> <th>Freq</th> <th>Level</th> <th>Over</th> <th>Limit</th> <th>ReadAntenna</th> <th>Cable</th> <th>Preamp</th> <th>A/Pos</th> <th>T/Pos</th> <th>Remark</th> </tr> <tr> <th>MHz</th> <th>dBuV/m</th> <th>dB</th> <th>dBuV/m</th> <th>dBuV</th> <th>dB/m</th> <th>dB</th> <th>dB</th> <th>cm</th> <th>deg</th> </tr> </thead> <tbody> <tr> <td>1</td> <td>7848.00</td> <td>53.34</td> <td>-0.59</td> <td>53.93</td> <td>36.62</td> <td>37.10</td> <td>16.02</td> <td>36.40</td> <td>---</td> <td>---</td> <td>Average</td> </tr> </tbody> </table>				Freq	Level	Over	Limit	ReadAntenna	Cable	Preamp	A/Pos	T/Pos	Remark	MHz	dBuV/m	dB	dBuV/m	dBuV	dB/m	dB	dB	cm	deg	1	7848.00	53.34	-0.59	53.93	36.62	37.10	16.02	36.40	---	---	Average
Freq	Level	Over	Limit	ReadAntenna	Cable	Preamp	A/Pos	T/Pos	Remark																																																														
MHz	dBuV/m	dB	dBuV/m	dBuV	dB/m	dB	dB	cm	deg																																																														
1	6531.00	53.55	-0.38	53.93	37.68	36.46	14.51	35.10	---	---	Average																																																												
Freq	Level	Over	Limit	ReadAntenna	Cable	Preamp	A/Pos	T/Pos	Remark																																																														
MHz	dBuV/m	dB	dBuV/m	dBuV	dB/m	dB	dB	cm	deg																																																														
1	7848.00	53.34	-0.59	53.93	36.62	37.10	16.02	36.40	---	---	Average																																																												
Mode 19				Mode 20																																																																			
Site : 03CH22-HY Condition : FCC_UWB_HAND 3m LE2C04A18EN_230712 VERTICAL : RBW:1000.000KHz VBW:3000.000KHz SWT:1.000sec : Detector : Average Project : 3N2325 Channel : CH5 Modulation : HPRF UWB Frame : NA HPRF Set # : 15 Payload Length : NA Power Offset : 70 Post Power Offset : 54 Sweep point (pts) : 1001				Site : 03CH22-HY Condition : FCC_UWB_HAND 3m LE2C04A18EN_230712 VERTICAL : RBW:1000.000KHz VBW:3000.000KHz SWT:1.000sec : Detector : Average Project : 3N2325 Channel : CH9 Modulation : HPRF UWB Frame : NA HPRF Set # : 15 Payload Length : 150 Power Offset : 63 Post Power Offset : 50 Sweep point (pts) : 1001																																																																			
<table border="1"> <thead> <tr> <th>Freq</th> <th>Level</th> <th>Over</th> <th>Limit</th> <th>ReadAntenna</th> <th>Cable</th> <th>Preamp</th> <th>A/Pos</th> <th>T/Pos</th> <th>Remark</th> </tr> <tr> <th>MHz</th> <th>dBuV/m</th> <th>dB</th> <th>dBuV/m</th> <th>dBuV</th> <th>dB/m</th> <th>dB</th> <th>dB</th> <th>cm</th> <th>deg</th> </tr> </thead> <tbody> <tr> <td>1</td> <td>6630.00</td> <td>53.82</td> <td>-0.11</td> <td>53.93</td> <td>37.90</td> <td>36.50</td> <td>14.64</td> <td>35.22</td> <td>---</td> <td>---</td> <td>Average</td> </tr> </tbody> </table>				Freq	Level	Over	Limit	ReadAntenna	Cable	Preamp	A/Pos	T/Pos	Remark	MHz	dBuV/m	dB	dBuV/m	dBuV	dB/m	dB	dB	cm	deg	1	6630.00	53.82	-0.11	53.93	37.90	36.50	14.64	35.22	---	---	Average	<table border="1"> <thead> <tr> <th>Freq</th> <th>Level</th> <th>Over</th> <th>Limit</th> <th>ReadAntenna</th> <th>Cable</th> <th>Preamp</th> <th>A/Pos</th> <th>T/Pos</th> <th>Remark</th> </tr> <tr> <th>MHz</th> <th>dBuV/m</th> <th>dB</th> <th>dBuV/m</th> <th>dBuV</th> <th>dB/m</th> <th>dB</th> <th>dB</th> <th>cm</th> <th>deg</th> </tr> </thead> <tbody> <tr> <td>1</td> <td>8849.00</td> <td>52.89</td> <td>-1.04</td> <td>53.93</td> <td>36.17</td> <td>37.20</td> <td>16.16</td> <td>36.64</td> <td>111</td> <td>9</td> <td>Average</td> </tr> </tbody> </table>				Freq	Level	Over	Limit	ReadAntenna	Cable	Preamp	A/Pos	T/Pos	Remark	MHz	dBuV/m	dB	dBuV/m	dBuV	dB/m	dB	dB	cm	deg	1	8849.00	52.89	-1.04	53.93	36.17	37.20	16.16	36.64	111	9	Average
Freq	Level	Over	Limit	ReadAntenna	Cable	Preamp	A/Pos	T/Pos	Remark																																																														
MHz	dBuV/m	dB	dBuV/m	dBuV	dB/m	dB	dB	cm	deg																																																														
1	6630.00	53.82	-0.11	53.93	37.90	36.50	14.64	35.22	---	---	Average																																																												
Freq	Level	Over	Limit	ReadAntenna	Cable	Preamp	A/Pos	T/Pos	Remark																																																														
MHz	dBuV/m	dB	dBuV/m	dBuV	dB/m	dB	dB	cm	deg																																																														
1	8849.00	52.89	-1.04	53.93	36.17	37.20	16.16	36.64	111	9	Average																																																												



Radiated Emissions (Fundamental)																																																																			
Operating Function	Adapter Mode	Polarization	H for Mode 21 V for Mode 22~24																																																																
		Test Distance	3m																																																																
Mode 21				Mode 22																																																															
<p>Date: 2024-03-05</p>				<p>Date: 2024-02-22</p>																																																															
<p>Site : 03CH22-HY Condition : FCC_UWB_HAND 3m LE2C04A18EN_230712 HORIZONTAL RBW:1000.000KHz VBW:3000.000KHz SWT:1.000sec</p> <p>Detector : Average Project : 3N2325 Channel : CH5 Modulation : HPRF UWB Frame : NA HPRF Set # : 21 Payload Length : NA Power Offset : 62 Post Power Offset : 50 Sweep point (pts) : 1001</p> <table border="1"> <thead> <tr> <th>Freq</th> <th>Level</th> <th>Over</th> <th>Limit</th> <th>ReadAntenna</th> <th>Cable</th> <th>Preamp</th> <th>A/Pos</th> <th>T/Pos</th> <th>Remark</th> </tr> <tr> <th>MHz</th> <th>dBuV/m</th> <th>dB</th> <th>dBuV/m</th> <th>dBuV</th> <th>dB/m</th> <th>dB</th> <th>dB</th> <th>cm</th> <th>deg</th> </tr> </thead> <tbody> <tr> <td>1</td> <td>6414.00</td> <td>53.58</td> <td>-0.35</td> <td>53.93</td> <td>37.95</td> <td>36.27</td> <td>14.35</td> <td>34.99</td> <td>--- Average</td> </tr> </tbody> </table>				Freq	Level	Over	Limit	ReadAntenna	Cable	Preamp	A/Pos	T/Pos	Remark	MHz	dBuV/m	dB	dBuV/m	dBuV	dB/m	dB	dB	cm	deg	1	6414.00	53.58	-0.35	53.93	37.95	36.27	14.35	34.99	--- Average	<p>Site : 03CH22-HY Condition : FCC_UWB_HAND 3m LE2C04A18EN_230712 VERTICAL RBW:1000.000KHz VBW:3000.000KHz SWT:1.000sec</p> <p>Detector : Average Project : 3N2325 Channel : CH9 Modulation : HPRF UWB Frame : NA HPRF Set # : 21 Payload Length : NA Power Offset : 60 Post Power Offset : 50 Sweep point (pts) : 1001</p> <table border="1"> <thead> <tr> <th>Freq</th> <th>Level</th> <th>Over</th> <th>Limit</th> <th>ReadAntenna</th> <th>Cable</th> <th>Preamp</th> <th>A/Pos</th> <th>T/Pos</th> <th>Remark</th> </tr> <tr> <th>MHz</th> <th>dBuV/m</th> <th>dB</th> <th>dBuV/m</th> <th>dBuV</th> <th>dB/m</th> <th>dB</th> <th>dB</th> <th>cm</th> <th>deg</th> </tr> </thead> <tbody> <tr> <td>1</td> <td>7849.00</td> <td>53.53</td> <td>-0.40</td> <td>53.93</td> <td>36.81</td> <td>37.10</td> <td>16.02</td> <td>36.40</td> <td>--- Average</td> </tr> </tbody> </table>				Freq	Level	Over	Limit	ReadAntenna	Cable	Preamp	A/Pos	T/Pos	Remark	MHz	dBuV/m	dB	dBuV/m	dBuV	dB/m	dB	dB	cm	deg	1	7849.00	53.53	-0.40	53.93	36.81	37.10	16.02	36.40	--- Average
Freq	Level	Over	Limit	ReadAntenna	Cable	Preamp	A/Pos	T/Pos	Remark																																																										
MHz	dBuV/m	dB	dBuV/m	dBuV	dB/m	dB	dB	cm	deg																																																										
1	6414.00	53.58	-0.35	53.93	37.95	36.27	14.35	34.99	--- Average																																																										
Freq	Level	Over	Limit	ReadAntenna	Cable	Preamp	A/Pos	T/Pos	Remark																																																										
MHz	dBuV/m	dB	dBuV/m	dBuV	dB/m	dB	dB	cm	deg																																																										
1	7849.00	53.53	-0.40	53.93	36.81	37.10	16.02	36.40	--- Average																																																										
Mode 23				Mode 24																																																															
<p>Date: 2024-02-22</p>				<p>Date: 2024-01-03</p>																																																															
<p>Site : 03CH22-HY Condition : FCC_UWB_HAND 3m LE2C04A18EN_230712 VERTICAL RBW:1000.000KHz VBW:3000.000KHz SWT:1.000sec</p> <p>Detector : Average Project : 3N2325 Channel : CH5 Modulation : HPRF UWB Frame : NA HPRF Set # : 21 Payload Length : NA Power Offset : 71 Post Power Offset : 50 Sweep point (pts) : 1001</p> <table border="1"> <thead> <tr> <th>Freq</th> <th>Level</th> <th>Over</th> <th>Limit</th> <th>ReadAntenna</th> <th>Cable</th> <th>Preamp</th> <th>A/Pos</th> <th>T/Pos</th> <th>Remark</th> </tr> <tr> <th>MHz</th> <th>dBuV/m</th> <th>dB</th> <th>dBuV/m</th> <th>dBuV</th> <th>dB/m</th> <th>dB</th> <th>dB</th> <th>cm</th> <th>deg</th> </tr> </thead> <tbody> <tr> <td>1</td> <td>6628.00</td> <td>53.80</td> <td>-0.13</td> <td>53.93</td> <td>37.87</td> <td>36.50</td> <td>14.64</td> <td>35.21</td> <td>--- Average</td> </tr> </tbody> </table>				Freq	Level	Over	Limit	ReadAntenna	Cable	Preamp	A/Pos	T/Pos	Remark	MHz	dBuV/m	dB	dBuV/m	dBuV	dB/m	dB	dB	cm	deg	1	6628.00	53.80	-0.13	53.93	37.87	36.50	14.64	35.21	--- Average	<p>Site : 03CH22-HY Condition : FCC_UWB_HAND 3m LE2C04A18EN_230712 VERTICAL RBW:1000.000KHz VBW:3000.000KHz SWT:1.000sec</p> <p>Detector : Average Project : 3N2325 Channel : CH9 Modulation : HPRF UWB Frame : NA HPRF Set # : 21 Payload Length : NA Power Offset : 63 Post Power Offset : 51 Sweep point (pts) : 1001</p> <table border="1"> <thead> <tr> <th>Freq</th> <th>Level</th> <th>Over</th> <th>Limit</th> <th>ReadAntenna</th> <th>Cable</th> <th>Preamp</th> <th>A/Pos</th> <th>T/Pos</th> <th>Remark</th> </tr> <tr> <th>MHz</th> <th>dBuV/m</th> <th>dB</th> <th>dBuV/m</th> <th>dBuV</th> <th>dB/m</th> <th>dB</th> <th>dB</th> <th>cm</th> <th>deg</th> </tr> </thead> <tbody> <tr> <td>1</td> <td>7849.00</td> <td>53.77</td> <td>-0.16</td> <td>53.93</td> <td>37.05</td> <td>37.10</td> <td>16.02</td> <td>36.40</td> <td>233 4 Average</td> </tr> </tbody> </table>				Freq	Level	Over	Limit	ReadAntenna	Cable	Preamp	A/Pos	T/Pos	Remark	MHz	dBuV/m	dB	dBuV/m	dBuV	dB/m	dB	dB	cm	deg	1	7849.00	53.77	-0.16	53.93	37.05	37.10	16.02	36.40	233 4 Average
Freq	Level	Over	Limit	ReadAntenna	Cable	Preamp	A/Pos	T/Pos	Remark																																																										
MHz	dBuV/m	dB	dBuV/m	dBuV	dB/m	dB	dB	cm	deg																																																										
1	6628.00	53.80	-0.13	53.93	37.87	36.50	14.64	35.21	--- Average																																																										
Freq	Level	Over	Limit	ReadAntenna	Cable	Preamp	A/Pos	T/Pos	Remark																																																										
MHz	dBuV/m	dB	dBuV/m	dBuV	dB/m	dB	dB	cm	deg																																																										
1	7849.00	53.77	-0.16	53.93	37.05	37.10	16.02	36.40	233 4 Average																																																										



Radiated Emissions (Fundamental)																																																																			
Operating Function	Adapter Mode	Polarization	H for Mode 25 V for Mode 26~28																																																																
		Test Distance	3m																																																																
Mode 25		Mode 26																																																																	
<p>Level (dBuV/m) vs Frequency (MHz). Date: 2024-02-22</p>		<p>Level (dBuV/m) vs Frequency (MHz). Date: 2024-02-22</p>																																																																	
<p>Site : 03CH22-HV Condition : FCC_UWB_HAND 3m LE2C04A18EN_230712 HORIZONTAL RBW:1000.000KHz VBW:3000.000KHz SWT:1.000sec</p> <p>Detector : Average Project : 3N2325 Channel : CH5 Modulation : HPRF UWB Frame : NA HPRF Set # : 31 Payload Length : NA Power Offset : 30 Post Power Offset : 50 Sweep point (pts) : 1001</p> <table border="1"> <thead> <tr> <th>Freq</th> <th>Level</th> <th>Over Limit</th> <th>Limit</th> <th>ReadAntenna Level Factor</th> <th>Cable Loss Factor</th> <th>Preamp</th> <th>A/Pos</th> <th>T/Pos</th> <th>Remark</th> </tr> <tr> <th>MHz</th> <th>dBuV/m</th> <th>dB</th> <th>dBuV/m</th> <th>dBuV</th> <th>dB/m</th> <th>dB</th> <th>cm</th> <th>deg</th> <th></th> </tr> </thead> <tbody> <tr> <td>1</td> <td>6535.00</td> <td>53.69</td> <td>-0.24</td> <td>53.93</td> <td>37.81</td> <td>36.47</td> <td>14.52</td> <td>35.11</td> <td>---</td> <td>---</td> <td>Average</td> </tr> </tbody> </table>		Freq	Level	Over Limit	Limit	ReadAntenna Level Factor	Cable Loss Factor	Preamp	A/Pos	T/Pos	Remark	MHz	dBuV/m	dB	dBuV/m	dBuV	dB/m	dB	cm	deg		1	6535.00	53.69	-0.24	53.93	37.81	36.47	14.52	35.11	---	---	Average	<p>Site : 03CH22-HV Condition : FCC_UWB_HAND 3m LE2C04A18EN_230712 VERTICAL RBW:1000.000KHz VBW:3000.000KHz SWT:1.000sec</p> <p>Detector : Average Project : 3N2325 Channel : CH9 Modulation : HPRF UWB Frame : NA HPRF Set # : 31 Payload Length : NA Power Offset : 30 Post Power Offset : 50 Sweep point (pts) : 1001</p> <table border="1"> <thead> <tr> <th>Freq</th> <th>Level</th> <th>Over Limit</th> <th>Limit</th> <th>ReadAntenna Level Factor</th> <th>Cable Loss Factor</th> <th>Preamp</th> <th>A/Pos</th> <th>T/Pos</th> <th>Remark</th> </tr> <tr> <th>MHz</th> <th>dBuV/m</th> <th>dB</th> <th>dBuV/m</th> <th>dBuV</th> <th>dB/m</th> <th>dB</th> <th>cm</th> <th>deg</th> <th></th> </tr> </thead> <tbody> <tr> <td>1</td> <td>7847.00</td> <td>53.45</td> <td>-0.48</td> <td>53.93</td> <td>36.73</td> <td>37.10</td> <td>16.02</td> <td>36.40</td> <td>---</td> <td>---</td> <td>Average</td> </tr> </tbody> </table>		Freq	Level	Over Limit	Limit	ReadAntenna Level Factor	Cable Loss Factor	Preamp	A/Pos	T/Pos	Remark	MHz	dBuV/m	dB	dBuV/m	dBuV	dB/m	dB	cm	deg		1	7847.00	53.45	-0.48	53.93	36.73	37.10	16.02	36.40	---	---	Average
Freq	Level	Over Limit	Limit	ReadAntenna Level Factor	Cable Loss Factor	Preamp	A/Pos	T/Pos	Remark																																																										
MHz	dBuV/m	dB	dBuV/m	dBuV	dB/m	dB	cm	deg																																																											
1	6535.00	53.69	-0.24	53.93	37.81	36.47	14.52	35.11	---	---	Average																																																								
Freq	Level	Over Limit	Limit	ReadAntenna Level Factor	Cable Loss Factor	Preamp	A/Pos	T/Pos	Remark																																																										
MHz	dBuV/m	dB	dBuV/m	dBuV	dB/m	dB	cm	deg																																																											
1	7847.00	53.45	-0.48	53.93	36.73	37.10	16.02	36.40	---	---	Average																																																								
Mode 27		Mode 28																																																																	
<p>Level (dBuV/m) vs Frequency (MHz). Date: 2024-02-22</p>		<p>Level (dBuV/m) vs Frequency (MHz). Date: 2023-12-30</p>																																																																	
<p>Site : 03CH22-HV Condition : FCC_UWB_HAND 3m LE2C04A18EN_230712 VERTICAL RBW:1000.000KHz VBW:3000.000KHz SWT:1.000sec</p> <p>Detector : Average Project : 3N2325 Channel : CH5 Modulation : HPRF UWB Frame : NA HPRF Set # : 31 Payload Length : NA Power Offset : 54 Post Power Offset : 57 Sweep point (pts) : 1001</p> <table border="1"> <thead> <tr> <th>Freq</th> <th>Level</th> <th>Over Limit</th> <th>Limit</th> <th>ReadAntenna Level Factor</th> <th>Cable Loss Factor</th> <th>Preamp</th> <th>A/Pos</th> <th>T/Pos</th> <th>Remark</th> </tr> <tr> <th>MHz</th> <th>dBuV/m</th> <th>dB</th> <th>dBuV/m</th> <th>dBuV</th> <th>dB/m</th> <th>dB</th> <th>cm</th> <th>deg</th> <th></th> </tr> </thead> <tbody> <tr> <td>1</td> <td>6599.00</td> <td>51.43</td> <td>-2.50</td> <td>53.93</td> <td>35.50</td> <td>36.50</td> <td>14.61</td> <td>35.18</td> <td>---</td> <td>---</td> <td>Average</td> </tr> </tbody> </table>		Freq	Level	Over Limit	Limit	ReadAntenna Level Factor	Cable Loss Factor	Preamp	A/Pos	T/Pos	Remark	MHz	dBuV/m	dB	dBuV/m	dBuV	dB/m	dB	cm	deg		1	6599.00	51.43	-2.50	53.93	35.50	36.50	14.61	35.18	---	---	Average	<p>Site : 03CH22-HV Condition : FCC_UWB_HAND 3m LE2C04A18EN_230712 VERTICAL RBW:1000.000KHz VBW:3000.000KHz SWT:1.000sec</p> <p>Detector : Average Project : 3N2325 Channel : CH9 Modulation : HPRF UWB Frame : NA HPRF Set # : 31 Payload Length : NA Power Offset : 52 Post Power Offset : 50 Sweep point (pts) : 1001</p> <table border="1"> <thead> <tr> <th>Freq</th> <th>Level</th> <th>Over Limit</th> <th>Limit</th> <th>ReadAntenna Level Factor</th> <th>Cable Loss Factor</th> <th>Preamp</th> <th>A/Pos</th> <th>T/Pos</th> <th>Remark</th> </tr> <tr> <th>MHz</th> <th>dBuV/m</th> <th>dB</th> <th>dBuV/m</th> <th>dBuV</th> <th>dB/m</th> <th>dB</th> <th>cm</th> <th>deg</th> <th></th> </tr> </thead> <tbody> <tr> <td>1</td> <td>7857.00</td> <td>53.53</td> <td>-0.40</td> <td>53.93</td> <td>36.80</td> <td>37.11</td> <td>16.03</td> <td>36.41</td> <td>229</td> <td>360</td> <td>Average</td> </tr> </tbody> </table>		Freq	Level	Over Limit	Limit	ReadAntenna Level Factor	Cable Loss Factor	Preamp	A/Pos	T/Pos	Remark	MHz	dBuV/m	dB	dBuV/m	dBuV	dB/m	dB	cm	deg		1	7857.00	53.53	-0.40	53.93	36.80	37.11	16.03	36.41	229	360	Average
Freq	Level	Over Limit	Limit	ReadAntenna Level Factor	Cable Loss Factor	Preamp	A/Pos	T/Pos	Remark																																																										
MHz	dBuV/m	dB	dBuV/m	dBuV	dB/m	dB	cm	deg																																																											
1	6599.00	51.43	-2.50	53.93	35.50	36.50	14.61	35.18	---	---	Average																																																								
Freq	Level	Over Limit	Limit	ReadAntenna Level Factor	Cable Loss Factor	Preamp	A/Pos	T/Pos	Remark																																																										
MHz	dBuV/m	dB	dBuV/m	dBuV	dB/m	dB	cm	deg																																																											
1	7857.00	53.53	-0.40	53.93	36.80	37.11	16.03	36.41	229	360	Average																																																								



3.5.7 Radiated Emissions (30MHz – 1GHz)

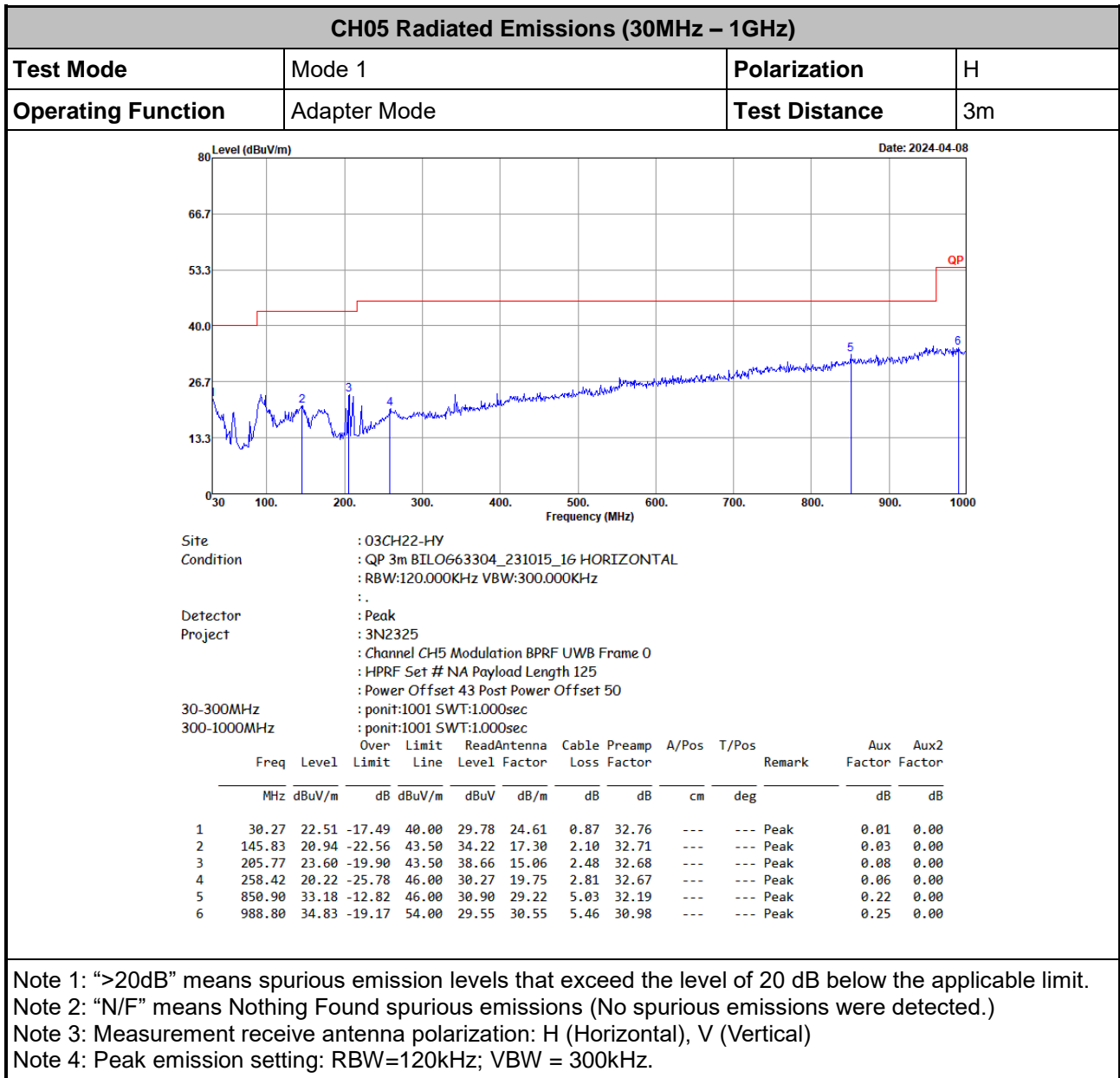



CH05 Radiated Emissions (30MHz – 1GHz)

Test Mode	Mode 1	Polarization	V
Operating Function	Adapter Mode	Test Distance	3m

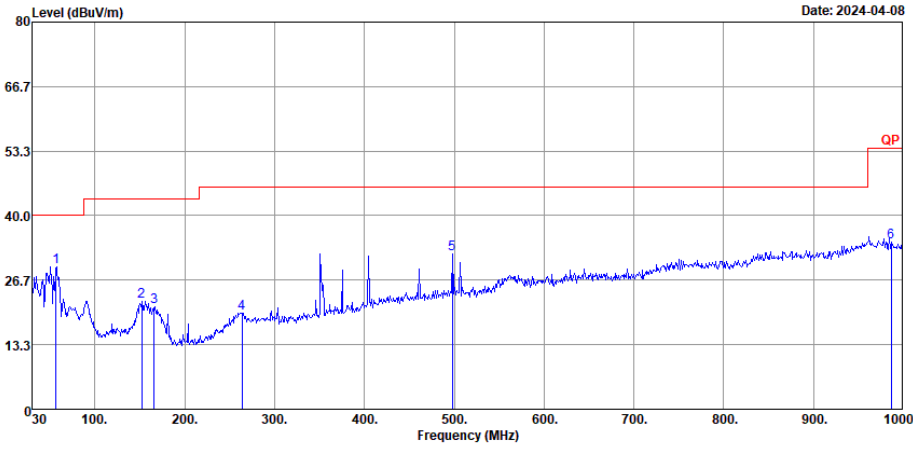

Site : 03CH22-HY
 Condition : QP 3m BILO663304_231015_16 VERTICAL
 : RBW:120.000KHz VBW:300.000KHz
 :
 Detector : Peak
 Project : 3N2325
 : Channel CH5 Modulation BPRF UWB Frame 0
 : HPRF Set # NA Payload Length 125
 : Power Offset 43 Post Power Offset 50
 30-300MHz : ponit:1001 SWT:1.000sec
 300-1000MHz : ponit:1001 SWT:1.000sec

	Over	Limit	ReadAntenna	Cable	Preamp	A/Pos	T/Pos	Remark	Aux	Aux2			
Freq	Level	Limit	Line	Level	Factor	Loss	Factor		Factor	Factor			
MHz	dBuV/m	dB	dBuV/m	dBuV	dB/m	dB	dB	cm	deg	dB	dB		
1	56.73	29.49	-10.51	40.00	48.57	12.34	1.28	32.73	---	---	Peak	0.03	0.00
2	152.31	22.29	-21.21	43.50	35.91	16.90	2.15	32.71	---	---	Peak	0.04	0.00
3	166.08	21.26	-22.24	43.50	35.53	16.10	2.25	32.70	---	---	Peak	0.08	0.00
4	263.82	19.90	-26.10	46.00	29.51	20.17	2.84	32.68	---	---	Peak	0.06	0.00
5	498.10	32.14	-13.86	46.00	37.13	23.92	3.87	32.89	---	---	Peak	0.11	0.00
6	986.70	34.45	-19.55	54.00	29.15	30.61	5.45	31.01	---	---	Peak	0.25	0.00

Note 1: ">20dB" means spurious emission levels that exceed the level of 20 dB below the applicable limit.
 Note 2: "N/F" means Nothing Found spurious emissions (No spurious emissions were detected.)
 Note 3: Measurement receive antenna polarization: H (Horizontal), V (Vertical)
 Note 4: Peak emission setting: RBW=120kHz; VBW = 300kHz.



CH05 Radiated Emissions (30MHz – 1GHz)

Test Mode	Mode 15	Polarization	H
Operating Function	Adapter Mode	Test Distance	3m

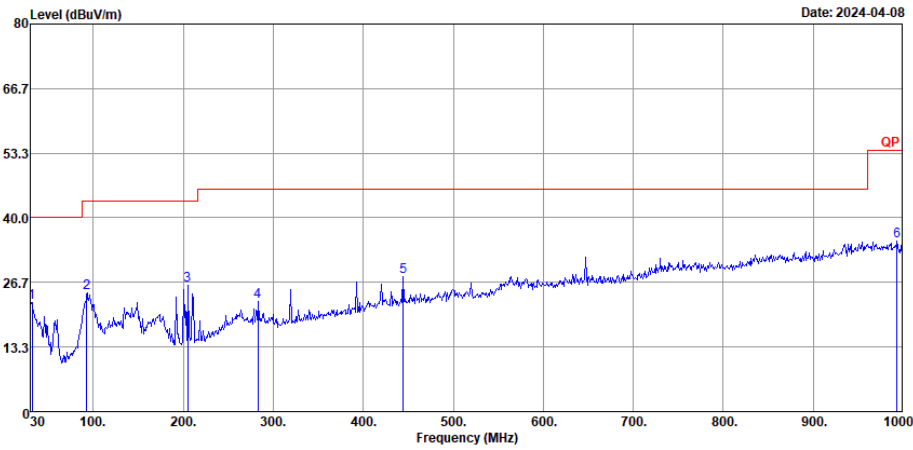

Site : 03CH22-HY
 Condition : QP 3m BIL0663304_231015_16 HORIZONTAL
 : RBW:120.000KHz VBW:300.000KHz
 : .
 Detector : Peak
 Project : 3N2325
 : Channel CH5 Modulation HPRF UWB Frame 0
 : HPRF Set # 13 Payload Length NA
 : Power Offset 80 Post Power Offset 50
 30-300MHz : ponit:1001 SWT:1.000sec
 300-1000MHz : ponit:1001 SWT:1.000sec

	Freq	Level	Over Limit	Limit Line	ReadAntenna Level	Antenna Factor	Cable Loss	Preamp Factor	A/Pos	T/Pos	Remark	Aux Factor	Aux2 Factor
	MHz	dBuV/m	dB	dBuV/m	dBuV	dB/m	dB	dB	cm	deg		dB	dB
1	31.89	22.43	-17.57	40.00	30.13	24.14	0.90	32.75	---	---	Peak	0.01	0.00
2	92.91	24.45	-19.05	43.50	40.26	15.20	1.67	32.73	---	---	Peak	0.05	0.00
3	204.96	26.03	-17.47	43.50	41.12	15.04	2.47	32.68	---	---	Peak	0.08	0.00
4	283.26	22.68	-23.32	46.00	33.55	18.84	2.93	32.70	---	---	Peak	0.06	0.00
5	444.20	27.93	-18.07	46.00	34.07	22.81	3.68	32.75	---	---	Peak	0.12	0.00
6	993.00	35.15	-18.85	54.00	29.87	30.49	5.47	30.94	---	---	Peak	0.26	0.00

- Note 1: ">20dB" means spurious emission levels that exceed the level of 20 dB below the applicable limit.
- Note 2: "N/F" means Nothing Found spurious emissions (No spurious emissions were detected.)
- Note 3: Measurement receive antenna polarization: H (Horizontal), V (Vertical)
- Note 4: Peak emission setting: RBW=120kHz; VBW = 300kHz.



CH05 Radiated Emissions (30MHz – 1GHz)

Test Mode	Mode 15	Polarization	V
Operating Function	Adapter Mode	Test Distance	3m

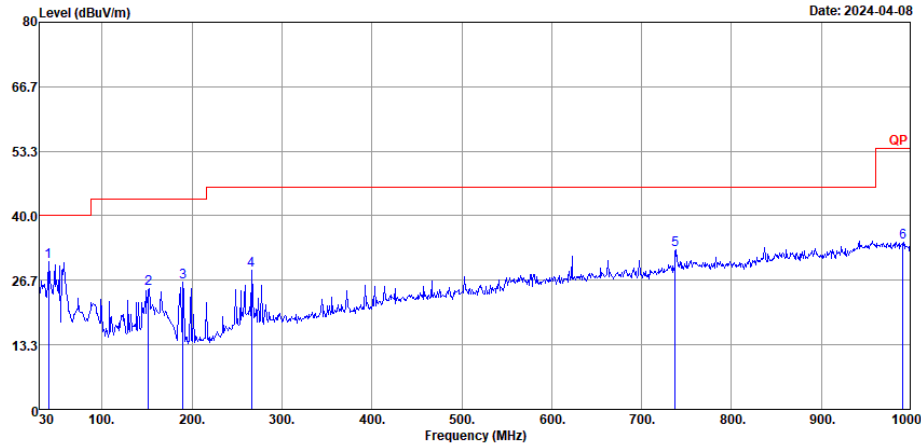

Site : 03CH22-HY
 Condition : QP 3m BIL0663304_231015_16 VERTICAL
 : RBW:120.000KHz VBW:300.000KHz
 : .
 Detector : Peak
 Project : 3N2325
 : Channel CH5 Modulation HPRF UWB Frame 0
 : HPRF Set # 13 Payload Length NA
 : Power Offset 80 Post Power Offset 50
 30-300MHz : ponit:1001 SWT:1.000sec
 300-1000MHz : ponit:1001 SWT:1.000sec

Over	Limit	ReadAntenna	Cable	Preamp	A/Pos	T/Pos	Remark	Aux	Aux2				
Freq	Level	Limit	Line	Level	Factor	Loss	Factor	Factor	Factor				
MHz	dBUV/m	dB	dBUV/m	dBuV	dB/m	dB	dB	dB	dB				
1	40.53	30.63	-9.37	40.00	42.58	19.72	1.06	32.74	---	---	Peak	0.01	0.00
2	151.77	25.04	-18.46	43.50	38.65	16.92	2.14	32.71	---	---	Peak	0.04	0.00
3	189.84	26.19	-17.31	43.50	41.65	14.72	2.39	32.67	---	---	Peak	0.10	0.00
4	265.98	28.71	-17.29	46.00	38.74	19.74	2.85	32.68	---	---	Peak	0.06	0.00
5	737.50	32.91	-13.09	46.00	32.70	28.06	4.73	32.70	---	---	Peak	0.12	0.00
6	990.90	34.54	-19.46	54.00	29.27	30.51	5.46	30.96	---	---	Peak	0.26	0.00

Note 1: ">20dB" means spurious emission levels that exceed the level of 20 dB below the applicable limit.
 Note 2: "N/F" means Nothing Found spurious emissions (No spurious emissions were detected.)
 Note 3: Measurement receive antenna polarization: H (Horizontal), V (Vertical)
 Note 4: Peak emission setting: RBW=120kHz; VBW = 300kHz.



CH09: Radiated Emissions (30MHz – 1GHz)

Test Mode	Mode 12	Polarization	H
Operating Function	Adapter Mode	Test Distance	3m

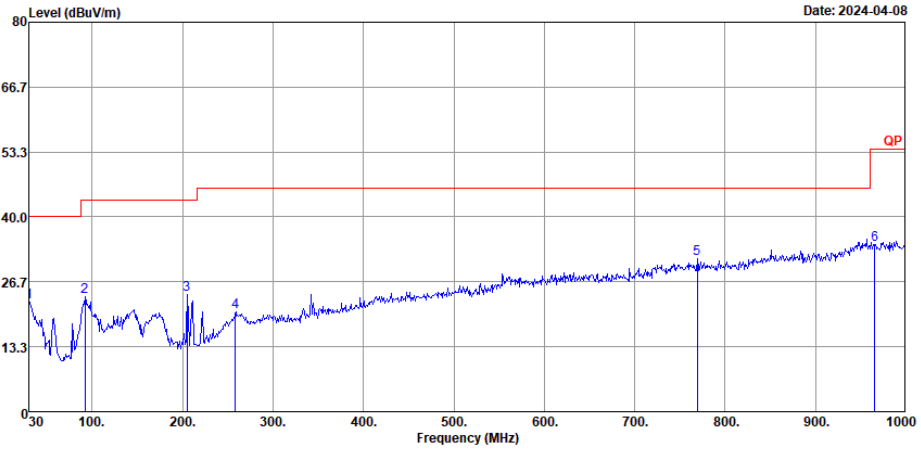

Site : 03CH22-HY
 Condition : QP 3m BIL0663304_231015_16 HORIZONTAL
 : RBW:120.000KHz VBW:300.000KHz
 :.
 Detector : Peak
 Project : 3N2325
 : Channel CH9 Modulation BPRF UWB Frame 3
 : HPRF Set # NA Payload Length NA
 : Power Offset 48 Post Power Offset 50
 30-300MHz : ponit:1001 SWT:1.000sec
 300-1000MHz : ponit:1001 SWT:1.000sec

	Over	Limit	ReadAntenna	Cable	Preamp	A/Pos	T/Pos	Remark	Aux	Aux2			
Freq	Level	Limit	Line	Level	Factor	Loss	Factor		Factor	Factor			
MHz	dBuV/m	dB	dBuV/m	dBuV	dB/m	dB	dB	cm	deg	dB	dB		
1	30.27	22.55	-17.45	40.00	29.82	24.61	0.87	32.76	---	---	Peak	0.01	0.00
2	91.83	23.56	-19.94	43.50	39.45	15.13	1.66	32.73	---	---	Peak	0.05	0.00
3	205.23	23.98	-19.52	43.50	39.06	15.05	2.47	32.68	---	---	Peak	0.08	0.00
4	258.42	20.56	-25.44	46.00	30.61	19.75	2.81	32.67	---	---	Peak	0.06	0.00
5	769.00	31.36	-14.64	46.00	30.75	28.24	4.82	32.60	---	---	Peak	0.15	0.00
6	965.70	34.40	-19.60	54.00	29.10	30.93	5.39	31.24	---	---	Peak	0.22	0.00

Note 1: ">20dB" means spurious emission levels that exceed the level of 20 dB below the applicable limit.
 Note 2: "N/F" means Nothing Found spurious emissions (No spurious emissions were detected.)
 Note 3: Measurement receive antenna polarization: H (Horizontal), V (Vertical)
 Note 4: Peak emission setting: RBW=120kHz; VBW = 300kHz.



CH09 Radiated Emissions (30MHz – 1GHz)

Test Mode	Mode 12	Polarization	V
Operating Function	Adapter Mode	Test Distance	3m

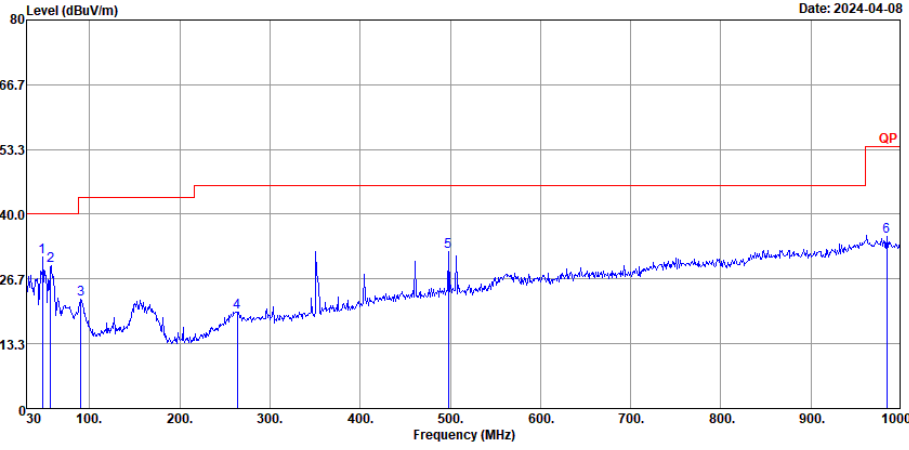

Site : 03CH22-HY
 Condition : QP 3m BILOG63304_231015_16 VERTICAL
 : RBW:120.000KHz VBW:300.000KHz
 : .
 Detector : Peak
 Project : 3N2325
 : Channel CH9 Modulation BPRF UWB Frame 3
 : HPRF Set # NA Payload Length NA
 : Power Offset 48 Post Power Offset 50
 30-300MHz : ponit:1001 SWT:1.000sec
 300-1000MHz : ponit:1001 SWT:1.000sec

	Over	Limit	ReadAntenna	Cable	Preamp	A/Pos	T/Pos	Remark	Aux	Aux2			
Freq	Level	Limit	Line	Level	Factor	Loss	Factor		Factor	Factor			
MHz	dBuV/m	dB	dBuV/m	dBuV	dB/m	dB	dB	cm	deg	dB	dB		
1	47.82	31.28	-8.72	40.00	46.99	15.82	1.18	32.73	---	---	Peak	0.02	0.00
2	57.00	29.33	-10.67	40.00	48.44	12.30	1.29	32.73	---	---	Peak	0.03	0.00
3	90.21	22.44	-21.06	43.50	38.48	14.99	1.65	32.73	---	---	Peak	0.05	0.00
4	263.82	19.89	-26.11	46.00	29.50	20.17	2.84	32.68	---	---	Peak	0.06	0.00
5	498.10	32.29	-13.71	46.00	37.28	23.92	3.87	32.89	---	---	Peak	0.11	0.00
6	983.90	35.41	-18.59	54.00	30.07	30.69	5.44	31.04	---	---	Peak	0.25	0.00

Note 1: ">20dB" means spurious emission levels that exceed the level of 20 dB below the applicable limit.
 Note 2: "N/F" means Nothing Found spurious emissions (No spurious emissions were detected.)
 Note 3: Measurement receive antenna polarization: H (Horizontal), V (Vertical)
 Note 4: Peak emission setting: RBW=120kHz; VBW = 300kHz.



CH09 Radiated Emissions (30MHz – 1GHz)

Test Mode	Mode 14	Polarization	H
Operating Function	Adapter Mode	Test Distance	3m

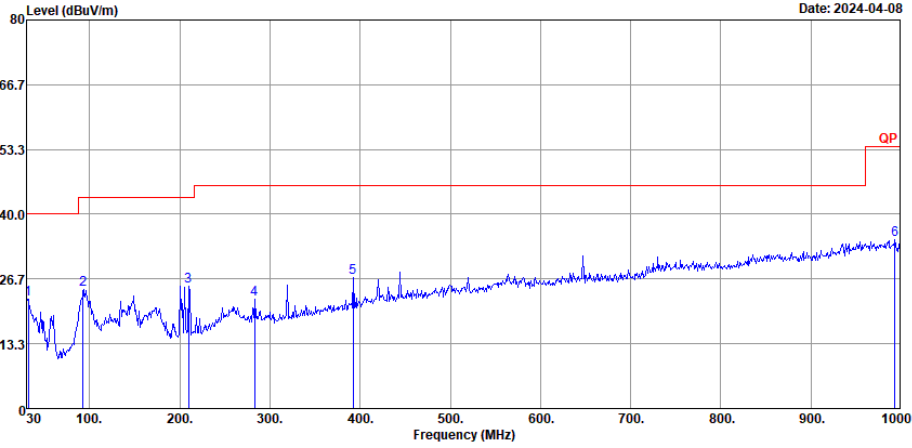

Site : 03CH22-HY
 Condition : QP 3m BILOG63304_231015_16 HORIZONTAL
 : RBW:120.000KHz VBW:300.000KHz
 : .
 Detector : Peak
 Project : 3N2325
 : Channel CH9 Modulation HPRF UWB Frame NA
 : HPRF Set # 13 Payload Length NA
 : Power Offset 59 Post Power Offset 50
 30-300MHz : ponit:1001 SWT:1.000sec
 300-1000MHz : ponit:1001 SWT:1.000sec

	Over	Limit	ReadAntenna	Cable	Preamp	A/Pos	T/Pos	Remark	Aux	Aux2			
Freq	Level	Limit	Line	Level	Factor	Loss	Factor		Factor	Factor			
MHz	dBuV/m	dB	dBuV/m	dBuV	dB/m	dB	dB	cm	deg	dB	dB		
1	31.89	22.61	-17.39	40.00	30.31	24.14	0.90	32.75	---	---	Peak	0.01	0.00
2	92.91	24.48	-19.02	43.50	40.29	15.20	1.67	32.73	---	---	Peak	0.05	0.00
3	209.82	25.24	-18.26	43.50	40.29	15.05	2.50	32.68	---	---	Peak	0.08	0.00
4	283.26	22.49	-23.51	46.00	33.36	18.84	2.93	32.70	---	---	Peak	0.06	0.00
5	392.40	26.92	-19.08	46.00	34.68	21.44	3.45	32.72	---	---	Peak	0.07	0.00
6	993.00	34.80	-19.20	54.00	29.52	30.49	5.47	30.94	---	---	Peak	0.26	0.00

Note 1: ">20dB" means spurious emission levels that exceed the level of 20 dB below the applicable limit.
 Note 2: "N/F" means Nothing Found spurious emissions (No spurious emissions were detected.)
 Note 3: Measurement receive antenna polarization: H (Horizontal), V (Vertical)
 Note 4: Peak emission setting: RBW=120kHz; VBW = 300kHz.



CH09 Radiated Emissions (30MHz – 1GHz)

Test Mode	Mode 14	Polarization	V
Operating Function	Adapter Mode	Test Distance	3m

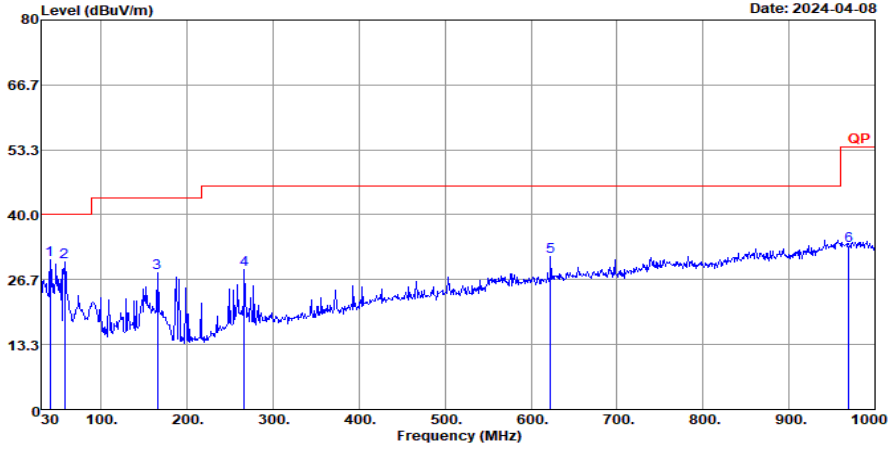

Site : 03CH22-HY
 Condition : QP 3m BILOG63304_231015_1G VERTICAL
 : RBW:120.000KHz VBW:300.000KHz SWT:0.500sec
 :
 Detector : Peak
 Project : 3N2325
 : Channel CH9 Modulation HPRF UWB Frame NA
 : HPRF Set # 13 Payload Length NA
 : Power Offset 59 Post Power Offset 50
 30-300MHz : ponit:1001 SWT:1.000sec
 300-1000MHz : ponit:1001 SWT:1.000sec

	Over	Limit	ReadAntenna	Cable	Preamp	A/Pos	T/Pos	Remark
Freq	Level	Limit	Line	Level	Factor	Loss	Factor	
MHz	dBuV/m	dB	dBuV/m	dBuV	dB/m	dB	dB	
1	40.53	30.68	-9.32	40.00	42.63	19.72	1.06	32.74 --- --- Peak
2	57.00	30.41	-9.59	40.00	49.52	12.30	1.29	32.73 --- --- Peak
3	165.54	28.17	-15.33	43.50	42.42	16.15	2.24	32.71 --- --- Peak
4	265.98	28.72	-17.28	46.00	38.75	19.74	2.85	32.68 --- --- Peak
5	622.70	31.35	-14.65	46.00	33.53	26.17	4.34	32.81 --- --- Peak
6	969.90	33.68	-20.32	54.00	28.36	30.88	5.40	31.19 --- --- Peak

Note 1: ">20dB" means spurious emission levels that exceed the level of 20 dB below the applicable limit.
 Note 2: "N/F" means Nothing Found spurious emissions (No spurious emissions were detected.)
 Note 3: Measurement receive antenna polarization: H (Horizontal), V (Vertical)
 Note 4: Peak emission setting: RBW=120kHz; VBW = 300kHz.



3.5.8 Radiated Emissions (960MHz – 18GHz)

CH05 Radiated Emissions (960MHz – 18GHz)			
Test Mode	Mode 1	Polarization	H
Operating Function	Adapter Mode		
Test Distance	The test distance between the receiving antenna and the EUT is as following: 3m for 1.61 GHz ~ 10.60 GHz frequency range, 1 m for 1GHz ~ 1.61 GHz, and 0.5 m for other frequency ranges.		

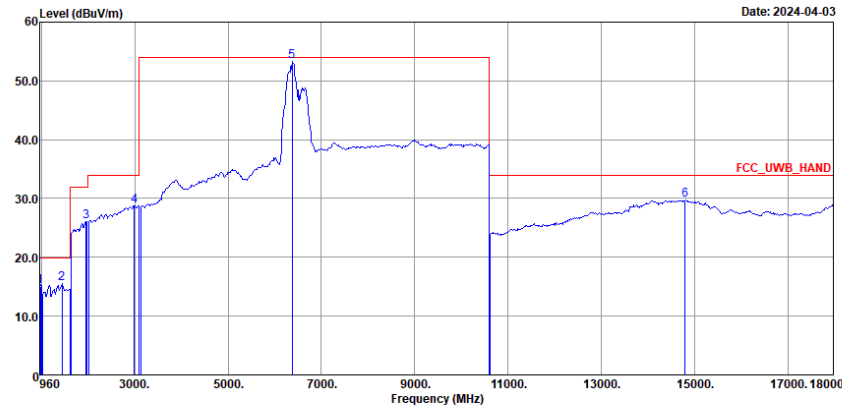

Site : 03CH22-HY
 Condition : FCC_UWB_HAND 3m LE2C04A18EN_230712 HORIZONTAL
 : RBW:1000.000KHz VBW:3000.000KHz
 : .
 Defector : Average
 Project : 3N2325
 : Channel CH5 Modulation BPRF UWB Frame 0
 : HPRF Set # NA Payload Length 125
 : Power Offset 43 Post Power Offset 50
 960-1000MHz : ponit:1001 SWT:1.000sec
 1000-1610MHz : ponit:1001 SWT:1.000sec
 1610-1990MHz : ponit:1001 SWT:1.000sec
 1990-3100MHz : ponit:2001 SWT:2.000sec
 3100-10600MHz : ponit:18001 SWT:18.000sec
 10600-18000MHz : ponit:18001 SWT:18.000sec

	Freq	Level	Over	Limit	ReadAntenna	Cable	Preamp	A/Pos	T/Pos	Remark	Aux	Aux2
	MHz	dBuV/m	Limit	Line	Level	Loss	Factor	cm	deg		Factor	Factor
			dB	dBuV/m	dBuV	dB/m	dB				dB	dB
1	970.84	15.11	-4.82	19.93	25.36	30.86	5.40	31.18	---	---	Average	0.23 -15.56
2	1434.93	15.51	-4.42	19.93	25.42	24.90	6.55	31.82	---	---	Average	-9.54 0.00
3	1953.52	26.14	-5.79	31.93	24.59	25.94	7.70	32.09	---	---	Average	0.00 0.00
4	2984.56	28.81	-5.12	33.93	23.42	28.30	9.57	32.48	---	---	Average	0.00 0.00
5	6377.50	53.28	-0.65	53.93	37.77	36.17	14.30	34.96	---	---	Average	0.00 0.00
6	14803.20	29.79	-4.14	33.93	23.80	42.69	22.28	43.42	---	---	Average	-15.56 0.00

Note 1: “>20dB” means spurious emission levels that exceed the level of 20 dB below the applicable limit.
 Note 2: “N/F” means Nothing Found spurious emissions (No spurious emissions were detected.)
 Note 3: Measurement receive antenna polarization: H (Horizontal), V (Vertical)
 Note 4: Average emission setting outside GPS Bands: RBW=1MHz; VBW=3MHz.
 Note 5: Average emission setting in GPS bands: RBW=1kHz; VBW=3kHz.
 Note 6: #5 is fundamental signal.

Note 7:
 • Distance extrapolation factor = 20 log (test distance [X m]/specific distance [3 m]) (dB)
Example: Distance extrapolation factor = 20log (0.5m/3m) = -15.56 (dB)
 • Corrected Reading: Antenna Factor (dB/m) + Cable Loss (dB) + Read Level (dBuV) - Preamp Factor (dB) + Aux Factor (dB) + Aux 2 Factor (dB) = Level (dBuV/m)
 (Note: For test item below 1GHz, Aux = Filter loss; Aux 2 = Distance extrapolation factor)
 (Note: For test item above 1GHz, Aux = Distance extrapolation factor; Aux 2 = 0, which means the measuring units are not connecting to the Filter)
Example: Corrected Reading: 30.86 (dB/m) + 5.40 (dB) + 25.36 (dBuV) – 31.18 (dB) + 0.23 dB + (-15.56) (dB) = 15.11 (dBuV/m)



CH05 Radiated Emissions (960MHz – 18GHz)			
Test Mode	Mode 1	Polarization	V
Operating Function	Adapter Mode		
Test Distance	The test distance between the receiving antenna and the EUT is as following: 3m for 1.61 GHz ~ 10.60 GHz frequency range, 1 m for 1GHz ~ 1.61 GHz, and 0.5 m for other frequency ranges.		

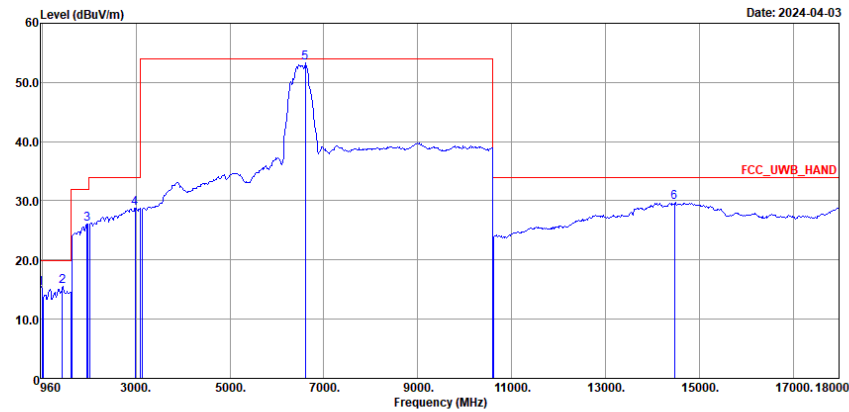

Site : 03CH22-HY
 Condition : FCC_UWB_HAND 3m LE2C04A18EN_230712 VERTICAL
 : RBW:1000.000KHz VBW:3000.000KHz
 : .
 Detector : Average
 Project : 3N2325
 : Channel CH5 Modulation BPRF UWB Frame 0
 : HPRF Set # NA Payload Length 125
 : Power Offset 43 Post Power Offset 50
 960-1000MHz : ponit:1001 SWT:1.000sec
 1000-1610MHz : ponit:1001 SWT:1.000sec
 1610-1990MHz : ponit:1001 SWT:1.000sec
 1990-3100MHz : ponit:2001 SWT:2.000sec
 3100-10600MHz : ponit:18001 SWT:18.000sec
 10600-18000MHz : ponit:18001 SWT:18.000sec

	Freq	Level	Over Limit	Limit Line	ReadAntenna Level	Cable Factor	Preamp Loss	A/Pos	T/Pos	Remark	Aux Factor	Aux2 Factor	
	MHz	dBuV/m	dB	dBuV/m	dBuV	dB/m	dB	dB	cm	deg	dB	dB	
1	960.88	15.22	-4.71	19.93	25.46	31.02	5.37	31.29	---	---	Average	0.22	-15.56
2	1429.44	15.49	-4.44	19.93	25.42	24.89	6.54	31.82	---	---	Average	-9.54	0.00
3	1957.32	26.03	-5.90	31.93	24.46	25.97	7.70	32.10	---	---	Average	0.00	0.00
4	2981.23	28.78	-5.15	33.93	23.39	28.30	9.57	32.48	---	---	Average	0.00	0.00
5	6610.00	53.26	-0.67	53.93	37.33	36.50	14.62	35.19	---	---	Average	0.00	0.00
6	14477.60	29.67	-4.26	33.93	23.89	42.26	22.00	42.92	---	---	Average	-15.56	0.00

Note 1: ">20dB" means spurious emission levels that exceed the level of 20 dB below the applicable limit.
 Note 2: "N/F" means Nothing Found spurious emissions (No spurious emissions were detected.)
 Note 3: Measurement receive antenna polarization: H (Horizontal), V (Vertical)
 Note 4: Average emission setting outside GPS Bands: RBW=1MHz; VBW=3MHz.
 Note 5: Average emission setting in GPS bands: RBW=1kHz; VBW=3kHz.
 Note 6: #5 is fundamental signal.

Note 7:

- Distance extrapolation factor = 20 log (test distance [X m]/specific distance [3 m]) (dB)
- Corrected Reading: Antenna Factor (dB/m) + Cable Loss (dB) + Read Level (dBuV) - Preamp Factor (dB) + Aux Factor (dB) = Level (dBuV/m)
 (Note: For test item below 1GHz, Aux = Filter loss; Aux 2 = Distance extrapolation factor)
 (Note: For test item above 1GHz, Aux = Distance extrapolation factor; Aux 2 = 0, which means the measuring units are not connecting to the Filter)



CH05 Radiated Emissions (960MHz – 18GHz)

Test Mode	Mode 15	Polarization	H
Operating Function	Adapter Mode		
Test Distance	The test distance between the receiving antenna and the EUT is as following: 3m for 1.61 GHz ~ 10.60 GHz frequency range, 1 m for 1GHz ~ 1.61 GHz, and 0.5 m for other frequency ranges.		

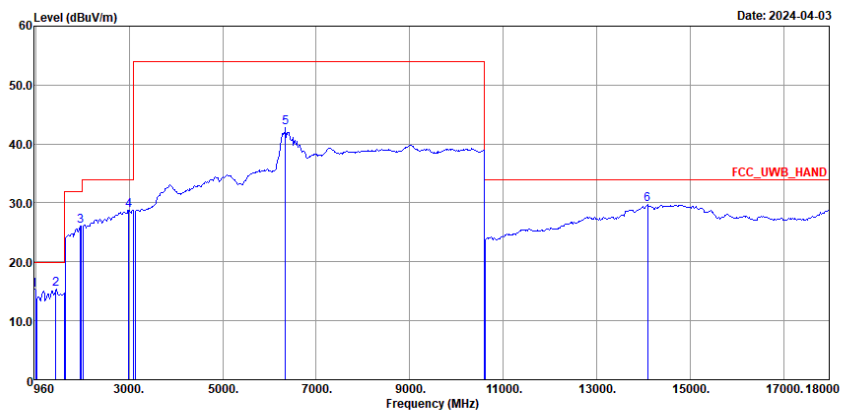

Site : 03CH22-HY
 Condition : FCC_UWB_HAND 3m LE2C04A18EN_230712 HORIZONTAL
 : RBW:1000.000KHz VBW:3000.000KHz
 : .
 Detector : Average
 Project : 3N2325
 : Channel CH5 Modulation HPRF UWB Frame 0
 : HPRF Set # 13 Payload Length NA
 : Power Offset 80 Post Power Offset 50
 960-1000MHz : ponit:1001 SWT:1.000sec
 1000-1610MHz : ponit:1001 SWT:1.000sec
 1610-1990MHz : ponit:1001 SWT:1.000sec
 1990-3100MHz : ponit:2001 SWT:2.000sec
 3100-10600MHz : ponit:18001 SWT:18.000sec
 10600-18000MHz : ponit:18001 SWT:18.000sec

Freq	Level	Over Limit	Limit Line	ReadAntenna	Cable	Preamp	A/Pos	T/Pos	Remark	Aux Factor	Aux2 Factor
MHz	dBuV/m	dB	dBuV/m	dBuV	dB/m	dB	dB	cm	deg	dB	dB
1	970.24	15.28	-4.65	19.93	25.53	30.87	5.40	31.19	---	Average	0.23 -15.56
2	1432.49	15.45	-4.48	19.93	25.36	24.90	6.55	31.82	---	Average	-9.54 0.00
3	1955.04	26.07	-5.86	31.93	24.51	25.95	7.70	32.09	---	Average	0.00 0.00
4	2986.78	28.79	-5.14	33.93	23.39	28.30	9.58	32.48	---	Average	0.00 0.00
5	6340.00	42.73	-11.20	53.93	27.46	35.94	14.26	34.93	---	Average	0.00 0.00
6	14092.80	29.69	-4.24	33.93	23.65	42.19	21.65	42.24	---	Average	-15.56 0.00

Note 1: ">20dB" means spurious emission levels that exceed the level of 20 dB below the applicable limit.
 Note 2: "N/F" means Nothing Found spurious emissions (No spurious emissions were detected.)
 Note 3: Measurement receive antenna polarization: H (Horizontal), V (Vertical)
 Note 4: Average emission setting outside GPS Bands: RBW=1MHz; VBW=3MHz.
 Note 5: Average emission setting in GPS bands: RBW=1kHz; VBW=3kHz.
 Note 6: #5 is fundamental signal.

Note 7:

- Distance extrapolation factor = 20 log (test distance [X m]/specific distance [3 m]) (dB)
Example: Distance extrapolation factor = 20log (0.5m/3m) = -15.56 (dB)
- Corrected Reading: Antenna Factor (dB/m) + Cable Loss (dB) + Read Level (dBuV) - Preamp Factor (dB) + Aux Factor (dB) + Aux 2 Factor (dB) = Level (dBuV/m)
 (Note: For test item below 1GHz, Aux = Filter loss; Aux 2 = Distance extrapolation factor)
 (Note: For test item above 1GHz, Aux = Distance extrapolation factor; Aux 2 = 0, which means the measuring units are not connecting to the Filter)
Example: Corrected Reading: 30.87 (dB/m) + 5.40 (dB) + 25.53 (dBuV) – 31.19 (dB) + 0.23 dB + (-15.56) (dB) = 15.28 (dBuV/m)



CH05 Radiated Emissions (960MHz – 18GHz)			
Test Mode	Mode 15	Polarization	V
Operating Function	Adapter Mode		
Test Distance	The test distance between the receiving antenna and the EUT is as following: 3m for 1.61 GHz ~ 10.60 GHz frequency range, 1 m for 1GHz ~ 1.61 GHz, and 0.5 m for other frequency ranges.		

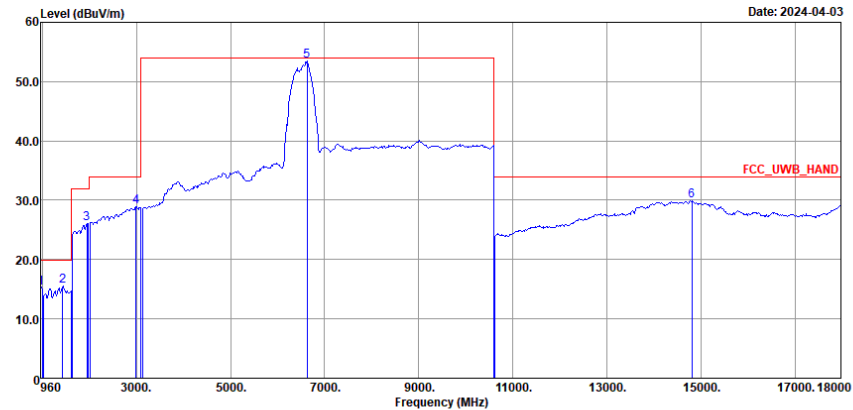

Site : 03CH22-HY
 Condition : FCC_UWB_HAND 3m LE2C04A18EN_230712 VERTICAL
 : RBW:1000.000KHz VBW:3000.000KHz
 : .
 Detector : Average
 Project : 3N2325
 : Channel CH5 Modulation HPRF UWB Frame 0
 : HPRF Set # 13 Payload Length NA
 : Power Offset 80 Post Power Offset 50
 960-1000MHz : ponit:1001 SWT:1.000sec
 1000-1610MHz : ponit:1001 SWT:1.000sec
 1610-1990MHz : ponit:1001 SWT:1.000sec
 1990-3100MHz : ponit:2001 SWT:2.000sec
 3100-10600MHz : ponit:18001 SWT:18.000sec
 10600-18000MHz : ponit:18001 SWT:18.000sec

	Freq	Level	Over Limit	Limit Line	ReadAntenna Level	Cable Loss	Preamp Factor	A/Pos	T/Pos	Remark	Aux Factor	Aux2 Factor
	MHz	dBuV/m	dB	dBuV/m	dBuV	dB/m	dB	dB	cm	deg	dB	dB
1	965.92	15.16	-4.77	19.93	25.41	30.93	5.39	31.23	---	Average	0.22	-15.56
2	1434.32	15.53	-4.40	19.93	25.44	24.90	6.55	31.82	---	Average	-9.54	0.00
3	1945.54	26.15	-5.78	31.93	24.70	25.86	7.68	32.09	---	Average	0.00	0.00
4	2993.44	28.86	-5.07	33.93	23.45	28.30	9.59	32.48	---	Average	0.00	0.00
5	6625.00	53.54	-0.39	53.93	37.62	36.50	14.63	35.21	---	Average	0.00	0.00
6	14810.60	29.89	-4.04	33.93	23.91	42.68	22.29	43.43	---	Average	-15.56	0.00

Note 1: ">20dB" means spurious emission levels that exceed the level of 20 dB below the applicable limit.
 Note 2: "N/F" means Nothing Found spurious emissions (No spurious emissions were detected.)
 Note 3: Measurement receive antenna polarization: H (Horizontal), V (Vertical)
 Note 4: Average emission setting outside GPS Bands: RBW=1MHz; VBW=3MHz.
 Note 5: Average emission setting in GPS bands: RBW=1kHz; VBW=3kHz.
 Note 6: #5 is fundamental signal.

Note 7:

- Distance extrapolation factor = 20 log (test distance [X m]/specific distance [3 m]) (dB)
- Corrected Reading: Antenna Factor (dB/m) + Cable Loss (dB) + Read Level (dBuV) - Preamp Factor (dB) + Aux Factor (dB) = Level (dBuV/m)
 (Note: For test item below 1GHz, Aux = Filter loss; Aux 2 = Distance extrapolation factor)
 (Note: For test item above 1GHz, Aux = Distance extrapolation factor; Aux 2 = 0, which means the measuring units are not connecting to the Filter)



CH09 Radiated Emissions (960MHz – 18GHz)			
Test Mode	Mode 12	Polarization	H
Operating Function	Adapter Mode		
Test Distance	The test distance between the receiving antenna and the EUT is as following: 3m for 1.61 GHz ~ 10.60 GHz frequency range, 1 m for 1GHz ~ 1.61 GHz, and 0.5 m for other frequency ranges.		

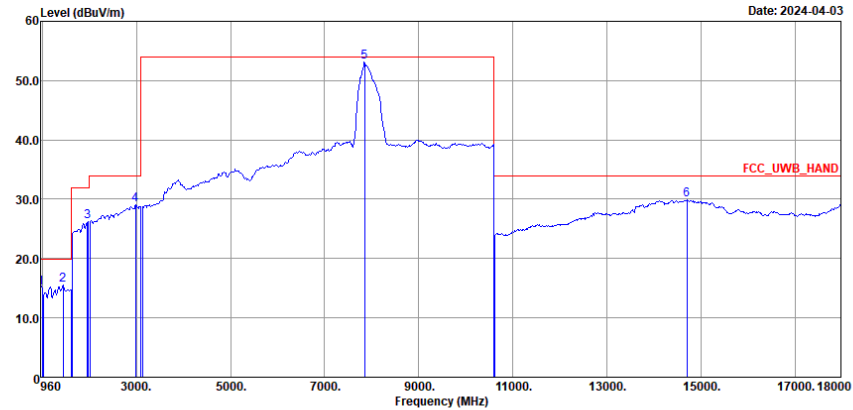

Site : 03CH22-HY
 Condition : FCC_UWB_HAND 3m LE2C04A18EN_230712 HORIZONTAL
 : RBW:1000.000KHz VBW:3000.000KHz
 : .
 Detector : Average
 Project : 3N2325
 : Channel CH9 Modulation BPRF UWB Frame 3
 : HPRF Set # NA Payload Length NA
 : Power Offset 48 Post Power Offset 50
 960-1000MHz : ponit:1001 SWT:1.000sec
 1000-1610MHz : ponit:1001 SWT:1.000sec
 1610-1990MHz : ponit:1001 SWT:1.000sec
 1990-3100MHz : ponit:2001 SWT:2.000sec
 3100-10600MHz : ponit:18001 SWT:18.000sec
 10600-18000MHz : ponit:18001 SWT:18.000sec

	Freq	Level	Over	Limit	ReadAntenna	Cable	Preamp	A/Pos	T/Pos	Remark	Aux	Aux2
	MHz	dBuV/m	Limit	Line	Level	Loss	Factor	cm	deg		Factor	Factor
			dB	dBuV/m	dBuV	dB/m	dB				dB	dB
1	961.96	14.98	-4.95	19.93	25.23	30.99	5.38	31.28	---	Average	0.22	-15.56
2	1435.54	15.57	-4.36	19.93	25.47	24.90	6.56	31.82	---	Average	-9.54	0.00
3	1954.28	26.16	-5.77	31.93	24.61	25.94	7.70	32.09	---	Average	0.00	0.00
4	2977.90	29.00	-4.93	33.93	23.62	28.30	9.56	32.48	---	Average	0.00	0.00
5	7847.50	53.18	-0.75	53.93	36.46	37.10	16.02	36.40	---	Average	0.00	0.00
6	14699.60	29.90	-4.03	33.93	23.73	42.80	22.19	43.26	---	Average	-15.56	0.00

- Note 1: ">20dB" means spurious emission levels that exceed the level of 20 dB below the applicable limit.
 Note 2: "N/F" means Nothing Found spurious emissions (No spurious emissions were detected.)
 Note 3: Measurement receive antenna polarization: H (Horizontal), V (Vertical)
 Note 4: Average emission setting outside GPS Bands: RBW=1MHz; VBW=3MHz.
 Note 5: Average emission setting in GPS bands: RBW=1kHz; VBW=3kHz.
 Note 6: #5 is fundamental signal.

Note 7:

- Distance extrapolation factor = 20 log (test distance [X m]/specific distance [3 m]) (dB)
- Corrected Reading: Antenna Factor (dB/m) + Cable Loss (dB) + Read Level (dBuV) - Preamp Factor (dB) + Aux Factor (dB) = Level (dBuV/m)
 (Note: For test item below 1GHz, Aux = Filter loss; Aux 2 = Distance extrapolation factor)
 (Note: For test item above 1GHz, Aux = Distance extrapolation factor; Aux 2 = 0, which means the measuring units are not connecting to the Filter)



CH09 Radiated Emissions (960MHz – 18GHz)			
Test Mode	Mode 12	Polarization	V
Operating Function	Adapter Mode		
Test Distance	The test distance between the receiving antenna and the EUT is as following: 3m for 1.61 GHz ~ 10.60 GHz frequency range, 1 m for 1GHz ~ 1.61 GHz, and 0.5 m for other frequency ranges.		

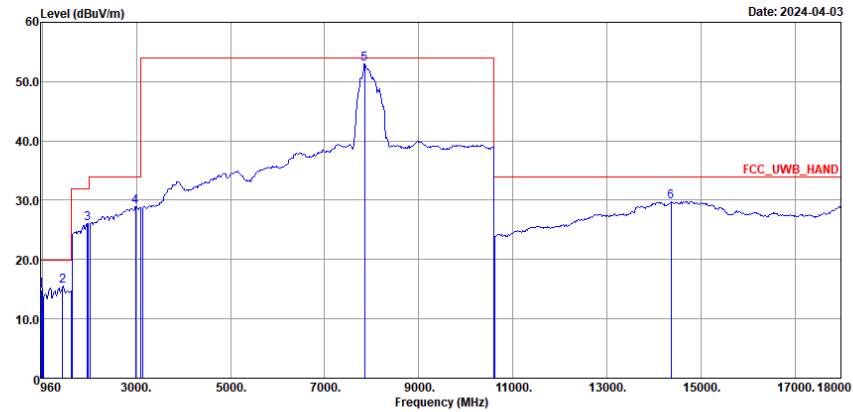

Site : 03CH22-HY
 Condition : FCC_UWB_HAND 3m LE2C04A18EN_230712 VERTICAL
 : RBW:1000.000KHz VBW:3000.000KHz
 : .
 Detector : Average
 Project : 3N2325
 : Channel CH9 Modulation BPRF UWB Frame 3
 : HPRF Set # NA Payload Length NA
 : Power Offset 48 Post Power Offset 50
 960-1000MHz : ponit:1001 SWT:1.000sec
 1000-1610MHz : ponit:1001 SWT:1.000sec
 1610-1990MHz : ponit:1001 SWT:1.000sec
 1990-3100MHz : ponit:2001 SWT:2.000sec
 3100-10600MHz : ponit:18001 SWT:18.000sec
 10600-18000MHz : ponit:18001 SWT:18.000sec

Freq	Level	Over Limit	Line	ReadAntenna	Cable	Preamp	A/Pos	T/Pos	Remark	Aux Factor	Aux2 Factor		
MHz	dBuV/m	dB	dBuV/m	dBuV	dB/m	dB	dB	cm	deg	dB	dB		
1	975.12	14.93	-5.00	19.93	25.12	30.84	5.42	31.13	---	---	Average	0.24	-15.56
2	1434.32	15.58	-4.35	19.93	25.49	24.90	6.55	31.82	---	---	Average	-9.54	0.00
3	1953.90	26.13	-5.80	31.93	24.58	25.94	7.70	32.09	---	---	Average	0.00	0.00
4	2981.23	28.87	-5.06	33.93	23.48	28.30	9.57	32.48	---	---	Average	0.00	0.00
5	7847.50	52.99	-0.94	53.93	36.27	37.10	16.02	36.40	---	---	Average	0.00	0.00
6	14366.60	29.80	-4.13	33.93	23.89	42.30	21.90	42.73	---	---	Average	-15.56	0.00

Note 1: ">20dB" means spurious emission levels that exceed the level of 20 dB below the applicable limit.

Note 2: "N/F" means Nothing Found spurious emissions (No spurious emissions were detected.)

Note 3: Measurement receive antenna polarization: H (Horizontal), V (Vertical)

Note 4: Average emission setting outside GPS Bands: RBW=1MHz; VBW=3MHz.

Note 5: Average emission setting in GPS bands: RBW=1kHz; VBW=3kHz.

Note 6: #5 is fundamental signal.

Note 7:

- Distance extrapolation factor = 20 log (test distance [X m]/specific distance [3 m]) (dB)
- Corrected Reading: Antenna Factor (dB/m) + Cable Loss (dB) + Read Level (dBuV) - Preamp Factor (dB) + Aux Factor (dB) = Level (dBuV/m)
 (Note: For test item below 1GHz, Aux = Filter loss; Aux 2 = Distance extrapolation factor)
 (Note: For test item above 1GHz, Aux = Distance extrapolation factor; Aux 2 = 0, which means the measuring units are not connecting to the Filter)



CH09 Radiated Emissions (960MHz – 18GHz)

Test Mode	Mode 14	Polarization	H
Operating Function	Adapter Mode		
Test Distance	The test distance between the receiving antenna and the EUT is as following: 3m for 1.61 GHz ~ 10.60 GHz frequency range, 1 m for 1GHz ~ 1.61 GHz, and 0.5 m for other frequency ranges.		

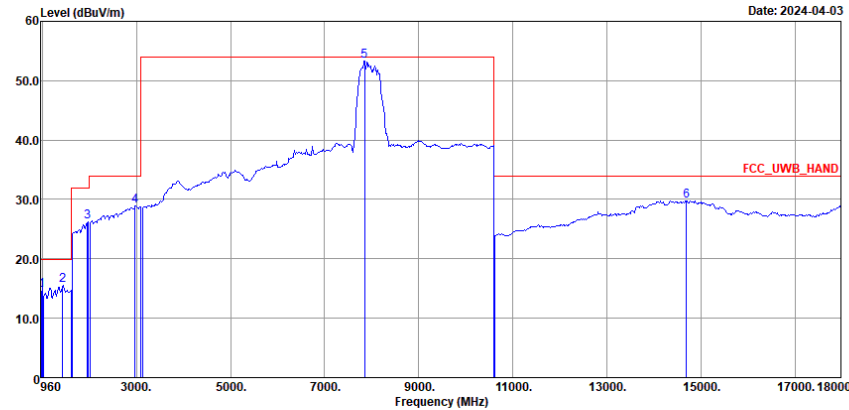

Site : 03CH22-HY
 Condition : FCC_UWB_HAND 3m LE2C04A18EN_230712 HORIZONTAL
 : RBW:1000.000KHz VBW:3000.000KHz
 : .
 Detector : Average
 Project : 3N2325
 : Channel CH9 Modulation HPRF UWB Frame NA
 : HPRF Set # 13 Payload Length NA
 : Power Offset 59 Post Power Offset 50
 960-1000MHz : ponit:1001 SWT:1.000sec
 1000-1610MHz : ponit:1001 SWT:1.000sec
 1610-1990MHz : ponit:1001 SWT:1.000sec
 1990-3100MHz : ponit:2001 SWT:2.000sec
 3100-10600MHz : ponit:18001 SWT:18.000sec
 10600-18000MHz : ponit:18001 SWT:18.000sec

	Freq	Level	Over	Limit	ReadAntenna	Cable	Preamp	A/Pos	T/Pos	Remark	Aux	Aux2
	MHz	dBuV/m	Limit	Line	Level	Loss	Factor	cm	deg		Factor	Factor
			dB	dBuV/m	dBuV	dB/m	dB				dB	dB
1	985.28	14.74	-5.19	19.93	24.97	30.65	5.45	31.02	---	Average	0.25	-15.56
2	1430.66	15.54	-4.39	19.93	25.46	24.90	6.54	31.82	---	Average	-9.54	0.00
3	1955.04	26.17	-5.76	31.93	24.61	25.95	7.70	32.09	---	Average	0.00	0.00
4	2970.13	28.90	-5.03	33.93	23.53	28.30	9.55	32.48	---	Average	0.00	0.00
5	7847.50	53.38	-0.55	53.93	36.66	37.10	16.02	36.40	---	Average	0.00	0.00
6	14692.20	29.83	-4.10	33.93	23.67	42.78	22.19	43.25	---	Average	-15.56	0.00

- Note 1: ">20dB" means spurious emission levels that exceed the level of 20 dB below the applicable limit.
- Note 2: "N/F" means Nothing Found spurious emissions (No spurious emissions were detected.)
- Note 3: Measurement receive antenna polarization: H (Horizontal), V (Vertical)
- Note 4: Average emission setting outside GPS Bands: RBW=1MHz; VBW=3MHz.
- Note 5: Average emission setting in GPS bands: RBW=1kHz; VBW=3kHz.
- Note 6: #5 is fundamental signal.

- Note 7:
- Distance extrapolation factor = 20 log (test distance [X m]/specific distance [3 m]) (dB)
 - Corrected Reading: Antenna Factor (dB/m) + Cable Loss (dB) + Read Level (dBuV) - Preamp Factor (dB) + Aux Factor (dB) = Level (dBuV/m)
 (Note: For test item below 1GHz, Aux = Filter loss; Aux 2 = Distance extrapolation factor)
 (Note: For test item above 1GHz, Aux = Distance extrapolation factor; Aux 2 = 0, which means the measuring units are not connecting to the Filter)



CH09 Radiated Emissions (960MHz – 18GHz)			
Test Mode	Mode 14	Polarization	V
Operating Function	Adapter Mode		
Test Distance	The test distance between the receiving antenna and the EUT is as following: 3m for 1.61 GHz ~ 10.60 GHz frequency range, 1 m for 1GHz ~ 1.61 GHz, and 0.5 m for other frequency ranges.		

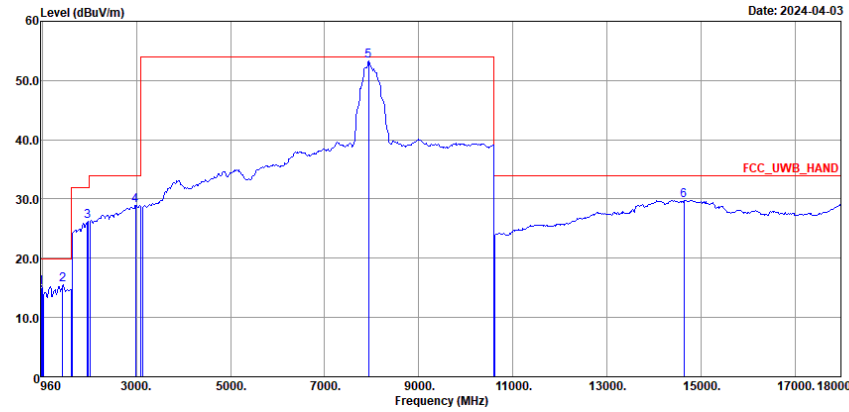

Site : 03CH22-HY
 Condition : FCC_UWB_HAND 3m LE2C04A18EN_230712 VERTICAL
 : RBW:1000.000KHz VBW:3000.000KHz
 : .
 Detector : Average
 Project : 3N2325
 : Channel CH9 Modulation HPRF UWB Frame NA
 : HPRF Set # 13 Payload Length NA
 : Power Offset 59 Post Power Offset 50
 960-1000MHz : ponit:1001 SWT:1.000sec
 1000-1610MHz : ponit:1001 SWT:1.000sec
 1610-1990MHz : ponit:1001 SWT:1.000sec
 1990-3100MHz : ponit:2001 SWT:2.000sec
 3100-10600MHz : ponit:18001 SWT:18.000sec
 10600-18000MHz : ponit:18001 SWT:18.000sec

Freq	Level	Over Limit	Limit Line	ReadAntenna Level	Cable Factor	Preamp Loss	A/Pos	T/Pos	Remark	Aux Factor	Aux2 Factor		
MHz	dBuV/m	dB	dBuV/m	dBuV	dB/m	dB	dB	cm	deg	dB	dB		
1	976.24	14.96	-4.97	19.93	25.15	30.83	5.42	31.12	---	---	Average	0.24	-15.56
2	1431.27	15.58	-4.35	19.93	25.49	24.90	6.55	31.82	---	---	Average	-9.54	0.00
3	1953.52	26.22	-5.71	31.93	24.67	25.94	7.70	32.09	---	---	Average	0.00	0.00
4	2979.01	28.95	-4.98	33.93	23.57	28.30	9.56	32.48	---	---	Average	0.00	0.00
5	7937.50	53.25	-0.68	53.93	36.47	37.20	16.09	36.51	---	---	Average	0.00	0.00
6	14640.40	29.83	-4.10	33.93	23.76	42.66	22.14	43.17	---	---	Average	-15.56	0.00

Note 1: ">20dB" means spurious emission levels that exceed the level of 20 dB below the applicable limit.
 Note 2: "N/F" means Nothing Found spurious emissions (No spurious emissions were detected.)
 Note 3: Measurement receive antenna polarization: H (Horizontal), V (Vertical)
 Note 4: Average emission setting outside GPS Bands: RBW=1MHz; VBW=3MHz.
 Note 5: Average emission setting in GPS bands: RBW=1kHz; VBW=3kHz.
 Note 6: #5 is fundamental signal.

Note 7:

- Distance extrapolation factor = 20 log (test distance [X m]/specific distance [3 m]) (dB)
- Corrected Reading: Antenna Factor (dB/m) + Cable Loss (dB) + Read Level (dBuV) - Preamp Factor (dB) + Aux Factor (dB) = Level (dBuV/m)
 (Note: For test item below 1GHz, Aux = Filter loss; Aux 2 = Distance extrapolation factor)
 (Note: For test item above 1GHz, Aux = Distance extrapolation factor; Aux 2 = 0, which means the measuring units are not connecting to the Filter)



3.5.9 Radiated Emissions (1164MHz – 1240MHz)

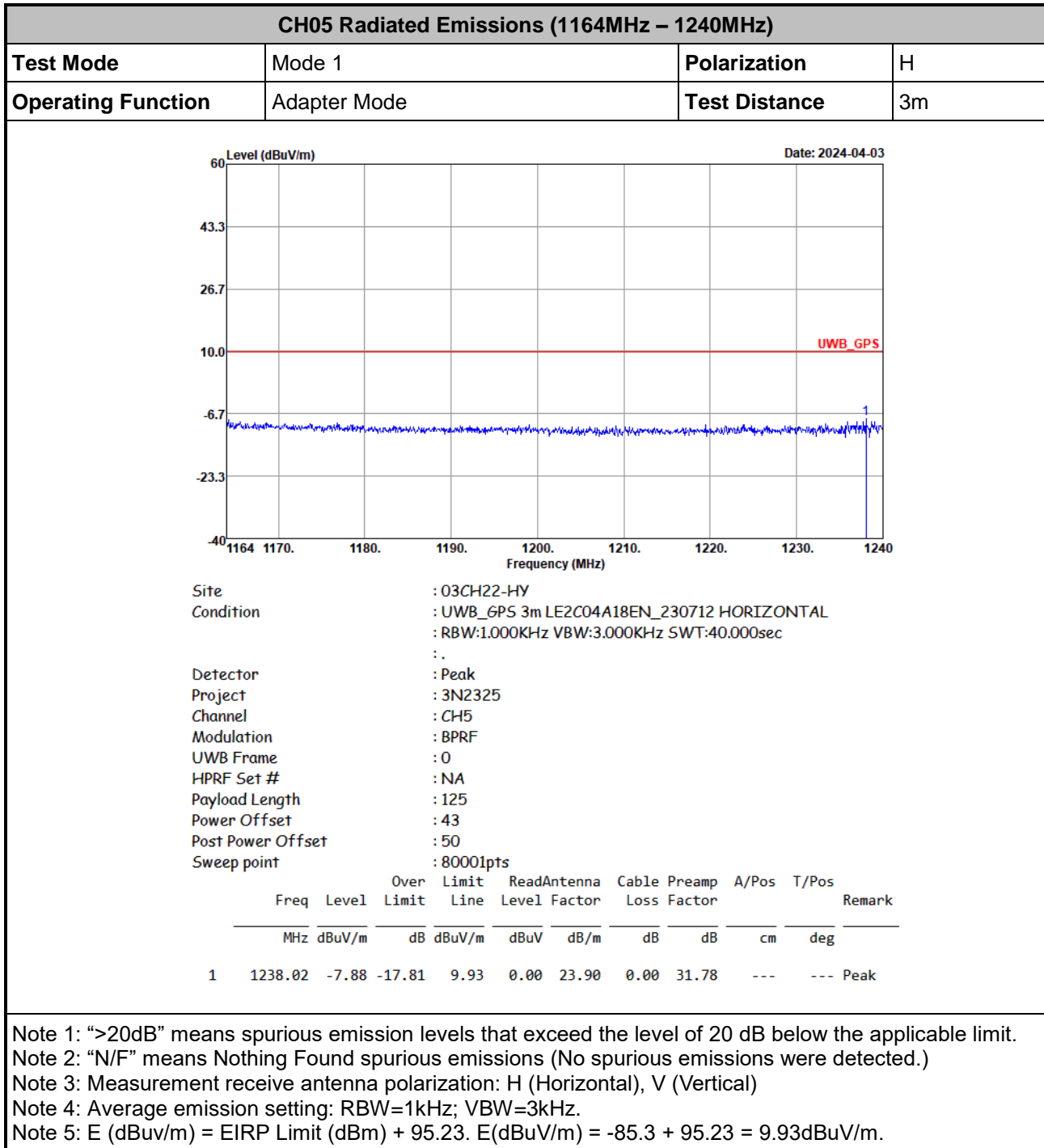



CH05 Radiated Emissions (1164MHz – 1240MHz)

Test Mode	Mode 1	Polarization	V
Operating Function	Adapter Mode	Test Distance	3m

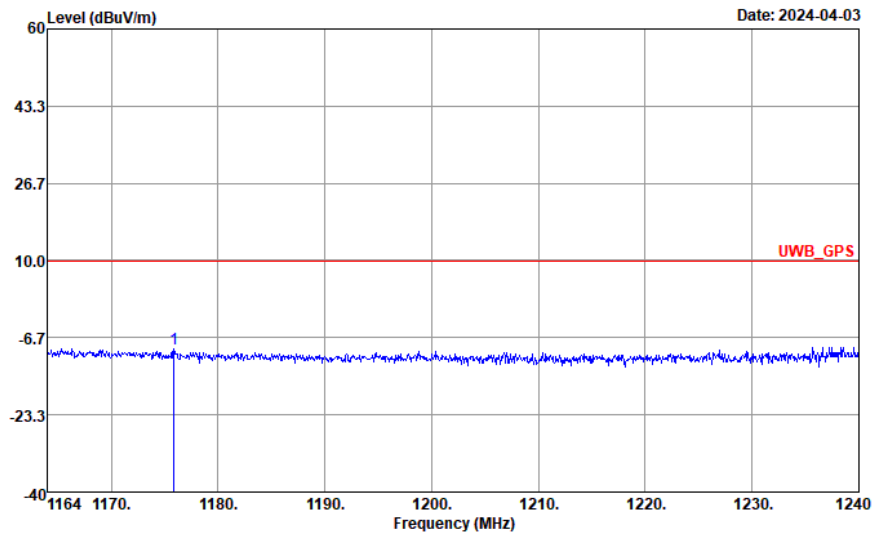

Site : 03CH22-HY
 Condition : UWB_GPS 3m LE2C04A18EN_230712 VERTICAL
 : RBW:1.000KHz VBW:3.000KHz SWT:40.000sec
 :.
 Detector : Peak
 Project : 3N2325
 Channel : CH5
 Modulation : BPRF
 UWB Frame : 0
 HPRF Set # : NA
 Payload Length : 125
 Power Offset : 43
 Post Power Offset : 50
 Sweep point : 80001pts

Freq	Level	Over Limit	Limit Line	ReadAntenna Level	Antenna Factor	Cable Loss	Preamp Loss	A/Pos	T/Pos	Remark	
MHz	dBuV/m	dB	dBuV/m	dBuV	dB/m	dB	dB	cm	deg		
1	1175.86	-9.10	-19.03	9.93	-1.45	24.12	0.00	31.77	---	---	Peak

- Note 1: ">20dB" means spurious emission levels that exceed the level of 20 dB below the applicable limit.
- Note 2: "N/F" means Nothing Found spurious emissions (No spurious emissions were detected.)
- Note 3: Measurement receive antenna polarization: H (Horizontal), V (Vertical)
- Note 4: Average emission setting: RBW=1kHz; VBW=3kHz.
- Note 5: E (dBuV/m) = EIRP Limit (dBm) + 95.23. E(dBuV/m) = -85.3 + 95.23 = 9.93dBuV/m.

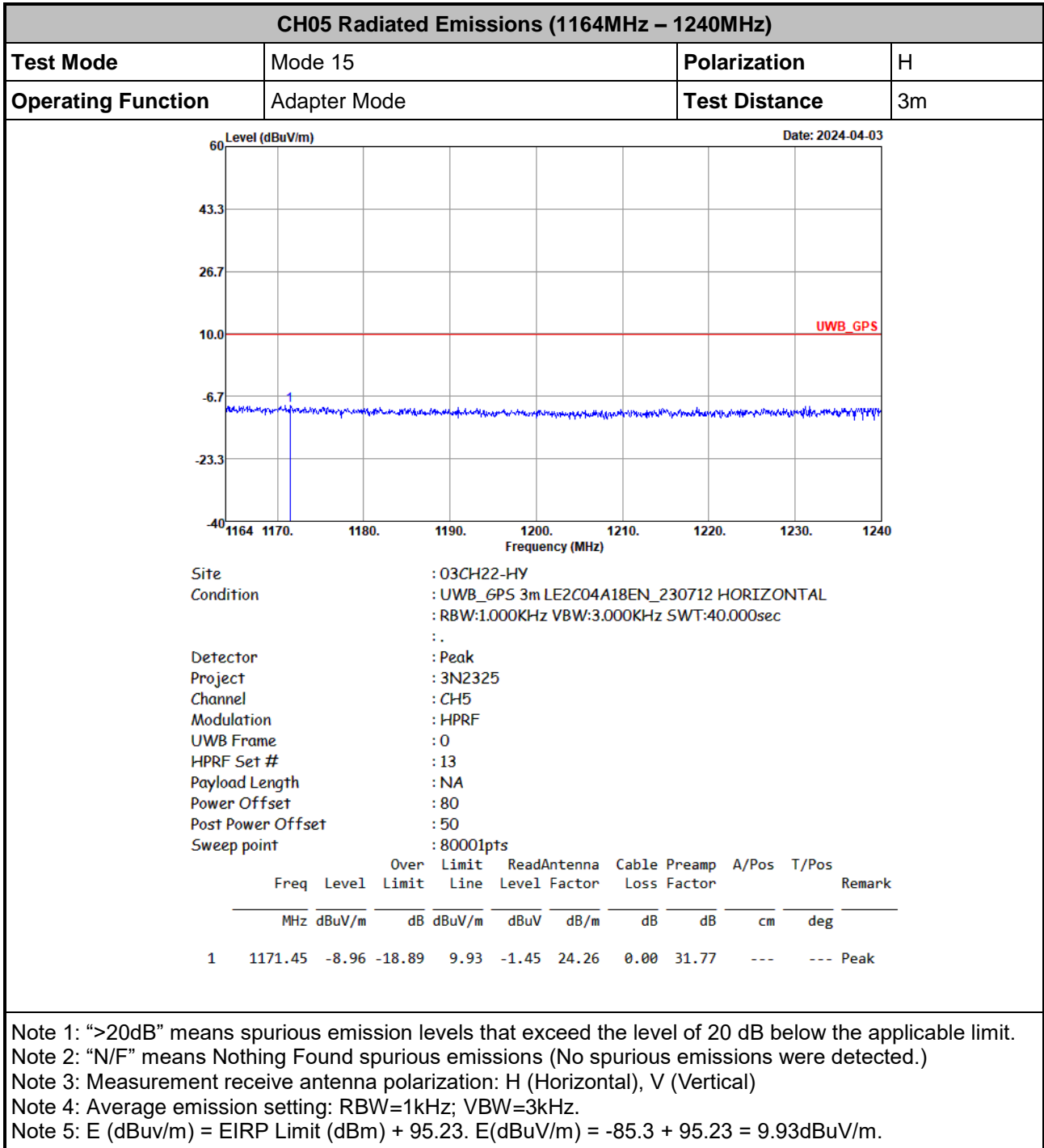



CH05 Radiated Emissions (1164MHz – 1240MHz)

Test Mode	Mode 15	Polarization	V
Operating Function	Adapter Mode	Test Distance	3m

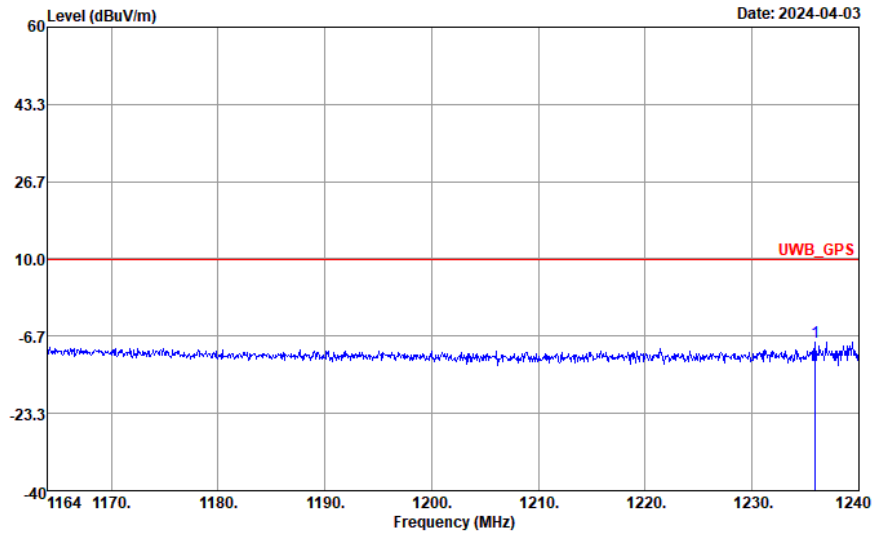

Site : 03CH22-HY
 Condition : UWB_GPS 3m LE2C04A18EN_230712 VERTICAL
 : RBW:1.000KHz VBW:3.000KHz SWT:40.000sec
 :.
 Detector : Peak
 Project : 3N2325
 Channel : CH5
 Modulation : HPRF
 UWB Frame : 0
 HPRF Set # : 13
 Payload Length : NA
 Power Offset : 80
 Post Power Offset : 50
 Sweep point : 80001pts

	Over	Limit	ReadAntenna	Cable	Preamp	A/Pos	T/Pos	Remark			
Freq	Level	Limit	Line	Level	Factor	Loss	Factor				
MHz	dBuV/m	dB	dBuV/m	dBuV	dB/m	dB	dB	cm	deg		
1	1235.90	-7.88	-17.81	9.93	0.00	23.90	0.00	31.78	---	---	Peak

- Note 1: ">20dB" means spurious emission levels that exceed the level of 20 dB below the applicable limit.
- Note 2: "N/F" means Nothing Found spurious emissions (No spurious emissions were detected.)
- Note 3: Measurement receive antenna polarization: H (Horizontal), V (Vertical)
- Note 4: Average emission setting: RBW=1kHz; VBW=3kHz.
- Note 5: E (dBuV/m) = EIRP Limit (dBm) + 95.23. E(dBuV/m) = -85.3 + 95.23 = 9.93dBuV/m.



CH09 Radiated Emissions (1164MHz – 1240MHz)

Test Mode	Mode 12	Polarization	H
Operating Function	Adapter Mode	Test Distance	3m

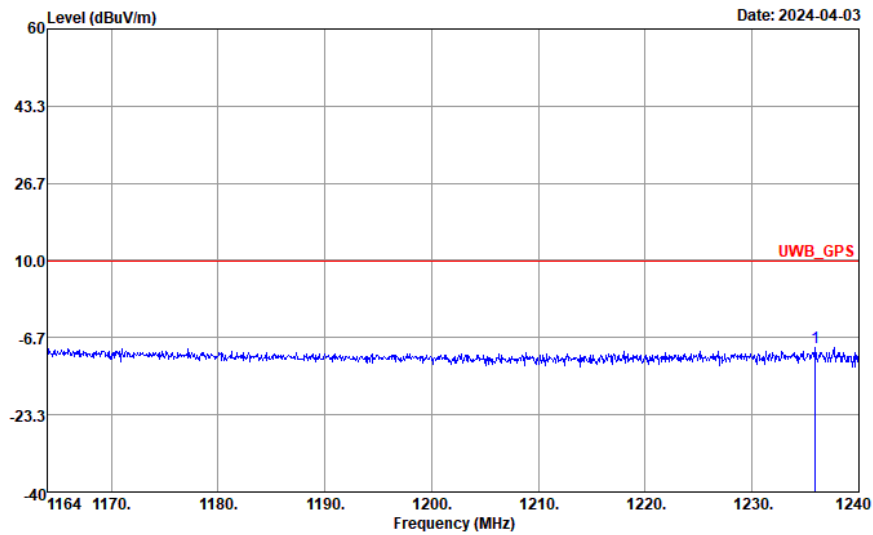

Site : 03CH22-HY
 Condition : UWB_GPS 3m LE2C04A18EN_230712 HORIZONTAL
 : RBW:1.000KHz VBW:3.000KHz SWT:40.000sec
 :
 Detector : Peak
 Project : 3N2325
 Channel : CH9
 Modulation : BPRF
 UWB Frame : 3
 HPRF Set # : NA
 Payload Length : NA
 Power Offset : 48
 Post Power Offset : 50
 Sweep point : 80001pts

Freq	Level	Over	Limit	ReadAntenna	Cable	Preamp	A/Pos	T/Pos	Remark
MHz	dBuV/m	dB	dBuV/m	dBuV	dB/m	dB	dB	cm	deg
1	1235.90	-8.88	-18.81	9.93	-1.00	23.90	0.00	31.78	--- Peak

- Note 1: ">20dB" means spurious emission levels that exceed the level of 20 dB below the applicable limit.
- Note 2: "N/F" means Nothing Found spurious emissions (No spurious emissions were detected.)
- Note 3: Measurement receive antenna polarization: H (Horizontal), V (Vertical)
- Note 4: Average emission setting: RBW=1kHz; VBW=3kHz.
- Note 5: E (dBuV/m) = EIRP Limit (dBm) + 95.23. E(dBuV/m) = -85.3 + 95.23 = 9.93dBuV/m.



CH09 Radiated Emissions (1164MHz – 1240MHz)

Test Mode	Mode 12	Polarization	V
Operating Function	Adapter Mode	Test Distance	3m

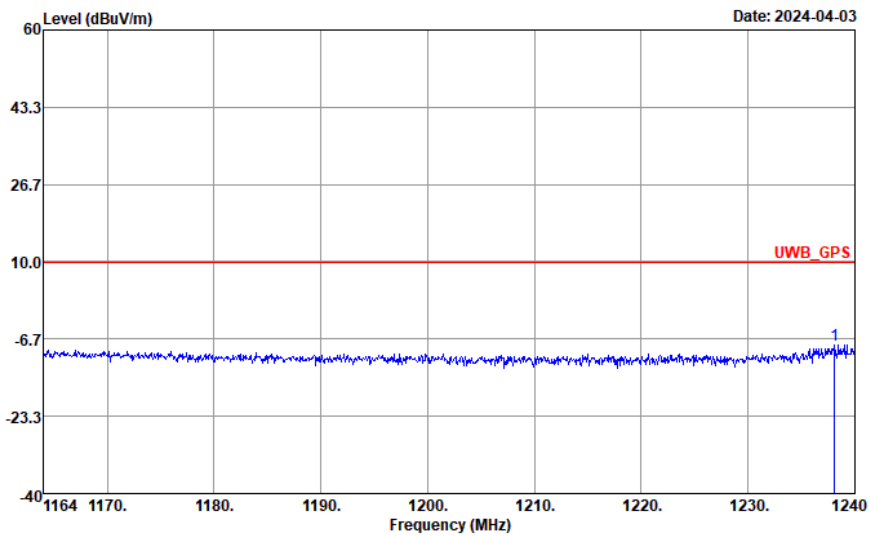

Site : 03CH22-HY
 Condition : UWB_GPS 3m LE2C04A18EN_230712 VERTICAL
 : RBW:1.000KHz VBW:3.000KHz SWT:40.000sec
 :.
 Detector : Peak
 Project : 3N2325
 Channel : CH9
 Modulation : BPRF
 UWB Frame : 3
 HPRF Set # : NA
 Payload Length : NA
 Power Offset : 48
 Post Power Offset : 50
 Sweep point : 80001pts

	Over	Limit	ReadAntenna	Cable	Preamp	A/Pos	T/Pos				
Freq	Level	Limit	Line	Level	Factor	Loss	Factor	Remark			
MHz	dBuV/m	dB	dBuV/m	dBuV	dB/m	dB	dB	cm	deg		
1	1238.10	-7.88	-17.81	9.93	0.00	23.90	0.00	31.78	---	---	Peak

- Note 1: ">20dB" means spurious emission levels that exceed the level of 20 dB below the applicable limit.
- Note 2: "N/F" means Nothing Found spurious emissions (No spurious emissions were detected.)
- Note 3: Measurement receive antenna polarization: H (Horizontal), V (Vertical)
- Note 4: Average emission setting: RBW=1kHz; VBW=3kHz.
- Note 5: E (dBuV/m) = EIRP Limit (dBm) + 95.23. E(dBuV/m) = -85.3 + 95.23 = 9.93dBuV/m.



CH09 Radiated Emissions (1164MHz – 1240MHz)

Test Mode	Mode 14	Polarization	H
Operating Function	Adapter Mode	Test Distance	3m

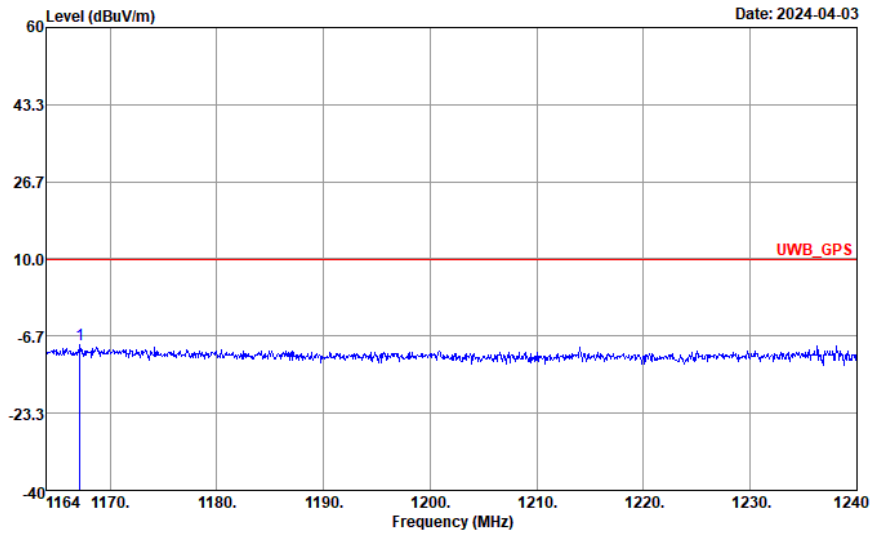

Site : 03CH22-HY
 Condition : UWB_GPS 3m LE2C04A18EN_230712 HORIZONTAL
 : RBW:1.000KHz VBW:3.000KHz SWT:40.000sec
 :
 Detector : Peak
 Project : 3N2325
 Channel : CH9
 Modulation : HPRF
 UWB Frame : NA
 HPRF Set # : 13
 Payload Length : NA
 Power Offset : 59
 Post Power Offset : 50
 Sweep point : 80001pts

	Freq	Level	Over Limit	Limit Line	ReadAntenna Level	Antenna Factor	Cable Loss	Preamp Loss	A/Pos	T/Pos	Remark
	MHz	dBuV/m	dB	dBuV/m	dBuV	dB/m	dB	dB	cm	deg	
1	1167.19	-8.56	-18.49	9.93	-1.12	24.33	0.00	31.77	---	---	Peak

- Note 1: ">20dB" means spurious emission levels that exceed the level of 20 dB below the applicable limit.
- Note 2: "N/F" means Nothing Found spurious emissions (No spurious emissions were detected.)
- Note 3: Measurement receive antenna polarization: H (Horizontal), V (Vertical)
- Note 4: Average emission setting: RBW=1kHz; VBW=3kHz.
- Note 5: E (dBuV/m) = EIRP Limit (dBm) + 95.23. E(dBuV/m) = -85.3 + 95.23 = 9.93dBuV/m.



CH09 Radiated Emissions (1164MHz – 1240MHz)

Test Mode	Mode 14	Polarization	V
Operating Function	Adapter Mode	Test Distance	3m

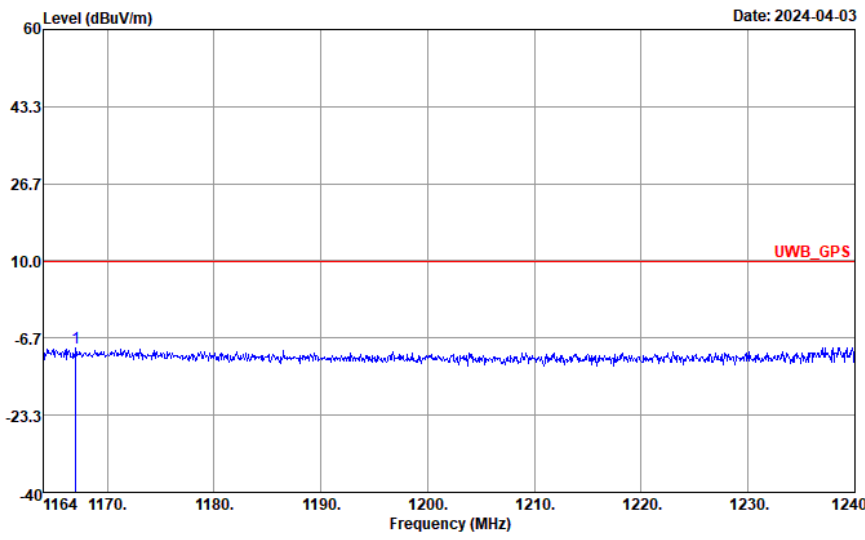

Site : 03CH22-HY
 Condition : UWB_GPS 3m LE2C04A18EN_230712 VERTICAL
 : RBW:1.000KHz VBW:3.000KHz SWT:40.000sec
 :.
 Detector : Peak
 Project : 3N2325
 Channel : CH9
 Modulation : HPRF
 UWB Frame : NA
 HPRF Set # : 13
 Payload Length : NA
 Power Offset : 59
 Post Power Offset : 50
 Sweep point : 80001pts

1	Freq	Level	Over Limit	Limit Line	Read Level	Antenna Factor	Cable Loss	Preamp Loss	A/Pos	T/Pos	Remark
	MHz	dBuV/m	dB	dBuV/m	dBuV	dB/m	dB	dB	cm	deg	
1	1167.04	-8.86	-18.79	9.93	-1.42	24.33	0.00	31.77	---	---	Peak

- Note 1: ">20dB" means spurious emission levels that exceed the level of 20 dB below the applicable limit.
- Note 2: "N/F" means Nothing Found spurious emissions (No spurious emissions were detected.)
- Note 3: Measurement receive antenna polarization: H (Horizontal), V (Vertical)
- Note 4: Average emission setting: RBW=1kHz; VBW=3kHz.
- Note 5: E (dBuV/m) = EIRP Limit (dBm) + 95.23. E(dBuV/m) = -85.3 + 95.23 = 9.93dBuV/m.



3.5.10 Radiated Emissions (1559MHz – 1610MHz)

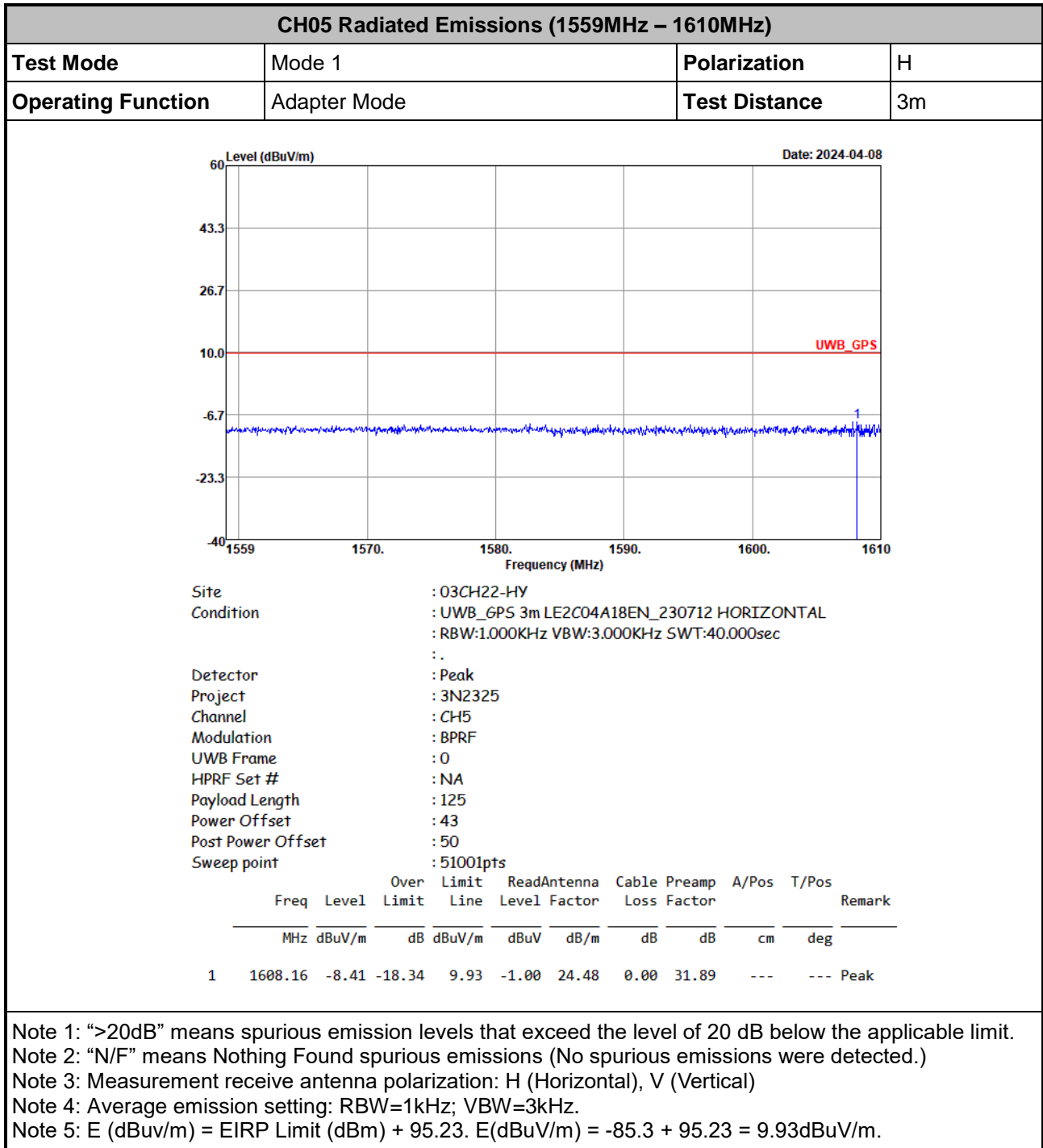



CH05 Radiated Emissions (1559MHz – 1610MHz)

Test Mode	Mode 1	Polarization	V
Operating Function	Adapter Mode	Test Distance	3m

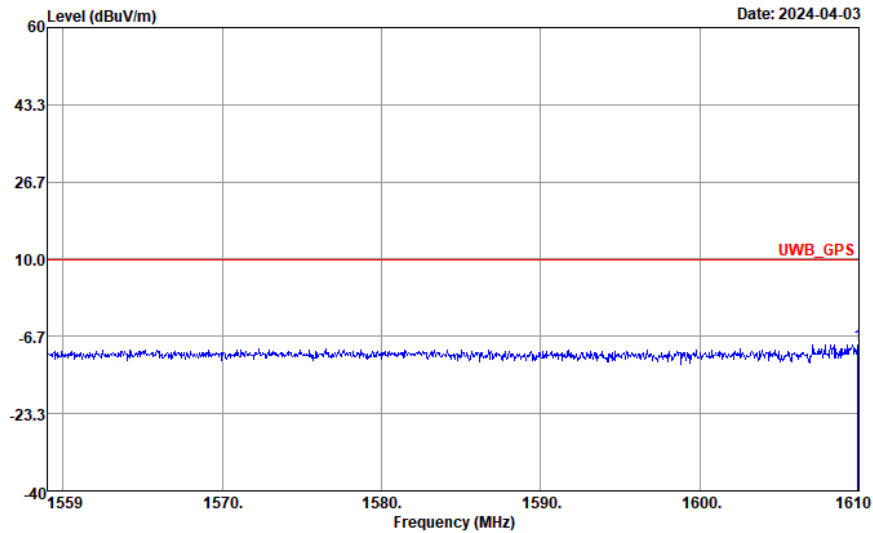

Site : 03CH22-HY
 Condition : UWB_GPS 3m LE2C04A18EN_230712 VERTICAL
 : RBW:1.000KHz VBW:3.000KHz SWT:40.000sec
 : .
 Detector : Peak
 Project : 3N2325
 Channel : CH5
 Modulation : BPRF
 UWB Frame : 0
 HPRF Set # : NA
 Payload Length : 125
 Power Offset : 43
 Post Power Offset : 50
 Sweep point : 51001pts

Freq	Level	Over	Limit	ReadAntenna	Cable	Preamp	A/Pos	T/Pos	Remark
MHz	dBuV/m	dB	dBuV/m	dBuV	dB/m	dB	dB	cm	deg
1	1609.95	-8.39	-18.32	9.93	-1.00	24.50	0.00	31.89	--- Peak

- Note 1: ">20dB" means spurious emission levels that exceed the level of 20 dB below the applicable limit.
- Note 2: "N/F" means Nothing Found spurious emissions (No spurious emissions were detected.)
- Note 3: Measurement receive antenna polarization: H (Horizontal), V (Vertical)
- Note 4: Average emission setting: RBW=1kHz; VBW=3kHz.
- Note 5: E (dBuV/m) = EIRP Limit (dBm) + 95.23. E(dBuV/m) = -85.3 + 95.23 = 9.93dBuV/m.



CH05 Radiated Emissions (1559MHz – 1610MHz)

Test Mode	Mode 15	Polarization	H
Operating Function	Adapter Mode	Test Distance	3m

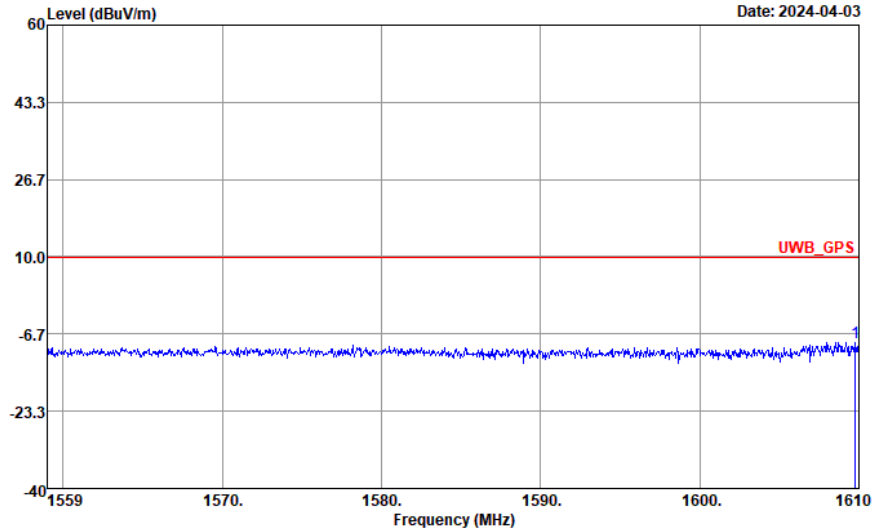

Site : 03CH22-HY
 Condition : UWB_GPS 3m LE2C04A18EN_230712 HORIZONTAL
 : RBW:1.000KHz VBW:3.000KHz SWT:40.000sec
 :.
 Detector : Peak
 Project : 3N2325
 Channel : CH5
 Modulation : HPRF
 UWB Frame : 0
 HPRF Set # : 13
 Payload Length : NA
 Power Offset : 80
 Post Power Offset : 50
 Sweep point : 51001pts

	Over	Limit	ReadAntenna	Cable	Preamp	A/Pos	T/Pos		
Freq	Level	Limit	Line	Level	Factor	Loss	Factor	Remark	
MHz	dBuV/m	dB	dBuV/m	dBuV	dB/m	dB	dB	cm	deg
1	1609.80	-8.40	-18.33	9.93	-1.01	24.50	0.00	31.89	--- --- Peak

- Note 1: ">20dB" means spurious emission levels that exceed the level of 20 dB below the applicable limit.
- Note 2: "N/F" means Nothing Found spurious emissions (No spurious emissions were detected.)
- Note 3: Measurement receive antenna polarization: H (Horizontal), V (Vertical)
- Note 4: Average emission setting: RBW=1kHz; VBW=3kHz.
- Note 5: E (dBuV/m) = EIRP Limit (dBm) + 95.23. E(dBuV/m) = -85.3 + 95.23 = 9.93dBuV/m.



CH05 Radiated Emissions (1559MHz – 1610MHz)

Test Mode	Mode 15	Polarization	V
Operating Function	Adapter Mode	Test Distance	3m

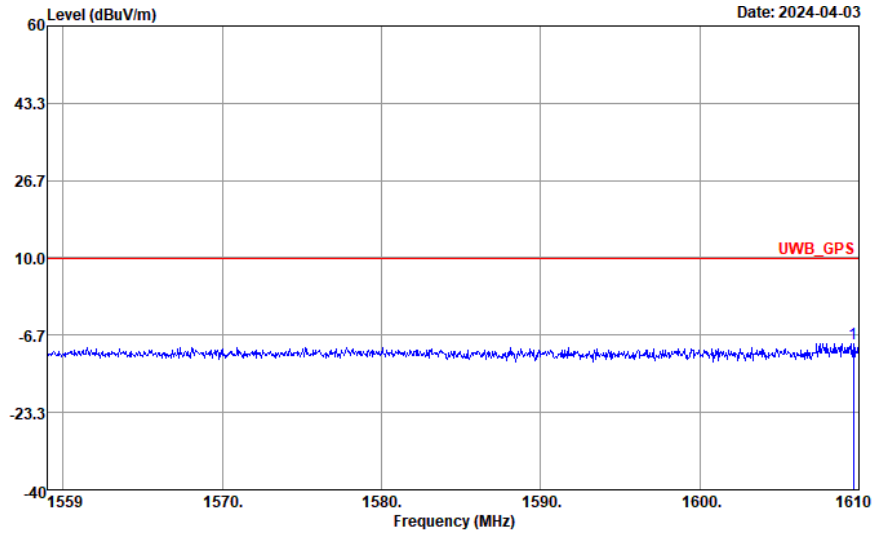

Site : 03CH22-HY
 Condition : UWB_GPS 3m LE2C04A18EN_230712 VERTICAL
 : RBW:1.000KHz VBW:3.000KHz SWT:40.000sec
 :.
 Detector : Peak
 Project : 3N2325
 Channel : CH5
 Modulation : HPRF
 UWB Frame : 0
 HPRF Set # : 13
 Payload Length : NA
 Power Offset : 80
 Post Power Offset : 50
 Sweep point : 51001pts

	Freq	Level	Over	Limit	ReadAntenna	Cable	Preamp	A/Pos	T/Pos	Remark	
	MHz	dBuV/m	dB	dBuV/m	dBuV	dB/m	dB	dB	cm	deg	
1	1609.64	-8.40	-18.33	9.93	-1.01	24.50	0.00	31.89	---	---	Peak

- Note 1: ">20dB" means spurious emission levels that exceed the level of 20 dB below the applicable limit.
- Note 2: "N/F" means Nothing Found spurious emissions (No spurious emissions were detected.)
- Note 3: Measurement receive antenna polarization: H (Horizontal), V (Vertical)
- Note 4: Average emission setting: RBW=1kHz; VBW=3kHz.
- Note 5: E (dBuV/m) = EIRP Limit (dBm) + 95.23. E(dBuV/m) = -85.3 + 95.23 = 9.93dBuV/m.



CH09 Radiated Emissions (1559MHz – 1610MHz)

Test Mode	Mode 12	Polarization	H
Operating Function	Adapter Mode	Test Distance	3m

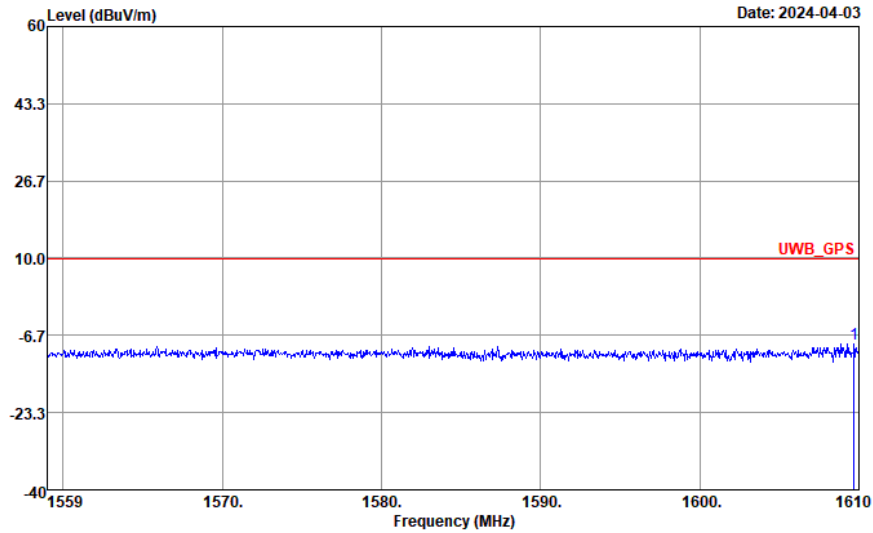

Site : 03CH22-HY
 Condition : UWB_GPS 3m LE2C04A18EN_230712 HORIZONTAL
 : RBW:1.000KHz VBW:3.000KHz SWT:40.000sec
 : .
 Detector : Peak
 Project : 3N2325
 Channel : CH9
 Modulation : BPRF
 UWB Frame : 3
 HPRF Set # : NA
 Payload Length : NA
 Power Offset : 48
 Post Power Offset : 50
 Sweep point : 51001pts

	Freq	Level	Over Limit	Limit Line	ReadAntenna Level	Antenna Factor	Cable Loss	Preamp Factor	A/Pos	T/Pos	Remark
	MHz	dBuV/m	dB	dBuV/m	dBuV	dB/m	dB	dB	cm	deg	
1	1609.69	-8.40	-18.33	9.93	-1.01	24.50	0.00	31.89	---	---	Peak

- Note 1: ">20dB" means spurious emission levels that exceed the level of 20 dB below the applicable limit.
- Note 2: "N/F" means Nothing Found spurious emissions (No spurious emissions were detected.)
- Note 3: Measurement receive antenna polarization: H (Horizontal), V (Vertical)
- Note 4: Average emission setting: RBW=1kHz; VBW=3kHz.
- Note 5: E (dBuV/m) = EIRP Limit (dBm) + 95.23. E(dBuV/m) = -85.3 + 95.23 = 9.93dBuV/m.



CH09 Radiated Emissions (1559MHz – 1610MHz)

Test Mode	Mode 12	Polarization	V
Operating Function	Adapter Mode	Test Distance	3m

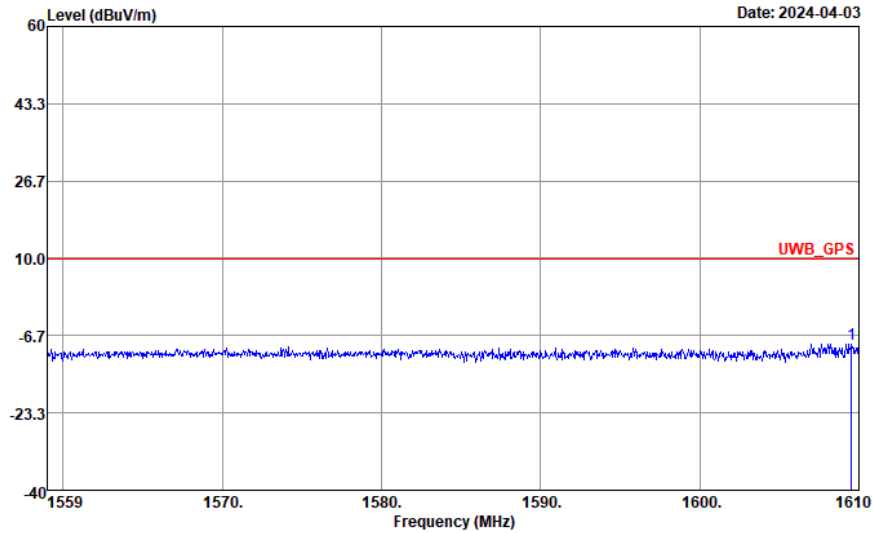

Site : 03CH22-HY
 Condition : UWB_GPS 3m LE2C04A18EN_230712 VERTICAL
 : RBW:1.000KHz VBW:3.000KHz SWT:40.000sec
 :.
 Detector : Peak
 Project : 3N2325
 Channel : CH9
 Modulation : BPRF
 UWB Frame : 3
 HPRF Set # : NA
 Payload Length : NA
 Power Offset : 48
 Post Power Offset : 50
 Sweep point : 51001pts

	Freq	Level	Over	Limit	ReadAntenna	Cable	Preamp	A/Pos	T/Pos	Remark
	MHz	dBuV/m	dB	dBuV/m	dBuV	dB/m	dB	dB	cm	deg
1	1609.54	-8.40	-18.33	9.93	-1.01	24.50	0.00	31.89	---	--- Peak

- Note 1: ">20dB" means spurious emission levels that exceed the level of 20 dB below the applicable limit.
- Note 2: "N/F" means Nothing Found spurious emissions (No spurious emissions were detected.)
- Note 3: Measurement receive antenna polarization: H (Horizontal), V (Vertical)
- Note 4: Average emission setting: RBW=1kHz; VBW=3kHz.
- Note 5: E (dBuV/m) = EIRP Limit (dBm) + 95.23. E(dBuV/m) = -85.3 + 95.23 = 9.93dBuV/m.



CH09 Radiated Emissions (1559MHz – 1610MHz)

Test Mode	Mode 14	Polarization	H
Operating Function	Adapter Mode	Test Distance	3m

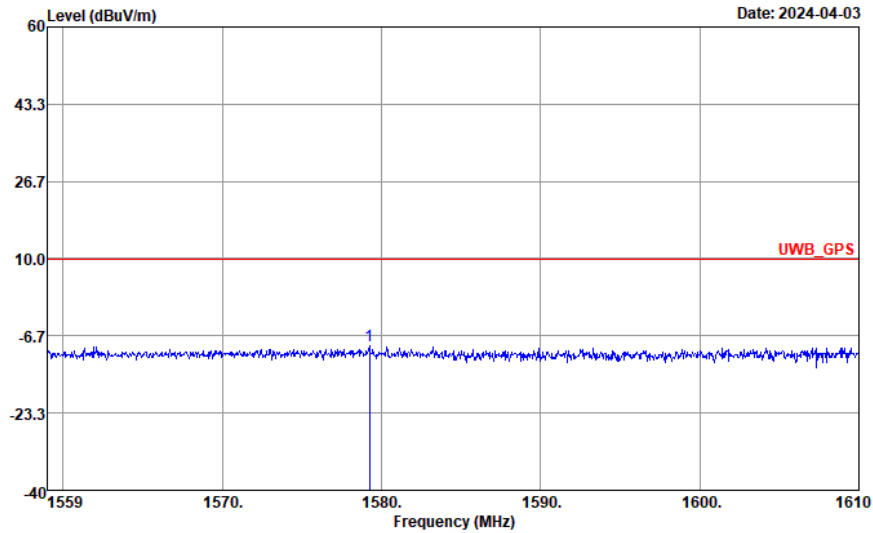

Site : 03CH22-HY
 Condition : UWB_GPS 3m LE2C04A18EN_230712 HORIZONTAL
 : RBW:1.000KHz VBW:3.000KHz SWT:40.000sec
 :.
 Detector : Peak
 Project : 3N2325
 Channel : CH9
 Modulation : HPRF
 UWB Frame : NA
 HPRF Set # : 13
 Payload Length : NA
 Power Offset : 59
 Post Power Offset : 50
 Sweep point : 51001pts

	Freq	Level	Over	Limit	ReadAntenna	Cable	Preamp	A/Pos	T/Pos	Remark	
	MHz	dBuV/m	dB	dBuV/m	dBuV	dB/m	dB	dB	cm	deg	
1	1579.25	-8.77	-18.70	9.93	-1.29	24.40	0.00	31.88	---	---	Peak

- Note 1: ">20dB" means spurious emission levels that exceed the level of 20 dB below the applicable limit.
- Note 2: "N/F" means Nothing Found spurious emissions (No spurious emissions were detected.)
- Note 3: Measurement receive antenna polarization: H (Horizontal), V (Vertical)
- Note 4: Average emission setting: RBW=1kHz; VBW=3kHz.
- Note 5: E (dBuV/m) = EIRP Limit (dBm) + 95.23. E(dBuV/m) = -85.3 + 95.23 = 9.93dBuV/m.



CH09 Radiated Emissions (1559MHz – 1610MHz)

Test Mode	Mode 14	Polarization	V
Operating Function	Adapter Mode	Test Distance	3m

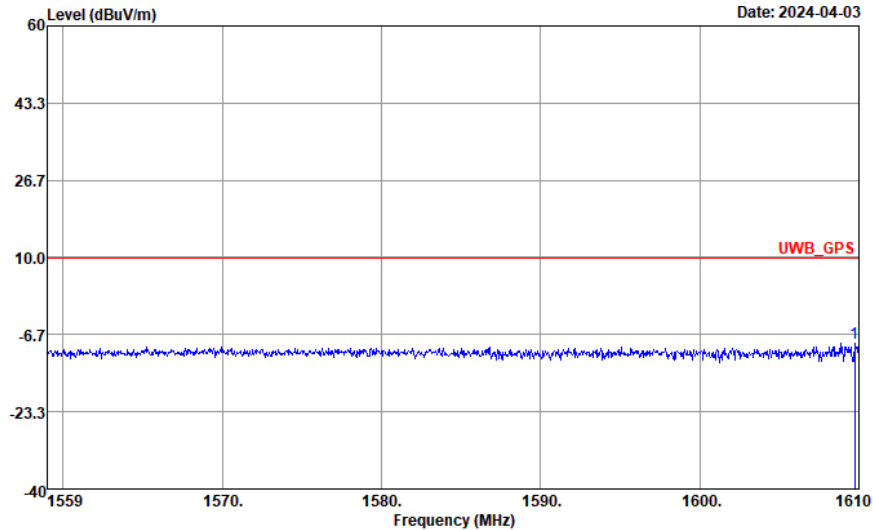

Site : 03CH22-HY
 Condition : UWB_GPS 3m LE2C04A18EN_230712 VERTICAL
 : RBW:1.000KHz VBW:3.000KHz SWT:40.000sec
 :
 Detector : Peak
 Project : 3N2325
 Channel : CH9
 Modulation : HPRF
 UWB Frame : NA
 HPRF Set # : 13
 Payload Length : NA
 Power Offset : 59
 Post Power Offset : 50
 Sweep point : 51001pts

	Freq	Level	Over Limit	Limit Line	ReadAntenna Level	Antenna Factor	Cable Loss	Preamp Factor	A/Pos	T/Pos	Remark
	MHz	dBuV/m	dB	dBuV/m	dBuV	dB/m	dB	dB	cm	deg	
1	1609.75	-8.40	-18.33	9.93	-1.01	24.50	0.00	31.89	---	---	Peak

- Note 1: ">20dB" means spurious emission levels that exceed the level of 20 dB below the applicable limit.
- Note 2: "N/F" means Nothing Found spurious emissions (No spurious emissions were detected.)
- Note 3: Measurement receive antenna polarization: H (Horizontal), V (Vertical)
- Note 4: Average emission setting: RBW=1kHz; VBW=3kHz.
- Note 5: E (dBuV/m) = EIRP Limit (dBm) + 95.23. E(dBuV/m) = -85.3 + 95.23 = 9.93dBuV/m.



3.5.11 Radiated Emissions (18GHz – 40GHz)

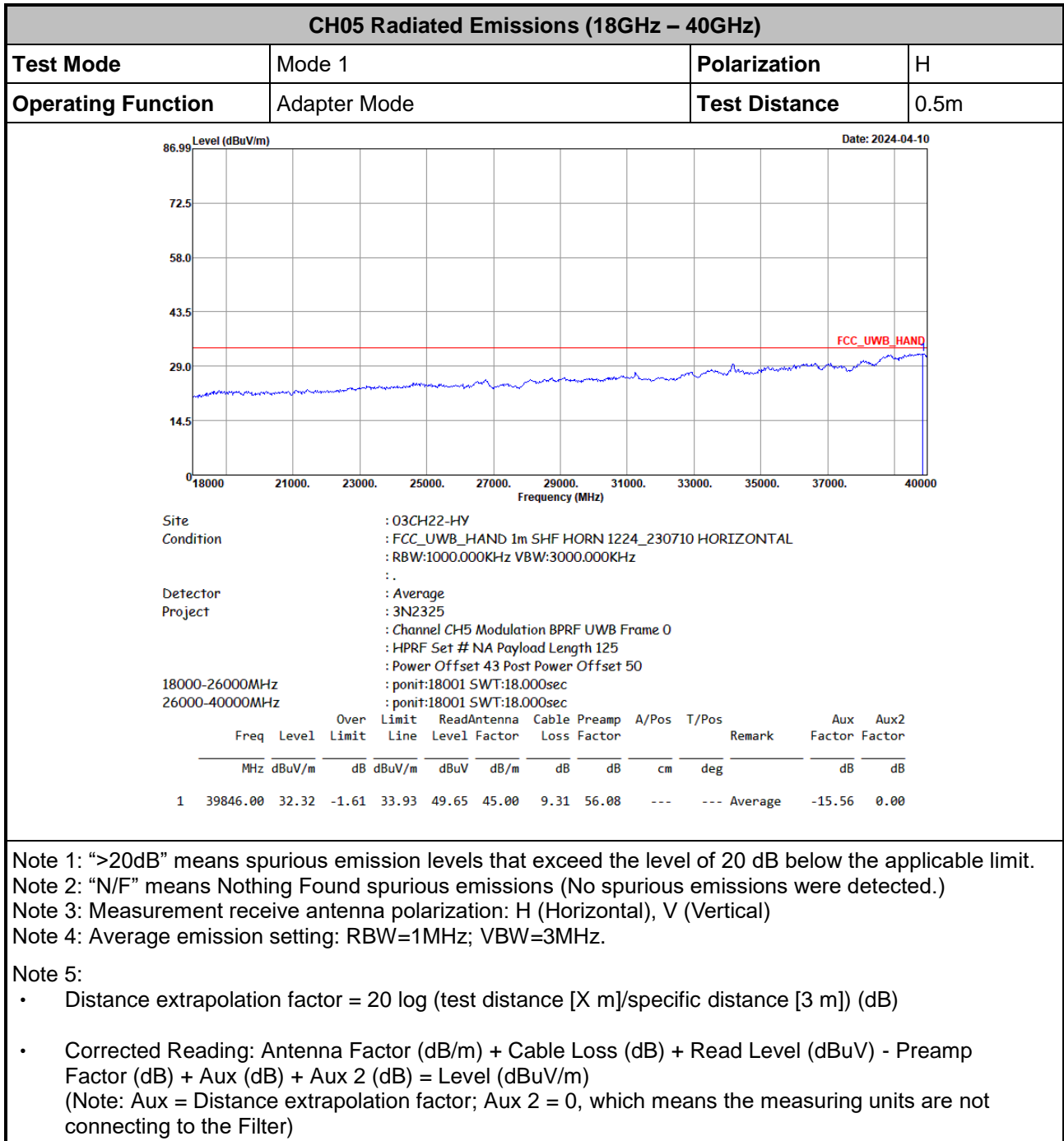



CH05 Radiated Emissions (18GHz – 40GHz)

Test Mode	Mode 1	Polarization	V
Operating Function	Adapter Mode	Test Distance	0.5m

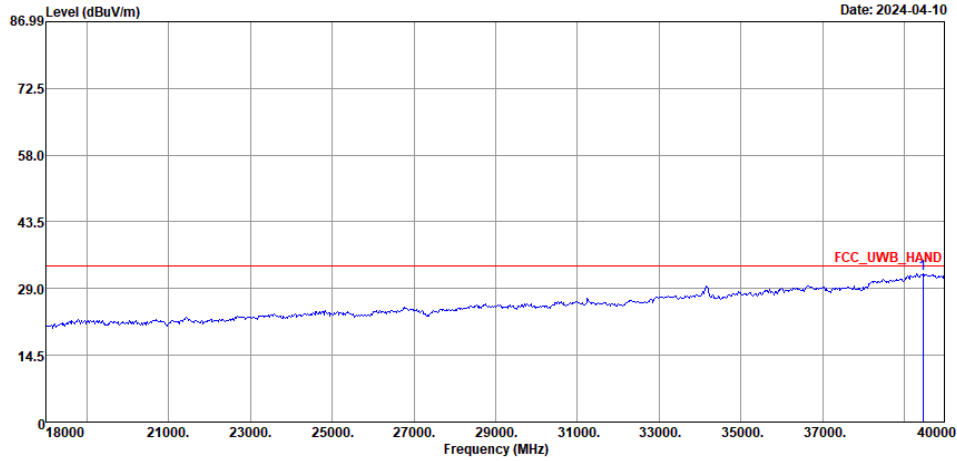

Site : 03CH22-HY
 Condition : FCC_UWB_HAND 1m SHF HORN 1224_230710 VERTICAL
 : RBW:1000.000KHz VBW:3000.000KHz
 :.
 Detector : Average
 Project : 3N2325
 : Channel CH5 Modulation BPRF UWB Frame 0
 : HPRF Set # NA Payload Length 125
 : Power Offset 43 Post Power Offset 50
 18000-26000MHz : ponit:18001 SWT:18.000sec
 26000-40000MHz : ponit:18001 SWT:18.000sec

Freq	Level	Over Limit	ReadAntenna Line	Cable Loss	Preamp Loss	A/Pos	T/Pos	Remark	Aux Factor	Aux2 Factor		
MHz	dBuV/m	dB	dBuV/m	dBuV	dB/m	dB	dB	cm	deg	dB	dB	
1 39450.00	32.19	-1.74	33.93	49.27	45.80	9.21	56.53	---	---	Average	-15.56	0.00

Note 1: ">20dB" means spurious emission levels that exceed the level of 20 dB below the applicable limit.
 Note 2: "N/F" means Nothing Found spurious emissions (No spurious emissions were detected.)
 Note 3: Measurement receive antenna polarization: H (Horizontal), V (Vertical)
 Note 4: Average emission setting: RBW=1MHz; VBW=3MHz.

Note 5:

- Distance extrapolation factor = 20 log (test distance [X m]/specific distance [3 m]) (dB)
- Corrected Reading: Antenna Factor (dB/m) + Cable Loss (dB) + Read Level (dBuV) - Preamp Factor (dB) + Aux (dB) + Aux 2 (dB) = Level (dBuV/m)
 (Note: Aux = Distance extrapolation factor; Aux 2 = 0, which means the measuring units are not connecting to the Filter)



CH05 Radiated Emissions (18GHz – 40GHz)

Test Mode	Mode 15	Polarization	H
Operating Function	Adapter Mode	Test Distance	0.5m

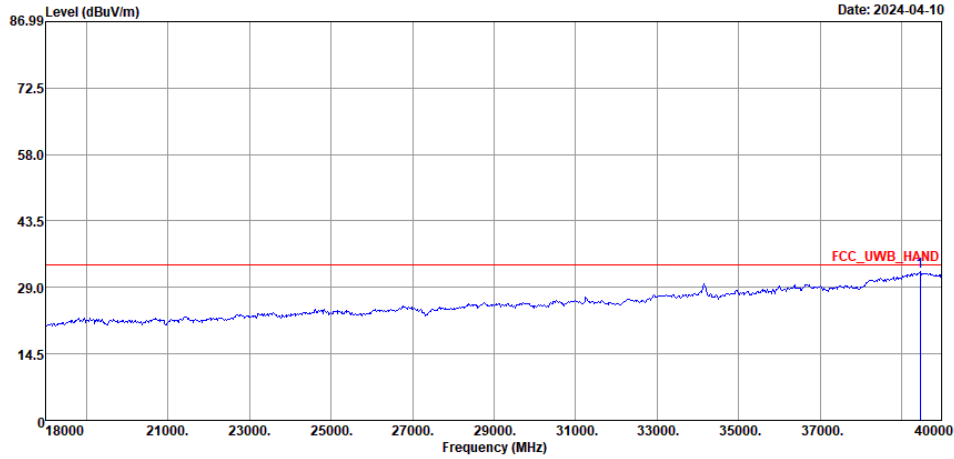

Site : 03CH22-HY
 Condition : FCC_UWB_HAND 1m SHF HORN 1224_230710 HORIZONTAL
 : RBW:1000.000KHz VBW:3000.000KHz
 :.
 Detector : Average
 Project : 3N2325
 : Channel CH5 Modulation HPRF UWB Frame 0
 : HPRF Set # 13 Payload Length NA
 : Power Offset 80 Post Power Offset 50
 18000-26000MHz : ponit:18001 SWT:18.000sec
 26000-40000MHz : ponit:18001 SWT:18.000sec

Freq	Level	Over	Limit	ReadAntenna	Cable	Preamp	A/Pos	T/Pos	Remark	Aux	Aux2
MHz	dBuV/m	dB	dBuV/m	dBuV	dB/m	dB	dB	cm	deg	dB	dB
1 39450.00	32.35	-1.58	33.93	49.43	45.80	9.21	56.53	---	---	Average	-15.56 0.00

Note 1: ">20dB" means spurious emission levels that exceed the level of 20 dB below the applicable limit.
 Note 2: "N/F" means Nothing Found spurious emissions (No spurious emissions were detected.)
 Note 3: Measurement receive antenna polarization: H (Horizontal), V (Vertical)
 Note 4: Average emission setting: RBW=1MHz; VBW=3MHz.

Note 5:

- Distance extrapolation factor = 20 log (test distance [X m]/specific distance [3 m]) (dB)
- Corrected Reading: Antenna Factor (dB/m) + Cable Loss (dB) + Read Level (dBuV) - Preamp Factor (dB) + Aux (dB) + Aux 2 (dB) = Level (dBuV/m)
 (Note: Aux = Distance extrapolation factor; Aux 2 = 0, which means the measuring units are not connecting to the Filter)



CH05 Radiated Emissions (18GHz – 40GHz)

Test Mode	Mode 15	Polarization	V
Operating Function	Adapter Mode	Test Distance	0.5m

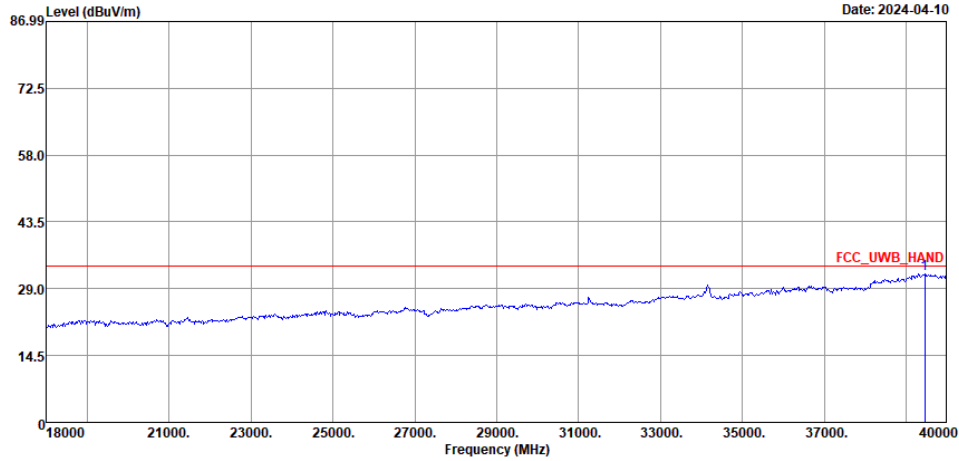

Site : 03CH22-HY
 Condition : FCC_UWB_HAND 1m SHF HORN 1224_230710 VERTICAL
 : RBW:1000.000KHz VBW:3000.000KHz
 :.
 Detector : Average
 Project : 3N2325
 : Channel CH5 Modulation HPRF UWB Frame 0
 : HPRF Set # 13 Payload Length NA
 : Power Offset 80 Post Power Offset 50
 18000-26000MHz : ponit:18001 SWT:18.000sec
 26000-40000MHz : ponit:18001 SWT:18.000sec

Freq	Level	Over Limit	Limit	ReadAntenna	Cable	Preamp	A/Pos	T/Pos	Remark	Aux	Aux2		
MHz	dBuV/m	dB	dBuV/m	dBuV	dB/m	dB	dB	cm	deg	dB	dB		
1	39450.00	32.23	-1.70	33.93	49.31	45.80	9.21	56.53	---	---	Average	-15.56	0.00

Note 1: “>20dB” means spurious emission levels that exceed the level of 20 dB below the applicable limit.

Note 2: “N/F” means Nothing Found spurious emissions (No spurious emissions were detected.)

Note 3: Measurement receive antenna polarization: H (Horizontal), V (Vertical)

Note 4: Average emission setting: RBW=1MHz; VBW=3MHz.

Note 5:

- Distance extrapolation factor = 20 log (test distance [X m]/specific distance [3 m]) (dB)
- Corrected Reading: Antenna Factor (dB/m) + Cable Loss (dB) + Read Level (dBuV) - Preamp Factor (dB) + Aux (dB) + Aux 2 (dB) = Level (dBuV/m)
 (Note: Aux = Distance extrapolation factor; Aux 2 = 0, which means the measuring units are not connecting to the Filter)



CH09 Radiated Emissions (18GHz – 40GHz)

Test Mode	Mode 12	Polarization	H
Operating Function	Adapter Mode	Test Distance	0.5m

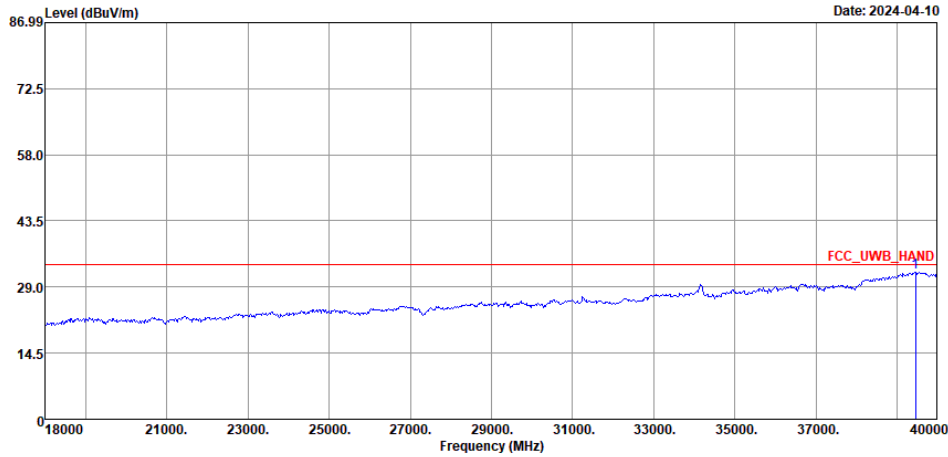

Site : 03CH22-HY
 Condition : FCC_UWB_HAND 1m SHF HORN 1224_230710 HORIZONTAL
 : RBW:1000.000KHz VBW:3000.000KHz
 :.
 Detector : Average
 Project : 3N2325
 : Channel CH9 Modulation BPRF UWB Frame 3
 : HPRF Set # NA Payload Length NA
 : Power Offset 48 Post Power Offset 50
 18000-26000MHz : ponit:18001 SWT:18.000sec
 26000-40000MHz : ponit:18001 SWT:18.000sec

Freq	Level	Over	Limit	ReadAntenna	Cable	Preamp	A/Pos	T/Pos	Remark	Aux	Aux2
MHz	dBUV/m	dB	dBUV/m	dBuV	dB/m	dB	dB	cm	deg	dB	dB
1 39450.00	32.28	-1.65	33.93	49.36	45.80	9.21	56.53	---	---	Average	-15.56 0.00

Note 1: ">20dB" means spurious emission levels that exceed the level of 20 dB below the applicable limit.
 Note 2: "N/F" means Nothing Found spurious emissions (No spurious emissions were detected.)
 Note 3: Measurement receive antenna polarization: H (Horizontal), V (Vertical)
 Note 4: Average emission setting: RBW=1MHz; VBW=3MHz.

Note 5:

- Distance extrapolation factor = 20 log (test distance [X m]/specific distance [3 m]) (dB)
- Corrected Reading: Antenna Factor (dB/m) + Cable Loss (dB) + Read Level (dBUV) - Preamp Factor (dB) + Aux (dB) + Aux 2 (dB) = Level (dBUV/m)
 (Note: Aux = Distance extrapolation factor; Aux 2 = 0, which means the measuring units are not connecting to the Filter)



CH09 Radiated Emissions (18GHz – 40GHz)

Test Mode	Mode 12	Polarization	V
Operating Function	Adapter Mode	Test Distance	0.5m

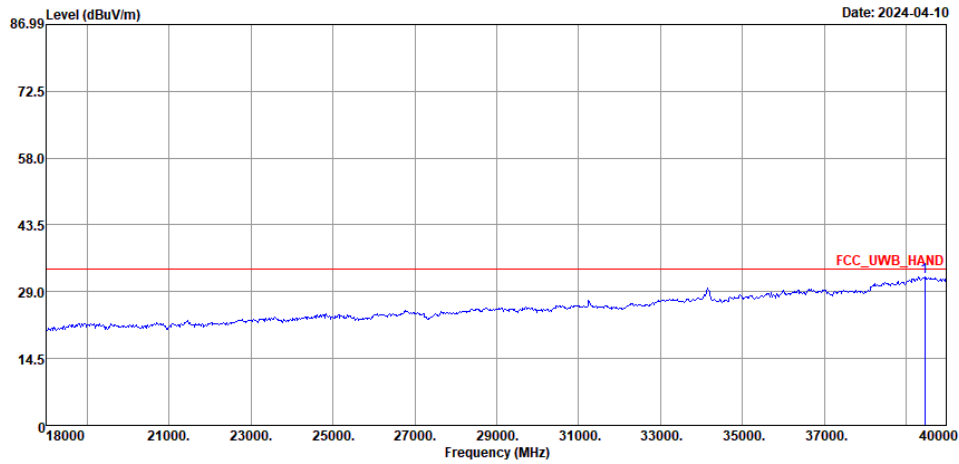

Site : 03CH22-HY
 Condition : FCC_UWB_HAND 1m SHF HORN 1224_230710 VERTICAL
 : RBW:1000.000KHz VBW:3000.000KHz
 :.
 Detector : Average
 Project : 3N2325
 : Channel CH9 Modulation BPRF UWB Frame 3
 : HPRF Set # NA Payload Length NA
 : Power Offset 48 Post Power Offset 50
 18000-26000MHz : ponit:18001 SWT:18.000sec
 26000-40000MHz : ponit:18001 SWT:18.000sec

Freq	Level	Over Limit	Limit	ReadAntenna	Cable	Preamp	A/Pos	T/Pos	Remark	Aux	Aux2		
MHz	dBuV/m	dB	dBuV/m	dBuV	dB/m	dB	dB	cm	deg	dB	dB		
1	39450.00	32.23	-1.70	33.93	49.31	45.80	9.21	56.53	---	---	Average	-15.56	0.00

Note 1: “>20dB” means spurious emission levels that exceed the level of 20 dB below the applicable limit.
 Note 2: “N/F” means Nothing Found spurious emissions (No spurious emissions were detected.)
 Note 3: Measurement receive antenna polarization: H (Horizontal), V (Vertical)
 Note 4: Average emission setting: RBW=1MHz; VBW=3MHz.

Note 5:

- Distance extrapolation factor = 20 log (test distance [X m]/specific distance [3 m]) (dB)
- Corrected Reading: Antenna Factor (dB/m) + Cable Loss (dB) + Read Level (dBuV) - Preamp Factor (dB) + Aux (dB) + Aux 2 (dB) = Level (dBuV/m)
 (Note: Aux = Distance extrapolation factor; Aux 2 = 0, which means the measuring units are not connecting to the Filter)



CH09 Radiated Emissions (18GHz – 40GHz)

Test Mode	Mode 14	Polarization	H
Operating Function	Adapter Mode	Test Distance	0.5m

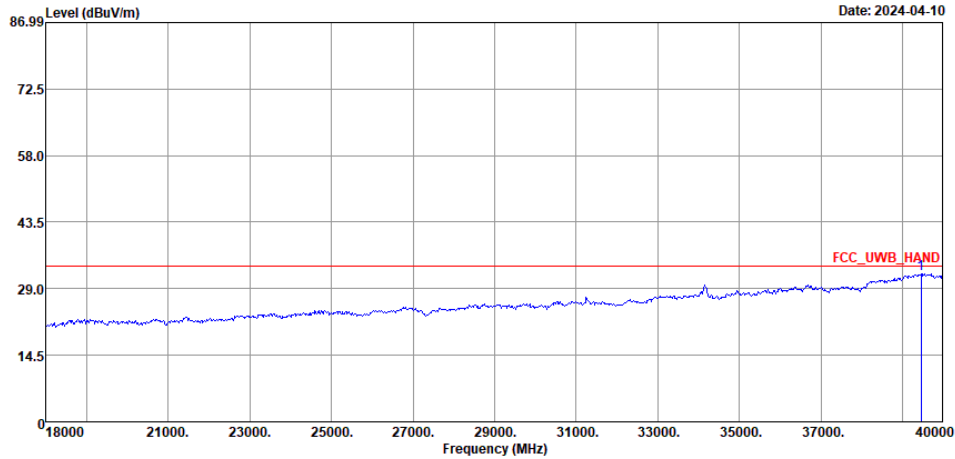

Site : 03CH22-HY
 Condition : FCC_UWB_HAND 1m SHF HORN 1224_230710 HORIZONTAL
 : RBW:1000.000KHz VBW:3000.000KHz
 : .

Detector : Average
 Project : 3N2325
 : Channel CH9 Modulation HPRF UWB Frame NA
 : HPRF Set # 13 Payload Length NA
 : Power Offset 59 Post Power Offset 50

18000-26000MHz : ponit:18001 SWT:18.000sec
 26000-40000MHz : ponit:18001 SWT:18.000sec

Freq	Level	Over Limit	ReadAntenna Line	ReadAntenna Level	Antenna Factor	Cable Loss	Preamp Loss	A/Pos	T/Pos	Remark	Aux Factor	Aux2 Factor
MHz	dBuV/m	dB	dBuV/m	dBuV	dB/m	dB	dB	cm	deg		dB	dB
1 39450.00	32.31	-1.62	33.93	49.39	45.80	9.21	56.53	---	---	Average	-15.56	0.00

Note 1: ">20dB" means spurious emission levels that exceed the level of 20 dB below the applicable limit.

Note 2: "N/F" means Nothing Found spurious emissions (No spurious emissions were detected.)

Note 3: Measurement receive antenna polarization: H (Horizontal), V (Vertical)

Note 4: Average emission setting: RBW=1MHz; VBW=3MHz.

Note 5:

- Distance extrapolation factor = 20 log (test distance [X m]/specific distance [3 m]) (dB)
- Corrected Reading: Antenna Factor (dB/m) + Cable Loss (dB) + Read Level (dBuV) - Preamp Factor (dB) + Aux (dB) + Aux 2 (dB) = Level (dBuV/m)
 (Note: Aux = Distance extrapolation factor; Aux 2 = 0, which means the measuring units are not connecting to the Filter)



CH09 Radiated Emissions (18GHz – 40GHz)

Test Mode	Mode 14	Polarization	V
Operating Function	Adapter Mode	Test Distance	0.5m

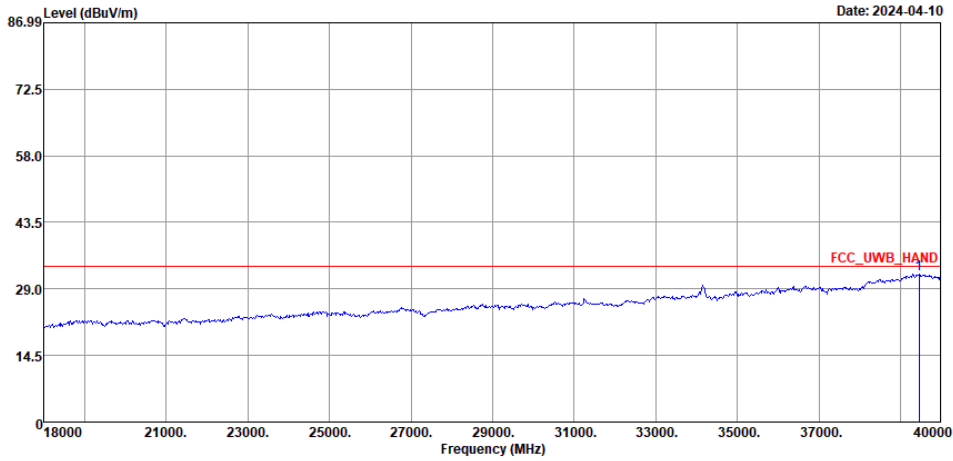

Site : 03CH22-HY
 Condition : FCC_UWB_HAND 1m SHF HORN 1224_230710 VERTICAL
 : RBW:1000.000KHz VBW:3000.000KHz
 :.
 Detector : Average
 Project : 3N2325
 : Channel CH9 Modulation HPRF UWB Frame NA
 : HPRF Set # 13 Payload Length NA
 : Power Offset 59 Post Power Offset 50
 18000-26000MHz : ponit:18001 SWT:18.000sec
 26000-40000MHz : ponit:18001 SWT:18.000sec

Freq	Level	Over Limit	Limit	ReadAntenna	Cable	Preamp	A/Pos	T/Pos	Remark	Aux	Aux2	
MHz	dBuV/m	dB	dBuV/m	dBuV	dB/m	dB	dB	cm	deg	dB	dB	
1	39450.00	32.19	-1.74	33.93	49.27	45.80	9.21	56.53	---	Average	-15.56	0.00

Note 1: ">20dB" means spurious emission levels that exceed the level of 20 dB below the applicable limit.
 Note 2: "N/F" means Nothing Found spurious emissions (No spurious emissions were detected.)
 Note 3: Measurement receive antenna polarization: H (Horizontal), V (Vertical)
 Note 4: Average emission setting: RBW=1MHz; VBW=3MHz.

- Note 5:
- Distance extrapolation factor = 20 log (test distance [X m]/specific distance [3 m]) (dB)
 - Corrected Reading: Antenna Factor (dB/m) + Cable Loss (dB) + Read Level (dBuV) - Preamp Factor (dB) + Aux (dB) + Aux 2 (dB) = Level (dBuV/m)
 (Note: Aux = Distance extrapolation factor; Aux 2 = 0, which means the measuring units are not connecting to the Filter)



4 Test Equipment and Calibration Data

Instrument	Brand Name	Model No.	Serial No.	Characteristics	Calibration Date	Test Date	Due Date	Remark
AC Power Source	ACPOWER	AFC-11003G	F317040033	N/A	N/A	Mar. 25, 2024	N/A	Conduction (CO07-HY)
Software	Rohde & Schwarz	EMC32 V10.30	N/A	N/A	N/A	Mar. 25, 2024	N/A	Conduction (CO07-HY)
Pulse Limiter	SCHWARZBECK	VTSD 9561-F N	9561-F N00373	9kHz~200MHz	Oct. 20, 2023	Mar. 25, 2024	Oct. 19, 2024	Conduction (CO07-HY)
RF Cable	HUBER + SUHNER	RG 214/U	1358175	9kHz~30MHz	Mar. 14, 2024	Mar. 25, 2024	Mar. 13, 2025	Conduction (CO07-HY)
Two-Line V-Network	TESEQ	NNB 51	45051	N/A	Mar. 10, 2024	Mar. 25, 2024	Mar. 09, 2025	Conduction (CO07-HY)
Four-Line V-Network	TESEQ	NNB 52	36122	N/A	Mar. 07, 2024	Mar. 25, 2024	Mar. 06, 2025	Conduction (CO07-HY)
EMI Test Receiver	Rohde & Schwarz	ESR3	102317	9kHz~3.6GHz	Sep. 20, 2023	Mar. 25, 2024	Sep. 19, 2024	Conduction (CO07-HY)
Loop Antenna	Rohde & Schwarz	HFH2-Z2	100488	9 kHz~30 MHz	Sep. 12, 2023	Dec. 28, 2023~Apr. 08, 2024	Sep. 11, 2024	Radiation (03CH22-HY)
Bilog Antenna	TESEQ	CBL 6111D & 00802N1D-06	63304 & 002	30MHz~1GHz	Oct. 15, 2023	Dec. 28, 2023~Apr. 08, 2024	Oct. 14, 2024	Radiation (03CH22-HY)
Amplifier	SONOMA	310N	421581	N/A	Jul. 15, 2023	Dec. 28, 2023~Apr. 08, 2024	Jul. 14, 2024	Radiation (03CH22-HY)
Double Ridged Guide Horn Antenna	RFSPIN	DRH18-E	LE2C04A18EN	1GHz~18GHz	Jul. 12, 2023	Dec. 28, 2023~Apr. 08, 2024	Jul. 11, 2024	Radiation (03CH22-HY)
Amplifier	EMEC	EM01G18GA	060877	N/A	Sep. 28, 2023	Dec. 28, 2023~Apr. 08, 2024	Sep. 27, 2024	Radiation (03CH22-HY)
Signal Analyzer	Keysight	N9010B	MY62170278	10Hz~44GHz	Aug. 31, 2023	Dec. 28, 2023~Apr. 08, 2024	Aug. 30, 2024	Radiation (03CH22-HY)
Hygrometer	TECPEL	DTM-303A	TP211559	N/A	Nov. 16, 2023	Dec. 28, 2023~Apr. 08, 2024	Nov. 15, 2024	Radiation (03CH22-HY)
Controller	EMEC	EM1000	N/A	Control Turn table & Ant Mast	N/A	Dec. 28, 2023~Apr. 08, 2024	N/A	Radiation (03CH22-HY)
Antenna Mast	ChainTek	MBS-520-1	N/A	1m~4m	N/A	Dec. 28, 2023~Apr. 08, 2024	N/A	Radiation (03CH22-HY)
Turn Table	ChainTek	T-200-S-1	N/A	0~360 Degree	N/A	Dec. 28, 2023~Apr. 08, 2024	N/A	Radiation (03CH22-HY)
Software	Audix	E3 6.09824_2019122	RK-002347	N/A	N/A	Dec. 28, 2023~Apr. 08, 2024	N/A	Radiation (03CH22-HY)
RF Cable	HUBER + SUHNER	SUCOFLEX 102	803951/2	9kHz~30MHz	Mar. 07, 2023	Dec. 28, 2023~Mar. 05, 2024	Mar. 06, 2024	Radiation (03CH22-HY)
RF Cable	HUBER + SUHNER	SUCOFLEX 102	803951/2	9kHz~30MHz	Mar. 06, 2023	Mar. 06, 2024~Apr. 8, 2024	Mar. 05, 2025	Radiation (03CH22-HY)
RF Cable	HUBER + SUHNER	SUCOFLEX 102	804390/2,804611/2,804615/2	N/A	Oct. 24, 2023	Dec. 28, 2023~Apr. 08, 2024	Oct. 23, 2024	Radiation (03CH22-HY)
Spectrum Analyzer	Rohde & Schwarz	FSW43	101456	RBW 50MHz	Feb. 23, 2023	Dec. 28, 2023~Feb. 22, 2024	Feb. 22, 2024	Radiation (03CH22-HY)
Spectrum Analyzer	Rohde & Schwarz	FSW43	101456	RBW 50MHz	Feb. 19, 2024	Feb. 23, 2024~Apr. 08, 2024	Fed. 18, 2025	Radiation (03CH22-HY)
Preamplifier	EMEC	EM18G40G	060801	18-40GHz	Jun. 27, 2023	Dec. 28, 2023~Apr. 08, 2024	Jun. 26, 2024	Radiation (03CH22-HY)
SHF-EHF Horn Antenna	SCHWARZBECK	BBHA 9170	1224	18GHz~40GHz	Jul. 10, 2023	Dec. 28, 2023~Apr. 08, 2024	Jul. 09, 2024	Radiation (03CH22-HY)



Appendix A. AC Conducted Emission Test Results

EUT Information

Report NO : 3N2325
 Test Mode : Mode 1
 Test Voltage : 120Vac/60Hz
 Phase : Line

Full Spectrum

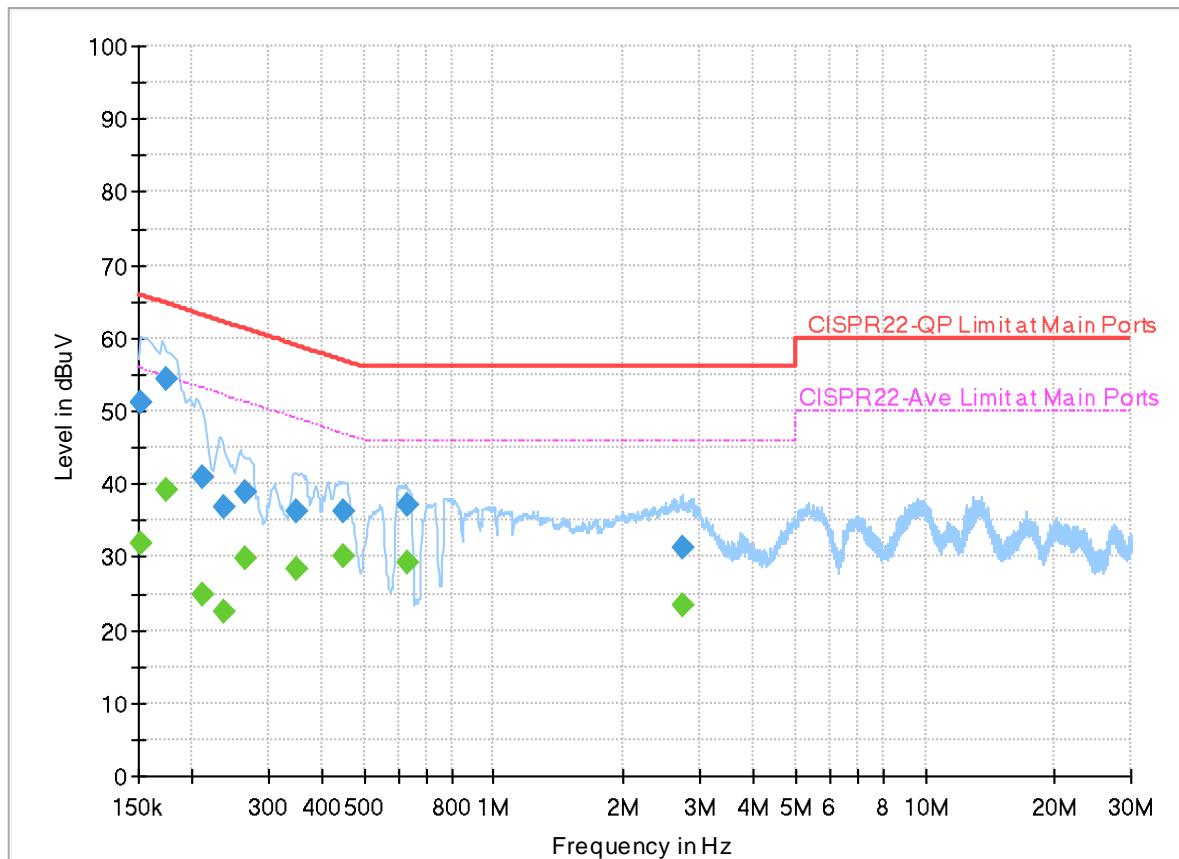

Final_Result

Frequency (MHz)	QuasiPeak (dBuV)	CAverage (dBuV)	Limit (dBuV)	Margin (dB)	Line	Filter	Corr. (dB)
0.151283	---	31.94	55.93	23.99	L1	OFF	19.9
0.151283	51.25	---	65.93	14.68	L1	OFF	19.9
0.173940	---	39.10	54.77	15.67	L1	OFF	19.9
0.173940	54.26	---	64.77	10.51	L1	OFF	19.9
0.210750	---	24.92	53.18	28.26	L1	OFF	19.9
0.210750	40.98	---	63.18	22.20	L1	OFF	19.9
0.237750	---	22.39	52.17	29.78	L1	OFF	19.9
0.237750	36.71	---	62.17	25.46	L1	OFF	19.9
0.263940	---	29.75	51.31	21.56	L1	OFF	19.9
0.263940	38.94	---	61.31	22.37	L1	OFF	19.9
0.347730	---	28.30	49.02	20.72	L1	OFF	19.9
0.347730	36.29	---	59.02	22.73	L1	OFF	19.9
0.447000	---	30.13	46.93	16.80	L1	OFF	19.9
0.447000	36.21	---	56.93	20.72	L1	OFF	19.9
0.628350	---	29.10	46.00	16.90	L1	OFF	19.9
0.628350	37.10	---	56.00	18.90	L1	OFF	19.9
2.729760	---	23.49	46.00	22.51	L1	OFF	20.0
2.729760	31.20	---	56.00	24.80	L1	OFF	20.0

EUT Information

Report NO : 3N2325
 Test Mode : Mode 1
 Test Voltage : 120Vac/60Hz
 Phase : Neutral

Full Spectrum

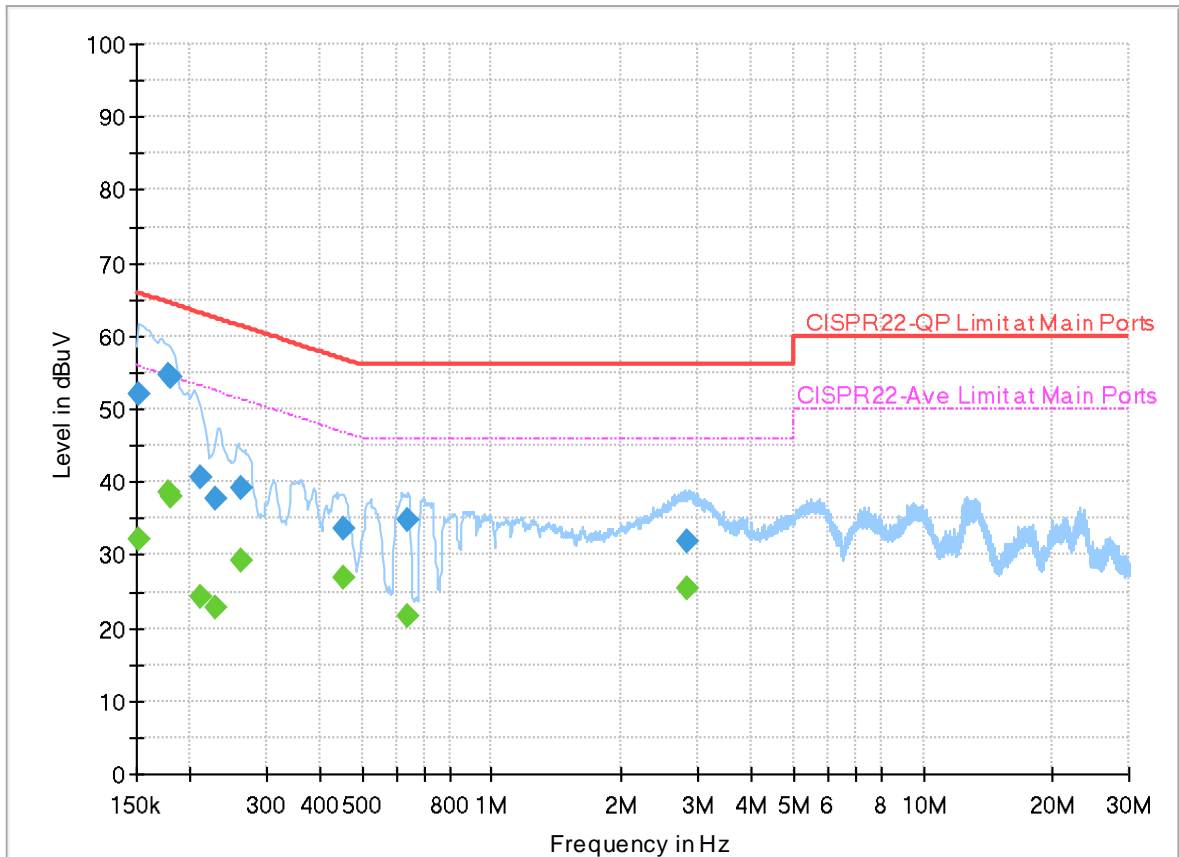

Final_Result

Frequency (MHz)	QuasiPeak (dBuV)	CAverage (dBuV)	Limit (dBuV)	Margin (dB)	Line	Filter	Corr. (dB)
0.152295	---	32.19	55.87	23.68	N	OFF	19.9
0.152295	51.94	---	65.87	13.93	N	OFF	19.9
0.177000	---	38.58	54.63	16.05	N	OFF	19.9
0.177000	54.70	---	64.63	9.93	N	OFF	19.9
0.179250	---	37.91	54.52	16.61	N	OFF	19.9
0.179250	54.40	---	64.52	10.12	N	OFF	19.9
0.210750	---	24.20	53.18	28.98	N	OFF	19.9
0.210750	40.72	---	63.18	22.46	N	OFF	19.9
0.228750	---	22.76	52.50	29.74	N	OFF	19.9
0.228750	37.74	---	62.50	24.76	N	OFF	19.9
0.262500	---	29.25	51.35	22.10	N	OFF	19.9
0.262500	39.25	---	61.35	22.10	N	OFF	19.9
0.451500	---	26.82	46.85	20.03	N	OFF	19.9
0.451500	33.74	---	56.85	23.11	N	OFF	19.9
0.635370	---	21.70	46.00	24.30	N	OFF	19.9
0.635370	34.91	---	56.00	21.09	N	OFF	19.9
2.838750	---	25.41	46.00	20.59	N	OFF	20.0
2.838750	31.83	---	56.00	24.17	N	OFF	20.0

THE END